

ICD 08241

# Amateur Radio

SERVING AMATEUR RADIO SINCE 1945  
OCTOBER 1985 \$2.00

CANADA \$2.50

# CQ

**Results of the  
1984 CQ WW DX  
C.W. Contest**

**THE RADIO AMATEUR'S JOURNAL**



# KENWOOD

...pacesetter in Amateur radio

NEW!

## “DX-cellence!”

### TS-940S

The new TS-940S is a serious radio for the serious operator. Superb interference reduction circuits and high dynamic range receiver combine with superior transmitter design to give you no-nonsense, no compromise performance that gets your signals through! The exclusive multi-function LCD sub display graphically illustrates VBT, SSB slope, and other features.

- **100% duty cycle transmitter.** Super efficient cooling system using special air ducting works with the internal heavy-duty power supply to allow continuous transmission at full power output for periods exceeding one hour.
- **Programmable scanning.**
- **Semi or full break-in (QSK) CW.**

- **Low distortion transmitter.** Kenwood's unique transmitter design delivers top "quality Kenwood" sound.
- **Keyboard entry frequency selection.** Operating frequencies may be directly entered into the TS-940S without using the VFO knob.
- **Graphic display of operating features.** Exclusive multi-function LCD sub-display panel shows CW VBT, SSB slope tuning, as well as frequency, time, and AT-940 antenna tuner status.
- **QRM-fighting features.** Remove "rotten QRM" with the SSB slope tuning, CW VBT, notch filter, AF tune, and CW pitch controls.
- **Built-in FM, plus SSB, CW, AM, FSK.**

#### Optional accessories:

- AT-940 full range (160-10 m) automatic antenna tuner
- SP-940 external speaker with audio filtering
- YG-455C-1 (500 Hz), YG-455CN-1 (250 Hz), YK-88C-1 (500 Hz) CW filters;
- YK-88A-1 (6 kHz) AM filter
- VS-1 voice synthesizer
- SO-1 temperature compensated crystal oscillator
- MC-42S UP/DOWN hand mic.
- MC-60A, MC-80, MC-85 deluxe base station mics.
- PC-1A phone patch
- TL-922A linear amplifier
- SM-220 station monitor
- BS-8 pan display
- SW-200A and SW-2000 SWR and power meters.

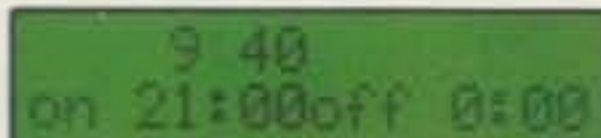

9.40  
on 21:00 off 0:00



SLOPE 1



V-B 21.250.00 US  
V-A 14.200.01 US



ANTENNA TUNER  
AUTO TUNE READY



- **High stability, dual digital VFOs.** An optical encoder and the flywheel VFO knob give the TS-940S a positive tuning "feel."
- **40 memory channels.** Mode and frequency may be stored in 4 groups of 10 channels each.
- **General coverage receiver.** Tunes from 150 kHz to 30 MHz.
- **1 yr. limited warranty.** Another Kenwood First.



More TS-940S information is available from authorized Kenwood dealers.

## KENWOOD

TRIO-KENWOOD COMMUNICATIONS  
1111 West Walnut Street  
Compton, California 90220

Complete service manuals are available for all Trio-Kenwood transceivers and most accessories. Specifications and prices are subject to change without notice or obligation.

# KENWOOD

...pacesetter in Amateur radio

## “Digital DX-terity!”



## TS-430S

**Digital DX-terity**—that outstanding attribute built into every Kenwood TS-430S lets you QSY from band to band, frequency to frequency and mode to mode with the speed and ease that will help you earn that dominant DX position from the shack or from the mobile!



### Covers all Amateur bands

160 through 10 meters, as well as the new 30, 17, and 12 meter WARC bands. High dynamic range, general coverage receiver tunes from 150 kHz to 30 MHz. Easily modified for HF MARS operation.

### Superb interference reduction

Eliminate QRM with the IF shift and tuneable notch filter. A noise blanker suppresses ignition noise. Squelch, RF attenuator, and RIT are also provided. Optional IF filters may be added for optimum interference reduction.

### Reliable, all solid state design.

Solid state design permits input power of 250 watts PEP on SSB, 200 watts DC on CW, 120 watts on FM (optional), or 60 watts on AM. Final amplifier protection circuits and a cooling fan are built-in.

### Memory channels.

Eight memory channels store frequency, mode and band data. Channel 8 may be programmed for split-frequency operation. A front panel switch allows each memory channel to operate as an independent VFO or as a fixed frequency. A lithium battery backs up stored information.

### Programmable, multi-function scan.

### Speech processor built-in.

### Dual digital VFOs.

### VOX circuit, plus semi break-in with sidetone.

### Optional accessories:

- PS-430 compact AC power supply
- SP-430 external speaker
- MB-430 mobile mounting bracket
- AT-130 compact antenna tuner covers 80-10 meters, incl. WARC bands
- AT-250 automatic antenna tuner covers 160-10 meters, incl. WARC bands
- TL-922A 2 kW PEP linear amplifier
- FM-430 FM unit
- YK-88C (500 Hz) or YK-88CN (270 Hz) CW filters
- YK-88SN (1.8 kHz) narrow SSB filter
- YK-88A (6 kHz) AM filter
- MC-42S UP/DOWN hand mic.
- MC-60A/80/85 deluxe desk mics.
- SW-2000/200A SWR/power meters
- SW-100A SWR/power/volt meter
- PC-1A phone patch
- HS-4, HS-5, HS-6, HS-7 headphones



# KENWOOD

TRIO-KENWOOD COMMUNICATIONS  
1111 West Walnut Street  
Compton, California 90220

Complete service manuals are available for all Trio-Kenwood transceivers and most accessories. Specifications and prices are subject to change without notice or obligation.

# KENWOOD

...pacesetter in Amateur radio

## Matching Pair

### TS-711A/TS-811A VHF/UHF all-mode base stations.

The TS-711A 2 meter and the TS-811A 70 centimeter all mode transceivers are the perfect rigs for your VHF and UHF operations. Both rigs feature Kenwood's new Digital Code Squelch (DCS) signaling system. Together, they form the perfect "matching pair" for satellite operation.

- **Highly stable dual digital VFOs.**  
The 10 Hz step, dual digital VFOs offer excellent stability through the use of a TCXO (Temperature Compensated Crystal Oscillator).
- **Large fluorescent multi-function display.**  
Shows frequency, RIT shift, VFO A/B, SPLIT, ALERT, repeater offset, digital code, and memory channel.
- **40 multi-function memories.**  
Stores frequency, mode, repeater offset, and CTCSS tone. Memories are backed up with a built-in lithium battery.



- **Versatile scanning functions.**  
Programmable band and memory scan (with channel lock-out). An "alert" function lets you listen for activity on your priority channel while listening on another frequency. **A Kenwood exclusive!**
- **RF power output control.**  
Continuously adjustable from 2 to 25 watts.

- **Automatic mode selection.**  
You may select the mode manually using the front panel mode keys. Manual mode selection is verified in International Morse Code.
- **All-mode squelch.**
- **High performance noise blanker.**
- **Speech processor.**  
For maximum efficiency on SSB and FM.
- **IF shift.**
- **"Quick-Step" tuning.**  
Vary the tuning characteristics from "conventional VFO feel" to a stepping action.
- **Built-in AC power supply.**  
Operation on 12 volts DC is also possible.
- **Semi break-in CW, with side tone.**
- **Optional voice synthesizer.**  
More TS-711A/TS-811A information is available from authorized Kenwood dealers.



#### Optional accessories.

- CD-10 call sign display
- SP-430 external speaker
- VS-1 voice synthesizer
- TU-5 CTCSS tone unit
- MB-430 mobile mount
- PG-2J DC power cable
- MC-60A, MC-80, MC-85 deluxe desk top microphones
- MC-48 16-key DTMF, MC-42S UP/DOWN mobile hand microphones
- SW-200A/B SWR/power meters:  
SW-200A 1.8-150 MHz  
SW-200B 140-450 MHz
- SWT-1 2-m antenna tuner
- SWT-2 70-cm antenna tuner

Complete service manuals are available for all Trio-Kenwood transceivers and most accessories. Specifications and prices are subject to change without notice or obligation.

## KENWOOD

TRIO-KENWOOD COMMUNICATIONS  
1111 West Walnut Street  
Compton, California 90220

# hy-gain<sup>®</sup>

## BROADBANDERS

### MAXIMIZE THE POTENTIAL OF YOUR HAM GEAR

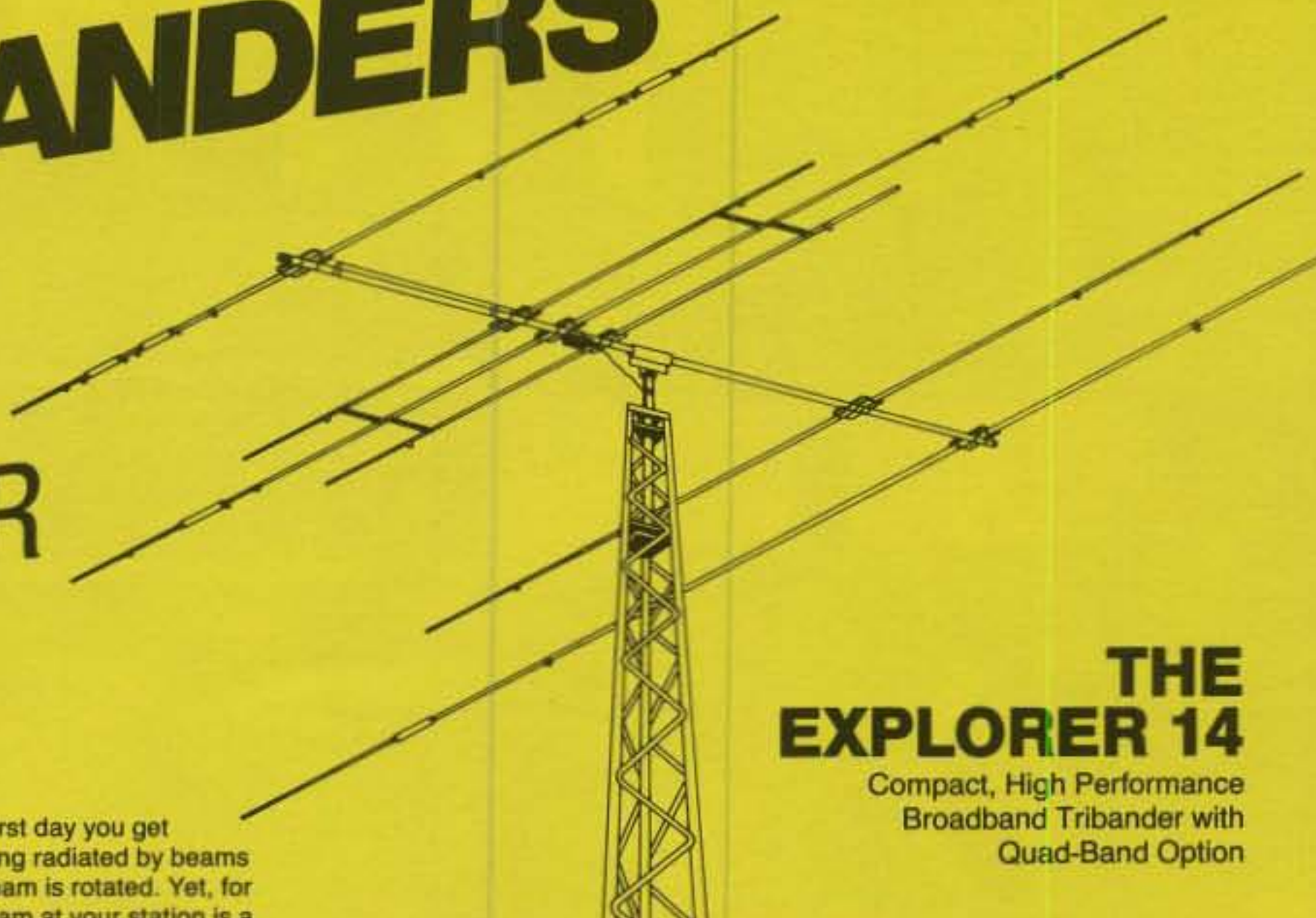

### THE EXPLORER 14

Compact, High Performance  
Broadband Tribander with  
Quad-Band Option

#### There is nothing like a beam!

You hear about the importance of the antenna system from the first day you get involved in amateur radio. You hear the big signals on the air being radiated by beams and you hear those same signals virtually disappear when the beam is rotated. Yet, for whatever the reason, getting on the air for the first time with a beam at your station is a down-right exhilarating experience. The universal reaction is "Had I really known, I would have installed a beam years ago".

The gain of a beam multiplies the effective radiated power of your transmitter just like an amplifier. More importantly, it amplifies the signal from the station being beamed. Off the sides and back of the antenna, the effective radiated power of those kilowatts on/near your frequency are reduced to manageable QRP levels.

A well-designed beam is by far the best performance buy you can make and it doesn't use any electricity. Further, if you buy a good one, it will last longer than some of the electronics gear in your shack. In terms of cost per hour of enjoyment, a beam antenna is among the least expensive major station components.

As sunspot cycle 21 winds down over the next few years the priority for a good beam shifts from "great to have" to "essential!" To maximize your station capability on the high bands choose one of these super broadband arrays.

#### THE EXPLORER 14

The same compact size as the well-known TH3Mk3 it replaces. The driven element uses an open sleeve dipole which is a concept that we call PARA-SLEEVE (Patent Pending). The para-sleeve design achieves the broadband performance objective. The forward gain and front to back ratio is very impressive, especially when compared with other antenna designs in the same size class. 43 lbs. (19.5 kg) of superb performance on a 14 ft. (4.3 m) boom. Turning radius 17 ft. (5.3 m) and 7.5 sq. ft. (.69 m<sup>2</sup>) of surface area. The EX 14 is the ideal choice where space is limited. Great for roof mount or on smaller towers. Optional QK7-10 kit adds your choice of either 30 or 40 meters to the driven element.

#### FIVE ELEMENT THUNDERBIRD TH5Mk2

Broadbanding is achieved with our unique dual driven element system. Five elements on the 19 foot boom (5.8 m), with four active elements on each of the three bands. 72 lbs. (32 kg) of rugged antenna with 7.4 sq. ft. (.68 m<sup>2</sup>) of surface area. Turning radius is a manageable 18.4 ft. (5.6 m).

#### SEVEN ELEMENT THUNDERBIRD TH7DX

This is a broadband successor to the legendary TH6DXX. Five active elements on 10 meters and four elements on both 15-20 meters. The TH7DX represents the ultimate in high-performance arrays whether you're comparing other large tribander's or stacked monobander's. 76 lbs. (35 kg) with a surface area of 9.4 sq. ft. (.87 m<sup>2</sup>), a 24 ft. (7.3 m) boom and a turning radius of 20 ft. (6.1 m). If you own a TH6DXX, a conversion kit is available which includes the second driven element, the completely new matching system, a full set of stainless steel hardware, and of course, step by step instructions. After conversion, your TH6DXX is a TH7DX, exactly.

#### FEATURES COMMON TO EX 14, TH5Mk2, and TH7DX:

- Separate Hy-Q traps for each frequency. Factory assembled and individually resonated to insure uniform performance.
- Handles maximum legal power with a respectable margin of safety.
- Unique broadband beta match assures efficient energy transfer and places the entire antenna structure at dc ground.
- BN 86 balun supplied as standard.
- Top quality stainless steel hardware supplied at no added cost.
- Super strong, taper swaged 6063-T832 thick-wall aluminum tubing used throughout.
- Unique Hy-Gain die cast aluminum boom to mast bracket. Accepts mast diameters up to 2½" (63 mm).
- Twist and slip proof die formed heavy gauge aluminum element to boom brackets.
- All tubing deburred and cleaned for ease of assembly.
- Only one set of dimensions for complete coverage of all three bands below 2:1 SWR.
- Designed to survive winds of 100 mph (160 km/hr).

The value of a Directional Antenna was one of my early "discoveries". Over the years, I have built or bought numerous Quads and Yagis. I have never been so impressed as I am with my TH7DX. I enjoy QRP but now have a problem convincing folks that I am only running 5 watts! The TH7DX is a superb antenna, both from a performance and a structural point of view.

Congratulations!

Jack Falker  
W8KR

(W8KR has worked all countries but two!)

**TH7DX**  
Seven element  
Thunderbird

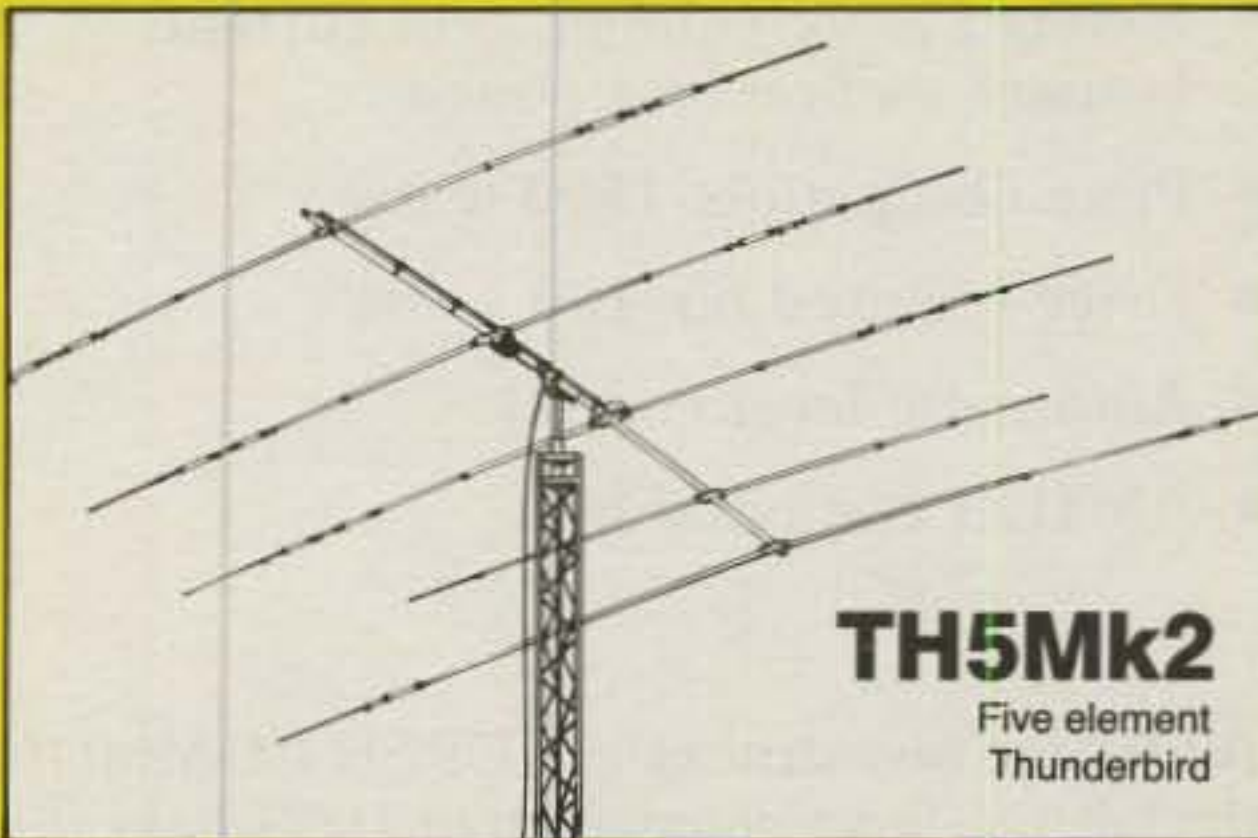
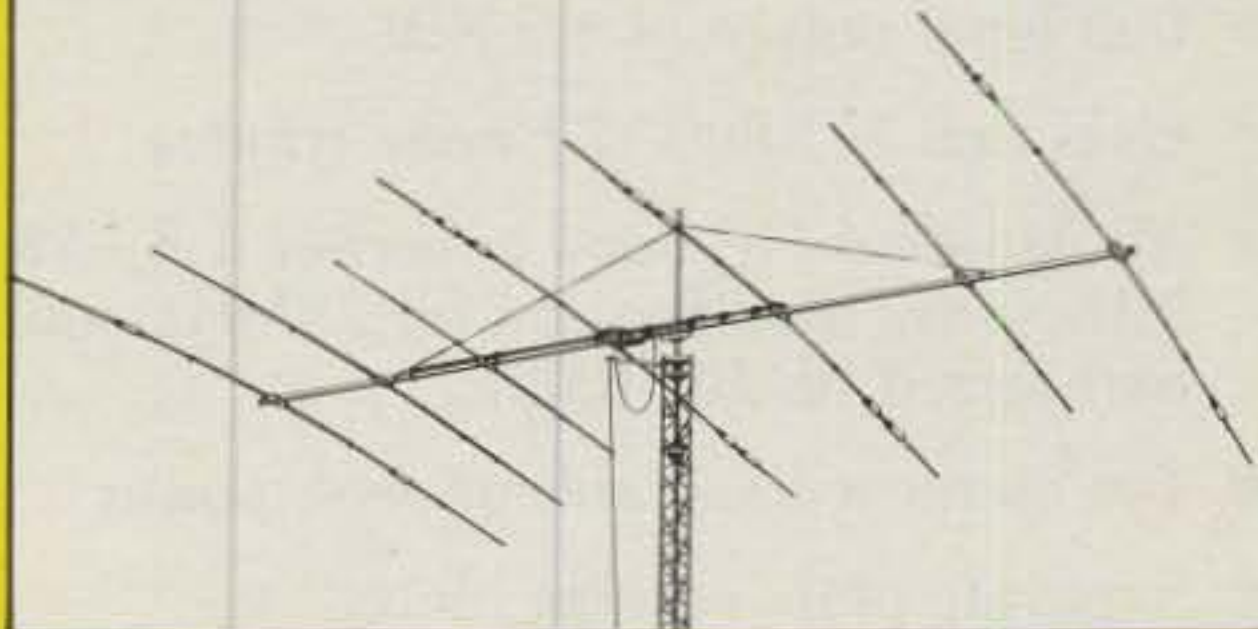

**TH5Mk2**  
Five element  
Thunderbird

**TELEX hy-gain<sup>®</sup>**

TELEX COMMUNICATIONS, INC.

9600 Aldrich Ave. So., Minneapolis, MN 55420 U.S.A.

Technical Assistance Hotline — Call 1-800-328-5652

# TITAN



## A 1.5 KW output HF linear amplifier built to last a lifetime.

- Full legal output of 1.5 KW
- Uses two 3CX800A7 Eimac triodes
- All Amateur HF band coverage 1.8 - 23 MHz (easy modification for 28MHz and authorized WARC bands)
- Ten element bargraph of peak power
- Separate plate current meter
- Metered plate voltage, grid current, forward and reverse power
- Plate dissipation: 1600 watts
- Drive required 65-100 watts
- Automatic level control
- AMTOR compatible
- Full break-in (QSK)
- Overdrive indicator
- Compact, matches modern transceivers
- Separate power supply for easy station layout
- Four status indicators
- High efficiency, tape wound transformer
- Tilt-up bail
- One year warranty
- UPS Shippable
- Made in USA

A lifetime investment in SUPER COMMUNICATION. The TITAN 425 Linear Amplifier delivers the full new legal power limit of 1500 watts PEP ssb output and 1500 watts of full break-in power for QSK cw, or AMTOR. This cool running dependable design delivers the punch to be heard under any band condition. And it is brought to you by the leading American supplier of hf Amateur equipment with the same kind of reliability you've come to expect from TEN-TEC gear.

Commercial version available on special order.

SEE YOUR DEALER OR WRITE

HOME BREW ? .....  
Write For TEN-TEC Enclosure Catalog .

**TEN-TEC**, INC.  
SEVIERVILLE, TENNESSEE 37862

**EDITORIAL STAFF**Alan M. Dorhoffer, K2EEK  
EditorGail M. Schieber  
Associate EditorLew McCoy, W1ICP  
Technical Representative**CONTRIBUTING STAFF**Frank Anzalone, W1WY  
Contest ChairmanJohn A. Attaway, K4IIF  
Chairman, CQ DX CommitteeSteve Bolia, N8BJQ  
WPX Contest Director

Larry Brockman, N6AR

Robert Cox, K3EST  
W.W. Contest DirectorsHugh Cassidy, WA6AUD  
DX EditorTheodore J. Cohen, N4XX  
Washington CommentaryLeo Haijsman, W4KA  
WAZ Awards ManagerDave Ingram, K4TWJ  
Amateur SpecialtiesGeorge Jacobs, W3ASK  
Propagation EditorDorothy H. Johnson, WB9RCY  
USA-CA DirectorSteve Katz, WB2WIK  
VHF EditorNorman Koch, K6ZDL  
WPX Award ManagerDonald McClenon, N4IN  
160 M. Contest DirectorKarl T. Thurber, Jr., W8FX  
AntennasAdrian Weiss, K8EEG/0  
QRPP EditorBernie Welch, W8IMZ  
Contest AdvisorBill Welsh, W6DDB  
Novice EditorBilly Williams, N4UF  
CQ DX Awards Manager**BUSINESS STAFF**Richard A. Ross, K2MGA  
PublisherDorothy Kehrlieder  
General ManagerArnie Sposato, KA2TYA  
National Advertising ManagerTori Hazlett  
Sales AssistantJack M. Gutzeit, W2LZX  
Advertising ConsultantArlene Caggiano  
AccountingCheryl Chomicki  
Customer Service**PRODUCTION STAFF**Dorothy Kehrlieder  
Production ManagerElizabeth Ryan  
Art DirectorBarbara Scully  
Artist

Pat Le Blanc

Richard Kishanuk  
PhotographersHal Keith  
IllustratorLarry Mulvehill, WB2ZPI  
Contributing Photographer

Offices: 76 North Broadway, Hicksville, NY 11801. Telephone: 516 681-2922. CQ (ISSN 0007-893X) is published monthly by CQ Publishing Inc. Second Class postage paid at Hicksville, NY and additional offices. Subscription prices: Domestic—one year \$16.00, two years \$29.00, three years \$42.00; Canada/Mexico—one year \$18.00, two years \$33.00, three years \$48.00; Foreign—one year \$20.00, two years \$37.00, three years \$54.00; Foreign Air Mail—one year \$73.00, two years \$143.00, three years \$213.00. Entire contents copyrighted CQ Publishing Inc. 1985. CQ does not assume responsibility for unsolicited manuscripts. Allow six weeks for change of address. Printed in the United States of America. Postmaster: Please send change of address to CQ Magazine, 76 North Broadway, Hicksville, NY 11801.



# The Radio Amateur's Journal



**ON THE COVER:** Keeping in a CW frame of mind, Neal McEwen, K5RW, displays some of his key collection for this CW Results issue. Photo by Larry Mulvehill, WB2ZPI.

OCTOBER 1985

VOL. 41, NO. 10

**FEATURES****RESULTS OF THE 1984 CQ WORLD WIDE CW DX CONTEST**

Larry Brockman, N6AR and Bob Cox, K3EST 13

TOP SCORES..... 14

CW TROPHY WINNERS AND DONORS..... 17

TOP ALL BAND SCORES..... 20

SINGLE OP ZONE WINNERS..... 22

USA CLUB SCORES AND DX CLUB SCORES..... 23

**A QUICK CONVERSION OF THE DRAKE L4B FOR USE**

WITH THE EIMAC 3CX1200A7..... Pete Warren, W5QMA 33

**CQ REVIEWS: THE KANSAS CITY KEYSER, MODEL KC-1**

Bob Locher, W9KNI 40

CQ SHOWCASE: NEW AMATEUR PRODUCTS..... 42

**CQ WORLD-WIDE DX CONTEST ALL-TIME PHONE**

RECORDS..... Frederick Capossela, K6SSS 46

**DATELINE... WASHINGTON, D.C.: THE INS AND OUTS OF THE WASHINGTON SCENE**

Dr. Theodore J. Cohen, N4XX 50

**HIGH-CLAIMED SCORES FOR THE 1985 CQ**

WW WPX CW CONTEST..... 52

**TICKET TALK: INFO ON AMATEUR RADIO LICENSING**

Frederick O. Maia, W5YI 54

**ANNOUNCING: THE 1986 CQ WORLD-WIDE 160 METER DX CONTEST**

56

**NOVICE: NOVICE LICENSING DATA, PART IV**

Bill Welsh, W6DDB 64

**ANTENNAS: READER REPORT, ANSWERING THE MAIL**

Karl T. Thurber, Jr., W8FX 78

**THE WORLD OF IDEAS: UNDERSTANDING MODERN**

AMATEUR GEAR, PART III..... Dave Ingram, K4TWJ 94

**VHF: PRINCIPLES, PRACTICES, AND PROJECTS**

FOR THE VHFER..... Steve Katz, WB2WIK 100

**DEPARTMENTS****AWARDS: STORY OF THE MONTH—S. LEO MCGRANAGHAN, WB4AIL**

Dorothy Johnson, WB9RCY 60

**CONTEST CALENDAR: CONTESTS FOR OCT. AND**

EARLY NOV..... Frank Anzalone, W1WY 66

**PROPAGATION: CQ WORLD-WIDE DX CONTEST SPECIAL**

George Jacobs, W3ASK 72

**DX: A MULTITUDE OF DX NOTES AND INFO**

Hugh Cassidy, WA6AUD 86

ZERO BIAS..... 6 ANNOUNCEMENTS..... 108

OUR READERS SAY..... 8 HAM SHOP..... 110

# Zero Bias

## AN EDITORIAL

**T**he response to my past few editorials has been very gratifying. Many of you are now thinking about the problems that face amateur radio and our precarious future. Although suggestions abound, most still center on what someone else, some group, or the government can do to solve the problems. Apparently, we're still a long way from thinking in terms of I and me.

Extending the Novice privileges is a very good idea, deserving of our support, but in and of itself it means very little to a person who has nothing to which to relate *more* privileges, let alone existing privileges. It's still going to take more "hands on" teaching at the grass-roots level. Another extension suggested by several readers (for some future date) is 30 meters. Although it is a small piece of spectrum, it does offer a universal low-power requirement, world-wide coverage, and our all-time favorite, CW. It would provide a theoretically equal footing with all other amateurs who must use the same CW and power limitations.

I've had several suggestions of a "computer class" of license for those who are now involved with computers. Obviously, this idea was put forward with a no-code provision (the spark still lingers) and would involve the exchange of data (no talking or key-clicks to worry about). I seriously doubt that this would go a long way toward turning on someone to a DX pileup. If we altruistically wanted to enhance the state of the art in data transmission, we wouldn't need amateur radio for that. We simply could push for an extension of CB privileges to include data. Now that would really ruffle some feathers and wouldn't sit well with anyone.

There have been letters spelling out what the amateur radio magazines should do, what the amateur radio industry should do, what the ARRL should do, and what the FCC should do. Most are well intentioned. For the most part, people have begun to think beyond themselves and their own particular license and are now paying some attention to the great world out there. So, even though some ideas may be well intentioned, they are nevertheless a bit impractical and overgeneralized. The best sign of all, however, is that we are creating some movement towards the problem.

Now if we stop and think about it, a lot of the "should do" activity is being done and a lot of ideas are being tried out by the amateur radio magazines, the amateur radio industry, the ARRL, and the FCC. It's not enough, pure and simple. There's not enough time, money, and people to do the whole job. We can, with your help, get the wheels turning, create the interest, and explore all sorts of ways to stimulate growth in amateur radio. It's still up to you on an individual basis to determine for yourself just what you are willing to do for amateur radio. The volunteer examiner program showed a lot of skeptics (me included) that amateurs could gather and mobilize for the common

good. Can we take it one step further?

I hope that by now we can accept the idea that demographics play a slim role in amateur radio. There really isn't a typical amateur or typical amateur activity. We can draw new amateurs from just about any group you can think of. If you check your amateur friends, you'll find that they have many different occupations, educational and social backgrounds, and a variety of life experiences and interests. That's the crux of the problem. There's no one handle on anything that large or varied. It's also the infinite beauty of amateur radio in that it truly has something for everyone. So, if we spend our time and efforts looking for the ultimate panacea, we're bound to failure and disappointment. What we have to do is think beyond the "who" or "what" groups of people, young or old, who might want to become amateurs and concentrate on similarities that all amateurs face. The only thing positive that can be achieved by appealing to groups is that it's easier to identify a member of a group, but it still doesn't make the criteria for the group correct. I believe that for a long time that kind of thinking stifled our growth, as evidenced by the rising median age.

When those of us of the median age group were drawn to amateur radio, there was a great similarity of interests and personality traits that hasn't existed since the early to mid 1950s. The youth gap plainly says that young people now simply do not identify or have the same aspirations as we did at their age. The magic is still there, but the approach is totally different. For us, amateur radio was a way of life. For young people today it is at best a part of life—a small part among many parts. Our job is to enhance that part and make that part attractive and desirable. That's done by being there to help, providing a good example and a demonstration of the fun and enjoyment that can be had from amateur radio. That's being people oriented, a thing we all profess to be. If we bring ourselves to do what we say we do, then half the battle is already won. On the other hand, if we're strictly looking to recreate ourselves at age 15, then look in the mirror. It's too late.

We are getting more Novices via the volunteer program. If we can concentrate on keeping their interest alive, encouraging their use of the Novice bands, and just becoming active to any degree, then we have a foothold on the next generation. They will do the proselytizing to their age group. The extended privileges for Novices or any other working program is at best six months to a year away. Your participation is as near as tomorrow. You have a better, nearer-in shot at making it work for all of us, right here and now. Each one of you holds the future of amateur radio within your grasp. Don't choke it.

### Travels With CQ

The stalwart CQ travelers were at the

Southwest Division Convention in Long Beach, California this past August at a most impressive setting. The Convention was held on the *R.M.S. Queen Mary*, now a floating hotel. In all honesty I must say the organizers for this event need a bit more organizing themselves. The one magnificent bit of organization was the choice of location. That couldn't have been better. Initially our booth was situated right next to the ARRL booth. While we are friends and all of that, it just isn't right to have us next to each other. The committee refused to move us, and it was through the kindness of AEA that we were able to switch booth space with them. The *Queen Mary* is also adjacent to "The Spruce Goose," the legendary seaplane built and flown by Howard Hughes. The plane is housed in a separate domed museum. Both the ship and the plane are superb attractions and well worth visiting. Since there was no fleamarket at the convention, we loaded up on posters and souvenirs to bring back. Norm Koch, K6ZDL, our WPX Award Manager, was there and spent some time at the booth helping out. He also brought me an old panel meter to bring home. He knew there wasn't going to be a fleamarket, and he didn't want me to go home empty-handed. Bill Welch, W6DDB, our Novice Editor, was there with his wife, and I enjoyed meeting them for the first time. I've talked to Bill for years on the phone, and it was nice to finally meet him. His group at the Lockheed ARC does have a followup program for amateur radio students to help get them on the air, and operating the club station is part of the Novice course. Lew McCoy, W1ICP, was there with his wife, Martha, and I think Lew's talk on antennas (what else) was the largest attended forum of the weekend. With a lot of CQ staffers there, Dick and I got a rare chance to get out and see all of the exhibits and new equipment. With Christmas coming up, I know that I've enlarged my wish list to include a few of the goodies that I saw there.

The next month or so will find us in Houston, Virginia Beach, Chicago, and Louisville, KY for the big events there. Get out there and mingle.

### Silent Key

Several of you wrote in to find out what happened to our annual Christmas cover this year. Our covers were original paintings done by John Rogers, W2ADC, a world-noted watercolor artist. John was quite ill this past year and decided not to do the cover, as it wouldn't have been up to his high standards due to his health. We both hoped to see another cover in 1985, but that wasn't to be. John passed away in July. Of the 16 or so years I knew John, it was less than 8 that I knew he was a ham. The subject never came up. I grew to admire his talent and his wit and looked forward each year to his view of "CQville." We all will miss him.

73, Alan, K2EEK



**TOP OF THE LINE  
ATU-1000  
ADVANCED TERMINAL UNIT**



More Hardware Features And Performance Than Any Other Morse, Baudot, ASCII, AMTOR, SITOR, or H.F. Packet Terminal Unit Anywhere At Any Price!

**Your ATU-1000's  
VERSATILITY**

- ... Puts you on all digital modes
- Morse/Baudot/ASCII/AMTOR/SITOR/H.F. packet (Software not Included)
- TTL I/O logic inversion for use with virtually any software
- Built-in TTL/RS-232/and loop keyer I/O
- Optional 19 inch rack mount kit
- 13 VDC operation, 110 VAC adaptor supplied

**PRECISION**

- ... Puts you precisely on frequency
- All shifts, 170 Hz fixed or 0 to 2000 Hz adjustable
- Set AFSK output tones independently from 1000 to 3000 Hz to one Hz
- 32 poles, active filtering
- Set receive filters to one Hz accuracy
- Set receive MARK & SPACE filters independently from 1000 to 3000 Hz
- CW filter adjustable 700 to 2500 Hz

**PERFORMANCE**

- ... Puts you ahead of all the rest
- Front-panel squelch control
- Discriminator-type tuning indicator
- 32 Poles total active filtering
- Built-in 4 digit counter
- Twin full-wave detectors
- D.C. coupled automatic threshold correction
- 5mV to 5V AGC

Ask your AEA dealer for a demonstration, or send for our latest specification sheet

Prices & Specifications Subject To Change Without Notice Or Obligation

**Advanced Electronic Applications, Inc.**  
P.O. Box C-2160  
Lynnwood, WA 98036  
(206) 775-7373  
TELEX: 152571  
AEA INTL

**AEA** BRINGS YOU THE BREAKTHROUGH

**ISOPOLE™  
"BREAKTHROUGH"  
BENEFITS**

**AEA**

You Can Afford It  
You Can Install It  
You Can Trust It  
You Can Excel With It

**PERFORMANCE**

- Low Vertical Radiation Angle
- No Feedline Radiation
- Wideband Matching Network
- Efficient Design
- Omnidirectional Pattern

**DEPENDABILITY**

- High Quality Materials
- Weatherproof Design
- Rugged Construction
- Advanced Engineering

**PRICE & CONVENIENCE**

- \$49.95 Amateur Net
- Easily Installed
- Compact & Lightweight
- UPS Shippable
- Inexpensive TV Mast Support (not Included)

ISOPOLE™ is available for 144 MHz, 220 MHz, 440 MHz  
Ask for our spec sheet and radiation pattern plots, or visit your favorite AEA dealer for more information.

(Prices and specifications subject to change without notice or obligation)

**AEA**

**Advanced Electronic Applications**  
P.O. Box C-2160  
Lynnwood, WA 98036  
(206) 775-7373  
TELEX: 152571  
AEA INTL

**AEA** BRINGS YOU THE BREAKTHROUGH

**AEA PACKET  
BREAKTHROUGH**



Your AEA PKT-1  
Allows You To:

\* Communicate at computer speed and with no errors on HF, VHF, UHF and OSCAR ... through QRM and QRN, and direct or via digipeater links...and leave a message, even when the person you want to talk with is not there.

**You Can Talk With:**

- Club stations
- Nets
- Bulletin Boards
- Mail boxes
- 2,000 stations now, and more every day

On 10.147 MHz; 14.103 MHz; 145.832 MHz; 145.01 MHz; OSCAR 10; and other bands and frequencies.

All you need is your home station, a computer, some communications software, and an AEA PKT-1 Packet Controller.

Call or visit your AEA dealer, or write for a complete information package TODAY. You can find out about PACKET by reading WB7GXD's tutorial articles in the September and October 1983, and January 1984 issues of 73 For Radio Amateurs.

**AEA** P.O. Box C-2160  
LYNNWOOD, WA 98036  
(206) 775-7373  
TELEX: 152571  
AEA INTL

**AEA** Brings You The BREAKTHROUGH

**LOOK!  
NOW YOU CAN MEET  
THE NEW FCC RULES!**

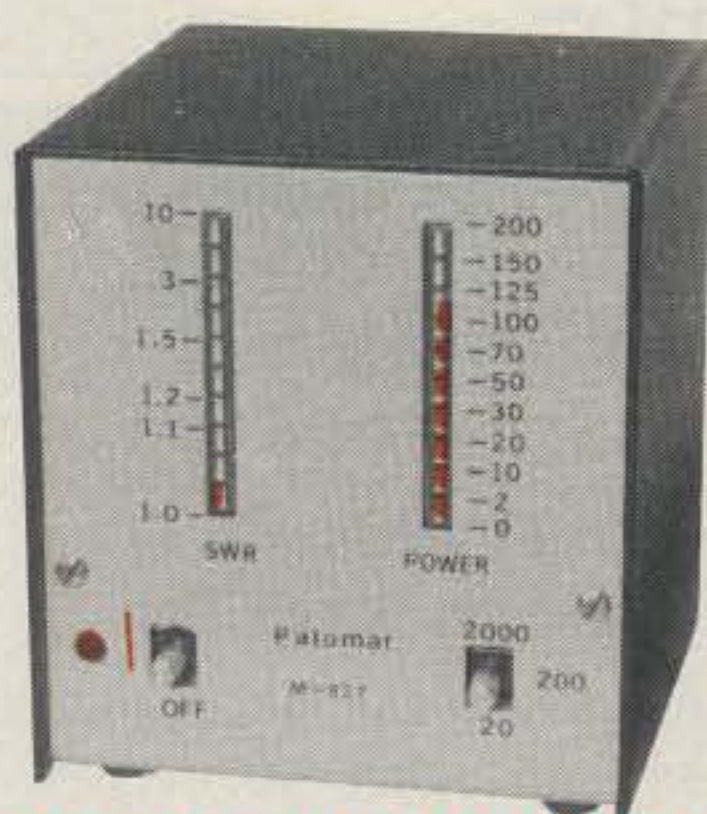

- **The only meter that shows PEP output Directly, Accurately, Instantly.**
- **Automatically computes SWR.**
- **Expanded SWR scale.**
- **Power ranges 20/200/2000 watts.**
- **Frequency range 1-30 MHz.**

**Automatic.** No "set" or "sensitivity" control. Computer sets full scale so SWR reading is always right. Complete hands-off operation.

**Light bar display.** Gives instant response so you can see SSB power peaks. Much faster than old-fashioned meters.

**Easy to read.** No more squinting at old-fashioned cross pointer meters. You can read the bright red SWR and power light bars clear across the room!

**Model M-827 Automatic SWR & Power Meter** only \$129.95 in the U.S. and Canada. Add \$4 shipping/handling. California residents add sales tax.

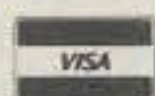

**ORDER YOURS NOW!**

Send for **FREE** catalog describing the SWR & Power Meter and our complete line of Noise Bridges, Pre-amplifiers, Toroids, Baluns, Tuners, VLF Converters, Loop Antennas and Keyers.

**Palomar  
Engineers**

1924-F West Mission Rd.  
Escondido, CA 92025  
Phone: (619) 747-3343

Please send all reader inquiries directly.

## Our Readers Say:

### One Is Not Enough!

Editor, CQ:

Ten meters is open, and there are many signals on 10 FM, all on 29.6, it seems. Just one simplex frequency on 10 FM? My ARRL Repeater Directory says so, but one is not enough.

How about using simplex on 29.59, 29.61, as well as 29.6? Even three simplex frequencies may not be enough, so when 10 is really busy, why not slip in between repeater output frequencies? For example, 29.63. Just keep your deviation under control.

See you on 29.61 FM simplex!

Bud Moist, AE7K  
Elko, NV

### Where Do We Find New Amateurs?

Editor, CQ:

I just read your interesting Zero Bias on the question of where do we find new amateurs? How do we attract the younger people?

Well, I'm not a young person, not in age anyway. But as an amateur I am. I took a Novice class sponsored by our local ARC. It was a good class and we all had fun learning our new language and basic theory and rules. It was a small class and we had 100% pass. We all thank our instructors.

Got my ticket 12/21/84, and it is now 2/11/85. Without taking my blood pressure I think it has only dropped a few points lower on the Novice bands than it was on 11 meters.

As we new operators learned, we get 50 kHz of the 40 and 80 meter bands and 100 kHz of 15 and 10 meters. Well, you don't have to hold a General license to realize that 10 and 15 meters are dead now. During the night 80 comes in and 40 dies. That leaves us younger people with 50 kHz to operate most of the time.

Now comes the point of this letter. The people in Canada use about 30 kHz of the 80 meter band for phone. The Novices are now cut to 20 or 30 kHz to work.

When younger people ask about "amateur radio" and I try to show them what it's all about, and I can't talk code 8 miles to a fellow Novice (KA8VQT) because of our fellow members of the CRRL on phone on the only band we have in the evening, I don't think we are going to attract many young operators.

I asked an Extra class license holder about the problem, and of course his answer was to study real hard and upgrade and you won't have a problem. I'm not so narrow-minded so as not to agree with him, but I do enjoy code, and right now if I

upgraded I probably wouldn't do as much code.

But your question was how to get younger people into ham radio. My suggestion is, don't let any new prospects hear our Novice bands. Thanks for hearing me out.

Jim Stone, KA8VQS  
Luzerne, MI

### A Unicorn Is The Answer

Editor, CQ:

This is just a brief note to congratulate you on the outstanding Editorial "Amateur Radio Needs a Unicorn," which appeared in the June issue of CQ. It is truly a masterpiece, and I think you have found the crux of the whole problem. Your Editorial should be required reading for ALL hams in the United States.

Pete Nissen, W4PTT  
Jacksonville, FL

### It Doesn't Have To Cost A Lot

Editor, CQ:

Just read your Editorial in the June issue of CQ. The thing that scares the kids away is the idea, actively promoted by all the magazines (who are supported by the manufacturers), that ham radio is and has to be a big money hobby.

If you want kids to come back, you have to let them know they can get on the air without the latest \$2300 rig, and show them how to do it.

Rodney W. Gray  
Belchertown, MA

### A Worthwhile Alternative

Editor, CQ:

Your editorial in the June issue raises several important points regarding the future of amateur radio. Amateur radio can be extremely rewarding to many older adults who are looking for an activity to become involved in. I raise this point because those trying to promote the field's growth sometimes forget its value for those involved in the Human Services either as a provider or recipient. Normally amateur radio is only considered in terms of its usefulness in a crises or emergency situation. However, it is a worthwhile alternate for people to consider who do not want to paint, jog, travel and/or spend a lot of time playing cards or bingo. Your readers' consideration would be appreciated in promoting this idea.

Dr. Robert Deitchman, Ph.D.  
Outreach Coordinator/Human Services  
Akron, Ohio

# SPECTACULAR SIMPLICITY



## KDK FM-240

### 2M - 25 WATT FM TRANSCEIVER

- Superior features, simpler to use for 2 meters, MARS, CAP
- Compact size for better fit in today's automobile
- 16 fully programmable memory channels, plus priority call channel, plus 2 VFOs for today's user.
- Subaudible encode and decode standard for today's 2 meter bands
- Subaudible frequency programmed by freq, no chart needed
- Speech synthesis option for voice VFO
- Superior man machine interface—one knob and one button, program all of the features easily—alphanumeric LCD prompts
- 16 button speaker/mic with UP/DN lock-out switch

This radio does every single thing we asked the design staff to make it do, and it does it in an easy to use, simple manner. It is truly spectacular to operate such a radio in the 2 meter band. For example, the FM-240 has two VFO modes—one called VFO, the other QSY. So if you are on your favorite channel and want to QSY, simply push QSY and tune the main knob to the new frequency. To return, simply push QSY again. The entire radio follows this simple but spectacularly effective engineering formula. ONE BUTTON + ONE KNOB, SIMPLY SPECTACULAR SIMPLICITY.

ENCOMM

2000 Avenue G, Suite 800, Plano, Texas 75074  
Phone (214) 423-0024 TLX 79-4783 ENCOMM DAL

ENCOMM

ICOM VHF Transceiver

# IC-271H



## The Versatile 100 Watt 2 Meter Base System

For the ultimate in 2-meter communications, ICOM presents the IC-271H transceiver with a high dynamic range receiver and a 100 watt transmitter...And all the advanced functions of the latest CPU controlled radios.



IC-PS30  
Power Supply

- 32 built-in Subaudible Tones
- High Visibility Display
- S-Meter and Center Meter
- Scanning Systems Memories, Modes and Programmable Band
- IC-HM12 Microphone with Up/Down Scan
- 11 $\frac{1}{4}$ "W x 4 $\frac{3}{8}$ "H x 12 $\frac{1}{8}$ "D

**The IC-271A.** The 25 watt IC-271A has the same outstanding features as the IC-271H, including an internal power supply, IC-PS25.



IC-271H  
Shown with internal  
power supply, IC-PS35

See the IC-271A(H) and other fine ICOM equipment at your local ICOM dealer today.

### Exceptional Standard Features:

- 143.800 - 148.199MHz, expandable for MARS operation
- 32 full-function Memories with lithium battery backup
- 100 Watts, fully adjustable on all modes
- Variable Tuning Steps, FM 5KHz and 1KHz; SSB 10Hz, 50Hz and 1KHz

**Optional Features.** AG-25 switchable preamp, UT-15S CTCSS encoder/decoder (encoder is standard), IC-EX310 voice synthesizer, IC-SM8 two-cable desk mic and IC-SM6 desk mic. PLUS a variety of power supplies... IC-PS30 system power supply, IC-PS15 external or IC-PS35 internal power supplies.



Internal  
Construction

CIRCLE 64 ON READER SERVICE CARD



First in Communications

ICOM America, Inc., 2380-116th Ave NE, Bellevue, WA 98004 / 3331 Towerwood Drive, Suite 307, Dallas, TX 75234

All stated specifications are approximate and subject to change without notice or obligation. All ICOM radios significantly exceed FCC regulations limiting spurious emissions. 271H1084

ICOM HF Receiver

# IC-R71A



## The World Class World Receiver

ICOM introduces the IC-R71A 100KHz to 30MHz superior-grade general coverage HF receiver with innovative features including keyboard frequency entry and wireless remote control (optional).

This easy-to-use and versatile receiver is ideal for anyone wanting to listen in to worldwide communications. With 32 programmable memory channels, SSB/AM/RTTY/CW/FM (opt.), dual VFO's, scanning, selectable AGC and noise blanker, the IC-R71A's versatility is unmatched by any other commercial grade unit in its price range.



**Keyboard Entry.** ICOM introduces a unique feature to shortwave receivers...direct keyboard entry for simplified operation. Precise frequencies can be easily selected by pushing the digit keys in sequence of frequency. The frequency will be automatically entered without changing the main tuning control.

**Superior Receiver Performance.** Passband tuning, wide dynamic range (100dB), a deep IF notch filter, adjustable AGC (Automatic Gain Control) and a noise blanker provide easy-to-adjust clear reception even in the presence of strong interference or high noise levels. A preamplifier allows improved reception of weak signals.

**32 Tunable Memories.** Thirty-two tunable memories, more than any other general coverage receiver on the market, offer instant recall of your favorite frequencies. Each memory stores frequency, VFO and operating mode, and is

backed by an internal lithium memory battery.

**Options.** FM, RC-11 wireless remote controller, synthesized voice frequency readout, IC-CK70 DC adapter for 12 volt operation, MB-12 mobile mounting bracket, two CW filters, FL32-500Hz and FL63-250Hz, and high-grade 455KHz crystal filter, FL44A.



CIRCLE 128 ON READER SERVICE CARD

 **ICOM**  
First in Communications

ICOM America, Inc., 2380-116th Ave NE, Bellevue, WA 98004 / 3331 Towerwood Drive, Suite 307, Dallas, TX 75234  
All stated specifications are approximate and subject to change without notice or obligation. All ICOM radios significantly exceed FCC regulations limiting spurious emissions. R71A1084

"The Key to Worldwide



Communications"

# HAM RADIO OUTLET

THE COMPLETE RESOURCE FOR YOUR HAM RADIO NEEDS.

## ICOM IC-R71A

SUPERIOR GRADE  
GENERAL COVERAGE  
RECEIVER



Regular \$799  
**SALE! \$629.95**

## TOLL-FREE PHONE

INCLUDING ALASKA AND HAWAII

## ICOM HAND-HELDS

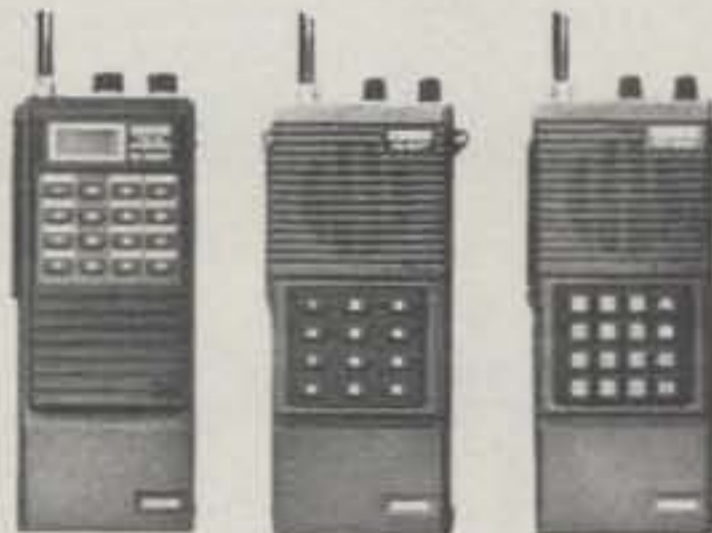

IC-02AT IC-2AT IC-3AT  
IC-04AT IC-4AT

**AT GREAT LOW  
SUMMER PRICES**

**FREE SHIPMENT**  
MOST ITEMS. U.P.S. SURFACE.

## ICOM IC-735

THE LATEST IN ICOM'S LONG LINE  
OF HF TRANCEIVERS

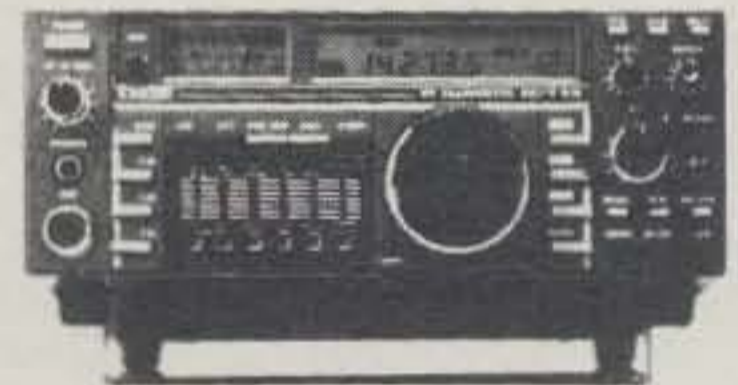

CALL FOR LOW, LOW PRICE

## ICOM IC-37A



220 MHz's **BEST BUY!**  
REGULAR \$449  
**SALE! \$299.95**  
LIMITED QUANTITIES  
THIS PRICE.

## ICOM LATEST EDITION IC-3200A DUAL BANDER

COVERS BOTH 2 METERS  
and 70CM



CALL FOR  
LOW,  
LOW  
PRICE

# 6 STORE BUYING POWER!

### PERSONALIZED SERVICE



BOB FERRERO W6RJ  
President  
JIM RAFFERTY N6RJ  
VP So. Calif. Div. Anaheim  
Managers  
GEORGE, WB6DSV Burlingame  
DON, N6IPE Oakland  
BOB, K7RDH Phoenix  
GLENN, K6NA San Diego  
AL, K5YRA Van Nuys  
and other active amateurs to serve you

# 800-854-6046

FREE SHIPMENT  
MOST ITEMS U.P.S. SURFACE

THE TOLL FREE NUMBER IS NOT IN EFFECT IN THE STATES OF  
CALIF. AND ARIZONA  
CALIF. AND ARIZONA CUSTOMERS CALL OR VISIT NEAREST STORE  
**PHONE HOURS: 9:30 AM TO 5:30 PM PACIFIC TIME.**  
**STORE HOURS: 10 AM to 5:30 PM Mon. through Sat.**

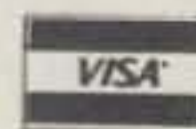

**ANAHEIM, CA 92801**  
2620 W. La Palma,  
(714) 761-3033, (213) 860-2040,  
Between Disneyland & Knotts Berry Farm.

**BURLINGAME, CA 94010**  
990 Howard Ave.,  
(415) 342-5757,  
5 miles south on 101 from San Fran. Airport.

**OAKLAND, CA 94609**  
2811 Telegraph Ave.,  
(415) 451-5757,  
Highway 24 Downtown. Left 27th off-ramp.

**PHOENIX, AZ 85015**  
1702 W. Camelback Road,  
(602) 242-3515,  
East of Highway 17.

**SAN DIEGO, CA 92123**  
5375 Kearny Villa Road,  
(619) 560-4900,  
Highway 163 and Clairemont Mesa Blvd.

**VAN NUYS, CA 91401**  
6265 Sepulveda Blvd.,  
(818) 988-2212  
San Diego Freeway at Victory Boulevard

AEA • ALLIANCE • ALPHA • AMECO • B & W • CALLBOOK • CENTURIAN • COLLINS • JSC • J W MILLER • KANTRONICS • SIGNAL ONE • STONER • TEMPO • TEN-TEC  
AMPHENOL • ANIXTER MARK • ANTENNA • COLUMBIA • CURTIS • CUSHCRAFT • KENWOOD • KLM • LARSEN • LUNAR • METZ • TRISTAO • TRI-EX • VAN GORDON • VOCOM  
SPECIALISTS • APRIL • ASTRON • BASH • DAIWA • DRAKE • DX EDGE • EIMAC • MFJ • MICRO-LOG • MINI-PRODUCTS • VIBROPLEX • WEST • YAESU and more  
BELDEN • BENCHER • BIRD • BUTTERNUT • GILFER • HAL • HUSTLER • HY GAIN • ICOM • MIRAGE • NYE • PALOMAR • ROHM • SHURE

Prices, specifications, descriptions subject to change without notice. Calif. and Arizona residents please add sales tax



Ville, OH2MM, traveled halfway around the world to visit Phil, YB0ARA, and put his station to the test in the all-band category.



A fine single band 21 MHz effort was shown by KA2DIV/V2A.

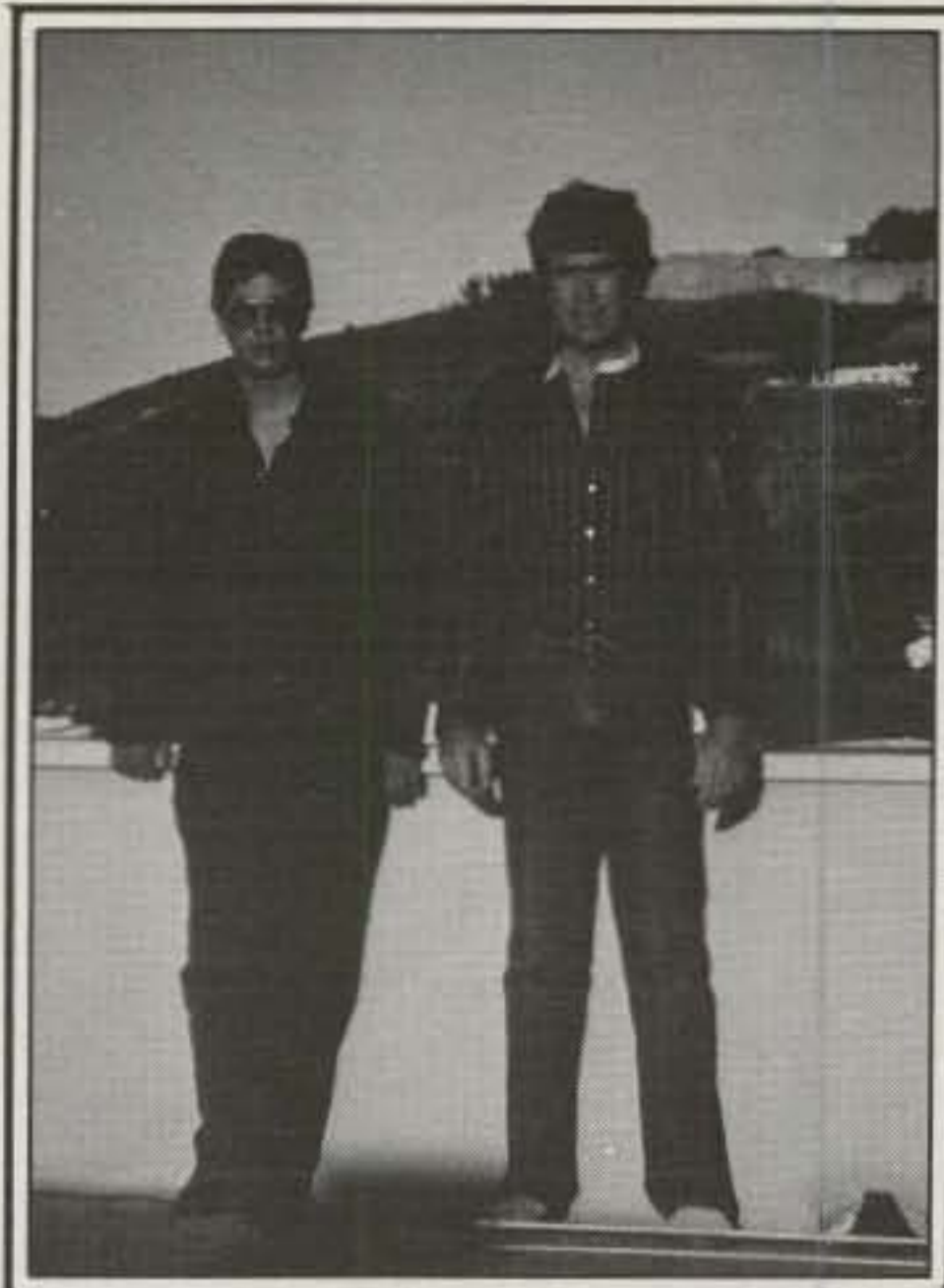

Jim Neiger, N6TJ, is shown here next to host EA9KF just before the contest. Jim managed a fantastic 5 million plus to finish second to rival N6AA from 9Y4VT.

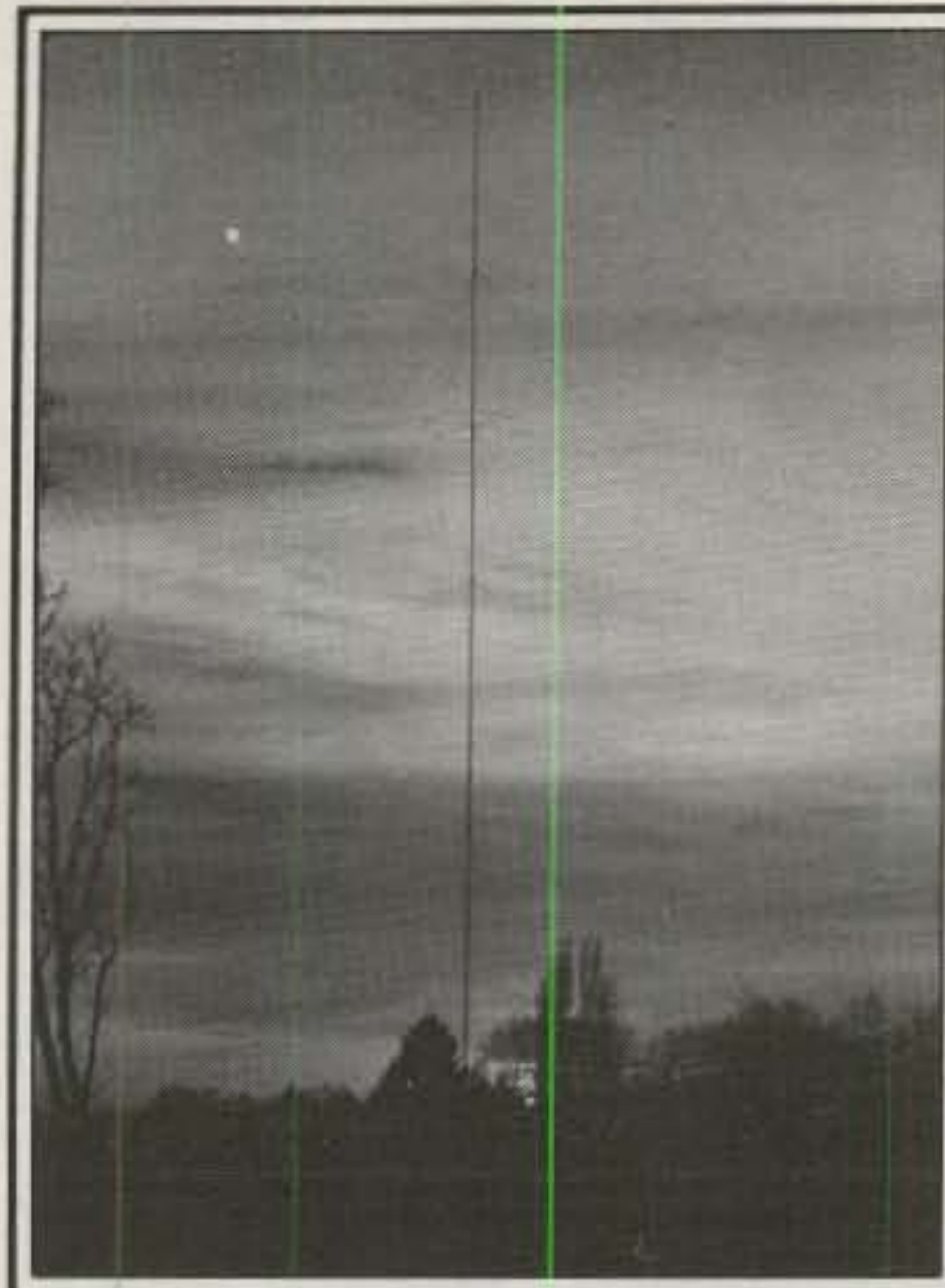

HB9AMO used this 85 foot vertical on 160 meters to amass 60K and a third-place finish. Lots of low-band activity at this time of the sun-spot cycle.

# 1984 CQ WORLD-WIDE DX CONTEST C.W. RESULTS

BY LARRY BROCKMAN\*, N6AR/4 AND BOB COX\*\*, K3EST,

It is the 47th hour of the CQ WW CW test, and our hero is just about exhausted. It has been a long contest this year. The receiver has hissed continuously on 28 MHz, and George is sure there is something wrong with it. Where were all those Europeans on 10? Surely 10 meters was worth more than 20 QSOs. And 80 meters—if George hears W3 blankety blank call CQ one more time he will scream. Does K6 ump de ump really think he can fool us into believing those imaginary JA calls George heard him "logging" on 40? With George's 5 over 5, he would have heard them for sure. And then there's the litany of DX stations just running contact after contact who failed to identify their call. George tried his best on that one, transmitting a well-placed di di dah dah di di in there often to wake up those turkeys. The nerve of that UK2 for telling George he had duped him 7 times on 20. Right now, George

was going to stop the daydreaming and get back to his CQing on 15. Got to get all those JAs he missed yesterday. This would be his best hour of the contest. But what's this? Oh, no. It's K6 ump de ump trying to take over George's frequency again. That guy would never learn; there he goes logging those imaginary calls, too. But George knows better, and another couple of cycles of the CQ machine and that K6 would be gone. Aw nuts, what's the use; George will move instead. So, up 5 kHz George goes and he strums out a CQ. "QRL, QRL . . ." resounds melodiously out of the receiver, so the dial spins again, and another CQ. "W3 blankety blank QRZ . . ."

Oh well, 40 is a better bet the last hour anyway. There are just 40 minutes left to go now, and George sets his mind to chasing multipliers. With a flash he is tuned up and ready to go. What's this? It's for real, SU11M on 40 CW. Boy, will he show that W3. George is going to scoop him on zone 34 on 40. So, George sets after his prey. George calls him long, and George calls him hard. Well-placed 4 by 4's; that will do it. "Lid, lid . . ." booms from the headphones, but our hero is sure they're talk-

ing about that lousy W3 who is in there now, too. "K6 ump de ump, K6 ump de ump de SU11M . . ." With this George has lost all vestige of the exhaustion we spoke of. George is now as single minded as a man can be. George is going to work that SU or else.

It is now 0005Z, and George is sure he will be next with the SU. Everyone has stopped calling, and it'll be clear on this next try. But the phone rings. It's Joe over at W3 blankety blank. "How was it? It was fantastic, the best CQ WW ever . . ." With that pearl, let us just check and find out how the Georges and Joes of the world did this year.

## The All Band Results

This year's new team competition seems to have generated interest and rivalry among some of the perennial entrants. The "Downhill Contesting Team" sent representatives to 5 continents, and ended up with 4 of the top 7 single operator scores in the world. Dick Norton, returning again to 9Y4VU, took the top spot with 5.6 million, with teammate Jim Neiger a close second with 5.0M from EA9KF. Jim

\*12041 Walker Pond Rd., Winter Garden, FL 32787

\*\*c/o CQ magazine

**A PEEK-A-BOO VIEW**  
of the new  
**AEA MODEL PK-64™**  
**PACKET SYSTEM**  
For the  
Commodore C-64 computer



The PK-64 PACKET RADIO SYSTEM contains everything you need to make your existing station and C-64 computer into an advanced packet radio station and digipeater with the least effort (and cost) possible with today's technology.

Check out just some of the special features in the following sneak preview:

- Hardware HDLC for full-duplex operation.
- Keyboard selectable HF or VHF modem built-in.
- Optional front panel tuning indicator for improved HF tuning.
- 12 Volt DC operation.
- Special MBA-TOR™ style Communications Software including:
  - Split screen for more efficient communications.
  - Text Editing
  - Disk and Cassette I/O and storage capabilities.
  - Internal Clock automatically logs connect and disconnect times and dates.

If you can wire a microphone connector on the end of a cable, now YOU can get on packet Radio for an introductory price under \$220. The PK-64 is scheduled for limited deliveries in September so order yours now from your favorite dealer, or send for more information.

Advanced Electronic Applications, Inc.  
POB C-2160, Lynnwood, WA 98036-0918  
(206) 775-7373

TELEX: 6972496 AEA INTL UW



managed an outstanding 160 meter effort on multipliers, but Dick made up for it with many more contacts (almost 200) and multipliers on 10 meters. Dave, N3RD/VP9, rounded out the top 3 with a fine 3.7 M. Marty Laine, OH2BH, posted a 4th place finish from CT1BCM, setting a new European Continental record, the only single operator all-band record set this year. In the USA category, Lew, N2LT, captured the lead with 2.2 M, and then WA8YVR at 1.9M and K1DG at 1.85 M. These were followed by 5 other W's within 200K of each other in a tough competition with many hours of poor conditions. The West Coast seemed to be particularly hard hit on conditions, with the best of the 6's and 7's managing to just break 1 M.

A contingent from Southern California traveled to French Guiana to join some of the locals for a super first-place effort in the world multi-single category (7.6M), a score that would have been second high in the World as a multi-multi. KD7P/KH2 provided much needed zone 27 activity in their 4.5 M second-place finish, a new Oceania record. EA3VY, 5H3BH, and HZ1AB in that order were in an incredible scramble for third, with only 100 K separating them out of 4 M. In the USA, it was Tom Taormina's new K5RC super station out of Texas that walked away with a 3.2 M first place, followed by K1ZZ and K1RX.

The boys at EA9CE radiated fine signals on all bands in their world high multi-multi effort with 9.2 M. Gene Walsh's N2AA multi-op machine took second honors from the USA with a fantastic 6.3M. Gene's 152 extra multipliers were no match for the extra 2800 W's and Europeans the EA9's logged. W3LPL and K6UA were second and third stateside, and fourth and sixth worldwide. YU1EXY, third worldwide, and JA9YBA, fifth worldwide, topped the multi-multi competition in Europe and Japan, respectively.

### Single Band Results

This was a disastrous year for the high bands as old sol continued the decline in the cycle. Virtually no 10 meter activity existed other than the all banders. But, out of the noise some of the faithful managed to pull as many as 280 contacts and 43 countries. 4M7QP took the USA high with just 15 K, followed by DJ6RX and W8WPC. Stateside, W8WPC's 8550 was tops, with Jay Carr, W6FAY, second at 5814.

Fifteen meters was also down somewhat (see some of the comments in QRM). Yet 9Y4W amassed 700 K to win for the world, with fellow South Americans PY5ZR and LU4FDM behind him. K2EK finished fourth worldwide with 277 K, enough for the USA lead. He was followed stateside by W4UM and W6YA.

Jorge, LU8DQ, lost in his bid to set a world 14 MHz single-band record to add to his existing 15 and 10 meter world records, but he managed to pile up 1 M points on 20, the only single band score to exceed 1 M this year. OH8OS took second place with 715 K, and set a new European record on the way. N5CR racked up 337 K to take USA honors, with N3RS and KM9D, both over 300 K, in close competition.

It was the low bands where the slack was taken up, particularly on 40 meters. Four Continental records and the USA mark were wiped out. In fact, 4 USA stations broke K0RF's old 1981 mark of 337 K, with Dave, N5JJ, taking the marbles with a phenomenal 424 K. N6RO, K5MR, and K6NA used the excellent JA and

### TOP SCORES

WORLD Single Operator All Band		USA Single Operator All Band	
9Y4VT	5,595,040	N2LT	2,192,028
EA9KF	5,014,224	WA8YVR	1,928,259
N3RD/VP9	3,668,256	K1DG	1,850,453
CT1BCM	3,295,152	K1OX	1,843,428
4V2C	3,205,896	W1KM	1,741,922
ZL3GQ	2,756,467	W4RX	1,663,305
YB0ARA	2,663,424	K1EA	1,634,165
FM/W6SZN	2,581,176	N4WW	1,615,940
EA2IA	2,468,804	W1RM	1,556,100
N2LT	2,192,028	K3WW	1,450,345
Single Op Single Band 28 MHz		Single Op Single Band 28 MHz	
4M7QP	14,980	W8WPC	8,550
DJ6RX	11,020	W6FAY	5,814
W8WPC	8,550	W9VA	2,046
W6FAY	5,814	W1VEF	1,431
JH2KKW	5,354		
JO1NZT	4,448		
21 MHz		21 MHz	
9Y4W	701,181	K2EK	276,727
PY5ZR	403,627	W4UM	228,384
LU4FDM	362,664	W6YA	189,810
K2EK	276,727	W5VGX	176,596
UP2BM/UF	258,405	K5TSQ	171,336
IK2DVG	230,608	K3VK	122,109
14 MHz		14 MHz	
LU8DQ	1,027,860	N5CR	336,708
OH8OS	715,692	N3RS	314,505
YU4GD	539,760	KM9D	307,024
YT3A	421,031	N6GG	247,628
YV1TO	418,698	W6BH	247,324
YU7AV	388,088	N7TT	243,595
7 MHz		7 MHz	
YX5A	696,150	N5JJ	424,853
DK3GI	608,612	N6RO	376,301
UP3BA/UF	573,648	K5MR	365,613
9Y4VU	546,735	K6NA	343,035
YU3EY	545,936	K1BW	314,360
TE1C	519,480	WT4A	254,898
3.5 MHz		3.5 MHz	
UP2NK/UF	283,362	W1FV	99,495
UZ9AWZ	250,614	AA6AA	92,133
UH8EAA	210,820	N4RJ	69,258
HA8KQX	210,240	N7DF/0	51,354
EA8RL	207,823	W9LT	37,051
I4EAT	160,540	W5RK	35,840
1.8 MHz		1.8 MHz	
LZ1KDP	78,088	K5UR	28,032
LZ2CJ	60,844	K1ZM	19,323
HB9AMO	60,680	N2SU	9,604
4X4NJ	48,114	W1CF	7,917
YV3AGT	47,679	N9NB	7,728
YV1OB	45,584	K6SE	7,500
Multi-Operator Single Transmitter		Multi-Operator Single Transmitter	
FY0GA	7,617,235	K5RC	3,221,384
KD7P/KH2	4,487,665	K1ZZ	2,773,744
EA3VY	4,053,000	K1RX	2,492,475
5H3BH	4,036,290	N4AR	2,445,534
HZ1AB	3,913,525	W3BGN	2,349,839
OK5R	3,656,054	W8UA	2,147,508
Multi-Operator Multi-Transmitter		Multi-Operator Multi-Transmitter	
EA9CE	9,170,984	N2AA	6,315,520
N2AA	6,315,520	W3LPL	4,646,621
YU1EXY	5,529,092	K6UA	4,217,924
W3LPL	4,646,621	W3GM	3,500,928
JA9YBA	4,470,165	W0AIH/9	1,723,711
K6UA	4,217,924	N4ZC	1,198,449





# ALINCO



### Linear Amps

2m and 70cm Micro Linear Amplifiers. Each of these amps include a heavy duty heat sink, a protection circuit and low pass filter for a clean signal. On three you get a GaAsFET RX preamp and even an RF meter on one.  
List Prices From \$69.95 to \$156.00



# ALINCO



### Power Supplies

Affordable performance is the final output of these workhorses. These high efficiency, high output, regulated supplies each comes with automatic current limit and shut down protection. Choose from 4.5 to 55 amps of output.  
List Prices From \$69 to \$333.



# ALINCO



**ALM-203T** List \$345.00  
2m FM Handheld Transceiver  
Don't decide on a handheld until you have seen Alinco's newest!  
Lightweight, low spurious emission and powerful.  
Transmit RF at 9.6 V - Low Power = .4 watt  
at 9.6 V - High Power = 3. watt  
at 13.8 V - Low Power = .5 watt  
at 13.8 V - High Power = 5. watt



## Memo:

To: Alinco Dealers  
From: Everett L. Gracey

If your customer has a failure with any Alinco product within 30 days, exchange the unit with a new one, providing a truck has not run over it or has been plugged into 117v direct.

After 30 days and up to 6 months if a failure occurs ask the user to send it back to Alinco and we will repair the unit at no charge, providing it has not been abused or modified.

Thank you for your continued support of Alinco products. The response has been terrific. Also, for your info we will have 100 of each item on shelf for immediate delivery.

Best Regards,

Everett

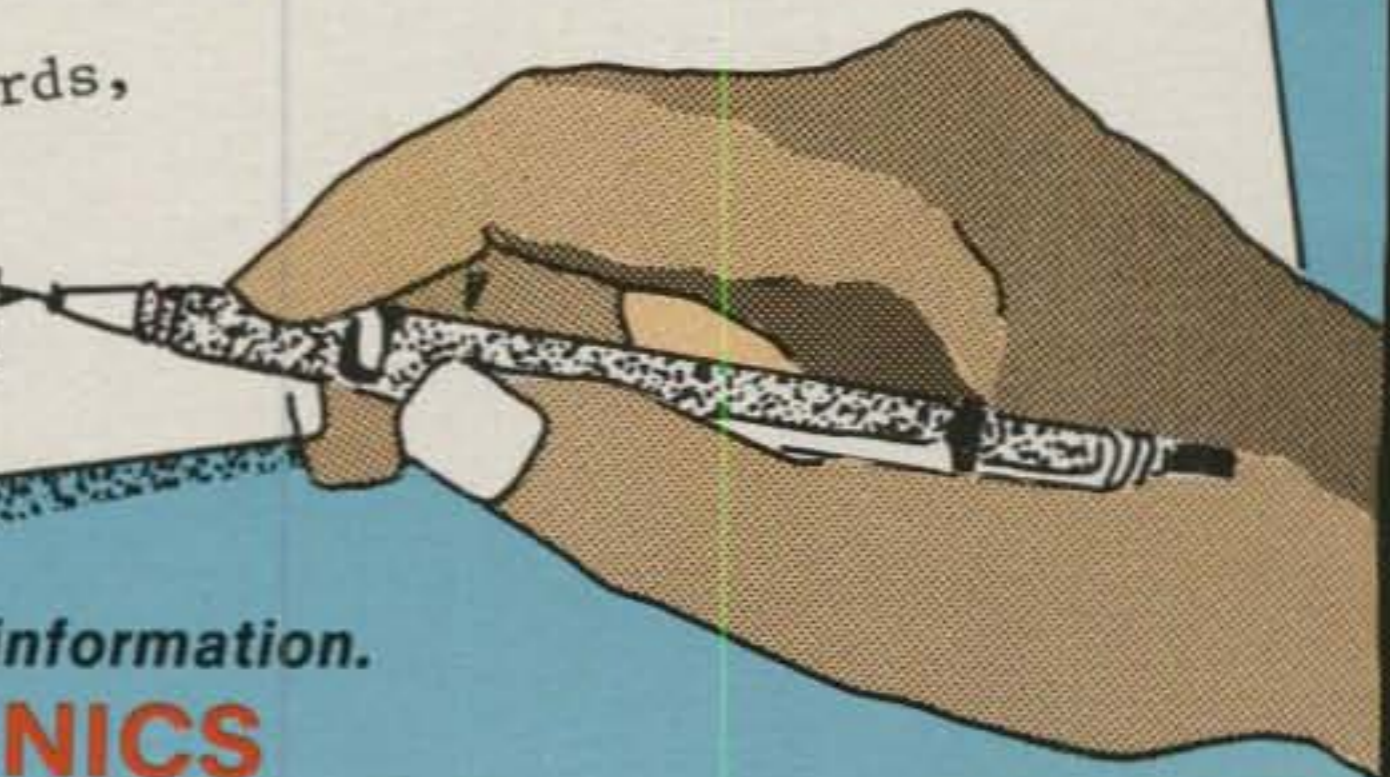

Contact your nearest dealer or Call Alinco Direct for more information.

## ALINCO ELECTRONICS

P.O. Box 70007 • Reno, Nev. 89570  
44 Glen Carran Circle • Sparks, Nev. 89431

Phone (702) 359-1414 • Telex 4993999 EGELECTR  
Facsimile (702) 359-1424



# Celebrate your buying decision with the money you've saved.

When it comes to getting maximum HF performance for your dollar, the choice is clear. Yaesu's FT-757GX.

Nowhere else will you find so many HF features packed into one compact, mobile-ready package. At a price that's got the competition baffled.

For starters, each 757 includes an electronic keyer, 600-Hz CW filter, AM and FM modes, AF speech processor. And a 25-kHz marker generator. All at no extra charge.

And working the DX has never been easier with dual VFOs, single-button VFO/memory swap for split-frequency operation, eight

memories, and push-button quick memory and band scan.

The 757 also lets you listen from 500 kHz to 30 MHz with its high-performance general coverage receiver. The transmitter covers 160 through 10 meters, including the new WARC bands, with 100 watts output on sideband, FM and CW.

CW buffs will enjoy the delights of full QSK operation. Plus the massive heatsink and duct-flow cooling system allow continuous RTTY operation for up to 30 minutes. Use the FP-757HD heavy-duty power supply option for continuous-duty applications.

And of course, there's the 757's highly attractive price. It's the

perfect way to get all the HF performance you desire, with money left over to apply toward other ham gear. Perhaps a power supply for base station use. An antenna or antenna tuner. Or whatever else makes your operation complete.

So ask your dealer today about Yaesu's FT-757GX. The most celebrated HF price/performer on the air.

## YAESU

Yaesu Electronics Corporation  
6851 Walthall Way, Paramount  
CA 90723 (213) 633-4007

Yaesu Cincinnati Service Center  
9070 Gold Park Drive, Hamilton  
OH 45011 (513) 874-3100

CIRCLE 126 ON READER SERVICE CARD

Prices and specifications subject to change without notice. Contact your Yaesu dealer regarding MARS operation.



Another 160 meter super effort from Charles, YV1OB, in his tent operating location.

European openings that lasted all through the night to finish above the old mark in that order. YX5A topped the pack worldwide with 696 K, a new South American mark. DK3GI and UP3BA/UF were next, each setting a new Continental mark for Europe and Asia. Randy, KH6XX set the fourth continental record with a 427 K score from Oceania.

In his first try outside of the home QTH, UP2NK managed to top the field on 80 worldwide with a fine 283K score, a new Asian record. He was trailed by Sam, UA9AN, from UZ9AWZ with 250 K, and UH8EAA with 210 K for a Russian and Asian sweep of the top 3. HA8KQX finished fourth by less than a 600 point margin, but managed to capture the new European record on 80. W1FV topped the competition on 80 in the States, with just under 100 K. He was closely pursued by Steve, AA6AA, at 92 K. Your Director, a long-term West Coast operator, is speechless over the thought of 60 countries in one weekend on 80 from California. Unless you have operated from W6 land, you'll never ever know how tough that is. Congratulations, Steve.

The low-band activity was phenomenal on 160, with many scores over 30 K this year, a score that would have seemed virtually impossible just a few years ago for all except the anointed. LZ1KDP set a new European standard with 78 K on the low band, with fellow countryman LZ2CJ second at 60 K. The rest of the top four included HB9AMO, narrowly edged out for second, and 4X4NJ. YV3AGT topped YV1OB for fifth place. K5UR was way out in front in the USA with a USA record high of 28 K. K1ZM was second at 19 K.

### Club and Team Contesting

The club competition was heated again this year, with Frankford Radio Club narrowly edging out arch rival Yankee Clipper Contest Club by 74 M compared to 71 M. The Southern California Contest Club was a distant third with 38 M. In the DX Club category, the Bavarian Contest Club put on a well-organized team effort, with most of the scores coming from the home front. Their 12 M put them on top, with the Kaunas Institute finishing second at 9M + . We would like to emphasize to all those interested in the club category that it is important that all logs from the clubs be clearly marked with the name of the club. Also, be sure your club sends a list of members and their claimed score. Inaccuracies in the club score total are most often caused by the absence of the right data.

As mentioned earlier, the team contest category seems to have encouraged some activity—particularly among the FOC crowd. However, the "Downhill Contesting Team," a

<b>CW TROPHY WINNERS AND DONORS</b>	
<p><b>SINGLE OPERATOR, ALL BAND</b> World <b>EA9KF (Opr. Jim Neiger, N6TJ)</b> Donor: W2AB Memorial</p> <p><b>World QRPP</b> <b>Robert D. Epstein, K8IA</b> Donor: Gene Walsh, N2AA</p> <p><b>World—Most Contacts</b> <b>9Y4VT (Opr. Richard J. Norton, N6AA)</b> Donor: KV4AA Memorial (14270 KHz Group)</p> <p><b>USA</b> <b>Lewis Tompkins, N2LT</b> Donor: Frankford Radio Club</p> <p><b>Canada</b> <b>Reginald Brearily, VE2AYU</b> Donor: Canadian DX Association</p> <p><b>Europe</b> <b>CT1BCM (Opr. Martin Laine, OH2BH)</b> Donor: Ed Bissell, W3AU</p> <p><b>Africa</b> <b>Chris Burger, ZS6BCR</b> Donor: Gordon S. Marshall, W6RR</p> <p><b>Asia</b> <b>VS6TA (Opr. Paul Newberry, N4PN)</b> Donor: Japan CQ Magazine</p> <p><b>Japan</b> <b>Toshio Takahashi, JA1BWA</b> Donor: Japan Crazy Contesters Club</p> <p><b>Oceania</b> <b>Peter W. Watson, ZL3GQ</b> Donor: Maui Amateur Radio Club</p> <p><b>SINGLE OPERATOR, SINGLE BAND</b> World (14 MHz) <b>Jorge Bozzo, LU8DQ</b> Donor: W2JT Memorial (NJ DX Association)</p> <p>World—3.5 MHz <b>A.K. Krigzde, UP2NK/UF</b> Donor: Fred Capossela, K6SSS</p> <p>World—1.8 MHz <b>LZ1KDP (Opr. Goshu Vodenitcharov, LZ1ZF)</b> Donor: KP4ES Memorial (Chip Margelli, K7JA)</p> <p>USA (7 MHz) <b>David Busick, N5JJ</b> Donor: Northern Illinois DX Association</p> <p>Canada (7 MHz) <b>Yuri Blanarovich, XN3BMV</b> Donor: Canadian Amateur Radio Federation</p> <p>Caribbean/Central America <b>TE1C (Opr. Carlos Fonseca, T12CF)</b> Donor: DX Club of Puerto Rico</p> <p>Australian—14 MHz <b>Ditmar Kiesewetter, VK2APK</b> Donor: Jay Carr, W6FAY</p> <p>Japan—21 MHz <b>Kazunori Kuroki, JR6EZE</b> Donor: DX Family Foundation</p>	<p><b>MULTI-OPERATOR SINGLE TRANSMITTER</b> World <b>FY0GA (Oprs. N6DX, N6ZV, N6VI, FM7CD, FY7AN, FY7CM, FY7YE)</b> Donor: Anthony Susen, W3AOH</p> <p><b>U.S.A.</b> <b>K5RC (Oprs. K5RC, NA5R, K5GN, KN5H, W5VAH, WA5ZVE, N5EA, K5GA)</b> Donor: Doug Zwiebel, KR2Q</p> <p><b>MULTI-OPERATOR MULTI-TRANSMITTER</b> World <b>EA9CE (Oprs. EA9GJ, EA9HE, EA9HY, EA9IE, EA9JL, EA9JV, EA9KF, EA9KN, EA9KQ, EA9LD, EA9LZ, EA9MO, EA9PB)</b> Donor: Hazzard Reeves, K2GL</p> <p><b>U.S.A.</b> <b>W3LPL (Oprs. W3LPL, AI3M, KC8C, KF3P, KT3Y, N2FB, W3FG, WD4AXM)</b> Donor: Jim Rafferty, N6RJ</p> <p><b>Europe</b> <b>YU1EXY (YU1EA, YU1EW, YU1FW, YU1MSK, YU1PKC, YU1PDF, YU1RL, YU1RS, YU1UU, YU3IW)</b> Donor: OH DX Ring</p> <p><b>CONTEST EXPEDITIONS</b> <b>World Single Operator</b> <b>David Hawes, N3RD/VP9</b> Donor: Yankee Clipper Contest Club</p> <p><b>World Multi-Operator</b> <b>5H3BH (Oprs. SM0AJU, SM0DJZ)</b> Donor: Bill Schneider, K2TT</p> <p><b>SPECIAL SINGLE OPERATOR COMBINED SSB/CW</b> World—All Band <b>Doug Grant, K1DG</b> Donor: John Knight, W6YY</p> <p>World—Single Band <b>Franklin Brooker, 9Y4VU</b> Donor: Yuri Blanarovich, VE3BMV</p> <p><b>CLUB</b> World—SSB/CW <b>Frankford Radio Club</b> Donor: CQ Magazine</p> <p><b>SPECIAL CQ MAGAZINE PLAQUES</b> <b>9Y4VT (Opr. Richard Norton, N6AA)</b> <b>VE7WJ (Opr. John Kiesel, KE7V)</b> <b>N2AA (Oprs. N2AA, K2BQ, K2GL, K2NG, K2SS, K2TT, K2TW, K2UR, K3EST, K5NA, KC2X, KR2Q, KU2M, W2RQ)</b></p>

team consisting of N6AA, N6TJ, N6XX, OH2BH, and OH2MM, just creamed everyone by sending off all 5 members to great spots on 5 different continents. As 9Y4VT, EA9KF, XE2MX, CT1BCM, and YB0ARA, these guys bullied there way to 18 M points, far ahead of the crowd. The FOC submitted four entries, but only three of the teams qualified, with

Team A (G3FXB, G3MXJ, G4BUE, OZ1LO, and ZL3GQ) taking second place with 7.1 M.

### Disaster Strike

It was bound to happen sooner or later. Unfortunately, it happened this year. As a volunteer group, the CQ Contest Committee is spread out over the country, and this neces-

sitates that we ship the logs twice—once from CQ to the Director in charge, who opens and sorts them and tabulates the high-claimed scores; and second, to each of the log checkers by the 13 categories. One of the boxes of contest logs was lost by the carrier in transit from the Director to the log checker. Specifically, the box of W4, W5, and W6 logs never got to their destination. After months of effort to trace and locate the shipment, we concluded that all was lost. Fortunately, as all logs are received by the Directors, the call, category, and score are recorded. Thus, we were able to construct the results for the entrants whose logs were missing on the basis of their high-claimed scores. After giving up on the carrier, every effort was made to collect the complete

line scores. We are indebted to the many stations who cooperated with us in our attempt to do this, and our apologies to those who didn't get the word. If your line score is not listed, please forgive us for the inconvenience.

### For The Record

For several years now we have been harping on the duplicate issue. Nevertheless, we continue to see the problem. People who should know better still leave duplicates in their logs, and neglect to fill out and send in check sheets with their logs.

Perhaps they ask whether it is fair to disqualify an entrant who works hard all weekend during the contest just because he leaves "a few" duplicates in the log. Let us emphasize



Station 4U11TU was put on the air this year by K1CC, a welcome European multiplier.

## Introducing the BUTTERFLY™ Beam from Butternut!

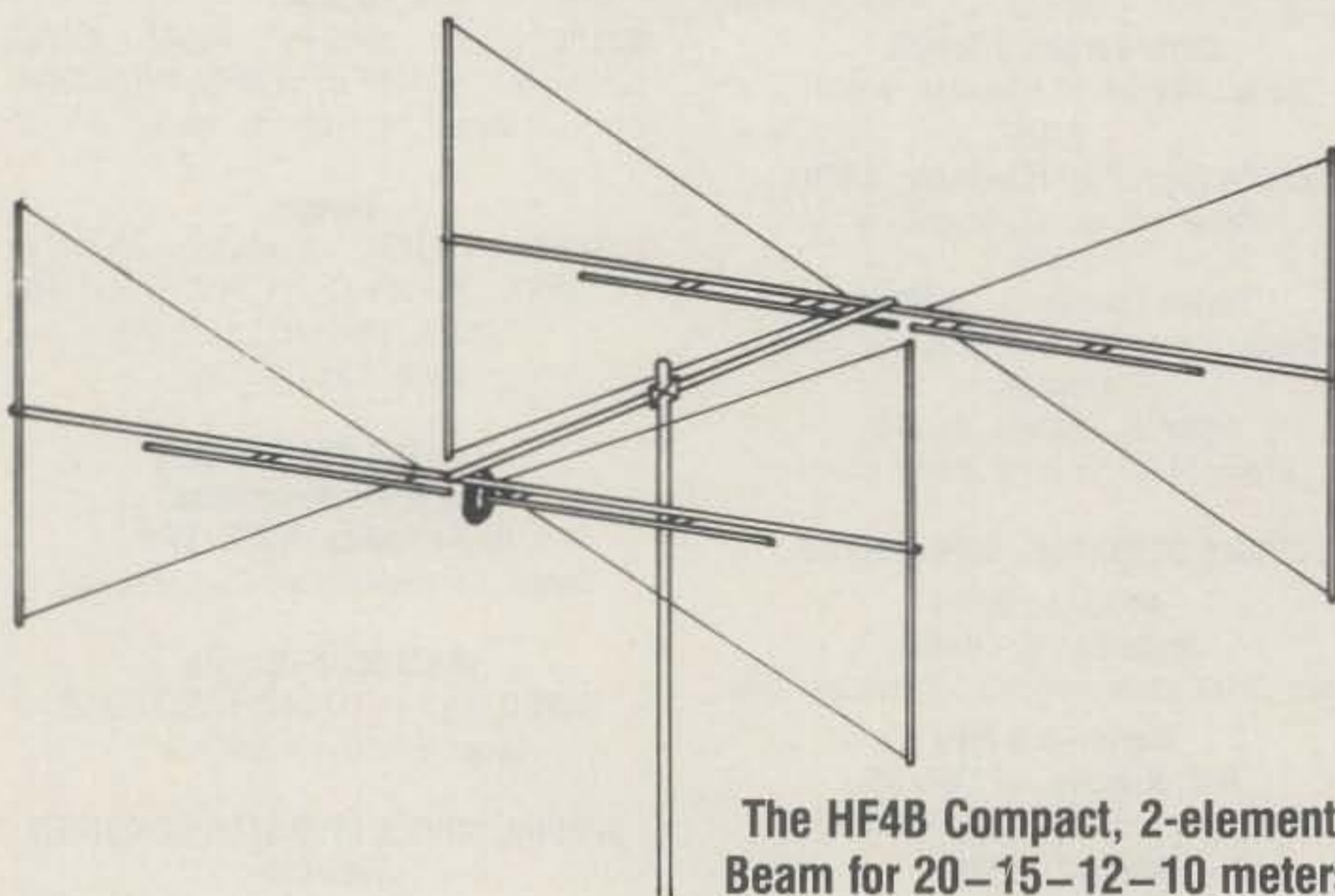

The HF4B Compact, 2-element  
Beam for 20-15-12-10 meters

### Compact Size

The HF4B's 12½-foot elements and 6-foot boom are ideal for home-station use and for weekend retreats, condos, apartments and other places where oversized beams are prohibited. Its light weight (17 pounds) means it can be turned with a tv rotator, yet it is robustly constructed in the best tradition of our world-famous Butternut verticals.

See your authorized  
Butternut dealer

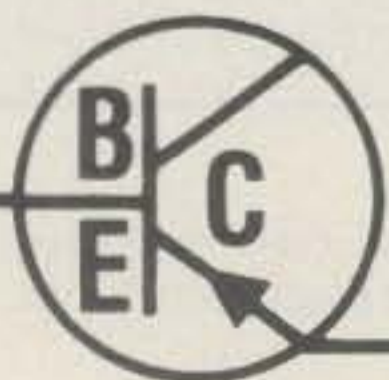

## BUTTERNUT ELECTRONICS CO.

405 East Market Street  
Lockhart, Texas 78644

Please send all reader inquiries direct.

### Performance

The HF4B BUTTERFLY™ has not sacrificed performance for compactness. Its unique design with fanned elements and L-C circuits avoids use of power-robbing traps yet provided high-efficiency operating on all bands. The BUTTERFLY™ outperforms anything in its class.

The HF4B offers an SWR of 1.5:1 or less at resonance. Its 2:1 bandwidth is 200 kHz on 20 meters, 450 kHz on 15, 1.7 MHz on 10, and across the entire 12 meter band. And it will handle the legal power limits both CW & SSB. Gain is at least 3 dB on 20, 4.5 dB on 15 and 5 dB on 10 & 12 meters. Front-to-back is up to 18 dB on 10, 12 and 20m, and up to 15 dB on 15m.

the other side. Is it fair to award someone who edges out a competitor by less than the point value of those duplicates? Those who lost in a tight one need assurance that their hard work and effort are rewarded and not someone else's sloppiness. The CQ WW Committee has a duty to preserve the integrity of the contest accordingly. Yet, each of our committee members is inundated with several hundred logs in each category. Time and workload preclude us from dupe-checking each log thoroughly. So, when we find a log that has a duplicate, our only recourse is to come down hard, and that's what we do. For the first 1%, the penalty is 3 QSO's for every duplicate. Up to 3%, the penalty is 10 QSOs for every duplicate. Above 3%, it's goodbye.

It is amazing that anyone would spend the time planning, traveling, and operating in some of the remote locations and then refuse to spend a few hours checking the log afterward. That is part of the game, and if you don't play the whole game, you may not finish at all. Take the time to check your log. Even if you do it during the contest, check it again afterwards. If you hate it so much you just won't check it, then avail yourself of one of the computer checking services. In any event, if you're serious enough to want to compete and be considered for an award, then you must accept the responsibility for the checking and for meeting a submission deadline.

There's a rash of disqualifications this year. Some of them would have been super efforts even had they been checked, but, they weren't properly checked. What a shame.

### Thanks Due

Our thanks to all who helped in the assembly and processing of this year's results. Our committee members include Frank, W1WY; John, K9DX/6; Terry, N6CW; Rick, N6ND; Dave, K2SS; John, K1AR; Ed, N3ED; Fred, AD6C; Jan, N6AW; Glenn, K6NA; Jim, W7EJ; Gene, N2AA; John, K2VV; and Doug, KR2Q. Their work and dedication are appreciated by us all.

Our thanks as well to all who participated in expeditions. Their activity gave all of us additional multipliers and fun. The calls we can thank are N6XX, N6AA, N6TJ, N3RD, WA3LRO, N4KR, N4PN, W6SZN, KD7P, JE1JKL, K1CC, K3UOC, K2KTT, UP2BM, UP3BA, UP2NK, OH2MM, OH2BH, OH2BAZ, VE3DAP, KA2DIV, FY0GA, GJ0AAA, VP2VCW, HZ1AB, 5H3BH, W8ZF, and others who put time, money, and sweat into making the contest special for all of us.

It's about time for George to appear again for the 1985 Contest. Good luck with that SU, George, and 73 to all.

Larry N6AR, and Bob K3EST

# You may not be able to solve the world's problems. But at least you can listen.



## The Panasonic Command Series™. With double superheterodyne tuning, you'll hear the world loud and clear.

Now it's easy to listen in on the world's hot spots. With the Panasonic RF-B600 Command Series FM/LW/MW/SW receiver.

Its advanced microcomputer-controlled tuner lets you preset up to nine different frequencies. And reach them at the touch of a button. Or, press the appropriate buttons and tune in any desired frequency with direct-access digital tuning. It'll lock right in to every signal with a PLL quartz-synthesized tuner. Once tuned in, the Panasonic double superheterodyne system helps deliver a clean, consistent signal.

There's even built-in auto-tuning to let you scan the shortwave band automatically, as well as manually. All this means you can tune in Berlin, pick up Paris, or locate London in an instant. Without dialing all over the band.

Both the RF-B600 and the RF-B300 are packed with features and built to go anywhere.

The Panasonic Command Series offers something for everyone. With equipment sophisticated enough to impress the most avid enthusiast, and automatic features that get you where you want to be. Fast.

There's a whole world out there that's waiting to be heard. Tune in to it with the Panasonic Command Series.



Batteries not included.

**Panasonic**  
just slightly ahead of our time.™

CIRCLE 80 ON READER SERVICE CARD

## BAND-BY-BAND BREAKDOWN—TOP ALL BAND SCORES

Number groups indicate: QSO's/Zones/Countries on each band.

### WORLD TOP SINGLE OPERATOR—ALL BAND

Station	160	80	40	20	15	10
9Y4VT	133/8/16	533/20/57	981/23/62	1219/29/75	1186/24/71	233/20/35
EA9KF	155/9/43	539/14/55	825/19/68	1182/29/71	1096/24/72	38/14/20
N3RD/VP9	73/5/9	336/14/44	1064/21/61	1192/28/82	1188/24/76	44/5/6
CT1BCM	166/8/37	390/19/64	742/21/66	712/30/72	1043/27/72	65/18/33
4V2C	37/6/9	416/22/55	1000/30/68	1024/30/60	1192/24/57	44/5/6
ZL3GD	19/10/10	160/22/41	420/21/47	554/27/62	1176/28/68	250/16/27
YB8ARA	5/3/4	183/21/31	455/27/62	845/33/73	851/25/66	34/16/23
FM/W6SZN	12/4/5	480/15/47	1192/20/61	293/19/49	944/21/55	203/8/8
EA2IA	5/2/5	588/16/54	710/20/75	998/28/76	736/26/75	4/3/4
N2LT	19/5/11	107/18/49	413/32/87	683/34/92	468/24/77	13/6/9

### WORLD TOP MULTI-OPERATOR SINGLE TRANSMITTER

FY0GA	148/13/41	420/18/57	1425/27/84	1303/35/84	1695/25/78	127/13/24
KD7P/KH2	61/11/11	428/24/34	895/32/60	619/35/81	1097/32/72	275/25/38
EA3VY	90/11/52	332/16/66	1354/24/81	1076/29/81	926/27/77	24/12/24
5H3BH	3/2/3	29/12/18	394/26/57	1279/33/90	1477/28/85	104/16/45
HZ1AB	107/9/32	319/10/38	1053/30/82	697/29/71	685/29/84	136/17/44
OK5R	151/8/50	701/23/77	880/31/97	813/35/98	460/34/89	34/12/32

### WORLD TOP MULTI-OPERATOR MULTI-TRANSMITTER

EA9CE	451/9/57	1065/16/61	1578/21/73	1679/32/78	1381/21/65	156/12/43
N2AA	140/17/48	295/23/77	1239/38/103	1126/37/122	591/28/89	97/14/24
YU1EXY	390/11/48	1020/23/73	1167/29/92	1424/35/104	600/33/98	100/15/35
W3LPL	57/11/28	223/21/70	932/36/108	748/36/109	704/27/100	60/17/26
JA9YBA	14/6/6	395/27/55	1117/33/88	1215/37/96	516/31/68	44/15/21
K6UA	134/11/16	396/24/48	923/34/93	900/37/104	508/28/68	126/17/28

### USA TOP SINGLE OPERATOR—ALL BAND

Station	160	80	40	20	15	10
N2LT	19/5/11	107/18/49	413/32/87	683/34/92	468/24/77	13/6/9
W8BYVR	26/7/16	147/23/55	267/34/76	576/36/85	424/27/75	24/11/14
K1DG	24/9/15	137/20/54	372/31/81	424/31/83	444/23/74	28/13/17
K10X	15/6/7	94/16/51	410/33/78	447/32/87	440/26/86	22/11/14
W1KM	20/8/14	227/19/64	258/29/71	390/33/83	406/26/74	17/9/12
W4RX	39/9/20	107/17/43	346/32/78	334/35/89	398/27/78	31/15/22
K1EA	7/4/4	118/17/45	305/30/70	597/28/79	372/24/76	22/12/14
N4WW	20/8/13	99/15/46	365/31/67	378/35/83	430/26/77	31/12/17
W1RM	3/3/3	126/2/59	179/30/80	400/31/91	416/27/78	21/12/14
K3WW	9/6/7	118/20/52	281/31/78	423/31/85	355/22/66	15/11/12

### USA TOP MULTI-OPERATOR SINGLE TRANSMITTER

K5RC	24/13/22	178/26/60	853/35/99	443/35/108	448/30/80	52/21/33
K1ZZ	29/9/18	145/17/53	413/31/88	641/33/102	540/27/87	27/13/18
K1RX	9/5/5	103/22/61	491/35/99	759/35/98	377/26/82	21/14/19
N4AR	33/12/26	109/22/62	439/37/110	604/36/98	383/28/79	23/15/21
W3BGN	43/14/30	113/19/58	355/35/92	649/34/95	408/27/84	26/14/21
W8UA	23/8/21	117/21/52	375/34/83	635/34/94	337/27/86	27/13/20

### USA TOP MULTI-OPERATOR MULTI-TRANSMITTER

N2AA	140/17/48	295/23/77	1239/38/103	1126/37/122	591/28/89	97/14/24
W3LPL	57/11/28	223/21/70	932/36/108	748/36/109	704/27/100	60/17/26
K6UA	134/11/16	396/24/48	923/34/93	900/37/104	508/28/68	126/17/28
W3GM	95/17/43	226/23/69	563/34/100	748/37/102	438/26/87	51/14/24
W8AIH/9	76/8/10	215/23/53	257/32/74	622/34/87	271/26/68	61/13/21
N4ZC	—	40/14/25	456/35/88	338/29/69	274/25/69	14/7/9

## DX QRM

This was my 43rd CQ Contest, and I really enjoyed staying on 40 for the first time. Nothing comparable to the mid 60's... UA9AN. 160 meters—wow!... FY0GA. Lost a pair of 930s, but still put zone 27 in a lot of logs via the incredible long paths on all bands... KD7P/KH2. Antenna was apartment dweller's special at 320 ft... W3HHB/KH6. With only 2 operators and 2 log keepers, a power failure, high power line noise and limited experience (our 2nd contest) we managed to survive the dogpiles and the weekend... VI3WI. The first CQ WW from a new location... YZ2CRU. This is our first multi-multi... JG1ZUY. Age 14—used no electronic or memory keyer, only "classical pump"... OH2BSS. Moved house just a few weeks prior to the contest; great to test performance of the new antenna in the premier operating event of the year... OH2BN. I am a schoolboy now in electronic middle school, age 19... SP4EEZ. Missed at least 50 QSOs and a couple of multipliers on 160 because of my CW... LZ2CJ. To the NH6J—rough copy and I think maybe I didn't make it, huh?... YU7AD. My company gave me two days off to prepare for the contest. On Monday everybody asked me what place I won... YU7AF.

Next year with a better antenna... OK1DMA. Very strong wind (about 140 km/hr.) partly destroyed my antennas... OK1AWC. WAC on 160 in 19 hours, 43 minutes YV1OB, W1RR, EA9CE, 4X4NJ, HB9AMO, and VK6HD... OK1DFF. Super 40; poor 10... OK5R. Much trouble with the antennas and electricity due to frost and a wind of over 160 km/hr!... OK1KSO. Our best score in this contest—many thanks for the contest... OK3KII. 40 and 80 were terrific... OZ8JYL. Our first time in the CQ WW and had a great time... G4OTU. Don't leave testing of new equipment and antennas until 4 hours before the contest... OH2BR. 22 years since my last contest... OH2AI. You'll never fall asleep if you drink the tea the chief operator gives you... DL0IU. A storm 2 days before the contest damaged our tribander, so little activity on the HF bands here... GU3HFN. N2AA was the loudest signal from North America on 80 and 40 all the time... G3VBL. Our 4th visit to the Channel Islands for the contest. The new club call helped to keep stations calling... GJ0AAA.

Enjoyed our 3 week trip to Malta with 18,000 QSOs CW only... 9H3DI. Very fine contest, but bad conditions on 10 and 15... PA3CEF. Too much trouble for 48 hours... YZ4Z. Excellent propagation, good activity... HA8KQX. Pileups on 40 were great... C53J. First all-band effort; will be back bigger and better next year... ZS6BCR. It would be nice to operate from the East Coast... VE7BS. No more Yagis. Couldn't get through to YB, DX1, etc. Back to loops in 1985... XN3BMV. Several power failures didn't help the QSO count... 9M2RT. Must be a long time since ZC4 was on in the contest judging by the ops who asked "4CZ?". Credit to the West Coast USA ops who got the call the first time... ZC4CZ. It was so hard to work Europe from this side of the World... NH6J/NH8. First serious effort for 8 years... ZL3GQ. 1.8 MHz from equatorial countries is hard... P29PR. After 25 years of CQ

WW DX contesting, this was my first DXpedition... UP2NKJUF. FY0GA was very strong in Asia on 160... UA9CBO. Thanks to CQ for this great contest... UA9AB. First time seriously from Europe as single op, modest station, and no conditions. Still, a record is a thrill!!... CT1BCM (OH2BH).

At whatever QTH I work the CQ WW, every year there is a storm that brings down the antenna (this year 40 M)... DL8MBS. The amplifier had to be turned off after 6 hours of operation because a neighbor's doorbell rang when I used it... DK3GI. Not good propagation on the upper bands, especially 28 MHz... EA2IA. Just wanted to look for DX stations, but got hooked... EA5CF. It is impossible for a little station to find a hole in the band for a call... ED1CI. After years of contesting on SSB, this was my first try at CW. All I can say is BEAUTIFUL... EA6GP. Very enjoyable contest, as always... EI4DW. East coast USA automatic keyers sure does raise the QRM level... EI3DP. Propagation fair, but no JAs... EI1DH. Despite the high winds on Saturday, my tower stayed up this year... G4BUE. 100 watts, 3 element Yagi, and 12 beers... F6AUS. The contest was great, but the logs are sure a lot of trouble... G3VMW. Most pleasant happening to find 15 open... G3ESF.

Very tiring on my first attempt ever... G4UOL. I realize I'll probably come in on the bottom with my entry, but who cares when I had so much fun... G3URA. California at 0957 on 40 (K6NA)!... G4IUF. Heard the first W break through Europe at 2332 on 3.5 MHz—finally worked him at 0153... GD5AVF. Last time I won the GM certificate was in 1957... GM8SQ. CW is a real pleasure for me; it's a kind of an art... HB9CWA. It was great fun working a pileup never possible from my home QTH at SP5EXA... JW0EQ. I like the everyone works everyone format... LA0EH. High speed Arctic flutter makes copy difficult... LA9ZV. TVI problems, a party, and a hangover... LA9GY. Highest multiplier I ever had... OZ1LO. Most expeditions only give their call signs every 5 minutes... OZ8AE. DX only heard during sun up/sun down passings... OZ8CT. Every year the biggest contest... PA0TA. Conditions poor on 160, but proud of my 58 countries... PA3BFM. Three more new ones added to QRPP DXCC... OK1KDR. Funny how little difference QRP or QRO really makes in a contest... PA3BUD.

## USA QRM

Greatest fun is meeting old friends—the camaraderie of a group contesting together... W3BGN. I survived another one... W4OO. JA's on 40 at 0430—the stack must work... K5RC. Single op keeps you busy... K3WW. Finally a chance to work the contest from the East Coast... N4WW (N6AR/4). I sure miss 28 MHz... K3LR. Take two aspirin and call me when the sunspots are back... K1AR. Power went out at 1306Z Saturday when a drunk driver knocked down a pole—it hurt me more than it hurt him... W1KM. Of all of the Friday nights of the year, why did my thrust bearing freeze up on this one... K1VR. Worked country number 100 on 160 M... W1WAI. Using a C-64 computer for

logging. Keyboard locked up and wiped out all the QSO information between 0400 and 1900Z on November 25 . . . W1OR. Strangest QRM problem—K1GQ's German Shepherd had 8 pups . . . K1DG. And I thought conditions were poor last year . . . W1HUE. WAC called me in 6 minutes . . . K2VV. Too bad the following stations on 80 M, all Q 5, couldn't hear the 6's calling them—UH8EAA, UR1RWX, ZL2JU, ZL1KVV, UP2NK/UF, YU1EXY, LZ1KAA, SK6JA, LA4PCI . . . AA6AA. Listening to 6's working JA's on 160, and can't even work the 6's . . . NA2Q.

With only 5 watts, this was a very long contest . . . AA2Z/1. Weird conditions—worked many Europeans long path . . . N3RS. My first Russian Roulette Contest—the wind blowing my free-wheeling beam . . . W1PL. Ten often open, but no activity . . . W7IR. Biggest thrill is pulling weak DX through loud W's calling CQ . . . W7FGT. Almost no Europeans heard on 21 MHz in Pacific Northwest . . . KE7C. If conditions get any worse, next year's log will fit on a postcard . . . KU7M. Or, it may come from Dr. DX . . . KO7G. In 1981 worked 162 USSR stations; in 1984 worked 23 of them . . . K7ZA. Can't wait till 1989 . . . K8NZ. Had several brief openings on 10 M to snag the countries I needed . . . W8WPC. Forty was really alive . . . W8UVZ. It was fun sharing the rig with my son, KA9QYA; his first contest . . . K9BQL. Wish more DX stations would work split on 80 . . . W9RN. Let's swap CW and SSB weekends every other year so the CW gang gets a shot at the usually better October propagation . . . W0WP. How about a low band category? . . . AB0X (ed.—the ARRL tried it). Like the new log forms . . . W0JU.

### Station Operators Multi-Operator, Single Transmitter

**AG7M & KW7Q. AK1L & KA1FBY, KA1X, KC1X. DF8AFZ:** DL3ZI, DL2ZAE, DK1DO, DJ0GN, DL4FBZ, DL5FO. **DF8BV:** DJ10J, DL/LX11, DL7MAE, DL1MAJ & DL5MAE, DK2OY, DL4MAH, DL5M80. **DL3HAH:** DF4XG, DL1HBT, DL2HAA, DL2HCB, DL3HAH, DL3HBS. **DL8ER:** DK7FP, DJ2LA, DJ5GN, DF5EN, DL6EAD, DL5EBN, DL9XY. **DL8IU:** DK7AH, DK8AG, DL4AAA, DL4AAE. **DL8LR:** DJ7PT, DL8RE, DJ2GW, DJ3Z, DF4WV, DF4WY, DF4PA, DF4PB, DF4PM. **DL8WN:** DA1PG, DJ1MU, DJ2RH, DJ9CB, DJ8LC, DF5ZP, DK6ZG, DK8FK, DL1AD. **DX1A:** DU1RU, DU1TW, DJ1US/DU. **EA3VY & EA3LL, EA3KU, EA3AIR, EA3AVV, EA3DXD, EA3EEE, EA3FER. EA6URP:** EA6DO, EA6DI, EA6EJ, EA6FG. **ED7BB:** EA7TH, EA7CFW, EA7BU, EA7FFA, EA7EL, EA7CEC. **F3TV:** F6ARC, F6BEE, F9IE. **F6ENV & F6DUR, F6BGY, F6FYA & F6KEO, F6ERS, F6IGF & F5UB, F6IWW & F6BYJ, F6AWN, FY8GA:** FM7CD, FY7AN, FY7CM, FY7YE, N6DX, N6VI, N6ZV. **G4OTU & G4XFB, GJ8AAA:** G3SXW, G3TXF, G3VVG. **GU3HFN:** GU3MBS, GU4WRP. **HA1KRR:** Sandor, Jozsef, Zsolt, Janos, Jozsef, Janos. **HA2KMR:** Jozsef, Atilla, Gabor, Csaba, Janos, Laszlo. **HA3KNA:** HA3FTA, HA3OV, HA3OU, HA3NS, HA3NU. **HA5KDY:** Miklos, Artur, Bela. **HA6KNX:** Jozsef, Gyula, Zsolt, Nandor. **HA7KMP:** Tamas, Janos, Alexandros. **HA8KCK:** HA8EK, HA8DZ, HA8DT, HA8ES, Marko, Atilla. **HA8KVK:** Laszlo, Jozsef, Laszlo. **HA8KWG:** Kezelo, Sav, Ado. **HB9AJ:** HB9AQF, HB9COC, HB9COF, HB9BWN, HB9CRP, HB9CJR, HB9CBT, HB9OL, HB9BEL, HB9CTU, HB9CIO, HB9CJJ, HB9CYK, HB9CCT, HB9UH. **HB9BXQ & HB9AKW, HB9BRJ, HB9BUN, HB9CKM, HG1S:** Fyula, Otto, Laszlo, Tibor, Laszlo, Istvan. **HG5A:** Peter, Laszlo, Tamas, Peter, Sendir, Manozsan. **HG6N:** HA6ND, HA6NY, HA6ON, HA6NQ, HA6DQ, HA6NF. **HG6V:** Laszlo, Geza, Sandor, Peter, Jozsef, Zoltan. **HG7B:** HA7UX, HA5WA, HA7UG, HA7UO, HA7SH, HA7UL. **HG9R:** HA9PP, HA9PV, HA9RB, HA9RP, HA9RU, HA9RX. **HZ1AB:** G4WZI, K2XR, W7KJ, W7SE, WA8MOA.

**JA1YAD:** JO1HJK, JR6JDE, JH7UCC, JH9ADA. **JH1YDT:** JH6UUN, JH8HNI, JP1AIE, JH4UTP, JK1UPX, JO1HSX. **JA1YNE:** JA1VNA, JA6QJG/1, JE3PTA/1, JH4VBO/1, JH3QYD/1, JA4WVO/1, JA7IHR/1. **JA1YXP:** JL1ROT, JM1AQV, JF2PPA, JJ1OHZ, JI2DLF. **JA1ZKL:** JI1RXR, JI1QBI, JK1JHU, JK1KIK, JL1DCA, JP1CZE, JM1WZP, JI1VFE. **JA2YKA:** JJ1BTA, JJ1BTC, JH2QXG, JR2GMC, JE2JCV, JE2TEM, JE2VYM, JF2DQJ, JF2LTH, JG2MTC, JG2VTD, JI2JXR, JI2NPL, JG3OET, JL3LDL, JA9SSY, JA9XXS. **JA5YAV:** JA5MVU, JR6JZF, JH5PHC. **JA7YAB:** JJ1NNJ, JR7CDI, JR7VMF, JA0-3440. **JA7YFB:** JJ1GX, JN1RON, JR7GYC, JR7JLU, JR7LCI, JR7OEF, JR7QYW, JR7RLB, JE7MOY, JH7XMO, JH7XKI, JH8QNT. **JA7YFH:** JH7SFR, JE7HXC, JR7UOL, JR7ECK, JE7HMC, JR7MRQ, JO1HBF, JE7WOH, JE7JWU, JE7RCC, JE7XTD, JR7MPT, JG2XUR. **JA7YRR:** JA7CLN, JA7JUD, JA7MOQ, JA7OZW, JA7LBY, JH7VHZ, JR7LVA. **JABYAU:** JR7CDO, JH8DXI, JH8MQZ, JH8NFQ. **JABYBY:** JG1RVN, JE3XWH, JG3DVR, JR3MGM, JH5OHJ, JR8DQB, JH8KJW. **JA3ZRT/JD1:** JE3MAS, JH4PAM, JL3TLC. **K1RX & KQ2M, K1RU, KF1V.**

**K1XM & K1PR, KQ1F, N1RC, K1ZZ & K1TO, K3KG & K4BAI, K4FJ, N4KUJ, N4TX, W4NL, K5LZO & K2TNO, K5TU, KA5SBS, KESIV, NM5M, NM5RUS, K5RC & K5GA, K5GN, KN5H, N5EA, NA5R, W5VAH, WA5ZUE, K5RR & K5KJ, NR5K, K5RX & N5RZ, K6TQ & WA6TBO, K6ZM & AK6T, NB6L, K8RWL & K8FPC, K8SCM, K8UAA, K8VBU, KM8L, N8CIS, W8FI, K83MM & N3ARK, WB3FIZ, WB3LFQ, KC5DX & NN5E, KD7P/KH2 & K6GDX, KJ9W, KH6SP, AH6FS, WB3HVS, W3HHG/KH6 & KH6DD, KM1C & KB1T, W1PH, W2IQD, WB8BTH, KQ20 & K2BK, KR1R & KS1N, LX9BV: LX1WW, LX1JP. **LZ1KAA:** LZ1JW, Stoyanov, Ivanov. **LZ1KAP:** Glushkov, Tedfilov, Ganchev. **LZ1KBL:** Keremidhtchiev, Miladinov, Mimov. **LZ1KKI:** Vasilev, Rabadjiski. **LZ1KMC:** Kostov, Iliev, Ivanov. **LZ1KRB:** Kirov, Grudov, Nedialkov. **LZ1KRC:** Kostakiev, Pavlov. **LZ1KTM:** Hristov, Kirilow, Iwanov. **LZ2KCS:** Svetla, Toma. **LZ2KKK:** Kalajdziev, Georgiev, Diamandiev. **LZ2KTS:** LZ2HE, LZ2PO, LZ2CC, LZ2DF, LZ2UA, LZ2LZ, LZ2E41, LZ2A3102. **N2RM & WA2HGM, KB3TN, N4AR & K8CC, W8KIC, K4FU, N4TY, N4KG & KC4ZV, WZ4F, N6IC & KA6SKW, N6DZG, NY6Y, Sharon, N6VR & WA6FGV, NS6X, AC6T, N6MA, N6ADI, AC6I, N9WA & KA9SLM, WD9GYX, ND8E & KD8PZ, W8KEA, W8RSG.****

**OE3GBB & OE3GEA, OH1AA:** OH1CO, OH1DL, OH1JD, OH1JL, OH1WR. **OH2AI:** OH2BBF, OH2BJM, OH2AQ, OH2BCI, OH2BUQ, OH2BOW, OH2LQ, OH2BR & OH2BAD, OH2VY & OH2JA, OH2BEJ, OH2BEN, OH2BHP, OH2BOS, OH2BQ, OH2ND, OH2NG, OH2SK, OH2SL, OH2TO, OH2OZ, OH2UE, OH2UX, OH2XT. **OH7AB:** OH7UE, OH7RS, OH7JR, OH7XJ, OH7TF. **OK1KIX:** OK1AID, OK1MEY, OK1MWI. **OK2KQO:** OK2BVI, OK2PAA, OK2MMW, OK2DIV. **OK3KII:** OK3CEI, OK3CAW, OK3CTL, ex-OL8CNI. **OK3KSQ:** OK3-27790, Alena. **OK3KTD:** OK3CES, OK3TEV, OK3TCF. **OK3RJB:** OK3TCL, OK3CQD, OK3CQR, OK3CSB, OK3TCN, OK3-26994. **OK5R:** OK1ADM, OK1ADS, OK1ALW, OK1DIM, OK1DWA. **ON6BR:** ON4ASE, ON4ASV, ON4AYL, ON5IA, ON5IG, ON5VA, ON6YN, ON7XN. **OZ5EDR:** OZ1HET, OZ3GN, OZ4UN. **OZ7DEN:** OZ10KE, OZ1DYI, OZ1LZ. **OZ8JYL:** OZ1KHZ, OZ1IMH, OZ1GGM, OZ1JXH, OZ1FTW, OZ4DX, OZ1DGG, OZ1KUM, OZ5XY. **PA3ADJ:** PA0KHS, PA0NZH, PA3DGM, PA3DOW. **PA3CEF & PA3CEE, PA3CGN, PA4DEC:** PA3AWW, PA3BXD, PA3CJF, PA3CQU, PA3DJL, PA8LEG.

**RB4IXW:** Sirovatsky, Ovtcharov, Timonin. **RIBWF:** Vlad, Rinat, Pavel. **RL8PYL:** RA3AA, UL7PAE, UL7PAO, UL7PAZ, UL7PBE, UL7PBY, UL7-023-434. **SK2AU:** SM2BJE, SM2DQS, SM2JUR. **SK5AA:** SM5FUG, SM5ACQ. **SK5EU:** SM5GLC, SM5AQD, SM5DDQ, SM5LZM. **SK6JA:** SM6AOU, SM6DER, SM6DOI, SM6SQQ, SM6FYJ. **SK6RR:** SM6CVT, SM6LRR, SM6LW, SK7PI: SM7OXQ, SM7KNW, SM7KNM. **SP2ZPJ:** SP2FAP, SP2ASJ. **SP6PAZ:** SP6FJG, SP6CYX, SP6IGE. **SP9ZHR/9:** SP9EMI, SP9CTS, SP9NLI. **UB4EWE:** UB5ES, Oleg, Eddy. **UB4IWB:** RB5IHR, RB5IHW, UB5IER. **UB4IWR:** Timuz, Nick, Ivan. **UB4IXB:** RB5II, UB5IFZ, UB5IML, UB5IOL, UB5IRM. **UB4LZA:** UB5LEE, UB5LHZ, UB5LSL, UY5DV, UB5-077-1347. **UB4MWA:** UB5MDA, UB5MDD, UB5MMR, UB5MOJ. **UB4MWU:** UB5MWM, UB5MJS, UB5MWU, Nick, Igor. **UB4SWM:** Vasil, Vasil, Slava. **UB4VWA:** Ovcharenko, Guktovoj. **UB4XWB:** UT5QG, Viktor T, Viktor Y. **UC1AWC:** Leonid, Alexandir, Sergej. **UC1AWF:** Yuri, Sergei L, Sergei I. **UC1OWG:** UC20A, UC20EL, UC2RG. **UC1WWF:** UC2WBI, Nick, Alex. **UC1WWX:** Anatol, Oksoma, Walsilij.

# T.V.I. problems?

## Low pass T.V.I. filters from Barker & Williamson



Model	Power (Watts)	Cut Off Frequency	Frequency of Maximum Attenuation	Minimum Attenuation	Frequency Range	Price
FL10/1500	1000	34 MHz	52 MHz	70 db	1.8 - 30 MHz	\$29.50*
FL10/100	100	44 MHz	57 MHz	60 db	1.8 - 30 MHz	\$22.50*
FL6/1500	1000	55 MHz	63 MHz	70 db	6 meter	\$36.00*
FL6/100	100	55 MHz	63 MHz	50 db	6 meter	\$25.00*

All above to match 50 ohm transmitters and antennas.

\*Add \$2 shipping and handling

ALL OUR PRODUCTS MADE IN USA

**B&W BARKER & WILLIAMSON**  
Quality Communication Products Since 1932  
At your Distributors write or call  
10 Canal Street, Bristol PA 19007  
**(215) 788-5581**

Please send all reader inquiries directly.

# OSCAR SYSTEMS

## From Spectrum International

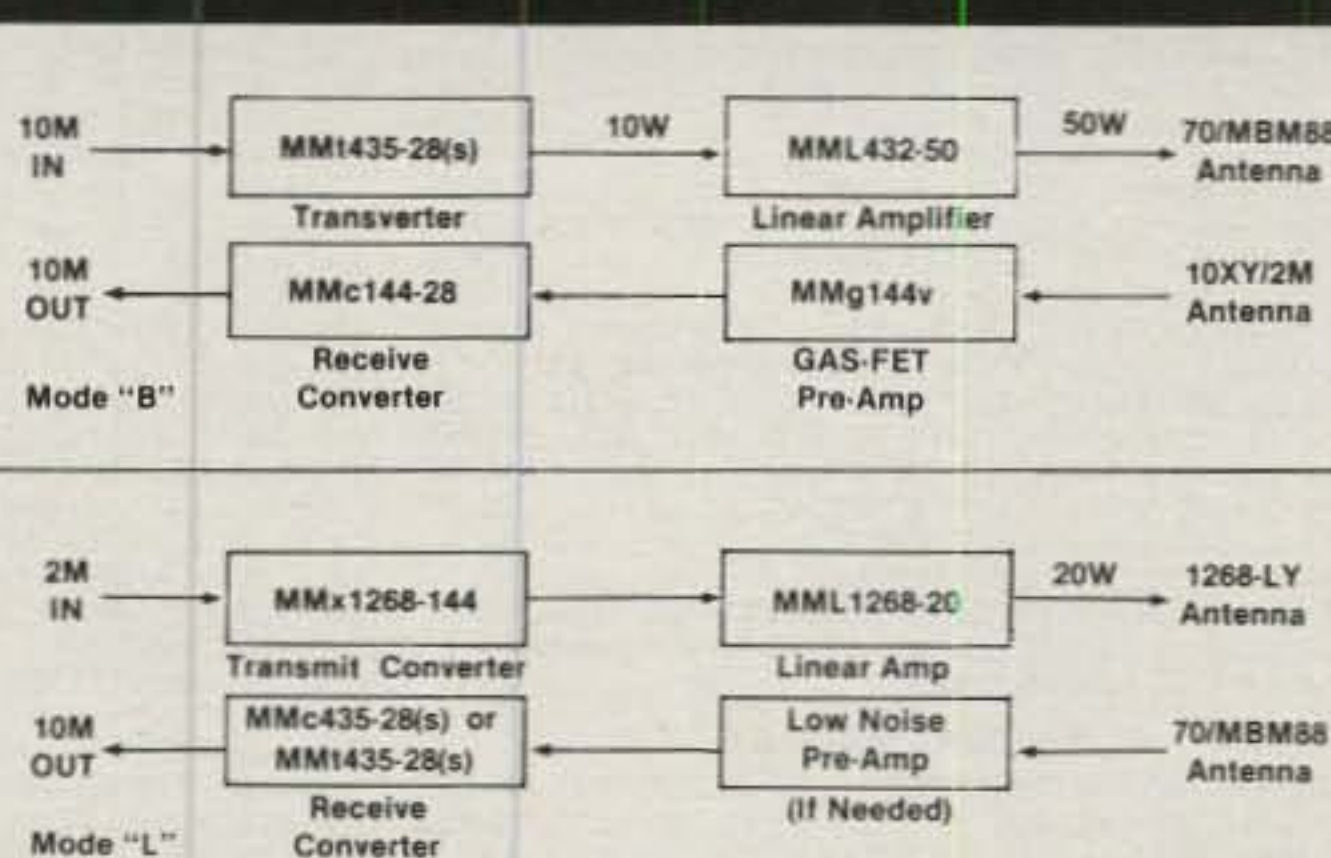

MMg 144v.....	\$54.95	10XY-2M .....	69.95
MMc 144-28.....	64.95	70/MBM88.....	94.95
MMc 435-28(s).....	94.95	1268-LY .....	49.95
MMt 144-28.....	189.95		
MMt 435-28(s)....	299.95		
MMx 1268-144....	259.95		
MML 432-50.....	199.95		
MML 432-100....	379.95		
MML 1268-20.....	ask		

Send 44¢ (2 stamps) for detailed specifications on all VHF/UHF products.

**si** Spectrum International, Inc.  
Post Office Box 1084Q  
Concord, MA 01742 USA

**UL88WW:** UL7BAY, UL788B, UL78CW. **UM9MWO:** UM8MFJ, Kim. **U040WR:** Slawa, Oleg, Alexey. **UP1BVG:** UP2BAA, UP2BLE, UP2BZ, UP2DT, UP2DZ, UP2-038-1191. **UP1BWW:** UP2BHM, UP2MC. **UP1BWW:** UP2BAS, UP2B8M, UP2BIJ, UP2MB, UP2PAX. **UP18XF:** UP2BAI, UP2BON. **UP1BZA:** UP2BIC, UP2BKH, UP2OX. **UP1BZG:** UP2BCO, UP2BCT, UP2BCW, UP2BOC, UP2DA, Grazyvdas. **UP2BZD:** UP2BFN, UP2BJQ, UP2BMX, UP2BNC, UP2BOA, UP2DO, UP38B. **UP18ZR:** UP2BDW, UP2BJK, UP2BQQ. **Dailyda, Matulaitis.** **UP1BZZ:** UP2BAW, UP2BIE, UP2BIL, UP2PAJ. **U016WW:** RQ2GG, UO2GDW, UO2OC, UO2OI, UO2-037-116, -83. **U016WY:** RC2ICC, UO2GMA. **U016XF:** UO2GFU, Dheyev. **U016XW:** Ziedonis, Mikhail, Vladimir. **UR1RWN:** UR2RKM, UR2TAX, UA3-123-325. **UR1RWO:** UR2-083-1013, UR2RNV. **UR1RWX:** UR2RDU, UR2RHF, UR2RNA, UR2RNX, UR2RNY, UR2RRD, UR2-083-167. **UZ1AWJ:** Vladimir, Eugeny O, Eugeny Z, Ilya. **UZ1AWO:** Vladimir, Andrei, Alex. **UZ1CXA:** RA1AX, UA1AGZ, UW1CX. **UZ1TWB:** RA1TA, UA1TCW, UA1UM. **UZ1ZWI:** UA1ZBQ, UA1ZN, UA1ZD, UA1ZV. **UZ2FWA:** UA2FF, UA2FJ, UA2FM, UA2FX, UA2FZ, RA2FA. **UZ2FWZ:** Valery, Victor, Serge.

**UZ3AXX:** RA3DUY, UA3AOV, UA3DHW, Ave, Anov, Kav, Oleg. **UZ3AZW:** Plugin, Kholodkov, Khanin. **UZ3DXF:** UA3SCN, UV3DN. **UZ3DXW:** Onischuk, Chervyakow, Vershinin. **UZ3DXU:** UA3QAY, UV3QAK, UA3-121-3176. **UZ3WWW:** RA3WA, RA3WBY, RA3WCG, UA3WZ, UV3WT. **UZ3XWM:** UA3XEX, Ali, Serge. **UZ4AWB:** UA4ABZ, UA4AMT, UA4AMX. **UZ4AXQ:** Valery, Nick, Alex. **UZ4FWN:** UA4FFG, UA4FFH. **UZ4WVB:** Vlad, Andrei, Nick, Alex. **UZ4WVC:** Shustov, Varmalaov, Sabrekov, Plastinin, Nikiforov, Pavlov. **UZ6AZR:** UA6ABS, UA6BPU, Denis. **UZ6LXM:** UA6LFO, UW6OE, Yuri. **UZ9AYA:** UA9ANF, Zaev. **UZ9AYE:** UA9AMA, UA9AOD, Chernicov. **UZ9CWW:** UA9CDC, Varganov. **UZ9FWR:** RA9FN, UA4WA, UA9FAL, UA9FAR, UA9FGJ. **UZ9HWA:** UA9HEA, UA9HEC, UA9HO. **UZ9SWY:** UA9SGW, UA9SGT, UA9SHD, UA9SIZ, UA9TS. **UZ9SXT:** UA9SAC, UA9SAR, UA9SCG, UV9SN. **UZ9UWK:** RZ9UZN, UZ9UEA, UA9ULB. **UZ9XWZ:** UA9XDG, UA9XDM, Eugeny. **UZ9XWW:** UA9XBD, UA9XHY, UA9XM, Budanov. **UZ9AWB:** Cuytez, Kovalenko, Kochkin. **UZ9CWA:** UA9CB, UA9CEM, UW9CA, UW9CM, Gorelic, Svytkovsky. **UZ9FWA:** UA9FCA, UA9FM, UA9FFH, UA9FFM, UW9FM. **UZ9QWA:** UA9QAS, UA9QBB, UA9QDC, UA9QDL. **UZ9QWE:** UA9QAA, UA9QJ, Alex.

**V9ADC:** WA2HZR, ZS6ME. **VE2CP & VE2BHC:** VE2BLX, VE2FKZ. **VE3S00:** VE3ADP, VE3CRD, VE3EOW, VE3GF, VE3K0Y. **V13WI:** VK2EFJ, VK3BPW, VK3CWB, VK3DWN, VK2KFO. **V02WL:** K3TM, V02AH. **W20W & KB2KW:** K12P, N2HR, NE2W, N6IN. **W2UI & N3KR:** W2XL & NA2N. **W38GN & N2BA:** WA2ZKY, N3RG. **W3NZ & K03H:** W3YFV & K3PPI. **W6BJH & net:** WA4JXI & WA4SV0. **WA4QQV & WA4QM0:** W66ZHT & K6HMA, N6HCS. **W8GWC & N8DCJ:** W8CZJ, W8JGU, WA8DXB, W8RCN. **W8NA & W8AR:** W8CY, WA8TKJ. **WA4JXI & WA4SV0:** WA4QQV & WA4QM0. **W86ZHT & K6HMA, N6HCS:** Y31ZL: Y31SL, Y31RL, Y25CL. **Y35L:** Y23DL, Y26IL, Y33VL, Y26BL. **Y43ZD:** Y43WD, Y25ID, Y57SD. **Y44ZD:** Y44ND, Y44JO. **Y67ZG:** Y21DG, Y25MG, Y67YG. **Y04KAY:** Y04SX, Y04DCY. **Y05KAY:** Y05BB0, Y05AFD, Y05BAT. **Y06KNY:** Y06ADW, Y06DBA. **YT3T:** YU380, YU2CBV, YU3EIJ, Bob, Rob. **YT5A:** YU5RU, YU5TU, YU5XNM, YU5XMA, YU5RA, YU5DX. **YU1EFG:** YU1HA, YU1DR, YU1PZM. **YU2CKL:** Antic, YU2JL, YU2RR, Senecic. **YU4E2C:** Mustafa, Nedim, Suad. **Y2ZCRT:** YZ20G, YZ2RD0, YU2MM, Tom. **Y24Z:** YU4WFT, YU4WIA, YU4ECI, YU4WNW, YU4WRW, Ljube, YU4WQR, YU4WIM, YU1FJK, YU4WAW, YU4WTF, YU4WTF, Mario. **4N2D:** YU2RO, YU2WM, YU2FK, YU2LHR, Darko. **4U1VIC:** K7AWD, OE1NJB, OE1ETA, NK4N, OE1JJB, OE1WOW, OE3KAB, OE1GLA, OE30LW. **5H3BH:** SM0AJU, SM0DJZ. **9H3DI:** DF8ZH, DL1RK, DL1ZQ, DF4ZL.

### Station Operators Multi-Operator, Multi-Transmitter

**AA4S & AE4Y, NE4G, WQ4V.** **DL0KF:** DF3LZ, DF6LH, DF8LZ, DJ2BV, DJ2LY, DJ3UL, DJ4FZ, DJ4S0, DJ5AZ, DJ6TK, DJ7SW, DJ8FR, DJ8HB, DL8LD, DK8LE, DK9VV, DL2ZT, DL3LAN, DL3LAR, DL5LC, DL6FY, DL9LBS. **EA9CE:** EA5BBA, EA7ALG, EA7DS, EA7TL, EA9E0, EA9EU, EA9GK, EA9GT, EA9HG, EA9JG, EA9KD. **KH6JS & AH6FU.** **JA2YEF:** JA9XDR, JE2KEA, JE2UGT, JF2ERH, JF2NFC, JF2QHC, JF2SFF, JF2VRV, JG2MPX, JG2PAJ, JI2LPD, JI2QVF, JR2PVJ, JR2TPD. **JA3YBF:** JA9TOZ, JA9UIZ.

**JA9UXW, JE6BXJ, JF3GYI, JF3KKO, JF3PGA, JG3LZG, JH9GRM, JI3KWZ, JI3XBE, JJ3PYI, JR4AGT, JR4IZK, Huryya, Doue, Yamada.** **JA3YKC:** JA2VUP, JA3ODC, JE6LPM, JE3PMM, JF3RAL, JG3HJG, JG3HLV, JG3LLB, JH4RHF, JH5EML, JH5E2P, JI3ERV, JI3XTZ, JJ3SRU, JK3GRR, JK3HYA, JR4BSM, JR4IMK, JR4PMX, JR6NWN. **JA7YAA:** JE7HLZ, JE7QCO, JG3GRM, JHTCUO, JH7HWR, JH8MRP, JJ1MVV, JJ1PEU, JR7PGL, JR7XBN. **JA7YCO:** JE7HYJ, JN1RPG, JR7M2C, H Ikeda.

**JA9YBA:** JA9BEX, JA9LJI, JA9LNI, JA9NFO, JA9OTX, JA9PPC, JA9QCE, JA9QWJ, JA9THK, JA9UAD, JA9VBW, JH7UJR, JH9OYH, JH8CAZ, JH8VUG, JI3SEB. **JG1ZUY:** JE1CKA, JF2IWL, JG1IMM, JH7PKU, JI1QQI, JI2GUT, JM1CAX, JM1RFT, J01NAH, JR4NIV. **JW5E:** JW5NM, JW6VDA, JW6WDA. **K3ZUF & KJ7K.** **K6UA & K6RF, K6VI, K6RF, KA6SAR, N6AW, N6ND, N16W, W6KUT, W6UOF, WA6EJL, KF3R & N7BJT, WB20YC, WB2YOF.** **N2AA & K2BQ, K2GL, K2NG, K2SS, K2TT, K2TW, K2UR, K3EST, K5NA, KC2X, KR2Q, KU2M, W2RO.** **NL7G & KL7PJ, KL7Y, NL7P, WL7E.** **OY6FRA:** OY2H, OY2J, OY3H, OY5NS. **W1BK & A13E, KC1Q, KV1Y, N1CW, W3LPL & A13M, KC8C, KF3P, KT3Y, N2FB, W3FG, WD4AXM.** **W9AIH/0 & W8KR, KN0V, W8UC, K0FV, WA8RPW, K89S.** **XN3BVD:** VE3BVD, VE3DUS, VE3IY, VE3KZ, VE6OU. **YR6A:** YO3APJ, YO6AKN, YO6AW, YO6AZM, YO6DIK, YO6EZ, YO6HO, YO6M2, YO6VZ, YO6ZI. **YU1EXY:** YU1EA, YU1EW, YU1FW, YU1MSK, YU1PKC, YU1PSF, YU1RL, YU1RS, YU1UU, YU3IW. **YZ2CRU:** YU2CU, YU2PA, YU2RA.

### SINGLE OP ZONE WINNERS

Zone	Call	Score	Zone	Call	Score
1	KL7RA	783,863	21	RF6FR	823,004
2	No Entrant		22	No Entrant	
3	VE7WJ	1,389,025	23	No Entrant	
4	W8YVR	1,928,259	24	VS6TA	1,809,310
5	N3RD/VP9	3,668,256	25	JA1BWA	1,099,280
6	XE2MX	1,465,671	26	No Entrant	
7	HP1XKR	640,226	27	JD1AMA	2,392
8	4V2C	3,205,896	28	YB0ARA	2,663,424
9	9Y4VT	5,595,040	29	VK8XX	3,026
10	No Entrant		30	VK2BQQ	490,175
11	PY4OD	680,400	31	KH6ND	1,851,525
12	CE2BFR	47,740	32	ZL3GQ	2,756,467
13	LU8DQ	1,027,860	33	EA9KF	5,014,224
14	CT1BCM	3,295,152	34	No Entrant	
15	OK3CGP	1,957,666	35	C53J	812,352
16	UB5EC	1,271,400	36	No Entrant	
17	UM8MBA	755,326	37	J28EG	8,398
18	UA9ND	263,648	38	ZS6BCR	1,624,576
19	UA0LCZ	469,238	39	3B8DB	155,176
20	LZ1CW	357,294	40	JW0EQ	548,270

# LOWEST PRICES!

## FAST SERVICE • HIGHEST QUALITY

**CABLE AND WIRE**

RG-213 MIL. SPEC., 97% SHIELD ..... 28.5¢/ft.  
 RG-214 MIL. SPEC., DBL. SILVER SHIELD ..... \$1.50/ft.  
 RG-217 MIL. SPEC., DBL. SHIELD ..... 80¢/ft.  
 RG-174 MIL. SPEC., 97% SHIELD ..... 10¢/ft.  
 RG-8X (MINI 8) FOAM, 95% SHIELD ..... 12.5¢/ft.  
 RG-8U FOAM, 95% SHIELD ..... 24.5¢/ft.  
 RG-58A/U MIL. SPEC., 97% SHIELD ..... 11.5¢/ft.  
 RG-11A/U MIL. SPEC., 97% SHIELD ..... 27¢/ft.  
 RG-59U MIL. SPEC., 97% SHIELD ..... 11.5¢/ft.  
 300 OHM KW TWIN LEAD ..... 16¢/ft.  
 450 OHM HD LADDER LINE, POLY INS. .... 10¢/ft.  
 450 OHM HD LADDER LINE BARE, 100 FT. ROLL \$13.00  
 4 CONDUCTOR ROTOR CABLE ..... 8¢/ft.  
 6 CONDUCTOR ROTOR CABLE ..... 14¢/ft.  
 8 CONDUCTOR ROTOR CABLE (2#18/6#22) .. 16.5¢/ft.  
 8 CONDUCTOR ROTOR CABLE HD (2#16/6#28) . 34¢/ft.  
 14 GA STRANDED COPPERWELD, 70 FT. ROLL. \$5.50  
 14 GA STRANDED COPPERWELD, 140 FT. ROLL. \$10.00  
 14 GA HD STRANDED COPPER ..... 8¢/ft.\*  
 12 GA HD SOLID COPPERWELD ..... 9¢/ft.\*  
 14 GA HD SOLID COPPERWELD ..... 7¢/ft.\*  
 18 GA HD SOLID COPPERWELD ..... 4¢/ft.\*  
 8 GA SOLID ALUMINUM GROUNDING WIRE 8¢/ft.\*  
 # SOLD IN CONTINUOUS LENGTHS TO 5000 FT. IN 50 FT. MULTIPLES ONLY

**ANTENNA GOODIES**

ALPHA DELTA PRODUCTS AT DISCOUNT PRICES  
 AMPHENOL PL-259 ..... 89¢/ea.  
 AMPHENOL UG-21D/U N TYPE ..... \$2.95  
 CERAMIC DOGBONE INSULATORS ..... 70¢/ea.  
 COAX SEAL, ROLL ..... \$1.95  
 VAN GORDEN HI-Q 1:1 BALUN ..... \$10.95  
 VAN GORDEN HI-Q CENTER INSULATOR ..... \$5.95  
 W2AU 1:1 or 4:1 BALUN ..... \$15.50  
 W2AU TRAPS 10/15/20/30/40 ..... \$33.95/pr.  
 W2AU END-sulator ..... \$1.50  
 B&W 375 or 376 COAX SWITCH ..... \$22.00  
 B&W 593/595 COAX SWITCH ..... \$24.00/\$28.00  
 DAIWA CS201/CS401 SWITCH ..... \$20.00/\$62.95

**ANTENNAS • ROTORS • TOWERS**

ALLIANCE U110/HD73 Rotors ..... \$45.95/\$98.00  
 AVANTI HM 151.3G ON GLASS 2M ANT ..... \$29.50  
 AVANTI HMR450.5G ON GLASS ..... \$32.00  
 BUTTERNUT HF2V 40 & 80 Mtr Vertical ..... \$108.95  
 BUTTERNUT HF6V 6 BAND Vertical ..... \$112.95  
 TBR160S/RMK-III/STRII ..... \$47.50/\$41.95/\$29.95  
 BUTTERNUT 2MCV/2MCV-5 ..... \$36.75/\$42.75  
 BUTTERNUT HF3B Compact Tri-Band Beam \$165.95  
**BONUS-FREE SHIPPING ON BUTTERNUT HF ANTENNAS AND BUTTERNUT ACCESSORIES PURCHASED WITH AN HF ANTENNA (Cont. USA Only)**  
 B & WAC 3.5-30 ALL BAND FOLDED DIPOLE, \$129.50  
 CUSHCRAFT A3/A4 ..... \$203.95/\$263.95  
 CUSHCRAFT R3 VERTICAL ..... \$254.95  
 OTHER CUSHCRAFT ..... IN STOCK  
 HY-GAIN CD-4511 ROTOR ..... \$154.95  
 HY-GAIN HAM IV/T2X ROTORS ..... \$246.95/\$295.95  
 HY-GAIN TH5MK2S/TH7DXS ..... \$429.95/\$497.95  
 HY-GAIN EX-14/QK710 ..... \$339.95/\$84.95  
 LARSEN LM-150-MM 2mtr MAG MT ANT ..... \$37.95  
 MINI PRODUCTS HQ-1 MINI QUAD ..... \$138.95  
 MOSLEY TA-33JR/TA33 ..... \$173.95/\$235.95  
 MOSLEY CL-33/CL-36 ..... \$260.95/\$350.95  
 MOSLEY PRO-37 ..... \$460.95  
 VAN GORDEN G5RV MULTI-BANDER ..... \$42.95  
 VAN GORDEN ALL BANDER ..... \$24.95  
 VAN GORDEN SD-40 DIPOLE KIT ..... \$22.10  
 VAN GORDEN SD-80 DIPOLE KIT ..... \$26.00  
 VAN GORDEN PD 40-20 DIPOLE KIT ..... \$27.30  
 VAN GORDEN PD 80-10 DIPOLE KIT ..... \$32.00  
 VAN GORDEN PD 80-40 DIPOLE KIT ..... \$29.95  
**UNIVERSAL ALUMINUM TOWERS DISCOUNT PRICES**  
**HY-GAIN TOWERS SHIPPED FREE!**  
 HG-37SS/HG52SS ..... \$785.00/\$1145.00  
 HG-54-HD/HG70HD ..... \$1765.00/\$2825.00  
**NOW STOCKING PHILLYSTRAN GUY CABLE!**  
 HPTG 2100 (2100# RATING) ..... 27¢/ft.  
 HPTG 4000 (4000# RATING) ..... 47¢/ft.  
 9901 CABLE END ..... \$7.50/ea.  
 SOCKETFAST POTTING COMPOUND ..... \$14.50

**ASTRON POWER SUPPLIES**

RS7A/RS12A ..... \$48.55/\$68.30  
 RS20A/RS20M ..... \$87.00/\$103.00  
 RS35A/RS35M ..... \$131.00/\$148.75  
 RS50A/RS50M ..... \$189.00/\$209.00

**TEN-TEC**

CORSAIR II ..... \$1144.95  
 525D ARGOSYII ..... \$515.00  
 CENTURY 22 ..... \$345.95  
 2510 MODEL B ..... \$410.00  
 229 1KW ANTENNA TUNER ..... \$248.00  
 4229 1KW ANTENNA TUNER KIT ..... \$178.00

**MFJ**

941D/949C ANTENNA TUNERS ..... \$87.50/\$127.50  
 401/407 KEYERS ..... \$43.95/\$59.95  
 MANY OTHER MFJ PRODUCTS IN STOCK

**NYE VIKING**

MB5A TUNER ..... \$485.95  
 MB4-2A TUNER ..... \$409.95  
 2KW LOW PASS FILTER ..... \$26.95

**AMERITRON**

AL-80A LINEAR ..... \$655.95  
 AL-84 LINEAR ..... \$335.00  
 AL-1200 LINEAR ..... \$1303.95  
 ATR-15 1500W TUNER ..... \$248.95  
 ATR-10 1000W TUNER ..... \$238.95  
 AL-80A/ATR-15 PACKAGE ..... \$885.95  
 AL84/ATR10 PACKAGE ..... \$545.95  
 RSC-8 REMOTE COAX SWITCH ..... \$110.95

**AMP SUPPLY CO.**

LA1000A/LA1000NT ..... \$385.95/\$465.95  
 LK500ZA/LK500ZB ..... \$935.95/\$1130.95

**DAIWA CN520/620/630N** ..... \$57.97/\$105.95/\$138.95  
**ALPHA DELTA MACC 4pos/8pos** ..... \$53.95/\$71.50  
**BENCHER PADDLES BLACK/CHROME** ..... \$37.50/\$47.50  
**SHURE 444D Dual IMP DESK MIC** ..... \$51.95  
**HEIL SOUND PRODUCTS** ..... IN STOCK  
**PALOMAR ENGINEERS PRODUCTS** ..... IN STOCK

**NEW PRODUCT - Our own 2 element 160.75/80, 40 Meter Sloper Antenna... only \$34.95 ppd.**

**LA CUE inc.**  
 132 Village Street  
 Johnstown, PA 15902

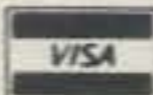

SHIPPING CHARGES  
 ADDITIONAL EXCEPT AS  
 NOTED. PRICES SUBJECT  
 TO CHANGE WITHOUT  
 NOTICE OR OBLIGATION



Hours Monday - Friday, 8:30 - 6:00, Saturday 8:30 - 4:00 • Please send stamp for flyer • We Export!

CALL TOLL FREE - ORDERS ONLY PLEASE!

**800-637-3300**

INFORMATION AND PA ORDERS CALL!

**814-536-5500**







# Radio Shack Parts Place™

Over 1000 Items in Stock at Everyday Low Prices

## Radio Shack's New Special-Order Service

We Can Replace Almost Any Industrial or Entertainment IC or Semiconductor—Fast!

Over 200,000 Substitutions

- NO MINIMUM ORDER
- NO POSTAGE CHARGE
- CONVENIENT "HOMETOWN" SHOPPING



If the IC or semiconductor you need is not part of our regular stock, our store manager will check our new in-store substitution guide and special-order a replacement from our warehouse. Your order will be sent ASAP to your Radio Shack store and we'll notify you when it arrives. Radio Shack also offers special-order service on selected tubes and crystals. Visit the store nearest you for details!

### "Jumbo" Plug-In PC Boards

- (1) Two-Bus PC Board. 4 1/2 x 9 9/16". Accepts up to 24 16-pin DIP devices. Fits 44-position socket. #276-190 ..... 5.95
- (2) IC/Discrete Board. Like above, but will accept up to 40 16-pin DIPs. Single supply bus. #276-191, 5.95
- (3) Socket for Above. #276-1551 ..... 2.99

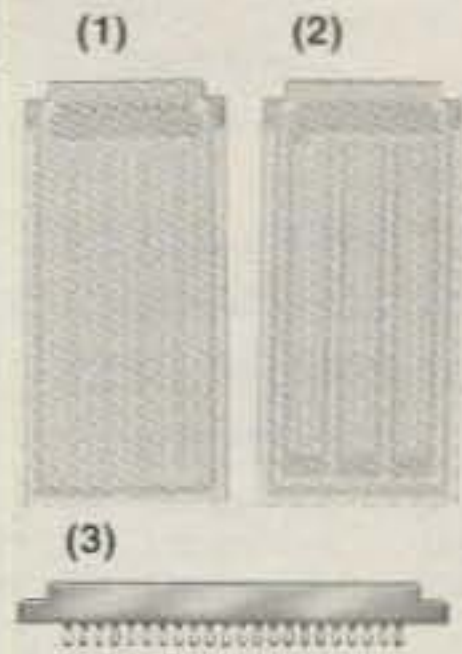

### 4000-Series CMOS ICs

Full-Spec Devices With Pin-Out and Specs



Type	Description	Cat. No.	Each
4001	Quad 2-Input NOR Gate	276-2401	.99
4011	Quad 2-Input NAND Gate	276-2411	.99
4013	Dual Type-D Flip Flop	276-2413	1.19
4017	Decade Counter/Divider	276-2417	1.49
4049	Inverting Hex Buffer	276-2449	1.19
4066	Quad Bilateral Switch	276-2466	1.19

### UHF Connectors and Adapters

Fig	Type	Adapts	To Fit	Cat. No.	Each
4	UG-255/U	Female BNC	PL-259	278-120	2.39
5	UG-273/U	Male BNC	SO-239	278-121	2.39
6	M-358 "T"	SO-239	(2) PL-259	278-198	2.49
7	—	SO-239	SO-239	278-192	1.79
8	PL-258	PL-259	PL-259	278-1369	1.49



- (9) Type M-359 UHF Right-Angle Adapter. #278-199 ..... 1.99
- (10) Solderless PL-259. For RG58/59 cables. #278-190 ..... 1.69
- (11) 1094 Female BNC. #278-105 ..... 1.69
- (12) UG-88 Male BNC. For RG58. Solderless. #278-103 ..... 2.39
- UG-88 Male BNC. As above, but for RG59/62. #278-104 ..... 2.39
- (13) Inline Female BNC. For RG58 cable. #278-113 ..... 2.49
- Inline Female BNC. For RG59/RG62 cables. #278-114 ..... 2.49

### Linear ICs

Low As **79¢**

Include Pin-Out and Data



- Type 741 Op Amp. Ideal for building your own CW/SSB active audio filter. 8-pin DIP. #276-007 ..... 79¢
- LM567 Tone Detector. For auto-patch tone and RTTY decoding. 8-pin DIP. #276-1721 ..... 1.99
- LM386 Audio Amplifier. Perfect audio output stage for homebrew receivers. 8-pin. #276-1731 ..... 1.09
- TLC555 CMOS Timer. Same pinout as standard 555 timer but very low power drain, typically one milliwatt at 5 VDC. 8-pin DIP. #276-1718 ..... 1.39

### Voice Synthesizer ICs

Now You Can Add Speech Output to Any Personal Computer or ASCII Terminal



- SPO256-AL2. Preprogrammed with 59 speech sounds and five pauses. Complete data and application notes included. 28-pin DIP. #276-1784, 12.95
- CTS256-AL2. Converts ASCII characters into control data for IC above. 40-pin DIP with data. #276-1786 ..... 16.95

### Jumbo 12/24-Hour LED Clock



**2795**

1.8"-Tall LED Digits

Provides selectable 12 or 24-hour display and 24-hour alarm. Hi/lo brightness selection. Easy to set time and alarm. Battery backup in case of AC failure. Handsome appearance, too. UL listed. 9V backup battery extra. #63-675

### Low-Cost TVI "Fixers"



- 300-ohm High-Pass Filter. Installs in-line at TV or FM receiver's 300-ohm terminals. #15-581 ..... 5.95
- 75-ohm High-Pass Filter. LC design. Installs in-line at TV, VCR or FM set's coax input. #15-579 ..... 3.95

### Micronta® Testers: Built-to-Last Quality!



Our Finest Analog VOM **4995**

21-Range Analog VOM. Big color-coded scale, rugged construction. "Beep" continuity function, polarity reverse switch. Measures to 1000 volts DC, 1000 volts AC, DC current to 10 amps and resistance in 4 ranges. 6 1/16 x 5 7/16 x 2 5/8". Batteries extra. #22-210

Fold-Up Autoranging LCD VOM. You select the function, it selects the range. Diode check mode, autorange override. Measures to 1000 volts DC, 500 volts AC, AC or DC current to 10 amps and resistance to 2 megs. 10 7/8 x 5 5/8 x 1 1/2". Batteries extra. #22-193



Our Best Digital VOM **7995**

Both models are fused and overload protected. Include probes and detailed owner's manuals.

### More Bargains for Hams!

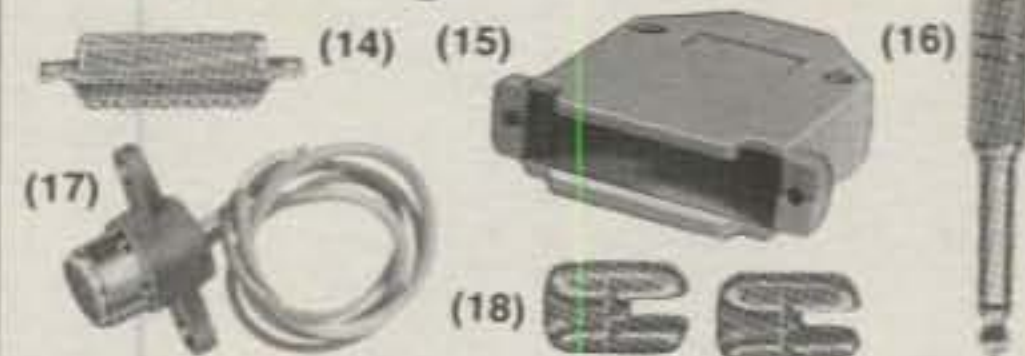

- (14) 25-Position Male D-Submini Connector. Solder type for RS-232 hookups. #276-1547 ..... 2.99
- (15) Hood for Above. #276-1549 ..... 1.99
- (16) Headphone Adapter. 1/4" mono plug to stereo 1/8" jack. Use comfortable new mini stereo phones with Ham and SWL receivers, scanners. #274-348 ..... 1.49
- (17) Electret Mike Element. Crisp, clean output. Ideal for mike repair, upgrades. #270-092 ..... 2.69
- (18) Antenna Insulators. "Egg" safety design. strong, low-loss material. #270-1518 ..... Pkg. of 2/69¢

A DIVISION OF TANDY CORPORATION

# Radio Shack®

OVER 9100 LOCATIONS WORLDWIDE

Prices apply at participating Radio Shack stores and dealers

CIRCLE 87 ON READER SERVICE CARD





<b>UP2BN</b> 14 84,735 451 27 78 <b>UP2BFL</b> 80,988 510 27 75 <b>UP3BG</b> 62,000 376 28 72 <b>UP2BC</b> 26,860 204 20 65 <b>UP2BDX</b> 260 15 5 8 <b>UP2BKA</b> 7 70,830 545 27 73 <b>UP2BLE</b> 30,303 223 22 69 <b>UP2BON</b> 10,944 135 20 37 <b>UP2ND</b> 10,800 172 11 37 <b>UP2BLF</b> 6,888 146 9 29 <b>UP2BIM</b> 3.5 84,788 1005 14 62 <b>UP2PCI</b> 71,064 840 14 58 <b>UP2BEI</b> 66,284 624 17 56 <b>UP2BIW</b> 47,322 610 13 53 <b>UP2BFI</b> 45,792 533 14 58 <b>UP2BDF</b> 44,268 545 13 55 <b>UP2BOS</b> 20,398 362 8 39 <b>UP2BGR</b> 12,144 240 9 35 <b>UP2BHO</b> 11,481 225 8 35 <b>UP2BOE</b> 6,560 130 7 34 <b>UP2BZ</b> 6,474 135 8 31	<b>UB5AEZ</b> 490 49 5 14 <b>UB5ZAL</b> 1.8 30,030 390 13 53 <b>RT5UY</b> 19,703 283 10 51 <b>UB5WF</b> 19,278 331 9 45 <b>UB5PJ</b> 16,576 246 9 47 <b>UB5LCV</b> 11,086 208 7 39 <b>RB5DC</b> 10,578 242 7 36 <b>UB5MNR</b> 10,086 246 8 33 <b>UB5WCO</b> 9,768 246 8 29 <b>UT5UBW</b> 8,619 134 9 42 <b>RB5AD</b> 8,208 213 7 31 <b>UB5IUA</b> 7,558 163 8 31	<b>UB5AEZ</b> 490 49 5 14 <b>UB5ZAL</b> 1.8 30,030 390 13 53 <b>RT5UY</b> 19,703 283 10 51 <b>UB5WF</b> 19,278 331 9 45 <b>UB5PJ</b> 16,576 246 9 47 <b>UB5LCV</b> 11,086 208 7 39 <b>RB5DC</b> 10,578 242 7 36 <b>UB5MNR</b> 10,086 246 8 33 <b>UB5WCO</b> 9,768 246 8 29 <b>UT5UBW</b> 8,619 134 9 42 <b>RB5AD</b> 8,208 213 7 31 <b>UB5IUA</b> 7,558 163 8 31	<b>COLOMBIA</b> <b>HK1AMW</b> A 731,855 1272 74 123	<b>EASTER ISLAND</b> <b>CEBAE</b> 28 1,680 34 10 10	<b>NETHERLANDS ANTILLES</b> <b>PABJLS/PJ2</b> A 93,043 387 35 48 <b>NE8Z/PJ3</b> 7 7,695 171 7 8	<b>PARAGUAY</b> <b>ZP5XOW</b> A 296,922 984 46 56 <b>ZP5XGG</b> 62,307 319 33 36	<b>TRINIDAD</b> <b>9Y4VT</b> A 5,595,040 4290 124 316 (Opr. N6AA) <b>9Y4W</b> 21 701,181 2052 30 87 (Opr. WA3LRO) <b>9Y4VU</b> 7 546,735 1255 24 81	<b>URUGUAY</b> <b>CX2AD</b> A 92,400 297 50 60 <b>CX8DT</b> 1.8 1,332 30 8 10	<b>VENEZUELA</b> <b>AM7QP</b> 28 14,980 192 12 16 <b>YY5A</b> 21 105,021 569 19 44 <b>YV4ABR</b> 58,092 435 15 32 <b>YV1TO</b> 14 418,698 1270 32 94 <b>YV3ALK</b> 241,844 992 29 74 <b>YX5A</b> 7 696,150 2003 29 88 <b>YV3AGT</b> 1.8 47,679 280 15 43 <b>YV10B</b> 45,584 350 11 33	<b>MULT-OPERATOR SINGLE TRANSMITTER NORTH AMERICA UNITED STATES</b> <b>K1ZZ</b> 2,773,744 1795 130 366 <b>K1RX</b> 2,492,475 1760 137 364 <b>KM1C</b> 1,508,910 1212 116 322 <b>KIXM</b> 1,194,032 1087 110 282 <b>AK1L</b> 256,815 468 60 135 <b>KR1R</b> 91,120 249 45 91 <b>N2RM</b> 2,052,705 1483 124 363 <b>W2GD</b> 1,083,600 914 122 298 <b>KQ2O</b> 691,716 696 101 253 <b>W2OW</b> 389,512 521 85 184 <b>KU2C</b> 344,411 459 90 193 <b>W2UI</b> 315,732 446 76 177 <b>W2XL</b> 157,992 264 79 148 <b>K2TD</b> 49,833 139 52 95 <b>W3BGN</b> 2,349,839 1594 143 380 <b>K3NA</b> 675,894 695 112 269 <b>KB3MM</b> 494,405 536 92 213 <b>W3NZ</b> 414,986 537 83 203 <b>KH3CP/W3</b> 366,606 504 88 191 <b>W3MA</b> 290,520 391 85 184 <b>K3UEI</b> 160,975 257 80 155 <b>K3II</b> 106,745 202 56 129 <b>W3YFV</b> 17,328 88 31 45 <b>N4AR</b> 2,445,534 1591 150 396 <b>K3KG/4</b> 1,968,894 1359 143 370 <b>N4KG</b> 853,312 782 119 279 <b>WA4JXI</b> 561,558 632 109 237 <b>WA4QOV</b> 344,799 475 89 184 <b>W400</b> 205,084 320 92 144 <b>WB40SN</b> 139,968 222 85 147 <b>KA4EQW</b> 79,655 164 64 115 <b>K4KUZ</b> 58,617 133 69 98 <b>K5RC</b> 3,221,384 1998 160 402 <b>K5LZO</b> 2,036,208 1579 136 336 <b>K5RX</b> 1,427,242 1159 134 303 <b>K5SDX</b> 388,969 484 101 206 <b>K5RR</b> 304,720 643 72 136 <b>N6VR</b> 901,888 1183 103 168 <b>K6ZM</b> 795,906 922 107 199 <b>W6BIP</b> 447,066 545 111 195 <b>WB6ZHT</b> 387,468 620 94 135 <b>N6IC</b> 216,540 373 83 131 <b>K6TQ</b> 200,900 365 78 118 <b>AG7M</b> 553,194 893 83 136 <b>W6BJH</b> 199,800 387 73 107 <b>W8UA</b> 2,147,508 1514 137 356 <b>W8GWC</b> 1,087,403 903 127 312 <b>K8UNP</b> 176,784 271 93 161 <b>N9WA</b> 170,562 291 72 145 <b>KA9P</b> 57,900 146 55 95 <b>N0BE</b> 972,356 1132 111 197 <b>K8RWL</b> 529,920 574 114 231 <b>W8NA</b> 235,235 367 79 156	<b>ASIA</b> <b>JAPAN</b> <b>JA2YKA</b> 2,671,650 2126 144 306 <b>JA7YFB</b> 1,020,500 1158 118 207 <b>JA1YNE</b> 661,290 872 101 181 <b>JA7YAB</b> 635,040 1056 87 129 <b>JA1YXP</b> 557,700 836 100 145 <b>JA8YAD</b> 544,178 866 94 147 <b>JA1ZKL</b> 525,139 816 100 141 <b>JA7YFH</b> 396,594 733 77 121 <b>JH1YDT</b> 353,192 610 80 132 <b>JA8YBY</b> 314,028 618 88 110 <b>JA5YAV</b> 290,476 517 77 125 <b>JA1YAD</b> 187,642 401 74 108 <b>JA7YRR</b> 94,380 374 47 74	<b>TANZANIA</b> <b>5H3BH</b> 4,036,290 3286 117 298	<b>ENGLAND</b> <b>G4DTU</b> 309,980 980 58 162	<b>FINLAND</b> <b>OH2VY</b> 1,841,644 2192 122 354 <b>OH5NQ</b> 1,692,603 2074 117 334 <b>OH7AB</b> 1,068,418 1817 95 282 <b>OH2BR</b> 813,056 1116 97 300 <b>OH1AA</b> 671,490 1441 68 202 <b>OH2AI</b> 514,304 1010 81 247 <b>OH2AQ</b> 331,788 894 61 197 <b>OH9AR</b> 240,408 882 46 122	<b>FRANCE</b> <b>F3TV</b> 3,579,950 3130 126 380 <b>F6IWW</b> 723,520 1486 77 195 <b>F9FYA</b> 304,874 1088 57 85 <b>F6IGF</b> 249,291 778 57 85 <b>F6ENV</b> 40,716 256 34 74	<b>GERMANY (FRG)</b> <b>DL1MAJ</b> 795,982 1142 90 283 <b>DL8IU</b> 667,314 1159 78 205 <b>DF8AFZ</b> 652,194 1195 91 251 <b>DF8BV</b> 514,843 925 85 258 <b>DL3HAH</b> 447,950 1036 71 218 <b>DL8WN</b> 400,896 744 73 215 <b>DL8LR</b> 324,018 614 68 214 <b>DL8ER</b> 185,200 495 57 143	<b>GERMANY (GDR)</b> <b>Y35L</b> 1,173,930 2188 89 270 <b>Y43ZD</b> 265,267 1095 54 145 <b>Y67ZG</b> 180,744 642 52 152 <b>Y44ZG</b> 101,579 405 49 108 <b>Y31ZL</b> 28,213 284 23 66	<b>GUERNSEY</b> <b>GU3HFN</b> 69,564 617 20 82	<b>HUNGARY</b> <b>H65A</b> 2,959,700 3227 111 314 <b>H67B</b> 2,583,999 2941 119 354 <b>H66N</b> 2,518,845 2778 117 330 <b>H69R</b> 2,290,869 2631 127 356 <b>H61S</b> 966,960 1713 90 226 <b>H66V</b> 937,380 1704 97 243 <b>HA3KNA</b> 687,834 1388 88 230 <b>HA8KCK</b> 591,282 1204 82 225 <b>HA1KRR</b> 580,203 1273 68 193 <b>HA8KVK</b> 536,540 1104 79 199 <b>HA2KMR</b> 475,046 1042 78 208 <b>HA6KNX</b> 356,570 986 75 192 <b>HA8KWG</b> 176,152 523 55 139 <b>HA7KMP</b> 97,012 406 44 114 <b>HA5KDY</b> 2,412 48 14 22	<b>JERSEY</b> <b>GJ8AAA</b> 2,111,472 3061 85 311	<b>LUXEMBOURG</b> <b>LX9BV</b> 79,800 417 41 99	<b>MALTA</b> <b>9H3DI</b> 886,039 2160 74 237	<b>NETHERLANDS</b> <b>PA3CEF</b> 744,534 1864 66 266 <b>PA3ADJ</b> 262,926 1247 33 129 <b>PI4DEC</b> 193,466 729 44 138	<b>POLAND</b> <b>SP2ZFJ</b> 712,974 1323 86 245 <b>SP6PAZ</b> 264,228 590 64 163 <b>SP9ZHR/9</b> 98,936 395 46 120 <b>SP5KVV</b> 64,668 800 12 56 <b>SP9KA0</b> 42,959 305 31 88	<b>ROMANIA</b> <b>Y03KWJ</b> 734,184 1470 96 228 <b>Y05KAU</b> 364,560 1082 64 176 <b>Y04KAY</b> 237,200 534 50 150 <b>Y06KNY</b> 4,970 145 9 26	<b>SPAIN</b> <b>EA3VY</b> 4,053,000 3802 119 381 <b>ED7BB</b> 2,737,755 3209 104 311	<b>SWEDEN</b> <b>SK6RR</b> 814,113 1491 78 211 <b>SK5EU</b> 760,362 1474 90 269 <b>SK6JA</b> 697,022 1396 74 224 <b>SK2AU</b> 685,720 1480 64 184 <b>SK5AA</b> 458,436 1100 68 185 <b>SK7PI</b> 95,680 320 49 111	<b>SWITZERLAND</b> <b>HB9BX0</b> 538,350 1531 66 156 <b>HB9AJ</b> 230,051 944 45 136	<b>UNITED NATIONS (VIENNA)</b> <b>4U1VIC</b> 432,400 1082 66 164
--	---	---	--	--	--	--	--	---	--	---	---	--	---	--	---	---	--	---	--	--	--	--	--	---	--	--	---	--	---

# NEW FROM MFJ

**MFJ'S MOST ADVANCED RTTY/ASCII/AMTOR/CW COMPUTER INTERFACE HAS FM, AM MODES, LED TUNING ARRAY, RS-232 INTERFACE, VARIABLE SHIFT TUNING, 170/850 Hz TRANSMIT, MARK-SPACE DETECTION.**



**MFJ RTTY/ASCII/CW software on tape, cables for C-64/VIC-20.**

**MFJ-1229**  
**\$179.95**

Engineering, performance, value and features sets MFJ's most advanced RTTY/ASCII/

AMTOR/CW computer interface apart from others. **FM (limiting) mode** gives easy, trouble-free operation. Best for general use, off-shift copy, drifting signals, and moderate signal and QRM levels. **AM (non-limiting) mode** gives superior performance under weak signal conditions or when there are strong nearby stations.

**Crosshair mark-space LED tuning array** simulates scope ellipse for easy, accurate tuning even under poor signal-to-noise conditions. Mark and space outputs for true scope tuning.

Transmits on both 170 Hz and 850 Hz shift.

**Built-in RS-232 interface**, no extra cost.

**Variable shift tuning** lets you copy any shift between 100 and 1000 Hz and any speed (5-100 WPM RTTY/CW and up to 300 baud ASCII). Push button for 170 Hz shift.

**Sharp multi-pole mark and space filters** give true mark-space detection. Ganged pots give space passband tuning with constant bandwidth. Factory adjusted trim pots for optimum filter performance.

**Multi-pole active filters** are used for pre-limiter, mark, space and post detection filtering. Has automatic threshold correction. This advanced design gives good copy under QRM, weak signals and selective fading.

Has front panel sensitivity control.

**Normal/Reverse switch** eliminates retuning while checking for inverted RTTY. Speaker jack. +250 VDC loop output.

**Exar 2206 sine wave generator** gives phase continuous AFSK tones. Standard 2125 Hz mark and 2295/2975 Hz space. Microphone lines: AFSK out, AFSK ground, PTT out and PTT ground.

**FSK keying for transceivers** with FSK input. **Has sharp 800 Hz CW filter**, plus and minus CW keying and external CW key jack.

**Kantronics software compatible socket.**

**Exclusive TTL/RS-232 general purpose socket** allows interfacing to nearly any personal computer with most appropriate software. Available TTL/RS-232 lines: RTTY demod out, CW demod out (TTL only), CW-ID in, RTTY in, PTT in, key in. All signal lines are buffered and can be inverted using an internal DIP switch.

**Metal cabinet.** Brushed aluminum front. 12 1/2 x 2 1/2 x 6 inches. 18 VDC or 110 VAC with optional AC adapter, MFJ-1312, \$9.95.

**Plugs between rig and C-64, VIC-20, Apple, TRS-80C, Atari, TI-99 and other personal computers.** Use MFJ, Kantronics, AEA and other RTTY/ASCII/AMTOR/CW software.

## MFJ MULTI-FUNCTION TUNING INDICATOR MFJ-1221 \$79.95



**Greatly improve your RTTY copying capabilities.** Add a crosshair LED Tuning Indicator that makes tuning quick, easy with pin-point accuracy. Add mark and space outputs for scope tuning. Add LEDs that indicate 170, 425, 850 Hz shifts. Great for copying RTTY outside ham bands. Add sharp mark and space filters to improve copy under crowded/weak conditions. 170, 425, 850 Hz shifts.

Add Normal/Reverse switch to check for inverted RTTY without retuning. Add output level control to adjust signal into your terminal unit. Add a limiter to even out signal variation for smoother copy.

Unit plugs between your tuner and receiver. Mark is 2125 Hz, space is 2295, 2550 or 2975 Hz. Measures 10x2x6 in. and uses floating 18 VDC or 110 VAC with AC adapter, MFJ-1312, \$9.95.

## 24/12 HOUR CLOCK/ID TIMER MFJ-106 \$19.95

Switch to 24 hour UTC or 12 hour format! Battery backup. ID timer alerts every 9 minutes after reset. Red .6 in. LEDs. Synchronizable to WWW. Alarm, Snooze function. PM, alarm on indicators. Gray/Black cabinet. 110 VAC, 60 Hz.



## MFJ 24 HOUR LCD CLOCKS

**\$19.95**

**\$9.95**



MFJ-108



MFJ-107

**ORDER ANY PRODUCT FROM MFJ AND TRY IT-NO OBLIGATION. IF NOT DELIGHTED, RETURN WITHIN 30 DAYS FOR PROMPT REFUND (LESS SHIPPING).**

- One year unconditional guarantee • Made in USA.
- Add \$4.00 each shipping/handling • Call or write for free catalog, over 100 products.

## MFJ ELECTRONIC KEYS MFJ-407 \$69.95



**MFJ-407 Deluxe Electronic Keyer** sends iambic, automatic, semi-auto or manual. Use squeeze, single lever or straight key. Plus/minus keying. 8 to 50 WPM. Speed, weight, tone, volume controls. On/Off, Tune, Semi-auto switches. Speaker. RF proof. 7x2x6 inches. Uses 9 V battery, 6-9 VDC or 110 VAC with AC adapter, MFJ-1305, \$9.95.

## MICROPHONE EQUALIZER MFJ-550 \$49.95



**Greatly improves transmitted SSB speech** for maximum talk power. Evens out speech peaks and valleys due to voice, microphone and room characteristics that make speech hard to understand. Produces cleaner, more intelligible speech on receiving end. Improves mobile operation by reducing bassy peaks due to acoustic resonances. Plugs between mic and rig. 4 pin mic jack, shielded output cable. High, mid, low controls provide ±12 db boost or cut at 490, 1170, 2800 Hz. Mic gain, on/off/bypass switch. "On" LED. 7x2x6 inches. 9 V battery, 12 VDC or 110 VAC with adapter, MFJ-1312, \$9.95.

## MFJ ANTENNA BRIDGE MFJ-204 \$79.95

Trim your antenna for optimum performance quickly and easily. Read antenna resistance up to 500 ohms. Covers all ham bands below 30 MHz. Measure resonant frequency of antenna. Easy to use, connect antenna, set frequency, adjust bridge for meter null and read antenna resistance. Has frequency counter jack. Use as signal generator. Portable, self-contained. 4x2x2 in. 9 V battery or 110 VAC with adapter, MFJ-1312, \$9.95.



## MFJ PORTABLE ANTENNA MFJ-1621 \$79.95

**MFJ's Portable Antenna** lets you operate 40, 30, 20, 15, 10 meters from apartments, motels, camp sites, vacation spots, nearly any electrically clear location where space for a full size antenna is a problem.

A telescoping whip (extends to 54 in.) is mounted on self-standing 5 1/2 x 6 1/4 x 2 1/4 inch Phenolic case. Built-in antenna tuner, field strength meter, 50 feet RG-58 coax. Complete multi-band portable antenna system that you can use nearly anywhere. Up to 300 watts PEP.

MFJ-1621  
**\$79.95**



**Huge 5/8 inch bold black LCD numerals** make these two 24 Hour clocks a must for your shack. Choose from a dual clock that features separate UTC and local time display or a single clock that displays 24 Hour time. **Mounted in a brushed aluminum frame**, these clocks feature huge 5/8 inch LCD numerals and a sloped face for across the room viewing. Easy set month, day, hour, minute and second function. Clocks can be operated in an alternating time-date display mode. MFJ-108, 4 1/2 x 1 x 2 inches; MFJ-107, 2 1/2 x 1 x 2 inches. Battery included.

# MFJ

**MFJ ENTERPRISES, INC.**  
Box 494, Mississippi State, MS 39762

CIRCLE 59 ON READER SERVICE CARD

TO ORDER OR FOR YOUR NEAREST DEALER, CALL TOLL-FREE  
**800-647-1800.** Call 601-323-5869 in Miss. and outside continental USA  
Telex 53-4590 MFJ STKV









antennas & towers **612-255-0855**

We Ship Worldwide

**rf enterprises**

Route No. 7  
St. Cloud, Minnesota 56301

MASTERCARD/VISA

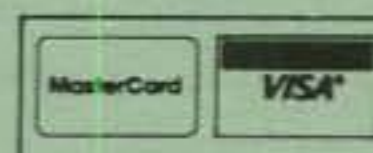

Prices subject to change without notice.  
Minnesota residents add 6 percent tax.

**ANTENNAS**

**KLM**

KT34A	\$335.00
KT34XA	479.00
40M-2	300.00
40M-3	449.00
40M-4	649.00
2M-11X	55.00
2M-13LBA	75.00
2M-16 LBX	89.95
220-14X	79.95
220-22 LBX	89.95
432-20 LBX	67.95
432-30 LBX	95.00
2M-22C	109.00
435-40CX	145.00

**CUSHCRAFT**

A3	\$205.00
A4	264.95
R3	256.95
DW3	110.00
AV3	49.95
AV4	87.95
AV5	95.00
40-2CD	274.95
A50-5	74.95
617-6B	189.95
A147-11	49.95
A147-22	119.95
A147-20T	63.95
215WB	74.95
32-19	88.00
42-18	94.00
220B	88.00
424B	74.95
416TB	54.95
A144-20T	64.95
AOP-1	139.95

**HY-GAIN**

TH7DX	
TH5Mk2S	
Explorer-14	
30/40 add-on	
204BAS	
205BAS	
155BAS	
Disc. 7-1	
Disc. 7-2	
Dir. Kit 7-3	
18HTS	
18AVT/WBS	
14AVQ/WBS	
V2S	
V3S	
V4S	
214BS	
BN-86 balun	
5BDQ	
2BDQ	

2-mtr. mobile ants. in stock

**BUTTERNUT**

HF6V	\$109.00
HF2V	105.00
TLK load kit	13.95
TBR-160 coils	46.95
STR-II	29.95
2MCV	36.95
2MCV-5	42.95
RMK-II	39.95

**MOSLEY**

TA-33Jr	\$179.00
TA-33	235.00
TA-40KR kit	89.95
CL-33	265.00

C  
A  
L  
L  
  
F  
O  
R  
  
P  
R  
I  
C  
I  
N  
G

**TOWERS**

**UNR-Rohn**

**FREE-STANDING:**

Today's best buy in towers. rated at 10 & 18 sq. ft.

HBX-40	\$198.00
HBX-48	265.00
HBX-56	335.00
HDBX-40	249.00
HDBX-48	325.00

**FOLDOVERS:**

FK2548	\$849.00
FK2558	910.00
FK2568	959.00
FK4544	1169.00
FK4554	1259.00
FK4564	1349.00

Fold-overs shipped freight prepaid.  
Prices 10 percent higher in western states

**GUYED TOWERS:**

25G section	\$47.50
25AG3 top	59.90
25AG4 top	64.00
45G section	109.00
45AG3 top	116.00
45AG4 top	116.00
TB-3 Bearing	49.00

**Hy-Gain**

**CRANK-UPS:**

Hy-Gain is now the name in crank-up towers. Shipped freight prepaid!

HG-37SS	
HG-52SS	
HG-54HD	
HG70HD	

CALL

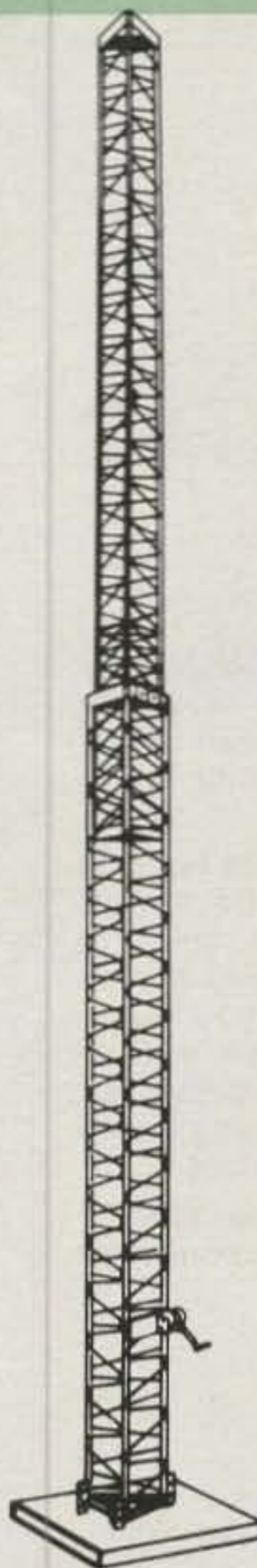

LET US BID A FREIGHT PREPAID HY-GAIN TOWER-ANTENNA PACKAGE FOR YOU.

**WIRE & CABLE**

**COAX:**

RG-213/U	\$0.29/ft.
RG-8/U	0.28/ft.
RG-8/U foam	0.27/ft.
RG-8X	0.16/ft.

**ANTENNA WIRE(solid):**

12 ga. Copperweld	\$.012/ft
14 ga. Copperweld	0.10/ft
450 ohm ladder line	0.10/ft

**ROTOR CABLE:**

Std (6-22, 2-18)	\$.019/ft
Hvy (6-18, 2-16)	0.34/ft

**BELDEN**

RG-213/U	\$0.40/ft
RG-8/U	0.32/ft
RG-8/U foam	0.35/ft
RG-8X	0.18/ft
RG-11A/U	0.36/ft
9913	0.42/ft

**MISCELLANEOUS ANTENNA SUPPLIES**

**ALPHA-DELTA**

Transi-traps:	
LT 200W	\$18.95
HT 2KW	29.00
RT 200W Dlx	28.95
HV 2KW Dlx	31.95

AMERITRON RCS-8 remote coax switch, 5 pos . . . . . \$119.95

**ROTORS**

**TELEX-HY-GAIN**

CD54II	
HAM IV	CALL
T2X	
HDR-300	

**KENPRO**

KR-500 elev	\$159.00
KR-5400 az-el	259.00
KR-5600 az-el	319.00

**THIS MONTH'S SPECIALS:**

Santec ST-142...\$219.95. Volume discounts on wire and cable.

Now Stocking:

Dynetic Systems DR-10 Az-El Rotor. Alpha-Delta DX-A Sloper.

# OWN THE WORLD WITH THE R3

## NO RADIAL VERTICAL 10, 15, 20 METERS

The R3 half wavelength design eliminates the ground radial system required by other verticals. Optimum current distribution gives more efficiency and low angle radiation for DX communications.

R3 brings high performance antenna features to those living in apartments, condominiums or on small city lots. Even if you have plenty of space, R3's combination of neat appearance and DX capability make it ideal for your station. The R3 includes an integral tuner to give a perfect match across 10, 15, and 20 meters. The remote tuning feature allows easy fingertip control as you operate your station.

R3 is a complete antenna system ready to install in virtually any location from ground level to roof top.

### FEATURES

- 3 dB Gain, ref  $\frac{1}{4}\lambda$  whip
- No Radials
- 360° Coverage
- Integral Tuner with Remote Control Console and Indicator
- 24 Volts To Tuner
- 110 or 220 Volt Operation
- 75 ft (22.9m) Control Cable Included
- Only 22ft (6.7m) High
- 1 sq ft (.09 sq m) Space
- Self Supporting
- Stainless Steel Hardware
- Mount: Sleeve Type Fits Pipe Up To 1 $\frac{3}{4}$  in (4.5cm) dia
- Can Be Easily Stored and Set Up For Portable or Temporary Operation

Add up the features—you'll find that you can have ALL OF THIS PERFORMANCE without the need to buy tower, rotator and associated hardware. **R3 IS ANOTHER PRODUCT CREATED FOR THE ENJOYMENT OF YOUR HOBBY BY THE WORLD RENOWNED CUSHCRAFT ENGINEERING DESIGN TEAM.**

# R3



### THE ANTENNA COMPANY

48 Perimeter Road, P.O. Box 4680  
Manchester, NH 03108 USA

TELEPHONE 603-627-7877

TELEX 953-050 CUSHSIG MAN

AVAILABLE THROUGH DEALERS WORLDWIDE

CIRCLE 53 ON READER SERVICE CARD

**Here's a relatively simple conversion of a popular workhorse. W5QMA makes very good use of EIMAC's 3CX1200A7 in updating the Drake L4B into a great DXing machine.**

## **A Quick Conversion Of The Drake L4B For Use With A 3CX1200A7**

BY PETE WARREN\*, W5QMA

**T**his article deals with the conversion of a Drake L4B from a pair of 3-500Z's to one 3CX1200A7 at full legal limit and the exploration of other possible conversions. The power supply constructed for this article is intended to serve for any amplifier utilizing this tube or even a pair of them where such is legal and needed.

While I have designed and built many commercial high-power amplifiers over the past 10 years, it has been over 25 years since (at age 16) I last built an amateur amplifier. Some months ago I vowed that if I ever built another amateur amplifier, it would be solid-state. Then I saw tentative data on the 3CX1200A7 and knew I had to build an amplifier employing one. I called to order a tube and technical data immediately and waited impatiently. Meanwhile, a friend told me of an L4B minus power supply available at a somewhat reasonable sum, and I decided to try a conversion.

The technical data and the tube arrived and the project was on. Since Peter Dahl is in El Paso (my QTH), I discussed the power supply with him and settled on a hefty design that would allow experimentation (2800-5400 volts, 1.8 amp with a capacitor input and bridge rectifier circuit). I acquired two different filament transformers, one for the L4B conversion (7.5 volt 21 amp, a wire-for-wire replacement for the Drake), and one 7.5 volt 42 amp for future experimentation.



*The heart of the conversion is the EIMAC 3CX1200A7. You'll need the glass chimney, too. However, you can use one of the existing sockets in the L4B. (Photo courtesy of Varian/EIMAC)*

The 1200 is a beauty of a tube with proper care and feeding. Since the grid dissipation is rated at 50 watts, this means there is no real need for a grid trip circuit (compared to 3CX800A7 with 4 watts and other similar tubes). Tube warm-up time to full power operation is three seconds, so no time-delay circuits are required.<sup>1</sup> How simple can you get! The resonant load impedance of the 1200

(see Table I) is only slightly higher at 3 kv than the corresponding impedance of a pair of 3-500's and the L4B in particular. The tube is rated a power gain of 20 at 4 kv. You will require the SK-346 chimney and a 2 inch hose clamp.

### **Test Results**

The power supply was connected to the L4B with the simple modifications I

\*6200 Valeria, El Paso, TX 79912

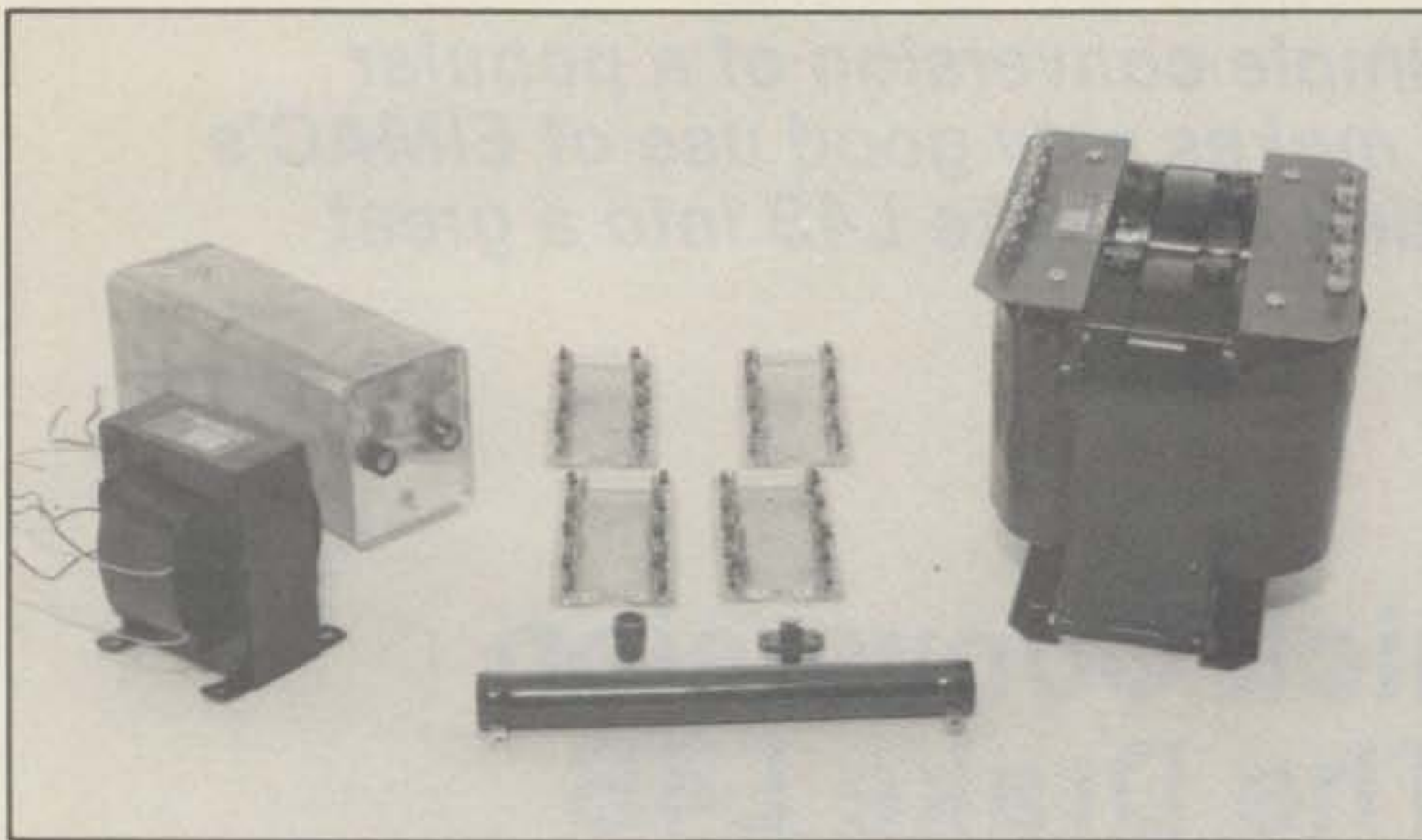

Major power-supply components. Note the preassembled diode boards in the center. These components are available from Peter W. Dahl Co.

shall describe in detail later in this article, and testing was begun.

Band (in meters)	Plate Current (in amps)	Input Power (in watts)	Output Power (in watts)
80	.55	1925	1300
40	.68	2375	1450
20	.63	2205	1450
15	.74	2590	1700
10	.70	2450	1400

Table I— Amplifier characteristics when output is measured into a dummy load with 3500 volt plate voltage applied under load, CW.

On SSB with 3600 volts under load, all bands yielded 1500+ PEP. The input to the L4B was monitored for SWR and found to be less than 1.4 to 1 on all bands. Playing with the input impedance and the out-

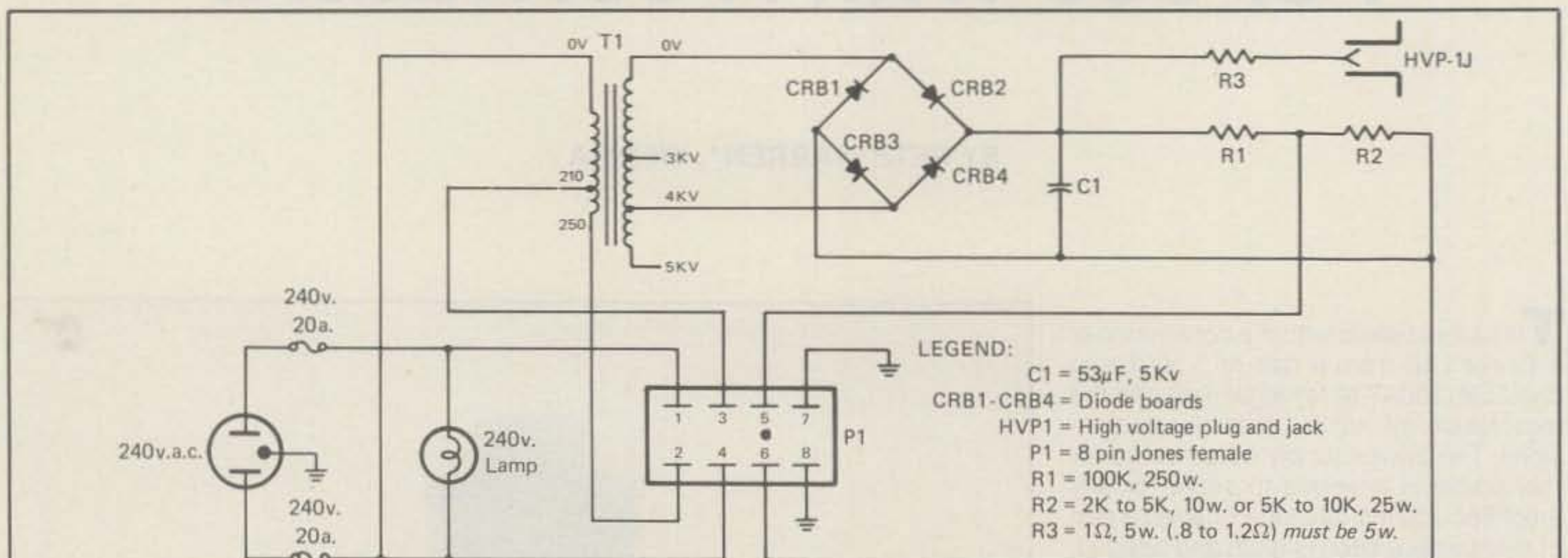

Fig. 1— Schematic diagram for the 3CX1200A7 high-voltage power supply. This same supply can be used for other amplifier projects and so was built as a separate unit.

### Parts List

The following parts are available from Pete W. Dahl Co. Inc.

	Price
C-1: 53 uf 5 kv	\$ 75.00 ea
CRBL-CRB4: 10 kv at 3 amps rectifier boards	20.00
HVP-1: Millen HV connectors (plug and jack)	5.60
HVT-1: 210 to 250 volt tapped primary 3 kv, 4 kv, 5 kv secondary, 1.8 amp Hypersil	265.00
HVT-1: 210 to 250 volt tapped primary 3 kv, 4 kv, 5 kv secondary, .9 amp Hypersil	185.00
R-1: 100K 250 watt bleeder resistor	17.50
T-1: L4B filament replacement transformer 7.5 VCT's at 21 amps	45.00

The completed power supply weighs 85 pounds. Note the collapsible handles at each end. The 20 amp, 2-pole, 250 volt breaker; neon power indicator; and 250 volt twist-lock male receptacle are visible at the lower-end handle recess. HVP-1J and P-1J are in the handle recess at the opposite end.

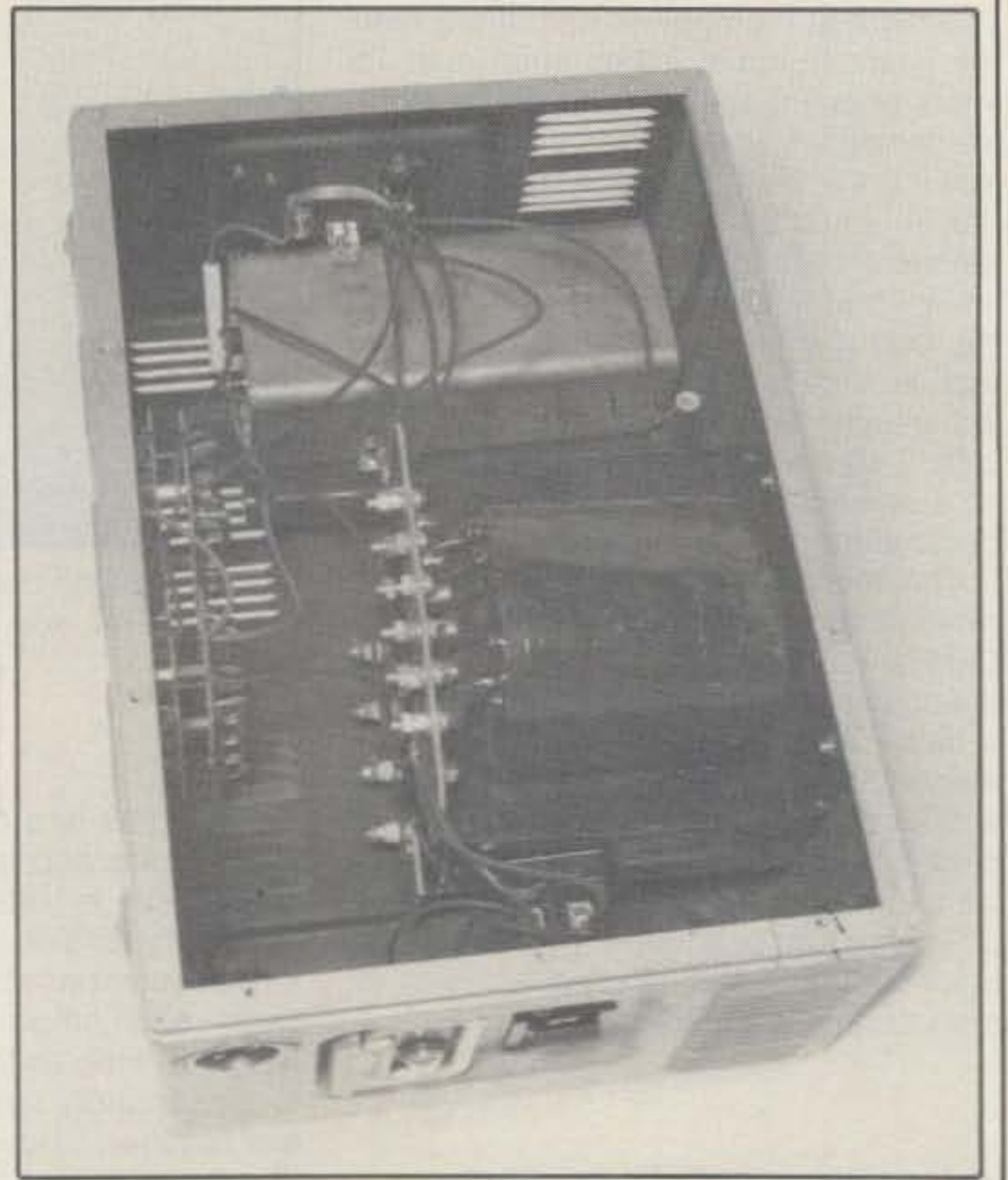

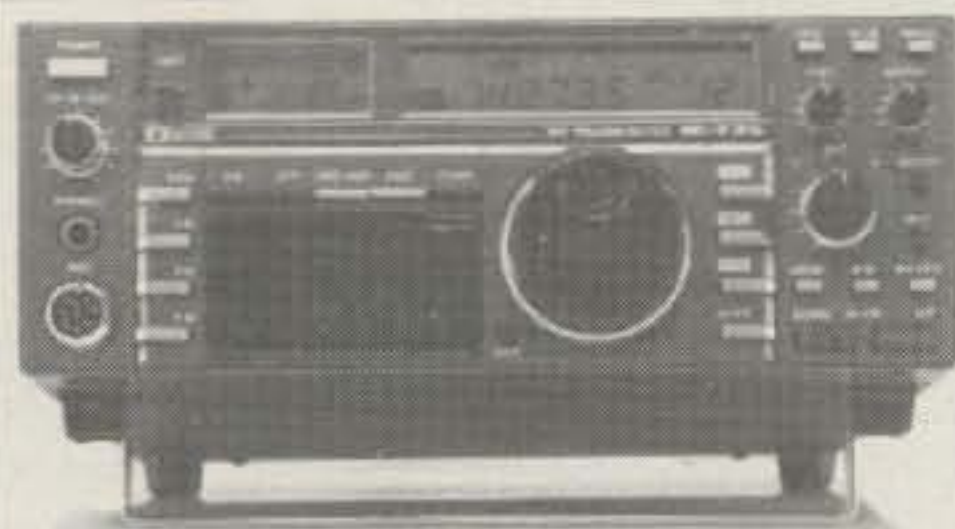

HF Equipment	Regular	SALE
IC-735 Xcvt/SW rcvt/mic	849.00	749 <sup>95</sup>
PS-55 Power supply	160.00	144 <sup>95</sup>
AT-120 Automatic antenna tuner	TBA	
FL-32 500 Hz CW filter	59.50	
EX-243 Electronic keyer unit	50.00	
IC-730 8-band 200w PEP xcvt w/mic	829.00	569 <sup>95</sup>
FL-30 SSB filter (passband tuning)	59.50	
FL-44A SSB filter (2nd IF)	159.00	144 <sup>95</sup>
FL-45 500 Hz CW filter	59.50	
EX-195 Marker unit	39.00	
EX-202 LDA interface; 730/2KL/AH-1	27.50	
EX-203 150 Hz CW audio filter	39.00	
EX-205 Transverter switching unit	29.00	
SM-5 8-pin electret desk microphone	39.00	
HM-10 Scanning mobile microphone	39.50	
MB-5 Mobile mount	19.50	
IC-720A 9-band xcvt/.1-30 MHz rcvt	1349.00	799 <sup>95</sup>
FL-32 500 Hz CW filter	59.50	
FL-34 5.2 kHz AM filter	49.50	
SM-5 8-pin electret desk microphone	39.00	
MB-5 Mobile mount	19.50	
IC-745 9-band xcvt w/.1-30 Mhz rcvt	999.00	779 <sup>95</sup>
PS-35 Internal power supply	160.00	144 <sup>95</sup>
EX-241 Marker unit	20.00	
EX-242 FM unit	39.00	
EX-243 Electronic keyer unit	50.00	
FL-45 500 Hz CW filter (1st IF)	59.50	
FL-54 270 Hz CW filter (1st IF)	47.50	
FL-52A 500 Hz CW filter (2nd IF)	96.50	89 <sup>95</sup>
FL-53A 250 Hz CW filter (2nd IF)	96.50	89 <sup>95</sup>
FL-44A SSB filter (2nd IF)	159.00	144 <sup>95</sup>
HM-10 Scanning mobile microphone	39.50	
SM-6 Desk microphone	39.00	
HM-12 Extra hand microphone	39.50	
MB-12 Mobile mount	19.50	



IC-751 9-band xcvt/.1-30 MHz rcvt	1399.00	1199
PS-35 Internal power supply	160.00	144 <sup>95</sup>
FL-32 500 Hz CW filter (1st IF)	59.50	
FL-63 250 Hz CW filter (1st IF)	48.50	
FL-52A 500 Hz CW filter (2nd IF)	96.50	89 <sup>95</sup>
FL-53A 250 Hz CW filter (2nd IF)	96.50	89 <sup>95</sup>
FL-33 AM filter	31.50	
FL-70 2.8 KHz wide SSB filter	46.50	
HM-12 Extra hand microphone	39.50	
SM-6 Desk microphone	39.00	
CR-64 High stability reference xtal	56.00	
RC-10 External frequency controller	35.00	
MB-18 Mobile mount	19.50	
Options: 720/730/745/751	Regular	SALE
PS-15 20A external power supply	149.00	134 <sup>95</sup>
EX-144 Adaptor for CF-1/PS-15	6.50	

# ICOM

Options - continued	Regular	SALE
CF-1 Cooling fan for PS-15	45.00	
EX-310 Voice synth for 751, R-71A	39.95	
SP-3 External base station speaker	49.50	
Speaker/Phone patch - specify radio	139.00	129 <sup>95</sup>
BC-10A Memory back-up	8.50	
EX-2 Relay box with marker	34.00	
AT-100 100w 8-band automatic ant tuner	349.00	314 <sup>95</sup>
AT-500 500w 9-band automatic ant tuner	449.00	399 <sup>95</sup>
AH-1 5-band mobile antenna w/tuner	289.00	259 <sup>95</sup>
PS-30 Systems p/s w/cord, 6-pin plug	259.95	234 <sup>95</sup>
OPC Optional cord, specify 2 or 4-pin	5.50	
GC-4 World clock (Closeout!)	99.95	79 <sup>95</sup>
HF linear amplifier	Regular	SALE
IC-2KL w/ps 160-15m solid state amp	1795.00	1299
VHF/UHF base multi-modes	Regular	SALE
IC-551D 80 Watt 6m transceiver	699.00	599 <sup>95</sup>
EX-106 FM option	125.00	112 <sup>95</sup>
BC-10A Memory back-up	8.50	
SM-2 Electret desk microphone	39.00	
IC-271A 25w 2m FM/SSB/CW xcvt	699.00	569 <sup>95</sup>
AG-20 Internal preamplifier*	56.95	
IC-271H 100w 2m FM/SSB/CW xcvt	899.00	759 <sup>95</sup>
AG-25 Mast mounted preamplifier*	84.95	
IC-471A 25w 430-450 SSB/CW/FM xcvt	799.00	699 <sup>95</sup>
AG-1 Mast mounted preamplifier*	89.00	
IC-471H 75w 430-450 SSB/CW/FM xcvt	1099.00	969 <sup>95</sup>
AG-35 Mast mounted preamplifier*	84.95	

**For a Limited time!**  
 With the purchase of IC-271A/H or IC-471A/H get the matching Preamp\* for just \$1.00 extra.

Common accessories for 271A/H and 471A/H	Regular	SALE
PS-25 Internal power supply for (A)	99.00	89 <sup>95</sup>
PS-35 Internal power supply for (H)	160.00	144 <sup>95</sup>
PS-15 External power supply	149.00	134 <sup>95</sup>
CF-1 Cooling fan for PS-15	45.00	
EX-144 Adaptor for PS-15/CF-1	6.50	
SM-6 Desk microphone	39.00	
EX-310 Voice synthesizer	39.95	
TS-32 CommSpec encode/decoder	59.95	
UT-15 Encoder/decoder interface	12.50	
UT-15S UT-15S w/TS-32 installed	79.95	
VHF/UHF mobile multi-modes	Regular	SALE
IC-290H 25w 2m SSB/FM xcvt, TTP mic	549.00	479 <sup>95</sup>
IC-490A 10w 430-440 SSB/FM/CW xcvt	649.00	579 <sup>95</sup>
VHF/UHF/1.2 GHz FM	Regular	SALE
IC-27A Compact 25w 2m FM w/TTP mic	369.00	299 <sup>95</sup>
IC-27H Compact 45w 2m FM w/TTP mic	409.00	359 <sup>95</sup>
IC-37A Compact 25w 220 FM, TTP mic	449.00	299 <sup>95</sup>
IC-47A Compact 25w 440 FM, TTP mic	469.00	399 <sup>95</sup>
UT-16/EX-388 Voice synthesizer	29.95	
IC-3200A 25w 2m/440 FM w/TTP	549.00	489 <sup>95</sup>
UT-23 Voice synthesizer	29.95	
IC-120 1w 1.2 GHz FM transceiver	499.00	449 <sup>95</sup>
ML-12 10w amplifier	339.00	299 <sup>95</sup>
6m portable	Regular	SALE
IC-505 3/10w 6m port. SSB/CW xcvt	449.00	399 <sup>95</sup>
BP-10 Internal Nicad battery pack	79.50	
BP-15 AC charger	12.50	
EX-248 FM unit	49.50	
LC-10 Leather case	34.95	
SP-4 Remote speaker	24.95	



Hand-held Transceivers	Regular	SALE
Deluxe models		
IC-02AT for 2m	349.00	289 <sup>95</sup>
IC-04AT for 440 MHz	379.00	289 <sup>95</sup>
Standard models		
IC-2A for 2m	239.50	189 <sup>95</sup>
IC-2AT with TTP	269.50	199 <sup>95</sup>
IC-3AT 220 MHz, TTP	299.95	239 <sup>95</sup>
IC-4AT 440 MHz, TTP	299.95	239 <sup>95</sup>

Accessories for Deluxe models	Regular	SALE
BP-7 425mah/13.2V Nicad Pak - use BC-35	67.50	
BP-8 800mah/8.4V Nicad Pak - use BC-35	62.50	
BC-35 Drop in desk charger for all batteries	69.00	
BC-60 6-position gang charger, all batts	359.95	
BC-16U Wall charger for BP7/BP8	10.00	
LC-11 Vinyl case	17.95	
LC-14 Vinyl case for Dlx using BP-7/8	17.95	
LC-02AT Leather case for Dlx models w/BP-7/8	39.95	

Accessories for both models	Regular	SALE
BP-2 425mah/7.2V Nicad Pak - use BC35	39.50	
BP-3 Extra Std. 250 mah/8.4V Nicad Pak	29.50	
BP-4 Alkaline battery case	12.50	
BP-5 425mah/10.8V Nicad Pak - use BC35	49.50	
CA-2 Telescoping 2m antenna	10.00	
CA-5 5/8-wave telescoping 2m antenna	18.95	
FA-2 Extra 2m flexible antenna	10.00	
CP-1 Cig. lighter plug/cord for BP3 or Dlx	9.50	
DC-1 DC operation pak for standard models	17.50	
LC-2AT Leather case for standard models	34.95	
RB-1 Vinyl waterproof radio bag	30.00	
HH-SS Handheld shoulder strap	14.95	
HM-9 Speaker microphone	34.50	
HS10 Boom microphone/headset	19.50	
HS-10SA Vox unit for HS-10 & Deluxe only	19.50	
HS-10SB PTT unit for HS-10	19.50	
ML-1 2m 2.3w in/10w out amplifier	79.95	SALE
SS-32M Commspec 32-tone encoder	29.95	

Shortwave receiver	Regular	SALE
R-71A 100 kHz-30 Mhz digital receiver	\$799.00	659 <sup>95</sup>
RC-11 Wireless remote controller	59.95	49 <sup>95</sup>
FL-32 500 Hz CW filter	59.50	
FL-63 250 Hz CW filter (1st IF)	48.50	
FL-44A SSB filter (2nd IF)	159.00	144 <sup>95</sup>
EX-257 FM unit	38.00	
EX-310 Voice synthesizer	39.95	
CR-64 High stability oscillator xtal	56.00	
SP-3 External speaker	49.50	
CK-70 (EX-299) 12V DC option	9.95	
MB-12 Mobile mount	19.50	



**Order Toll Free - Use your Credit Card!**

**HOURS** • Mon. thru Fri. 9-5:30; Sat. 9-3  
 Milwaukee WATS line: 1-800-558-0411 answered evenings until 8:00 pm Monday thru Thursday.  
**Please use WATS lines for Ordering**  
 use Regular lines for other Info and Service dept.

**Order Toll Free: 1-800-558-0411** In Wisconsin (outside Milwaukee Metro Area) 1-800-242-5195  
**AMATEUR ELECTRONIC SUPPLY Inc.**  
 4828 W. Fond du Lac Avenue; Milwaukee, WI 53216 - Phone (414) 442-4200

### AES BRANCH STORES

<b>WICKLIFFE, Ohio</b> 44092 28940 Euclid Avenue Phone (216) 585-7388 Ohio WATS 1-800-362-0290 Outside Ohio 1-800-321-3594	<b>ORLANDO, Fla.</b> 32803 621 Commonwealth Ave. Phone (305) 894-3238 Fla. WATS 1-800-432-9424 Outside Florida 1-800-327-1917	<b>CLEARWATER, Fla.</b> 33575 1898 Drew Street Phone (813) 461-4267 No In-State WATS No Nationwide WATS	<b>LAS VEGAS, Nev.</b> 89106 1072 N. Rancho Drive Phone (702) 647-3114 No In-State WATS Outside Nevada 1-800-634-6227	<b>CHICAGO, Illinois</b> 60630 ERICKSON COMMUNICATIONS 5456 N. Milwaukee Avenue Phone (312) 631-5181 Outside Illinois 1-800-621-5802
--	---	---	---	--

put impedance will no doubt yield the anticipated 1870 single tone useful output power (Table II). However, we achieved our goal of 1500 PEP out on all bands, and we will play with impedance in a subsequent article.

### Building The Power Supply

A friend and I started building the power supply at 10 a.m. and finished at 9 p.m. the same day. This included drawing the schematic (see fig. 1) and handling our normal work load, emergencies, and an employee party. We figure it took four man hours actual assembly time.

I chose a new surplus vented electronic carrying case with fold-down handles to build this power supply. Ventilation is required, since the heat generated by the bleeder resistor, rectifier, and transformer dissipation can add up. The resistor itself can dissipate up to 250 watts. The power supply, however, does run quite cool under normal use. I chose to use a 20 amp 2-pole breaker, rather than the switch and fuses shown in fig. 1. The finished supply measures 9" x 15" x 20" as I assembled it, but any similar size will do. The HV transformer may be smaller if a ICCS current of .8 amp is specified, and the overall size of the supply may be reduced slightly with no ill effects to output performance. All of the power-supply components are available from Peter Dahl. The no-load HV will drop approxi-

### RADIO FREQUENCY LINEAR AMPLIFIER CATHODE DRIVEN Class AB<sub>2</sub>

#### TYPICAL OPERATION (Frequencies to 30 MHz)

Class AB<sub>2</sub> Cathode Driven, Peak Envelope or Modulation Crest Conditions

Plate Voltage	2500	300	3500	400	Vdc
Cathode Voltage <sup>1</sup>	0	0	0	0	Vdc
Zero-Signal Plate Current <sup>3</sup>	130	165	205	240	mA dc
Single-Tone Plate Current	800	800	800	800	mA dc
Two-Tone Plate Current	540	560	570	565	mA dc
Single-Tone Plate Current <sup>3</sup>	255	250	275	250	mA dc
Two-Tone Grid Current <sup>3</sup>	140	130	140	112	mA dc
Peak rf Cathode Voltage <sup>3</sup>	115	105	120	115	vAc
Peak Driving Power <sup>3</sup>	102	105	110	100	Watts
Single-Tone Useful Output Power <sup>3</sup>	1250	1600	1870	2055	Watts
Resonant Load Impedance	1750	2080	2430	2780	ohms
Intermodulation Distortion Products <sup>2</sup>					
3rd Order	-37	-35	-30	-33	dB
5th Order	-42	-47	-43	-48	dB

<sup>1</sup> Positive cathode bias may be provided by zener diode

<sup>2</sup> The intermodulation distortion products are referenced against one tone of a two equal tone signal

<sup>3</sup> Approximate values

Table II—Manufacturer specifications for the 3CX1200A7.

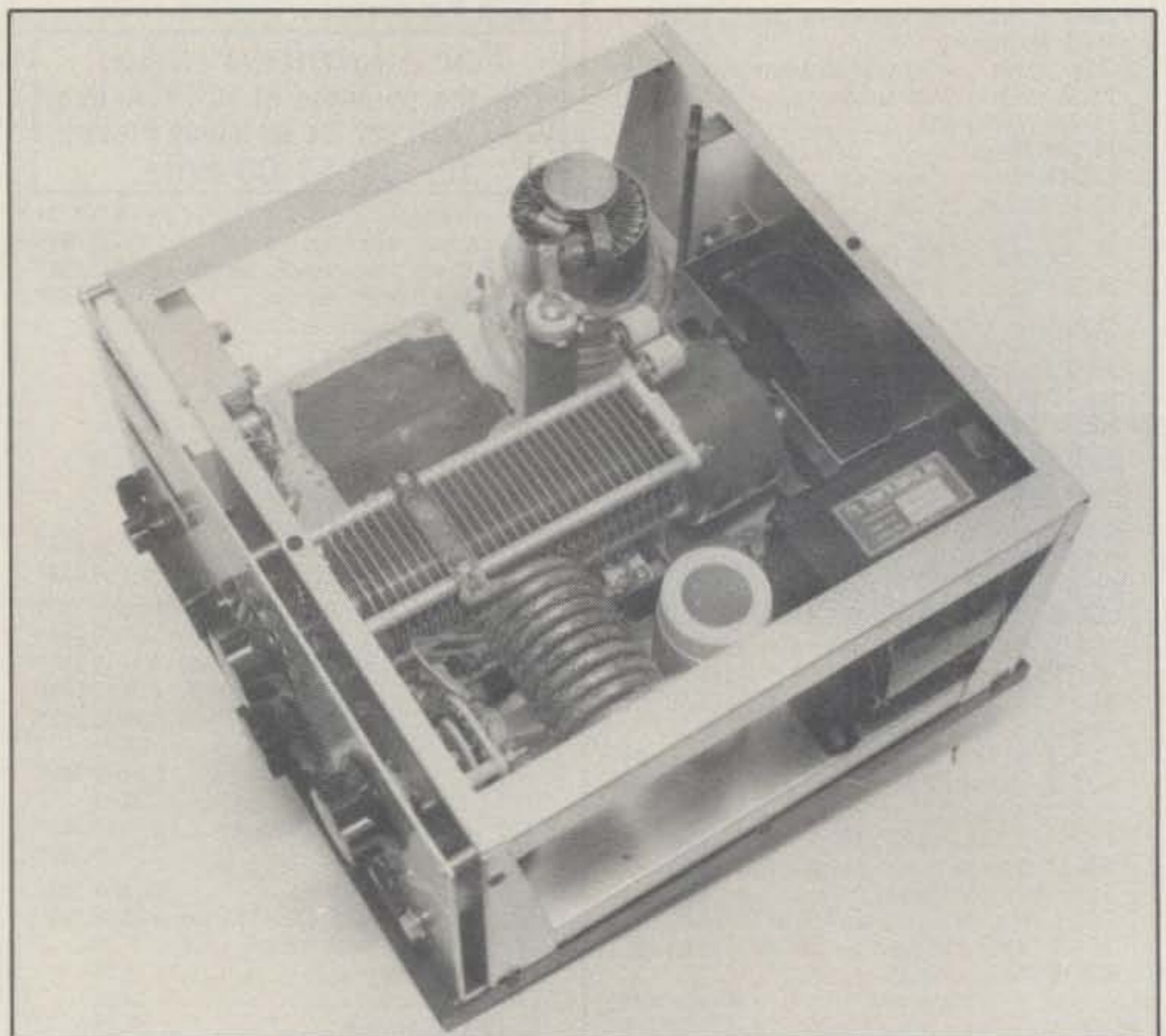

An interior view of the converted L4B amplifier. Note the 2 inch hose-clamp plate connector and the front tube socket hole-cover. The new filament transformer can be seen in the lower right-hand corner.

mately 10% under full load. With the heavy-duty diode array supplied by Dahl, no extra surge protection was needed.

Stand-by cut-off bias is supplied by R2, and any close value (see fig. 1) may be used. R3 is a surge protector for the supply and will blow like a fuse if a short is encountered externally to the supply, so it must be 5 watts and mounted, so that if it blows, the leads to it do not short out. (After writing this article, one of the 500 pF 5 kv

capacitors in the L4B shorted under a no-load voltage of only 3950 volts. R3 works!)

### Converting The L4B

This is the simple part.

1. Replace the existing filament transformer with Dahl's new 7.5 volt 21 amp transformer, wire for wire. It mounts in the same space. Be certain the L4B is jumpered for 230 volt operation (see fig. 2).

2. Prepare a cover plate out of plastic,

### MISSING



NAME: Guy Dean Scruggs DOB: 6/29/62 Age: 23  
EYES: Blue HAIR: Blonde FROM: Spartensburg, SC  
CHILD FIND #2316P



NAME: Richard Lee Scruggs DOB: 6/10/64 Age: 21  
EYES: Brown HAIR: Brown FROM: Spartensburg, SC  
CHILD FIND #2316P

If you can assist in identifying a child or if you are one of these missing children, call Child Find Inc., TOLL FREE HOTLINE (800)-I-AM-LOST (914-255-1848 collect in NY). Please refer to the Child Find # when calling.

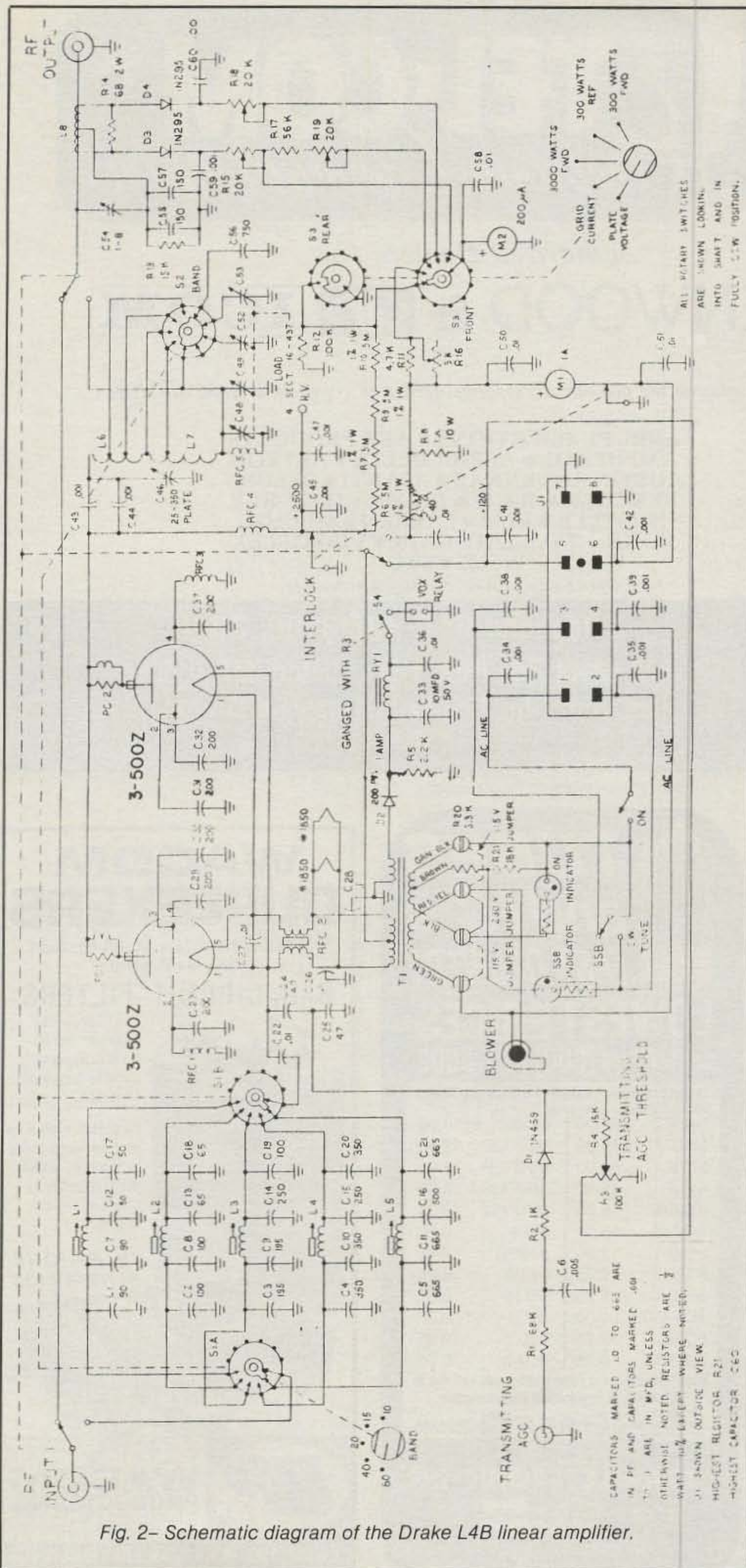

Fig. 2- Schematic diagram of the Drake L4B linear amplifier.

bakelite, or plexiglass for the front tube socket hole.

3. Remove the 3-500's if they are still there. Save the plate leads. Remove the chimney clamps on the front socket hole only!

4. Install the cover plate on the front tube socket hole using single- or double-sided tape under the cover to seal it, and bolt it in place of the front chimney clamps.

5. Install the 3CX1200A7 and its new chimney in the rear socket.

6. Install one of the two plate leads using a 2 inch hose clamp for the plate cap.

7. As you increase the output beyond the original criteria set for the L4B, the cooling fan may not be able to cool the additional heat of the tube. A bigger blower or a supplemental fan should be considered for this use. The cooler the tube runs, the longer the tube's life.

This completes the conversion. The Heath SB220 or any other amplifier using two 3-500's should be almost as simple.

### Testing

Hook up the power supply with the high-voltage tap on 3 kv to start testing and assure normal operation with the CW-SSB switch in the CW position. This should give 2800 volts or so with no load. Be certain of low VSWR to avoid arcing (1.5:1 or less). Now try the SSB mode.

Remove the 230 volt AC source from the power supply. Wait 20 seconds or more. Even if a recommended shorting switch is installed, short across filter capacitor C-1 with an insulated screwdriver to be safe. Change the HV power tap to 4 kv.

Retune the amplifier in the CW mode (3600 volts no-load, 3200 volts loaded). If all parameters scan as normal, try the SSB mode (4000 volts no-load, 3500-3600 volts loaded). You should achieve outputs similar to the ones in Table I.

### Footnotes

**CAUTION:** You are dealing with extremely high voltages which can be lethal. Use the utmost care and have a healthy respect for these voltages. High-voltage conditions may exist for 20 seconds after the primary is removed.

A tube of this power capacity has a high value of inrush filament current—typically ten times the normal amount. In this case, inrush current on a cold filament is on the order of 200 amps. The Dahl filament transformer will allow this to flow for a second or two. However, this causes quite a heavy stress on the tube's filament and over a period of time is not to be recommended. It is suggested that a time-delay relay be added to the filament circuit which will short out a series resistor after a few seconds. The resistor should allow about 70% of the filament voltage to be applied during the inrush period, which is about 2 seconds. Then full voltage can be applied. This will pay off in increased tube life.

**SPECIAL  
ICOM  
IC-745  
\$789.00**



# TEL-COM★ *Electronic Communications*

Authorized Dealers For

**KENWOOD & ICOM**

Also displaying the popular accessories needed to complete a HAM STATION . . .

**SPECIAL  
NEW!  
KENWOOD  
TS 940S  
With Automatic  
Antenna Tuner  
\$1765.00**

ARRL PUBLICATIONS • AEA PRODUCTS  
AMPHENOL • ALPHA DELTA • ASTRON  
AUSTIN ANTENNAS • AVANTI • BELDEN  
BENCHER • B & W • DAIWA • HAM-KEY  
HUSTLER • KLM • LARSEN • MIRAGE  
ROHN • TELEX/HY-GAIN • VIBROPLEX  
WELZ • ETC.

Open 6 Days A Week Monday thru Saturday

**Telephone 617/486-3400, 3040**

675 Great Rd., (Rte. 119) Littleton, MA 01460

1 1/4 miles from Rte. 495 (Exit 31) toward Groton, Mass.

CIRCLE 77 ON READER SERVICE CARD

## WHEN VIC TALKS . . .

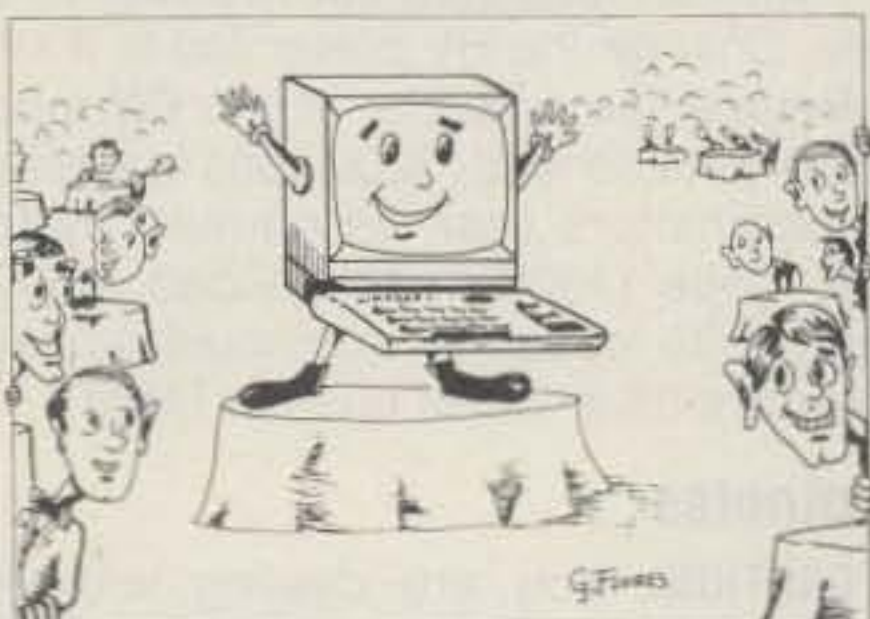

Add a new dimension to your VIC-20 with the VIC-TALKER cartridge, providing voice synthesis through the TV. Unlimited vocabulary with advanced English text pronunciation rules and user-expandable exception dictionary. Works with numbers, abbreviations and punctuation too. Pronounces text output from BASIC PRINT statements, just like you send to the printer. Use built-in inflection rules or control pitch and volume with simple commands from BASIC. Mixes audio from the VIC-20 sound chip with VIC-TALKER's synthesized voice. Completely self-contained cartridge doesn't steal user memory from BASIC. EEPROM saves user-expanded exceptions dictionary when power is off — all exceptions you create are there when power is turned on again! Create different voices and sound effects. Make voices ranging from baritones to chipmunks with the powerful synthesis chip.



**\$89<sup>00</sup>**

+ shipping  
and handling

**t talktronics, inc**

27341 Eastridge Drive ★ El Toro, CA 92630  
(714) 768-4220 9am-5pm PST

CIRCLE 75 ON READER SERVICE CARD



## TUBES and IC's FAST DELIVERY LOWEST PRICES

call Toll Free (800) 221-5802

In-depth Inventory - Industrial & Receiving Tubes  
Here are 2 dozen examples...

3-400Z	\$85.00	8122	\$110.00
3-500Z	85.00	MRF450	12.95
572B	55.00	MRF454	18.95
811A	12.00	MRF455	14.95
6146B	8.75	MRF492	19.95
M2057	15.00	6LF6	8.26
8950	11.50	6JS6C	7.46
807	5.75	6KD6	8.26
6550A	7.75	6MJ6	8.38
4CX250B	60.00	8417	8.38
6DJ8	2.75	7360	13.95
6883B	8.25	6CA7	5.55

Major Manufacturers Factory boxed and Full line of  
Sylvania ECG Replacement Semiconductors

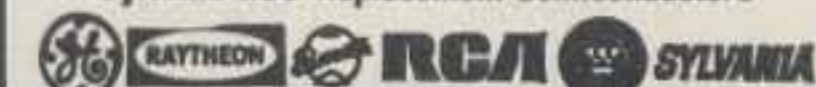

Minimum order \$25.00

Allow \$3 UPS charge

**TRANSELETRONIC INC.**

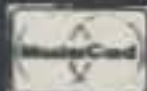
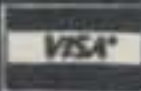

Box No. C, 1365 39th STREET BROOKLYN, NY 11218  
Tel. 718-633-2800/Watts Line 800-221-5802  
FAX # (718) 633-4375

CIRCLE 8 ON READER SERVICE CARD

## WACOM DUPLEXERS

Our Exclusive Bandpass-Reject Duplexers  
With Our Patented

**B<sub>p</sub>B<sub>r</sub> CIRCUIT<sup>®</sup> FILTERS**

... provides  
superior performance, especially  
at close frequency  
separation.

Models available for  
all commercial and  
ham bands within  
the frequency  
range of 35 to  
960 MHz.

**TELEPHONE  
817/848-4435**



**WACOM  
PRODUCTS, INC.**

P.O. BOX 21145 • WACO, TEXAS 76702 • 817/848-4435

CIRCLE 73 ON READER SERVICE CARD



# HENRY

# REPORT #2

New models reflect our policy by design. Technology moves fast. At Henry Radio we keep up with a steady flow of new models, some for amateur use, some for commercial use, some for industrial use and some for scientific research.

Here are three new models for this month:

- \*New UHF model 3004 1500 watts output at 440 MHz.
- \*New VHF model 3002 1500 watts output at 144 MHz.
- \*New HF 5K Classic, 3.5 to 30 MHz (not for sale to U.S. amateurs)

These three added to the already broad line of amplifiers we offer means that we can now cover two MHz to 500 MHz and power outputs as high as 10,000 watts depending on frequency. This may be the most complete line of power RF amplifiers available in the world.

Let us know your requirements. We want to help you.

**2K Classic**...the culmination of more than fifteen years of developing the 2K series into the world famous line that sets the standards for top quality HF linears. A true "workhorse"; built to loaf along at full legal power, trouble free, for years of hard service. Operates on all amateur bands, 80 through 15 meters (export models include 10 meters).

**2K Classic "X"**...We can't think of any way to make this magnificent 2000 watt amplifier better. Rugged...durable...the last amplifier you may ever need to buy.

**3K Classic**...uses the superb Eimac 8877 tube. More than 13db gain. We believe the 3K to be the finest amateur linear available anywhere...the amplifier of every amateur's dreams.

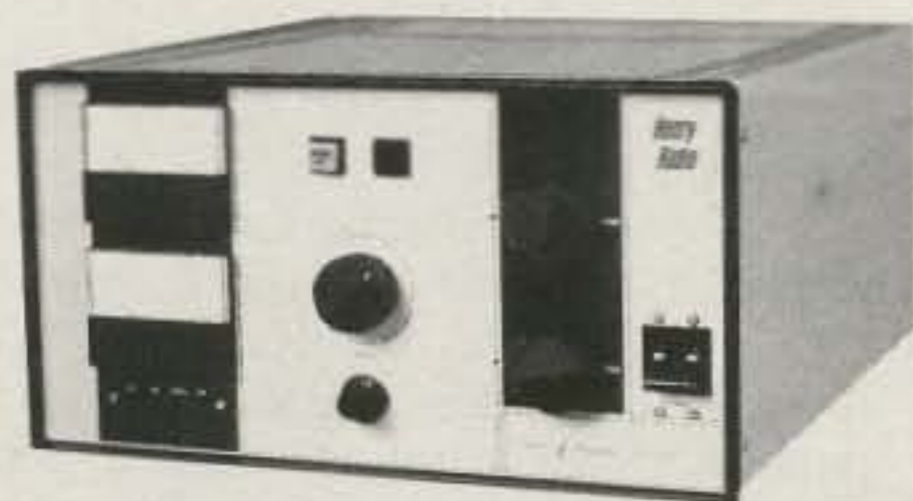

**2KD Classic**...a desk model designed to operate at 2000 watts effortlessly, using two Eimac 3-500 Z glass envelope triodes, a Pi-L plate circuit and a rotary silver plated tank coil. We challenge you to find a better desk model for even a thousand dollars more.



**2002-A**...a bright new rework of our popular 2002 2 meter amplifier. Uses the new Eimac 3CX800A7. The RF chassis uses a 1/4 wave length strip line design for extreme reliability. It provides 2000 watts

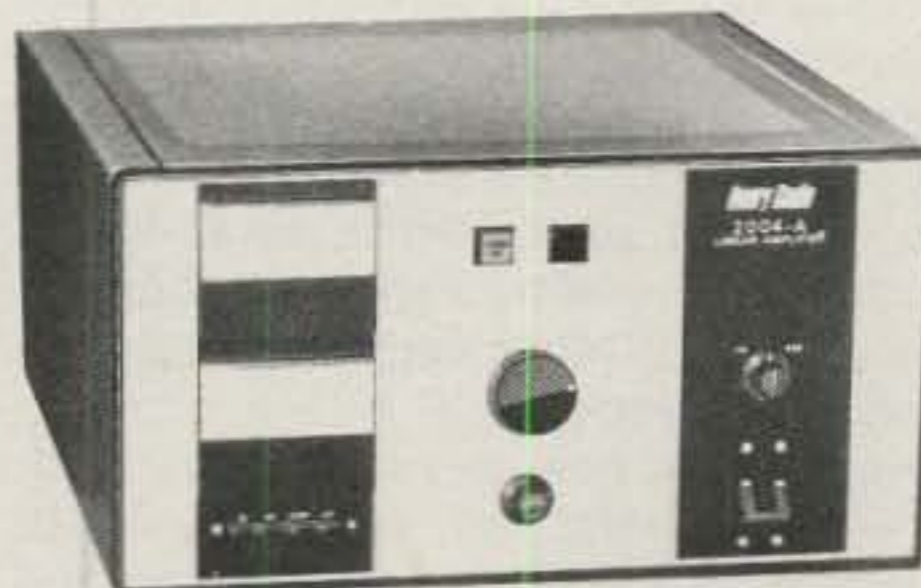

input for SSB and 1000 watts input for CW. Because this tube is rated at an unheard of 15dB gain, only about 25 watts drive is required for full output.

**2004-A** is identical to the 2002A except that it is set up for the 430 to 450 MHz band. This amplifier uses a 1/2 wave strip line and offers all of the same specifications as the 2002A.

**1002-A** A rack mount 2 meter amplifier with the same design as the 2002A, except using one 8874 tube for 1/2 power specifications. Rated at 600 watts PEP output and 300 watts continuous carrier output. It employs the same strip line design as the 2002A.

**1004-A**...a rack mount half-power version of the 2004A. Covers the 430 to 450 MHz band using a 1/2 wave strip line design.

Henry amateur amplifiers are available from select dealers throughout the U.S. and are being exported to amateurs all over the world. In addition to our broad line of commercial FCC type accepted amplifiers we offer special RF power generators for industrial and scientific users. Call or write Ted Shannon or Mary Silva for full information.

We stock these plus many other fine names:  
AEA • ARCO • AARL • ASTRON • B & K • B & W • BIRD •  
CDE • CONNECT-SYSTEMS • CUSHCRAFT • EIMAC •  
HAL • HUSTLER • HY-GAIN • ICOM • KENWOOD •  
LARSEN • NYE • ROBOT • TEMPO • VIBROPLEX • YAESU



## Henry Radio

2050 S. Bundy Dr., Los Angeles, CA 90025 (213) 820-1234  
Butler, Missouri 64730 (816) 679-3127

TOLL FREE ORDER NUMBER: (800) 421-6631 For all states except California. Calif. residents please call collect on our regular numbers.

CIRCLE 56 ON READER SERVICE CARD

## The Kansas City Keyer Model KC-1

The serious operator is always on the lookout for new equipment, methods, and technologies to gain any edge, however fine, on the competition. For many years, one important element of the successful contest operator's station has been a good programmable memory keyer. However, the advent of microprocessor technology in Morse code memory keyers seemed to arrive at virtually the same time that development of new features in such keyers ceased. Of course, the first generation of microprocessor memory keyers certainly brought valuable new features to the dedicated operator, especially contest operators, but other aspects left something to be desired.

Highly desirable keyer options, such as variable weighting, variable monitor tone control, switchable dot memory and dash memory, and switchable auto-spacing are all standard features of microprocessor keyers, and keyboard control of these features is acceptable to most operators. On the other hand, digital control of transmission speed is satisfactory to very few, as most operators find that they simply cannot accurately judge speed, especially in responding to another station. Most, if not all, operators prefer a variable-speed pot control.

The KC-1 Kansas City Keyer from Lance Johnson solves this problem neatly—indeed, elegantly—giving the operator a continuously variable-speed control pot, while retaining all the desirable design features of other microprocessor controlled keyers, and adding some significant new features of its own.

For a contest keyer to be useful, it must do one thing better than the competition: it must give the operator more time with his hands and mind while he is operating. Time is of the essence to the winning contest station. Time to log. Time to dupe. Time to munch on a sandwich, time to gulp a mouthful of cold coffee. Time to

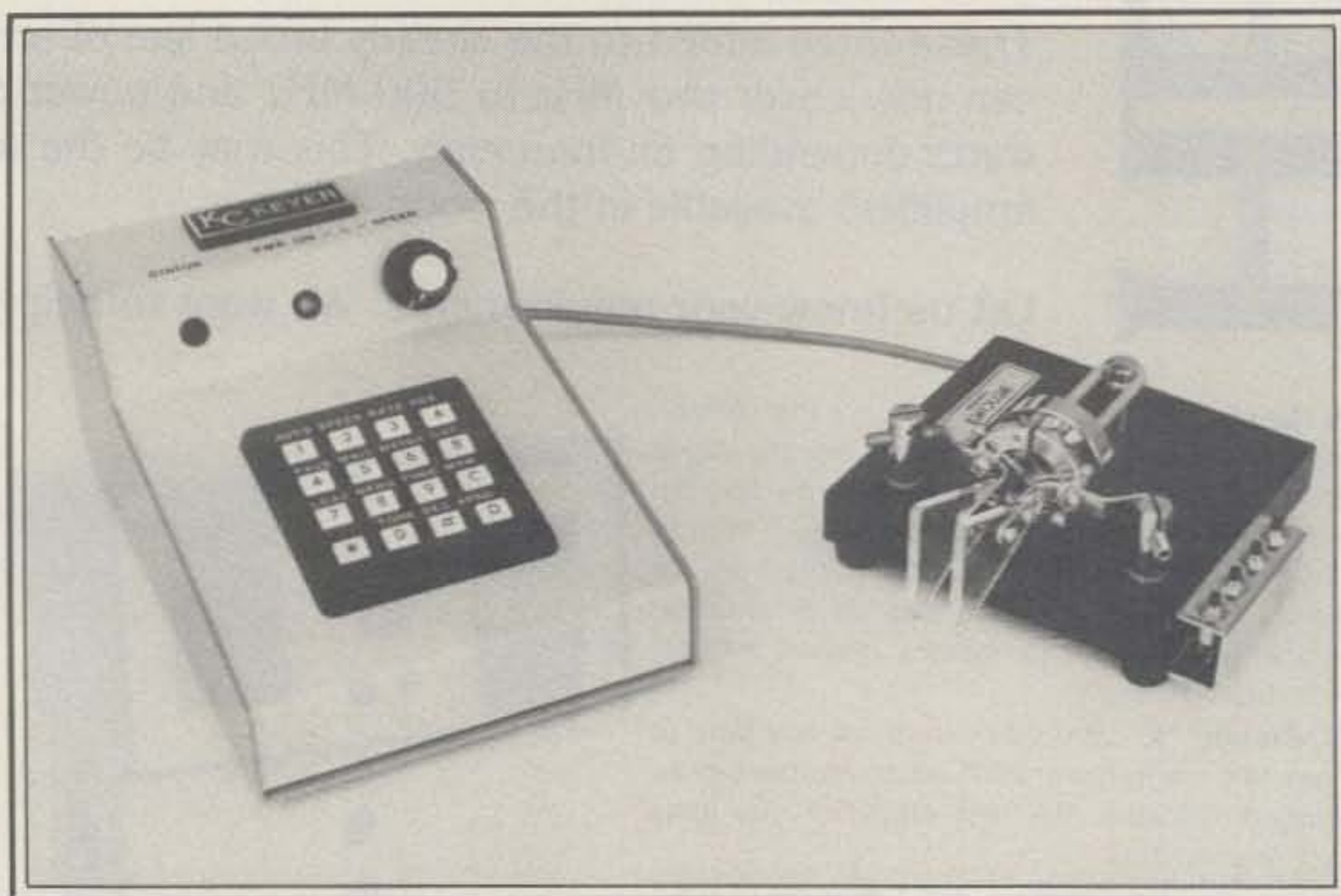

The complete Kansas City Keyer package. The keyer is on the left, with the Bencher keyer and pushbutton controller on the right.

change log pages, time to turn the antenna. All of this time, of course, is while the station and operator continue to transmit, racking up the QSO's, with the programmed memory keyer giving the operator the time and the hands for all the above-referenced necessary chores.

The KC-1 gives the operator more of that hands-free time, along with a host of other features designed to give the serious contest operator an extra edge. The features that the KC-1 offers are almost too numerous to mention. Consider, for example, the option of a programmed message that has a pause built in to allow manual insertion of information during the transmission of a memory message such as another station's call, and then, automatic resumption of the message when you are finished with the manual entry. Consider not only an automatic serial-number generator, but the ability to ask the keyer the current number without transmitting, or the ability to repeat the number or to subtract one digit from the number. Consider the ability to end a

memory program with a timed pause, then have an automatic start of another message.

Not only are these features standard in the KC-1, but there are more. Imagine a totally closed loop of messages. The keyer calls "QRZ TEST DE W9KNI K," then pauses. I hear a station respond, and log the call, then key it into the waiting keyer, "ZA1AB." Perfectly timed, the memory picks up where I leave off, sending "5NN04 BK," and I log my report. To indicate confirmation after I copy his exchange, I touch the paddle, "T" and release the paddle. Again, almost magically, the KC-1 keyer senses that I am finished with the manual entry and picks up and restarts the sequence "U QRZ TEST DE W9KNI K" and keeps going. *Notice:* to achieve that QSO, I fingered, kneed, or footed NO switches. I sent two groups—one the other station's call, the other a simple "T," which the keyer followed with the "U" to finish the "TU," then automatically called up the "QRZ" routine. The rest of the time was spent logging,

\*1445 Northwoods Circle, Deerfield, IL 60015

duping, drinking cold coffee . . . Hey. Wait a minute. A ZA? A ZA? Hey! That's an all-time new one!

I should be so lucky.

But that's not all! The operator can elect to program the actual wpm sending speed during a memory transmission so that messages are sent at specific speeds, or he can choose to have messages sent at whatever speed for which the keyer is set. As earlier referenced, the operator does have available a speed control knob, but the keyer also allows keyboard entered and programmed speeds. Obviously, this can be very useful. For example, you could program the "QRZ" response sequence to read "QRZ TEST DE W9KNI W9KNI AR" with the "QRZ TEST" portion of the message sent at 40 wpm, and the "DE W9KNI W9KNI AR" portion at 25 wpm. This would be exceptionally valuable in a Sweepstakes exchange.

The KC-1 even offers the ability to generate "sloppy" CQ messages, suggesting hand-sent CQ's by a tired operator, rather than the perfection of the usual programmed keyer. Such a CQ might well be desirable in the later hours of a contest in trying to snag stations not seriously dedicated to the contest. Some of these stations are reluctant to respond to a contest-machine-type CQ, but might be more likely to respond to the more comfortable "sloppy" call sent by a tired brother amateur, and give him a QSO. And some of those callers can be the extra multipliers that the competition won't snag. The "sloppy" calls are generated by purposely varying the timing between each "CQ" and by varying the number of "CQ's" in a sequence.

But, although the KC-1 is certainly a superb contest keyer, it is also a fine keyer for ordinary QSO's. Using the keyer with simple manual paddle entry, it is a friendly, easy-to-use keyer, one with which any operator should have little problem. The iambic timing of the keyer is identical to the Curtis-type "B" timing, the same as the WB4VVF designed ACCU-Keyer or the MFJ Grandmaster. The speed control pot lacks the full range of a typical keyer, but none the less covers typically a 3:1 range. However, the range of speeds can be easily changed.

When the keyer is turned on, the speed is initialized at 20 wpm at the low end of the speed range, with a high end of about 60 wpm. At any time if the operator wishes to change the speed range, he keys in the desired speed, and that speed will become the keyer speed at the point where the pot is set, with higher or lower speeds immediately available by turning the pot in the appropriate direction. So, if the operator sets the pot at mid-scale and programs the keyboard entry for 15 words per minute, he will find a speed of about 10 words per minute at the left end of the pot scale and about 30 words per minute at the high end.

Another nice aspect of the keyer is the cleverly designed optional pushbutton strip designed to fit on the side of the Bencher paddle for activation of different memory messages. Although much was made above of the ability of the keyer to run closed-loop messages, allowing strings of QSO's without use of pushbuttons, the keyer also features a total of 16 addressable memories, all callable from the keypad mounted on the front of the keyer. Four of the sixteen messages can be called by remote switching, for which the pushbutton strip is invaluable.

The KC-1 keyer is one product that will require the user to study the manual to have any hope of beginning to extract all the capabilities that this fine product offers. The manual is well written, however, and learning the full functions of the keyer is not difficult. Programming the various functions described above becomes easy, thanks to the instruction manual walking the new user through the various sequences, and clever contest-

ers will undoubtedly discover additional tricks that the flexibility of the KC-1 will allow.

The KC-1 includes enough memory for about 1500 characters, battery back-up protected in case of power failure. It is housed in an attractive slope paneled cabinet, designed to make its use under fire as simple as possible. It includes dual-polarity keying, and a standard wall-plug power supply. The unit is covered by a 90-day warranty.

Although the KC-1 offers a complex level of capabilities, it is also a fine, easily used, friendly keyer for casual operating in between contests. Although its capabilities and price put it into a class where it is not for everyone, any amateur seriously interested in contests must give it careful consideration.

The KC-1 Keyer is available from Lance Johnson Engineering, P.O. Box 7363, Kansas City, Missouri 64116. The price of the basic keyer is \$199.95. The optional pushbutton strip sells for \$19.95.

**DIGITAL INDOOR/REMOTE THERMOMETER-ALARM CLOCK**



- Monitor indoor/outdoor temperature
- Displays in degrees C or F
- Continuous LCD readout for 2 yrs. with 1) AA battery
- Quartz clock with alarm - 12/24 hr. format
- Remote sensor cable - 12'6" (4 meters)
- Display graphics - 1/2" temp, 3/8" clock
- Unit dim. - 4 1/2" x 2" x 1 3/16"
- 1 year warranty - \$39.95 + \$2 SBH

Try for 10 days. If not delighted, return for prompt refund less SBH - Satisfaction guaranteed.

**TELTEMP ENT. - DEPT. Q001, P.O. BOX 16332, SPOKANE, WA 99215**

CIRCLE 44 ON READER SERVICE CARD



**Golden State Communications**  
P.O. Box 1052 Dept. A  
Los Alamitos, Ca. 90720

**SPECIAL SALE**

**AZDEN PCS-4000 2 Meter FM Transceiver (142-149.995 MHz)**

- Small size: 2"H, 5 1/2"W, 6 3/4"D
- 16 Memories/2 Priority Channels
- 16 Key Autopatch System
- Back lit key pad
- Dual power 25W/5W
- Commercial Grade Construction
- 1 Year Warranty

**SALE PRICE \$279.00**

**ORDER YOURS TODAY! (213) 430-8395**  
7AM-5PM Pacific Time MONDAY-SATURDAY  
*Price does not include shipping and is subject to change without notice.*

CIRCLE 49 ON READER SERVICE CARD

**KDK The New FM-240 for 2-Meters**

With the **User Friendly** **MMI Man Machine Interface**

*There is NO OTHER Transceiver On the Market Today that can Surpass the KDK FM-240 in size, features, and Price! NONE!*

List Price \$369.00



**Our Prices TOO GOOD TO PUBLISH!**

When you have your quotes and are ready to buy, call Williams. We'll pay UPS shipping on your radio to make up for the phone call, when you order from us!

**NO CREDIT CARDS.**

FM-4033 (220-mHz) . . . . . CALL!  
FM-6033 (6-Meters) . . . . . CALL!  
FM-7033 (440-mHz) . . . . . CALL!

Plus FREE UPS Brown Shipping.  
For Phone CODs add only \$1.90

The KDK FM-240 features:

- 25-watts of power (5-watts in Low power)
- 16 memory channels plus one priority channel
- Automatic offset programming standard and oddball.
- Easy to see Alpha-numeric LCD readout system
- Simple tuning & programming-nothing complicated
- 16-position touchtone pad mounted on speaker/mike
- Up/Down tune, and lock switches on speaker/mike
- Programmable sub-audible tone ENCODE and DECODE
- Optional Voice Synthesized module-easily plugs in
- Four modes of scan-manual, timed, stop/stay & stop/resume
- Comes with mobile bracket, speaker microphone, power cord and easy-to-read operating instructions.
- Features 90-day warranty, plus the ENCOMM exclusive 2-year Service Warranty (details upon request)
- Compact. Measures approx: 1-1/2H x 5-1/2W x 6-5/8D (Inches)
- Covers 2-meter band, plus CAP and MARS

The Nation's Premier KDK & Sanlec Dealer!

**WILLIAMS RADIO SALES**

600 LAKEDALE ROAD, DEPT. Q  
COLFAX, N.C. 27235

CALL GERRY OR WAYNE!  
For the Best Deal Ever!  
**(919) 993-5881**  
Noon to 10 P.M. E T

When you buy your **KDK** from Williams - You get much more!

# IRISH

5.25" DISK  
40 TRACK/SIDE  
SS/SD \$12.50  
SS/DD \$13.90  
DS/DD \$15.50



VM 1285-8  
VHF MODULATOR  
CHAN 3, CHAN 4  
75 OHM OUTPUT  
STANDARD PHONO SOCKET  
\$5.00/EA.

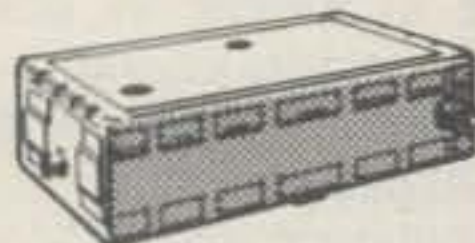

TEP  
188 DEPOT RD.  
HUNTINGTON STA., N.Y. 11746  
(516) 423-9618 CIRCLE 139 ON CARD

CALL OR WRITE FOR MORE INFORMATION.  
ADD \$3.50/SHPG/HANDLG/INS.  
NYS RESIDENTS ADD APPLICABLE SALES TAX



## TENNA HITCH by DC SALES

For Class #1 & #2 hitches

Adapts your existing car trailer hitch for any HF Antenna No holes in your car

Complete \$29.95

Plus \$5 postage & handling

Contact your favorite dealer or:



**DC SALES**

1602 Chestnut Ridge Rd.  
Kingwood, TX 77339  
(713) 358-0051

Dealer inquiries invited

CIRCLE 97 ON READER SERVICE CARD

\*NEW\* COUNTY 64 \*NEW\* COUNTY 64 \*  
COUNTY 64 COME WITH THE POWERFUL LOGGING  
FEATURES OF CONTENDER PLUS II (without WAZ &  
DXCC) / PLUS A SPECIAL COUNTY LOGGING  
SYSTEM. THIS SYSTEM TAKES THE WORK OUT  
OF COUNTY RECORD KEEPING.

OTHER LOGGING SYSTEMS AVAILABLE FROM  
CRUMTRONICS ARE:

CONTENDER PLUS II (one disk).....	\$34.95
CONTENDER PLUS II / with USA-CA. (three disk).....	\$49.95
COUNTY 64 (two disk).....	\$34.95
USA-CA ADD ON FOR CONTENDER PLUS II (2 disk).....	\$12.00

FOR FREE FACT SHEET OR TO ORDER WRITE:

**CRUMTRONICS**  
SOFTWARE DIVISION  
P. O. BOX 6187  
FORT WAYNE, IN 46896



COD ORDERS CALL: 219/745-0350 or 219/485-2718  
CRUMTRONICS is our name logging is our game

CIRCLE 131 ON READER SERVICE CARD

# CQ SHOWCASE

## Larsen Magnetic Mount and Mobile Telephone Mount

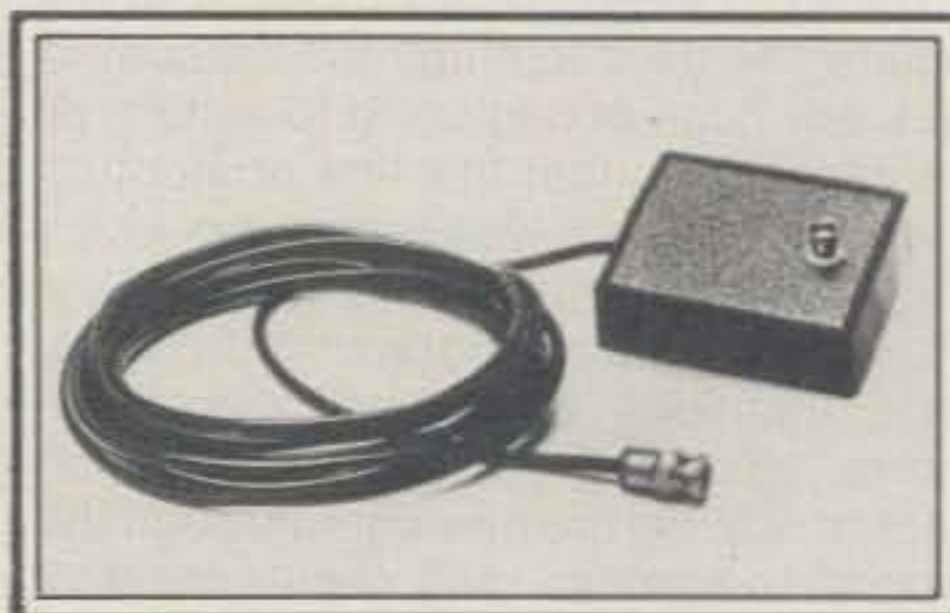

Larsen Electronic's new magnetic mount unit, with BNC connectors at both ends, allows portable radio operators to remote the portable's normal antenna outside the vehicle for mobile operation. The mount comes with 12 feet of cable for use on any vehicle. The magnetic mount contains heavy magnets and has a protective Teflon base.



Larsen's new Command Post Mobile Telephone Mount offers a variety of mounting options—dashboard, console and floor—with a central post that pivots 360 degrees on a ball joint and locks in position. A joint in the middle tilts up or down, allowing any position or angle. The mount is adjustable from inside the vehicle. The Command Post system is designed to reduce vibration to the phone unit while providing a wide range of non-slip adjustments. The basic mount may be ordered alone or with any combination of mounting accessories for individual needs.

For information on both these products, contact Larsen Electronics, P.O. Box 1799, Vancouver, WA 98668, or circle number 101 on the reader service card.

## The ICOM IC-R7000 Receiver

For monitoring all amateur radio frequencies, ICOM has introduced the IC-R7000 25-2000 MHz (specifications guaranteed from 25-1300 MHz) continuous-coverage receiver. The IC-R7000 also covers aircraft, marine, government, emergency services, and television bands. The IC-R7000 features 99 memory channels, direct keyboard frequency access or main tuning knob access, FM/AM/SSB modes, scanning (memory, mode, and programmable or priority), adjustable scanning speed, narrow/wide filter selection, five tuning speeds (0.1, 1.0, 5, 10, 12.5, or 25 kHz), fluorescent display with dimmer switch, noise blanker, and more.



The IC-R7000 is 4 3/8" H x 11 1/4" W x 10 7/8" D. Also available are an optional RC-12 infrared remote controller, and optional voice synthesizer. The unit sells for \$899. For more information, contact ICOM America, Inc., 2380 116th Ave., N.E., Bellevue, WA 98004, or circle number 102 on the reader service card.



## Wattmeters and VSWR Bridges Available From Encomm

Welz Corporation and their American distributor Encomm, Inc. have announced the introduction of a series of wattmeters and VSWR bridges. Some models peak and average power, while the mobile units also measure the automobile operating voltage. For more information on the line of wattmeters and VSWR bridges, contact Encomm, Inc., 2000 Ave. 'G' Suite 800, Plano, TX 75074, or circle number 103 on the reader service card.

# ALL MODE MOBILE TELEPHONE INTERFACE

FM - AM - SSB ± 50 Hz.

## Automatic Vox Phone Patch System

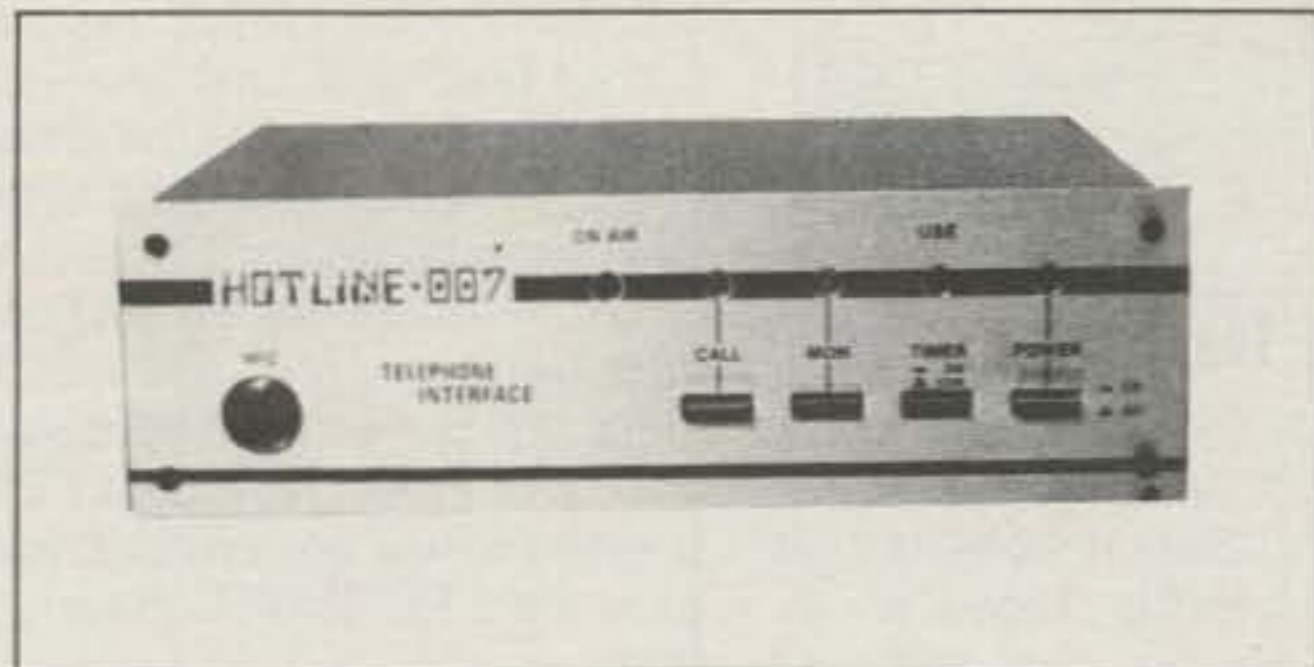

**OPTIONAL:**  
DTMF TELEPHONE  
TYPE SPEAKER/  
MICROPHONE

**HOTLINE-007** is a fully automatic simplex telephone interconnect. Operates through any base transceiver with FM-AM-Squelched SideBand mode. No modifications to the transceiver, just connect to the external speaker, microphone and phone line. **VOX** operation both transmit and receive. Selectable tone or rotary dialing. Repeater pickup operational also.

- Programmable access code 3 or 5 digits.
- Adjustable **VOX** both transceiver and phone line, digital processing delay (BBD)
- Will not transmit when frequency is busy, 7 second clear time
- \* Programmable CW ID
- \* Adjustable microphone and line gain, no lost words.
- \* Microphone jack for continued base operation, no need to change.
- \* 3 or 12 minute timer
- \* Dial restrict switch
- \* Ringback (reverse patch)
- \* Accepts speed dialing
- \* Operates on 115/220 VAC, 12 VDC

**NO EXTRAS TO PURCHASE FOR OPERATION, TRANSCEIVER AND PHONE LINE CONNECT TIME 30 MINUTES.**



SETS THE STANDARD FOR OTHERS TO FOLLOW!  
EXCLUSIVE IMPORT DISTRIBUTOR - Quality is your assurance.

1275 N. Grove Street  
Anaheim, California 92806

(714) 630-4541

CIRCLE 57 ON READER SERVICE CARD

NOTE: Prices and specifications subject to change without notice or obligation

ENGINEERING CONSULTING  
INTRODUCES

### 'REMOTE A PAD' MODEL RAP-1

2 FOUR DIGIT DTMF  
DECODERS, PLUS 16 DIGIT  
KEYPAD CONTROL

TUNE THE WORLD FROM  
YOUR HANDHELD VHF/UHF RADIO

- Audio tones from any source, are converted to solid state switches which control any 16 digit keypad of a radio or other device.
- Some examples you can control include the Pro-Search™ Rotator (rotate beam remotely), ICOM IC-701 or ICOM IC-R11 when using the RM-2 controller, ICOM 7850 & 751, Azden PCS 4000, handhelds such as Yaseu FT-2DB, FT-7DB, ICOM IC-Q2AT, and many more.
- Anything you can do manually with your 16 digit keypad, the RAP-1 will do remotely using audio touch tones from any source.
- Two (four digit) programmable access codes are used to operate relays or other on/off functions.

- LED decoder status indicators and momentary plus steady state decoder outputs are provided.
- 22 gold pin card edge connector, 15 pin dip socket and ribbon cable are supplied.
- All CMOS low power drain (30ma), 551-201 Decoder.
- Hook eight wires (4 rows and 4 columns) in parallel with the existing keypad of the radio you wish to control remotely. Connect audio from any source, 12 volts D.C. and you are in control.
- The dual 4 digit decoders will turn your links on and off using your programmable access code.
- Detailed interface diagrams and instructions included with purchase. Interface cable for Pro-Search™ \$9.95 (plugs in ecc. socket)

Model RAP-1  
**\$149.95**  
'Remote A Pad'  
Remote control  
interface board  
and DTMF  
decoder.

### ICOM IC-02AT USER'S "AUDIO BLASTER" MODULE

- Module installs inside the radio in 10 minutes.
- Boosts audio to nearly 1 watt!
- Low power drain (4 ma stand-by)
- Complete step by step instructions included
- Corrects the LOW audio problem!
- Drive external speakers to full volume, even signals with low deviation!



Model AB-1 **\$19.95**  
Price includes postage and handling, U.S.A. CA res. add 6%

Send check or money order to:  
**ENGINEERING CONSULTING**  
583 CANDLEWOOD ST., BREA, CA 92621  
(714) 671-2009

Please send all reader inquiries directly.

Say You Saw It In CQ

### CONTEST PROGRAMS FOR APPLE II, II+, IIe

CQWW DX • ARRL DX • SS • SPRINT

Custom Disk dedicated to each contest. Each Disk has 1 contest, 5 programs. High speed. 1200+ basic program lines.

- Contest Log Keeper - instant dupecheck, stored DXCC list does auto count/display of countries (zones/sects) - scrolls log
- Edit • Print/Display Log • Checklist
- QSL Labels (alphabetical or selected)

Req. Disk Drive, 48K. Clock/Printer Optional  
**\$30.00/disk ppd.**

Jack L. Schultz, W2GGE  
2 Huxley Drive, Huntington, NY 11743

CIRCLE 70 ON READER SERVICE CARD

### AMATEUR TRADER



**FAST** YOUR AD WILL BE CIRCULATED FAST, NO TWO MONTH DELAY AS IN OTHER PUBLICATIONS. ADS ARE CIRCULATED TWICE EA MO.  
**INEXPENSIVE** ADS-15 CENTS PER WORD. SUBSCRIPTIONS-12MO, \$9. 6MO, \$5. SEND CHECK TO:

WOODY'S AMATEUR TRADER  
P.O. BOX 202, LYNDEN,  
WASHINGTON, 98264

NOT ONLY A TRADER BUT INCLUDES INTERESTING INFORMATION PLUS IT IS ENTERTAINING. YOU'LL LOVE IT! ORDER - TODAY!



## SATELLITE TV

BUY AT DEALER COST!

- 6' Ring Mount Systems \$ 799-\$ 999
- 6' Motorized Systems \$1199-\$1399
- 10' Motorized Systems \$1599-\$1799

SEND \$5.00 FOR HEFTY INFO-PAK. INCLUDES ILLUSTRATED FULL COLOR BOOK "SATELLITE TV & YOU", COMPLETE CATALOG OF ALL SYSTEMS, SAMPLE TEN STEP ILLUSTRATED DO-IT-YOURSELF INSTALLATION GUIDE & LATEST PROGRAM GUIDE LISTING OF WHAT'S UP THERE - OVER 100 SATELLITE TV CHANNELS!

SATELLITE EXPRESS, INC.  
162 Hubbard Way, Suite F,  
(Dept. 21) Reno, NV 89502



or call  
(415) STV-DISH

CIRCLE 137 ON READER SERVICE CARD

### COLLINS KWM-380 KEYBOARD

Pipo Communications Has The Keyboard That Is Used With The Collins KWM-380 For Remote Entry.

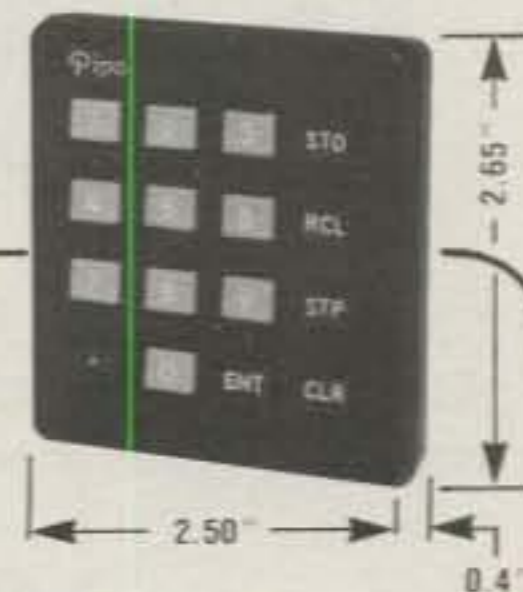

KEYBOARD-MOUNTING FRAME & SHIPPING \$25  
To know more about our Touch-Tone™ Encoders, CALL OR WRITE FOR FREE CATALOG & INFORMATION GUIDE.

Pipo Communications  
P.O. Box 3435 • Hollywood, CA 90078  
213/852-1515

\*AT&T

**Pipo Communications**  
Emphasis is on Quality & Reliability

CIRCLE 21 ON READER SERVICE CARD

## Radio Amateur Callbook Publications

Radio Amateur Callbook is presenting three new publications for 1986. The *North American Callbook*, the *International Callbook*, and the *Callbook Supplement* will provide current QSL information for over 880,000 radio amateurs throughout the world. Published on December 1, 1985, the new *1986 North American Callbook* lists the licensed amateurs in all countries in North America plus those in Hawaii and U.S. possessions. Also featured are international postal information, world-wide QSL bureaus, census of radio amateurs around the world, and more. Also published on December 1st, the *International Callbook* lists the calls, names, and address information for licensed amateurs in all countries outside North America. All the traditional *Callbook* "extras" are included. The *1986 Callbook Supplement* is a new concept in *Callbook* updates. To be published June 1, 1986, the new supplement will list the combined activity in both the *North American Callbook* and the *International Callbook* for the preceding 6 months. One supplement will give new licenses, address changes, and "then and now" call changes from countries around the world.

For more information, contact Radio Amateur Callbook, Inc., 925 Sherwood Drive, Box 247, Lake Bluff, IL 60044, or

circle number 104 on the reader service card.

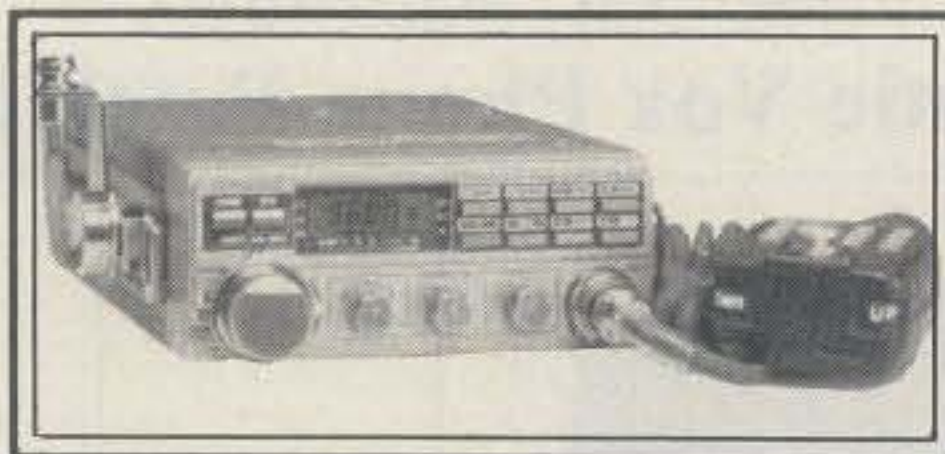

### Kenwood TR-50 Transceiver

The Kenwood TR-50 is a battery-pack mobile/portable 1200 MHz FM transceiver that covers from 1260-1300 MHz with a 1 watt output transmitter, repeater offset with reverse switch, five memory channels, programmable scanning, memory scan, a priority alert function, and RIT. "Odd splits" operation is possible using memory channel five. The multi-function LCD panel indicates frequency, VFO A/B, repeater offset, S/R/F/battery condition, and other keyboard functions.

The TR-50 comes complete with a rechargeable battery set and charger, shoulder strap, 16-key DTMF hand microphone, and an antenna on an adjustable mount. An external power cable is also included for mobile or base station supply operation. For more information, contact Trio-Kenwood Communications, 1111 West Walnut St., Compton, CA 90220, or circle number 106 on the reader service card.

## MFJ-1702 Two-Position Coaxial Switch

MFJ Enterprises, Inc. has introduced its two-position coaxial switch, the MFJ-1702. This switch has one pole, two output positions, and low insertion loss (less than 0.2 dB). Its maximum frequency range is 500 MHz, and it has less than 20 milliohms contact resistance SO-239 connectors. It has a VSWR of 1:1.2 and gets better than 60 dB isolation at 300 MHz and better than 50 dB at 450 MHz. The power rating is 2.5 kw PEP, 1 kw CW. Unused terminals are also automatically grounded for static/lightning/RF protection.

MFJ includes a one-year unconditional guarantee, and an additional 30-day money-back guarantee if the product is purchased directly from MFJ Enterprises, Inc. Cost of the MFJ-1702 is \$19.95 (plus \$5.00 shipping and handling). For more information, contact MFJ Enterprises, Inc., P.O. Box 494, Mississippi State, MS 39762, or circle number 107 on the reader service card.

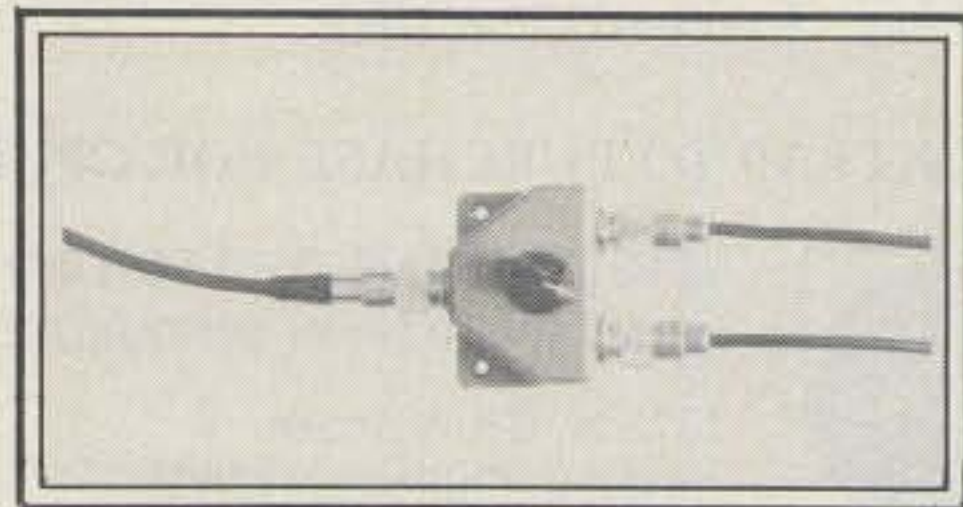

## 40/80 Meter Antenna Kit For "Perfect Dipole"

Quick Installation — Nothing Else to Buy

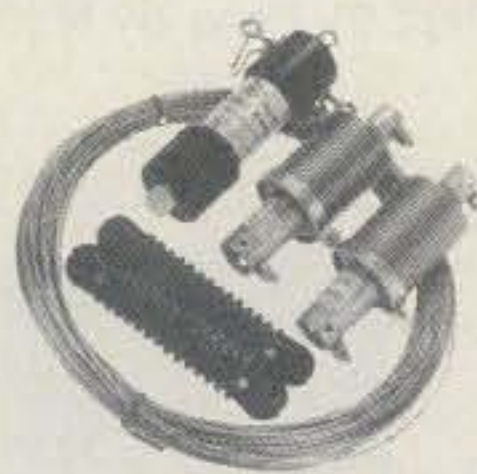
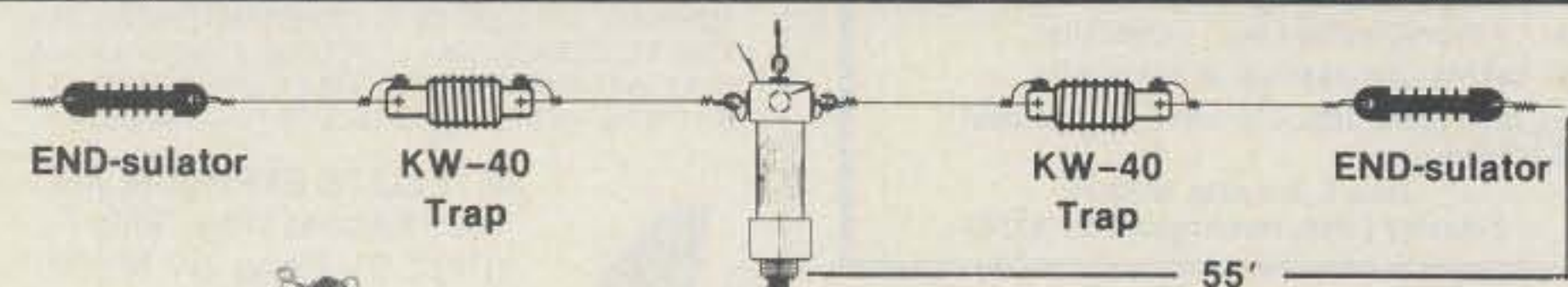

- Complete Kit**
- W2AU 1:1 Balun
  - Pair of W2VS KW-40 Traps
  - 125' #14-7 Copper Wire
  - Complete Installation & Pruning Instructions
- Free full line catalog shipped with each order.

Get "perfect dipole" (low SWR) operation on both bands, plus "second resonance" operation on 10, 15 and 20 meters. Complete instructions result in quick, accurate installation and pruning to low operating SWR.



Every component in the 40/80 meter kit is an old line, reliable UNADILLA product, time-tested with hams for at least 15 years!

**FREE** catalog describes a complete line of baluns, remote antenna relays and antenna traps in the 10-60 meter band.

## Order Your Antenna Kit Today!

Only \$65.00

Tax & UPS Shipping Included

Name \_\_\_\_\_  
 Address \_\_\_\_\_  
 City \_\_\_\_\_ State \_\_\_\_\_ Zip \_\_\_\_\_  
 Phone ( ) \_\_\_\_\_

- AmEx     VISA     Mastercard  
 Card # \_\_\_\_\_  
 Valid (AmEx only) \_\_\_\_\_  
 Expires \_\_\_\_\_  
 COD     Check     Money Order

To ORDER or request free catalog call  
**1-800-523-0027**

**24 HOURS-7 DAYS A WEEK!**  
 NY/HI/AK/CAN residents please use coupon  
 or call collect 315-437-3953, 8-5 EST

1 week delivery for credit card & C.O.D.,  
 2 weeks for personal check.

### 60 DAY MONEY BACK GUARANTEE

Unadilla/Reyco/InLine  
 Division of Microwave Filter Co., Inc.  
 6743 Kinne St., E. Syracuse, N.Y. 13057    **CQ10**

# MUST LIQUIDATE At Far Below Dealer Cost! TOTAL Personal Computer System

**Factory Reconditioned with  
Factory Warranty!**



**Carries easily  
as a suitcase!  
Plugs into 115V outlet!**

**GREAT GIFT IDEA  
FOR STUDENTS!**



**Sorry, we're not permitted to PRINT the famous brand-name.  
BUT, we CAN "tell all" if you call us TOLL FREE: 1-800-328-0609!**

## THE COMPUTER

Snap-on computer keyboard! 64K RAM, 20K ROM. Full-size typewriter keyboard. Upper and lower case letters, numerals, symbols, reverse characters. 2 cursor control keys, 4 function keys, programmable to 8. Music synthesizer with 3 independent voices, each with 9 octave range. Input/output ports accommodate . . . user, serial, ROM cartridge, joysticks, external monitor, phone modem.

**Built-in disk drive!** Intelligent high speed unit with 5 $\frac{1}{4}$ " floppy disk recorder. 170K formatted data storage; 35 tracks. 16K ROM. Uses single sided, single density disk. Serial interface. Second serial port to chain second drive or printer.

**Built-in color monitor!** Displays 40 columns x 25 lines of text on 5" screen. High resolution. 320 x 200 pixels. 16 background, character colors.

**Built-in ROM cartridge port!** Insert ROM program cartridge. Multitude of subjects available in stores across the nation!

Original List Price . . . . . **\$995.00**  
**Liquidation Priced At Only** . . . . . **\$388**  
Item H-742-63631-00 Ship, handling: \$20.00

## THE PRINTER

Print method: Bi-directional impact dot matrix.  
Character matrix: 6 x 7 dot matrix.  
Characters: Upper and lower case letters, numerals and symbols. All PET graphic characters.  
Graphics: 7 vertical dots — maximum 480 columns. Dot addressable.  
Character codes: CBM ASCII code.  
Print speed: 60 characters per second.  
Maximum columns: 80 columns.  
Character spacing: 10 characters per inch.  
Line feed spacing: 6 lines per inch in character mode or 8 lines per inch selectable. 9 lines per inch in graphics mode.  
Line feed speed: 5 lines per second in character mode. 7.5 lines per second in graphics mode.  
Paper feed: Friction feed.  
Paper width: 4.5" to 8.5" width.  
Multiple copies: Original plus maximum of two copies.  
Dimensions: 13"W x 8"D x 3 $\frac{1}{4}$ "H. Wt.: 6 $\frac{1}{2}$  lbs. Power: 120V AC, 60 Hz.

Original List Price: **\$200.00**  
**Liquidation Priced At** . . . . . **\$118**  
Item H-742-63831-00 Ship, handling: \$7.00

## THE SOFTWARE

**"Easy Script"** One of the most powerful word processors at any price! Cut re-typing, create documents from standard paragraphs, do personalized letters, see and change a document before it is printed. Instruction manual has extensive training section that simplifies use . . . even for someone who has never used a computer or word processor before!  
**"The Manager"** A sophisticated database manager for business or home use. Business uses: accounts payable/receivable, inventory, appointments, task manager. Home uses: mailing lists, home inventory, recipes, collection organizer, investment tracking, checkbook balancing. School uses: research article index, gradebook.

Original List Price: **\$73.98** **\$24**  
**Liquidation Price** . . . . .  
Item H-742-64011-03 Ship, handling: \$3.00

**BUY INDIVIDUAL UNITS OR  
GET THIS ULTRA-FAMOUS  
SYSTEM AT ONE LOW  
PACKAGE PRICE!**  
**TOTAL Personal Computer System  
available at FAR BELOW dealer cost!**

Original List Price . . . . . **\$1,293.00**  
**TOTAL PACKAGE PRICE** . . . . . **\$488**  
Item H-742-64011-02 Ship, handling: \$24.00

Compatible with above Computer System (Not included in package price.)

**JOYSTICKS (Set of 2)**  
Mfr. List: \$59.90 pr. **\$18** pr.  
Liquidation Price . . . . .  
Item H-742-63622-00 S/H: \$6.00 pr.

**64 MODEM**  
Mfr. List: \$124.95 **\$44**  
Liquidation Price . . . . .  
Item H-742-63646-00 S/H: \$4.00



Credit card members can order by phone,  
24 hours a day, 7 days a week.

**Toll-Free: 1-800-328-0609**

**TeleCheck** Your check is welcome!  
No delays when you pay by check!

**C.O.M.B. CO.®**  
**Authorized Liquidator**  
14605 28TH AVENUE NORTH  
MINNEAPOLIS, MINNESOTA 55441-3397

**SEND ME THE ITEMS I HAVE LISTED BELOW**

Price subject to change after 60 days. Sales outside continental U.S. are subject to special conditions. Please call or write to inquire.

Item No.	#	Item	Price	S/H
<b>TOTAL</b>				

**C.O.M.B. CO.®** Item H-742  
14605 28th Ave. N./Minneapolis, MN 55441-3397

Send the items indicated at left. (Minnesota residents add 6% sales tax. Please allow 3-4 weeks delivery. Sorry, no C.O.D.)

My check or money order is enclosed. (No delays in processing orders paid by check, thanks to TeleCheck.)  
Charge:  MasterCard®  VISA

Acct. No. \_\_\_\_\_ Exp. \_\_\_\_\_

**PLEASE PRINT CLEARLY**

Name \_\_\_\_\_

Address \_\_\_\_\_

City \_\_\_\_\_

State \_\_\_\_\_ ZIP \_\_\_\_\_

Phone \_\_\_\_\_

Sign here \_\_\_\_\_

# CQ World-Wide DX Contest All-Time Phone Records

BY FREDERICK CAPOSSELA, K6SSS

In the records listed below, boldface listings denote world records. Number groups after calls are: year of operation, total score, contacts, zones, and countries. All-band and Multi-Operator records include a band-by-band breakdown of the world leader in each category.

## Single Operator/Single Band WORLD RECORD HOLDERS

1.8	UP2BBT/U6V('83)	203,416	1,490	8	39
3.5	YV3AZC('84)	351,324	1,238	26	82
7.0	EA8AK('84)	776,700	1,736	35	115
14	VP2KAA('81)	2,011,185	4,186	37	150
21	AH0AB('82) (Opr. JA3DOC)	1,923,840	4,509	36	108
28	YV2AMM('82)	1,839,004	3,700	37	130

### AFRICA

1.8	EA8AK('82)	34,220	201	12	46
3.5	CT3BZ('79)	235,113	772	22	87
7.0	EA8AK('84)	776,700	1,736	35	115
14	CR6WW('74)	1,058,446	2,152	35	132
21	EL2AV('81)	1,404,936	3,087	35	117
28	OH2MM/CT3('79)	1,827,150	4,068	37	113

### ASIA

1.8	UP2BBT/U6V('83)	203,416	1,490	8	39
3.5	UW9AF('83)	222,192	554	19	53
7.0	4Z4DX('81)	241,368	721	26	87
14	N2BZQ/4X('82)	1,142,964	2,347	36	135
21	4S7AAG('81) (Opr. OH2BCP)	918,925	2,897	38	137
28	4X0U('80) (Opr. 4X4UH)	1,187,200	2,555	37	123

### EUROPE

1.8	LZ2CJ('84)	107,818	1,319	13	61
3.5	YT3A('82) (Opr. YU3DM)	154,972	806	28	84
7.0	IO3MAU('83)	355,000	1,447	31	94
14	I5NPH('80)	1,062,936	2,429	37	134
21	LZ2KTS('83) (Opr. LZ2CC)	1,368,897	2,821	39	152
28	9H1EL('81)	1,355,760	3,662	36	132

### NORTH AMERICA

1.8	KV4FZ('76)	37,584	380	11	37
3.5	NE4G/6Y5('84)	278,520	1,221	27	83
7.0	XN3BMV('84)	546,615	1,882	31	104
14	VP2KAA('81)	2,011,185	4,186	37	150
21	VP2KAC('81)	1,783,500	3,941	37	137
28	KV4FZ('79)	1,482,525	4,079	39	126

### OCEANIA

1.8	VK6HD('83)	5,363	62	11	20
3.5	KH6XX('82)	161,622	773	27	46
7.0	T32AF('84) (Opr. KH6UR)	677,844	2,045	34	80
14	ZM1BIL('83)	1,334,232	2,635	38	136
21	AH0AB('82) (Opr. JA3DOC)	1,923,840	4,509	36	108
28	AH0B('82) (Opr. JA2VUP)	1,788,430	4,173	36	109

### SOUTH AMERICA

1.8	YV2IF('84)	18,291	172	14	25
3.5	YV3AZC('84)	351,324	1,238	26	82
7.0	9Y4VU('84)	700,488	1,718	28	110
14	FY7AK('76) (Opr. F5QQ)	1,415,329	2,950	36	127
21	CX4CR('82)	1,602,120	3,519	36	120
28	YV2AMM('82)	1,839,004	3,700	37	130

## Single Operator/All Band

AF	EA8AK('81)	9,974,811	5,506	152	457
AS	EX6F('84)	6,362,000	4,648	113	387
EU	YU3EY('82)	4,913,574	3,170	136	455
NA	HI8PGG('81) (Opr. N1GL)	9,009,721	7,190	131	392
O	KH6XX('81)	5,713,434	4,912	131	262
SA	9Y4VT('82) (Opr. N6AA)	11,954,696	7,082	146	422
QRP	TG9GI('82)	1,035,693	1,747	75	192

## Multi-Operator/Single Xmtr.

AF	ED9CM('83)	10,157,160	5,148	152	511
AS	RG6G('82)	12,276,352	6,012	156	558
EU	I4RYC('80)	9,918,368	5,997	139	453
NA	NP4A('82)	14,953,818	8,772	174	585
O	KC6ZR('80)	7,605,360	6,197	137	283
SA	9Y4W('82)	16,775,034	8,097	158	540

## Multi-Operator/Multi-Xmtr.

AF	EA8CR('77)	21,351,898	10,290	153	544
AS	EW6V('82)	18,746,136	10,100	142	544
EU	OH0W('82)	19,030,501	10,773	188	729
NA	VP2KC('79)	37,770,012	17,767	175	677
O	KH6XX('79)	21,990,252	10,989	184	494
SA	P41C('81)	41,957,244	17,718	173	625

## WORLD RECORD

Station	Band	Contacts	Zones	Countries
	1.8	39	7	9
9Y4VT	3.5	404	17	57
(1982)	7.0	748	25	78
11,954,696	14.0	1,620	32	89
	21.0	1,476	34	96
	28.0	2,795	31	93
Total		7,082	146	422

## WORLD RECORD

Station	Band	Contacts	Zones	Countries
	1.8	124	8	25
9Y4W	3.5	296	17	59
(1982)	7.0	594	27	86
16,775,034	14.0	1,953	35	127
	21.0	2,104	35	121
	28.0	3,026	36	122
Total		8,097	158	540

## WORLD RECORD

Station	Band	Contacts	Zones	Countries
	1.8	261	9	21
P41C	3.5	861	22	69
(1981)	7.0	1,752	30	98
41,957,244	14.0	4,837	38	156
	21.0	5,790	39	143
	28.0	4,813	35	138
Total		17,718	173	625



# HOTTER RIGS, BETTER ANTENNAS, BIGGER AMPS.

New rigs and old favorites, plus the best essential accessories for the amateur.

3621 FANNIN ST.  
HOUSTON, TX. 77004-3913

CALL FOR ORDERS  
1-713-520-7300 OR  
1-713-520-0550

ALL ITEMS ARE GUARANTEED OR SALES PRICE REFUNDED.

## EQUIPMENT

KENWOOD..... Call for prices on all Kenwood  
YAESU FRG9600 60-905MHZ RCVR... 499.00  
New Kantronics UTU-XT..... 19.00  
Icom IC735..... 749.00  
Four lot price IC-735..... 2800.00  
Ten-Tec 2510 Satellite..... 439.00  
Alpha..... List - 15%  
Icom 271A, 27a..... Call

## SERVICES

Alignment, any late model rig..... 50.00  
Flat fee Collins rebuild..... Call

## ACCESSORIES

Heil HC3/HC4/HC5..... Stock  
Heil BM10 Boom Mike headset..... 53.95  
Heil HCS Control Box/Interface..... 89.95  
CES 510 Smart Patch..... 349.00  
FLUKE 77 auto-ranging digital multimeter..... 115.00  
Shure 444D Mic..... 54.95  
Bird 43 Wattmeter..... Call  
Bird Elements, H/59.00; A-E/48.00; Special..... In Stock  
Ameco Pre-Amps..... 10% Off  
Daiwa CN620B, 20-200, 2000W..... 109.95  
Collins 500Hz Filter, F455J05, new..... 95.00  
Sanyo AA Nicads, tabs..... 2.50  
2, 4, 5, 6, 8 pin mic plugs..... 4.00  
Fox Tango..... - 10%  
Tenna Hitch  
By D.C. Sales, Fits Class 1, 2 Hitches. Adapts existing hitch on your car/truck to any HF antenna. 3/8 x 24 thread. No holes, complete unit..... 29.95

## KEYS

Bencher & Vibroplex..... Less 10%  
MFJ Super keyboard #496..... 199.95

## TUBES

GE6146B..... 11.95  
Eimac 3-500Z..... 109.95  
GE Industrial Tubes..... Call  
GE 12BY7A..... 6.00  
GE 6JS6C..... 11.95

## BOOKS

Hayden, Computer Programs for Amateur Radio..... 16.95  
We also stock SAMS, TAB, ARRL, RSGB, Radio Pubs..... Call  
CALRAD 65-287 SWR, Relative Power Meter..... 32.95  
3-150Mhz, KW +

## PACKET?PICKIT!

AEA PK64..... 199.00  
KANTRONICS PACKET..... 199.00  
CP100 vs. CP1 Worth the difference? Yes!!!..... Call



## ANTENNAS

AR2XB, V2S, 2MCV-5, ISOPOLE..... 44.95  
A4..... 289.95  
402CD..... 279.95  
New Cushcraft LAC-3 Lightning Arrestor. 7.95  
215WB New, 15EL, 2MBeam..... 79.95  
AOP-1, Complete Oscar Antenna..... 149.95  
Butternut HF6V, 80-10 Vertical..... 125.00  
HF2V, 80&40 Vertical..... 125.00  
HF3B Butterfly Antenna..... 169.95  
Hustler G7-144..... 119.95  
Barker & Williamson All Band Dipoles..... Less 10%  
Ham4 Rotator, T2X, CD45-2..... Call  
KLM HF World Class Series Antennas..... Call Don

## OTHER ANTENNAS

Larsen Kuldock..... 17.00  
Valor 75-10M complete mobil antenna AB-5..... 79.95  
Avanti ASP151 3G, thru glass 2M..... 33.00  
Anteco 2M, 5/8, Mag. Mount, Comp..... 25.00

## SURPLUS

2.5A/1000PIV  
Epoxy diode..... 29¢ Each or 19.00/100  
.0015/10KV..... 1.95  
3N201..... .95  
4 Inch ferrite rod..... 1.95

## BELDEN

9913 low loss, solid center, foil/braid shield..... 45¢/ft.  
8214 RG8Foam..... 43¢/ft.  
8237 RG8..... 40¢/ft.  
8267 RG213..... 52¢/ft.  
8000 14Ga stranded copper ant. wire .. 13¢/ft.  
8448 8 conductor rotor cable..... 31¢/ft.  
9405 Heavy duty, 2-16 Ga. 6-18 Ga. .... 52¢/ft.  
9258 RG8x..... 19¢/ft.  
8403 Mic Cable, 3 condctr & shield..... 80¢/ft.  
100 Feet 8214 w/ends installed..... 45.00  
8669 7/16" tinned copper braid..... 1.10/ft.  
International Wire RG214, non-mil, good cable..... .70/ft.

## AMPHENOL

831SP-PL259 Silverplate..... 1.25  
UG176 reducer RG8X..... .30  
831J Double Female UHF..... 2.00  
82-61 N Male..... 3.00  
82-97 N Female Bulkhead..... 3.00  
New 82-202-1006 N-Male fits 9913..... 5.00

## ROHN

1/4" E.H.S. Guy cable, Rohn US, 1000 ft..... 250.00  
3/16" E.H.S. cable..... 210.00  
1/4" Guy Cable, 6100#7 x 7 strand, import..... 15¢/ft.  
3/16" Guy Cable, 3700#7 x 7 strand, import..... 12¢/ft.  
3/8 x 6 E&J Turnbuckle..... 7.95  
3/16" Wire Rope Clips..... .40  
1/4" wire clips..... .50  
Porcelain 500D Guy Insulator (3/16)..... 1.69  
Porcelain 502 Guy Insulators (1/4)..... 2.99

## USED EQUIPMENT

All equipment, used, clean, with 90 day warranty and 30 day trial. Six months full trade against new equipment. Sales price refunded if not satisfied.

## POLICIES

Minimum order \$10.00. Mastercharge, VISA, or C.O.D. All prices FOB Houston, except as noted. Prices subject to change without notice. Items subject to prior sale. Call anytime to check the status of your order. Texas residents add sales tax. D'ats all, folks.

## SPECIAL TELEPHONE OFFER

Call our numbers and when you place your order, we'll deduct a dollar off it. And don't be shy. Ask tough questions. Our guys are more than order takers—they know the radios and the equipment.

## DON'S CORNER

We've noticed a recent trend that has some other dealers charging you a restocking fee and not offering a store warranty. At Madison, we strongly protest. A good radio deserves both a factory warranty and a store warranty. What good is a warranty if the store you bought it from won't honor it and, instead, always ships your unit back to the factory? Madison has always, always, backed everything we sell. We don't charge a restocking fee. We take care of the warranty. Our personal guarantee policy has been in effect for over 40 years—shouldn't this be the year you discover how much it means to you when you buy a new piece of gear?

Madison Ad Proofreading contest: 1st postcard with correct number of errors noted wins a Calrad SWR meter. No purchase necessary to enter.

73&Good DX  
DON

# MADISON

## Electronics Supply

3621 FANNIN  
HOUSTON, TEXAS 77004

1-713-520-7300  
OR  
1-713-520-0550

# dateline... Washington, D.C.

a regular feature by  
THEODORE J. COHEN, N4XX

## THE INS AND OUTS OF THE WASHINGTON SCENE

### Amateur Operators Participate in Emergency Communications Test

The National Communications System (NCS) has released the results of its latest Emergency Communications Test involving volunteer communications systems. Conducted on 21 and 23 March 1985, and dubbed *Night Tango IX*, the exercise was intended to evaluate the ability of volunteer operators in the Amateur service, in the Military Affiliate Radio System (MARS; Air Force, Army, and Navy/Marine Corps), and the Civil Air Patrol (CAP) to provide critical communications resources during a national emergency.

During the test four NCS representatives prepared messages from simulated senior government officials, and used the five volunteer radio systems to pass these messages. Of interest to the NCS were things such as message timeliness, message accuracy, NCS/Volunteer interfaces, and system reliability. In all, each NCS representative sent the other three representatives a message on each of the two exercise days; thus, a total of 24 messages were to be sent through the volunteer system. Because all locations did not have participating volunteers, however, only 84 transmissions of the 24 messages were attempted. Of these, 77 were received, for a total transmission reception rate of 92%. Army MARS scored the lowest in this area, with only 60% of the transmitted messages received, while amateurs received 90% of the messages. Air Force MARS and the CAP received all of the messages.

According to the NCS report, the average receipt time for the 77 transmissions was 1 hour and 45 minutes. The average time for messages sent through amateur volunteers was over two hours, but was not as bad as that observed for Air Force MARS (over three hours). The CAP and Navy/Marine Corps MARS had the best showing, with average receipt times of under one hour.

While it is tempting to compare the results obtained for this exercise with the results of other *Night Tango* exercises, the data for each exercise must be used

with caution. The number of variables in each exercise, including propagation effects and the availability of operators, can make it difficult to draw meaningful comparisons. Regardless, the report stated that all participating volunteers displayed a high degree of enthusiasm and that the operating procedures used in the volunteer systems continue to improve. The latter is particularly important, concluded the NCS, since such improvements will further enhance the ability of these systems to support national security and emergency preparedness requirements.

#### FCC Seeks League Assistance On Gauging Problems With Anti-Pilferage Devices

According to Jeffrey Young, Enforcement Division, Field Operations Bureau, FCC, the Commission recently asked the League's Amateur Auxiliary (i.e., the Official Observers) to assist in the collection of data on so-called "anti-pilferage devices." These low-power communication devices currently operate on 2, 4.5, and 8.2 MHz, and are used in retail stores across the country to catch shoplifters. Under General Docket 85-129, however, the Commission proposes to permit these devices to be used on any frequency between 1.6 and 10 MHz, with signal levels of up to 100  $\mu$ V/m at 30 m. As such, the potential for interference to amateur receivers is one of the issues being investigated.

In calling upon the Amateur Auxiliary, the FCC's intent was to identify amateurs living near anti-pilferage devices, and to obtain answers to the following four questions:

1. Approximate distance to the low-power transmitter?
2. Signal strength (or signal-to-noise) reading for the received signal?
3. Gain of the receiving antenna at 2, 4.5, or 8.2 MHz?
4. How objectionable would the signals be if they were found in an amateur band?

Data from the Amateur Auxiliary were to have been in the Commission's hands by the end of August, though the cutoff

date may have extended to ensure that sufficient data were available for analysis.

At this time, no studies have been made on the interference anti-pilferage systems might experience as a result of amateur transmissions. Regardless, the League, in its comments on the docket, requested that the anti-pilferage devices be prohibited from operating in the 160, 80, and 40 meter amateur bands, and that use of these devices be restricted to commercial, business, or industrial environments.

#### The "Paper Tiger" Has Teeth

In this era of "unregulation," the Commission has often been referred to as a "paper tiger." But according to Richard Smith, Chief, Field Operations Bureau (FOB), FCC, amateurs and manufacturers alike are finding out that the so-called "paper tiger" has sharp teeth.

One example of the Commission's continued enforcement efforts is the recent seizure of \$1 million in computer inventory that had been scheduled to be sold by auction at the Seequa Computer Corporation in Odenton, MD. The seizure capped a ten-month investigation into the marketing by Seequa of systems that did not meet FCC regulations for incidental radiation. Seequa was first issued a citation in October 1984 for marketing its Chameleon model without having followed FCC certification rules, said Richard Engelman, Chief, Investigations and Inspections Branch, Enforcement Division, FOB. And while the company did eventually receive a Grant of Equipment Authorization from the FCC, the models seized did not comply with the requirements of that grant.

A search warrant allowing the seizure of the equipment was issued as the result of a request through the U.S. Attorney's office in Baltimore. Personnel from the FCC Baltimore District Office, the FCC Laboratory, and the FCC's FOB headquarters participated in the search and seizure.

#### Engelman Named To FOB Post

Richard B. Engelman has been named Chief, Investigations and Inspections

Media Tech®, 8603 Conover Place, Alexandria, VA 22308

(I&I) Branch, Enforcement Division, FOB, FCC. Engelman, who received his B.S.E.E. from the Rose-Hulman Institute of Technology in Terre Haute, IN, joined the Commission in 1977, and participated extensively in regulatory matters pertaining to national and international broadcasting. Prior to his being named Chief of the I&I Branch, he was assigned to the FOB's Engineering Division, where he conducted technical studies that were used to determine the type of equipment needed by the Bureau's field activities to adequately enforce the Commission's rules and regulations.

Engelman holds an Amateur Extra class license as well as a private pilots license, and he lives in Alexandria, VA.

### AMRAD Assists Hearing Impaired In Using Computers

You would think that the availability of inexpensive home computers would be a boon to the hearing impaired. But it just isn't so! The reason is that a large installed base of telecommunications devices for the deaf (TDDs) already exists, and these devices use Baudot code. Computers, on the other hand, communicate using ASCII. Thus, those who switched from TDDs to computers risked being cut off from the majority of hearing-impaired persons who "talked with their fingers."

All that is changing, however, and one of the organizations responsible for the change is the Amateur Radio Research and Development Corporation (AMRAD). According to the "AMRAD Newsletter," members of the corporation, under a federal grant, have adapted several popular home computers to function as TDDs. In each case, the software and design data were made available to the public. Additionally, AMRAD has programmed one of the world's first "bilingual" bulletin boards. Known as HEX, for Handicapped Educational Exchange, the bulletin board accepts calls from either TDDs or computers. The corporation's bulletin board is now in its second generation of development, and serves as a clearing house for information on the use of computers to aid the disabled.

For more information on HEX and on AMRAD's activities in the area of TDD/computer compatibility, contact Richard Barth, W3HWN, c/o AMRAD, P.O. Drawer 6148, McLean, VA 22106-6148.

### NABER Creates Professional Organization For Radio Technicians

The National Association of Business and Educational Radio (NABER) has announced the establishment of the Association of Communications Technicians (ACT). A section of NABER, ACT has been developed to provide services that are specifically tailored to today's technician. Through ACT, technicians will be kept informed about technical information important to their profession and will

receive the direct benefits of membership designed to assist them in doing their job and advancing their careers.

The new association will have two levels of membership, general and senior. All communications technicians are eligible for general membership, while only NABER-certified technicians are eligible for senior membership. General members will receive, among other things, a year's subscription to *Business Radio*; a new quarterly technical newsletter, "TechTalk"; and discounts on various publications. Senior members of ACT receive all of the general member benefits plus life insurance, discounts on other forms of insurance, and other benefits.

For more information, write to NABER-ACT, P.O. Box 19164, Washington, DC 20036, or call the NABER Technician Services Office at (202) 833-3956.

### Cable TV Interests Continue To Push for Scrambling; Home Satellite Terminal Users Push for "Viewers' Rights"

In what could soon become a head-to-head confrontation before the U.S. Congress, cable television (CATV) interests are pushing the satellite transmission companies to scramble their signals at the same time that viewers are defending their "rights" to receive such signals. According to "CATACABLE," a monthly newsletter of the Cable Television Association, the marketing of small earth terminals for home use has shifted from rural markets to cable markets, where the main sales pitch is that you can "get something for free" by buying a home earth terminal instead of paying the cable

operator. The association apparently had no problem with the use of home earth terminals in rural markets, where the availability of television signals was limited, but finds the use of these terminals in areas served by its member operators a threat to the continued viability of their CATV systems. Scrambling, says Association President Carl Schmauder, would secure the signals, and would ensure that those who benefit from the services pay for them.

Meanwhile, a move is underway in the House of Representatives to block pay-television programmers from encoding their satellite signals. This ban would be imposed until such time that prices, terms, and conditions are established for marketing satellite signals to those with home earth terminals. According to *The Westlink Report*, however, pay programmers (such as HBO and Showtime) may be making contingency plans to terminate their satellite operators, and to switch instead to terrestrial microwave systems for signal distribution.

Further to the matter of marketing satellite signals, HBO has announced prices for direct home reception of its HBO and Cinemax satellite services (\$12.95 per month for each service, or \$19.95 per month for both), with the initial price of home decoders quoted at \$399. According to "CATACABLE," this has already resulted in a significant slowdown in home earth terminal sales.

Suffice it to say that the last chapter in the use of home earth terminals is yet to be written. Stay tuned for details.

Your Washington Editor thanks Steve Thompson, N4TX, for his contributions to this month's column.



**TUBES—2,000 TYPES  
DISCOUNT PRICES!**

New 20-pg. wholesale catalog for the radio collector/hobbyist. Antique, hard-to-find and modern tubes. Also transformers, capacitors and parts for tube equipment, and books, etc.

**Antique Electronic Supply**  
688 West First Street  
Tempe, AZ 85281

CIRCLE 145 ON READER SERVICE CARD

**This Month's Goody From The Candy Store**

**RDC**

**ICOM R-7000**  
Under \$800.00



**Limited Quantities** US or FOREIGN Callbook \$9.95  
**OVER 6500 HAM RELATED ITEMS IN STOCK**  
Send SASE, Call letters, name & phone #  
for NEW HF list.

**ROSS DISTRIBUTING COMPANY**  
78 South State Street, Preston, Idaho 83263  
Telephone (208) 852-0830 We Close at 2:00 on Mon&Sat

CIRCLE 36 ON READER SERVICE CARD

**IRON POWDER and FERRITE PRODUCTS**

**AMIDON**  
*Associates*

**Fast, Reliable Service Since 1963**

**Small Orders Welcome**      **Free 'Tech-Data' Flyer**

**Toroidal Cores, Shielding Beads, Shielded Coil Forms**  
**Ferrite Rods, Pot Cores, Baluns, Etc.**

**12033 OTSEGO STREET, NORTH HOLLYWOOD, CALIFORNIA 91607**

CIRCLE 31 ON READER SERVICE CARD

**REVOLUTIONARY!**

**New RTTY/CW Interface and Program Cartridge for the VIC-20, Commodore-64 and C-128!**

Check these **EXCLUSIVE** features not found in any other T/U!

- **Automatic RTTY scanning: Baudot 60-66-75-100-132 ASCII 110-300 plus Invert & repeat!**
- **Tape all incoming or outgoing data "on the fly" WHILE OPERATING!**
- **Tape or load at 16K/min rate! (Almost as fast as a disk.) Tape starts/stops automatically.**
- **Tape search! (Monitor displays only what you are searching for on tape.)**
- **Self Test! (No test equipment required for T/U check out.)**

**OTHER FEATURES**

Completely crystal controlled on transmit • Complete KYBD control, no switches • Screen display of operating modes and memory size • Automatic CW tracking 5-127 wpm • MSO (RBBS) program • Logging program • KYBD selectable HI/Low tone pairs to take advantage of filters in your receiver • Will operate CW, MCW, Break CW • CW speed lock • On-screen tuning indicator • Split screen • On-screen clock • Logging scratch pad • RTTY sync • Edit mode • 26 instant call-up message buffers plus memory filing system • In MSO (RBBS), user may assign read, write, list, & delete codes • Extra memory may be added for larger MSO, etc. • Memory can be scrolled, edited, re-transmitted, taped, etc. • Will also transmit number of bytes remaining in memory and time that is displayed on the screen.

Designed by amateurs for amateurs. Routines in this program were originally developed in 1974 by Charles "Merlin" Myer (W8VCF) and recently updated to state of the art. There are over 100 functions in this program (too many to list here). A professional glass epoxy circuit board, plates through holes, and gold tabs. One-year warranty. If you don't think this is the finest RTTY/CW/T/U Interface and program on the market, return it within 30 days for full refund (less shipping), no questions asked! T/U plugs into user port, program cartridge plugs into expansion port. No hidden extras to buy. The only thing you need to supply is a microphone and audio connector to match your rig! Compare our price and specifications to units costing over \$300.00!

**ORDER: CM-20 (for Vic-20) \$124.95**  
**CM-64 (for C-64) \$124.95**  
**CM-128/64 (for C-128) \$124.95**  
 (add \$3.50 for shipping & handling)  
 Mich. residents add 4% sales tax

**Newsome Electronics**  
 19675 Allen Rd.  
 Trenton, Michigan 48183  
 (313) 479-2100

**1985 CQ WW WPX CW Contest High-Claimed Scores**

The following scores are early-bird high-claimed scores as of 28 July 1985. These are raw scores subject to verification.

U.S.A.	
SINGLE OPERATOR ALL BAND	
KT3Y	3,161,018
KC1F	3,143,868
KQ2M	3,002,510
K1GQ	2,767,273
KI6P	2,684,710
K3ZO	2,406,624
NR5M	2,340,849
W3GM	1,809,900
K1XA	1,548,960
K5RX	1,482,984
K4JPD	1,452,816
K1VUT	1,403,116
KM9L	1,358,048
N6ICV	1,140,300
AJ6V	985,520
K7LXC	925,290
WA2OOS	887,698
WA6AUE	795,872
KM8L	753,753
N4KMY	8,592
28 MHz	
KE5CV	5,566
NU4Y	5,467
W8AKS/6	288
21 MHz	
KA5W	64,750
KS9J	11,616
N0BSH	8,094
14 MHz	
N2AA	1,658,469
K2TW	1,324,430
A17B	1,247,290
N1CQ	1,089,900
W5WUMU	1,037,993
W5FO	854,104
N3BJ	852,202
7 MHz	
N5RZ	1,754,664

KR2Q	1,555,910
K1MM	1,397,400
KZ2S	1,179,288
NI6W	1,043,526
KM3T/2	911,820
AA6XX	451,200
3.5 MHz	
N2AU	120,990
NE6I	52,628
KJ9D	27,178
WB6JMS	25,020
K3TW	19,680
NV6O/2	2,236
1.8 MHz	
K5UR	13,668
KA1SR	884
MULTI-OPERATOR SINGLE TRANSMITTER	
NA5R	3,919,662
A16V	2,781,341
WC4E	2,510,224
N7TT	3,357,161
KU2C	2,172,942
AK6A	1,891,998
NU6S	1,740,409
NI8V	1,710,308
WC6I	1,472,472
AK6T	1,010,322
MULTI-OPERATOR MULTI-TRANSMITTER	
NM5M	4,325,412
K6XO	504,144
QRP/p	
KA2AEV A	232,349
W8VSK A	162,150
KB7G 14	54,284
AA2U 7	57,814
DX SINGLE OPERATOR ALL BAND	
YZ4GD	3,870,272

5Z4MX	2,922,318
OK1RI	2,660,690
DF9ZP	2,014,956
IK2DVG	2,014,880
6Y6A	1,756,800
VE3CRG	1,638,226
KG6DX	1,562,160
CE3DNP	1,492,705
OH6LI	1,423,800
AH6AZ	1,279,047
HB9CSA	1,159,640
OH2PM	1,107,447
JH1OGC	1,096,077
JE6MQW	910,316
VK2APK	902,598
OK3ZMV	888,336
VE3DZV	817,544
EG7TH	740,885
HP1XKR	704,245
28 MHz	
YO3KWJ	96,882
4M7QP	15,972
OH2EJ	12,610
SM0COP	10,191
SM5DUT	8,988
21 MHz	
YT3L	515,619
G4CNY	343,226
JA1ZLO	107,334
E11DP	80,029
JW0EQ	63,525
14 MHz	
YX5A	3,042,480
JA0DAI	1,109,745
VE6CB	1,035,386
OH3KM	807,311
YU7BJ	714,560
JH1AEP	709,198
7 MHz	
YZ9A	1,920,960
T32AF	1,255,918
OH2BH	1,253,600
OH6EI	1,122,590
YT3T	971,520

JA5BJC	736,764
DK2OY	600,320
3.5 MHz	
I4IND	526,812
YU1ZZ	341,205
VE3BMV	313,838
CF7SK	226,080
VE1AIH	92,964
OH2BCI/OH0	77,616
1.8 MHz	
LA7JO	25,748
VE3MFA	23,302
VE3INO	22,272
VE3OME	19,872
PA3BFM	6,192
MULTI-OPERATOR SINGLE TRANSMITTER	
HH2WW	5,062,500
GB2MM	3,562,503
IO3FIY	2,942,294
JA3YBF	2,607,084
OH1AF	2,507,490
OG3AA	2,459,200
IO2UIY	2,445,232
JE2YRD	2,161,072
7S7SSA	2,031,928
8J7ITU	1,600,902
MULTI-OPERATOR MULTI-TRANSMITTER	
KH6XX	8,564,616
KL7Y	6,486,053
QRP/p	
YU7RU A	236,106
4X6IF A	233,636
4X6NM 21	89,080
OK8ACW 14	52,640
YO4DCF 7	23,184
SP9GKM 3.5	17,956

NOTE: Queries pertaining to the WPX Contest should be sent to N8BJQ via CQ Magazine, 76 N. Broadway, Hicksville, NY 11801.



**IMPROVE YOUR FT-980!**

For super-selectivity replace your stock filters with a matched pair of genuine 8-pole Fox Tango units. All drop-in easily except replacement for ceramic. Complete instructions.

**SUPERIOR FT-980 FILTER REPLACEMENTS**

2.1KHz (SSB) sub for XF-8.9HSM	\$ 60 ea.
2.1KHz (SSB) sub for CFM-455J1 ceramic	\$100 ea.
250 or 500Hz (CW) sub for XF-8.9HC	\$ 60 ea.
500Hz (CW) sub for XF455.8MCN	\$ 75 ea.

**DISCOUNT:** 10% off any 2 or more of above.  
**SHIPPING:** \$3 US, \$5 Air (US & Canada), \$10 Elsewhere  
 Order by mail or phone • VISA/MC or COD accepted  
 Ask About Our Filters For Many Other Rigs.

**FOX-TANGO Corp.**

Box 15944, W. Palm Bch, FL 33416  
 Telephone: (305) 683-9587

CIRCLE 85 ON READER SERVICE CARD

**HAZER YOUR ROHN 25 G Tower**

- Antenna and rotator mount on HAZER, complete system trans tower in verticle upright position.
- Safety lock system on HAZER operates while raising-lowering & normal position. Never can fall.
- Weight transferred directly to tower. Winch cable used only for raising & lowering. Easy to install and use.
- Will support most antenna arrays.
- High quality materials & workmanship.
- Safety - speed - convenience - smooth travel.
- Complete kit for 50' or less tower includes winch, cable, hardware and instructions.

Hazer 2-Heavy duty alum. 12 sq ft. load \$297.00 ppd.  
 Hazer 3-Standard alum. 8 sq ft. load 213.00 ppd.  
 Hazer 4-Heavy galv. steel. 16 sq ft. load 278.00 ppd.  
 Ball thrust bearing TB-25 for any of above 42.50 ppd.  
 As an alternative, purchase a Martin M-13 or M-18 aluminum tower engineered specifically for the HAZER system.

**GLEN MARTIN ENGINEERING INC.**  
 P.O. Box C 253 Boonville, Mo. 65233  
 816-882-2734



CIRCLE 35 ON READER SERVICE CARD

**CW WILL NEVER BE THE SAME!**

The "Kansas City Keyer" Model KC-1 is a microprocessor based keyer with 1500 characters of memory, analog and digital speed controls, flexible serial no. generator, tune function, auto space, WPM function, paddle reversal, QRZ loops, beacons, variable weighting, editing, plus much more.

**ANYONE CAN USE IT!**

The KC-1's EPROM contains user-friendly software that enables you to utilize all of the system's features with ease. Our manual shows you how to automate most of your CW contest operating.

**SEND FOR BROCHURE!**

Send us your name and address for a detailed description of the Kansas City Keyer KC-1 and its accessories.

CIRCLE 127 ON READER SERVICE CARD



**\$199.95**  
 (Special Introductory Price)  
 includes cables and power supply

**LANCE JOHNSON ENGINEERING**  
 P.O. BOX 7363  
 KANSAS CITY, MISSOURI 64116



## ASTRON POWER SUPPLIES

• HEAVY DUTY • HIGH QUALITY • RUGGED • RELIABLE •

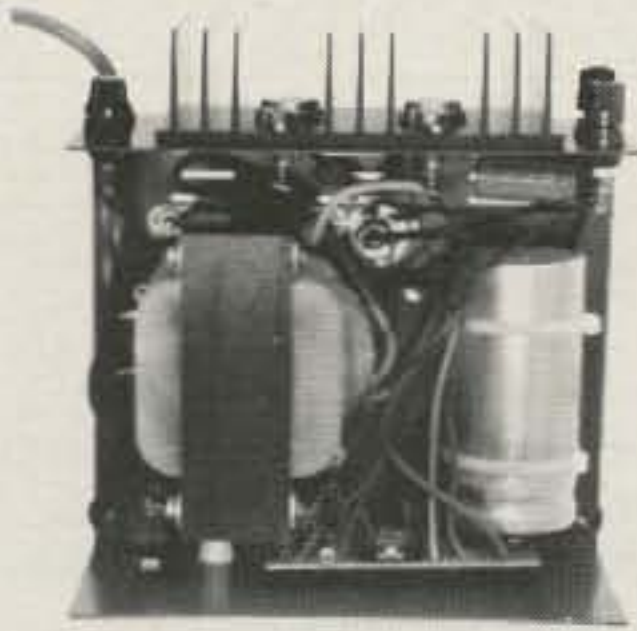

INSIDE VIEW - RS-12A

### RS and VS SERIES SPECIAL FEATURES

- SOLID STATE ELECTRONICALLY REGULATED
- FOLD-BACK CURRENT LIMITING Protects Power Supply from excessive current & continuous shorted output.
- CROWBAR OVER VOLTAGE PROTECTION on all Models except RS-4A.
- MAINTAIN REGULATION & LOW RIPPLE at low line input Voltage.
- HEAVY DUTY HEAT SINK • CHASSIS MOUNT FUSE
- THREE CONDUCTOR POWER CORD
- ONE YEAR WARRANTY • MADE IN U.S.A.

### PERFORMANCE SPECIFICATIONS

- INPUT VOLTAGE: 105 - 125 VAC
- OUTPUT VOLTAGE: 13.8 VDC ± 0.05 volts (Internally Adjustable: 11-15 VDC)
- RIPPLE: Less than 5mv peak to peak (full load & low line)



MODEL RS-50A



MODEL RS-50M



MODEL VS-50M

### RM-A Series



MODEL RM-35A

### 19" X 5 1/4" RACK MOUNT POWER SUPPLIES

Model	Continuous Duty (AMPS)	ICS* (AMPS)	Size (IN) HxWxD	Shipping Wt. (lbs.)
RM-35A	25	35	5 1/4 x 19 x 12 1/2	38
RM-50A	37	50	5 1/4 x 19 x 12 1/2	50
• SEPARATE VOLT & AMP METERS				
RM-35M	25	35	5 1/4 x 19 x 12 1/2	38
RM-50M	37	50	5 1/4 x 19 x 12 1/2	50

### RS-A SERIES



MODEL RS-7A

MODEL	Continuous Duty (Amps)	ICS* (Amps)	Size (IN) H x W x D	Shipping Wt (lbs)
RS-4A	3	4	3 3/4 x 6 1/2 x 9	5
RS-7A	5	7	3 3/4 x 6 1/2 x 9	9
RS-7B	5	7	4 x 7 1/2 x 10 3/4	10
RS-10A	7.5	10	4 x 7 1/2 x 10 3/4	11
RS-12A	9	12	4 1/2 x 8 x 9	13
RS-20A	16	20	5 x 9 x 10 1/2	18
RS-35A	25	35	5 x 11 x 11	27
RS-50A	37	50	6 x 13 3/4 x 11	46

### RS-M SERIES



MODEL RS-35M

- Switchable volt and Amp meter

MODEL	Continuous Duty (Amps)	ICS* (Amps)	Size (IN) H x W x D	Shipping Wt (lbs)
RS-12M	9	12	4 1/2 x 8 x 9	13
RS-20M	16	20	5 x 9 x 10 1/2	18
RS-35M	25	35	5 x 11 x 11	27
RS-50M	37	50	6 x 13 3/4 x 11	46

### VS-M SERIES



MODEL VS-20M

- Separate Volt and Amp Meters
- Output Voltage adjustable from 2-15 volts
- Current limit adjustable from 1.5 amps to Full Load

MODEL	Continuous Duty (Amps)			ICS* (Amps) @ 13.8V	Size (IN) H x W x D	Shipping Wt (lbs)
	@ 13.8VDC	@ 10VDC	@ 5VDC			
VS-20M	16	9	4	20	5 x 9 x 10 1/2	20
VS-35M	25	15	7	35	5 x 11 x 11	29
VS-50M	37	22	10	50	6 x 13 3/4 x 11	46

### RS-S SERIES



MODEL RS-12S

- Built in speaker

MODEL	Continuous Duty (Amps)	ICS* Amps	Size (IN) H x W x D	Shipping Wt (lbs)
RS-7S	5	7	4 x 7 1/2 x 10 3/4	10
RS-10S	7.5	10	4 x 7 1/2 x 10 3/4	12
RS-10L(For LTR)	7.5	10	4 x 9 x 13	13
RS-12S	9	12	4 1/2 x 8 x 9	13
RS-20S	16	20	5 x 9 x 10 1/2	18

## INFO ON AMATEUR RADIO LICENSING

### The Test Session

**T**he hardest decision that volunteer examiners make is deciding to hold their very first amateur radio operator examination session. While it is true that there is a big difference between assisting at a test and being the Contact VE, it really is quite a simple process. The mechanics are pretty much the same no matter with which VEC a volunteer examiner is accredited. Here are the steps.

#### Lining Up the VE's

You must have a minimum of three *accredited* volunteer examiners to hold an examination session. Our VEC program only accredits Extra class amateurs. Some VEC programs accredit Advanced class amateurs to administer certain lower class examinations. At this writing, the FCC only allows Extra class amateurs to administer *any* of the Morse code examinations above the Novice level.

Many VE's set up an organized testing group complete with a team name. Since we divide "expense recoupment" (test fees) with our volunteer examiners, many of our VE teams establish bank accounts in the name of their test team to make handling of the funds easier.

We recommend a minimum of four VE's (and preferably more) on a testing team to provide at least one alternate in the event of emergencies, sickness, or other unforeseen events that might preclude a VE from being in attendance. You also should consider the use of "assistants" to help during the session. These assistants or "helpers" need not be accredited VE's and can hold any class license. There is certainly plenty to do if anyone wants to get involved in amateur radio operator testing.

VE's from other VEC programs are eligible to participate in a test session, but they must be approved by the VEC coordinating the examination. This usually only involves sending a signed statement or application along with a copy of the VE's amateur radio operator license.

It is contrary to FCC rules to use VE's from other VEC programs without prior VEC accreditation. Allow time—at least two *additional* weeks—before your scheduled test session to get more VE's accredited, since this is a separate process.

#### Scheduling the Session

Once you have the required number of volunteer examiners, the next step is to determine when and where you want to hold the examinations. Most of the examinations that we coordinate seem to be held in public locations, such as a meeting room in a municipal, school, or industry facility. To the best of our knowledge, no one has paid for a testing locations thus far. Many testing sessions are also held in conjunction with hamfests, club meetings, and amateur radio operator training classes.

You will also want to make a decision on whether you want to schedule just one test session or hold examinations on a repetitive basis. Cities with populations exceeding 100,000 ideally should have monthly exams available. Quarterly examinations in smaller cities should be adequate.

One of the advantages of the new volunteer program is that tests are now usually administered during the evening or weekends. The FCC, of course, gave them during regular business hours. Contrary to what you may have heard, there really is *not* a shortage of amateur exams—only VE's to come forward and administer them. The good news is that at this point it appears that volunteers will administer *double* the number of amateur tests in 1985 as the FCC did in 1984, their last year of testing!

A word about holding upgrade tests at amateur gatherings. The only fee you charge an applicant is the *one* test fee, usually \$4.00 and *no more*! The amount of the test fee is determined by the VEC. A test candidate cannot be required to pay an additional admission charge to the amateur gathering, nor can an applicant be charged more than one test fee regardless of the number of examinations administered. An applicant who upgrades at a hamfest from Novice to Extra class pays only one fee and *cannot* be required to pay the admission charge to the hamfest.

It is also required that the VE team make a public announcement of the upcoming amateur examinations. This can be in any form, including a club newsletter release, announcement on a local repeater, and even a posted notice at the local amateur radio equipment supplier.

Once you have determined the test site and date, then you must decide whether you want to require applicants to

submit their applications (FCC Form 610) in advance or at the test session. Be aware that some VEC's require advance registration, or no walk-ins. As a general rule, we advocate paying the test fee at the examination session and allowing walk-in candidates. Some VEC's require that the test-fee check be made out to them. Since we split these fees with our VE's, we recommend that the fees be made payable to the testing team, who in turn reissues a check to us for the VEC share.

#### Retaking Failed Examinations

The FCC still has a rule, at this writing, that requires a 30-day wait before retaking a failed examination. The FCC has, however, empowered VEC's to grant waivers of this rule for *any* good reason. Such a reason might be that it has been only 27 days since the last examination session in a candidate's area. A letter from the applicant requesting a waiver of the "30 day rule" must be attached to the application and sent to the VEC. This letter must explain the reason for requesting the waiver. Granting of the waiver is at the discretion of the VEC. If approved, the "request for waiver letter" will eventually be forwarded to the FCC's licensing facility in Gettysburg along with the applicant's application.

#### VEC Advised of the Test Session

It is now time to write and advise the VEC that you need test session instructions and materials. The VEC will want to know when you have scheduled the test session and certain other information. We require notification *only* of the date and city and state in which the examination will be held, plus the name, address, and telephone number of the "contact" VE with whom we will be working. Allow the VEC time to get you the needed test materials. We recommend 30 days advance notice, although we can act on less if need be. While we can even handle test notifications by telephone, we prefer that it be done in writing.

The Contact VE whom we deal with is the volunteer examiner who operates as liaison between the testing team and the VEC. Other VEC organizations may require additional information such as the names of the accredited VEs, the exact test location, session sponsors, various test parameters, and on and on. We try to

keep it as simple and streamlined as possible. Some VECs don't. If we can get along without additional pieces of paper, we do.

### VEC Acts on VE Request

The VEC will forward the Contact VE the needed session forms and tests. Different VEC's have different systems for handling this. Our system is to simply forward what we call a preassembled "session packet" to the Contact VE. This packet contains three different copies of each test to be administered, plus the needed forms (there are only two) and an instruction booklet. This booklet is only 16 typewritten pages long and is updated about once every 60 days to conform to recent changes in the VEC program and FCC rules. It tells the VE team everything they have to know to conduct the session.

Additional copies of the written tests to be administered are photocopied or printed by the VE as needed from the "masters" that we forward. We also send along a Novice examination in the event it is needed. The Novice examination is not really part of the new volunteer examination program, but we frequently find that VE's need it to administer as a prerequisite to giving higher-class examinations. While an applicant need not pass the 5 or 13 wpm Morse code test if he can pass 20 words per minute, *all* written tests must be administered and passed in order.

Some VEC's provide a quantity of FCC Form 610 applications. Others do not. We send along one "610" with instructions that the VE's may photocopy or print it for use at their session, or they should order additional copies from the local FCC field office.

### The Morse Code Test

Actually, according to the rules this is the responsibility of the VE team, not the VEC. Every VEC has code test tapes available, however. Many VE's can generate their own 5, 13, or 20 word per minute code test using their personal computers. We have a 13 wpm and a 20 wpm test tape available (at a cost of \$2.50 plus 50¢ postage each) that contains 10 different QSO type tests that run for 5 minutes each. The VE simply asks 10 multiple-choice or fill-in-the-blank questions about the QSO or requires the applicant to copy for one minute solid. The format of the code test is at the option of the volunteer examiner. No sending test is required, but the VE can require one if he feels it important. As you can see, we give our VE's a lot of latitude.

### Administering the Test

Now that you have the test session lined up and the test materials on the way, you are ready for the big day! Next month we cover *How to administer the test*, what to send the VEC, and what he does with it.

# Wanna' trade?

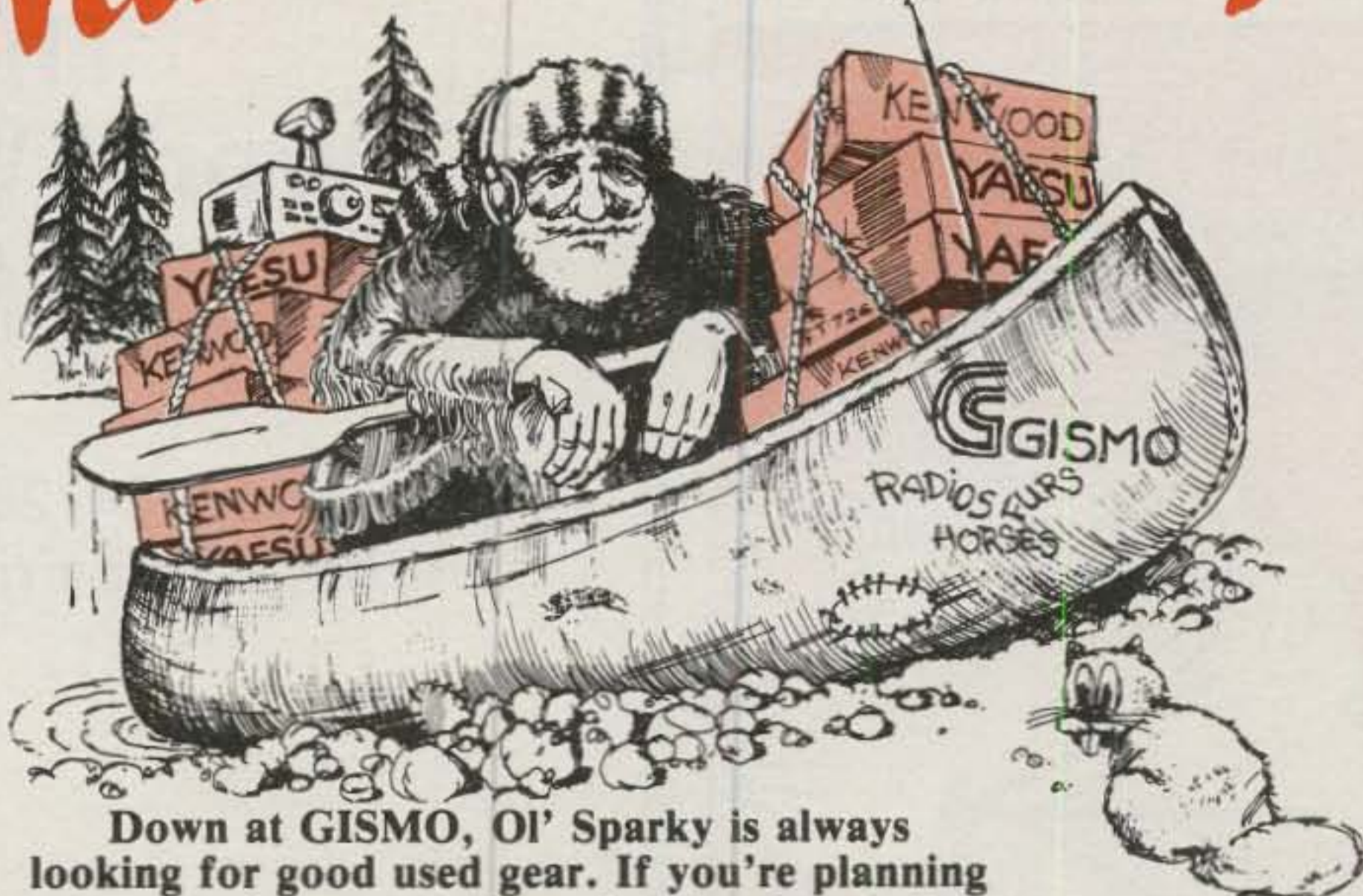

Down at GISMO, Ol' Sparky is always looking for good used gear. If you're planning to upgrade your station, give Sparky a call. Your present equipment may be worth plenty.

**704-523-7003**



C.O.D.



**GISMO**

3401 South Boulevard  
Charlotte, NC 28209

**New Location**

CIRCLE 30 ON READER SERVICE CARD

## NEW

## Alpha Delta Model DX-A 160-80-40 METER QUARTER WAVE

## TWIN SLOPER ANTENNA

The Model DX-A combines the tremendous firepower of the quarter wave sloper with the wide bandwidth of a half wave dipole. Simple to install, quick to tune. Proven longhaul DX performance.

- Installs like an inverted-V dipole. One leg for 80 meters (67') and the other leg for 160/40 meters (55'). Fed with a single 50 ohm coax. SO-239 connector provided on mounting bracket.
- Configuration provides wide bandwidth on all three bands. Typically 70 kHz on 160 meters, 200 kHz on 80 meters and full band on 40 meters. Much wider than most other loaded slopers, dipoles or verticals. Tuner usually not required.
- Model DX-A also operates on 30-17-12 meters. VSWR of less than 2.5:1. Easily matched with a tuner.
- High-power operation. Rated at 1500 watts P.E.P. output. No traps to break

down. A single "ISO-RES" isolator-resonator is used in the 160/40 meter leg.

- Current lobe up high for maximum radiation and excellent DX performance. Can be installed from 25 to 40' high.

- The Model DX-A Antenna is fully assembled, uses all stainless steel hardware, a UV-protected "ISO-RES" coil, #12 copper wire and is rated for severe environments. Specially coated wire disappears from your neighbors' view.

**\$49<sup>95</sup>**

Available from your local Alpha Delta Dealer or add \$3.00 shipping and handling (USA only).

## ALPHA DELTA COMMUNICATIONS, INC.

P.O. Box 571 Centerville, OH 45459  
(513) 435-4772 Orders • (513) 376-4180 Antenna Tech Info



current solutions to current problems

**NOW  
FACTORY  
DIRECT!!!**

**STEP UP TO  
TELREX  
ANTENNAS  
ANTENNA SYSTEMS**

**"INVEST" in a Telrex antenna!**

Why gamble with shoddy antenna construction when Telrex makes available a professionally designed quality product.



Antennas that last **"Decades"**  
(not months)



**Some of the WORLD'S finest.**

TB4EC 10, 15, 20 Mtr.	\$295.00
TB5ES 10, 15, 20 Mtr.	\$410.00
TB5EM 10, 15, 20 Mtr.	\$530.00
TB6EM 10, 15, 20 Mtr.	\$640.00
20M326 3 elem. 20 Mtr.	\$360.00
20M536 5 elem. 20 Mtr.	\$595.00
20M646 6 elem. 20 Mtr.	\$995.00
15M532 5 elem. 15 Mtr.	\$485.00
15M845 8 elem. 15 Mtr.	\$975.00
10M523 5 elem. 10 Mtr.	\$315.00
10M636 6 elem. 10 Mtr.	\$675.00
2MVS814, 2 Mtr. phased	\$245.00



For data on the complete line of Telrex antennas phone (anytime) and leave your call sign, or write.

Phone: 201-775-7252

Write: **Telrex** P.O. Box 879  
Asbury Park, N.J. 07712

**Announcing**

**The 1986  
CQ World-Wide 160 Meter  
DX Contest**

**C.W.: January 24-26  
Starts: 2200Z Fri.**

**S.S.B.: February 21-23  
Ends: 1600Z Sun.**

This year's rules are essentially the same as last year's. To preserve order, and to facilitate more off-continent QSO's, it is strongly recommended that DX stations work W/VE split-frequency, and announce their preferred listening spot.

**Classes:** Both single operator and multi-operator.

**Exchange:** RS(T) and QTH. State for U.S. and province for Canada. DX may use a standard prefix or a two- or three-letter country abbreviation. It helps the scorers on some handwritten logs.

**Scoring:** Contacts with stations in your own country, 2 points. Contacts with other countries in your continent, 5 points. Contacts with other continents, 10 points. (KH6 and KL7 are considered countries and not states.) This means U.S. and Caribbean contacts are 5 points for each other. Alaska and all North American Caribbean contacts are 5 points for W/VE.

**Multiplier:** Each U.S. state (maximum 48), VE province (maximum 13), DX country, and Maritime Mobile Region. U.S. and Canada do not also count as multipliers for anyone. Possible Canadian multipliers are VO1, VO2, VE1 (N.S.), VE1 (N.B.), VE1 (P.E.I.), VE2, VE3, VE4, VE5, VE6, VE7, VE8 (NWT), and VY (Yuk).

**Final Score:** Total QSO points times the sum of the multipliers.

**Penalties:** Three additional contacts may be deleted from the score for each unmarked duplicate or false contact removed from the log. A second multiplier may be removed for each one lost by the above action. An error in the state, province, or prefix may result in loss of that contact.

**Disqualification:** If the claimed score decreases by more than 2% as a result of removing duplicate or invalid contacts, you may be disqualified. Other causes are violation of contest rules, unsportsmanlike conduct, or violation of your country's amateur radio regulations. Disqualified stations or operators may be barred from future CQ contests for up to three years.

**Awards:** Certificates to the top scorers in each class, in each state, province, and DX country.

Special plaques for several categories will be announced in the Contest Calendar column as they become available.

Sample log and summary sheets may be obtained from CQ by sending a large s.a.s.e. with sufficient postage to cover your request. It is not necessary to use the official forms. You can make up your own, 40 contacts to the page, time in GMT, and columns for exchange sent and received, multiplier, and QSO points. Indicate the multiplier only the first time it is worked, and number them sequentially.

Include a summary sheet with your entry showing the scoring and other essential information, and a signed declaration that all rules and regulations have been observed. Mailing deadline for CW entries is February 28th, and March 31st for the SSB section.

Logs can be sent directly to the 160 Contest Director, Don McClenon, N4IN, 3075 Florida Avenue, Melbourne, FL 32904 USA. They can also be sent to CQ 160 Meter Contest, 76 North Broadway, Hicksville, NY 11801 USA. (Please indicate CW or SSB on the envelope.)



# Your Ham Tube Headquarters!

TUBES BOUGHT, SOLD AND TRADED  
SAVE \$\$\$—HIGH \$\$\$ FOR YOUR TUBES

Call Toll Free 800-221-0860  
Tubes

3-400Z .....	\$85.00	7360 .....	\$10.00
3-500Z .....	85.00	7735A .....	27.50
4-400A .....	80.00	8122 .....	110.00
4CX250B .....	55.00	8156 .....	12.50
572B .....	55.00	8643 .....	82.50
811A .....	12.00	8844 .....	26.50
813 .....	30.00	8873 .....	175.00
M2057 .....	13.00	8874 .....	185.00
6146B .....	6.50	8877 .....	495.00
6883B .....	6.75	8908 .....	12.50

### Semiconductors

MRF 245/SD1416 .....	\$30.00	SD1088 .....	19.95
MRF 454 .....	18.95	2N3055 .....	00.75
MRF 455 .....	13.95	2N6084 .....	11.50

### RF Connectors

PL259 .....	10/\$5.95	M358 .....	2.50 ea.
PL258 .....	10/9.95	M359 .....	2.25 ea.
UG175/176 .....	10/1.80	Type "N" Twist on	
UG255/u .....	2.50 ea.	(RG8/u) .....	\$4.75 ea.
UG273/u .....	2.25 ea.	Minimum Order \$25.00	

Allow \$3.00 min. for UPS charges

**CeCo**

COMMUNICATIONS, Inc.

2115 Avenue X Brooklyn, NY 11235

SERVING THE INDUSTRY SINCE 1922

Phone (718) 646-6300

Call CECo For Your CCTV Security And Color Production Requirements

CIRCLE 12 ON READER SERVICE CARD

Take it with you.

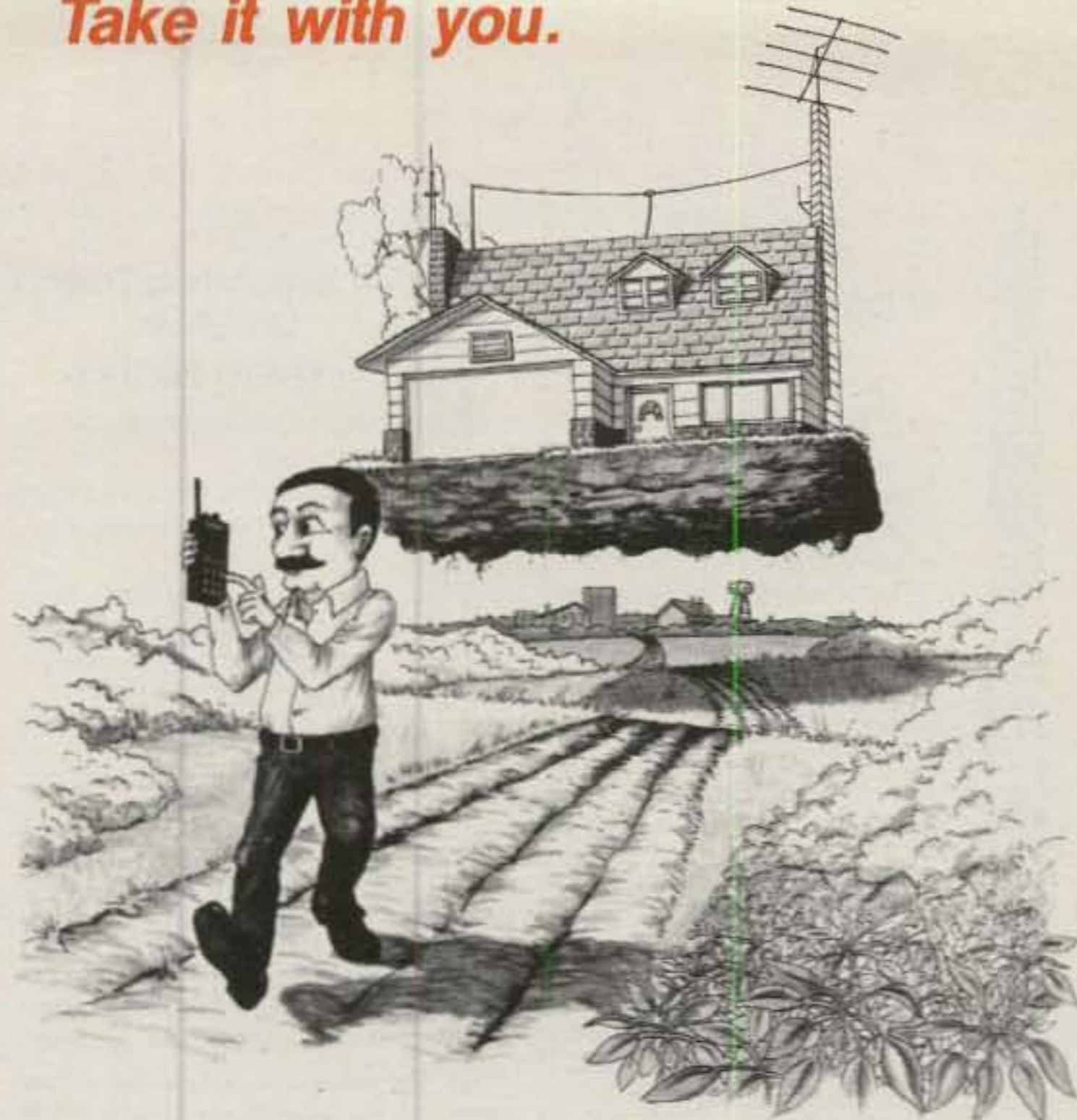

ShackMaster™ puts your home station in the palm of your hand. Whether portable, mobile, around the yard or around town you'll be linked through your handheld to your high performance equipment at home. Even call home from any Touch-Tone phone and operate.

Scan the bands, change modes, select antennas, turn gear on and off — all from your Touch-Tone keypad. Check into nets, work skeds, ragchew and DX without being tied down to the shack.

Exchange electronic mailbox messages with your family — like "I'll be late", or "All is OK". Or talk with your family directly through ShackPatch™, with you in remote control of your home station. Report traffic accidents or disabled motorists through your home phone while mobile or motorists with PersonalPatch™.

All the power of your home station (and more) really can follow you anywhere... to find out more about ShackMaster™ just write, send us your QSL, or call and talk with us at 408-749-8330.

**ACC** advanced computer controls, Inc.

10816 Northridge Square • Cupertino, CA 95014

(408) 749-8330

CIRCLE 14 ON READER SERVICE CARD

## Get Your Best Deal... Then CALL US... TOLL FREE!

# 1-800-238-6168

(In Tennessee, call 901-683-9125)

# KENWOOD ICOM

## WE TRADE!! CALL FOR FREE APPRAISAL!

AUTHORIZED DEALER FOR: Kenwood, ICOM, Ten-Tec, MFJ, Astron, AEA, Mirage, B&W, Hustler, Cushcraft, Larsen, Hy-Gain, Butternut, Avanti, Van Gordon, and more... PLUS CURRENT USED GEAR

When you call, talk to a Qualified Ham Operator! Ask for MARSHALL, KU4O, or BILL, W4TNP

We are an Authorized Service Center for KENWOOD

After the sale, it's the service that counts!

# Memphis Amateur Electronics, Inc.

Store Hours:  
Monday-Friday, 9 to 5,  
Saturday 9 to 12  
(Central Time)

Send QSL card for FREE Catalogue

1465 Wells Station Rd., Memphis, TN 38108

CIRCLE 42 ON READER SERVICE CARD



# ANTENNA/TOWER SALE!

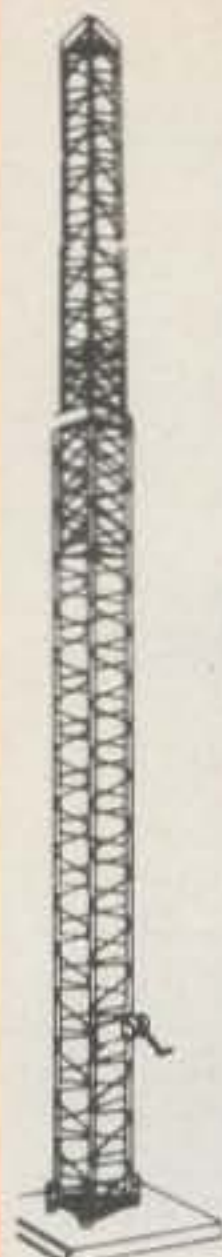

## hy-gain CRANKUP SALE!

All Models Shipped Factory Direct—Freight Paid\*!

- Check these features:
- All steel construction
  - Hot dip galvanized after fabrication
  - Complete with base and rotor plate
  - Totally self-supporting—no guys needed

Model	Height	Load	Sale Price
HG37SS	37 ft	9 sq. ft.	\$CALL
HG52SS	52 ft	9 sq. ft.	\$CALL
HG54HD	54 ft	16 sq. ft.	\$CALL
HG70HD	70 ft	16 sq. ft.	\$CALL

Masts—Thrust Bearings—Other Accessories Available—Call! Prices Shown Are Your Total Delivered Price In Continental U.S.A.!



## ROHN Self Supporting Towers On SALE!

### FREIGHT PREPAID

- All Steel Construction—Rugged
- Galvanized Finish—Long Life
- Totally Free Standing—No Guy Wires
- America's Best Tower Buy—Compare Save \$
- Complete With Base and Rotor Plate
- In Stock Now—Fast Delivery

Model	Height	Ant. Load*	Weight	Delivered Price*
HBX40	40 ft	10 sq ft	164	\$329
HBX48	48 ft	10 sq ft	303	\$429
HBX56	56 ft	10 sq ft	385	\$499
HOBX40	40 ft	18 sq ft	281	\$399
HOBX48	48 ft	18 sq ft	363	\$489

\*Your Total Delivered Price Anywhere in Continental 48 States. Antenna Load Based on 70 MPH Wind.



## Tri-Ex®

These rugged crankup towers now available from Texas Towers! All models available On Sale for tremendous savings to you!

To save on freight costs, all towers are shipped directly from the Tri-Ex factory to you!

- Check these features:
- All steel construction
  - Hot dip galvanized after fabrication
  - Complete with base and rotor plate
  - Totally self-supporting—no guys needed

Model	Height	Up	Down	Wind	Load	List	Sale
W36	36.0 ft	20.5 ft	9.0 sq ft		\$694	\$579	
WT51	51.0 ft	20.5 ft	9.0 sq ft		\$1154	\$899	
LM354	54.0 ft	21.0 ft	16 sq ft		\$2010	\$1599	
LM4700	70.0 ft	22.0 ft	16 sq ft		\$4195	\$3199	
(Motorized)							
DX86	86.0 ft	23.0 ft	25 sq ft		\$7200	Call	
(Motorized)							

## US TOWER CORPORATION

Formerly Tristao Tower Co.



**MA-40**  
40' tubular  
Regular \$745

**SALE! \$549**

**MA-550**  
55' tubular

Will handle 10 sq. ft. antennas at 50 MPH winds.

Regular \$1245

**SALE! \$899**

**IN STOCK FOR IMMEDIATE DELIVERY**

CALL FOR INFORMATION ON ALL OTHER MODELS

### RG-213U

\$ .29/ft \$279/1000ft  
Up to 600 ft via UPS

- RG-213/U—95% Bare Copper Shield
- Mil-Spec Non-contaminating Jacket for longer life than RG8 cables.
- Our RG-213/U uses virgin materials.
- Guaranteed Highest Quality!

### RG-8X

\$ .19/ft \$179/1000 ft

- RG8X—95% Bare Copper Shield • Low Loss
- Non-contaminating Vinyl Jacket • Foam Dielectric

**Coaxial Cable Loss Characteristics (DB/100 ft)**

Cable Type	Imped.	10MHz	30MHz	150MHz	450MHz
RG-213/U	50	.6	.9	2.3	5.2
RG8X	52	.8	1.2	3.5	6.8
RG-58/U	52	1.4	1.9	6.0	12.5
1/2" Alum	50	.3	.5	1.2	2.2
1/2" Heliax	50	.2	.4	.9	1.6
1/4" Heliax	50	.1	.2	.5	.9

### HARDLINE/HELIAX™

Lowest Loss for VHF/UHF!

1/2" Alum. w/poly Jacket \$ .79/ft  
1/2" LDF4-50 Andrew Heliax™ \$1.69/ft  
1/4" LDF5-50 Andrew Heliax™ \$3.99/ft  
select connectors below.

### HARDLINE & HELIAX™ CONNECTORS

Cable Type	UHF	FML	UHF MALE	N	FML	N MALE
1/2" Alum	\$19	\$19	\$19	\$25		
1/2" Heliax™	\$22	\$22	\$22	\$22		
1/4" Heliax™	\$49	\$49	\$49	\$49		

### AMPHENOL CONNECTORS

Silver PL259	\$1.25
UG71B N Male	\$2.95
UG23D N Female	\$2.95

### Antenna Wire & Accessories

Copperweld Antenna Wire (steel core, copper coated)	
Solid 12 ga.	\$12/ft
14 ga.	\$10/ft
Stranded 14 ga.	\$10/ft
16 ga.	\$09/ft
1/4 mile 18 ga copper-clad steel wire	\$30
6 inch heavy-duty end insulator	\$2.00/ea.
Dog-bone insulator	\$ .79
Coax seal	\$2.50

### Van Gorden

1:1 Balun	\$11
Center Insulator	\$6
Dipole Kits	D80 \$31/D40 \$28
Short Dipole Kits	SD80 \$35/SD40 \$33
All-band Dipole w/ ladder line	\$29
Eavesdropper SWL Antenna	\$64

### ALPHA DELTA

DX-A 160-80-40 Sloper \$49

### CUSHCRAFT

A33-el Tribander Beam	\$209
A743 30/40mtr Kit for the A3	\$75
A44-el Tribander Beam	\$269
A744 30/40mtr Kit for the A4	\$75
R3 20, 15, 10mtr Vertical	\$259
AV5 80-10mtr Vertical	\$99
D40 40mtr Dipole	\$149
40-2CD 2-el 40mtr Beam	\$279
A50-5 5-el 6mtr Beam	\$79
215 WB NEW 15-el 2mtr Beam	\$75
3219 19-el 2mtr Beam	\$89
220B 17-el 220MHz Beam	\$89
424B 24-el 432MHz Beam	\$75
ARX2B 2mtr Vertical	\$39

### hy-gain

Discoverer 2-el 40-mtr Beam  
Discoverer 3-el Conversion Kit  
EXPLORER-14 SUPER SPECIAL  
OK710 30/40 mtr Add-On-Kit  
V2S 2-mtr Base Vertical  
V4S 440MHz Base Vertical  
TH5MK2S Broad Band 5-el Triband Beam  
TH7DXS 7-el Triband Beam  
TH3JRS 3-el Triband Beam  
205BAS 5-el 20-mtr Beam  
155BAS 5-el 15-mtr Beam  
105BAS 5-el 10-mtr Beam  
204BAS 4-el 20-mtr Beam  
64BS 4-el 6-mtr Beam  
18 AVT/WB 80-10mtr Vertical  
18HTS 80-10 mtr Hy-Tower Vertical  
23BS 3-el 2mtr Beam  
25BS 5-el 2mtr Beam  
28BS 8-el 2mtr Beam  
214BS 14-el 2-mtr Beam  
2800 80/40 mtr Trap Dipole  
5800 80-10 mtr Trap Dipole  
BN86 80-10 mtr KW Balun W/Coax Seal

Limited Quantities purchased at old prices. Call for current prices.

### HUSTLER

6BTV 80-10 mtr Vert	\$129	5BTV 80-10 mtr Vert	\$109		
4BTV 40-10 mtr Vert	\$89	G7-144 2-mtr Base	\$119		
G6-144B 2-mtr Base	\$89				
<b>Mobile Resonators</b>	<b>10m</b>	<b>15m</b>	<b>20m</b>	<b>40m</b>	<b>75m</b>
400W Standard	\$16	\$17	\$19	\$22	\$26
2KW Super	\$20	\$22	\$25	\$29	\$39

Bumper Mounts - Springs - Folding Masts in Stock!

### BUTTERNUT ELECTRONICS CO

NEW HF4B "Butterfly" Compact Beam \$169.  
-delivered (cont. USA)

### HF6V \$129 Delivered (Cont. USA)

- Full Legal Power 80/10 Meters
- Optional Stub Tuned Radial Kit Model STR II \$29
- Optional Roof Mounting Kit Model RMK II \$49 (includes STR II)
- Optional 160 Meter Resonator Kit Model TBR 160 \$49

### HF2V 80/40 Meter Vertical Antenna \$129

Delivered (Continental USA)

- Optional 160 Meter Resonator Kit Model TBR 160 \$49

Free Shipping On Butternut Accessories Also When Purchased With Antenna

### KLM

KT34A 4-el Broad Band Triband Beam	\$339
KT34XA 6-el Broad Band Triband Beam	\$489
2m-14C 14-el 2-mtr Satellite Antenna	\$89
2m-16LBX NEW-16-el 2-mtr Beam	\$99
2m-22C NEW-22-el 2-mtr Satellite Antenna	\$119
432-30LBX NEW-30-el 432 MHz Antenna	\$99
435-18C 435 MHz Satellite Antenna W/CS-2	\$119
432-16LB 16-el 432 MHz Beam	\$69
435-40CX 435 MHz Satellite Antenna w/CS-2	\$159

### MOSLEY

TA-333 3-el Tribander	\$239
TA-33JR 3-el Tribander	\$189
PRO 37 7-el Tribander Beam	\$469
S 403 3-el 40-mtr Beam	\$699

### MINI-PRODUCTS HQ-1 \$159

### ROTORS

Alliance HD73 (10.7 sq ft rating)	\$119
Alliance U110 (3 sq ft rating)	\$49
Telex HAM 4 (15 sq ft rating)	\$229
Telex Tailtwister (20 sq ft rating)	\$279
Telex HDR300 Heavy Duty (25 sq ft rating)	\$539
KLM EL-3000 Moon Tracker Elevation Rotator	\$369
Kenpro KR400 Azimuth Rotator	\$129
Kenpro KR500 Heavy Duty Elevator Rotator	\$159
Kenpro KR600 Azimuth Rotator	\$199
Kenpro KR2000 Heavy Duty Azimuth Rotator	\$379
Kenpro KR5400 AZ/EL Rotor Package	\$259
Kenpro KR5600 Heavy Duty AZ/EL Rotor Pkg	\$329

### ROTOR CABLE

Standard 8 cond cable \$19/ft (vinyl jacket 2-#18 & 6-#22 ga)  
Heavy Duty 8 Cond cable \$.36/ft (vinyl jacket 2-#16 & 6-#18 ga)

### UNR-ROHN GUYED TOWERS

10 ft Stack Sections

20G	\$39.50	45G	\$112.50
25G	\$49.50	55G	\$134.50

All 20G, 25G, 45G and 55G Accessories In Stock at Discount Prices - CALL!

Foldover Towers	Model	Height	Ant Load*	Price
	FK2548	48 ft	15.4 sq ft	\$899
	FK2558	58 ft	13.3 sq ft	\$949
	FK2568	68 ft	11.7 sq ft	\$999
	FK4544	44 ft	34.8 sq ft	\$1199
	FK4554	54 ft	29.1 sq ft	\$1299
	FK4564	64 ft	28.4 sq ft	\$1399
	25G Foldover Double Guy Kit			\$219
	45G Foldover Double Guy Kit			\$249

\*Above antenna loads for 70 MPH winds and Guys at Hinge & Apex.

### TOWER/GUY HARDWARE

3/16" EHS Guywire (3990 lb rating)	\$15/ft
1/4" EHS Guywire (6000 lb rating)	\$18/ft
5/32" 7 x 7 Aircraft Cable (2700 lb rating)	\$15/ft
3/16" CCM Cable Clamp (3/16" or 5/32" Cable)	\$.45
1/4" CCM Cable Clamp (1/4" Cable)	\$.55
1/4" TH Thimble (fits all sizes)	\$.45
3/8" EEE (3/8" Eye & Eye Turnbuckle)	\$6.95
3/8" EJ (3/8" Eye & Jaw Turnbuckle)	\$7.95
1/2" EE (1/2" Eye & Eye Turnbuckle)	\$9.95
1/2" EJ (1/2" Eye & Jaw Turnbuckle)	\$10.95
3/16" Preformed Guy Grip	\$2.49
1/4" Preformed Guy Grip	\$2.99
6" Diam - 4 ft Long Earth Screw Anchor	\$14.95
5000 Guy Insulator (5/32" or 3/16" Cable)	\$1.69
502 Guy Insulator (1/4" Cable)	\$2.99
5/8" Diam - 8 ft Copper Clad Ground Rod	\$12.95

### PHILLYSTRAN GUY CABLE

HPTG2100 Guy Cable (2100 lb rating)	\$29/ft
HPTG4000 Guy Cable (4000 lb rating)	\$49/ft
HPTG6700 Guy Cable (6700 lb rating)	\$69/ft
9901LB Cable End (for 2100/4000 cable)	\$7.95
9902LD Cable End (for 6700 cable)	\$8.95
Socketfast Potting Compound (does 6-8 ends)	\$14.95

### GALVANIZED STEEL MASTS

Heavy Duty Steel Masts 2 in OD - Galvanized Finish

Length	5 FT	10 FT	15 FT	20 FT
.12 in Wall	\$29	\$49	\$59	\$79
.18 in Wall	\$39	\$69	\$99	\$129
.25 in Wall	\$69	\$129	\$189	\$249

**ORDER TOLL FREE 1-800-272-3467**

Texas, Alaska & for information: 1 (214) 422-7306

# TEXAS TOWERS

Div. of Texas RF Distributors Inc. 1108 Summit Ave., Suite 4 • Plano, Texas 75074

**VISA** **MasterCard**

Mon-Fri: 9am - 5 pm  
Sat: 9am - 1 pm

(Prices & Availability Subject To Change Without Notice)

(Antenna/tower product prices do not include shipping unless noted otherwise)

# KENWOOD



**TS-940S LIST \$1999**  
 NEW Top-of-the-Line  
 HF Transceiver  
 • 100% Duty Cycle  
 • 40 Memory Channels  
**CALL FOR SPECIAL PRICES!!**



**TS-930S LIST PRICE \$1649**  
**CALL FOR SPECIAL SALE PRICE!**



**TS-430S LIST PRICE \$899.95**  
**CALL FOR SPECIAL SALE PRICE!**



**TS-711A LIST \$799.95**  
**TS-811A LIST \$899.95**  
**CALL FOR SPECIAL PRICE!**



**TW-4000A LIST \$599.95**  
**CALL FOR SPECIAL PRICE!**

**TR2600A - 2mtr**  
**TR3600A - 70cm**  
 High Tech  
 HT XCVRS

**NEW Ultra-Compact HT XCVRS**  
**TH21AT 2mtr**  
**TH31AT 220 MHz**  
**TH41AT 440 MHz**  
**CALL FOR SPECIAL PRICES—SAVE \$\$\$!!**

## MIRAGE AMPLIFIER SALE!



**B3016 ONLY \$199!**

Model	Band	Pre-amp	Input	Output	Sale Price
A1015	6M	Yes	10W	150W	\$249
B23	2M	No	2W	30W	\$ 79
B215	2M	Yes	2W	150W	\$259
B108	2M	Yes	10W	80W	\$159
B1016	2M	Yes	10W	160W	\$249
B3016	2M	Yes	30W	160W	\$199
C22	220	No	2W	20W	\$ 79
C106	220	Yes	10W	60W	\$179
C1012	220	Yes	10W	120W	\$259
D24	440	No	2W	40W	\$179
D1010N	440	No	10W	100W	\$289

# ICOM



**IC735 NEW General Coverage HF Transceiver Full Featured - Ultra Compact - Economical**  
 List Price \$849  
**CALL FOR SPECIAL PRICE!**



**IC745 General Coverage HF Transceiver List \$999**  
**IC751 Full Featured HF Transceiver List \$1399**  
**CALL TODAY FOR LOW TEXAS TOWERS/ICOM PRICES!**



**IC271A List \$699 IC271H List \$899**  
**IC471A List \$799 IC471H List \$1099**  
**CALL TODAY FOR SPECIAL LOW ICOM PRICES!!**

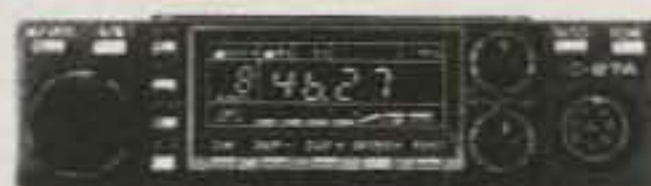

**IC27A List \$369 IC27H List \$409**  
**IC37A List \$449 IC47A List \$469**  
**CALL TODAY FOR SPECIAL ICOM PRICES!**



**IC3200 NEW 2m/70cm Dual Band Xcvr List \$549**  
**CALL FOR SPECIAL PRICE!**

**IC02AT - 2mtr**  
**IC04AT - 70cm**  
 High Tech  
 HT XCVRS

**IC2AT - 2mtr**  
**IC3AT 220 MHz**  
**IC4AT 440 MHz**  
**ALL IN STOCK—CALL FOR SPECIAL PRICES!**

### ASTRON POWER SUPPLIES

**Heavy Duty - High Quality - Rugged - Reliable**

- Input Voltage: 105-125 VAC Output: 13.8 VDC ± .05V
- Fully Electronically Regulated—5mV Maximum Ripple
- Current Limiting & Crowbar Protection Circuits
- M-Series With Meter—A-Series Without Meter



Model	Cont. Amps	ICS Amps	Price
RS4A	3	4	\$ 39
RS7A	5	7	49
RS12A	9	12	69
RS20A	16	20	89
RS20M	16	20	109
RS35A	25	35	135
RS35M	25	35	149
RS50A	37	50	199
RS50M	37	50	229

# YAESU



**FT-757GX LIST PRICE \$829**  
**CALL FOR SPECIAL SALE PRICE!**



**FT-726R LIST PRICE \$899**  
**CALL FOR SPECIAL SALE PRICE!**



**FT2700RH NEW 2m/70cm Dual Band Transceiver Full Duplex — Cross Band Operation! List \$579**  
**CALL FOR PRICE—SAVE \$\$!**



**FT-209RH NEW High Tech 2mtr HT 5 Watt Output NOW IN STOCK**

**CALL FOR YOUR SPECIAL PRICE!**



**CP-1 COMPUTER PATCH List \$239.95 SALE \$189.95**

- CP-1-1 Computer Patch ..... \$189.95
- CP-1/20 Computer Patch W/VIC20 MBATEXT \$219.95
- CP-1/64 Computer Patch W/C64 MBATEXT \$219.95
- CP-100 Deluxe Computer Patch ..... \$299.95
- PK64 C64 Packet System ..... \$219.00
- ATU-1000 Advanced Terminal Unit ..... \$1049.95
- MBATOR Software C64 or VIC20 (Specify) ..... \$89.95
- Doctor DX CW Band Simulator Software ..... \$99.95
- Doctor QSO Morse Code Trainer Software ..... \$79.95
- PKT-1 Packet Controller ..... \$469.95

Isopola 144MHz, 220MHz & 440MHz Antennas In Stock — **CALL FOR SPECIAL PRICES!**

## Kantronics

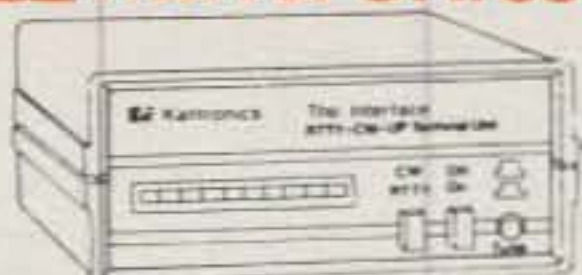

**The Interface List \$169.95 SALE \$129.95**  
**Interface II List \$269.95 SALE \$239.95**  
**Challenger List \$99.95 SALE \$89.95**  
**Universal Term Unit List \$199.95 SALE \$189.95**  
**Packet Communicator List \$219.00 SALE \$199.95**  
**UTU Terminal Software (IBM/CPM/TRS80) \$19.95**  
**Hamssoft/Amtorsoft (Atari/C64/VIC/TRS80C) \$79.95**  
**Apple Hamssoft \$29.95 Atari/VIC Hamssoft \$49.95**  
**TRS80C Hamssoft \$59.95 TI994A Hamssoft \$99.95**  
**Hamtext (Apple/Atari/C64/VIC20) \$99.95**  
**Amtorsoft (C64/VIC20) \$89.95**  
**Amtorsoft (Apple) \$139.95**

# AMERITRON



**AL80A NEW 1000W 3-500Z Amplifier \$689**

**AL-84 600W PEP Output (4-6MJ6 Tubes) ..... \$379**  
**AL-1200 1500W Output (3CX-1200 Tube) ..... \$1399**  
**RCS-8 5 Pos Remote Antenna Switch ..... \$119**  
**ATR-15 1500W Antenna Tuner ..... \$289**

## TEN-TEC SALE!



**NEW CORSAIR II CALL FOR PRICE AND DELIVERY INFORMATION**



**425 Titan New 3KW amplifier in stock-only \$2195!**

## ALINCO



**ELH-230D LIST \$89.95**

30 Watt 2M Amp w/GaAs-FET Preamp  
 Special \$79.00  
 Other Alinco Amps in Stock  
 Call For Special Price.

## POWER SUPPLIES



**EP-3030 LIST \$208.00 SPECIAL \$189.00**

## KDK



**FM-240 NEW COMPACT 2M-25W FM Transceiver**

- 16 memory channels
- 2 VFOs
- Programmable sub audible tone unit included no extra charge.
- Optional voice synthesizer available

**Call For Special Price**

## THL CORP.



**Power amps and receive preamps in stock. CALL FOR SPECIAL PRICES!**

**ORDER FREE SHIPPING-UPS SURFACE TOLL FREE 1-800-272-3467**  
 (continental USA) (most items, except towers/antennas) Texas, Alaska & for information call 1-(214)-422-7306



# TEXAS TOWERS

Div. of Texas RF Distributors Inc. 1108 Summit Ave., Suite 4 • Plano, Texas 75074

Mon-Fri: 9am - 5 pm  
 Sat: 9am - 1 pm

## NEWS OF CERTIFICATE AND AWARD COLLECTING

**T**he Story of the Month as told by Leo is:  
**S. Leo McGranaghan, WB4AIL**  
**All Counties #209, 1-2-79**

"I was born in Harrisburg, Pennsylvania on December 26, 1900. As a freshman at Technical High School, I was a member of Tech High Wireless Club. The club consisted of six students with one professor in charge. In the Wireless Room they had a huge spark gap arrangement mounted on a large marble slab. That big thing had nearly scared the wits out of me. Instructions consisted of making tuning coils out of rolling pin bases, loose couplers, and condensers out of waxed paper and tin foil.

"I had a wire on the roof of my home that served as an antenna. I had a buzzer test consisting of a cat whisker with a Galena crystal. I tried many times without success to get the high noon time click as sent out from NAA in Washington, D.C. The first World War came and my interest in wireless came to a halt.

"In 1930 I moved to Miami, Florida, my home until just a few years ago. In 1938 I found the girl of my dreams, Velma, and we promptly got married. Then in 1942 came World War II. I served three years in the United States Navy Reserve doing duty mostly on Patrol Craft. Since I was from a warm part of the country, the Navy decided to send me to the Aleutians to join my ship and to cool off. After a year and a half on duty in those frigid waters off the coast of Alaska, my ship was moved to Honolulu and we had a chance to thaw out for the rest of the war.

"After the war I returned to Miami and continued my pre-war job as a special agent for Prudential Insurance Company. In 1948 I became a proud father of our only daughter, Nancy. She was certainly worth waiting for! In 1950 I changed jobs to real estate and had my own office in Miami.

"In the early part of 1970 a friend of mine convinced me that I should give ham radio a whirl. He built me an HW16 and helped me learn amateur radio. I was first licensed as WN4PGI. At that time the FCC regulations required that holders of Novice class licenses be rock bound, so I had about 15 crystals for operation on 15 meters. In September 1970, after retirement, Velma and I took a Mediterranean cruise on the Swedish American Liner Gripsholm. Being a guest and a bold Novice, I managed to find my way to the radio



S. Leo McGranaghan, WB4AIL, USA-CA  
All Counties #209, 1-2-79.

room. It was there that they showed me a book put out by CQ magazine showing the many counties they had worked. In their time off all the radio officers used to work amateurs. That did it! I was hooked! I decided to become a County Hunter, and when I returned home I sent for the book and began county hunting. I had hundreds of QSL cards from previous contacts, although many of them did not contain the county. I then got the Postal Directory and from it was able to determine the counties. I was having fun! One day someone said that I should join MARAC (Mobile Amateur Radio Awards Club). I did join and was given No. R-514. The monthly bulletins were over my head, and I suppose that they wondered why a Novice was joining MARAC.

"Back in those days a Novice license was issued for only two years. If the license was permitted to expire, the licensee could apply again for a license only after a year of waiting. After waiting that miserable year off the air I was finally given a new call, WN4DMA. I continued to pound brass and work only CW. As my second two-year period came to a close I decided I must upgrade. A summer of study prepared me for the General class exam. I passed and was given my present call, WB4AIL. I was able to complete my first 500 counties all endorsed CW on 15 meters. For the next three years after my upgrade I spent every day from band opening to band closing collecting counties on 20 meters. I added 30 pounds to my frame and completed the balance of 3075 counties. I was given USA-CA All Counties #209, dated January 2, 1979.

"In June of 1979 I repaid the favor extended me on the liner Gripsholm and introduced my nephew, John, KA2CNG, to

county hunting after he upgraded his license to General class. I personally supervised the first 20 counties he worked to make sure he was on the right track.

"I want to express my thanks to each and everyone who helped me along the way. Space will not permit me to mention all the individuals who so graciously gave their time to help. To all of you I say, "Thanks!" I have attended three annual County Hunter conventions where it has been my pleasure to meet old friends. The last convention I attended was in Charleston, West Virginia. My nephew drove me there, and it was my first experience seeing how the operation runs from inside a car.

"Have you ever wondered what becomes of old county hunters? Many of them, I have found, seem to gravitate to the 3905 Century Club nets which operate evenings on 40 or 75 meters. If you are interested in working 5 band WAS, this is the place to search. If anyone is interested in working me for my USA-CA number, you will find me most evenings around 3903 on the Century Club.

"In 1982, after 52 years in Miami, Florida, Velma and I moved to Greensboro, North Carolina to be near our daughter and her family. We enjoy the four seasons there. Just recently we celebrated our 46th wedding anniversary and my 84th birthday. I hope I will be able to attend my 4th Annual County Hunters Convention one of these years.—73, Leo, WB4AIL"



Yas, JH8GWW, and Kazuo, JA8JL,  
shown in Kazuo's radio shop in Sapporo.  
Yas has just received USA-CA 1000 #880.

333 South Lincoln Ave., Mundelein, IL  
60060

# Dan's Got It All

**ICOM**  
IC-751, IC-745, IC-02A

**YAESU**  
FT-980 CAT, FT-209 RH, FT-757 GX

**KANTRONICS THE INTERFACE**  
CRI-100, CRI-200, CWR-6850

**KENWOOD**  
TR-7950, TR-7600, TH-21A, TH-21AT, TS-940S, TS-930S

**AEA** CP-1

**HAIC**

**Britt's 2-Way Radio Sales & Service**

2508 Atlanta Street  
Smyrna, Georgia 30080  
Belmont Hills Shopping Center  
(404) 432-8006

All Of These "Goodies" And Many More At Super Savings.  
Come See Us Or Call 1-800-241-2027.

CIRCLE 169 ON READER SERVICE CARD

**NEW DIRECT PRICE**

## AUTOTENNA

**Automatic MOBILE ANTENNA**

Proven commercial design • 5 band Automatic Antenna • Requires no manual switching or resonator changing 500 watts PEP power rating • Large center loading coil • Corrosion resistant construction • Special models available for commercial or maritime frequencies • **\$124.95** includes shipping

**GENE HANSEN CO.**  
1000 Hansen Road.  
Corrales, NM 87048-0419  
(505) 898-3251

**WRIGHTAPES:** (Since 1976) Unconditionally guaranteed Morse Code Practice on 60 min. cassette tapes. Beginners 2-tape set 5 WPM \$7.90. Also 3, 4, 5, 6-8, 10, 9-11, 12-14, 14, 16-20, 22, 24-28 WPM. Specify Plain Language or Code Groups. Also plain lang. only 30-35, 35-40, 45-60. FCC type tests: 5-6, 11-12, 11-17, 13-14, 20-24. Call signs: 12-15, 20-24. Nos.: 5-22, 13-18, 18-24. Check, M/C, Visa \$3.95 ea. PPD 1st class USA, Mex., Can. (Elsewhere add \$2 per tape). Instant Service.

PH: 517-484-9794 **WRIGHTAPES**  
235 E. Jackson Q-3, Lansing, MI 48906.

Please send all reader inquiries directly.

## THE WIREMAN

FOR ALL AMATEUR WIRE & CABLE  
Belden & Equivalent  
Direct Pricing Fast Service

**1-800-433-WIRE**

HARDLINE COAX CONNECTORS  
COPPER WELD™ MAGNET WIRE  
CBto10 LARSEN ANTENNAS UNADILLA

**1-800-433-9473**

616-924-4561 (Mich & Ragchew)

**CERTIFIED COMMUNICATIONS**  
4138 SOUTH FERRIS, FREMONT, MICHIGAN 49412

CIRCLE 15 ON READER SERVICE CARD  
Say You Saw It In CQ

*"...received my moneys worth with just one issue..."*  
— J. Trenbick

*"...always stop to read CTM, even though most other magazines I receive (and write for) only get cursory examination..."*  
— Fred Blechman, K6UGT

U.S.A.	\$15.00 for 1 year
Mexico, Canada	\$25.00
Foreign	\$35.00(land) - \$55.00(air)
<small>(U.S. funds only)</small>	
Permanent (U.S. Subscription)	\$100.00
Sample Copy	\$3.50

**CHET LAMBERT, W4WDR**  
1704 Sam Drive • Birmingham, AL 35235  
(205) 854-0271

CIRCLE 37 ON READER SERVICE CARD

**THE 1985 ARRL HANDBOOK WAS GREAT ... BUT WAIT UNTIL YOU SEE THE '86!**

For a preview of the 1986 ARRL Handbook, see October QST. ARRL, 225 Main St., Newington, CT 06111

# MISSOURI RADIO CENTER

## KENWOOD



### TS-430S Most Advanced, Compact HF Transceiver

- General Coverage Receiver
- USB/LSB/CW/AM/Optional FM • 10Hz Dual Step Digital VFO • Eight Memories w/Lithium Back-up • Memory and Band Scan

## KENWOOD



### TS-930S Top of the Line HF Transceiver

- General Coverage Receiver • Superior Dynamic Range • All Solid State—28 VDC Final • QSK CW • Optional Automatic Antenna Tuner • Dual VFO w/8 Memories • Dual Mode Noise Blanker

## KENWOOD



### TR-7950/7930

- Large LCD Readout • 21 Multi-Function Memory • Lithium Back-up • Automatic Offset • Built-in Encoder • Memory or Band Scan

## KENWOOD



### TR-2600

- 2.5W/300 mW (Switchable) 2 Meter Handheld Transceiver
- LCD Readout • Ten Memories w/Lithium Back-up • Band and Memory Scan

## YAESU



### FT-757 GX

- Compact General-Coverage Receiver
- General-Coverage Receiver
- USB/LSB/CW/AM/FM • Dual VFOs
- Memory/Band Scan • Speech Processor • CW Filter and CW Keyer included

## YAESU

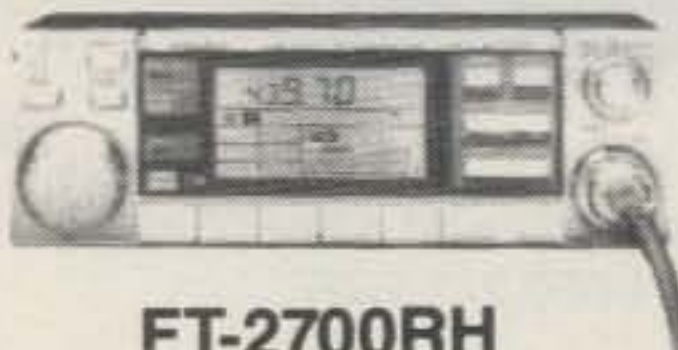

### FT-2700RH

- Dual Bander
- VHF FM
- 144/430 MHz
- 25 WATTS

## YAESU



### FT-209RH

- 5 Watts
- 10 Memories
- LCD
- Compact

## YAESU



### FT980

- CAT SYSTEM—Computer Aided Transceiver
- Wide Dynamic Range • General Coverage • Low Noise Front End • 10 Hz Digital Readout • All Mode Transceiver—CW/SSB/AM/FM/FSK!

## ICOM



### IC-745 HF Base

- All ham band HF transceiver. 16 memories. 100KHz to 30 MHz general coverage receiver and adjustable noise blanker and AGC

## ICOM

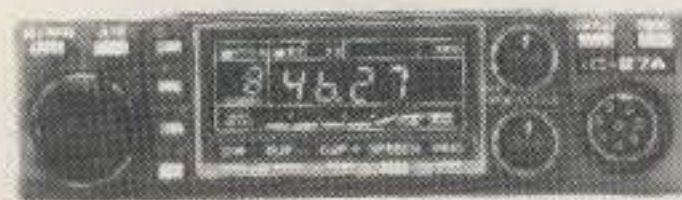

### IC-27A Compact Mobile

- A breakthrough in 2-meter mobile communications! Most compact on the market (5 1/2" x 1 1/2" Hx7" D), contains internal speaker for easy mounting. 25 watts. 32 PL frequencies. 9 memories. scanning and touchtone mic.

## ICOM



### IC-02AT

- The IC-02AT 2-meter LCD readout handheld features 10 memories, 32 PL tones, scanning, keyboard frequency entry, dial lock, 3W std., 5W opt. DTMF

## ICOM



### IC-R71A General Coverage Receiver

- The IC-R71A 100KHz - 30 MHz superior-grade general coverage receiver features keyboard frequency entry, 32 memories, SSB/AM/RTTY/CW, selectable AGC and noise blanker, and wireless remote controller (optional).

OUR ASSOCIATE  
STORE IN THE  
ST. LOUIS AREA

**FLOYD ELECTRONICS**  
2213 VANDALIA COLLINSVILLE, ILL 62234  
**CALL 618-345-6448**

## CALL FOR SPECIAL SALE PRICES

- AEA
- ASTRON
- AVANTI
- AZDEN
- B & W
- BEARCAT
- BENCHER

- BUTTERNUT
- CENTURION
- CES
- COMM SPEC
- CUSHCRAFT
- DAIWA
- HUSTLER

- HYGAIN
- ICOM
- KANTRONICS
- KENWOOD
- KLM
- LARSEN

- MFJ
- MICROLOG
- MIRAGE
- SANTEC
- VANGORDON
- WELZ
- YAESU

**CALL**

**MISSOURI  
RADIO**

**1-800-821-7323**

MASTERCARD, VISA & C.O.D.'s WELCOME

102 NW BUSINESS PARK LANE  
KANSAS CITY, MO 64150  
816-741-8118

### Special Honor Roll

John McCallum, KØIFL  
All Counties #493, 6-12-85  
Lorraine Bachmann, WDX9DCJ  
All Counties #494, 6-19-85

### Honor Roll

<b>3000</b>		<b>1500</b>			
KØIFL	523	KØIFL	715	W3IJT	2034
WDX9DCJ	524	WDX9DCJ	716	YU4GD	2035
				KT2C	2036
<b>2500</b>		<b>1000</b>		KA9IKG	2037
KØIFL	585	JH8GWW	880	SM5FQQ	2038
WDX9DCJ	586	W5OBT	881	HAØDU	2039
				OH3ES	2040
				N9BAE	2041
<b>2000</b>		<b>500</b>		WD9ITQ	2042
KØIFL	641	WB2GHA	2032		
WDX9DCJ	642	J88AQ	2033		

### Awards Issued

John McCallum Carter, KØIFL, finished them all and won USA-CA 1500 #715, USA-CA 2000 #641, USA-CA 2500 #585, USA-CA 3000 #523, and All Counties #493, all Mixed, all dated 6-12-85.

Lorraine Bachmann, WDX9DCJ, continued to listen well and qualified for the following additional awards: USA-CA 1500 #716, USA-CA 2000 #642, USA-CA 2500 #586, USA-CA 3000 #524, and All Counties #494. All awards are endorsed SSB, Mixed Bands. Lorraine is the first SWL in Wisconsin and the third SWL to win USA-CA All Counties.

Yasu-Tada Nimomiya, JH8GWW, added a gold seal to his certificate for USA-CA 1000 #880, 6-7-85, Mixed. Yasu's first 500 counties were all 10 meter SSB; his second 500 were all 20 meter SSB.

Robert D. Lee, W5OBT, continued to be heard with his fine signal from New Mexico, and now has USA-CA 1000 #881, Mixed, 6-14-85.

USA-CA 500 certificates went to:

Thomas James Arey, WB2GHA, USA-CA 500 #2032, All 20M/SSB, Mobile, 6-3-85.

Bill Providence, J88AQ, USA-CA 500 #2033, Mixed, 6-8-85. Bill's award is #1 to St. Vincent.

George Dessert, W3IJT, USA-CA 500 #2034, All SSB, 6-10-85.

Rajko Mackic, The Akademski Radio Klub, YU4GD, USA-CA 500 #2035, Mixed, 6-12-85.

Russell Pike, KT2C, USA-CA 500 #2036, All CW, 6-15-85.

Robert Tirk, KA9IKG, USA-CA 500 #2037, Mixed, 6-19-85.

Jan A. Petterson, SM5FQQ, USA-CA 500 #2038, Mixed, 6-25-85.

Istvan Bogyo, HAØDU, USA-CA 500 #2039, Mixed, 6-25-85. This is first USA-CA to Hungary.

Jauko Kurkisno, OH3ES, USA-CA 500 #2040, 6-26-85, All CW.

June A. Geiger, N9BAE, USA-CA 500 #2041, 6-26-85, All 2M/FM, Simplex, Mobile to Mobile. June's award is the first USA-CA endorsement for all 2M Simplex.

Robert H. Geiger, WD9ITQ, USA-CA

500 #2042, All 2M/FM, Simplex, Mobile to Mobile, 6-26-85. Roby has the second USA-CA endorsement for 2M Simplex.

### Awards Available

**Very High Speed Club.** The Radio Telegraphy Very High Speed Club was founded in May 1961 under the auspices of DARC and VERNON. The goal of the club is to gather operators who are able to transmit and copy very high speed telegraphy. Membership is gained by having four 30-minute contacts with existing members at a speed of at least 40 wpm. Copy must be solid and no keyboard or decoders may be used. The four recommendations should be sent with the application and accompanied by 10 IRC's or the equivalent. A declaration that a keyboard or decoder was not used must be included, and all must be sent to the VHSC Secretary. Life membership is granted with no further payment. For further information, and a list of the VHSC members, contact VHSC Secretary, PAØDIN, Din J. Hoogma, Schoutstraat 15, 6525 XR Nijmegen, Netherlands.



Worked DIG Members Award.

**Worked Dig Members.** The W-DIG-M may be applied for by all licensed radio amateurs and SWL's who can prove contact with DIG members as follows.

Class 3—DX stations work 15 DIG members, EU stations work 50 DIG members. Class 2—DX stations work 30 DIG members, EU stations work 75 DIG members. Class 1—DX stations work 50 DIG members, EU stations work 100 DIG members. All QSL's of DIG members listed in the DIG member list and the new DIG members published in the DIG nets are valid for this award. Expedition calls do not count additionally—either the home call or the expedition call.

The diploma is available for contacts on all shortwave bands and modes (mixed) or for contacts in CW only (CW Award) or for contacts on the VHF/UHF bands only (VHF Award). For worked 100 additional DIG members there are stickers up to 2000 DIG members (SASE or SAE plus 1 IRC). No QSL's, only GCR list and fee of 7 DM or 10 IRC's. Apply to Award Manager, Werner Theis, DB7PY, Auf dem Forst 25, D-5400 Koblenz, Federal Republic of Germany.



Specialized Communications Achievement Award.

**Specialized Communications Award.** This award is for FSTV, SSTV, FAX, RTTY, OSCAR, EME, Microwave, etc. Work over 50 miles on ATV, special-event projects on ATV, 25 DX countries on SSTV, 10 or more FAX two-way transmissions on HF bands, 10 contacts or more on AMSAT, 25 countries on RTTY.

The Specialized Communications Award is available only to subscribers of *Amateur Television Magazine*. For further information, send SASE or SAE and 1 IRC to *Amateur Television Magazine*, P.O. Box H, Lowden, IA 52255.

**The New SPAM Award.** The Society for the Promotion of Amplitude Modulation is pleased to announce the SPAM "100" Award. This award will be available to:

1. Regular SPAM members and officials for confirmation (by QSL card or letter) of two-way contact with 100 AM stations on the bands.



The "SPAM" Award.

2. SPAM Auxiliary (SWL/DX) members who submit the satisfactory evidence (confirmation by QSL card, letter, or special SPAM reception report form) of reception of the signal of 100 radio amateurs using the AM (DSB full carrier or SSB with carrier insertion) mode.

An attractive gold-color certificate for the SPAM "100" will be issued to each award winner. Send application and fee of \$5.00 US to: F.A. Dunlap, SPAM President, 14113 Stoneshire, Houston, TX 77060.

### Notes

Once more the season changes and summer holidays are a pleasant memory. Now we look forward to winter again in northern Illinois. I hope things are going well where you are.

73, Dorothy, WB9RCY

## "HOW TO" FOR THE NEWCOMER TO AMATEUR RADIO

### Novice Licensing Data—Part IV

**T**his article covers all of the material one must know to pass an FCC Novice written examination (FCC element two). All parts should be studied prior to attempting to pass the test. The first part of this article provides the overall introduction to this instruction material, plus complete coverage of electrical principles. Parts II and III appeared in the last two issues of *CQ*; they provided in-depth coverage of circuit components, practical circuits, signals and emissions, and operating procedures. Previous issues of *CQ* are usually available at \$2.25 each; requests can be sent to *CQ*, 76 North Broadway, Hicksville, NY 11801. If you know someone who is interested in becoming an amateur radio operator, you should bring this article to his or her attention.

#### Amateur Radio Practices

**2D-1.1 How can an amateur radio station be protected against being operated by unauthorized persons?** Lock the radio shack and/or the equipment input power switch. Hide equipment input power switch. Have station input on a separate line which is disabled when station is not to be used. Post a sign prohibiting unauthorized operation. Do not leave the station ready to be operated as soon as power is turned on. The automatic final RF amplifier power reduction protective feature built into modern transceivers provides an easy way to eliminate unauthorized full-power output; simply switch to an antenna that is incompatible with the band selected at the transceiver. (The March 1985 Novice column covers the use of electric power in fixed stations. That article includes suggestions that can be followed to minimize the possibility of unauthorized station use.)

**2D-2.1 Why should all antenna and rotor cables be grounded when an amateur radio station is not in use?** Such grounding protects station equipment from possible lightning and/or static discharge damage. Such electrical discharges should go directly to a suitable ground, without going to station equipment. The input coil of the receiver provides the discharge path in any station that does not have a separate grounding system. This is because the receiver is connected to the antenna system whenever the station is not in transmit mode.

**2D-2.2 How can an antenna system be protected from damage due to a nearby lightning strike?** The tower, plus all other nonradiating parts of the antenna system, should be connected to a good electrical ground. Whenever the station is not in use, the antenna system's radiating parts should also be grounded. The National Electric Code provides electrical wiring and grounding information that applies to amateur radio stations. This book should be available in every public library. It is essential reading for all amateurs. Article 810 is of particular importance to amateurs. (The September through



This is 14-year-old Mike Franzwa, KB6CDP, of Castro Valley, California. He has been licensed since September 1983. Mike has already contacted amateurs in 48 states and 13 countries. He won Easy Bay honors in the last ARRL Novice Roundup Contest. His station includes a Heath DX-40 transmitter with external VFO, Hallicrafters SX-101 receiver, Hustler 4-BTV vertical, and an 80 meter dipole.

November 1978 Novice columns cover amateur radio station grounding in detail. The November 1977 through March 1978 Novice columns include general grounding information within this article about amateur radio station installation tips. The April 1983 Novice column covers electric shock information that amateurs should know.)

**2D-2.3 How can amateur radio station equipment be protected from damage due to lightning striking the electrical wiring in the building?** Input power plugs can be disconnected from AC wall receptacles before a storm arrives. If a separate AC input power circuit breaker is used to feed the amateur radio station equipment, it can be pulled (opened) prior to the arrival of the storm. Most of the modern amateur radio equipment has surge protection built in to minimize the possibility of such damage.

**2D-3.1. For proper protection from lightning strikes, what pieces of equipment should be grounded in an amateur radio station?** All items in metal enclosures should be grounded to a common point, and that point should be connected to a satisfactory station ground. All ground leads should be at least ten-gauge wire, with ground cable preferred for use in this application.

**2D-3.2. What is a convenient indoor grounding point for an amateur radio station?** A cold-water pipe is the answer required in the test. However, I have helped install more than 1000 stations, and I have yet to find a cold-water pipe that provides a suitable ground. This answer would only be true if copper piping was used throughout the building.

**2D-3.3. To protect against electrical shock hazards, the chassis of each piece of equipment in an amateur radio station should be connected to what?** Each chassis should be connected to the common ground point, which is usually the chassis ground stud of the transmitter/transceiver. That common ground point is, in turn, at-

tached to an effective station ground via the shortest possible length of ground braid, or large diameter wire.

**2D-4.1. When working on an antenna mounted on a tower, a person doing the climbing should always wear what type of safety equipment?** A safety belt.

**2D-4.2. For safety purposes, how high should all portions of a horizontal wire antenna be located?** It should be located as high as it can be installed. It should be at least at a height where tall people cannot touch it. Secondly, it should be located where it cannot come in contact with power lines, if either the power lines or the antenna (and feedline) fall. Neither the antenna, nor its feedline, should be in close proximity or in line with either AC power or telephone lines.

**2D-4.3. What type of safety equipment should a person on the ground wear while assisting another person on an antenna tower?** A safety helmet (hard hat), and possibly an eye shield.

**2D-5.1. What is a likely indication that radio frequency interference to a receiver is caused by front-end overload?** The resultant RF interference would exist over a wide frequency range. In the case of television interference (TVI), it would distort reception on several channels.

**2D-5.2. When radio frequency interference occurs to a receiver regardless of frequency, while an amateur radio station is transmitting, what is likely the problem?** Receiver front-end overload is the most common cause of this problem. Another cause of this difficulty could be the TV receiver using a processing frequency (such as a local oscillator or intermediate frequency) that is the same (or close to) the amateur transmitting frequency.

**2D-5.3. What type of filter should be installed on a television receiver's tuner input as the first step in preventing overload from an amateur radio station's signal?** A high-pass filter should be installed at the tuner of the TV receiver to block lower frequency (3-30 MHz) amateur emissions, while passing the higher frequency TV signals.

**2D-5.4. What is meant by receiver overload?** Receiver overload is a condition wherein an extremely strong signal swamps the front end of a receiver, distorting reception over a wide range of frequencies.

**2D-6.1. What is meant by harmonic radiation?** A harmonic frequency is any fundamental frequency multiplied by a whole number (such as 2, 3, 4, etc.). Every transmitter radiates unintended harmonics along with the desired fundamental frequency, but such harmonic (multiple) frequencies must be at a much lower power level than the fundamental. Harmonic radiation is a very low level emission that occurs inadvertently at integral multiples of the fundamental frequency.

**2D-6.2. Why is harmonic radiation by an amateur radio station undesirable?** The harmonics may interfere with other radio services, since they may not fall within an amateur radio band. Also, any power transmitted on harmonic frequencies is power that is subtracted from the fundamental (intended) frequency output. A



typical example of harmonic interference is amateur 10 meter (28–29.7 MHz) operation causing second harmonic interference to TV channel 2 (54–60 MHz).

**2D-6.3. A multi-band antenna connected to an improperly tuned transmitter may radiate what type of interference?** Harmonic interference. As an example, if the antenna is resonant at 7, 14, 21, and 28 MHz, a 7 MHz fundamental (intended) output emission could be accompanied by second, third, and fourth harmonic (14, 21, and 28 MHz) which the multiband antenna would accept and radiate.

**2D-6.4. What is the purpose of properly shielding a transmitter?** Proper shielding prevents various processing frequencies from being radiated by the transmitter. Shielding also protects transmitter circuits from nearby electromagnetic energy which could otherwise degrade transmitter output.

**2D-6.5. When interference is observed on only one or two channels of a TV receiver while an amateur radio station is transmitting, what is the likely problem?** The most likely cause of such interference is harmonic radiation from an amateur radio transmitter. A low-pass filter could be installed between the amateur's transmitter and antenna system to alleviate (minimize) such a problem.

**2D-6.6. What type of filter should be installed on an amateur radio transmitter as the first step in reducing harmonic radiation?** A low-pass filter which passes the amateur HF (3–30 MHz) signals with very little attenuation (loss) while offering high rejection to TV VHF (30–300 MHz) and UHF (300–3000 MHz) signals.

**2D-7.1. Why is it important to have the impedance of a transmitter final-amplifier circuit match the impedance of the antenna or feedline?** Matched impedances provide maximum undistorted power transfer from the transmitter into the antenna. Matched impedances also provide maximum signal transfer between the antenna and the receiver. Impedances should be matched between the transceiver and the feedline, as well as between the feedline and the antenna. Matched impedances minimize the standing-wave ratio (SWR) that would otherwise exist. A high SWR condition reduces power transferred from the transmitter to the antenna, and from the antenna to the receiver.

**2D-7.2. What is the term for the measurement of the impedance match between a transmitter final amplifier circuit and the antenna or feedline?** Standing-wave ratio (SWR). This is simply the ratio between the high and low voltage points that exist along a feedline that is not perfectly matched to the antenna and/or transmitter/transceiver. An SWR of 3 to 1 (3:1) represents the following waveshape being present along the transmission line.

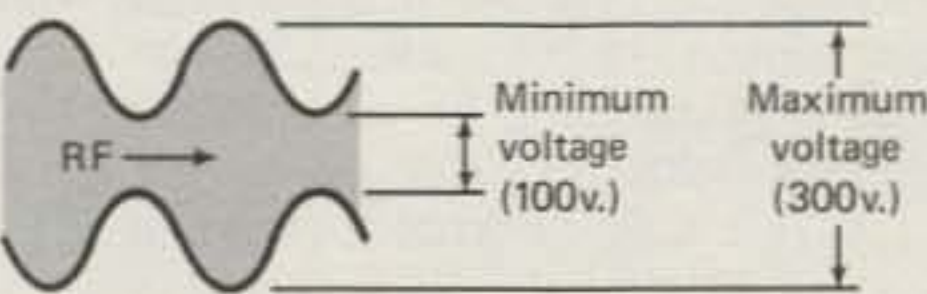

$$SWR = \frac{E_{\max}}{E_{\min}} \text{ or } \frac{I_{\max}}{I_{\min}}$$

In this example,

$$SWR = \frac{E_{\max}}{E_{\min}} = \frac{300}{100} = 3 (3:1)$$

If impedances were perfectly matched in this example, both the maximum and minimum voltage would be 200 volts, and the SWR would be 1:1.

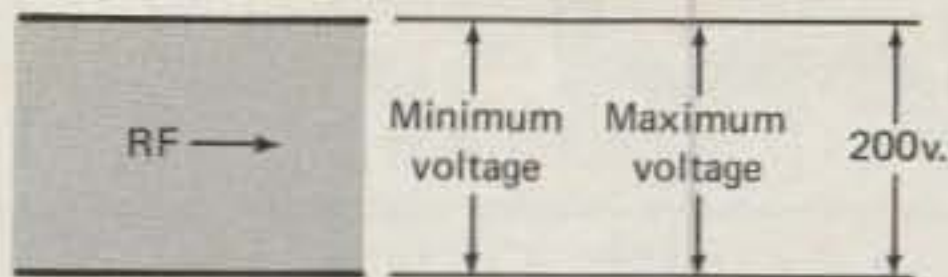

$$SWR = \frac{E_{\max}}{E_{\min}} = \frac{200}{200} = 1 (1:1)$$

An SWR of 3:1, or better (lower), is considered to indicate that satisfactory impedance matches exist between the transceiver and feedline, and between the feedline and antenna. Most of the modern transceivers are designed to automatically reduce RF final amplifier input power if the antenna system causes the SWR to exceed 3:1.

**2D-7.3. What station accessory is used to measure RF power being reflected back down the feedline from the transmitter to the antenna?** This question is asked incorrectly. It is the power that is not accepted by the antenna (due to impedance mismatch) that is reflected back down the feedline from the antenna to the transmitter. The device used to measure reflected power is the reflectometer, which is commonly called the standing-wave-ratio (SWR) bridge. The SWR bridge reads forward and reflected voltages; it automatically displays the SWR as determined by the following formula.

$$SWR = \frac{E_{\text{fwd}} + E_{\text{ref}}}{E_{\text{fwd}} - E_{\text{ref}}}$$

where:

$E_{\text{fwd}}$  is forward voltage

$E_{\text{ref}}$  is reflected/reverse voltage

The operator simply adjusts the SWR bridge to show a full-scale reading in the forward direction. The SWR bridge is then switched to show reflected (reverse) voltage, and the SWR is read off the meter scale.

**2D-7.4. What station accessory is often used to measure voltage standing-wave ratio?** A voltage standing-wave ratio (VSWR) bridge, which is commonly called an SWR meter, and is occasionally called a reflectometer.

**2D-7.5. Where should an SWR bridge be connected to indicate the impedance match of a transmitter and an antenna?** The only true reading occurs when the SWR meter is connected between the far end of the feedline and the input to the antenna. However, it is usually extremely difficult to adjust or read the SWR meter when it is attached to the antenna; consequently, it is usually installed in the radio shack, between the transceiver and the feedline. This latter installation configuration provides easy access to the SWR bridge, but the resultant readings are less accurate than the readings that would be available with the SWR bridge connected to the antenna (at the far end of the transmission line). This situation is due to the fact that the SWR bridge is not comparing the true forward and reflected voltages of the antenna when it is installed in one's radio shack. The shack-installed VSWR bridge sees a forward voltage that is higher than the voltage that will actually be applied to the input terminals of the antenna. This situation exists because there will be signal attenuation (loss) as the transmitter output travels along the feedline to the antenna. Similarly, the SWR bridge in one's radio shack reads a lower reflected voltage than exists at the antenna terminals; this is due to the reflected signal being attenuated (reduced) as it travels along the feedline from the antenna back towards the transmitter/transceiver and through the SWR

bridge. Consequently, the SWR bridge in the shack sees a higher forward voltage and a lower reflected voltage than those which exist at the antenna terminals. If the feedline is very bad, the shack-installed VSWR bridge could indicate a reasonable SWR despite a terribly bad mismatch condition existing between the feedline and the antenna. An apparent SWR improvement with time is usually due to feedline deterioration and increased signal attenuation (loss).

**2D-7.6. Coaxial feedlines are designed to be operated with what kind of standing-wave ratio?** A low standing-wave ratio (SWR). However, most types of coaxial cables are designed to withstand reasonably high standing-wave ratios. High SWR's produce high maximum voltages between the center (go) line and the return (shield) of the coaxial cable. An excessively high voltage can puncture (short circuit) the insulation between the conductors of a coaxial cable. (*The August 1983 Novice column provides information about military radio frequency transmission lines. It is a useful article for new amateurs to read.*)

**2D-7.7. If the SWR bridge reading is higher at 3700 kHz than at 3750 kHz, what does this indicate about the antenna?** It usually indicates that the antenna is closer to being resonant at 3750 kHz than at 3700 kHz. The SWR is generally lowest (minimum/best) when the frequency of the input signal matches the resonant frequency of the antenna.

**2D-7.8. If the SWR bridge reading is lower at 3700 kHz than at 3750 kHz, what does this indicate about the antenna?** It usually indicates the antenna is closer to being resonant at 3700 kHz than at 3750 kHz. However, the impedance of a dipole changes in relationship to its height above electrical ground. (*The May through July 1983 Novice columns cover dipole antennas in detail. Since the dipole is the first antenna most new amateurs erect, this previous article is worthwhile reading.*)

**2D-8.1. What kind of SWR meter reading may indicate poor electrical contact between parts of an antenna system?** A high SWR reading could indicate an unsatisfactory condition requiring correction. The problem could be poor connections between the transceiver and SWR bridge, the SWR bridge and the feedline, or the feedline and antenna. A high VSWR reading could also be due to an antenna problem. Poor contacts in an antenna system usually produce SWR readings far greater than 3:1, which is generally recognized as the acceptable (maximum) SWR limit.

**2D-8.2. High SWR reading measured from a half-wave dipole antenna being fed by coaxial cable can be lowered by doing what to the antenna?** The test answer to this question is to lengthen or shorten the antenna to lower the SWR. This is a silly answer. If a dipole has been cut to the correct length, and it has been assembled properly, its length should not be varied. The input impedance varies in accordance with the antenna's height over electrical ground. Consequently, it should help to raise or lower the antenna. If you can change it both directions, raise it to a height where the resultant SWR is minimum.

## Part IV Summary

This completes the fourth part of this series. We have covered six of the nine subelements (subjects) contained in the FCC element two (Novice) syllabus. The next few Novice columns will cover the rules and regulations. Seven of the 20 questions in each Novice written examination are on rules and regulations, which is 35 percent of the exam.

# Contest Calendar

a monthly feature by  
FRANK ANZALONE, W1WY

## NEWS/VIEWS OF ON-THE-AIR COMPETITION

As mentioned in last month's column, there have been a few changes and additions to the trophy and plaque awards in our 1985 World-Wide DX Contest. The most notable change is the sponsorship of the World All-Band Phone award, which Bill Leonard, W2SKE, has been donating for almost 30 years. Bill has turned over the sponsorship of this award to Dave Rosen, K2GM, who will continue it as a memorial for his father, the late, well-remembered "Doc" Rosen, WA2RAU.

Our grateful thanks to Bill, who along with the late Larry LeKashman (W2IOP at the time) started the trophy awards list which now numbers over 60.

The late Don Wallace, W6AM, and "Buzz" Reeves, K2GL, are also long-time donors. Don's award is being continued as a memorial by the Southern California DX Club, of which Don was a member.

The Carib./C.A. awards vacated by Jim Neiger, N6TJ, have been picked up by Alex Kasevich, VP2MM, on phone, and Peter Munroe, WB1DQC, on CW.

The Carolina DX Association and the Southern New England DX Club have picked up the USA Multi-Single Phone and the European Single-Band CW awards terminated by K8NA and the G2LB memorial.

An added new one is the South American All-Band CW Memorial sponsored by the Venezuela DX Club.

I am sure that you will note that many of these awards are memorials. Can you think of a more appropriate way to perpetuate the call of a deceased club member? The North Jersey DX Association has been doing this for years for two of their "Silent Keys," K2HLB and W2JT.

Questions regarding future sponsorship of awards in any CQ contest can be addressed to me, and I will make sure they are forwarded to the respective contest directors. We are especially looking for donors of awards in our 160 Meter Contest coming up in January and February 1986. However, we must hear from you as soon as possible, as time is running out.

Deadline for the January issue is October 15th and November 15th for February. Sending your announcements to my home address will give additional time.

Have you checked the expiration date of your license lately?

73 for this time, Frank, W1WY

14 Sherwood Road, Stamford, CT 06905

### Calendar of Events

- \* Oct. 5-6 California QSO Party
- Oct. 5-6 Ibero-American SSB Contest
- Oct. 5-6 ARRL CW QSO Party
- Oct. 5-6 VK/ZL/Oceania SSB Contest
- Oct. 5-7 Kansas State QSO Party
- \* Oct. 6-7 Illinois QSO Party
- Oct. 12-13 VK/ZL/Oceania CW Contest
- Oct. 12-13 Pennsylvania QSO Party
- Oct. 12-13 ARCI QRP CW Contest
- Oct. 12-13 ARRL Phone QSO Party
- Oct. 13 RSGB 21/28 MHz Phone
- Oct. 16-17 YLRL Anniv. CW Party
- Oct. 19-20 Boy Scouts Jamboree
- Oct. 19-21 Rhode Island QSO Party
- Oct. 20 RSGB 21 MHz CW Contest
- Oct. 26-27 CQ WW DX Phone Contest**
- Oct. 30-31 YLRL Anniv. SSB Party
- Nov. 2-3 IPA Radio Club Contest
- Nov. 2-4 ARRL CW Sweepstakes
- Nov. 9-10 European RTTY Contest
- Nov. 9-10 Silver Jubilee "Electril"
- Nov. 16-18 ARRL Phone Sweepstakes
- Nov. 23-24 CQ WW DX CW Contest**
- Dec. 7-9 ARRL 160 Meter Contest
- Dec. 14-15 ARRL 10 Meter Contest

\* Covered last month.

### Ibero-American SSB DX Contest

2000Z Sat. to 2000Z Sun., Oct. 5-6

Organized by the URE of the "Valles Oriental" section, this contest commemorates the "Hispanidad," which is celebrated on October 12th.

Single operator only, on all 6 bands, 10 to 160 meters.

**Exchange:** RS plus a QSO number starting with 001.

**Points:** Between Ibero-American stations 3 points per QSO, non-Ibero stations 1 point. A station may be worked once on each band for QSO and multiplier credit.

**Multiplier:** Each Ibero-American station worked on each band: CE, CO, CP, CR, CT, CX, C3, C9, DU, EA, HC, HI, HK, HP, HT, KP4, LU, OA, PY, TG, TI, XE, YS, YV, ZP, 3C, and DXCC Dependences.

**Score:** Total QSO points times the Ibero-American multiplier from each band.

**Awards:** A plaque will be issued to the champion outside the Ibero-American area, and to the high scores in each continent and DXCC countries. A minimum of 4 hours and 75 QSO's must be worked to be eligible for the awards.

There is an SWL section with the same scoring conditions. A special plaque will be awarded to the winner who has participated 5 or more years.

All entries must be postmarked no later than November 30th and go to: Dele-

gacion Comarcal URE Valles Oriental, P.O. Box 262, Granollers (Barcelona), Spain.

### Kansas State QSO Party

0100Z to 0700Z Sat., Oct. 5  
1300Z Sat. to 0700Z Sun., Oct. 5-6  
1300Z Sun. to 0100Z Mon., Oct. 6-7

This is the fourth annual QSO Party sponsored by the Boeing Employees' ARS of Wichita, Kansas.

The same station may be worked on each band and each mode, for contact points, and more than once if they are additional multipliers. Kansas can work in-state stations for QSO and multiplier credit.

**Exchange:** QSO no., RS(T), and QTH. County for Kansas; state, province, or country for others.

**Scoring:** Two points for phone QSOs, three points if on CW. Kansas stations multiply total QSO points by the sum of different states, VE provinces, and DX countries worked.

Others will use sum of different Kansas counties worked for their multiplier (counted once only, maximum of 105). There is also a bonus multiplier of one for each group of 8 QSOs with the same Kansas county.

**Frequencies:** CW—1805, 3560, 7060, 14060, 21060, 28160. SSB—1815, 3925, 7260, 14280, 21380, 28580. Novice—3725, 7125, 21150, 28160.

**Awards:** Certificates to the top-scoring station, both single and multi-operator, in each state, VE province, DX country, and Kansas county. Work five club members and you will be eligible for the worked five Kansas Bears Award.

Include a summary sheet and a dupe sheet if your log shows more than 200 contacts. The usual signed declaration is also required. Logs and summary sheets are available; include a large SASE with your request to the address below.

Mailing deadline for all entries is November 12th to: Boeing Employees' A.R.S., c/o Mike Thornton, WA0TAH, P.O. Box 16534, Wichita, KS 67216.

### ARRL QSO Party

C.W.: Oct. 5-6 Phone: Oct. 12-13  
1800Z Saturday to 0600Z Sunday

This event is similar to the annual Open CD Party, which has been phased out, and it is open to all ARRL members. Operate a maximum of 10 hours out of the 12-hour period. Off times must be at least

30 minutes and must be clearly indicated in the log.

**Exchange:** Your "status" and ARRL section (MBR member, ORS official relay station, etc.).

**Scoring:** Total QSO's from all bands times number of ARRL sections worked (maximum of 74). Phone and CW are separate and require separate logs. A dupe sheet is also required if you make more than 200 contacts.

Referring you to a current issue of *QST* for more details is academic, since all members of course receive *QST*. Anyway, be sure to get your entry to the ARRL, 225 Main Street, Newington, CT 06111 within a month of the above dates.

### VK/ZL/Oceania DX Contest

SSB: Oct. 5-6 CW: Oct. 12-13  
1000Z Saturday to 1000Z Sunday

There have been some small modifications in the rules of this year's old-time contest. This year it commemorates the 75th anniversary of the Wireless Institute of Australia and the 50th year of the VK/ZL contest.

Following rules are for stations other than VK/ZL. Oceania stations can work anyone. The rest of the world work VK, ZL, and Oceania stations only. The same station may be contacted on each band for QSO and multiplier credit (no WARC bands).

**Exchange:** RS(T) plus a three-figure QSO number starting with 001.

**Scoring:** Same for everybody, 2 points per QSO.

**Multiplier:** Each VK/ZL and Oceania prefix worked on each band.

**Final Score:** Total QSO points from all bands times the sum of the prefix multiplier from each band.

**Awards:** This year there will be awards to the top scorers in each continent. These will be in the form of leather-bound log books, and medallions to the top scorers in countries that submit 10 or more entries. Certificate awards will be made at the discretion of the contest manager.

There is an SWL section. Only VK, ZL, or Oceania stations are reported. Call of station being worked and RS(T) being sent and received must be reported. Scoring same as above, but SSB and CW scores are combined for final score.

Include a summary sheet showing the scoring, use separate log sheets for each band, and include the usual signed declaration that all rules and regulations have been observed.

This year they go to: W.I.A. VK/ZL/O Contest Manager, 1 Noorabil Court, Greensborough, Vic. 3088, Australia. All entries must be received no later than January 31, 1986.

### ARCI QRP CW Contest

1200Z Sat. to 2400Z Sun., Oct. 12-13

This is the fall edition and 24th anniversary

of the QRP Amateur Radio Club International. This year's activity will be found on CW only. Participants may operate the full 24 hours.

**Exchange:** RS(T) and state, province, or country. Members will include their number; non-members their power output.

**Scoring:** Contacts with members, 5 points. Non-members, 2 points if in same continent, 4 points if in a different continent. The same station may be worked on each band for QSO and multiplier credit.

There is a power output bonus: 4 to 5 watts— $\times 2$ ; 3 to 4 watts— $\times 4$ ; 2 to 3 watts— $\times 6$ ; 1 to 2 watts— $\times 8$ ; less than 1 watt— $\times 10$ ; over 5 watts check log only.

The following bonus multipliers are also available: solar or wind power— $\times 2$ ; battery power— $\times 1.5$ . Must be used for duration of contest.

**Multiplier:** Each state, VE province, and DX country worked on each band.

**Final Score:** Total QSO points from all bands  $\times$  (states + provinces + countries)  $\times$  power bonus  $\times$  power type if any.

**Frequencies:** 1810, 3560, 7040, 14060, 21060, 28060, 50360. Novice—3710, 7110, 21110, 28110.

**Awards:** Certificates to the highest scorers in each state, province, and DX country with two or more entries. All entries will be considered for the Triple Crown QRP Award. In addition, Adrian Weiss, WØRSP, is sponsoring a special *Milliwatt* certificate to be awarded to the top-scoring station in the less than 1 watt category, providing there are two or more entries in that category.

Use a separate log sheet for each band. Include a summary sheet showing the scoring, equipment description, and other essential information. Include a large SASE for a copy of the results. It is suggested you send a large SASE to KA5NLY for official log forms.

Logs must be received by November 13th and go to: QRP ARCI Chairman, Gene Smith, KA5NLY, P.O. Box 55010, Little Rock, AR 72225.

### Pennsylvania QSO Party

1600-0500Z Sat.-Sun., Oct. 12-13  
1300-2200Z Sun., Oct. 13

This is the 28th annual party sponsored by the Nittany A.R.C. of State College, Pennsylvania. The same station may be worked on each band and mode for QSO points. PA stations may also work other PA stations for QSO and multiplier credit. Mobiles may be worked in each county change.

**Exchange:** RS(T), three-digit QSO number, and QTH. County for PA, ARRL section for others.

**Scoring:** One point for SSB contacts, 1.5 points for CW, 2 points for CW on 80 and 160.

PA stations multiply total by ARRL sec-

tions + PA counties + 1 DX country worked. Others use PA counties for their multiplier (maximum of 67).

Mobiles add 500 bonus points for each county operated from, minimum of 10 QSOs. Mobiles on county lines give one QSO number but get credit for two multipliers.

**Frequencies:** CW—1810 and 40 kHz up from bottom edge of each CW band. SSB—1850, 3980, 7280, 14280, 21380, 28580. Novice—10 up from bottom of each Novice band. Mobile—5 kHz below listed frequencies. Try 160 at 0300Z.

**Awards:** Will be made in five classes—single operator, multi-single, multi-multi, mobile, and QRP (maximum 5 watts). Certificates to winners in each county, each section, and club (minimum of 3 members and 20 QSOs). Plaques to top scorers in both eastern and western PA, out-of-state, both multi's, mobile, western USA, and QRP (*quite a selection—ed.*)

Include a summary sheet with your entry showing the scoring, a check list of counties or sections worked, and a dupe sheet if you make 100 or more contacts. There is a severe penalty of 100 points deducted for each dupe that has not been removed.

Official log forms are recommended and are available from W3HDH. For a copy of the results send 50¢ (no SASE).

Mailing deadline for entries is November 15th to: Douglas R. Maddox, W3HDH, 1187 S. Garner Street, State College, PA 16801.

### YLRL Anniversary Party

C.W.: Oct. 16-17 Phone: Oct. 30-31  
1800Z-1800Z Wed.-Thurs.

This is the 46th annual party run by the YL Radio League. It is open to all YL's around the world, and activity is between YL's only on all bands, 3.5 through 28 MHz. Phone and CW are separate contests and require separate logs and awards.

**Exchange:** QSO no., RS(T), and ARRL section. DX stations will indicate their country.

**Scoring:** One point per QSO between stations within an ARRL section and between DX stations. Two points if the QSO is between a DX station and an ARRL section station. The same station may be worked *once only* regardless of the band.

**Multiplier:** Is figured from the number of ARRL sections and DX countries worked. There is also a low power multiplier of 1.25 if power input is 150 watts or less on CW, 300 watts PEP on SSB.

**Final Score:** Total QSO points from all bands times the ARRL sections and DX countries worked times the power multiplier.

For each duplicate contact that is removed from the log in the course of checking, a penalty of three additional and equal contacts will be exacted.

**Frequencies:** CW—3555, 7055, 14055,

21195, 28195. SSB—3955, 7255, 14295, 21395, 28595. (Plus or minus 15 kHz.)

**Awards:** Gold cups to the top scorers in each contest. A plaque to the highest combined phone/CW score, and the Corcoran and Hagen memorial plaques. Certificates to the first, second, and third place overall winners and in each U.S. and VE call area and DX country. Only YLRL members are eligible for the cup and plaques.

Logs must be received no later than December 10, and this year go to: Marty Silver, NY4H, 3118 Eton Road, Raleigh, NC 27608.

### RSGB 21/28 MHz Phone Contest

0700 to 1900 GMT Sunday, Oct. 13

It's the world working the British Isles on 21 and 28 MHz.

The same station may be worked on each band for QSO and multiplier credit. There are a total of 42 prefixes available on each band. Following are the rules for areas other than the British Isles.

**Sections:** Single operator and multi-operator, both bands only, and SWL.

**Exchange:** RS report plus a progressive QSO number starting with 001.

**Scoring:** Each contact with a B.I. station is worth 3 points. Multiply total QSO points from each band by the sum of B.I. prefixes worked on each band (maximum of 42 per band). The GB prefix does not count for QSO or multiplier.

Unmarked duplicate contacts will be penalized 10 times the points claimed. Logs containing more than 5 unmarked duplicates will be disqualified.

There is also an SWL section. Only B.I. stations are to be logged. Scoring is the same as indicated above. The same call sign may appear once only in every three contacts, except when the logged station is a new multiplier.

**Awards:** Overseas stations will be awarded certificates to the leading station in each country and the leading station in the multi-operator section, and to the SWL winner in each country. The first, second, and third overall winners will also receive certificates of merit.

Separate log sheets are required for each band. Include a summary sheet showing the scoring, prefixes worked, and a signed declaration that rules and regulations have been observed.

Logs must be received by December 3rd. This year they go to: RSGB HF Contests Committee, c/o M. Harrington, 123 Clensham Lane, Sutton, Surrey SM1 2ND, England.

### RSGB 21 MHz CW Contest

0700 to 1900 GMT Sunday, Oct. 20

Like the 21/28 MHz Phone Contest, the activity in this one is between the British Isles and the rest of the world. Competition is limited to single operator stations

only. There is a separate QRP section in which power input must not exceed 10 watts, and there is also an SWL section.

The following rules are for areas other than the British Isles.

**Exchange:** RST report plus a progressive QSO number starting with 001.

**Scoring:** Each contact with a B.I. station is worth three points. Multiply total QSO points by the number of B.I. prefixes worked (G2, G3, GD3, etc.). A maximum of 42 is possible. (GB does not count for QSO or multiplier.)

Unmarked duplicate contacts for which credit has been taken will be penalized ten times the points claimed. Logs containing more than five unmarked duplicates will be disqualified.

Only British Isles stations are to be logged by overseas SWL's. The same call may be reported only once in every three contacts, unless the logged station is a new multiplier. Scoring is the same as above.

**Awards:** Certificates to the three leading stations in each overseas country, both transmitting and SWL.

Include a summary sheet with a list of prefixes worked, station description, the usual signed declaration, and your name and address in block letters.

Logs must be received by December 31st. This year they go to: RSGB HF Contests Comm., c/o J. Bazley, G3HCT, "Brooklands" Ullenhall, Solihull, Warks. B95 5NW, England.

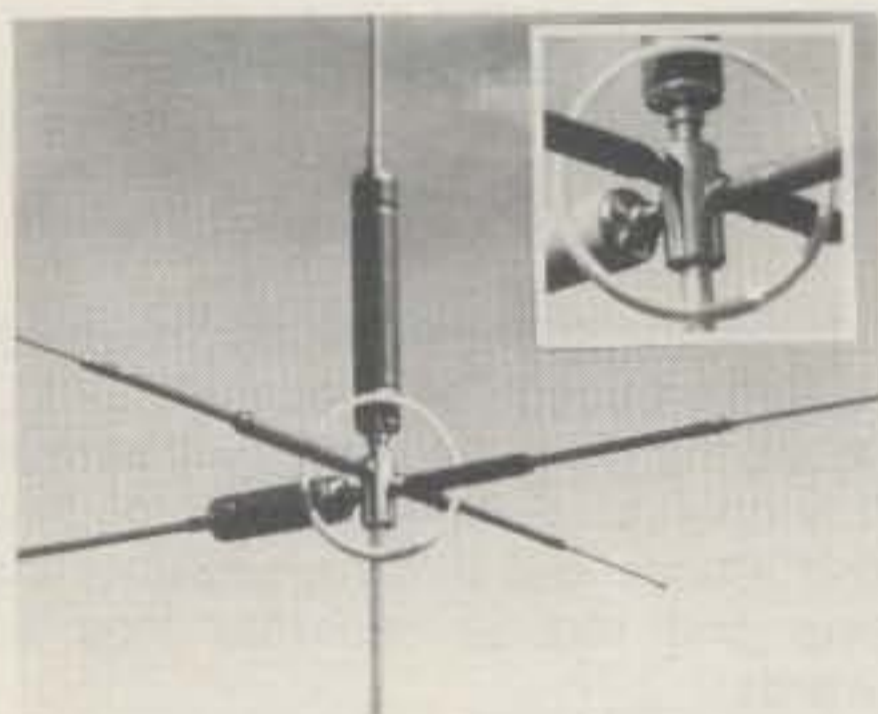

#### X-PANDA-FIVE \$15.00

(Plus \$1.50 Shipping & Handling. Florida Residents Add 5%.)  
(Foreign orders please add \$5.00 US funds for Shipping)

- X-PANDA-FIVE converts your Hustler or Hy-Gain mobile antenna from one to five bands. Add as many resonators for the bands you wish to operate. Adjust resonators for minimum SWR, no stopping to change bands any more.
- X-PANDA-FIVE with proper resonators and good ground plane makes an ideal system for apartments and condominiums.
- X-PANDA-FIVE can be used to make a multi-band antenna system for vans, campers, motor homes and travel trailers.
- X-PANDA-FIVE will accept either regular or super size resonators

Name \_\_\_\_\_  
Call \_\_\_\_\_  
QTH \_\_\_\_\_

To: J.L. INDUSTRIES  
P.O. Box 547, Hallandale, FL 33009

## The Mean Little Kit



New compact 24-piece kit of electronic tools for engineers, scientists, technicians, students, executives. Includes 7 sizes screwdrivers, adjustable wrench, 2 pair pliers, wire stripper, knife, alignment tool, stainless rule, hex-key set, scissors, 2 flexible files, burnisher, miniature soldering iron, solder aid, coil of solder and desoldering braid. Highest quality padded zipper case, 6 x 9 x 1 3/4" inside. Satisfaction guaranteed. Send check, company purchase order or charge Visa or Mastercharge. We pay the shipping charges.

**JTK-6 Tool Kit . . . . . \$89.00**

#### Free Catalog!

Page after page of hard-to-find precision tools. Also contains complete line of tool kits and tool cases. Send for your free copy today!



**JENSEN TOOLS INC.**  
7815 South 46th St., Phoenix, AZ 85044-5399  
Phone: 602-968-6241 TWX: 910-950-0115

CIRCLE 124 ON READER SERVICE CARD

# AUSTIN. When only the best will do!

Taking the leading role in custom antenna design comes easily to Austin. With over 25 years of engineering and consulting experience, how could we offer you less than the best?

And our high performance solutions go beyond our popular MULTIBAND antennas.

There's THE OMNI sidebander with horizontal and vertical polarization. Or the ALL BAND SCANNER with high gain that outperforms the competition. And THE STICK, a broad band design for operation from Amateur to Marine frequencies. Just a sampling of the choices available.

Whatever your antenna needs, the winner is Austin.

Call or write for product information.  
Dealer inquiries invited.

CIRCLE 99 ON READER SERVICE CARD

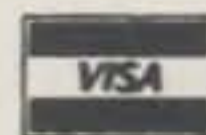

**AUSTIN  
CUSTOM  
ANTENNA**  
P.O. Box 357  
Sandown, NH 03873  
(603) 887-2926

## Rhode Island QSO Party

1700Z Sat. to 0500Z Sun., Oct. 19-20  
1300Z Sun. to 0100Z Mon., Oct. 20-21

This one is again being sponsored by the East Bay AWA (WA1YPN). The same station may be worked on each band and each mode. RI stations may contact other RI stations for QSO points.

**Exchange:** RS(T) and QTH. City or town for RI; state, province, or DX country for others.

**Scoring:** Phone QSOs are worth 2 points, CW 3 points, and Novice/Tech. 5 points.

RI stations multiply total QSO points by the number of states, VE provinces, and DX countries worked. Others by the different RI cities and towns worked for their final score (39 cities and towns).

**Frequencies:** CW—1810, 3550, 3710, 7050, 7110, 14060, 21050, 21110, 28050, 28110. Phone—3900, 7250, 14300, 21360, 28600, 50110, 144.2 and 146.52. (Use of FM simplex is encouraged. No repeaters.)

**Awards:** Certificates to the top-scoring single operator station in each RI county, and each state, province, and country. The top-scoring Novice/Tech. in RI and out of state will also be rewarded, as will the winning RI multi-operator station.

Include a summary sheet with your entry showing the scoring and other essential information, and an SASE for a copy of the results.

Mailing deadline is November 30th to: East Bay AWA Inc., P.O. Box 392, Warren, RI 02885.

## Scouts Jamboree On The Air

Starts: 0001 Local Time Sat., Oct. 19  
Ends: 2359 Local Time Sun., Oct. 20

This is the 28th annual Jamboree sponsored by the World Bureau of Scouts. Activity is world wide and includes not only Scout units, but Girl Scouts and Guides, too. This is not a contest, but an opportunity for Scouts or anyone interested in Scouting to get together on the air and exchange greetings. Amateurs can invite members of Scout units or individuals to visit their stations or clubs and see how ham radio operates.

No specific exchange, no scoring, and no logs are required. However, participating post-card-size certificates issued by the World Scout Bureau are available. They may be requested before the JOTA weekend for distribution and included with your QSL's of JOTA contacts. Send a large s.a.s.e. to: Jamboree on the Air, 1325 Walnut Hill, Irving, TX 75062; 22¢ postage for 10 cards, 17¢ for each additional 8.

**Suggested Frequencies:** Phone—3940, 7290, 14290, 21360, 28990. CW—3590, 7030, 14070, 21140, 28190. Also Novice bands, SSTV, and RTTY.

I suggest you write to W2GND for addi-

tional details. Stateside participants send reports to Harry A. Harchar, W2GND, 216 Maxwell Ave., Hightstown, NJ 08520.

## CQ World-Wide DX Contest

Phone: Oct. 26-27 CW: Nov. 23-24  
0000Z Saturday to 2400Z Sunday

Complete rules were published in last month's issue and are the same as those used last year. There have been a few changes and additions in the sponsors of the more than 60 trophies and plaques that will be awarded in the 1985 contest. The Team Contesting category has been retained and will be given another year trial.

You are again reminded to study the disqualification clause. Penalties have been clearly defined for taking credit for duplicate contacts. You may not only risk a deduction in your score, but also possible disqualification, especially if you were cited in last year's contest.

There are other items that might lead to being disqualified—sportmanship and regulation violations. Reading the comments in the phone results last month (USA QRM item) would indicate that there are areas for improvement. The Contest Committee is cognizant of the fact and will be watching those areas in this year's contest.

*Note:* The double asterisk (\*\*) at the bottom of the rules page should read "Except the Gordon Marshall, W6RR African Award."

Repeating the deadline, all entries must be postmarked NO LATER than December 1, 1985 for the phone section and January 15, 1986 for the CW section. An extension may be given if requested in writing.

Again this year all logs must be sent directly to: CQ World-Wide DX Contest, 76 North Broadway, Hicksville, NY 11801 U.S.A. Be sure to indicate Phone or CW on the envelope.

*... at last ...*

### your shack organized!

A beautiful piece of furniture — your XYL will love it!

## \$184.50 S-F RADIO DESK

**Deluxe - Ready to Assemble**

Designed with angled rear shelf for your viewing comfort and ease of operation.

**FINISHES:** Walnut or Teak Stain.

**Floor Space:** 39" Wide by 30" Deep

**SF**

Additional Information on Request.  
Checks, Money Orders, BankAmericard and Master Charge Accepted.

F.O.B. Culver City. (In Calif. Add 6% Sales Tax.)  
DEALER INQUIRIES INVITED

**S-f Amateur Radio Services**

**4384 KEYSTONE AVENUE • CULVER CITY, CALIF. 90230 — PHONE (213) 837-4870**

CIRCLE 86 ON READER SERVICE CARD

## The DX EDGE®: Regular or Computerized

Both have one purpose: to improve your DX performance by letting you know when & where to look for rare DX.

**New Faster Computerized Version for Commodore 64™**

- Real time DX help in the finest graphics
- Daylight/darkness areas of the world at any time of day, any time of year.
- Sunrise/sunset times anywhere
- Automatic real time gray line updates
- Pinpoint any QTH in the world
- QTHs keyed to DXCC list & 40 Zones
- Complete & easy instructions.

### Regular (the Original DX EDGE®)

The everyday DX operating aid used around the world and on major DXpeditions

- Large plastic slide rule format • 1 slide for each month • Long path & short path
- Great circle slides to show beam direction available; specify your latitude.

**Prices:** C-64 version: \$34.95; Regular: \$16.95; Great circle slides \$3 with DX EDGE, \$5 without, ppd. All ppd. in U.S., Canada. Add \$4.00 elsewhere. Add tax in NYS. U.S. funds only. Please make check or M.O. payable to the DX EDGE and mail to:  
**The DX EDGE, P.O. Box 834, Madison Square Stn. New York, N.Y. 10159.**

An information flyer is available free of charge.

A product of Xantek, Inc. ©Xantek, Inc. 1985  
Commodore 64 is a trademark of Commodore Electronics Ltd.

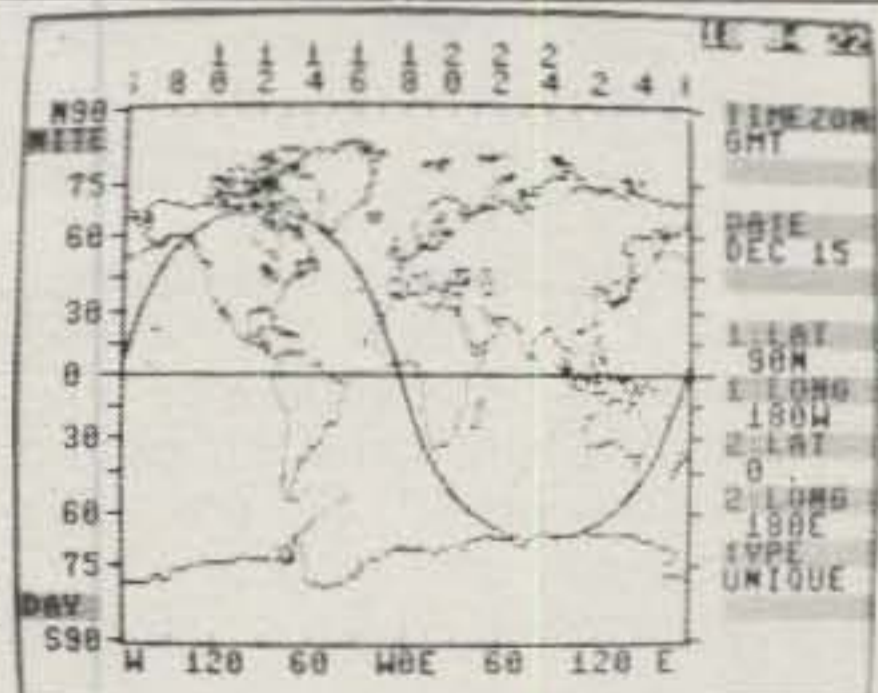

## THE SCIENCE OF PREDICTING RADIO CONDITIONS

### Contest Special

The 1985 CQ World-Wide DX Contest will be held on the following dates:

October 26-27—Phone Section

November 23-24—CW Section

Continuing with the practice of the past 35 years, this month's propagation column is devoted to special forecasts for the contest periods, both phone and CW.

#### Rapidly Decreasing Solar Activity

The present cycle continues to decline rapidly towards its eventual end. The *Royal Observatory of Belgium*, the world's official record keeper of sunspot data, reports a mean sunspot number of 24 for June 1985. This results in a smoothed sunspot number of 21 centered on December 1984. This is a drop of four numbers in a one-month period. A smoothed sunspot number on the order of 14 is forecast for October 1985. This corresponds to a 10.7 cm solar flux level of approximately 80.

The level of solar activity expected during October is the lowest to be forecast for a CQ World-Wide DX Contest since 1964, although activity during the 1976 contest period was almost as low. By comparison, in 1979, when the present cycle was enjoying peak activity, the level during the contest period was between 158 and 162. During last year's contest period the cycle stood at the 29 mark in October and at 25 in November.

Statistically, this means that general DX contest conditions, particularly on the 10, 15, and 20 meter bands, are expected to be at their poorest level in 21 years. But don't despair. The ionosphere, although weaker, is not going to disappear. There should still be plenty of world-wide DX to be worked, but it's going to require more skill and patience to do it. While conditions are expected to worsen considerably on 10 and 15 meters, 20 meters should continue to be a world-wide DX band during the daylight hours, and nighttime DX openings on 40, 80, and 160 meters may actually improve a bit when compared to previous years of higher solar activity.

While the expected decline in solar activity and the corresponding degradation of HF propagation conditions can rightfully be greeted with jeers, moans, and

#### LAST MINUTE FORECAST

Day-to-Day Conditions Expected for October 1985

Propagation Index . . . . .	Expected Signal Quality			
	(4)	(3)	(2)	(1)
Above Normal: 4, 9, 31	A	A	B	C
High Normal: 5, 8, 15, 21-22	A	B	C	C-D
Low Normal: 3, 6-7, 10, 13-14, 16-17, 20, 23, 25-26, 29-30	A-B	B-C	C-D	D-E
Below Normal: 2, 11-12, 18-19, 24, 27-28	B-C	C-D	D-E	E
Disturbed: None	C-E	D-E	E	E

Where expected signal quality is: A—Excellent opening, exceptionally strong, steady signals greater than S9.

B—Good opening, moderately strong signals varying between S6 and S9, with little fading or noise.

C—Fair opening, signals between moderately strong and weak, varying between S3 and S6, with some fading and noise.

D—Poor opening, with weak signals varying between S1 and S3, and with considerable fading and noise.

E—No opening expected.

#### HOW TO USE THIS FORECAST

1. Find propagation index associated with particular band opening from Propagation Charts appearing on the following pages.
2. With the propagation index, use the above table to find the expected signal quality associated with the band opening for any day of the month. For example, an opening shown in the charts with a propagation index of 3 will be poor to nil (D-E) on the 1st, fair to poor (C-D) on the 2nd, good to fair (B-C) on the 3rd, excellent (A) on the 4th, etc. Above normal conditions are expected for the WDX Contest on the 26th, dropping to below normal on the 27th.

groans by DXers, it is part of the amateur radio challenge, and it is what makes amateur radio so interesting. If you plan to participate in the 1985 DX contest, the DX propagation charts and other information appearing in this month's column are designed to help you stay "sharp," and to make use of the ionosphere for piling up as many contest points as possible, despite the decline in solar activity.

#### General Conditions, Band By Band

The following is a band-by-band summary of DX propagation conditions normally expected from mid-October through mid-December, and entered on the contest periods.

**10 Meters:** With the bottom of the present sunspot cycle slowly approaching, very few DX openings are expected on this band. During High or Above Normal conditions look for some openings towards Africa before noon, towards Central and South America from a few hours before until a few hours after noon,

and towards the South Pacific during the afternoon.

**15 Meters:** Although DX conditions are not expected to be as good as last year, 15 meters should be a fairly good band during most of daylight hours. When conditions are Normal, the band should open to many areas of the world from shortly after sunrise through the late afternoon. Signals from Europe and Africa should peak an hour or two before noon, while signals from Central and South America, the Far East, and the South Pacific should peak during the late afternoon. During Below Normal or Disturbed conditions, 15 meter openings will be spotty and of very short duration, if possible at all.

**20 Meters:** This is again expected to be the "backbone" band during the contest. During Normal conditions good DX openings are expected to almost every corner of the world sometime between sunrise and the early evening hours. Conditions should peak for a few hours after sunrise and again during the late afternoon and early evening. During these peak periods, 20 meters should be the optimum band for DX, with openings usually characterized by strong signal levels. When conditions are Below Normal, 20 meter openings should be fewer in number, of shorter duration, and with weaker signal levels. In general, however, the band should hold up for some DX openings during all but Disturbed conditions.

**40 Meters:** The band is expected to open during the late afternoon hours, and remain open for DX to one area of the world or another until shortly after sunrise. Look for openings to Europe and Africa from an hour or so before sundown to about midnight in the MST and PST time zones, and to at least 2 a.m. in the CST and EST zones. Good openings towards Central and South America should be possible throughout most of the hours of darkness. Openings towards the South Pacific and the Far East are expected to peak during a two-hour period before sunrise. During most of the hours of darkness, 40 meters should normally be the optimum band for DX propagation. When conditions are Below Normal or Disturbed, openings will be spotty and considerably fewer in number.

**80 Meters:** DX propagation conditions are generally at their best on this band during periods of low solar activity. Some fairly good 80 meter DX openings are expected to several areas of the world dur-

11307 Clara Street, Silver Spring, MD 20902

ing the hours of darkness and the sunrise period. When propagation conditions are Normal, signal levels should be strong on many openings. Even during Below Normal or Disturbed periods there is a fairly good chance that some DX openings may be possible during the hours of darkness. Expect conditions normally to peak around midnight for openings towards Europe and Africa, after midnight and before sunrise for openings towards Central and South America, and just before sunrise for openings towards the South Pacific and the Far East.

**160 Meters:** With longer hours of darkness, DX conditions on this band should improve. While DX conditions may not be as good on 40 and 80 meters, look for openings to many areas of the world during the hours of darkness and the sunrise period. Because of power limitations in force on this band in many areas of the world, signals are likely to be weak and noisy, especially on phone. The best time for 160 meter DX is when a path is in complete darkness. Within this period conditions often peak just as the sun begins to rise at the *easterly* point on the path. The best forecaster for 160 meter DX (and 40 and 80 meters, as well) is a set of sunrise and sunset tables. For example, if the sun is expected to rise at 0700 GMT in western Europe, then this would be the best time to look for 160 meter openings between western Europe and the USA, plus or minus a half hour. Conditions on 80 meters can often also serve as an indicator for 160 meter openings. The band will often open at the same 80 meters seems to peak on a particular path. With these tips and some patience, it should be possible to work many DX areas of the world on 160 meters during the contest.

### Contest Work Plans

The DX Propagation Charts on the following pages show the times when each amateur band from 10 through 160 meters is expected to open for DX from the United States to the major areas of the world. Instructions for the proper use of these charts are given elsewhere in this column.

The information contained in the charts can easily be reorganized into more convenient types of operational work plans, or schedules, which can serve as valuable propagation guides during the contest. Experience gained during previous contests has shown that such plans can be extremely useful in piling up contacts and points with a minimum of wasted time.

Table I is an example of one of several types of plans that can be devised. It shows, for each three-hour period throughout the day, the areas of the world to which 20 meter propagation conditions are expected to be optimum. Only those openings shown in the charts with a propagation index of (2) or higher were used in compiling this plan.

Time PST	Areas to which openings should be optimum
00-03	No openings expected with a propagation index of (2) or higher. Some (1) openings should be possible to South America, South Pacific, New Zealand, and Australasia, but this means conditions should be High Normal or better. This is a good time to catch up on some sleep.
03-06	About the same as the previous block.
06-09	Should open in just about every direction: Europe, North Africa, Eastern Mediterranean and Middle East, most of Asia and the Far East, Pacific Islands, New Zealand, Australasia, the Caribbean, Central America, and most of South America. This is the period in which to rack up points.
09-12	About the same as previous period, but signals getting weaker and openings falling off.
12-15	Western and southern Europe, most of Africa, most of the Caribbean, Central America, and the northern countries of South America.
15-18	All of the Caribbean, Central America and South America, most of Africa, the Pacific Islands and New Zealand, the Far East.
18-21	Another peak period, and a good time in which to increase scores. Most of Asia including the Far East; the Pacific Islands, New Zealand, and Australasia; Caribbean, Central and South America, but falling off; Antarctica.
21-00	South Pacific, New Zealand and Australasia, much of South America, Antarctica. A propagation index (1) opening to Europe and Africa.

Table I—Sample 20 meter operating schedule for a Western USA QTH.

A western USA QTH has been chosen for this example, but similar plans can be devised for other locations, for other bands or for multi-band operation, and for other time spans.

### Radio Storms

The forecasts discussed in this column are based on *normal* propagation conditions expected with a sunspot level of approximately 14. If actual conditions during the contest turn out to be *above normal*, DX openings on 10, 15, and 20 meters are likely to be somewhat better than shown in the charts. On the other hand, if a radio storm should develop, with accompanying below normal or disturbed HF propagation conditions, fewer openings will take place on these bands. During radio storms, propagation conditions on 40, 80, and 160 meters generally also become erratic, with poorer openings during certain types of storms and improved openings during other types.

If a radio storm should develop during the contest, circuits passing through or near polar regions will probably become weak, fade considerably, or may even black out entirely, depending upon the severity and duration of the storm. During certain storms, while east-west propagation may become poorer, north-south openings may improve.

If a storm should occur, concentrate on working the higher frequency bands and the paths to the northeast, north, and northwest during the daylight hours, and the lower bands and the paths to the east, south, and west during the evening and early morning hours.

A Last Minute Forecast made at press time for the phone section of the contest appears at the beginning of this column. A similar forecast for the CW section will appear in next month's column. For up-

dated geomagnetic and solar data during the contest period, check the National Bureau of Standards Radio Station WWV broadcasts at 18 minutes past each hour. These broadcasts (transmitted simultaneously on 2.5, 5.0, 10.0, 15.0, and 20.0 MHz) contain the latest available geomagnetic A and K-figures and the level of 10.7 cm solar flux. They also contain a short-term forecast of geomagnetic and solar conditions given in subjective terms. Table II can be used to convert the geomagnetic and solar data given on the WWV broadcasts into expected HF ionospheric conditions. The hourly forecasts broadcast on WWV along with the latest solar flux and geomagnetic indices, also may be obtained by telephoning 303-497-3235 at any time. This is a service provided by the NOAA Space Environment Services Center, but the call is not toll-free. Direct inquiries to the duty forecaster at the center can also be made 24 hours each day, 7 days a week by calling 303-497-3171 (collect calls will not be accepted).

For example, a solar flux of 82 and an A-index of 9 should result in High Normal conditions, while a solar flux of 77 and a K index of 2.5 would indicate Low Normal conditions.

### Do-It-Yourself Forecasting

Besides the WWV transmissions of solar flux and geomagnetic data, there are now available several aids, including software for home computers, which can be used for forecasting conditions and band openings during the 1985 contest.

I personally use the MUFLOT program on my grandson's Commodore-64 computer for determining band openings. While not as accurate as the more powerful computer programs such as



**FACTORY AUTHORIZED DEALER  
PLEASE CALL OR WRITE FOR THE  
LATEST AND GREATEST FROM ICOM**

IC-735 HF Xcvr./Gen. Cov. Rcvr.	\$729.00
IC-745 HF Xcvr./Gen. Cov. Rcvr.	769.00
IC-PS15 12 VDC, 15 Amp. Power Supply	131.12
IC-PS30 12 VDC, 30 Amp. Sys. Pwr. Supply	228.76
IC-PS55 12 VDC, Power Supply For IC-735	140.80
IC-SP10 Mobile External Speaker	29.95
IC-271H 2-Mtr., FM/SSB/CW, 100 W., Xcvr.	749.00
IC-SM5 Desk Microphone	39.00
IC-SM6 Desk Microphone	39.00
IC-SM8 Desk Microphone, Dual Cables	69.95
IC-27A 2-Meter, FM, 25 Watt Xcvr.	319.00
IC-27H 2-Meter, FM, 45 Watt Xcvr.	359.00
IC-37A 220-MHz., FM, 25 Watt Xcvr.	299.00
IC-3200A 2-Mtr./70-cm, FM, 25 Watt Xcvr.	469.00
IC-2AT 2-Mtr., FM, Handheld W/Touch-Tone	199.50
IC-3AT 220-MHz., FM, Handheld With T-T	234.50
IC-02AT 2-Mtr., FM, Handheld With T-T	289.50
IC-BP2 7.2 VDC, 425 mah., Ni-Cad Batt. Pack.	39.50
IC-BP3 8.4 VDC, 250 mah., Ni-Cad Batt. Pack.	29.50
IC-BP4 Battery Case	12.50
IC-BP5 10.8 VDC, 425 mah., Ni-Cad Batt. Pack.	49.50
IC-BP7 13.2 VDC, 425 mah., Ni-Cad Batt. Pack.	67.50
IC-BP8 8.4 VDC, 800 mah., Ni-Cad Batt. Pack.	62.50
BC-35 Drop-In Rapid Charger; IC-BP2, 5, 7, 8	69.00
IC-CP1 Mobile Charging Cord	9.50
IC-DC1 DC Converter	17.50
IC-HM9 Speaker/Microphone	34.50
LC-5 Leatherette Case, IC-2AT W/IC-BP5	17.95
LC-7 Leatherette Case, IC-2AT W/IC-BP3	17.95
LC-11 Leatherette Case, IC-02AT W/IC-BP3	17.95
LC-14 Leatherette Case, IC-02AT W/IC-BP8	17.95
HS-10 Headset For Handhelds	19.50
HS-10SA VOX Unit For HS-10	19.50
HS-10SB PTT Unit For HS-10	19.50
IC-HP1 Headphones	34.50

**TOKYO HY-POWER LABS**

HC-200 200 Watt PEP Antenna Coupler	\$86.14
HC-400L 200 Watt PEP Antenna Coupler	164.64
HC-2000 2-KW PEP Antenna Coupler	285.60
HL-30V 2-Meter FM Amplifier	59.78
HL-110V 2-Meter Multi-Mode Amplifier	201.60
HL-160V 2-Meter Multi-Mode Amplifier	287.84
HL-90U 430-MHz. Multi-Mode Amplifier	318.00
HRA-2 144-MHz. Mast-Mounted Pre-Amp.	132.00

**WELZ**

CT-15A Dummy Load, 50W Peak, 15W Avg.	\$12.95
CT-150 Dummy Load, 400W Peak, 150W Avg.	49.95
CT-300 Dummy Load, 1-KW Peak, 300W Avg.	69.95

**BELDEN**

New 9913 Low Loss VHF/UHF Coax Cable, RG-8/U Type. Accepts Standard Amphenol PL-259 And Type N Conn. 9½-AWG, Solid, Bare Copper, Center Conductor. 84% Velocity Factor. 100% Shield Coverage. 50 Ohm. Semi-Solid, Polyethylene, Center Insulation. . . . . \$4.4/ft.

**ASTRON**

RS-7A 13.8 VDC, 7 Amp Int., 5 Amp Cont.	\$46.30
RS-12A 13.8 VDC, 12 Amp Int., 9 Amp Cont.	64.60
RS-20A 13.8 VDC, 20 Amp Int., 16 Amp Cont.	82.90
RS-35A 13.8 VDC, 35 Amp Int., 25 Amp Cont.	125.60
RS-12M Same As RS-12A, With Meter	80.46
RS-20M Same As RS-20A, With Meter	98.76
RS-35M Same As RS-35A, With Meter	141.46
VS-20M Same As RS-20M, Adj. Volt./Curr.	117.06
VS-35M Same As RS-35M, Adj. Volt./Curr.	159.76
VS-50M 13.8 VDC, 50A Int., 37A Cont., Adj.	226.86

UPS/Insurance Charges Are Additional.  
MC, VISA, C.O.D. Orders Are Accepted.

*LaRue Electronics*

1112 GRANDVIEW STREET  
SCRANTON, PENNSYLVANIA 18509  
PHONE (717)343-2124

CIRCLE 38 ON READER SERVICE CARD

Geomagnetic Activity	Range		Solar Flux Range	
	K	A	65-80	80-100
Quiet	0-1	0-3	Above Normal	Above Normal
Quiet	1-2	3-7	High Normal	Above Normal-High Normal
Unsettled	2-3	7-15	Low Normal	High Normal
Active	3-4	15-27	Low Normal-Below Normal	Low Normal
Minor Storm	4-5	27-48	Below Normal-Disturbed	Below Normal-Disturbed
Major Storm	5+	48+	Disturbed	Disturbed

Table II- This table can be used to convert the geomagnetic and solar data given on the WWV broadcasts into expected HF ionospheric conditions.

**HOW TO USE THE DX PROPAGATION CHARTS**

1. Use Chart appropriate to your transmitter location. The Eastern USA Chart can be used in the 1, 2, 3, 4, 8 KP4, KG4 and KV4 areas in the USA and adjacent call areas in Canada; the Central USA Chart in the 5, 9 and 0 areas; the Western USA Chart in the 6 and 7 areas, and with somewhat less accuracy in the KH6 and KL7 areas.

2. The predicted times of openings are found under the appropriate meter band column (10 through 80 Meters) for a particular DX region, as shown in the left-hand column of the Charts. An \* indicates the best time to listen for 160 meter openings.

3. The propagation index is the number that appears in ( ) after the time of each predicted opening. The index indicates the number of days during the month on which the opening is expected to take place as follows:

- (4) Opening should occur on more than 22 days
- (3) Opening should occur between 14 and 22 days
- (2) Opening should occur between 7 and 13 days
- (1) Opening should occur on less than 7 days

Refer to the "Last Minute Forecast" at the beginning of this column for the actual dates on which an opening with a specific propagation index is likely to occur, and the signal quality that can be expected.

4. Times shown in the Charts are in the 24-hour system, where 00 is midnight; 12 is noon; 01 is 1 A.M.; 13 is 1 P.M., etc. Appropriate daylight time is used, not GMT. To convert to GMT, add to the times shown in the appropriate chart 7 hours in PDT Zone, 6 hours in MDT Zone, 5 hours in CDT Zone, and 4 hours in EDT Zone. For example, 14 hours in Washington, D.C. is 18 GMT. When it is 20 hours in Los Angeles, it is 03 GMT, etc.

5. The charts are based upon a transmitted power of 250 watts c.w., or 1 kw, p.e.p. on sideband, into a dipole antenna a quarter-wavelength above ground on 160 and 80 meters, and a half-wavelength above ground on 40 and 20 meters, and a wavelength above ground on 15 and 10 meters. For each 10 dB gain above these reference levels, the propagation index will increase by one level for each 10 dB loss, it will lower by one level.

6. Propagation data contained in the Charts has been prepared from basic data published by the Institute for Telecommunication Sciences of the U.S. Dept of Commerce. Boulder, Colorado, 80302.

**October 15-December 15, 1985  
Time Zone: EDT (24-Hour Time)  
EASTERN USA TO:**

Reception Area	10 Meters	15 Meters	20 Meters	40/80 Meters
Western & Central Europe & North Africa	09-11 (1)	08-09 (1) 09-11 (3) 11-12 (2) 12-13 (1)	06-07 (1) 07-08 (2) 08-09 (4) 09-11 (3) 11-13 (4) 13-14 (3) 14-15 (2) 15-17 (1)	16-17 (1) 17-18 (2) 18-20 (3) 20-02 (2) 02-03 (3) 03-04 (2) 04-05 (1) 19-21 (1)* 21-23 (2)* 23-02 (3)* 02-03 (2)* 03-04 (1)*
Northern Europe & European USSR	09-11 (1)	08-09 (1) 09-10 (2) 10-11 (1)	06-07 (1) 07-10 (3) 10-13 (2) 01-03 (2) 03-04 (1) 19-21 (1)* 21-01 (2)* 01-03 (1)*	17-19 (1) 19-22 (2) 22-01 (1) 01-03 (2) 03-04 (1) 19-21 (1)* 21-01 (2)* 01-03 (1)*

Eastern Mediterranean & Middle East	08-10 (1)	08-09 (1) 09-11 (2) 11-12 (1)	06-10 (1) 10-12 (2) 12-15 (3) 15-16 (2) 16-18 (1)	18-20 (1) 20-00 (2) 00-02 (1) 20-22 (1)* 22-00 (2)* 00-01 (1)*
Western Africa	11-14 (1)	08-10 (1) 10-12 (2) 12-13 (3) 13-15 (4) 15-16 (2) 16-17 (1)	06-07 (1) 07-09 (2) 09-13 (1) 13-15 (2) 15-16 (3) 16-17 (4) 17-18 (3) 18-19 (2) 19-20 (1)	18-20 (1) 20-02 (2) 02-03 (1) 20-22 (1)* 22-01 (3)* 01-02 (1)*
Eastern & Central Africa	10-13 (1)	08-12 (1) 12-14 (2) 14-15 (1)	07-13 (1) 13-15 (2) 15-17 (3) 17-18 (2) 18-19 (1)	20-01 (1) 22-00 (1)*
Southern Africa	10-12 (1)	08-10 (1) 10-11 (2) 11-13 (3) 13-14 (2) 14-15 (1)	07-13 (1) 13-15 (2) 15-17 (3) 17-18 (2) 18-19 (1) 22-00 (1)	18-19 (1) 19-22 (2) 22-23 (1) 19-22 (1)*
Central & South Asia	NIL	09-11 (1) 17-19 (1)	07-08 (1) 08-10 (2) 10-12 (1) 19-21 (1)	05-07 (1) 18-21 (1) 05-07 (1)* 18-20 (1)*
Southeast Asia	NIL	17-19 (1)	07-08 (1) 08-10 (2) 10-13 (1) 18-21 (1)	05-07 (1) 18-20 (1) 05-07 (1)*
Far East	NIL	16-17 (1) 17-18 (2) 18-19 (1)	07-08 (1) 08-10 (2) 10-11 (1) 16-19 (1) 19-21 (2) 21-22 (1)	04-08 (1) 17-19 (1) 05-07 (1)* 17-18 (1)*
South Pacific & New Zealand	12-16 (1)	12-14 (1) 14-15 (2) 15-16 (3) 16-18 (2) 18-19 (1)	06-07 (1) 07-08 (2) 08-09 (3) 09-11 (2) 11-17 (1) 17-18 (2) 18-20 (3) 20-22 (2) 22-01 (1)	23-00 (1) 00-02 (2) 02-06 (3) 06-08 (2) 08-09 (1) 02-04 (1)* 04-06 (2)* 06-07 (1)*
Australasia	14-16 (1)	10-15 (1) 15-16 (2) 16-17 (3) 17-18 (2) 18-19 (1)	06-07 (1) 07-09 (2) 09-15 (1) 15-17 (2) 17-20 (1) 20-23 (2) 23-01 (1)	02-05 (1) 05-07 (2) 07-08 (1) 07-08 (1)* 05-07 (2)* 07-08 (1)*
Caribbean, Central America & Northern Countries of South America	08-09 (1) 09-13 (2) 13-15 (1)	07-08 (1) 08-09 (2) 09-14 (3) 14-15 (4) 15-16 (3) 16-17 (2) 17-18 (1)	00-06 (1) 06-07 (2) 07-09 (4) 09-11 (3) 11-15 (2) 15-16 (3) 16-18 (4) 18-19 (3) 19-20 (2) 20-22 (1) 22-00 (2)	18-19 (1) 19-21 (3) 21-03 (4) 03-05 (3) 05-06 (2) 06-07 (1) 19-21 (1)* 21-01 (2)* 01-04 (3)* 04-05 (2)* 05-06 (1)*
Peru, Bolivia, Paraguay, Brazil, Chile, Argentina, & Uruguay	10-15 (1)	07-08 (1) 08-10 (2) 10-13 (1) 13-14 (2) 14-16 (4) 16-17 (2) 17-18 (1)	06-07 (1) 07-09 (3) 09-10 (2) 10-14 (1) 14-16 (2) 16-18 (4) 18-19 (3) 19-20 (2) 20-22 (1) 22-00 (2) 00-02 (1)	20-22 (1) 22-04 (2) 04-06 (1) 21-23 (1)* 23-03 (2)* 03-04 (1)*





IONCAP, which are available professionally, MUFLOT does an acceptable job on either Commodore or Apple computers. The latest version of the program will print out in standard format highest usable frequency, maximum usable frequency, and lowest usable frequency for any path over a 24-hour period. The program also prints out beam heading and distance, and can also be used for obtaining sunrise and sunset data, etc. The only input needed, besides path terminals and date, is solar flux level. Since solar flux values can be obtained from WWV, the MUFLOT program is to a very large degree a "real time" propagation prediction method. For pricing, availability, and full information write directly to Base (2) Systems, 2534 Nebraska Street, Saginaw, MI 48610. Check the Ham Shop section in this issue of CQ for other propagation programs that may be available. Programs such as MUFLOT can be of tremendous help during the DX contest.

Another propagation aid that I use is the *DX Edge*, which is available from Xantek, Inc., P.O. Box 834, Madison Sq. Station, New York, NY 10159. It is a slide-rule-type device which allows you to determine quickly and easily those areas of

the world that are in daylight, darkness, or twilight at any given time of day and for any month of the year. It is great for determining sunrise and sunset times at a glance, for locating the terminator, and for predicting long-path and gray-line openings. The *DX Edge* has recently been modified to also make it possible to determine great-circle bearings. I also find it useful for determining local time anywhere in the world.

The *DX Edge* consists of a slide-rule-type carrier and a set of monthly transparent overlays. Imprinted on the carrier is a unique double map of the world showing the 40 CQ DX zones and many country prefixes. The overlays slide along the carrier, giving a clear, instant visual picture of daylight-darkness conditions. Easy-to-understand instructions come with the *DX Edge* and explain how to use the instrument for determining the best times to look for DX openings on the HF bands. It should be an invaluable aid during DX contests. Pricing and other information can be obtained directly from Xantek.

If you do not already have a copy of the *Shortwave Propagation Handbook* by myself and Theodore J. Cohen, N4XX,

then you might want to get one to read before the contest begins. The book continues to be the most popular text for plain, every-day use and understanding of HF radio propagation. It contains propagation information and charts, and guides you through do-it-yourself prediction and forecasting methods. Copies are still available from the CQ Book Shop, 76 North Broadway, Hicksville, NY 11801 for \$8.95 postpaid (plus \$2.00 shipping and handling).

Lee Wical, KH6BZF, puts out an excellent weekly newsletter full of interesting propagation information, and containing advanced forecasts of HF and VHF ionospheric openings. Write directly to KH6BZF at 45-601 Luluku Road, CRT #4411, Kane'Ohe, Hawaii 96744-1854 for more complete details, availability, and pricing.

## VHF Ionospheric Openings

While the CQ DX Contest does not include the VHF bands, some interesting ionospheric activity is likely to occur on these bands during October.

Some fairly good meteor-scatter-type openings should be possible on the VHF bands around October 20th, when the two-day *Orionids* meteor shower is expected to begin. This should be a major shower, with a maximum hourly rate of at least 25 meteors.

Auroral activity usually increases during October, and some corresponding auroral-scatter-type and sporadic-E VHF openings can be expected during periods of such activity. The best days to check are those which are expected to be either Below Normal or Disturbed on the HF bands. See the Last Minute Forecast at the beginning of this column for the days in October that are forecast to be in these categories.

## CW Contest Forecast

This month's DX Propagation Charts are valid for both the phone and the CW sections of the contest. Be sure to keep them handy for use during next month's CW section as well. Short-Skip Propagation Charts for use during October appeared in last month's column.

Experience from the past 34 contest years has shown that DX contests are excellent periods in which to test the accuracy of prediction and forecast methods used in this column. Contests generate a large amount of activity in every corner of the world and on all HF bands. Previous results and observations have helped considerably in improving the accuracy of this column. Comments concerning the 1985 contest and the accuracy of these forecasts and predictions would be appreciated, and should be sent directly to W3ASK at P.O. Box 1714, Silver Spring, MD 20902. *Good luck in the contest!*

73, George, W3ASK

Say You Saw It In CQ

# NOW AVAILABLE!

# The NEW MB-V-A

## A great tuner is now even better!

**We Added:**

- Taut band Jewell meters.
- Beefed up internal shielding.

- Auto-switching meter to 3,000 watt scale.
- Higher voltage input capacitors.

**Our MB-IV line carries the same improvements.**

**Also New - ALL BAND antenna for use with our tuners.**

25:1  
VERNIER DIAL

AUTOMATIC  
SWR

PUSH-BUTTON  
ANTENNA SELECTION

CONTINUOUS  
POWER MONITORING

PUSH-BUTTON  
CAPACITOR SWITCH

EASY GRIP  
TUNING

## MB-V:

# NYE VIKING RUGGED 3KW ANTENNA TUNER

Discover this durably built, feature packed MB-V Antenna Tuner. You'll find operating conveniences that make antenna tuning a snap. The MB-V is value engineered to do the job over wide operating ranges. Compare quality, features and the exclusive NYE VIKING TWO YEAR WARRANTY!

**Maximize Power Transfer.** Match your transmitter output impedance to almost any antenna system for maximum power transfer.

**Pi Network.** Low Pass Pi Network tuning — 1.5 to 30MHz. Heavy duty, silver plated continuously variable inductor with 25:1 vernier dial. 7000 volt variable capacitor and 15,000v switch selected fixed capacitors on output side. Tunes 40 to 2000 ohm antennas. Also provides harmonic suppression.

**Automatic SWR.** Hands free metering of SWR. No reset or calibration needed. Separate power meter — 300 or 3000 watts. Easy to read 2 1/2" recessed, backlighted meters show SWR and power continuously.

**Antenna Switch.** New! PUSH-BUTTON antenna switching to 4 antennas (2 coax, single wire and twin lead). Tuner bypass on first coax output. We designed this rugged switch to handle the power.

**3KW Balun.** Trifilar wound, triple core toroid gives balanced output to twin feeders from 200 to 1000 ohms and unbalanced output down to 20 ohms.

**Model Options.** MBIV-01 includes all MB-V features less antenna switch and balun. MB-IV-02 is identical to MB-IV-01 with the addition of a double core balun.

**OTHER NYE VIKING PRODUCTS:** Straight Keys, Squeeze Key, Code Practice Set, Electronic and Memory Keys, Phone Patches, 2KW Low Pass Filter, Automatic SWR and Power Meters for HF and 2m (plus a model for the blind), 200w PEP antenna tuner...and more!

Ask for a free catalog

Available at Leading Dealers.

**WM. M. NYE COMPANY**  
1614-130th Avenue N.E.  
Bellevue, WA 98005  
(206) 454-4524

# WE BUILD IT SO YOU CAN BRAG ABOUT IT!

CIRCLE 76 ON READER SERVICE CARD



# CQ BOOK SHOP

The Radio Publications Group—The "Bill Orr Series"

These easy reading classics belong in the library of any active ham. Loaded with practical how-to information, with tables, charts, and formulas arranged for handy reference.

**Beam Antenna Handbook**, 200 pages, paperback, \$7.95. Order #R143.

**Wire Antennas**, 192 pages, paperback, \$7.95. Order #R144.

**Antenna Handbook**, 192 pp. paperback, \$7.95. Order #R145.

**Cubical Quad Antennas**, 112 pages, paperback, \$6.95. Order #R146.

**VHF Handbook**, 336 pp. paperback, \$11.95. Order #R147.

**Interference Handbook**, by W.R. Nelson, 247 pages, paperback, \$9.95. Order #R172.

**RTTY Today**  
by Dave Ingram, K4TWJ

A brand new, completely up-to-date handbook on RTTY, covering the latest developments and techniques, plus use of the home computer for RTTY. Illustrated with photos, diagrams, station setups, and RTTY gear. 112 pages, paperback, \$8.95. Order #C211.

**Vertical Antenna Handbook**, 2nd ed.  
by Paul H. Lee, N6PL

Out of print for several years, this classic has been reprinted with updates, including an addendum on antenna design for 160 meters. Other sections include feeding and matching, short verticals, ground effects, and much more. 139 pages, paperback, \$9.95. Order #C208.

**World Radio TV Handbook 1985**

The world's only complete directory of international broadcasting and TV stations—the established, authoritative guide endorsed by the world's leading broadcasting organizations.

A comprehensive country-by-country listing of short-, medium-, and long-wave stations, revised and updated to reflect actual conditions. Also includes special features on The Future Regulation of High-Frequency Broadcasting, Solar Activity in 1985, Technical Innovations at Radio Nederland's New Transmitting Station, and more. 600 pages, paperback, \$19.50. Order #B097.

**Confidential Frequency List**, 6th ed.  
by Perry Ferrell

The latest available information on the most interesting communications stations on the shortwave bands listed by frequency and callsign. Now also includes RTTY stations. Details schedules, emergency channels, alternates, and IDs. 304 pages, paperback, \$13.95. Order #G196.

**Radio Handbook**, 22nd ed.  
by Bill Orr, W6SAI

A state-of-the-art, single-source reference on radio communications and theory for hams, professional ops, techs, and engineers. New coverage includes solid-state devices, Yagis and quads, and h.f. amplifier designs. A hands-on instruction manual, as well. 1168 pages, hardcover, \$39.95. Order #S197.

**The Shortwave Propagation Handbook**, 2nd ed.  
by George Jacobs, W3ASK, and Theodore J. Cohen, N4XX

A new, revised edition of the popular guide to all your propagation needs. Contains up-to-the-minute information and charts, and guides you through producing your own propagation data. 154 pages, paperback, \$8.95. Order #C137.

**Ameco Radio Amateur FCC Test Manuals**

Easy-to-understand questions and answers based on the latest FCC study guides, plus sample exams, will help you make sure you're ready to sit for the license tests.

**Novice Class**, 64 pages, paperback, \$2.95. Order #A221.

**General Class**, 128 pages, paperback, \$4.95. Order #A034.

**Advanced Class**, 128 pages, paperback, \$4.95. Order #A035.

**Extra Class**, 128 pages, paperback, \$4.95. Order #A220.

**Ameco Novice Code and Theory Package**

A complete training package containing the 128-page Novice theory course and a 60-minute code cassette, which teaches how to send and receive code up to 8 words per minute, and a 32-page book. Also included are FCC-type code and theory examinations to help even a rank beginner get a ticket fast! \$7.75. Order #A024.

**The Complete DX'er**  
by Bob Locher, W9KNI

Covers every significant aspect of DXing from how to really listen to how to snatch the rare ones out of the pileups. Also includes advice on siting, equipment selection, and antennas. 187 pages, paperback, \$10.95. Order #B209.

**CQ BOOK SHOP 76 North Broadway, Hicksville, NY 11801**

QTY.	ORDER #	TITLE	PRICE	TOTAL

Shipping charges \$2.00 per order. Shipping charges waived on orders of \$50.00 or more. Books shipped best way. All orders are processed the day they are received, but please allow 30 days for delivery within North America.

* Book Total	
Shipping Charge	
Grand Total	

Name \_\_\_\_\_  
 Address \_\_\_\_\_  
 City \_\_\_\_\_  
 State \_\_\_\_\_ Zip \_\_\_\_\_

Check  MasterCard  VISA



Card No. \_\_\_\_\_ Expires \_\_\_\_\_

X \_\_\_\_\_  
 Signature required on all charge orders:

## REPEATER VOTER

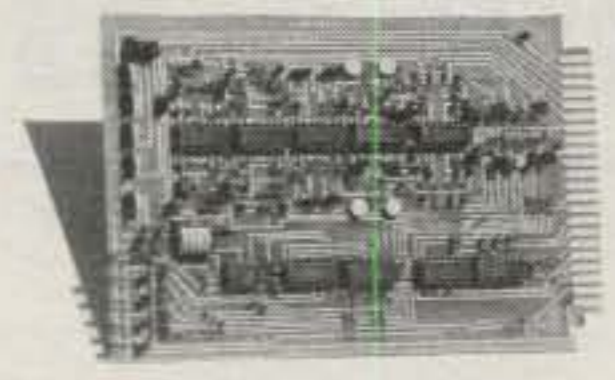

### 4RV Four Channel Repeater Voter

- Signal to Noise Type
  - Expandable to 32 Channel by Just Adding Cards
  - Designed for Commercial and Amateur Service
  - Continuous Instant Voting
  - Dual or Single 12 Volt Supply
  - LED Indicators of COR and Voted Signals
  - Front Mounted Level Pots
  - Built in Calibrator
  - Remote Voted Indicators Pinned Out
  - 4 1/2" x 6" Double Sided Gold Plated 44 Pin Card
  - Unswitched Audio Input
  - On Board Audio Switching and Mixing
  - Audio Mixer Input Available for External Input
  - Open Collector or Relay Contact Input
  - Open Collector NPN Output
  - Remote Disable Inputs
  - More
- 4RV Kit including board and parts with 20 page manual ..... \$200.00  
 Built, tested, and calibrated with manual ..... \$350.00

For more information call or write: (614)  
 VOTER Hall Electronics 261-8871  
 815 E. Hudson Street  
 Columbus, Ohio 43211

CIRCLE 154 ON READER SERVICE CARD

## AUTHORIZED KENWOOD I-COM RADIO DEALER



H. L. HEASTER, INC., 203 Buckhannon Pike, Clarksburg, W. VA. 26301  
 Clarksburg Phone (304) 624-5485 or W. VA. Toll-Free 1-800-352-3177  
 Harold Heaster, K80HX, 91 Ridgely Place, Ormond Beach, FL. 32074  
 Florida Phone (904) 673-4066  
 We sell all brands of amateur radios, amplifiers, antennas, towers, etc.  
 Call us for a quotation for your needs, we guarantee to save your money!

CIRCLE 39 ON READER SERVICE CARD

## STATION MANAGER/ADVANCED

A General Purpose Logging Program

Designed for the IBM® PC®, XT®, enhanced PC jr®. Menu driven, prompts for easy use; full color displays; multiple logs (each up to 1,000 entries with user editing), several reporting methods including one by partial callsign.

\$59.00 includes: 90 pg. User's Guide & Diskette (source code included)  
 \$20.00 — User's Guide only (may be applied to full purchase price)

Ohio residents include sales tax

### OMEGA CONCEPTS

Professional software for the Radio Amateur  
 P.O. Box 615 Troy, OH 45373 T.L. Jones (KB80A) Author



IBM is a registered trademark of International Business Machine Corp.

CIRCLE 27 ON READER SERVICE CARD

## A LOOK AT THE SHACK FROM BOTH ENDS OF THE COAX

### Reader Report

This month columnist W8FX opens the mailbag again for some more interesting comments on the popular G5RV antenna. He also looks at a very practical antenna accessory, as well as some new and useful hamshack software. Stay with us.

—K2EEK

Last month we wrapped up the six-part Notebook series. In the final article of the series we examined the "bottom line" of antenna performance parameters, primarily from the standpoint of the parameters themselves, but we also considered a number of measurement aspects. In addition, we took a look at several antenna-related products, and noted some especially interesting hamshack reading material.

In this month's Antennas column we'll focus on publicly answering some of our reader mail. We will begin by sampling some of the many letters we received regarding our treatment of the G5RV antenna in the March '85 column, and our call for comments on this increasingly popular antenna's performance. We'll then highlight a number of other mailbag items from readers concerning both previous columns and news items of interest. We'll also take a look at a most useful antenna measurement accessory, the antenna noise bridge (ANB), and then in particular W8URR's Tennatest bridge. Closing out the column for the month, we'll take our customary look at what's new in the world of software for the hamshack. Let's kick off this time with a review of letters received on the G5RV antenna.

#### The G5RV: They Like It!

We have discussed the G5RV antenna several times in the column, most recently being our coverage in the March issue. To review, the G5RV design was proposed by Louis Varney, G5RV, several years back, and it's coming back "in" as a very simple, inexpensive, and easy-to-install multiband dipole. Essentially, the G5RV is a 102 foot wire dipole fed in the center with a specific length of twinlead or openwire line.

Several versions of the 80-10 meter G5RV have been developed, both of which use the same length of flattop. One version (the one I'm partial to) uses a 33

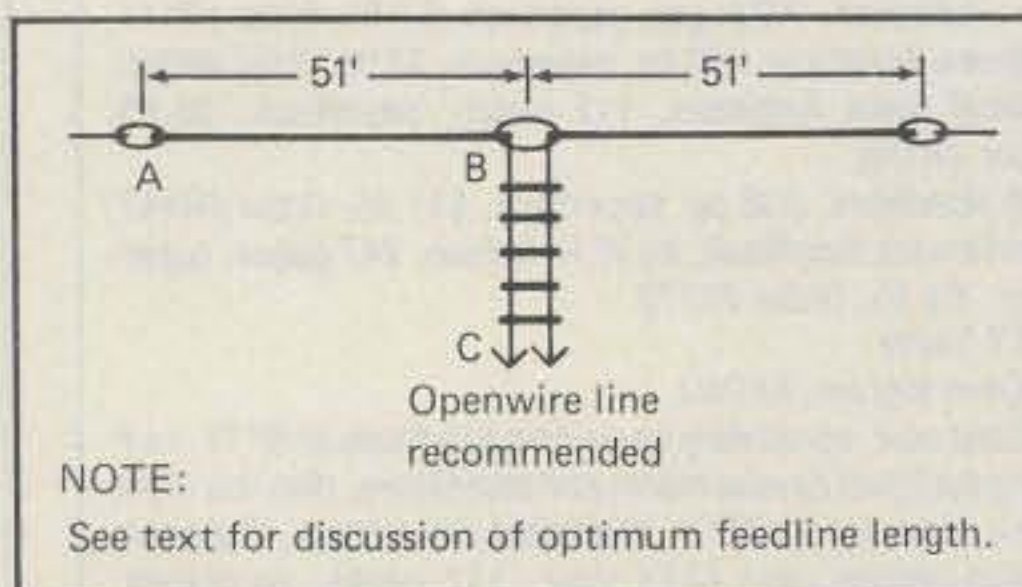

Fig. 1—The G5RV antenna. This sketch shows the G5RV as fed with openwire line. As pointed out by Fred Bonavita, W5QJM, in the text of this month's column, the trick to obtaining even performance across all bands lies in optimizing the feedline length. The idea is to avoid antenna currents on the transmission line by varying its length in relation to the band(s) and one side of the antenna. See Fred's letter, which shows the importance of the dimension AB + BC.

foot length of openwire line (or about 29 feet of twinlead) connected directly to a transmatch. A second version uses the same 33 or 29-foot length of balanced transmission line, but this is connected, in turn, to a 68 foot or longer section of coax. The coax, on which the SWR may run rather high, is also routed through a transmatch, required to reduce the line's end impedance to a reasonable-enough value to make the transmitter happy. This configuration was shown as fig. 3 on page 64 of the March issue.

In that issue, we asked if we had any G5RV users in the CQ audience. As I found out, we certainly do have some G5RVers out there, and we received a half-dozen letters in just a few days after the issue hit the newsstands. The performance verdict was almost unanimous: this antenna works, and it works well.

Typical of the letters received in praise of the antenna's performance was that from Mike Schrowang, KC9YN. Excerpting from Mike's letter:

"I am a user of the G5RV antenna and am very pleased with the results. It is very easy to assemble, and I recommend it to hams who might be plagued with space problems, but want multiband performance . . . it also makes a good Novice antenna which can be built by anyone with little or no experience. I haven't used it for 160 meters because I'm using a centered halfwave dipole [on that band], but I have worked stations on the 'top band' that have done what you suggested [tying

the feeder wires together and operating the antenna against ground as a random-length, top-loaded vertical—ed.].

"My antenna uses the 102 foot flattop, and I use good-quality 300 ohm twinlead with a length of 29.5 feet. I look forward to hearing more on the G5RV in your articles, and I'm sure you will get lots of mail on it."

How true! While we received numerous letters on the G5RV, probably the most enlightening letter was received from Fred Bonavita, W5QJM, who has experimented a good deal with G5RV. It's instructive to reprint most of Fred's letter:

"You bet there are some G5RV users and lovers out here in radioland. I have been using a G5RV in modified form for many years, and would not return to any other type of wire antenna. My experimenting with the G5RV and the work of others has brought me to the modified form of that antenna, and your readers might be interested in the findings.

"First off, openwire line is the best for feeders. It is available from Kilo-Tec at about \$15 per 100 feet—compare that with the price of coax. This is 450 ohm line with spreaders spaced every 6 inches for better performance. If 450 ohm openwire line is not desired, the next best is 450 ohm ribbon line (available from Texas Towers, Kilo-Tec, and others at about the same price). This comes with 'windows' cut in it to ease the strain on the line in high winds, but long runs can flap around vigorously. The balanced line to avoid, however, is 300 ohm TV-type twinlead. This stuff will change impedance when it gets wet, and it is to be avoided for permanent installations, if possible."

Fred continues: "While I agree with the 51 foot length for the legs of the G5RV antenna, I disagree with the lengths of the feeders given in the March column. It's important to avoid resonances in the feedline.

"I had trouble getting a G5RV to load properly using virtually the same dimensions given in your March column and combining the balanced and coax line. Once I used Myers' formula for the correct ratio between the feedlines and one side of the flattop [Robert M. Myers, W1XT, *Practical Antennas for the Radio Amateur*, SCELBI Publications, 1979, p. 39], it played like an accordion. I also did away with the coax."

For those who don't have W1XT's book, Fred explains that "... the secret is

317 Poplar Drive, Millbrook, AL 36054

avoiding antenna currents on the transmission line by varying its length in relation to the band(s) and one side of the antenna. I cut the feeder so that its length, plus the 51 feet [of flattop], would not be an even multiple of 16 feet for 80, 40, 20, or 10 meters, and would not be an even multiple of 22 feet for 15 meters."

Looking at fig. 1, drawn from Fred's sketch, with dimension AB = 51: "... If we make BC = 45, then AB + BC = 96. When divided by 16, this gives us an answer of 6.0, a no-no. Dividing that by 22 is 4.36, which is slightly more acceptable. Change the feeder length, BC, to, say, 53. We now have 51 + 53 = 104. That divided by 16 equals 6.5, a good answer. That figure (104) divided by 22 equals 4.73, which is okay, but not an optimum number for 15 meter operation."

Fred summarizes: "The idea here is to try to get a combination of AB and BC which, when divided by 16 and 22, will produce an answer as close as possible to a 'point-5' response (such as 5.5, 8.4, 3.6, etc.), and as far as possible from a 'point-0' response (such as 7.0, 4.1, 6.9, etc.). This may require some pruning, but it's not difficult. [Note that] all feedline measurements must be made from the output of the antenna tuner to the center feedpoint 'B' of the antenna. The G5RV can be hung either as a flattop or as an inverted Vee antenna, and it plays well in either configuration."

We thank Fred for his detailed explanation of the interplay of the flattop and the feedline. Alternately, when constructing multiband dipoles, consider retuning the line for antenna currents by selecting a feeder length which, when combined with one-half of the flattop length, does not equal an integral multiple of a half-wavelength. Line lengths of about 27, 40, 58, 76, 96, 110, or 140 feet should do the trick over 3.5–29.7 MHz. Note that the line's velocity factor doesn't play a part in establishing these resonances.

Anthony M. DeFazio, N2EVN, uses the alternate G5RV version that makes use of a length of coax to make the final run to the hamshack. He found happiness with a length of openwire of exactly 35 feet, or if using twinlead, 29.6 feet, as opposed to the lengths we specified (33 and 29 feet, respectively). While N2EVN doesn't specify the exact length of coax he used in his installation, he advises that (1) the coax run should not be less than 68 feet; and (2) the cable should not be routed directly underneath the antenna, but rather run off at a right angle, then into the hamshack. He indicates that with his G5RV sized to the specifications listed above, the SWR on all bands, 10 through 80, was down to 1:1—certainly no mean feat, particularly if this includes 30 meters!

Phil Dendinger, N6FNT, indicated good success with a "half-size" G5RV. Wrote Phil: "I live in a condo and use a half-size version—25 feet, 6 inches of #12 wire on each side of the dipole, and

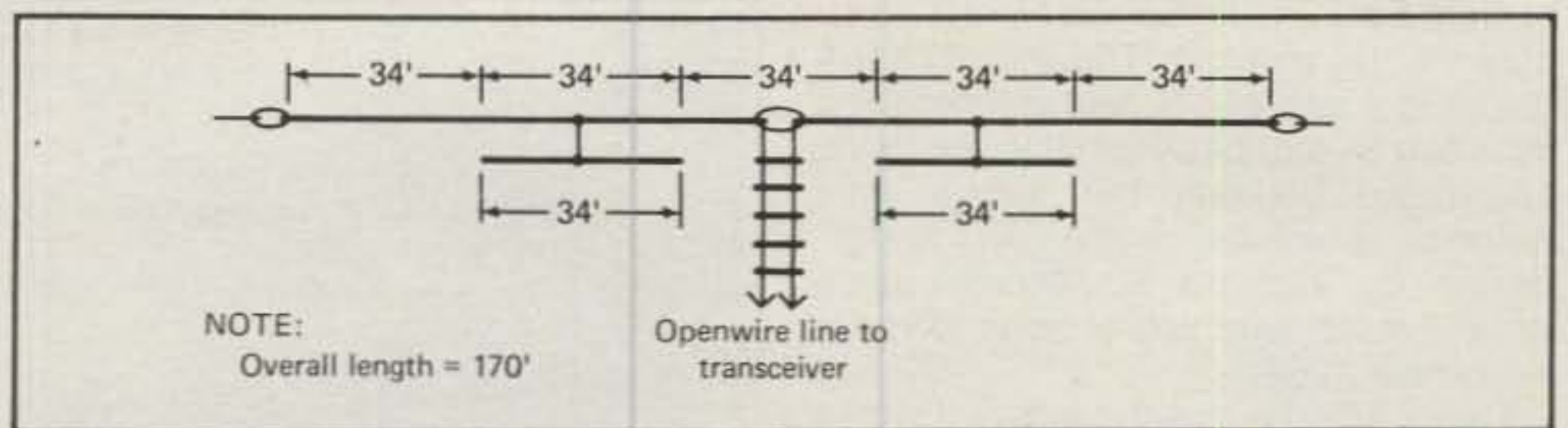

Fig. 2—The W4HIR/KT5X back-to-back J-stub antenna. The interesting multiband HF antenna above was submitted by Carey Brown, W4HIR, on behalf of Fred Maas, KT5X. Back-to-back J-stub arrangement gives a very good account on 15, 20, 40, and 80 meters. Overall antenna length is 170 feet. See text for details. The two stub sections can be held off from the flattop using several homemade spreaders 3 to 4 inches in length, fabricated from plastic plexiglass sheet material.

14 feet, 9 inches of 300 twinlead into 75 ohm coax [coax length not specified]. I run the coax into a Cubic ST-3B antenna tuner and use a Kenwood TS-130S barefoot. I can tune up on 10, 15, and 20 easily, and on 40 [with limited success]."

Phil indicated that he had the antenna outside at first, on top of a one-story garage, bent into a Vee-shape. He later moved the antenna indoors, placing it in the attic, bending it into a "W-shaped" affair, where it still works fine. Clearly, the G5RV antenna is alive and well, as Phil's shack is now graced by a new DXCC award, and he has achieved WAS on 10 meters.

Ken Tinsley, KB6EE, also wrote to describe a similar half-size design. Ken's dimensions were 25 feet, 6 inches for each leg of the flattop, and 17 feet, 6 inches of twinlead, plus 36 feet of coax.

Although Ken didn't state, presumably the antenna is used on 40 meters and up.

As we leave the G5RV, at least temporarily, it's interesting to note the almost unanimous opinion of CQ readers that the G5RV is an excellent multiband antenna, but the method of feeding and the specific feedline lengths recommended by various users are at considerable variance. This variance is natural with any experimental, compromise multiband antenna, however, and so we're open for more reports on the G5RV!

### Into the Mailbox

Carey Brown, W4HIR, submitted the interesting antenna design, shown in fig. 2, that is being used by friend KT5X. No particular name is given to the array by the contributor, though it might be dubbed a "Back-to-Back J-Stub," for the two

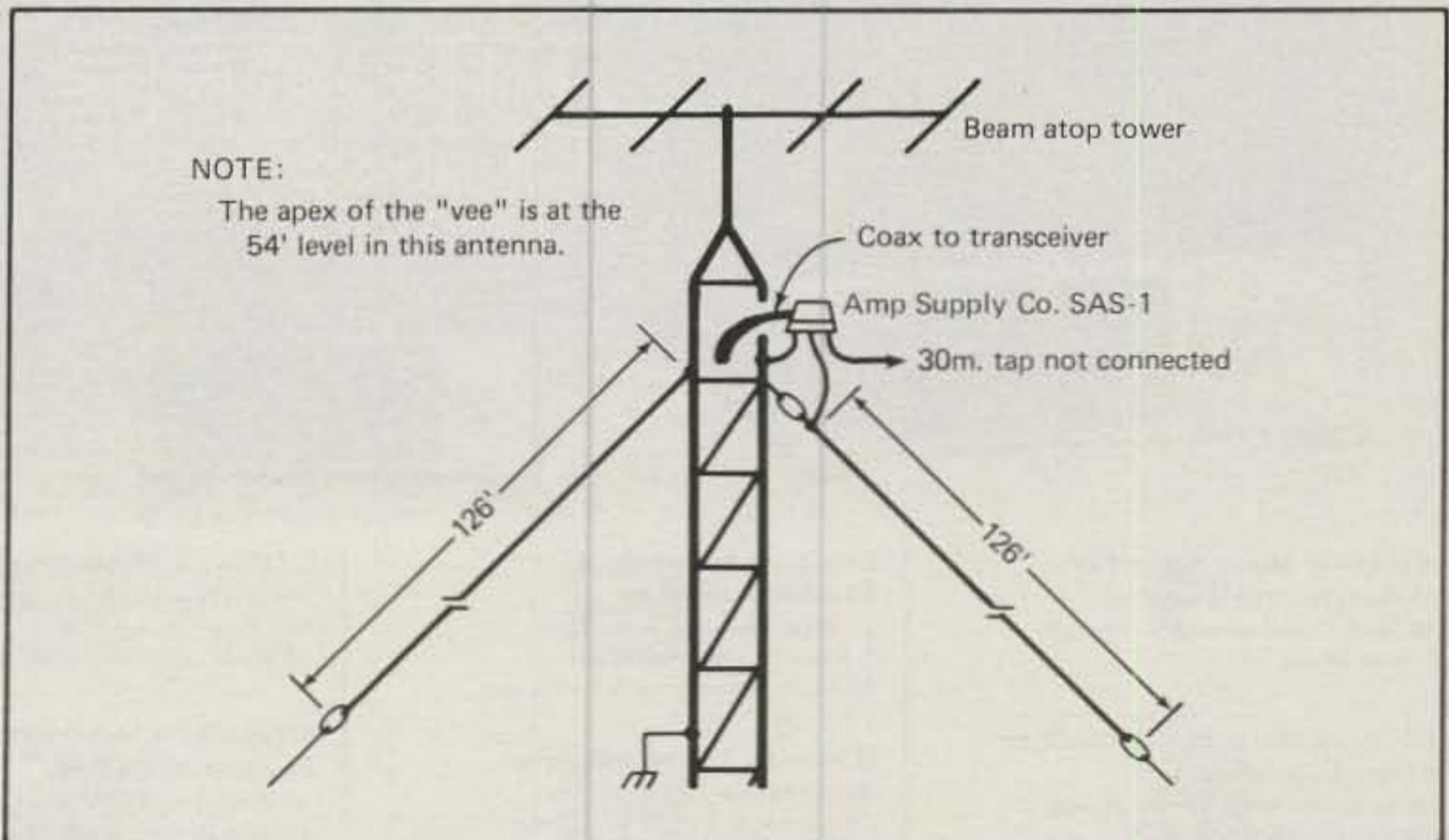
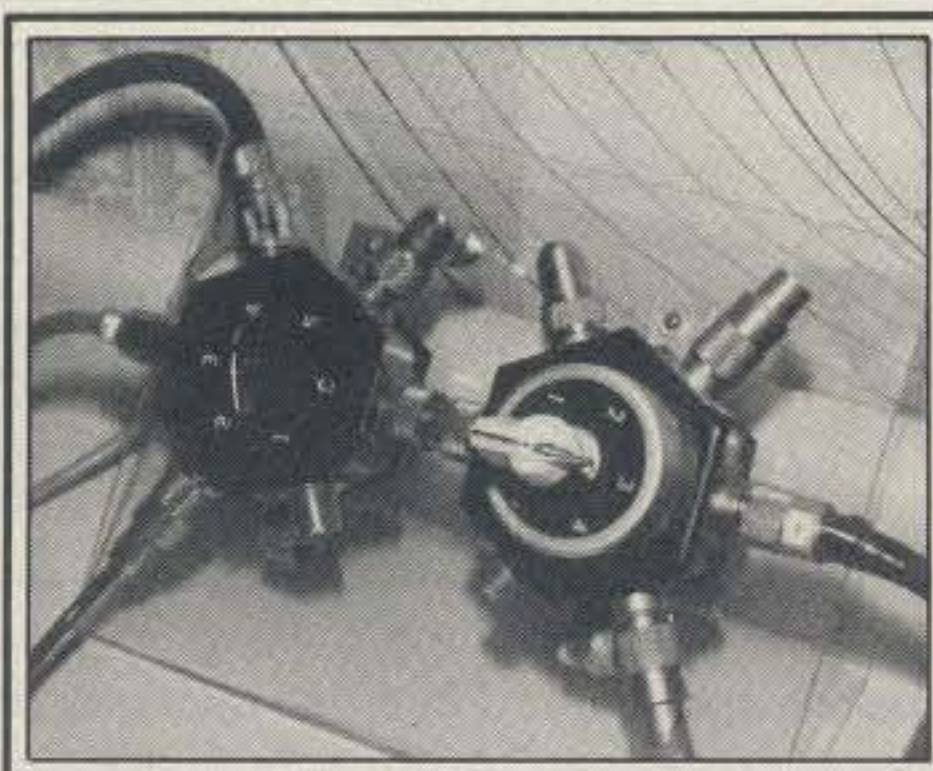

Fig. 3—W1OR piggyback inverted Vee. Gordon Orelli, W1OR, used an Amp Supply Co. SAS-1 matching network (balun) and 252 feet of wire to create a good-performing 160 meter inverted Vee. In his somewhat unorthodox arrangement, the SAS-1 terminal marked "tower/ground" is connected to one of the 126 foot wires and the tower. The other SAS-1 terminal marked "160/80/40 Mtr." is connected to the other 126 foot wire. Since W1OR doesn't use the 30 meter capability of the SAS-1 matcher, the terminal marked "30 Mtr." is not used. Gordon actually modified Amp Supply's SA-4 Sloper antenna system for 160 meter single-band operation in the design he submitted to us. The system as supplied by Amp Supply Co. is designed for 160, 80, 40, and 30 meter operation as a top-fed sloper.

back-to-back J-type radiators which characterize the antenna. The W4HIR/KT5X design is a total of 170 feet in length and uses two 34 foot back-to-back J-sections suspended beneath the flattop. This antenna is similar to the "JF Array" design by Richard R. Schellenbach, W1JF, which was published in QST for November 1982.

Carey advises that the antenna works on 80-15 meters. The characteristics, however, are markedly different from band to band. On 80 meters the antenna functions as a "long dipole," while on 40 it's an extended double Zepp with 3.5 dB gain broadside. On 20 the back-to-back J-stubs make it a three-element collinear with about 6 dB bidirectional gain broadside. On 15 there is about 5 dB gain bidirectionally off the ends. As the feedpoint impedance is high, it's best fed with open-wire line of 300-600 ohms impedance, using a wide-range antenna tuner to work into coax within the shack.

W1OR, Gordon Orelli, described a simple "piggyback" 160 meter tower-supported antenna to us a few months ago. The antenna is an inverted Vee with the apex at the 54 foot point on his tower. It's fairly simple: he uses an Amp Supply Co. SAS-1 matching network atop the tower, and feeds it with 50 ohm coax. One side of the network is connected to the tower and to one of the 126 foot lengths of wire, while the other side connects to the other 126 foot wire. Details are shown in fig. 3.



*If neatness counts, then Alex, YV5IMF, receives an "A" for this interconnection assembly that allows him to connect up to five rigs to up to five antennas, with the unused antennas and rigs being automatically grounded. (See text.)*

Gordon's Vee is a single-band affair; he reports that he had no problem in achieving 160 meter resonance. SWR is fairly flat at 1.5:1 across the band. (The SAS-1 and a trap 160/80/40/30 meter sloper antenna kit, the SA-4—which Gordon modified, since he didn't need to use the other bands—is available from Amp Supply Company, 208 Snow Ave., P.O. Box 147, Raleigh, NC 27602.)

Alex Statzewitch, YV5IMF, sent us a photo of a simple but very neat RF switching assembly that enables him to easily and quickly connect two or more rigs to two or more antennas. He uses two

heavy-duty, five-position coaxial switches mounted back-to-back. These are of the grounding type so that the antennas and rigs which are not in use are grounded. In addition to the safety advantages, Alex points out that grounding the unused antennas helps prevent transmitted RF received by the unused antennas from leaking into the standby rigs, to possibly damage "front end" circuitry.

Back in the January 1984 column we described a modified Windom flattop postulated by Bob Grove, WA4PYQ. Bob's design was 134 feet long, fed 44 feet off of one end by a 48.5 foot matching section of 300 ohm twinlead which is at that point connected to a 4:1 balun and coax for the final run into the hamshack. Bob reported good results, with SWRs no higher than 3:1, on 160, 80, 40, 20, 15, and 10 meters.

Rob Wanderer, KT2D, confirms the antenna's performance on 160 and 80 meters, though with high SWR, and adds that it works for him on 30 meters as well, even though mounted quite low. Writes Rob:

"All and all I'm satisfied, but I hope to raise it up come springtime. Presently, the apex is about 17 feet up, and the end of the 44 foot leg is 7.5 feet up and runs pretty much in the clear. The end of the 90 foot leg is up about 8 feet, but runs through trees.

"I have used and tried the antenna on only three bands—160, 80, and 30 me-

## 14 Reasons Why Your Next Amplifier Will Come From

# MIRAGE

COMMUNICATIONS



**A1015—6 Meter Amplifier**  
10 Watts In—150 Watts Out  
All Mode Operation with Rx Preamp  
Remote Keying

**B23A—2 Meter H/T Amplifier**  
2 Watts In—30 Watts Out  
All Mode Operation with Rx Preamp  
compact Size (3½" × 2" × 7")

**B108—2 Meter Dual Purpose Amplifier**  
10 Watts In—80 Watts Out  
2 Watts In—30 Watts Out  
All Mode Operations with Rx Preamp

**B215—2 Meter H/T Amplifier**  
2 Watts In—150 Watts Out  
Designed for H/T use  
All Mode Operation with Rx Preamp

**B1016—2 Meter Dual Purpose Amplifier**  
10 Watts In—160 Watts Out  
2 Watts In—60 Watts Out  
All Mode Operation with Rx Preamp

**B3016—2 Meter Amplifier**  
30 Watts In—160 Watts Out  
Operates with 2 to 50 Watts Input  
All Mode Operation with Rx Preamp

**C22A—1¼ Meter H/T Amplifier**  
2 Watts In—18 Watts Out  
Compact Size (3½" × 2" × 7")  
All Mode Operation with Rx Preamp

**C106—1¼ Meter Dual Purpose Amplifier**  
10 Watts In—60 Watts Out  
2 Watts In—23 Watts Out  
All Mode Operation with Rx Preamp

**C211—1¼ Meter Amplifier**  
2 Watts In—110 Watts Out  
High Power H/T Amplifier  
All Mode Operation with Rx Preamp

**C1012—1¼ Meter Dual Purpose Amplifier**  
10 Watts In—120 Watts Out  
2 Watts In—40 Watts Out  
All Mode Operation with Rx Preamp

**C3012—1¼ Meter Amplifier**  
30 Watts In—120 Watts Out  
2 Watts In—40 Watts Out  
All Mode Operation with Rx Preamp

**D24—430-450 MHz Amplifier**  
2 Watts In—40 Watts Out  
All Mode Operation FM,SSB,CW,ATV  
Optional "N" Type Connectors

**D1010—430-450 MHz Dual Purpose Amplifier**  
10 Watts In—100 Watts Out  
2 Watts In—45 Watts Out  
All Mode Operation FM,SSB,CW,ATV  
Optional "N" Type Connectors

**D3010—430-450 MHz Amplifier**  
30 Watts In—100 Watts Out  
All Mode Operation FM,SSB,CW,ATV  
2 to 35 Watts Input

**BACKED BY THE INDUSTRY'S ONLY 5 YEAR WARRANTY**  
See the complete line of Mirage RF Amplifiers, Peak Reading Watt/SWR Meters and accessories at your local dealer or contact:

**MIRAGE**  
P.O. Box 1000  
Morgan Hill, CA 95037  
(408) 779-7363

CIRCLE 74 ON READER SERVICE CARD

# Modulate Our Multitude of Ample Amps

Hard to get through on our 800 number? Call before 10 a.m. or after 5 p.m., or call our regular number. If you pay for the call and order, we'll credit your order with \$1.

## KENWOOD

## YAESU

## ICOM

## SANTEC

### HF TRANSCEIVERS



- NEW TS-940S HF Transceiver CALL  
With General Coverage Receiver
- TS-930S HF Transceiver CALL  
With General Coverage Receiver
- TS-430S HF Transceiver SUPER SPECIAL  
With General Coverage Receiver
- TS-830S Transceiver CALL  
160-10 Meter With Power Supply
- TS-530SP 160-10 Meter XCVR CALL  
With Power Supply & Notch Filter

### RECEIVERS

- R-2000, R-600, R-1000, R-11 CALL  
General Coverage Receivers

### VHF/UHF



- TR-7950/7930 CALL  
2-meter Mobile Units, 45 or 25 Watts
- TR-9130 2m All-mode, 25 Watts CALL
- TS-711A/TS-811A CALL  
All-mode Transceivers  
2m or 70cm mobile or base station

### HANDHELDS

- TR-2600A 2m FM Transceiver CALL  
With memories, LCD, scan
- TH-21A, 21AT/TH-41A, 41AT CALL  
2m/70cm Ultra-compact FM Transceiver

### HF TRANSCEIVERS

- FT 980 CAT System 1439.00  
AC Power Supply, Full Break-in CW,  
SSB/AM/FM/FSK, Speech Processor



- FT 757 HF XCVR with mic 699.95  
with General Coverage RCVR  
includes CW keyer, AM/FM, CW filter

### NEW SCANNER

- FRG 9600 499.95  
Continuous Coverage  
60 MHz-905 MHz, All mode

### SWL RECEIVER

- NEW FRG 8800 SWL Receiver 510.00  
VHF Converters, Active Antennas available

### HANDHELDS

- FT 209RH 2m HT 299.95  
FREE FTS-6 Tone Encoder with each FT  
209RH

All accessories in stock

### VHF/UHF

- NEW FT 270RH 2m, 45-watt 369.95  
Very high mobile rig
- NEW FT 2700RH 25-watt 499.95  
Dual-band 2m and 440



- FT 726R For 2m 759.95  
(Optional modules for 6m, 430, 440 MHz)  
Great for Satellite Work

### HANDHELDS

- IC 02AT 2m HT, 10 Memories CALL
- IC 04AT 440 HT/Touchtone CALL
- IC 2AT 2m HT/Touchtone 199.95
- IC 3AT 220 MHz HT/Touchtone 229.95
- IC 4AT 440 MHz HT/Touchtone 229.95

### SWL RECEIVERS

- R71 Limited Quantities 599.95  
General Coverage Receiver

### VHF/UHF

- NEW IC 3200 2m/440 bands 489.95
- IC 271H 100-watt 2m XCVR 732.95
- IC 27A 2m compact mobile 309.95
- IC 290H 25-wt all-mode 2m XCVR 479.95



- IC 271A Special 559.95  
All-mode 2m Transceiver

### HF TRANSCEIVERS



- NEW IC 735 HF XCVR CALL
- IC 751 HF XCVR/Gen Cov RCVR 1179.00  
With PS35 installed 1299.00
- IC 745 759.95  
HF XCVR/Gen Cov RCVR

### MARINE

- M12 12-ch Programmable HT 219.95
- M2 76-channel Synthesized HT 261.95
- M80 25-watt all-channel Scanner 387.26
- M80C Commercial M80 429.95
- New M5 all-channel HT 325.95

### KDK

- FM 2033 2m, 25-watt 259.95
- FM 240 2m, 25-watt 299.95

- STLC Leather Case for ST 142 34.95
- SM3 Speaker Mic for ST 142 34.50



- 2591 2m Synth Handheld 259.95
- Century 22 CW XCVR 350.00
- 2510 Model B 410.95  
Satellite Station for Oscar 10
- CORSAIR II Model 561 CALL
- ARGOSY II 525D Digital 519.95
- TRITON 425 HF Amp 1.5kW CALL

### SCANNERS

#### REGENCY

- New R1060 10-ch, 6-band 99.95
- MX4000 mobile 30-900 MHz 389.00
- HX1000 20-ch Handheld 209.95
- HX2000 Handheld 120-900 MHz 299.95
- MX3000 30-ch, 6-band mobile 210.95
- MX5000 20-ch 25-512 MHz cont. 354.95

#### BEARCAT

- New 100XL Handheld Call
- 260 16-ch mobile 248.95
- 201 16-channel/aircraft 169.95
- 2020 40-ch/aircraft 274.95
- 210XL 195.00
- 300 50-ch scanner/aircraft 341.00

#### SONY RECEIVERS

- 2002 SWL Receiver 209.95
- 2010 SWL Receiver 279.95
- 4910 SWL Receiver 89.95

### ANTENNAS

- CUSHCRAFT
- A3 3-element 10-15-20m 205.00
- A4 4-element 10-15-20m 264.95
- R3 10-15-20m Vertical 256.95
- 214B SSB/215WB FM 2m Boomers 73.00
- ARX-2B 2m Ringo Ranger 34.95
- A3219 2m Boomer 88.00

- KLM
- KT34A 4-element 10-15-20m 334.95
- KT34XA 6-element 10-15-20m 479.95
- 2m-11X 11-element 2m 59.95
- 2m-16LBX 16-element 2m 91.95

- MOSLEY
- CL-33 3-element Triband Beam 265.95
- TA-33 3-element 10-15-20m 239.95
- Pro 37 7-element 10-15-20m 465.95

- HUSTLER
- 6-BTV 10-80m Vertical with 30m 128.95
- 5-BTV 10-80m Vertical 108.95
- MOBILE RESONATORS Standard Super
- 10 and 15 meter 11.95 17.95
- 20 meters 15.50 21.95
- 30 and 40 meters 17.95 25.95
- 75 meters 19.95 36.95

- HY-GAIN
- 391S TH7DX 7-ele 10-15-20m CALL
- 395S Explorer 14 10-15-20m CALL
- Order Hy-Gain tower, Hy-Gain antenna, &  
Hy-Gain rotor—get free shipping on all.

- MORE ANTENNAS
- AEA Isopoles CALL
- AVANTI HM 151, 3G 2m on-glass 31.95
- LARSEN LM-150 5/8 Mag Mount 39.95
- MINIQUAD HQ-1 141.95
- BUTTERNUT HF6V 10-80m Vert 109.95
- BUTTERNUT HF3B 2-ele Beam 169.95
- FOR OSCAR by Cushcraft & KLM CALL

### TOWERS



- Self-supporting towers:
- HBX40 40-feet with Base 198.00
- HBX48 48-feet with Base 264.00
- HBX56 56-feet with Base 335.00
- HDBX40 Higher load with Base 248.00
- HDBX48 Higher load with Base 325.00  
Other BX, HBX, HDBX in stock

- Guyed foldover towers:
- FK2558 58-feet, 25G 940.00
- FK4554 54-feet, 45G 1296.00
- Other sizes at similar savings.  
Foldovers shipped freight paid.  
10% higher west of the Rockies.

- Straight Sections:
- 20G Straight Section 37.95
- 25G Straight Section 48.95
- 45G Straight Section 109.00
- Complete Tower Packages CALL



- CABLE BY SAXTON
- RB213 Mil Spec 29\*/ft
- RG8/U Foam 95% Shield 25\*/ft
- 8-wire Rotator 2 #18, 6 #22 17\*/ft
- Mini-8 95% Shield 13\*/ft
- CABLEWAVE HARDLINE Call

### ACCESSORIES

- FOR PACKET
- AEA PKT1 Packet Controller 459.95
- Kantronics Packet Controller 210.95

- BENCHER PADDLES
- Black/Chrome 38.95/48.95

- ASTRON POWER SUPPLY
- RS7A 49.95 RS20M 104.95
- RS12A 69.95 RS35M 149.95
- RS20A 89.95 VS20M 124.95
- RS35A 133.95 VS35M 169.95
- RS50A 189.95 VS50M 209.95

- BIG DISCOUNTS
- TELEX HEADPHONES
- Procom 350 Procom 450  
Procom 250 and others  
Call for our prices

- B & W
- 375 6-position Coax Switch 23.50
- 425 1 kW Low Pass Filter 27.50

- DAIWA/MCM/J.W. MILLER
- CN-520/CN-540 Meters 59.95/69.95
- CN-620B/CN-630 Meters 106.00/126.00
- CN-419 Antenna Tuner 500 W 174.95

- AMPHENOL
- Connectors of all kinds in stock CALL

- ROTATORS
- Alliance HD73 105.00
- Kienpro KR500 Elevation Rotator 159.95
- Hy-Gain Ham IV CALL
- Hy-Gain Tailtwister T\*X CALL
- Hy-Gain CD4511 CALL
- Hy-Gain Heavy-duty 300 CALL
- Buy an HF Beam & get an HD73 for \$99.95

### AMPLIFIERS

- TOKYO HY-POWER
- VHF & UHF amps CALL for Quotes

- DAIWA
- LA-2035 2m Amp, 2 in, 30 out 68.95
- LA-2035R 2m Amp with preAmp 74.95

- B23A 2m Amplifier 2-30 84.95
- B1016 2m Amplifier 10-160 242.95
- B3016 2m Amplifier 30-160 199.95
- D1010N UHF Amp/N connectors 279.95
- B215 2m Amp, 2 in, 150 out 245.95
- A1015 6m Amp, 10 in, 150 out 242.95

- AMERITRON HF AMPS
- AL80A 1200 watt 659.95
- AL84 HF Amp 160-15 389.95
- AL1200 1.5 kW Amp 1399.95

- KENWOOD TL922 2kW CALL
- AMP SUPPLY
- LA 1000A 160-15m Amp 389.95
- LK 500NT HF Amp no tune 1185.00
- AT 1200A 1200 PEP Tuner 169.95
- LK 500ZB 2.5 kW hipersil 1132.95

- VOCOM AMPLIFIERS
- 2 watts in, 30 watts out 2m Amp 69.95
- 2 watts in, 60 watts out 2m Amp 107.95
- 2 watts in, 120 watts out 2m Amp 169.95
- 200mW in, 30 watts out 2m Amp 84.95

- New VHF/UHF Amps  
from TE Systems  
with Low Noise  
GaAs FET Preamp  
Call for Quotes

- HAL
- CWR 6850 Teletreader 746.95
- CRI 100 RTTY/CW Interface 214.95
- CRI 200 RTTY/CW Interface 259.95
- Other items available CALL

### HARDWARE

- MFJ 1224 with MFJ C-64/V-20 Soft 79.95
- MFJ 1229 CALL
- Kantronics Interface II 210.95
- AEA CP-100 Interface 284.95
- AEA MPI Micropatch 119.95
- AEA CP-1 Interface 179.95

### PACKAGES

- Microlog AIR-1 Vic-20/C-64 179.95
- AEA Copr for Vic-20/C-64 209.95
- AEA Microamtor Patch MAP-64 119.95

### SOFTWARE

- Kantronics Hamtext  
Vic-20, C-64, Apple CALL

- Kantronics Hamsoft/Amtor  
Vic-20, C-64, TRS-80 color, Atari 69.95

- Kantronics Hamsoft  
Vic-20, Apple, Atari, TRS-80C, TI-99 CALL

- Microlog Air Disk  
Vic-20 and C-64 Disk 39.95  
Cartridge 56.95

- AEA
- MBA Text Vic-20 or C-64 79.95
- MBA-tor 64 89.95
- Marstext Vic-20 or C-64 79.95

- Dr. DX by AEA 95.95
- Dr. QSO by AEA 71.95

### HY-GAIN FACTORY REBATE

- From 1 Aug. to 30 Sep. 1985.
- 10% Factory Rebate on  
TOWERS  
ROTATORS  
ANTENNAS
- Limited to one item per category.



- 13646 Jefferson Davis Highway  
Woodbridge, Virginia 22191  
Information & Service: (703) 643-1063
- Store Hours: MTT: 10 a.m. - 6 p.m.  
WF: 10 a.m. - 8 p.m.  
Sat: 10 a.m. - 4 p.m.
- Order Hours: M-F 9 a.m. - 7 p.m.  
Saturday 10 a.m. - 4 p.m.

- Send 3 22\* stamps for a flyer.  
Dealer Inquiries Invited



- Our associate store  
Davis & Jackson Road, P.O. Box 293  
Lacombe, Louisiana 70445  
Information & Service: (504) 882-5355



- Terms: No personal checks accepted.  
Prices do not include shipping. UPS  
COD fee: \$2.35 per package. Prices are  
subject to change without notice or  
obligation. Products are not sold for  
evaluation. Authorized returns are sub-  
ject to a 15% restocking and handling  
fee and credit will be issued to use on  
your next purchase. EGE supports the  
manufacturers' warranties. To get a  
copy of a warranty prior to purchase,  
call customer service at 703-643-1063  
and it will be furnished at no cost.



For Orders and Quotes Call Toll Free: 800-336-4799  
Virginia Orders and Quotes Call Toll Free: 800-572-4201

CIRCLE 40 ON READER SERVICE CARD

ters. On 40, 20, 15, and 10, received signal levels are noticeably and consistently poorer on the dipole than on my 14AVQ vertical. Contrary to your article [which indicted that a tuner might not be required—ed.], but perhaps due to the low height and trees, an antenna tuner is required. However, the uncorrected SWR is fairly constant across the bands. For 160, it's 4:1, for 80 it's 3:1.

"The 30 meter band is a different story. Uncorrected SWR is over 10:1, and the best adjustment I can make is 2.5:1 [with the tuner]. Changing the RG-213 cable length between the balun and tuner changes the SWR to a best case of 3:1."

Rob concluded that more experimentation is needed to achieve better performance on 30 meters, though performance on 160 and 80 was good.

In past columns, and most recently in the January 1985 column, we presented some unusual wire antenna designs submitted by Cliff Francis, W0MBP. Cliff is a dedicated antenna experimenter and tinkerer who frequently sends us reports of his experimentation with "broadside curtains," multiple Windoms, and other complicated and often controversial designs.

A few months ago Cliff sent us a set of six rather complex designs for a "Combined Effect Antenna," longwires that will resonate on a large number of frequencies between 3 and 30 MHz. These single-wire antennas make use of a number of vertical wire elements suspended from the horizontal flattop. Cliff has found that by carefully choosing the length and arrangement of the vertical elements, multiple resonances are possessed by these dual-polarized antennas, especially useful for MARS work as well as out-of-band shortwave listening.

Cliff's several designs were too numerous to describe in detail and diagram in this month's column, so we suggest that readers who are interested in this type of multi-resonant wire antenna trade notes by corresponding directly with Cliff. Write to him at 325 S. 3rd St., Silsbee, TX 77656. I'm sure that Cliff would appreciate your enclosing an SASE with your letter.

## Product Peek

This month we take a look at the antenna noise bridge (ANB), in particular F. Gordon Adams, W8URR's Tennatest. First, let's review some basic facts about the ANB, one of the most useful and popular hamshack instruments.

The ANB is a self-contained package that is useful in adjusting an antenna system to resonance by using a receiver alone; no transmitter energy need be fed to the antenna in order to make measurements on it. The ANB can also be used for a variety of other impedance-measuring and related chores, as we shall see. The ANB can be homebrewed from popular

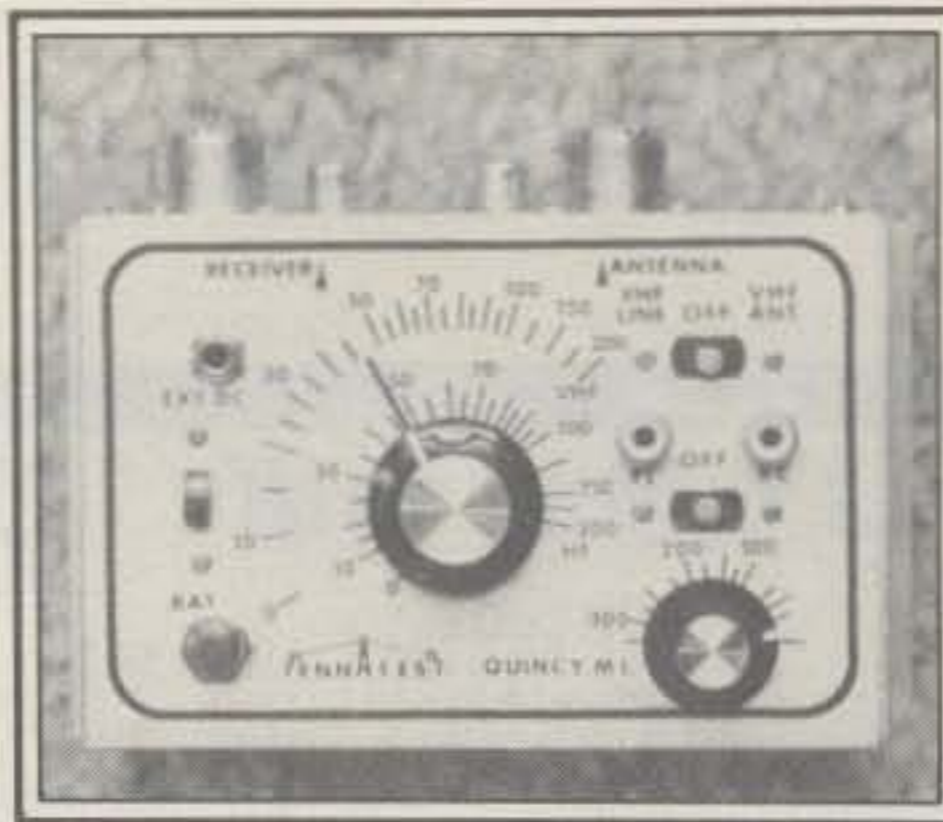

Shown here is W8URR's Tennatest noise bridge. The unit has a number of useful capabilities, including determination of resonant frequency, VSWR at resonance, resistive impedance, inductive reactance, and capacitive reactance. The VHF model is shown here, and an HF model is also available. (Photo courtesy W8URR)

Handbook or magazine article designs, or commercial units by MFJ, Radiokit, Palomar Engineers, W8URR, or others may be purchased.

The ANB is, in fact, an updated version of earlier instruments, known variously as the Antennascope (described in *CQ* by the late Wilfred Scherer, W2AEF, in 1950), antenna bridge, impedance bridge, antenna null detector, or Z-bridge. The big difference between the ANB and its predecessors is that it includes a built-in broadband noise source. As a result, it doesn't have to be driven by an external signal, such as that from a grid-dip oscillator or transmitter. When the ANB is used with a reliable and stable communications receiver that can tune to the desired frequency, both the antenna resonant frequency and the impedance at resonance can be measured with confidence.

The ANB is an excellent supplement to the SWR bridge, and it allows you to learn a good deal more about your antenna system than does the SWR bridge alone. The ANB is actually a more useful instrument, in that it allows you to determine capacitive and inductive reactance, among other things, and it tells you "which way to go" in adjusting the antenna.

Modern ANBs contain a broadband noise generator and an RF impedance bridge. The known leg of the bridge has a calibrated variable resistor and a calibrated variable capacitor, controlled by a front-panel knob or knobs. The antenna or circuit to be measured is connected to the unknown leg of the bridge, while a receiver, used as a detector, is used to determine frequency.

W8URR's Tennatest ANB, available in both an HF and a VHF version, is designed to simply and easily accomplish most antenna measurements. These include determination of resonant frequency, SWR at resonance, resistive im-

pedance, capacitive and inductive reactance, and electrical feedline length. According to Gordon, the Tennatest unit has a very sharp "noise null," and thus is capable of excellent measurement accuracy. For example, electrical feedline length may be determined with 2 kHz, and accurate determination of feedline velocity factor is possible. Interestingly, the HF model boasts an impedance range of 20 to 300 ohms, and the VHF model features a range of 10 to 200 ohms, but both ranges may be expanded by a factor of four (from 80 to 1200 ohms, and from 40 to 800 ohms, respectively) using a small 4:1 TV-type balun transformer.

The device consists of a noise-generating diode, followed by a wideband, three-stage transistor amplifier, which is transformer coupled to the calibrated bridge circuit. Power is supplied by a 9 volt transistor radio battery or by an external power supply. Connection is made by inserting the noise bridge between the antenna, or other series-resonant circuit, and the receiver. The receiver, which must be able to be tuned to the resonant frequency in order to determine the "null" or decrease in noise, indicates the null point, and the impedance is shown on the bridge's calibrated dial.

As of this writing, the 1-40 MHz HF model is priced at \$39, while the VHF model is priced at \$68. Gordon obviously takes pride in his product, as his advertising literature boasts that if you don't feel that the Tennatest outperforms others, it may be returned for a full refund of the purchase price, shipping, and \$5 for your trouble! Contact Tennatest, F. Gordon Adams, W8URR, 1025 Wildwood Road, Quincy, MI 49082.

## Software Notes

This month we have room to cover just three computer software offerings, but they are all interesting and useful ones. Let's begin with AMSAT.

The Radio Amateur Satellite Corporation (AMSAT) can help you and your computer to "come aboard" the amateur space program. Naturally, whatever antennas you choose to use to "work" one of the OSCAR or other amateur satellites, you must accurately point them toward the satellite, rotating them in both azimuth and elevation. To determine where to point your antennas, you can use a graphical plotting aid, or you can use your personal computer with software available from the AMSAT Software Exchange, Box 27, Washington, DC 20044.

The primary programs offered by AMSAT are versions of the W3IWI orbit prediction program, which tells you just about everything you need to know for determining when to listen and exactly how to position your antennas. Various versions of the program are available to support a wide variety of popular computers. These include the several Radio Shacks and Apples, IBM-PC, TI 99/4, North Star,



**START COPYING CW THE EASY WAY!**

- \*\*Start copying words instead of letters!\*\*
- \*\*Master the standard exchange in just a few evenings!\*\*
- \*\*Gain on-the-air confidence quickly!\*\*

**THE QSO-TRAINER™ Code Course** - For the ham who already knows the code. If you have been a ham for a while, tried the "traditional" random-letter approach to code practice, and still don't have the on-the-air confidence you'd like—this course may be exactly what you need.

Easy-to-learn lessons on two 60-minute audio cassettes.

Send \$14.95 + \$2.00 shipping and handling (IN residents add \$0.85) to:

**AVC INNOVATIONS, INC.**  
Dept. C, P.O. Box 20491  
Indianapolis, IN 46220

CIRCLE 132 ON READER SERVICE CARD

**It's Time For the Best.**



Beautifully designed...precision built with quartz accuracy.

- A. North American CORK map. Sturdy oak frame 19"x25". U.S. call areas/Mexican & Canadian prefixes. 24 & 12 hr. clocks. **\$4989**
- B. Personalized call sign. Rich pine. Sweep sec. hand. 24 hr. dial 12 hr. dial day & date. **\$3995**
- C. Local time in 57 world locations. Fine oak case 8" high. On/off switch. Sweep sec. hand. Daylight/Nighttime hrs. Luminescent hands. **\$5995**
- D. Personalized call sign. Warm oak 3 1/2"x11". 12 hr. dial/sweep sec. hand. **\$2675**

Send price + \$3.00 P&H to: Since  
**LITTLE WOLF TIME CO.** 1975

Rt. 1, Box 278A, Ogdensburg, WI 54962  
Give exp. date. (715) 467-2748

CIRCLE 54 ON READER SERVICE CARD

**MULTI BAND TRAP ANTENNAS**



**TRAP DIPOLES:**

Model	Bands	Traps	Length	Price
D-42	10/15/20/40	2	55'	\$59.95
D-52	10/15/20/40/80	2	105'	\$64.95

**TRAP VERTICALS - "SLOPERS":**

Model	Bands	Traps	Length	Price
VS-31	10/15/20	1	12'	42.95
VS-41	10/15/20/40	1	21'	44.95
VS-52	10/15/20/40/80	2	52'	59.95

\*Can be used without radials  
\*Feed line can be buried if desired

\*Permanent or Portable Use

All ANTENNAS are Factory assembled - Commercial Quality - Handle full power - Comes complete with: Deluxe Traps, Deluxe center connector, 14 ga Stranded Copper Weld ant. wire and End Insulators. Automatic Band Switching - Tuner usually never required - For all transmitters, Receivers & Transceivers - For all class amateurs - One feedline works all bands - Instructions included - 10 day trial!

**COAX CABLE:** (includes PL-259 connector on each end)

Type	Length	With antenna purchase	Separately
RG-58	50'	\$8.00	\$11.95
RG-58	90'	12.00	16.95

**DELUXE CENTER CONNECTOR**

- \* NO RUST Terminals
- \* NO jumper wires used
- \* NO Soldering
- \* Built in Lightning Arrestor
- \* With SO-239 Receptacle
- \* Handles Full Power
- \* Completely sealed, weatherproof
- \* Easy element adjustments
- \* Commercial quality



**DELUXE ANTENNA TRAPS:** Completely sealed & weatherproof - Solid brass terminals - Handles Full power - NO jumpers - NO Soldering - Instructions included

For 4 band Dipole Ant. 40/20/15/10	\$36.00/pr.
For 5 band Dipole Ant. 80/40/20/15/10	\$38.00/pr.

ORDER DIRECT FROM FACTORY: All orders shipped US Postpaid  
VISA/MC - give card #, Exp. date, Signature

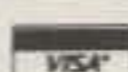

**SPI-RO MANUFACTURING, INC.**  
Room 104, P.O. Box 1538  
Hendersonville, NC 28793



Dealer Inquiries Invited

**FREE SATELLITE TV**



**800-4-SATMAN**

**NEW 24 Page Buyer's Guide With Guaranteed Lowest Prices**

- Explains all about FREE 100 channel Satellite TV and how to shop for an earth station!
- Lists GUARANTEED LOWEST PRICES...we will not be undersold, save 30-50% over local dealer prices!
- Tells how to easily and quickly Install-Your-Own earth station and save \$400 or more!
- Shows how to demonstrate and sell earth stations from your home and earn extra money!



The new SATMAN Buyer's Guide is a necessity for any prospective or current earth station owner who wants to save big money on name brand satellite products and also earn some extra money. Buy direct, Do-It-Yourself, and save with SATMAN. Toll free ordering, no sales tax (IL only), major credit cards accepted, huge in-stock inventories available, and fast UPS shipping anywhere in U.S. Check with SATMAN before you buy... We will not be undersold! Call now for your free 24 page SATMAN Buyer's Guide.

**1-800-4-SATMAN**

1-309-692-9582 Illinois



5017 N. MELODY • PEORIA, IL 61614 • 1-800-4-SATMAN

clip and save

**Crystal Filters**

for KENWOOD TS830, TS930, TS940

Our filters have received universal praise. As famous con-  
tender VE3BMV wrote recently in Radiosporting's review: "...  
Kenwood filters are great but 8-pole Fox Tango filters are  
better... I have put a pair in my 930 and the improvement is  
fantastic..."

**FOX TANGO MATCHED-PAIR FILTER KITS**  
2.1KHz for SSB; 400Hz for CW ..... \$139 ea.  
SSB and CW (4 filters) SPECIAL ..... \$250

Kits include detailed instructions and all needed parts.  
Specify bandwidths and Kenwood Model when ordering.  
FOX TANGO filters equal or exceed the claims of imitators.  
Why risk disappointment? Get the real thing!

SHIPPING: \$3 US, \$5 Air (US & Canada), \$10 Elsewhere  
Order by mail or phone • VISA/MC or COD accepted  
Ask About Our Filters For Many Other Rigs.

**FOX-TANGO Corp.**

Box 15944, W. Palm Bch, FL 33416  
Telephone: (305) 683-9587

CIRCLE 52 ON READER SERVICE CARD



Say You Saw It In CQ

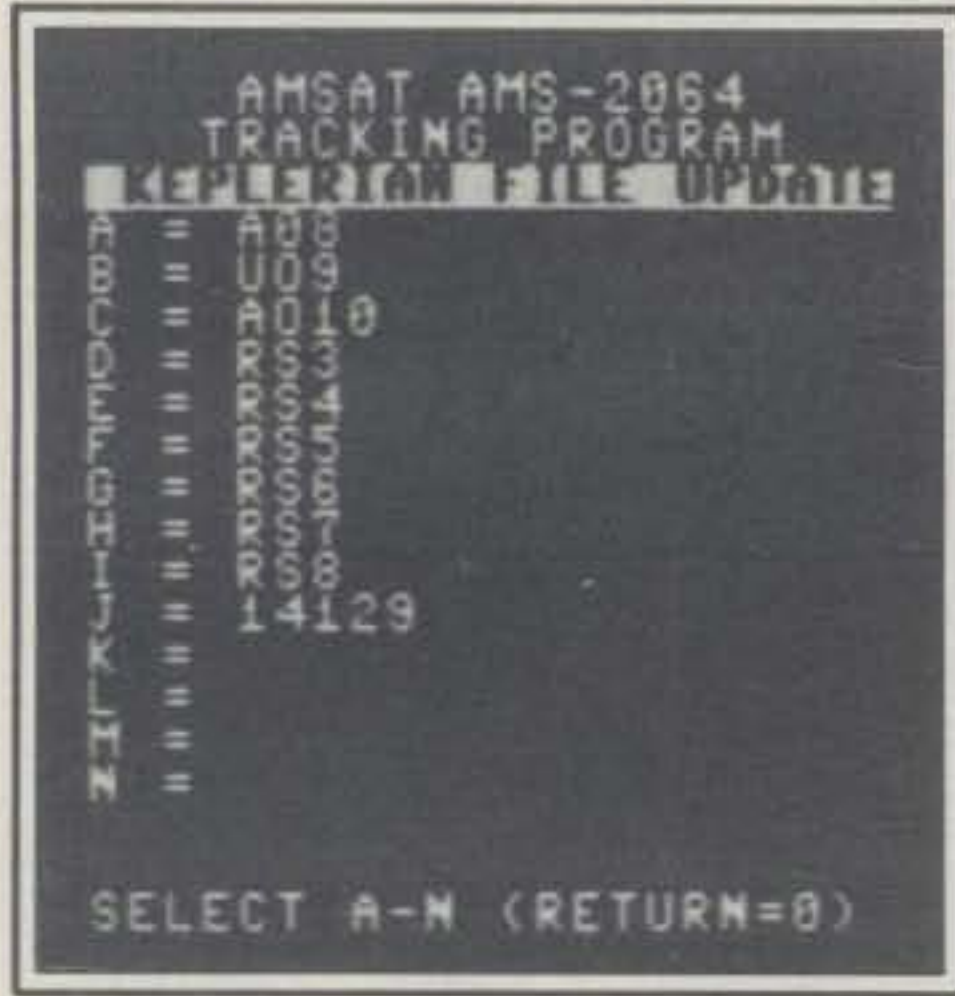

AMS-2064 Keplerian file menu. The program, based on the W3IWI orbit prediction program, is available for a dozen or more personal and home computers, and allows the user to make accurate orbital predictions for two-way amateur communications. (W8FX photo)

Timex Sinclairs, Atari, Vic-20, Commodore 64, and others. Other programs, such as the KORZ antenna positioning software for the Apple-II, and Quiktrak for the Commodore 64 and Vic-20, are offered as well. Most, though not all, of the programs are available on either disk or tape and cost between \$10 and \$20. Con-

TRACKING: A010 FROM: 30NOV84 010000					
UTL	UTL	UTL	UTL	UTL	UTL
01:00:00	22639	33	38119	145.81	182
02:28:42	22639	24	38833	-.2	134
03:48:47	22639	15	37766	.1	160
04:52:53	22635	6	33948	.4	187
05:38:37	256	0	29816	.7	203

Partial tracking screen printout derived from the AMSAT AMS-2064 orbital prediction program. (W8FX photo)

tact the AMSAT Software Exchange for more details and their current "program availability notice." (While you're doing this, you might also inquire as to AMSAT membership, certainly worthwhile to help support the amateur space effort and to keep on top of the action.)

Amateurs who are into serious circuit design should be interested in two Commodore 64 offerings from Nth Digit Solutions, 3243 Arlington Avenue No. 195, Riverside, CA 92506. Two electronic program packages are offered. The first is the Circuit Analysis Package, costing \$34.95, which includes two powerful programs to analyze the frequency and phase response of practically any circuit configuration. The General Circuit Analysis Program analyzes the amplitude and phase response of a wide variety of cir-

cuit configurations of up to 25 nodes and 40 branches. The network elements may be resistors, capacitors, inductors, FET or NPN transistors, or operational amplifiers. The branches entered, as well as the analysis output, may be directed to a printer for hardcopy. Also included in the package is the Ladder Circuit Analysis Program, which will analyze ladder networks of up to 200 branches, computing the amplitude and phase of various transfer functions. This program will handle resistors, inductors, capacitors, transformers, transmission lines, stubs, and other components.

The Circuit Design Package, priced at \$24.95, is a menu-driven collection of 13 utility programs used to solve many electronic design problems. These may relate to active and passive filters of various

**★ QUALITY PARTS    ★ DISCOUNT PRICES    ★ FAST SHIPPING!**

**SEND FOR FREE FALL 1985 CATALOG... 48 PAGES!**

**ALL ELECTRONICS CORP.**  
905 S. VERMONT • P.O. BOX 20406 • LOS ANGELES, CA 90006

---

**13.8 VDC REGULATED POWER SUPPLY**

These are solid state, fully regulated 13.8 vdc power supplies. Both feature 100% solid state construction, fuse protection, and L.E.D. power indicator U.L. listed.

2 amp constant, 4 amp surge    \$18.00 each  
3 amp constant, 5 amp surge    \$25.00 each

---

**\*SPECIAL PRICE\* DUAL L.E.D. DISPLAYS**

560 high, 7 segment L.E.D. read-outs. Mount in 24 pin DIP sockets.

FND-5148 red, c.c.    75¢ each  
DL-527 red, c.a.    75¢ each  
MAN-6640 orange, c.c.    75¢ each

**EDGE CONNECTORS**

ALL ARE 1.56" SPACING.

22/44 EDGE CONNECTOR PC style    \$2.00 each  
22/44 EDGE CONNECTOR solder lug style    \$2.50 each  
28/56 EDGE CONNECTOR PC style    \$2.50 each

---

**MINIATURE TOGGLE SWITCHES**  
ALL ARE RATED 5 AMPS @ 125 VAC

**S.P.D.T. (on-on)**  
PC style non-threaded bushing  
75¢ each  
10 for \$7.00

**S.P.D.T. (on-on)**  
Solder lug terminals  
\$1.00 each  
10 for \$9.00  
100 for \$80.00

**S.P.D.T. (on-off-on)**  
Solder lug terminals  
\$1.00 each  
10 for \$9.00  
100 for \$80.00

---

**ULTRA-MINIATURE 5 VDC RELAY**

Fujitsu # FBR211NED005M20  
High sensitivity  
COIL: 120 ohms  
CONTACTS: 1 amp  
Mounts in 14 pin DIP socket

\$1.25 each  
10 for \$10.00

**D.P.S.T. LIGHTED ROCKER SWITCH**

115 vac lighted rocker snap mounts in 7/8" x 1 1/8" hole  
Orange lens: 16 amp contact

\$1.50

---

**MINI-PUSH BUTTON**

S.P.S.T. momentary normally open 1/8" bushing  
Red button  
35¢ each  
10 for \$3.00

---

**COMPUTER GRADE CAPACITORS**

2,000 mfd. 200 VDC 1 1/4" DIA. x 5" HIGH    \$2.00  
3,600 mfd. 40 VDC 1 1/4" DIA. x 3 1/4" HIGH    \$1.00  
6,400 mfd. 60 VDC 1 1/4" DIA. x 4 1/4" HIGH    \$2.50  
9,700 mfd. 50 VDC 1 1/4" DIA. x 4 1/2" HIGH    \$3.00  
31,000 mfd. 15 VDC 1 1/4" DIA. x 4" HIGH    \$2.50  
72,000 mfd. 15 VDC 2" DIA. x 4 1/4" HIGH    \$3.50  
185,000 mfd. 6 VDC 2 1/2" DIA. x 4 1/2" HIGH    \$1.50

---

**FLASHER LED**  
5 volt operation red jumbo T 1 1/4 size \$1.00 each

**BI-POLAR**  
jumbo T 1 1/4 size 2 for \$1.70

---

**STANDARD JUMBO DIFFUSED T 1 1/2**

RED    10 for \$1.50  
         100 for \$13.00  
GREEN    10 for \$2.00  
         100 for \$17.00  
YELLOW    10 for \$2.00  
         100 for \$17.00

---

**TOLL FREE ORDERS**  
★ 1-800-826-5432  
(IN CA: 1-800-258-6666)  
INFO • (213) 380-8000  
TWX - 5101010163 ALL ELECTRONIC

● QUANTITIES LIMITED  
● MINIMUM ORDER \$10.00  
● USA \$3.00 SHIPPING  
● NO C.O.D.  
● FOREIGN ORDERS INCLUDE SUFFICIENT SHIPPING  
● CALIF. RES. ADD 6.12%

CIRCLE 16 ON READER SERVICE CARD

**MAXCOM**  
INCORPORATED  
AUTOMATIC ANTENNA MATCHER

**ONE ANTENNA .3 TO 70 MHZ.  
VSWR 1.5:1 OR LESS**

UNEXCELLED FOR "FREQUENCY HOPPING"

- \* NO MOVING PARTS !
- \* 5 YEAR WARRANTY !
- \* INSTANT MATCHING !
- \* 50 OHM INPUT !
- \* LOW NOISE !
- \* DIPOLE !
- \* MARINE !
- \* AMATEUR !

- \* 100% SOLID STATE !
- \* NO CONTROL LEADS !
- \* LIGHT WEIGHT !
- \* HIGH EFFICIENCY !
- \* 200 TO 2KW. P.E.P. !
- \* LONG WIRE !
- \* MILITARY !
- \* AVIONICS !

★ MADE IN AMERICA, BY AMERICANS. ★  
Over 2,000 Satisfied Users

**"NEW R.F. GROUNDLESS LONGWIRE MODELS  
NOW AVAILABLE"**

CONTACT  
**MAGNUM DISTRIBUTORS INC.**  
1831 South Dixie Highway, Pompano Beach, Florida 33060  
305-785-2002 • Telex 514365 (English FTL)

CIRCLE 61 ON READER SERVICE CARD

```

AMSAT AMS-2064
TRACKING PROGRAM
NAME? U09
ID? NASA SET 489
EPOC? 18JUL83 084250
IMCL? 97.5463
RAAM? 165.624
ECCE? 2.882E-04
ARGP? 165.1355
M.A.? 194.9991
M.M.? 15.2250202
DRAG? 3.859E-05
FREQ? 145.825

```

Keplerian file data for the U09 (AMSAT Oscar 9) satellite as displayed by the AMSAT AMS-2064 program for the Vic-20 and Commodore 64. (W8FX photo)

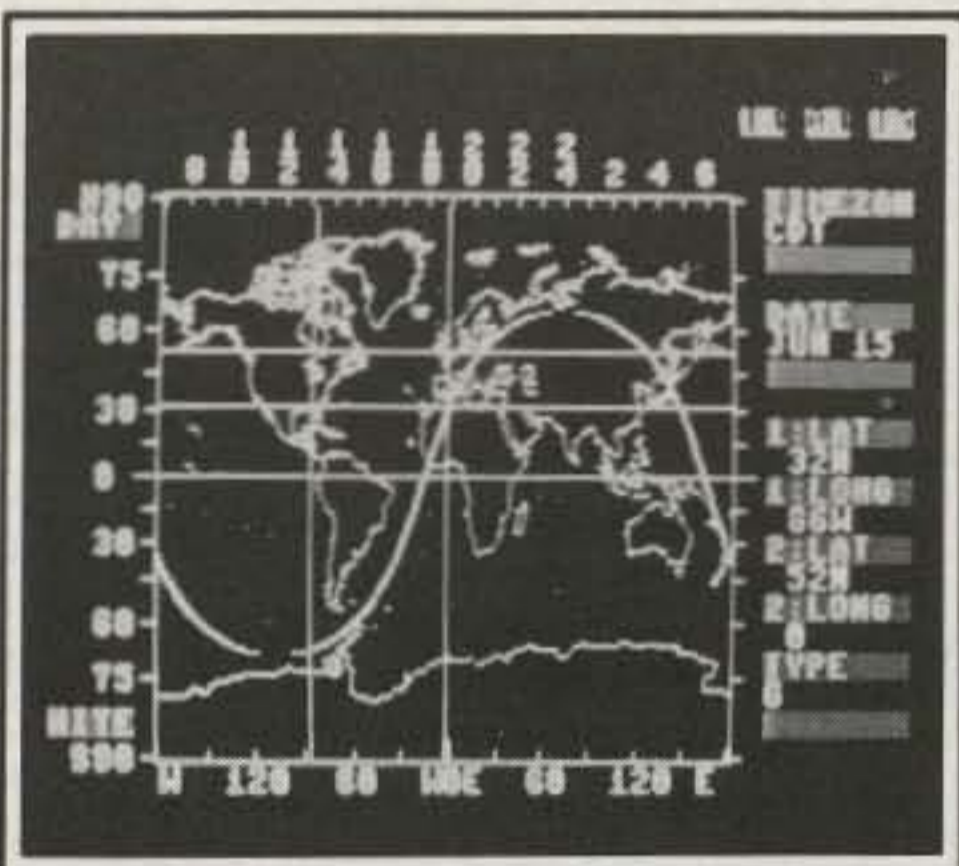

The next few months in your Antennas and Accessories column promise to be packed with interesting material, so stay with us. For example, in an upcoming column we will describe the new Xantek Computerized DX EDGE sunset/sunrise and grayline calculation program for the Commodore 64. (W8FX photo)

types, "L" and "T" attenuators, Ohm's Law, resonance, resistor values, decibels, rectangular-polar conversion, and the like. Both program packages are available only on disk for the Commodore 64. Contact the manufacturer, Nth Digit Solutions, for additional details.

A letter from Milt Webb, WA4FNG, of dataLOG Software, advised us of his line of software for Tandy/Radio Shack Color Computer (CoCo) owners. Milt states that "... there is a lot of software available for the Commodore, Apple, and even for the IBM-PC, and our goal is to make just as much available for CoCo owners."

Milt included a copy of his catalog, which described a number of offerings. These include a comprehensive logging program that can handle up to 1550 QSOs with a two-disk-drive system, a DXCC database, a WAS database, and a disk utility program that is given as a bonus free with every purchase. According to Milt, several new programs are in the works and should be available by the time this column appears. The new pro-

grams include an inexpensive Morse keyboard program and COCOMUF, an MUF (Maximum Usable Frequency) prediction routine.

For more information on this line of CoCo software, contact Milt Webb, WA4FNG, at dataLOG Software, P.O. Box 10531, Jacksonville, FL 32247.

### Wrapping It Up

Okay, gang, that's all the space we're allowed to use this time. To review, in this

month's Antennas column we have provided some followup on the popular G5RV multiband antenna, caught up with some reader mail on a variety of topics, and examined the Tennatest antenna noise bridge. We also highlighted three software offerings of interest to the serious hamshack computerist.

Next time we get together we'll feature several more Antennas topics of timely interest. See you then.

73, Karl, W8FX

## Here's the easiest, lowest-cost way to use the OSCAR 10 Satellite

### New TEN-TEC Satellite Station.

**It's easy.** The new TEN-TEC Model 2510 simplifies station assembly, reduces the number of interconnections, and makes operating easier.

**It's low cost.** Eliminates buying separate converters and another HF rig.

**It's full duplex.** The 2510 is a 435 MHz, 10-watt SSB/CW transmitter and a 2-to-10 meter receive converter all in one package to give you full duplex transmit/receive functions in Mode B. It converts your HF station into an OSCAR station!

**Exclusive single knob tuning.** Provides tranceive-type operation.

**Just add antennas, rotators, and go.** The 2510 transmitter section has a frequency range of 435 to 435.5 MHz (up to 437 MHz with optional board), adjustable ALC, and full controls. Main Tuning sets uplink frequency. Spot Control helps find your downlink signal. Drive Control, Microphone Gain, Band Switch, and Push-Button switches complete the front panel. Push-Button switches are: DUPLEX/MUTE (for duplex operation or for disabling receive converter during transmit); CW/SSB selects mode; USB/LSB selects sideband. The receive converter frequency coverage is 144 to 146 MHz (converted to 28 to 30 MHz) with dynamic range of 85 dB typical. Rear panel connectors are provided for antennas, amplifiers, key, 12Vdc input, and HF receiver.

**Enjoy the most exciting event in Amateur radio today** — with the new TEN-TEC Satellite Station. See your dealer or write for information to TEN-TEC, Inc. Sevierville, TN 37862.



Please send all reader inquiries directly.

## NEWS OF COMMUNICATIONS AROUND THE WORLD

*I want to be a DXer,  
And with DXers stand . . .*

One should never doubt the lure of DXing. It is not necessary to search far for proof of this. When did you last come across a DXer who did not repetitively turn the conversation back to DXing no matter how it might have been headed? A couple of months back the lure brought a Local up the hill to seek the exotic delights of DX. He was not the first.

DX always is fascinating, possibly even more so to those whose lives up to now have been blighted by being trapped into rag-chewing, local nets, and old crony nets, and whose yearly highlight has been the outing for Field Day. But one should not confuse the ability to expand one's horizons with the opportunity to work the far places. This Local had come looking for opportunity.

"Tell me about DXing," he commanded, and we told him. Naturally we told him about the morning paths to the Far East and the Indian Ocean, the night paths to South Africa, and the strong signals always out of the vast Pacific. We expounded on the local yachts which head out from the Golden Gate, hook a left turn, and are soon heard on 14,313 kHz from Nuka Hiva, Moorea, Bora Bora, or Viti Levu. This Local was interested.

We continued, telling him about the great DX Tests—the WPX and the CQ WW DX Tests in which you can work DX around the world and around the clock 24 hours a day just by swinging the beam. When we finished, there were lights shining in the eyes of the Local. He had heard the word; he had taken the lure. He just had to know more.

"The first thing in DXing you have to learn," we gravely advised the Local, "is that the difference between a rag-chewer and a DXer is a tower and a beam. Some may still think that high power is the DXer's key to success. Forget it! A tall tower with a big beam does it all!"

This message was getting through. It was easy to note the thought processes at work as the Local thought of where he might locate a tower on his property, of if it might be necessary to find a new QTH to ensure a good shot in all directions. We were sure that before long he would be thinking of those places in this county where you can fire out over the Pacific in one direction and across or up or down the bay in the other direction.

77 Coleman Dr., San Rafael, CA 94901

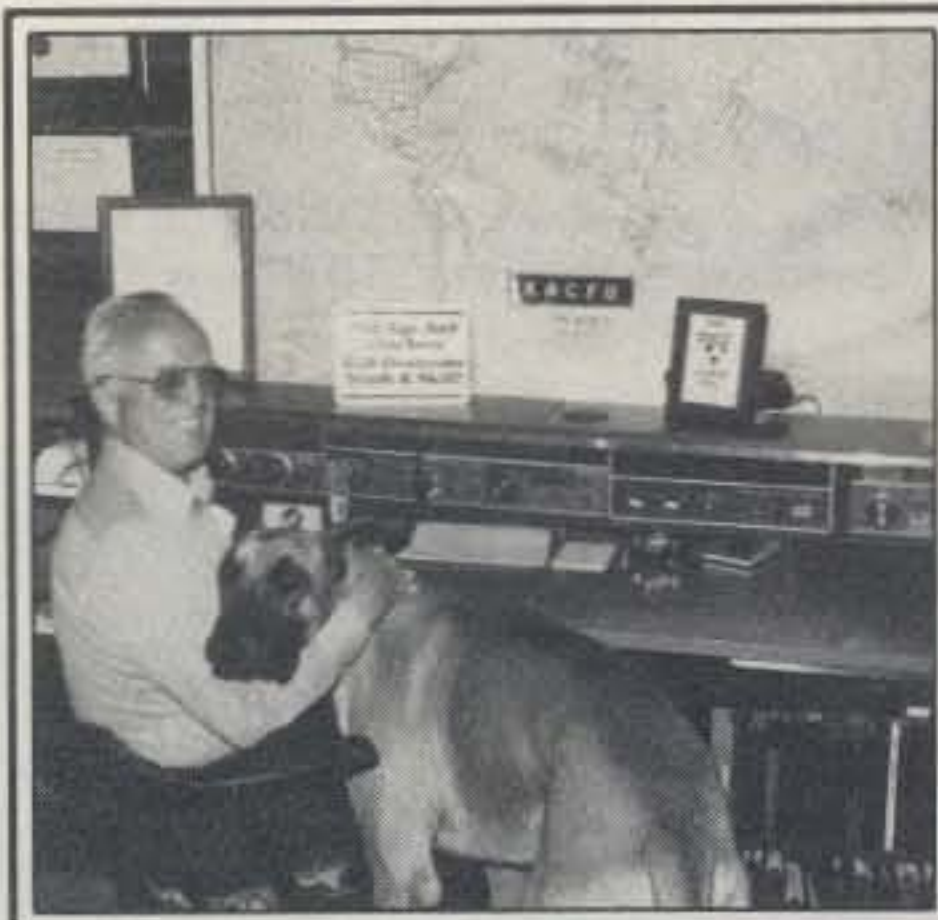

*Here is Arch Doty, K8CFU, once the scourge of the lower Michigan peninsula, but now living high in the mountains in North Carolina. Arch says he did everything with low power, even attaining the DXCC Honor Roll. We believe him. With that dog who would argue?*

One learns but one lesson at a time, and it was the primary tenet of DXing that we were expounding. "Big beams and high towers work DX," we repeatedly emphasized. It was not long before the Local was repeating the axiom word for word. Off he went, but we were sure we would hear from him again.

A couple of months or so later the Local was back. "Say," he said with an opening always remarkable for its originality, "you should see the beam I put up since I was last here. Eighty feet above the ridge at our new QTH, separate mono-banders for 10, 15, and 20. And I have a clear shot in all directions. Of course, the XYL is still complaining that on top of the ridge between the ocean and the bay the wind never stops blowing. I keep telling her that she will get used to it. Do you think she will?"

Of course she would! Every XYL, though she may not be interested in amateur radio or DXing, always takes pride in the accomplishments of the lord of the manor. How often have you heard that strong note of feeling in an XYL's voice when you inquire about a fellow DXer. "Oh, he's been down in the shack all week listening for Malpelo." If it is not Malpelo, it probably will be the Maldives or Maria Theresa. And when the QSLs come through, which member of the family takes the greatest joy? You can hear the ringing overtones when the question is asked, "Here's your QSL, and where the heck is Juan da Nova?" But it was not because he was bursting with joy that the Local came. He had more questions.

"I got the tower up and the antennas

tuned for the DX portions of the bands," the Local told us, "but I don't seem to be working much. Sometimes I hear some DX. Occasionally I will work something, but it does seem that things are not what I expected. I thought that the beam would be making a bigger difference. What do you think?"

What did we think? Just as all DXers think. That some new gear would make a big difference. "Head down to HRO," we advised the Local, "and talk things over with W6RJ. Bob Ferrero will have some good ideas on what you might need. Bob is a big DXer himself, and you will recognize him from his picture in the HRO advertisements in CQ. And be sure to let me know how things go." We were sure that he would. We were also sure that when next he heard of the Local he would be winning all the local club DX tests and probably would even be named the club's DXer of Year at the big Christmas party where no gift is over 75 cents. We could hardly believe that the Local could miss.

It was a surprise to see him again in a month or so. Possibly he could not miss, but apparently he was not making many hits. He still had some problems, and there were still questions unanswered. There were still hopes unfulfilled.

"You know the suggestion you gave me about looking at some new gear," he said, and we nodded our heads at the words. "Well, I got one of those rigs with all the digital readouts, the kind that all real DXers have, and this one allows me to QSY from band to band without retuning. It covers the WARC bands, and has the UP conversion and the PLL circuit to keep the frequency stable. It has two VFOs and low front-end noise. It has LDC readout, VDC final, QSK CW automatic offset, a 500 Hz CW filter, tunable memories, and a speech processor. It even has things that as yet I don't understand. But it does not have DX. What am I doing wrong?"

Real DXers seldom do anything wrong. Some just do things better than others. So we ran through a checklist with the Local. Everything seemed to be in order. "What are you using for a linear?" we finally asked, and the Local shrugged.

"Somehow I got the idea that with a high tower, a new rig, and some nice-looking accessories that I saw at the radio store, I would not have to have a linear. My signal reports are good. At times there are comments on how good the signal is, but that comes only after I have managed to get through. If they can read me so well, then what is the trouble in getting through to them? I thought it would be easier. What am I doing wrong?"

## The WPX Program

### Mixed

1169	K7NN	1172	KA2MBC
1170	I2QMU	1173	YU3BQ
1171	YC0DNK	1174	KA1SR

### S.S.B.

1746	LA7JO	1749	I6GAS
1747	G4UNH	1750	W6OUL
1748	TF5BW	1751	CT1BY

### CW

2327	OK3RRC	2328	W6OUL
------	--------	------	-------

### Endorsements

Mixed: 450 K7NN, I2QMU, VE7EIG, YU3BQ, KA1SR, 500 K7NN, I2QMU, VE7EIG, YU3BQ, KA1SR, 550 K7NN, I2QMU, YU3BQ, 600 K7NN, I2QMU, YU3BQ, 650 K7NN, I2QMU, YU3BQ, 700 K7NN, I2QMU, YU3BQ, 750 K7NN, I2QMU, YU3BQ, 800 K7NN, I0AOF, 850 K7NN, 900 OE1KJW, K9ZO, K7NN, 3A2LF, 950 JA4ESR, K9ZO, K7NN, 1000 JA4ESR, K9ZO, K7NN, 1050 K9ZO, K7NN, N2AC, K2POF, 1100 K9ZO, K7NN, 1150 K7NN, 1200 K7NN, 1250 K7NN, 1300 K7NN, 1350 K7NN, 1400 K7NN, 1450 K7NN, 1500 K7NN, WA4QMQ, 1550 K7NN.

S.S.B.: 350 LA7JO, DL8ZAW, I6GAS, KE6KT, W6OUL, CT1BY, 400 LA7JO, I6GAS, W6OUL, CT1BWY, 450 OE1KJW, LA7JO, I6GAS, W6OUL, CT1BWY, 500 LA7JO, I6GAS, W6OUL, CT1BWY, 550 LA7JO, I6GAS, W6OUL, CT1BY, 600 I2EOW, LA7JO, I2TZK, I6GAS, W6OUL, CT1BWY, 650 LA7JO, I2TZK, I6GAS, W6OUL, CT1BWY, 700 LA7JO, W6OUL, CT1BWY, 750 LA7JO, W7KWI, 800 LA7JO, WO4L, DK5WQ, 850 LA7JO, 900 LA7JO, 950 LA7JO, 1000 LA7JO, 1050 LA7JO, 1100 LA7JO, 1150 LA7JO, 1750 9H4G.

C.W.: 350 W6OUL, 400 KY9P, W6OUL, 450 W6OUL, 500 W6OUL, 550 W6OUL, PA3DBG, 600 W6OUL, 650 OK3CFF, W6OUL, 700 JA7FFN/1, W6OUL, 750 W6OUL, 800 W6OUL, 900 DJ1YH, 1400 WA4QMQ.

10 meters:	JA4ESR, I3ZKD.
15 meters:	I3ZKD, DK5WQ.
20 meters:	I3ZKD.
40 meters:	JA4ESR, I3ZKD, W6OUL.
80 meters:	I3ZKD, OE9SLH, W6OUL.

Asia:	I3ZKD, PA3DBG.
Africa:	I3ZKD.
No. America:	JA2KVD, I3ZKD, OK3BT.
So. America:	I3ZKD, WA4OIB.
Europe:	I3ZKD, DL8ZAW, TF5BW.
Oceania:	I3ZKD.

**Award of Excellence Holders:** K6JG, N4MM, W4CRW, K5UR, K6XP, K2VV, VE3GCO, DL1MD, DJ7CX, DL3RK, WB4SIJ, DL7AA, ON4QX, YU2DX, OK3EA, OK1MP, N4NO, ZL3GQ, W4BQY, I0JX, WA1JMP, K0JN, K4IE, KF2O, W8CNL, W1JR, F9RM, W5UR, CT1FL, W8RSW, WA4QMQ, W8ILC, VE7DP, K9BG, W1BWS, G4BUE, N3ED, LU3YZ/W4, NN4Q, KA3A, VE7WJ, VE7IG, N2AC, W9NUF, N4NX, SM0DJZ, DK5AD, WD9IC, W3ARK, LA7JO.

**Award of Excellence Holders with 160 meter endorsement:** K6JG, W4CRW, K5UR, OK1MP, W8CNL, W1JR, W5UR, W8RSW, W8ILC, W1BWS, G4BUE, LU3YL/W4, VE7WJ, W9NUF, N4NX, SM0DJZ, DK5AD, W3ARK, LA7JO.

Complete rules and application forms may be obtained by sending a business-size, self-addressed, stamped envelope (foreign stations send extra postage if air-mail desired) to CQ WPX Awards, P.O. Box 1351, Torrance, CA 90505-0351 U.S.A.

Actually, there was nothing that we could think of off-hand that he was doing wrong. Everything he had done to this point seemed to be straightforward and right. Everything was in accord with almost every DX book ever written. We had to explain that DX stations tend to respond to the strongest signal heard.

"Of course they can hear you easily when you are out in the clear," we counseled, "but when there is a pile-up, it is natural that they'll respond to the signal that stands above the tumult and shouting. They work the signals they can read easily. And, unless you have an extremely exotic callsign that the station under the pile-up might need, they simply just

work the loudest and most legible. You will even find that if the exotic DX callsign is not loud, it will be lost in a pile-up." We paused to let all of this sink in. Then we added, "Maybe you'd better try thinking about a linear."

This time the Local had moved before we did. "I've been looking at some," he was quick to advise us, "and from what I've been able to find, they all seem to be about the same. But I was talking with a fellow downstate a couple of weeks ago, and he told me that he had a friend nearby who had something called a 4K that had never been used off 20 meters and that this friend might let it go at a good price. He also said that if I would give him a call on the landline, he would tell me how to get one of those 5K rigs that the advertisements say are not intended for U.S. amateurs. What do you think?"

Son of a gun! We hardly knew what to think. Over the years we have looked at a lot of stations of DXers, but we could not recall ever seeing one of those rigs on line in those shacks. There were instances we remembered when we had wondered about the oversized cable that snaked out of the shack and into the garage, but when we asked one time, we were assured that it was but for the air-conditioning unit, this being one which drew a lot of amps. "Of course you know," we cautioned, "that those rigs are illegal for the W/Ks to run. Maybe yes in some other countries, but not the U.S." That might have been the right explanation.

## The WAZ Program

### 15 Meter Phone

221	DK5AD	222	JM1GAW
-----	-------	-----	--------

### 20 Meter Phone

537	KE4YD	539	K8DFC
538	KD9CN	540	JA4NNG

### 40 Meter Phone

31	JH1XYR	32	A-71AD
----	--------	----	--------

### 80 Meter Phone

31	EA8XS
----	-------

### 20 Meter CW

230	VK1DH
-----	-------

### All Band WAZ S.S.B.

2962	NE8Q	2964	KM9Y
2963	EA1AWW	2965	CT1BWY

### C.W. and Phone

5887	F6HKD	5891	W8ZNH
5888	DL2DN	5892	LATIE
5889	ZS1PS	5893	OE6WK
5890	KM9Y	5894	G4CJY

Applications and reprints of the latest rules may be obtained by sending a self-addressed stamped envelope (37 cents) size 4 1/2 x 9 1/2 to the WAZ Manager, Leo Haijzman, W4KA, 1044 S.E. 43 Street, Cape Coral, Florida 33904. Applicants forwarding QSL cards either direct to the WAZ manager or to a check point should include sufficient postage for safe return of their QSL cards. The processing fee for all C.Q. awards is \$4.00 for subscribers and \$10 for non-subscribers. In order to qualify for the subscriber rate, please enclose your latest CQ mailing label with your application.

## Amateur Radio LICENSE PREPARATION Study Guides

Get the RIGHT study material!

Manuals have all FCC Amateur Radio Operator multiple-choice questions, answers, distractors (wrong answers) and discussion as to why answer is right!

FCC - NOVICE STUDY GUIDE.....\$2.95 (Element 2)  
 FCC - TECH./GENERAL STUDY GUIDE..\$5.00 (Element 3)  
 FCC - ADVANCED STUDY GUIDE.....\$5.00 (Element 4A)  
 FCC - EXTRA CLASS STUDY GUIDE...\$5.00 (Element 4B)  
 THE FCC RULE BOOK.....\$3.00 (Use in conjunction with Study Guide)

Add \$1.50 each manual for first class postage. Same day shipment!

W5YI - VEC  
 P.O. Box #10101-C, Dallas, TX 75207

CIRCLE 65 ON READER SERVICE CARD

## ALL BAND TRAP "SLOPER" ANTENNAS!



FULL COVERAGE! ALL BANDS! AUTOMATIC SELECTION with PROVEN weatherproof sealed traps - 18 Ga Copperweld Wire! GROUND MOUNT SLOPERS - No Radials needed! Ground to rod or house water faucet! Connect Top to Trees, Buildings, Poles, etc at ANY angle from Straightup to 60 degrees for excellent "SLOPER" DX Antenna Gain or bend it anywhere you need to! 2000 Watt PEP Input, max. Permanent or portable Use installs in 10 minutes. SMALL - NEAT - ALMOST INVISIBLE - No one will know you have a Hi-Power DX Antenna. Ideal For COND'Os APARTMENTS - RESTRICTED AREAS - Pre-tuned for 2-1 or less SWR over ALL bands (except 80-160-300kc) No adjustments needed - EVER. COMPLETELY ASSEMBLED, with 50 ft RG-58U Coax feedline and PL259 connector - Built in lightning arrester - ready to hookup! FULL INSTRUCTIONS!

No. 1080S - 80-40-20-15-10 - 1 trap	49 ft. - \$49.95
No. 1040S - 40-20-15-10 - 1 trap	26 ft. - \$48.95
No. 1020S - 20-15-10 - 1 trap	13 ft. - \$47.95
No. 1016S - 160-80-40-20-15-10 - 2 traps	83 ft. - \$79.95

SEND FULL PRICE FOR PPDEL IN USA (Canada is \$5.00 extra for postage etc) or order using VISA, MASCARD - AMER EXP. Give Number Ex Date. Ph 1-308-236-5333 weekdays. We ship in 2-3 days (Per Cks 14 days) Guaranteed 1 yr - 10 day money back trial.

WESTERN ELECTRONICS  
 Dept. AC-10 Kearney, Nebraska 68847

CIRCLE 143 ON READER SERVICE CARD

## 40m Phased Array —the Easy Way!

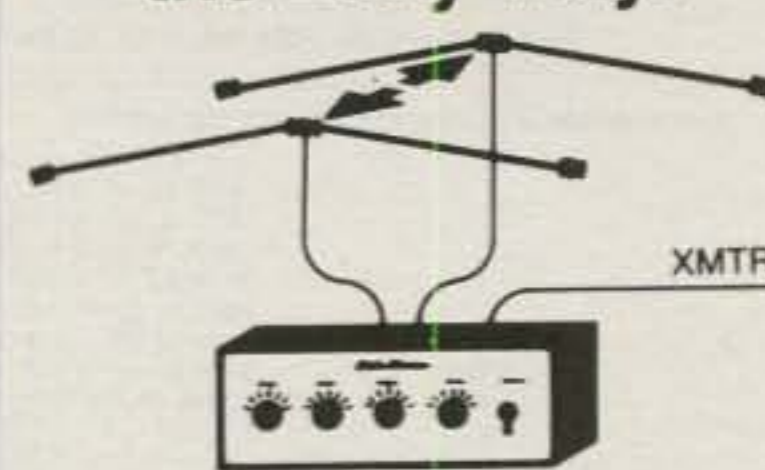

### OPTI-PHASOR™ by BaileyTech

- Change direction instantly
- High F/B, adjustable phasing
- Low SWR over entire 40m band
- Just 2 dipoles gives 4 db gain

\$119.95 Also available with matched dipoles and feed lines.

Check, MO, VISA, M/C  
 Call or Write for Complete Catalog.  
 TET Antennas, Larsen, Hy-Gain,  
 Alpha Delta, etc.

## SULTRONICS

1587 U.S. 68 N Xenia, OH 45385  
 (513) 376-2700

CIRCLE 160 ON READER SERVICE CARD

## USED GEAR BONANZA!

<b>AUTEX</b> QF-1A Filter \$49 <b>AZDEN</b> PCS-2000 \$139 PCS-4000 \$229 <b>BEARCAT</b> 210 \$159 <b>COLLINS</b> 7553 32SI 516F2 \$749 30LI \$550 <b>DENTRON</b> WP-2A SWR PEP \$59 DTR-1200L Amp \$359 <b>DRAKE</b> TR4 w/PS \$319 TR3 w/PS \$279 R4C \$229 T4XB AC4 \$199 R4B \$199 T4X R4B AC4 \$399 W-4 Wattmeter \$59	<b>HAL</b> ST6 \$129 DS3000 \$199 <b>HAMMARLUND</b> HQ110C \$99 HQ140X \$125 <b>HEATH</b> SB102 w/PS Spkr \$249 HW101 \$179 SB610 \$99 DX60B w/vfo SOLD HW8 w/ps \$195 HW8 \$175 SB401 \$105 HA201 2M HT Amp SOLD <b>HEIL</b> EQ300 \$40 <b>HENRY</b> 6M AMP C100C10 \$125 <b>ICOM</b> IC730 \$449 IC701 w/ps \$469 IC402 \$209 IC551 w/VX+PBT	PS15 \$115 IC25A \$89 IC701 p/s \$99 IC27H \$299 IC230 \$109 IC25A 2M FM \$179 IC2AT \$149 <b>KANTRONICS</b> Interface \$75 AMTOR/64 \$45 <b>KENWOOD</b> TS9305 w/at fil \$1325 TS1805 w/dfc fil \$519 TS511 w/cw \$299 R600 S/W Rcvr \$219 SP930 \$65 VFO-230 \$229 VFO-820 \$109 VFO-590 \$109 TY506 xvtr \$169 TR9130 \$379 TR7730 \$189 TR7625 \$169 TR7400 w/TT \$185	TR7400 \$169 TR7800 \$199 RM76 \$29 TR2400 H/T \$99 ST-1 H/T Base \$49 <b>MFJ</b> 1224 w/hamsoft \$89 Keyer + Key \$79 <b>PANASONIC</b> RF3100 SW Rcv \$139 <b>REGENCY</b> HR212 2M \$69 DX-200 S/W \$139 <b>ROBOT 800</b> \$369 <b>SHURE</b> 444 Mic \$29 <b>SWAN/CUBIC</b> 700CX p/s spkr \$389 1900X amp \$199 100MX w/PU5 \$350 350 W/AC-DC \$289 ST-1 Tuner \$123 WM3000 SWR PEP \$69	<b>TEMPO</b> Tempo One w/ps \$275 Tempo One VFO \$109 <b>TEN-TEC</b> Corsair \$895 Argonat 509 w/amp \$325 Triton 4 \$329 Century 21 \$209 280 w/ps \$99 <b>WILSON</b> WE800 2M FM \$129 H/T Base Chg \$15 <b>VOCOM</b> 2C-025-200 amp \$59 <b>YAESU</b> FT980 CAT \$999 FT107MDMS W/PS \$589 FY101B \$169 FT707 w/mic \$649 FY707DM Memory \$649 FT620B \$269 FT480R \$379 FY301 VFO \$109	YC601B Digital \$149 FRG7700 SW \$329 FRA7700 \$79 FRY7700 \$39 FRG7 s/w \$169 FT227R \$169 CPU2500 w/TT \$179 FT720R w/TT \$229 Y5200 w/meter \$39 NC3 H/T Chg \$39 NC7 H/T Chg \$39 NC8 H/T Chg \$49
---	---	---	--	---	---

**Late Arrivals:**  
**YAESU**  
 907R Hand held \$99  
**KENWOOD**  
 530 SP Mint! \$589  
 530S w/cw Filters \$549  
**HEATH**  
 HL2200 2 kw amp Mint! \$649

- |           |              |                 |             |              |              |              |
|-----------|--------------|-----------------|-------------|--------------|--------------|--------------|
| ■ KENWOOD | ■ SANTEC     | ■ TELEX HY-GAIN | ■ AMERITRON | ■ AVANTI     | ■ HEIL       | ■ CONNECTORS |
| ■ ICOM    | ■ KDK        | ■ HUSTLER       | ■ WELZ      | ■ CALLBOOK   | ■ MFJ        | ■ BENCHER    |
| ■ MIRAGE  | ■ AZDEN      | ■ KLM           | ■ LARSEN    | ■ ARRL BOOKS | ■ KANTRONICS |              |
| ■ AEA     | ■ NYE VIKING | ■ ROHN          | ■ BUTTERNUT | ■ CABLE      |              |              |

VISA/MASTER CARD FREE SHIPPING ON MOST RIGS FOR CASH! S.A.S.E. FOR OUR "BENCH-TESTED" USED EQUIPMENT LISTING MON-FRI 9 AM - 6 PM CENTRAL TIME SATURDAY 9 AM - 5 PM

4124 West Broadway, Robbinsdale, MN 55422 (Mpls./St. Paul)

CIRCLE 125 ON READER SERVICE CARD

**WOW!** AT LAST!! A VERY AFFORDABLE COMPUTER AT A VERY AFFORDABLE PRICE

POWERFUL FULLY PROGRAMMABLE WITH 2K OF MEMORY—PORTABLE—8.75" x 1.35" INCH MODULE SINGLE-KEY ENTRY COMMANDS—DURABLE 40 KEY MEMBRANE TYPE KEYBOARD—Z80A BASED FOUR CHIP DESIGN—EDUCATIONAL—UNIQUE SYNTAX-CHECK REPORT CODES FOR ERROR IDENTITY—GRAPH DRAWING AND ANIMATED DISPLAY—ACCURATE TO 9-1/2 DECIMAL PLACES FOR FULL RANGE MATH AND SCIENTIFIC FUNCTIONS—AT AN AFFORDABLE PRICE

WE CANNOT TELL YOU THE MAKE OF THE COMPUTER BUT IT WAS MADE BY A FAMOUS WATCH COMPANY. THEY USED TO SELL FOR \$99.95

WE BOUGHT OUT WHAT THE FACTORY HAD LEFT IN STOCK AND HAD TO REMOVE THE LABELS. THESE UNITS ARE UNPACKAGED. LESS THE 9V WALL ADAPTER AND MANUAL. BECAUSE THIS IS A DISCONTINUED ITEM THERE IS NO WARRANTY.

GET THEM WHILE THEY LAST LIMITED SUPPLY

BUY 1st UNIT FOR \$19.95	BUY 2nd FOR \$16.95	9V DC WALL ADAPTOR	\$4.95
BUY THE 3rd UNIT (NON OPERATING) FOR PARTS	\$10.95	MANUAL (OVER 100 PAGES)	\$2.95

See September 1984 issue of 73 for TIMEX/RTTY article

<b>CHIP BONANZA (AT THESE PRICES THEY ARE A STEAL)</b>		16K RAM MODULES	NEW \$29.95
2708	\$1.00 EA OR 10 FOR \$9.00	GAME CASSETTES & CORDS AVAIL	CALL OR WRITE
2716	\$2.25 EA OR 10 FOR \$20.00		
2732	\$3.25 EA OR 10 FOR \$30.00		
2764	\$4.00 EA OR 10 FOR \$35.00		
27128	\$7.00 EA OR 10 FOR \$60.00		
8502	\$4.95 EA OR 10 FOR \$48.00		
8810	(REG. \$3.95) \$1.95 EA OR 10 FOR \$18.00		
88A09	(REG. \$19.95) \$5.95 EA OR 10 FOR \$50.00		
88A21	(REG. \$9.95) \$2.95 EA OR 10 FOR \$25.00		
4116 or equivalent	8 for \$5.99		
4164	9 for \$12.95		
TMS 9900NL MICRO-P 84 PIN 8 BIT D/B + 16 BIT CPU	\$ 4.95		
TMS 9901NL MICRO-P PSI	\$ 2.95		
TIM 9904NL MICRO-P CLOCK GEN. AND DRIVER	\$ 3.95		
TMS 9918ANL MICRO-P COLOR GRAPHICS AND DISPLAY	\$ 9.95		
KEYBOARD (99/4) 48 KEYS MEASURE 4 x 10 (HI-TEK)	\$ 9.95		

APPLE II and APPLE II+ COMPUTER MAINFRAMES (fully populated) \$150  
 Power supply, case and keyboard; separately available Call or Write  
 Unit as described above, fully assembled & tested \$350 plus shipping  
 APPLE POWER SUPPLIES \$29.95

(HOT ITEM!) IF YOU'RE TRYING TO BUILD THE CABLE DECODER AS FEATURED IN THE FEB. ISSUE OF RADIO ELECTRONICS, WE HAVE THE HARD TO GET COILS AND MOST OF THE PARTS.  
 FSK DEMODULATOR/TONE DECODER XR-2211 (SPECIAL) \$2.95 LIMITED QUANTITY—5 PER CUSTOMER

SHIPPING INFORMATION: ORDERS OVER \$25 WILL BE SHIPPED POST-PAID EXCEPT ON ITEMS WHERE ADDITIONAL CHARGES ARE REQUESTED ON ORDERS LESS THAN \$25. PLEASE INCLUDE ADDITIONAL \$2.50 FOR HANDLING AND MAILING CHARGES. MICHIGAN RESIDENTS ADD 4% SALES TAX. SEND 20¢ STAMP OR SASE FOR FREE FLYER. CANADIAN ORDERS ADD \$5.00 POSTAGE IN U.S. FUNDS.

**HAL-TRONIX, INC.**  
 P.O. BOX 1101 · DEPT. N  
 SOUTHGATE, MICH. 48195  
 PHONE (313) 285-1782

"HAL" HAROLD C. NOWLAND W8ZXH

CIRCLE 91 ON READER SERVICE CARD

## AMATEUR TELEVISION

### KPA5 1 WATT 70 CM ATV TRANSMITTER BOARD

- **APPLICATIONS:** Cordless portable TV camera for races & other public service events, remote VCR, etc. Remote control of R/C airplanes or robots. Show home video tapes, computer programs, repeat SSTV to local ATVers. DX depends on antennas and terrain typ. 1 to 40 miles.
- **FULL COLOR VIDEO & SOUND** on one small 3.25x4" board.
- **RUNS ON EXTERNAL 13.8 VDC** at 300 ma supply or battery
- **TUNED WITH ONE CRYSTAL** on 426.25, 434.0, or 439.25 mHz.
- **2 AUDIO INPUTS** for a low Z dynamic and line level audio input found in most portable color cameras, VCRs, or home computers.
- **APPLICATION NOTES & schematic** supplied for typical external connections, packaging, and system operation
- **PRICE ONLY \$159** delivered via UPS surface in the USA Technician class amateur license or higher required for purchase and operation.

**WHAT IS REQUIRED FOR A COMPLETE OPERATING SYSTEM?** A TV set with a TVC-2 or TVC-4 420-450 mHz to channel 3 downconverter, 70 cm antenna, and coax cable to receive. Package up the KPA5, add 12 to 14 vdc, antenna, and any TV camera, VCR, or computer with a composite video output. Simple, eh?

**CALL OR WRITE FOR OUR COMPLETE CATALOG & more info** on atv downconverters, antennas, cameras, etc., or who is on in your area.

TERMS: Visa, Mastercard, or cash only UPS COD by telephone or mail Telephone orders & postal MO usually shipped within 2 days, all other checks must clear before shipment. Transmitting equipment sold only to licensed amateurs verified in 1984 Callbook. Calif. include sales tax

CIRCLE 118 ON READER SERVICE CARD  
 (818) 447-4565 m-f 8am-6pm pst.

**P.C. ELECTRONICS**  
 Tom W6ORG Maryann WB6YSS

2522 Paxson Lane  
 Arcadia CA 91006

CIRCLE 168 ON READER SERVICE CARD

tion, but it was not one the Local understood.

"Hold it!" he said, and he started with more questions. We finally had to tell him that that was another story, one for which we would not have enough time that day to even start exploring. For a half-century there have been those who have tried to understand, but as yet are not sure just what happened. They know, but they don't know. We had no intention of getting into that pot.

"Well," the Local finally asked, "what do you think I should do?" and we gave him the best advice that any DXer could get. "Look over all of them," we said, and we did not see the Local for another couple of months. But he finally did return. We had thought that the whole spectrum of DXing had been covered save, possibly, for list operations and DX Nets. We were sure that by now the Local would be winging it in DX circles. What we thought was not what we got.

When we saw him again we could not mistake the sad overtone in his voice. We thought possibly he had missed Bouvet, but we had not heard of that being on . . . yet.

"Look," the Local said, and there was hurt in his voice. "Since I first started talking to you months back I've done everything you suggested, but I'm still not working DX. What's wrong?"

"Such as?" we countered, and the Local was into his routine. "I try working the bands when I get home from work," he said. "Everything is dead. Where did I ever get the idea that 20 would be open all night long? The noise is terrible and the conditions are bad. And all I am hearing are the W4s and W5s. This is not what I expected DX to be, or what I was told!"

We had to think this over, and the thought finally started getting through to us that perhaps this one had never heard about the sunspot cycle. So we had to explain all of this—how the sunspots go up and the sunspots go down. And so does DX. When they are up, the DX is unbelievable. When they are down . . . well, most DXers would rather forget those years. But we had to explain that when the sunspots are down, DX is terrible and sometimes even worse than that.

We were relieved to see that the Local did not immediately panic. "Okay," he finally said, "maybe I won't work the Indian Ocean for a year or so, but I'll work all the short-skip, and when the next cycle is here, I'll be ready and primed. I'll know all about DXing. That should work, shouldn't it?"

Of course it should. When one is patient, it is easy to learn the lesson that all things come to him who waits—long enough. And if one upgrades the station when the cycle is down, DX will come like iron filings to a magnet when the cycle is up. All you have to do is wait . . . and wait.

And that was the way things went. But finally the Local got around to specifics.

## 5 Band WAZ Standings as of July 1, 1985

### All 200 zones worked:

1. ON4UN	35. ON5NT	69. DL4YAH
2. K4MQG	36. OH6JW	70. LA7ZO
3. SM4CAN	37. OK1AWZ	71. W9ZR
4. AA6AA	38. IV3PRK	72. W1NG
5. W8AH	39. DJ6RX	73. VK9NS
6. W6KUT	40. OH3YI	74. N4KG
7. EA8AK	41. I4RYC	75. YU7DX
8. LA7JO	42. ZL1BIL	76. DL8MAG
9. EA3SF	43. I4EAT	77. OK3DG
10. OH1XX	44. ZL1BQD	78. ZL1BOQ
11. EA8OZ	45. TG9NX	79. EA9IE
12. W0SD	46. XE1J	80. DL7HZ
13. K0ZZ	47. F5VU	81. DJ9RQ
14. ON6OS	48. W3AP	82. EA5SP
15. OK3TCA	49. YO3AC	83. EA2IA
16. K6SSS	50. K3TW	84. SP3BQD
17. ZL3GQ	51. XE1OX	85. LZ1NG
18. OK3CGP	52. VE7IG	86. N4JF
19. SM0AJU	53. OK1ADM	87. CT2AK
20. OZ3PZ	54. CT1FL	88. HB9CIP
21. I3MAU	55. WA1AER	89. OK1MG
22. I2ZGC	56. N4RR	90. CT4BD
23. 4Z4DX	57. UW0MF	91. VK6HD
24. N4KE	58. W4DR	92. EA6ET
25. K5UR	59. OK1MP	93. VK3QI
26. K9AJ	60. W1NW	94. LZ2DF
27. SM3EVR	61. OE1ZJ	95. ON4QX
28. LA5YJ	62. HB9AHL	96. SM0DJC
29. DL3RK	63. HB9AMO	97. CT3BM
30. N4WJ	64. LA6OT	98. K2TQC
31. G3MCS	65. UR2QD	99. EA8XS
32. SM5AQD	66. UK2RDX	100. HA9RE
33. W0MLY	67. ZS5LB	101. SM4CTT
34. I0RIZ	68. F6DZU	

### The top 12 contenders for 5 Band WAZ are:

1. DK5AD, 199	7. LA9GV, 198
2. JA3EMU, 199	8. W6GO, 198
3. N4WW, 199	9. W4CEB, 198
4. A71AD, 199	10. W2YY, 198
5. K6YRA, 199	11. SM5AKT, 198
6. W8UVZ, 199	12. G3GIQ, 198

### 327 Stations have attained the 150 zone level

"This sunspot cycle. When did you say we would reach the bottom?"

We hadn't and did not want to, but there was no dodging. "Some are saying that we will bottom about June 1987. Others say that it won't be until March 1988. But it's coming. It always has."

After awhile the Local shrugged. "Now I can better understand why it takes so long to get on the Honor Roll," he said. "You can't work DX all the time because DX is not here all the time, right?"

He was satisfied when we acknowledged that he was understanding. But we were happy he had not gotten into the area of discussion about some DX countries that have not been heard for a quarter century or so. Right then we did not want him to get discouraged. He would learn that after a cycle or two, the big total DXers are the DXers that hang in there, if you start young enough. But persevere. Even if it isn't the top of the cycle,

there will always be some DX available. Sometimes more than others.

## Sri Lanka

Vincent Paul Perera, 4S7PVR, writes from downtown Mount Lavinia that there are accommodations available, and during the last year a number of visiting DXers have passed through the area. These have included ON5OS, SM2EJE, DL7NH, and WB4ATV. Paul even notes that Wayne Warden, W9GW, has a license sitting at the bureau should he be able to double-back to 4S7-land.

At the local overnight stop, maybe a bit longer at times, six received call signs while in Sri Lanka. Some months back there were some political problems in the northern tip of the island, but Paul notes that that was a somewhat local problem and little affected the southern part around Colombo.

Should you be looking for late information on operating from 4S7-land, drop a line to 4S7PVR at 84 Templars Road, Mount Lavinia, Sri Lanka, and he will be able to advise on accommodations, licenses, and most anything else you need.

## U.N. 40th Anniversary

The 4U1UN at United Nations Headquarters in New York is offering an award for working two of the U.N. amateur radio stations during the 40th anniversary year of the signing of the U.N. charter in San Francisco in 1945. The stations to look for are 4U1UN at the New York headquarters, 4U1ITU at the ITU headquarters in Geneva, and 4U1VIC at the Vienna International Center in Austria. The date of the signing was 24 October 1945. Any contact during the calendar year 1985 counts for the award.

Send list of stations worked including date, time, mode, report, and band to: U.N. Staff Recreation Council, Amateur Radio Club, Room DC1-0724, Box 20, New York, NY 10017. They ask for \$5.00 or 15 IRCs, this

## CQ DX Awards Program

### S.S.B.

1425	KM9Y	1427	TF5EP
1426	G4XZX	1428	TF5BW

### C.W.

642	KM9Y
-----	------

### S.S.B. Endorsements

310	DL9OH/316	300	SM4CTT/307
310	K6YRA/315	300	WA4WTG/306
310	N4JF/316	275	XE1OX/299
310	XE1AE/315	275	XE1OW/292
310	N2SS/312	250	KM9Y/258
300	9H4G/309	3.5/7 MHz	9H4G

### C.W. Endorsements

310	K4CEB/316	200	KM9Y/245
310	N4PN/315		

Total number of active countries is 315. The basic award fee for subscribers to CQ is \$4. For non-subscribers, it is \$10. In order to qualify for the reduced subscriber rate, please enclose your latest CQ mailing label with your application. Endorsement stickers are \$1.00. Updates not involving the issuance of a sticker are made free when an s.a.s.e. is enclosed for confirmation of total. Rules and application forms for the CQ DX Awards Program may be obtained by sending a business size, No. 10 envelope, self-addressed and stamped, to CQ DX Awards Manager, Billy Williams, N4UF, Box 9673, Jacksonville, FL 32208 U.S.A. DX stations must include extra postage for air-mail reply. Please make all checks payable to the awards manager.

# RF TRANSISTORS

FRESH STOCK - NOT SURPLUS  
TESTED — FULLY GUARANTEED

P/N	2-30 MHz 12V (* = 28V)		Match Pr.
	Rating	Each	
MRF406	20W	\$14.50	\$32.00
MRF412,IA	80W	18.00	45.00
MRF421	100W	25.00	58.00
MRF421C	110W	—	60.00
MRF422*	150W	38.00	82.00
MRF426,IA*	25W	18.00	42.00
MRF428**	150W	55.00	125.00
MRF433	12.5W	12.00	30.00
MRF435*	150W	42.00	90.00
MRF449,IA	30W	12.50	30.00
MRF450,IA	50W	14.00	31.00
MRF453,IA	60W	15.00	35.00
MRF454,IA	80W	16.00	36.00
MRF455,IA	60W	12.00	28.00
MRF458	80W	20.00	46.00
MRF460	60W	18.00	42.00
MRF464*	80W	25.00	60.00
MRF466*	40W	18.75	48.00
MRF475	12W	3.00	9.00
MRF476	3W	2.75	8.00
MRF477	40W	11.00	25.00
MRF479	15W	10.00	23.00
MRF485*	15W	6.00	15.00
MRF492	90W	18.00	40.00
SRF2072	75W	15.00	33.00
SRF3662	110W	28.00	60.00
SRF3775	75W	15.50	34.00
SRF3795	85W	16.50	37.00
CD2545	50W	23.00	52.00
SD1076	70W	17.00	40.00
SD1451	50W	15.00	36.00

Selected High Gain Matched Quads Available

P/N	VHF/UHF TRANSISTORS		Net Ea.	Match Pr.
	Rating	MHz		
MRF212	10W	136-174	\$16.00	—
MRF221	15W	136-174	10.00	—
MRF222	25W	136-174	14.00	—
MRF224	40W	136-174	13.50	32.00
MRF231	3.5W	66-88	10.00	—
MRF234	25W	66-88	15.00	39.00
MRF237	4W	136-174	3.00	—
MRF238	30W	136-174	12.00	—
MRF239	30W	136-174	15.00	—
MRF240	40W	136-174	18.00	—
MRF245	80W	136-174	28.00	65.00
MRF247	75W	136-174	27.00	63.00
MRF250	50W	27-174	20.00	46.00
MRF260	5W	136-174	7.00	—
MRF261	10W	136-174	9.00	—
MRF262	15W	136-174	9.00	—
MRF264	30W	136-174	13.00	—
MRF607	1.75W	136-174	3.00	—
MRF641	15W	407-512	22.00	—
MRF644	25W	407-512	24.00	54.00
MRF646	40W	407-512	26.50	59.00
MRF648	60W	407-512	33.00	69.00
2N3866*	1W	30-200	1.25	—
2N4427	1W	136-174	1.25	—
2N5591	25W	136-174	13.50	34.00
2N5642*	20W	30-200	13.75	34.50
2N5945	4W	407-512	10.00	—
2N5946	10W	407-512	12.00	—
2N6080	4W	136-174	6.25	—
2N6081	15W	136-174	7.50	—
2N6082	25W	136-174	8.90	—
2N6083	30W	136-174	9.30	24.00
2N6084	40W	136-174	11.75	28.50

P/N	TMOS FET		Each	Match Pr.
	Rating	Frequency		
MRF134*	5W	2-200	\$10.50	—
MRF137*	30W	2-200	22.50	—
MRF138**	30W	1.5-150	35.00	—
MRF150**	150W	1.5-150	80.00	—
MRF172*	80	2-200	65.00	—

Selected, matched finals for Kenwood, Yaesu, Icom, Atlas, etc. Technical assistance and cross-reference information on CD, PT, RF, SRF, SD P/Ns.

**QUANTITY DISCOUNTS AVAILABLE**  
**WE SHIP SAME DAY C.O.D./VISA/MC**  
INFORMATION AND CALIF. ORDERS: (619) 744-0728  
OUTSIDE CALIF. ORDER DESK: 800-854-1927



## RF PARTS

1320-16 Grand Ave., San Marcos  
California 92069 (619) 744-0728

mainly going to the United Nations Childrens Fund.

In Vienna 4U1VIC is still living well on Wagramer Strasse while waiting for country status. During the year it was visited by a number of DXers. Some of the guest operations at the club station included K7ZR, W9WGQ, K6AYA, WD9GSD, and WB6DXU. W8ZFV was in Vienna on a contract for UNIDO. The 4U1VIC club is putting out a newsletter, and you can look for them in the CQ WW Test later this month. Remember, 4U1VIC may be a DXCC counter one of these days. Maybe even sooner. And while we are working that side of the street, 4U1VIC asks that Austrian stamps not be sent with QSLs. They do have to take these downtown to mail, and 7 schillings, the amount usually sent, is not sufficient for airmail service. Send two IRCs and you will get your QSL with U.N. Vienna stamps. By this time there is a good possibility that a third party traffic agreement will be signed for the U.N. outpost.

Also, in the case of guest operators, do not QSL to their home QTH unless that is specifically requested. The name or handle of the operator on the QSL will facilitate handling.



Recently named Honorary President of SARL, the Finnish Amateur Radio League, Armas Valste, OH2NB, has long been a top OH-DX type. Armas served as president of SRAL back in the sixties, combining this with a long service in amateur athletics. Over the years he put in a long term as Head Coach of the Finnish track and field organization and also served as General Manager. In his youth he held a number of championships in the high jump and shotput. Armas has also signed CT1BCM in recent years.

### Armas Valste, OH2NB

The 80th birthday of Armas Valste was also the day he received his 5BDXCC award. Should you wonder why it took such a top DXer so long, it really did not. Armas worked this one from CT1BCM in Portugal.

Long a member of the DXCC Honor Roll, Armas was elected Honorary President of the Finnish Radio Society earlier this year, this continuing a record of amateur services. Back in 1968 he was the President of SRAL.

Amateur radio is not the only field in which OH2NB has excelled. In his youth he participated in track and field events, winning six Finnish championships in the shotput and four in the high jump. In those days he often competed against Urho Kekkonen, who later was president of the Republic of Finland. In 1936 Armas became head coach of the Finnish

Sport Federation, and was its general manager from 1963 to 1968.

Currently living in Albufeira in southern Portugal, at least during the winters, Armas continues to be active on the air and is usually found operating CW, a mode he has long championed.

### Forty Meters

In response to a petition from Puerto Rico's amateurs, the FCC some months back issued a Notice of Proposed Rule Making to allow phone in the 40 meter band down to 7075 kHz by amateurs outside the continental U.S., or the lower 48, as sometimes noted.

This came following the action of the FCC in 1984 to allow such operations to General and higher class licensees in the Pacific, including Hawaii and Alaska. In their petition the Puerto Rican amateurs point out that Puerto Rico and the U.S. Virgin Islands were the only noncontinental U.S. areas not allowed this privilege.

Comments on this matter were due about mid-year, and possibly by this time something will be surfacing on this matter.

Working the same area, it might be noted that recently the FCC eliminated the need for third class radiotelephone licenses for maritime or aviation VHF in U.S. territory. The FCC noted that such licenses were issued to anyone who applied, and were relatively meaningless. Licenses in such operations will still be required for the medium- or high-frequency bands. They will also be needed when outside the U.S.

### Montserrat

Ed Radio, AJ6V, will be in Montserrat for the CQ WW CW Test next month. Ed will be operating in the single-operator, all-band category. In 1983 Ed also operated from Montserrat and was twelfth world overall in the DX test. He will be signing VP2MEV again. Only the 1985 or later Callbook has his correct address.

### Thailand

John Knight, W6YY, passes along the information that though the Thailand Minister of Communications lifted the ban on amateur communications early this year, the Thai Posts, Telegraph and Telephones Department made their own decision to withhold any operating authority pending examination of all would-be amateurs.

In the past all licenses in Thailand have been informally issued by the Radio Amateur Society of Thailand (RAST). One of the problems with implementing all of the above is that some RAST members are worried if new calls will be assigned and their old call signs lost. The examinations for HS licenses were expected to have taken place during this summer, and HS stations will be showing under the new license procedures early this fall.

### Saint Martin/FS7

The St. Martin Radio Club wants to again bring to the attention of those planning a visit to any of the French Antilles that the power limitation is 100 watts. If you are planning a trip to FM/FG/FS with some possible amateur operation, figure to leave your linear at home. The problem is not helped when some have difficulty in getting a copy of the local PTT regulations. Also, some French-licensed DX stations express concern when checking contest results, as the 100 watts from the French Antilles often shows in the scores.



WE SHIP WORLDWIDE

# Barry Electronics Corp.

WORLD WIDE AMATEUR RADIO SINCE 1950

Your one source for all Radio Equipment!

For the best buys in town call:

212-925-7000

Los Precios Mas Bajos en Nueva York...



Come to Barry's for Fall Festival Savings

Jan KB2RV, Kitty WA2BAP, Mark K2CON

KITTY SAYS: WE ARE NOW OPEN 7 DAYS A WEEK. Saturday & Sunday 10 to 5 P.M.

Monday-Friday 9 to 6:30 PM Thurs. to 8 PM Come to Barry's for the best buys in town.



ONV Safety belts-in stock

ICOM IC-R71A, IC-751, IC745, IC-27A/H, IC-37A, IC-47A, IC-1271A, IC-271A/H, IC-3200A, IC-471 A/H, IC-735



ICOM

## KENWOOD



R-600, R-1000, R-2000, TS-940 S/AT TS 430S, TR-3600A, TR 7950, TW-4000A. Kenwood Service/Repair. TH21/31/41AT, TM-211A/ 411A & TS-711A/811A

Antennas A-S Cushcraft Hustler KLM METZ Mini-Products Mosley

FT-ONE, FT-980, FT-757GX, FRG-8800 FT-726R, FRG-9600, FT-270RH, FT-2700RH

YAESU ICOM Land-Mobile H/T Midland/Standard Wilson Maxon Yaesu FTC-2203, FT-4703 Icom IC-M12 (Marine) M700 Tempo M-1



SMART PATCH

CES-Simplex Autopatch 510-SA Will Patch FM Transceiver To Your Telephone Great For Telephone Calls From Mobile To Base Simple To Use - \$319.95

CELLULAR 'PHONES STOCKED

WELZ

FLUKE 77 Multimeter



Nye MBV-A 3 Kilowatt Tuner

COMPU-FIRE EXTINGUISHERS EXL-5000E RTTY/AMTOR TERMINAL



NCG 7-21-50 Transceiver

VoCom/Mirage/Daiwa Tokyo Hy-Power Amplifiers & 5/8λ HT Gain Antennas IN STOCK Large inventory of Saxton Wire & Cable

AMERITRON AMPLIFIER AUTHORIZED DEALER



Yaesu FTR-2410, Wilson ICOM IC-RP 3010 (440 MHz) ICOM IC-RP 1210 (1.2 GHz)



Soldering Station,

48 Watts, \$68

Computer Interfaces stocked: MFJ-1224 AEA CP-1, PKT-1, DR.DX CP-100, PK-64, Dr. QSO, Morse University



ALPHA AMPLIFIERS

SANTEC ST-222/UP ST-142/UP ST-442/UP HT-7

MFJ Models 422, 313, 1224 & 941D

HAM MasterTapes—Beta or VHS Tapes

MURCH Model 2000 A, A-LS, B in stock

JBC soldering line in stock.

MICROLOG-AIR I, Air Disk, SWL, Morse Coach

KANTRONICS

UTU, Interface II, Challenger, Packet Comm.

EIMAC 3-500Z 572B, 6JS6C 12BY7A & 4-400A



BIRD Wattmeters & Elements In Stock

AEA 144 MHz AEA 220 MHz AEA 440 MHz ANTENNAS

Complete Butternut Antenna Inventory In Stock!

DIGITAL FREQUENCY COUNTERS

Trionyx- Pro-Com Engineering Model TR-1000 0-1 GHz 1200HH 0-600 MHz 0-1.3 GHz 1296HH

Long-range Wireless Telephone for export in stock

BENCHER PADDLES, BALUNS, AUDIO FILTERS, IN STOCK

MIRAGE AMPLIFIERS ASTRON POWER SUPPLIES Alinco/Falcon Amps

HEIL EQUIPMENT IN STOCK



Tri-Ex Towers

Hy-Gain Towers & Antennas, and Rotors will be shipped direct to you FREE of shipping cost.



New TEN-TEC 2591HT, Corsair II, Argosy II, Century 22

MAIL ALL ORDERS TO BARRY ELECTRONICS CORP., 512 BROADWAY, NEW YORK CITY, NY 10012.

New York City's LARGEST STOCKING HAM DEALER COMPLETE REPAIR LAB ON PREMISES

"Aqui Se Habla Espanol"

BARRY INTERNATIONAL TELEX 12-7670 MERCHANDISE TAKEN ON CONSIGNMENT FOR TOP PRICES

Monday-Friday 9 A.M. to 6:30 P.M. Thursday to 8 P.M. Saturday & Sunday 10 A.M. to 5 P.M. (Free Parking)

AUTHORIZED DIST. MCKAY DYMEK FOR SHORTWAVE ANTENNAS & RECEIVERS.

IRT/LEX-"Spring St. Station"

Subways: BMT-"Prince St. Station"

IND-"F" Train-Bwy. Station"

Bus: Broadway #6 to Spring St.

Path-9th St./6th Ave. Station.

Commercial Equipment Stocked: ICOM, MAXON, Midland, Standard, Wilson, Yaesu. We serve municipalities, businesses, Civil Defense, etc. Portables, mobiles, bases, repeaters...

Local Ham Club Speeches Given

We Stock: AEA, ARRL, Alpha, Ameco, Antenna Specialists, Astatic, Astron, B & K, B & W, Bash, Bencher, Bird, Butternut, CDE, CES, Collins, Communications Spec. Connectors, Covercraft, Cushcraft, Daiwa, Dentron, Digimax, Drake, ETO (Alpha), Eimac, Encomm, Heil-Sound, Henry, Hustler (Newtronics), Hy-Gain, Icom, KLM, Kantronics, Larsen, MCM (Daiwa), MFJ, J.W. Miller, Mini-Products, Mirage, Newtronics, Nye Viking, Palomar, RF Products, Radio Amateur Callbook, Robot, Rockwell Collins, Saxton, Shure, Telex, Tempo, Ten-Tec, Tokyo Hi Power, Trionyx TUBES, W2AU, Waber, Wilson, Yaesu Ham and Commercial Radios, Vocom, Vibroplex, Curtis, Tri-Ex, Wacom Duplexers, Repeater, Phelps Dodge, Fanon Intercoms, Scanners, Crystals, Radio Publications.

WE NOW STOCK COMMERCIAL COMMUNICATIONS SYSTEMS DEALER INQUIRIES INVITED. PHONE IN YOUR ORDER & BE REIMBURSED.

COMMERCIAL RADIOS stocked & serviced on premises.

Amateur Radio Courses Given On Our Premises, Call

Export Orders Shipped Immediately. TELEX 12-7670

## The WPX HONOR ROLL

The WPX Honor Roll is based on the current confirmed prefixes which are submitted by separate application in strict conformance with CQ master prefix list. Scores are based on the current prefix total regardless of an operator's all-time count. Honor Roll must be up-dated annually by addition to, or to confirm present total. If no up-date, file will be placed into "inactive" until next up-date. Lifetime Honor Roll fee \$2.00, with no fees required for up-dates.

### MIXED

2815	F9RM	1767	N2AC	1367	K8LJG	1159	G4FAM	876	VE2PD
2740	YU2DX	1754	YU1DZ	1338	SM6DHU	1126	YU4YA	858	K7CU
2484	K6JG	1699	SM7TV	1338	WA8YTM	1095	KA3A	856	DF6EX
2480	W2NC	1689	I2PHN	1335	N6JM	1070	YU2CQ	851	JH8NYK
2305	K2VV	1677	I8YRK	1330	YU7KV	1048	WD9IC	841	10AOF
2277	K6XP	1660	YU7AW	1300	N5TV	1040	N4IB	837	VE2FOU
2237	VE3GCO	1648	W8CNL	1268	IS0LYN	1012	N8BJQ	829	VE5ADA
2179	N4MM	1603	I6SF	1251	I2MQP	999	KS7T	827	PY1DFF
2126	W4BQY	1589	I3ZKO	1250	N4NX	994	YU2CBK	801	YU1OHF
2082	W9DWQ	1577	K9BG	1249	KL7AF	980	K2POF	800	KO2Q
1951	YU7BCD	1572	W0SFU	1240	N6AW	952	W6YMH	752	JH4UVU
1905	N6CW	1536	W1NG	1238	LA7JO	947	WD4RAF	745	KX1A
1905	N9AF	1501	KF2O	1226	W7CB	933	N2AIF	739	NE6I
1892	YU2TW	1491	WA1JMP	1196	YU7AJD	914	A18S	722	K8HF
1889	N6JV	1482	IN3ANE	1190	DK5AD	913	A16Z	630	W14K
1875	N4UU	1467	K6ZDL	1187	EA9IE	910	YU1SZ	611	JO1BMV
1837	K5UR	1464	EA2IA	1172	WB8ZRL	905	W0JIE	605	W9PWW
1815	PA0SNG	1396	W9NUF	1164	CT1LN	904	W3GXK	600	N3KR
1801	YU7BPO	1391	PY4OD						

### S.S.B.

2710	F9RM	1558	K5UR	1167	W1NG	1000	WB8ZRL	792	Z21GJ
2273	I0ZV	1557	PA0SNG	1147	W2NC	994	KL7AF	787	W2XQ
2082	K6JG	1556	YU7BCD	1136	ZP5RS	993	H18GB	761	WB6SRK
2029	I0AMU	1527	N4NO	1131	W2CC	954	KC8YM	755	W04L
2022	J6XP	1503	W9DWQ	1103	W3ARK	948	XE1XF	736	K3IXD
1887	ZL3NS	1472	W4BQY	1100	N5TV	948	KK0L	721	IN3AHO
1968	K2POA	1385	YU7AW	1100	G4CHP	946	I1POR	688	W6YMH
1966	K2VV	1380	N4UU	1099	N6FX	937	K8LJG	683	K9BQL
1921	N4MM	1376	N2SS	1094	KC4OV	901	PY4VX	663	KB0C
1739	CT1UA	1340	VE1YX	1081	XE1OX	895	WA2FKF	661	K8ZZO
1690	I4ZSQ	1325	WA4QMO	1080	TG9GI	868	PY4OD	655	EA8AKN
1690	OZ5EV	1310	CT4NH	1062	W9NUF	858	VE2PD	649	KK5P
1677	HB9AAA	1292	WF4V	1048	I8KCI	850	N4IB	649	IK5ACO
1658	W0YDB	1269	I6NOA	1044	AC2J	845	WA0DCQ	621	AG2K
1649	I2PHN	1249	KF2O	1033	N2AC	838	W0ULU	617	W14K
1633	I8YRK	1230	I2MQP	1029	EA2IA	810	CT1BY	610	VO1AW
1618	I0MBX	1223	PY3BXW	1028	JH1VRQ	810	I0SGF	600	W7KWI
1605	I8KDB	1197	CT1FL	1013	N4NX	801	CT4UW	600	KC2FC
1600	WD8MGO	1176	WA4OIB	1008	I1HAG				

### C.W.

2239	W2NC	1553	N4UU	1244	N4YB	999	KF2O	755	N4NX
1863	N6JV	1532	VE7CNE	1184	W4WJ	995	KA7T	748	N2AIF
1850	WA2HZR	1507	N2AC	1182	K6ZDL	990	W9NUF	723	YU2CQ
1834	K2VV	1475	N4MM	1180	PY1APS	970	IT9VDO	708	YK1AO
1809	K8KPL	1442	K5UR	1163	N6FX	963	K8LJG	700	VE2FOU
1796	K6JG	1435	ON4QX	1148	EA2IA	897	KL7AF	655	SM5DAC
1785	N4NO	1401	YU7SF	1133	JE1JKL	888	DJ1YH	645	PA3CKO
1739	W3ARK	1383	VO1AW	1133	I2DMK	874	K2POF	633	W2XQ
1680	K6XP	1355	I6SF	1123	I1YRL	827	NN4Q	616	VE1CK
1657	W9DWQ	1305	LZ1XL	1111	PY4OD	813	JH1VRQ	605	LA7JO
1650	W4BQY	1294	K9QVB	1107	JA1KRU	797	AK2H	601	F6HKD
1635	DL1QT	1286	YU3NP	1011	W1NG	771	G4FAM	600	W6YMH
1608	G2GM	1278	YU7AW	1000	N5TV	767	WD9IC	600	VE4AEX
1555	YU7BCD								

Note that the above refers to the French Antilles. It is possible that in Sint Maarten, this being across the street on the same island as St. Martin, you will encounter Dutch regulations. What to do? When in doubt, or planning a trip where you are not firm on the regulations, ask Naoki Akiyama, N1CIX, in downtown Newington. Nao has the answers to most everything on international questions. He might even tell you where to look for JAs in the CQ WW Test this month. Nao does work as the liaison with sister societies of the ARRL, among the other duties he handles. If you are traveling and plan to operate, don't leave home without Naoki's help.

### Father Moran

Many DXers had a chance to visit with Father Moran, 9N1MM, when he was touring the states last year. Frank Nagy, N8BIB, passes along the note that Father Moran always has a continuing need for books for his St. Xaviers School at Godavari, just south of Kathmandu.

There are currently 300 students at



Father Marshall Moran, 9N1MM, stands in the Library at St. Xavier's School at Godavari, a few miles outside Kathmandu. Long the best hope for DXers needing Nepal, Father Moran traveled in the states last year visiting the Deserving.

9N1MM's school, and for years the possibility of working Nepal has usually depended on Father Moran being on the air. If you are interested in disposing of surplus books, drop a line to Frank Nagy, 24315 Waltz Road, New Boston, MI 48164, and he will advise how to ship. There is a weight limit of 11 pounds per parcel in case you want to know.

### Sunspots

DXers always like to talk about things they do not have but need. These include high towers, high QTHs, and high DXCC totals. Lately they have been talking about low sunspot numbers, and the cry is often heard in the land, "When will it end?"

Soon, but not yet. The April sunspot numbers are compiled by the good A. Koeckelbergh of the Sunspot Index Data Center in Brussels showed the mean for the month as 16.1. The best day had 31 spots, and there were 14 days when the count was 10 or less. Seven days had zero sunspot counts.

We are nearing the bottom, but often the bottom is hard to tell until you are a bit beyond it. Boulder, the home of WWV, is looking for a bottom about June 1987. Our own in-house N4XX is looking for the bottom in the spring of 1988.

The present Cycle 21 started up in June 1976 and reached a peak 41 months later in December 1979. The 12-month running average at the peak was 164.5. The curve flattens when it is nearing bottom, and the current cycle appears to be flattening. When the new cycle starts, it goes up fast, DX improves, and happy DXers are capering everywhere. Right now the dying Cycle 20 seems to be feeling for bottom. There it bounces along for a year or so, perhaps even a bit more. The Great Days of DXing are coming. Be Prepared! But not just yet.

### WPX

Norm Koch, K6ZDL, long a toiler in the WPX vineyard, passes along some pertinent notes on the WPX program. Norm has been handling that chore for a number of years now, working to bring order out of confusion, and in recent years he has converted much of the WPX records to computer listings.

Norm recently noted that on the WPX Honor Roll both the CW and the SSB modes have been computerized, all the way down to those with 1000 counters. He is working on the mixed mode and will have this lined out sometime in the future.

The computer is coming up with some items that need attention—things like poor record-keeping, duplications scattered through a station's file, as well as the same prefix being claimed five or six times. As the files are put into the computer, these aberrations are being flagged and corrected.

An audit of the WPX Honor Roll some months back raised some questions, and eventually two stations (not W/Ks) were dropped from the listings for failure to comply with the rules. The audit also extended to reviews utilizing some overseas checkpoints where there was some feeling that the Honor Roll was being sandbagged.

Want to check your WPX listings? Norm will furnish you with a printout of your file for \$2.00, or 10 IRCs, plus a business-size envelope with at least 39¢ U.S. postage affixed. Write directly to K6ZDL.

### A Multitude of DX Notes

Father Dave Reddy, CE0AE, passed away

on June 7th. For a good many years Father Dave was the reliable source for an Easter Island contact. His arrival there ended a long scarcity that had existed since the USAF station on the island was disbanded. Father Dave was a member of The Order of Franciscan Minors.

There seems always to be a DXer needing VR6-Pitcairn Island. A month or so back AT&T made it a bit easier for the deserving DXer. They began serving Pitcairn with telephone service. Calls are routed to Pitcairn via New Zealand and highseas radio transmissions. It cost \$11.83 for the first three minutes and individuals in the U.S. will have to make reservations to place a call.

There is but one telephone on the island. Guess who has it? For a clue, name someone on the island whose name you know, well. Right! VR6TC, Tom Christian.

The Radio Club de Chile wants to clear up the CE0AA QSLing, and Rogelio Gomez Fernandez, CE3GF, advises that cards sent to Box 700 in Santiago were caught up a couple of months back. Some QSLs received were put aside because the card did not match up with the logs, these to be run through after the backlog was cleared in an effort to reconcile the card with a log entry. Rogelio asks that anyone with any queries write directly to the Radio Club de Chile, Box 700, Santiago, Chile, and outline the problem. Some have noted cards coming back via unexpected routes. However, if you still do not have the needed CE0AA QSL, write direct. The club wants to get all the problems straightened out.

Jim Smith, VK9NS, has been reported as mentioning that another scientific group might be on Heard around the turn into 1986. In June 5X5 cards from 5X5GK for activity after August 28, 1984. The DXCC desk was also looking with approval on 5X5BD and 5X5WR.

If Zone 2 for WAZ has been heart-break hill for you, note that VE3JKC/VE2 is on the air and will be there until 1987. He is at Harrington Harbor in the southern entrance to the Strait of Belle Island, about 50°30'N, 59°25'W, more or less. As long as we are in the Canadian circuit, VX6 was used to mark the centennial of Lethbridge in Alberta for two weeks in July. VA1 was used for the bicentennial of Sydney in Nova Scotia, also in July. The Heard Island DX Assn. has an official report of their 1983 Heard effort. It covers both the mountaineering and amateur action. Good reports from those who have read it. Ten dollars to the HIDXA, Box 90, Norfolk Island 2899, Australia will put it in your hands. A month or so back we saw a photo from this trip used in advertising for scuba gear.

Robert Shelton, N2EDF, made a 40-minute videotape, edited and suitable for presentation, while on the Navassa effort a few months back. If you would like to make a copy of the 6Y5NR/KP1 effort, write to N2EDF at 11 North Clarke Street, Ogdensburg, NJ 07439. Five dollars will cover expenses. Write if you want more details.

You will be hearing the CH-prefix in Canada for a month starting on October 16th to mark the 100th anniversary of Louis Riel. A political activist in western Canada, among other things, he led the second Riel Rebellion in 1884, was convicted of treason in 1885, and was executed at Regina. Eber Diehl, W7AMM, has the logs for his operations in Iran as EP2EJ from 1971 to 1977, and if you need an EP2EJ QSL, all you have to do is ask with an SASE. Write to W7AMM at P.O. Box 2026, Sierra Vista, AZ 85636.

The Wireless Institute of Australia amateurs have been using the alternate VI-prefix and will use it until the end of the year. This is to mark the 75th anniversary of the WIA, the world's first and oldest national radio society, they proudly proclaim. This will be used throughout Australia. Once before it was used briefly locally in VK3. Also, a VK75A callsign is authorized for use throughout Australia. This is VK75A . . . period.

If you are making long-range plans, the 1986 great International DX Convention will be back at the Holiday Inn in Visalia, April 19-20th. The Southern California DX Club will be host this year, and they have already signed a contract for all the rooms in the hotel. Everything! Nothing but DX knee deep.

SU1ER says that the Egyptian Amateur Radio Society might be found most Fridays and Saturdays at 14175 kHz or 14275 kHz from 1700-2100Z. JH1RNZ got married and headed for Fiji on a DXpedition along with the bride. JAs report that 3D2RN was not heard during daytime hours, but 160 through 20 was busy with pile-ups every night. Seems that there is a story under all of that somewhere. 8J1XPO is on from the Tsukuba Science Exposition. QSL via JARL.

In June the ARRL filed a petition for more Novice privileges to meet their goal of 600K licensees in the U.S. by 1990. After "massaging" by the staff, the proposal includes expansion of the 28 MHz Novice/Tech band to allow CW and data communications at 28.1-28.3 MHz and CW and SSB from 28.3-28.5 MHz; Novice privileges on 220 MHz; Novice privileges in the 1240 MHz band; and a couple of other ideas. The word is that there is much inactivity among Novices—" . . . tens of thousands" have never used their licenses to make a single contact. The July statement said, ". . . while Morse code is, and probably always will be, an integral part of Amateur Radio, it is not the only mode that is appropriate for a beginner to use."

Remember, the season for DXing starts later this month—the great CQ World-Wide Phone DX Test the last weekend of the month. Don't worry about the sunspot cycle. Just check WWV and jump in. Low bands might be even deeper. 73, Cass, WA6AUD

## DX Ten Years Back

LA1SH/BY was heard out of China. There was some skepticism, but eventually it appeared he had been in Darien, but aboard a merchant vessel tied up at the dock. EP2SN was on frequently trying to fill out a WAS. W3ACE, once a U.S. ambassador, visited the top man for radio affairs in Baghdad while on a visit. Discussing the amateur operating situation, the official expressed the view that perhaps some amateur radio activity would be possible, also some good p.r. Hank immediately applied for a YL-license. It was immediately rejected. W6KNH was off on a trip with stops at BV, 9V1, 9M2, 9N1, VU, 4S7, 5Z4, ZE, and PY and planned to operate as possible at each stop. The Colvins were preparing to head out on DXpeditions again after a long lay-off. Sable and St. Paul Islands showed for new DXCC countries for the Deserving. Tuvalu was also due up as a true-blue counter within a few months. EA8CR was headed for Equatorial Guinea for the CQ WW CW Test, and CR9AJ was active from Macao. And how about the sunspot cycle of Cycle 20—headed for the bottom and just about there.

## QSL Information

All of this comes with a lot of help and W9LNQ.

AX6ITU to VK6DU  
 CT3EU to G3PFS  
 DL7FT/SV to DL7FT  
 EB2ITU to EA1QF  
 EF5UIT to EA5CS  
 EP2EJ to W7AMM  
 HB9APJ/OX to HB9APJ  
 HB9ASJ/OX to HB9ASJ  
 HP1XKA to JA7AGO  
 J5WAD to W6CNA  
 JV1UB to JT1KAA  
 JY5CI to G4WVZ  
 JY9MG to JR3XMG  
 JY9WR to G4ATS  
 OG3AA to OH3AA  
 ON6TW/GUB to ON7JF  
 P29SN/ZL1 to ZL2BOF  
 PT8MI to W3DJZ  
 SV9CS to SV-Bureau  
 SV8DH/5 to Bureau/or 85CB  
 V2A to W2 Bureau  
 XJ4RMP to VE4AKN  
 ZC4AB to G4SDJ/85 CB  
 ZC4CZ to G4MJO  
 3X8HAB to DL8CM  
 7S1SSA to SM1ALH

7S4SSA to SM Bureau  
 A92P to POB 14, Menoma, Bahrain  
 BY1QH to POB 2654, Beijing, Peoples Republic of China  
 CE8ZIG to Box, Airport, Easter Island  
 DX1N to JJ3FMP Shige Haya-shi, 9 Yamamichi, Aramaki, Itami Hyogo, 664 Japan  
 NY6M/KH2 to Gary Dein, 216 Holden St NCWP, FPO San Francisco 96630-1800  
 T32AN to Box 667, Aiea, Hawaii 96761  
 TA1E to POB 794, Istanbul, Turkey  
 TA1D POB 1167, Istanbul, Turkey  
 VP2MEV to Ed Radio, AJ6V, 25811 Estacada Dr., Los Altos Hills, CA 94022  
 XJ4RMP to Daryl McKinny, 15 Jupiter Bay, Winnipeg, Manitoba R3T 0W5

Watch for our great new products coming soon!



MODEL HQ-1  
\$189.95

CRAMPED FOR SPACE — WANT DX?

Then you want the antenna that's known around the world for its small size and superior performance...The **Multiband HYBRID QUAD** for 6-10-15 & 20 meters.

If not stocked by your dealer order direct. We pay shipping in USA...Send for free catalog of other models and more data.

- WING SPAN-11 FT.
- BOOM-54 INCHES LONG
- WIND AREA-1.5 SQ. FT.
- 1200 WATTS P.E.P. INPUT TO FINAL
- FEED LINE-50 OHMS
- EACH BAND FREQUENCY ADJUSTABLE

Mini-Products, Inc.

1001 W18th St., Erie, Pa. 16502  
814-454-2171

## A LOOK AT THE WORLD AROUND US

### Understanding Modern Amateur Gear—Part III

**A**s you'll recall, last month's column featured the first part of our inside look at modern SSB gear. We discussed introductory thoughts on understanding circuit designs and home servicing, plus various means of recognizing your own electronic capabilities or limitations. This month we conclude the mini course with some detailed ideas and proven techniques for analyzing, cross-comparing, and troubleshooting HF transceivers. Our upcoming information is useful for both amateurs interested in self-maintaining their rigs and not-so-technical individuals desiring the best possible insight when purchasing new gear. That ability to study block diagrams and schematics when comparing future rigs has definite benefits over impulsive purchases guided by attractive front panels. Possibly we could compare this to the proverb of beauty being only skin deep, a fact which most of us recognize, and one that also describes amateur gear. Front-panel glamour is nice, but it can also be deceiving.

Personally, I prefer a rig that is stout-hearted enough to take some abuse, yet simple enough so that I can understand its "innards." I don't like a feeling of helplessness if a unit breaks down. If that means buying basic design-type gear in your particular situation, so be it. A confident attitude often results in maximum enjoyment—of autos, amateur gear, or even home appliances. Agree?

Since we obviously can't delve into all of a transceiver's technical aspects in this brief discussion, we've elected to zero in primarily on RF and IF concepts at this time. Techniques of microprocessor control and digital frequency selections are subjects within themselves, some of which have been covered in previous articles. If creditable interest is reported in these areas of 1, 2, 4, 8 band selection with related binary counts being decoded on various boards for "picking up" filters, etc., plus divide-by-N tunings, we'll elaborate on such aspects in a future column. Meanwhile, let's direct our attention to understanding some of those mystifying innards in our modern transceivers.

#### Relating Block Diagrams, Schematics, and PC Boards

A brief glimpse inside any modern transceiver gives factual proof that a

step-by-step approach is the most logical means of understanding and/or servicing these fully packed units. Lacking that insight, a unit can merely be visualized as an amazing and mysteriously functioning product of modern technology. Unraveling those vague areas begins by reading a manual's theory of operation section while following explanations on its related block diagram. Some amateurs use various colored pens for tracing receive, transmit, common oscillators, and power-supplying paths, and for including associated frequencies/bandwidths of circuits within a unit. We heartily endorse that helpful idea.

The previous exercise can provide both basic familiarization with a unit's circuitry and an indication of one's technical limitations. You can then reconsider your own understanding of concepts such as signal frequency conversion (incoming RF to IF, for example), demodulation or product detection (acquiring AF from an IF signal), balance modulators (audio and RF carrier are superimposed, carrier is nulled, leaving double sideband only signal), crystal filters (their narrow bandwidth will pass only one of those sidebands), etc. Assuming you still feel technically competent, actual signal paths within various transceiver "blocks" can now be traced on the unit's schematic diagram. If a signal path or area becomes overly complex, you can refer back to the block diagram, note components (Q6's output goes through noise blanker gate, moves from RF to IF pc board, goes through filter YK88S, and continues through Q1, Q2, and Q3 before reaching the SSB/CW detector, for example), then return to the schematic itself (there's YK88S and Q1, Q2, Q3; now where's the circuit run interconnecting those sections and continuing to D21 through D24?). After you become familiar with a unit's block diagram and schematic, relating associated circuitry to internal pc boards is a fairly easy matter. Large objects such as filters, IF cans, IC's, or variable resistors are used for reference, while resistor and transistor numbers (Q1, R34, etc.) aid cross comparisons.

The previously outline technique of block diagram to schematic correlations can be exemplified with the aid of figs. 1 and 2 (an ideal time to try your illuminated magnifier and colored pens). A TS-430 was picked at random for this particular study only because its schematics evenly fit our page size (no, I do not own a TS-430).

Since the IF board handles a variety of operations, only that section will be considered at this time (note dotted lines of separate boards on the rig's block diagram). Let's begin where the 8.830 MHz receive signal enters the IF board (left top area of fig. 2). That signal moves through YK88S to the bottom gate of Q1, off its drain (top wire), through L2 to bottom gate of Q2, through C26 to Q3, on to L4, and into detector D21 through D24. Looking at both the block diagram and the schematic, an 8.8315 MHz carrier/oscillator signal from the rig's "control unit" enters the IF board's left side and connects to both the SSB/CW detector (via a variable resistor across L4's secondary) and the transmitter's balance modulator (via pin 3 of IC7). Returning to the SSB/CW detector and subtracting 8.8315 MHz oscillator from 8.8300 MHz IF gives 1500 Hz, an audio frequency midway of the IF/filter bandpass. That audio signal progresses through IC1 to Q46 (notch switched off), off that emitter, off the board to the AF gain control, then back in and on to pin 1 of IC5, out via pin 4, and again off the board to the speaker. Notice how every detail is visible on the schematic and how the block diagram helps when you become lost. I've pointed out the AGC and squelch sections in the schematic. Now it's your turn to trace their wirings/actions.

Moving to the transmitter's section, audio from the mike input enters the schematic's left bottom area and proceeds to the base of Q34. That audio proceeds to the input of IC6 (pin 1), out on its pin 3, off the IF board to the mike gain control, back in and to the base of Q38, and on to one input (pin 1) of the balance modulator, IC7. Since an 8.8315 MHz signal is also fed to the other input of IC7 (pin 2), a double-sideband suppressed carrier signal appears at its output (pin 7). If you carefully follow that wire (and our marks), it treks back through filter YK88S (drop one sideband), back "way around" the board to Q41's bottom input gate, and out to Q15 on the RF board. We now invite you to review our presented methods of circuit tracing and apply the concepts to your own amateur transceiver. Remember to refer back to block diagrams as necessary and note "sign posts" items when relating schematics to actual pc boards, and you'll realize maximum insight on your rig's overall operation.

#### Troubleshooting Amateur Gear

Before one delves headlong into home repairs of amateur gear, it should be

Eastwood Village No. 1201 So., Rt. 11,  
Box 499, Birmingham, AL 35210

*Dotted Lines = Circuit boards*

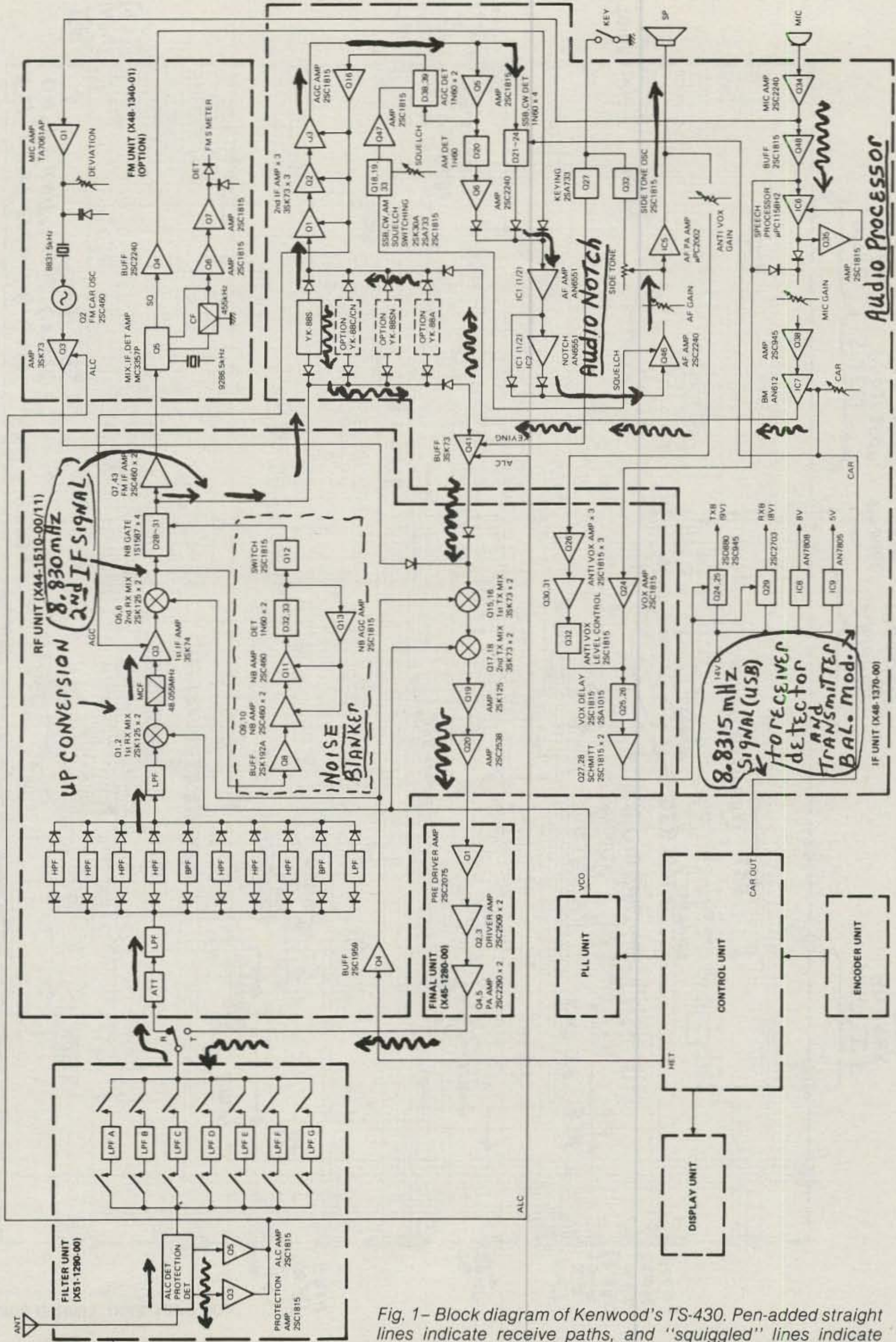

Fig. 1—Block diagram of Kenwood's TS-430. Pen-added straight lines indicate receive paths, and "squiggled" lines indicate transmit paths. This block diagram relates to next-figure schematic. Discussion in text.

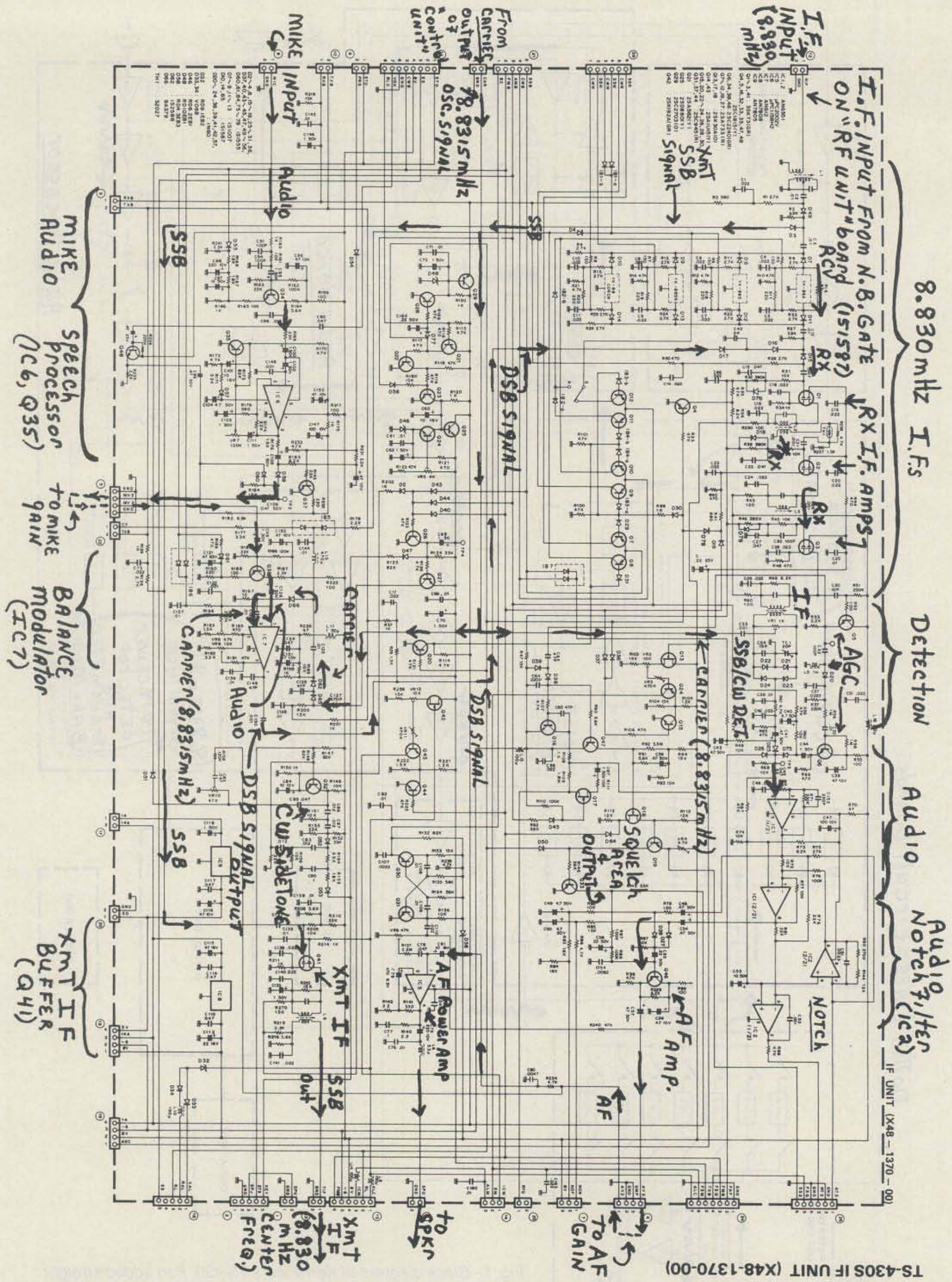

Fig. 2- Circuit diagram of main pc board and IF section in Kenwood's TS-430. Discussion of functions and signals in text.

**ASTRON — SALE!**

RS-7A	45.00	RS-35A	123.75
RS-12A	62.75	RS-35M	138.95
RS-12M	78.95	VS-35M	156.95
RS-20A	79.95	RS-50A	179.95
RS-20M	96.45	RS-50M	203.25
VS-20M	114.95	VS-50M	223.95

**KLM**

2M16LBX, 220-22LBX, 432-30LBX	90.50	
2M-14C-85	2M-22C-108	50
435-18C-110	435-40CX-144	50

**KENPRO ROTORS**

KR400/KR500	125.95/154.95
KR-5400/KR-5600	247.50/309.95

**HENRY AMPS**

2 KD CLASSIC	965.00
2002A/2004A Less Relay	1250./1350.
3002A/3004A Less Relay	2100./2100.

**AMP SUPPLY**

LK-500ZB	1,097.95
----------	----------

**MIRAGE-FREE UPS BROWN ON ALL MIRAGE**

A1015 - 235.50	C-22A - 85.95
B23A - 83.95	C-106 - 169.95
B215 - 245.50	C-1012 - 248.95
B108 - 149.95	D-24N - 177.50
B1016 - 235.50	D-1010N - 279.50
B3016 - 199.50	D-3010N - 251.00
MP-1 - 99.95	MP-2 - 99.95

**TONNA F9FT ANTENNAS ARE BACK! WE ARE THE EXCLUSIVE U.S. DISTRIBUTOR INTRODUCTORY SPECIAL:**  
1269/1296 QUAD ARRAY COMPLETE WITH 4-23el YAGIS; 'H' FRAME; POWER DIVIDER; PHASING LINES; CONNECTORS. GREAT FOR OSCAR MODE 'L' OR TERRESTRIAL APPLICATIONS. REGULARLY 339.95 **SALE PRICE 215.95**

**OTHER GREAT, HIGH PERFORMANCE ANTENNAS BY TONNA (CALL FOR SPEC. SHEET!!)**

5 EL. 6 METER YAGI	69.95	13 EL. 2MTR YAGI	59.95	TONNA(CALL FOR SPEC. SHEET!!)	
21 EL. 70cm YAGI	56.95	23 EL. 1296/69 YAGI	46.95	19 EL. 70cm YAGI	44.95
(ATV MODELS IN STOCK)		17 EL. 2MTR SUPER YAGI	88.00	2MTR OSCARTWIST	65.95
70cm OSCARTWIST	68.95	55 EL. 1296 SUPER YAGI	68.95	2 x 9 EL. (18el)	
2 x 19 EL. (38el.)		9 ± 19 el OSCAR ANTENNA 2M & 70cm ON A COMMONBOOM-GREAT FOR STACKING	75.95		

**WATCH OUR ADD FOR NEW LINES!!**

**FOR THE BEST DEAL IN TOWN CALL THE BEST NUMBER AROUND 1-800-HAM-7373**

**CUSHCRAFT AOP-1 OSCAR PAK-133.99 RINGO RANGER II (2-220-440)-33.99**  
**KENWOOD TS-940S/AT - CALL US! YAESU FT - 757GX XCVR - 695.95**  
**KENWOOD TR2600A H.T. - CALL US! YAESU FT - 270RH XCVR - 365.95**

**KENWOOD**  
FACTORY AUTHORIZED DEALER  
CALL US FOR AMERICA'S LOWEST PRICE ON ALL YOUR KENWOOD NEEDS (FREE UPS BROWN ON KENWOOD GEAR)

**CUSHCRAFT**

215WB - 73.00	A-3	200.45
4218XL - 91.00	A-4	267.45
R-3 - 250.95	40-2CD	267.45

OTHER MODELS IN STOCK — CALL

**CUE DEE THE SWEEDISH BOOMER**  
USED BY MANY TOP '10' CONTESTERS  
144-15AN 2MTR15EL. 75.95

**PARABOLIC**

1296-28 IW TRANSVERTER	339.95
1269-144 3W UP CONV.	319.95
1296 DUAL TUBE AMP CAVITY	439.95
2PORT POWER DIVIDERS (2-220-432)	50.95
4PORT POWER DIVIDERS (2-220-432)	55.95
1296 2PORT DIVIDER	57.95
1296 4PORT DIVIDER	62.95
1269/96 DISH FEEDS	89.95
2304 DISH FEEDS	89.95
1296 SLUG TUNERS	65.95

**YAESU — FACTORY AUTHORIZED DEALER CALL FOR THE BEST DEAL AROUND ON 'THE RADIO' FULL LINE (FREE UPS BROWN ON YAESU GEAR)**  
**MUTEK LTD.**

DO YOU OWN AN ICOM VHF XCVR? DO YOU WANT TO IMPROVE THE RECEIVER - TRY OUR MUTEK FRONT END BOARD - YOU'LL BE GLAD YOU DID!

RPCB211/251 RD FRONT END	143.95
FOR ICOM 211 OR 251	
RPCB271 FRONT END FOR ICOM 271A OR 271H	168.95
RPCB225 FRONT END FOR YAESU 221/225	143.95
SLNA 50S 6MTR PREAMP	84.95
SLNA-144S 2MTR PREAMP	84.95
100WRF SWITCHED, N.F. < 1db, GAIN 15db.	
SBLA144E 2MTR MAST MOUNT R.F. SWITCHED PREAMP, 250W THRU POWER, N.F. < 1db 15dbG	169.95
GLNA 433E 70CM MAST MOUNT R.F. SWITCHED PREAMP, 50W THRU N.F. < 1db G = 15db	172.95
GFBA-144E 2MTR MAST MT. PREAMP, 1KW THRU POWER G = 15db N.F. < 8db WITH AMP SEQUENCER	289.95
GLNA-432E 70cm MAST MT PREAMP, 500W THRU, G = 15db N.F. < 1db. WITH AMP. SEQUENCER	299.95
HIGH D.R. DBM XVRTRS FOR 6 ± 2MTRS COMING SOON!	

**SSB ELECTRONIC**

K6001 6 To 10 DBM RCV CONV.	115.95
K2001 2 To 10 DBM RCV CONV.	115.95
K7001 70cm To 10 DBM RCV CONV.	115.95
K2301G 23cm To 10 or 2 RCV CONV. G.F. FRONT END AND DBM	159.95
TV-144-28-10 10W 2MTX XVRTR	209.95
TV-432-28-10 10W 70cm XVRTR	299.95
TV-220-28-10 10W 1/4M XVRTR Coming Soon	
DX-144 PREAMP N.F. < 4db	130.95
DX-220 PREAMP N.F. < 5db Coming Soon	
DX-432 PREAMP N.F. < 5db	130.95
(WON DAYTON 1985 N.F. CONTEST)	
DX-1296S PREAMP N.F. .5db	156.95
DX-2320 PREAMP N.F. < 8db	186.95
PA-2310 1269/1296 10W LINEAR AMP.	275.95
LT-23S 1296 10W LINEAR TRANSVERTER	610.95
2MIF	610.95
LSM-24 1269-2 OSCAR MODE L XMIT CONV. 1W	
OUTPUT, 2M.I.F.	299.95
MICROLINE 13 1/2 W 2.3GHZ XVRTR SYSTEM 2M.I.F.	410.95
MICROLINE 13 3W 2.3GHZ XVRTR SYSTEM, 2M.I.F.	675.95
SLA-13 2304 3W AMP	285.95

**MAST MOUNTED PREAMPS:**

MV144V 250W R.F. SWITCH WITH 12V SUPPLY INTERFACE	175.95
MV432V 150W R.F. SWITCH WITH INTERFACE	185.95
MV-144S-01 1KW THRU PWR WITH SEQUENCER	309.95
MV-432S-01 500W THRU PWR WITH SEQUENCER	319.95
MV-1296S 100W THRU PWR WITH SEQUENCER	349.95

OTHER HIGH QUALITY PRODUCTS IN STOCK-CALL FOR CATALOGUE

TERMS: Prices do not include shipping except where indicated and are subject to change without notice. At our discretion some COD's may require a deposit. Returns are subject to a 15% restocking charge. \*Continental USA only

16 S Mountain Blvd -- Rt 309  
Mountaintop, Pa 18707

HOURS: Monday thru Friday 10 a.m. - 4 p.m.  
Saturdays 10 a.m. - 12 p.m.

"24 HOUR PHONE SERVICE FOR YOUR CONVENIENCE"

MC/VISA/C.O.D

CIRCLE 109 ON READER SERVICE CARD

**PORTAQUADS**  
2-MTR & 220 MHz  
FOLDS INTO CASE CA. ADD  
SPECIFY BAND \$73.95 6% TAX  
RADIO ENGINEERS  
3941 MT. BRUNDAGE AVE.  
SAN DIEGO CA. 92111

CIRCLE 67 ON READER SERVICE CARD

**CABLE TV**  
**Converters/Descramblers**  
Jerrold, Hamlin, Zenith—Many Others! Factory Units/  
Lowest Dealer Prices. Complete illustrated catalog, \$2.00.  
Pacific Cable Co., Inc., 7325 1/2 Reseda Blvd., #905  
Reseda, CA 91335 (818) 716-5914

CIRCLE 98 ON READER SERVICE CARD

**MOR-GAIN**  
1/2-size (75M only 66')  
Multi-Band (5, 4, 3 bands)  
80/75M thru 10M  
Broadbanded - no traps used  
Prices start at \$104.50

**MOR-GAIN**

THE MOR-GAIN HD DIPOLES are the most advanced, highest performance multi-band HF dipole antennas available. Patented design provides length one-half of conventional dipoles. 50 ohm feed on all bands, no tuner or balun required. Can be installed as inverted VEE. Thousands in use worldwide. 22 models available including two models engineered for optimum performance for the novice bands. The Mor-Gain HD dipoles N/T series are the only commercial antennas specifically designed to meet the operational requirements of the novice license. Our 1-year warranty is backed by nearly 20 years of HD dipole production experience.

For detailed 10-page brochure, write or phone directly to **MOR-GAIN**, P.O. Box 329C, Leavenworth, Ks. 66048, Tel. (913) 682-3142.

DEALER INQUIRIES INVITED

**MOR-GAIN**

**ENGINEERING CONSULTING INTRODUCES**  
**TOUCHTONE™ DTMF to RS-232-C 300 BAUD INTERFACE**

TOUCHTONE RECEPTOR → "DECODE A PAD" (DAP-1) → SERIAL PORT → COMPUTER

- Use your computer to decode DTMF touchtones.
- Receive all 16 digits as fast as they can be transmitted.
- Easily program your computer in BASIC to decode multi-digit "strings", display digits, sound alarms, observe secret codes, control relays, remote base.
- Simple to use; just provide +12 VDC and audio, hook two wires to the RS-232-C serial input on your computer, enter a simple BASIC program and begin to decode.
- Simple BASIC program and instructions included.
- L.E.D. Indicator

**"Decode-A-Pad" Model DAP-1**  
Wired and Tested **\$89.95**

Includes shipping USA. Cal. addresses add 6%.  
VISA and MasterCard accepted, or send check/M.O. to  
**ENGINEERING CONSULTING**  
583 CANDLEWOOD ST., BREA, CA 92621  
714/671-2008

Please send all reader inquiries directly.

**TOUCHTONE™ DECODER KIT**  
- MODEL TTK -  
**\$22.95**

- SSI 201 DTMF Receiver
- Receive all 16 DTMF digits
- No additional filtering
- Output BCD or hex format
- Low power (29ma @ 12V)
- Kit includes 3.58Mhz crystal, 22 pin IC socket, resistor, capacitors, data sheet and schematics

**4 DIGIT SEQUENCE DECODER**  
- MODEL TSD -  
**\$59.95**

- Completely wired & tested
- User programmable
- LED status indicator
- Open collector output
- Control relays; mute audio
- Control link on/off
- Custom IC insures high reliability & small size!
- Fits inside most rigs; runs on 12 VDC (35ma)
- Over 1500 different codes!

- Makes excellent private call on busy repeaters!
- Use it to turn on audio or sound an alarm
- Momentary and latching outputs

MasterCard and Visa accepted, or send check/M.O.  
Cal. address add 6%; price includes shipping USA. Send to:  
**ENGINEERING CONSULTING**  
583 CANDLEWOOD ST., BREA, CA 92621  
TEL: 714-671-2009

Please send all reader inquiries directly.

# Copy Worldwide Short-wave Radio Signals on Your Computer

Remember the fun of tuning in all those foreign broadcast stations on the short-wave radio? Remember those mysterious sounding coded tone signals that baffled you? Well, most of those beeps & squeals are really digital data transmissions using radioteletype or Morse code. The signals are coming in from weather stations, news services, ships & ham radio operators all over the world. Our short-wave listener cartridge, the "SWL", will bring that data from your radio right to the video screen. You'll see the actual text as it's being sent from those far away transmitters.

The "SWL" contains the program in ROM as well as radio interface circuit to copy

Morse code and all speeds/shifts of radioteletype. It comes with a cable to connect to your radio's speaker/earphone jack, demo cassette, and an excellent manual that contains a wealth of information on how to get the most out of short-wave digital DXing, even if you're brand new at it.

For about the price of another "Pac-Zapper" game, you can tie your Commodore 64, 128 or VIC-20 into the exciting world of digital communications with the Microlog SWL. \$64. Postpaid, U.S. MICROLOG CORPORATION, 18713 Mooney Drive, Gaithersburg, Maryland 20879. Telephone: 301 258-8400.

**MICROLOG**  
INNOVATORS IN DIGITAL COMMUNICATION  
CIRCLE 110 ON READER SERVICE CARD



## BUILD 'EM YOURSELF ELECTRONICS PROJECTS

Each book has 40 different new practical electronics projects, state-of-art technology, parts available at Radio Shack, other handy suppliers. Learn as you build these fun gadgets, devices, useful utensils, simple tools.

### QUICK-N-EASY ELECTRONICS PROJECTS

40 projects, 96 pages, \$7.95

### EASY-TO-BUILD ELECTRONICS PROJECTS

40 projects, 96 pages, \$7.95

Send check, money order, cash, or VISA/Mastercard number and expiration date. Include \$1 postage per book. Allow 3-4 weeks delivery. Sorry, no CODs or telephone orders.

**ARCsoft Publishers**  
Post Office Box 132C  
Woodsboro, Maryland 21798

## AR-200 XL MEDIUM DUTY ANTENNA ROTOR

Select a Heading - Antenna Turns and Stops Automatically.



\$99.95

## SIDEBAND SQUELCH

- Fits inside most HF-SSB transceivers.
- Requires human voice to activate.
- Ignores static, noise and heterodynes.
- On/off switch only—no adjustments!
- Connects to audio leads and 9/12 VDC.
- Fully assembled and tested \$99.95.
- Complete with comprehensive manual.
- Used worldwide in commercial and military transceivers.



CMC COMMUNICATIONS  
5479 Jetport, Tampa, FL 33614 (813) 885-3996

CIRCLE 120 ON READER SERVICE CARD

## UHF POWER AMP

AM-6155/GRT (ITT 3212) 225-400 Mhz RF amp, 50W output from 4-10W input using Eimac X6512; silver-plated cavity in removable drawer. Requires 115/230 VAC & 20 VDC. 7x19 1/2x18", 75 lbs. sh. Used-not tested, excellent condition: \$159.50

AM-6154/GRT VHF POWER AMP, same as AM-6155 except covers 116-149.95 MHz range; used-not tested, \$209.50

CU-872 HF ANTENNA COUPLER for up to eight 2-32 MHz receivers; 70 ohm output, N connections, test meter, and 20/6922 tubes. 7x9x16.5, 40 lbs sh. Used, \$49.50

Prices F.O.B. Lima, O. • VISA, MASTERCARD Accepted. Allow for Shipping • Send for '85 Catalog Supplement Address Dept. CQ • Phone: 419/227-6573

**FAIR RADIO SALES**  
1016 E. EUREKA • Box 1105 • LIMA, OHIO • 45802

CIRCLE 66 ON READER SERVICE CARD

## ICOM



Contact us for all of your amateur radio needs... FEATURING:

ICOM, AEA, LARSEN, VAN GORDEN, VIBROPLEX, NYE-VIKING, FALCON COMM. LEADING EDGE., ARRL PUBLICATIONS, KAGLO, HAMTRONICS, PROWRITER, ELEPHANT DISKS, DEBCO TRIONYX

## VHF COMMUNICATIONS

915 North Main Street  
Jamestown, New York 14701

Western New York's finest... amateur radio dealer!  
PH. (716) 664-6345

CIRCLE 161 ON READER SERVICE CARD



understood that serious electronic troubleshooting is a time-perfected skill. Likewise, we must also realize that every technician has his own style of analyzing/repairing equipment and changing such success-proven methods isn't always logical advice. In other words, I can outline some well-founded ideas and pointers, but complementing hands-on experience/skill must be acquired on a personal basis.

As a reassuring beginning, remember that a kaput transceiver is usually stifled by a single problem rather than "mass burnout." Replacing a few defective components usually restores smooth operation to that favorite rig. The keynote to that restoration involves mentally dividing the rig into stages (RF, IF, demodulator, AF, etc.), then pursuing a straight-line path for locating "where the signal stops" and uncovering the defective stage. Separate components are then checked/replaced within that stage, and the rig returns to operation.

The sophisticated nature of today's transceivers can be advantageously used for determining internal areas or stages with problems. We merely study the rig's block diagram, use "common reasoning," and let the unit itself describe its ailing section. Assume, for example, a rig transmits perfectly (full output, good quality audio, etc.), but receive sensitivity is very low (no S-meter readings, low audio, etc.). First, a double check here. Is the antenna in known good shape? Are front-panel switches set correctly? Does another (preferably similar) transceiver perform better when connected to the same antenna cable? Remember our previous note: Don't Assume Anything! Check everything fully (this step is the most often overlooked). Next consider block-diagram facts. What receiver stages are not used for processing (IF level) transmit signals? This step can narrow troubles to receiver RF and IF stages and support sections. Depending on a unit's design, the RF attenuator and noise blanker can be used for further narrowing the search to "before" or "after" their connected sections. Beyond this point one might consider clip-lead connecting the antenna to various stage inputs "up to" the first mixer and noting receiver performance (a sudden burst of signals obviously indicates you've "crossed" the defunct stage). Assuming the problem still exists, the defective area has been narrowed to a minimum number of stages, and IF signal injections are logical continuing steps. Assuming a local friend has an identical model rig, "cross connecting" stages may prove ideal here. Capacitors are used for blocking DC while passing RF signals (a .01 mFd is fine), and a known-good IF signal is injected from the working transceiver to that same point on the ailing rig. If one carefully respects frequencies, levels, and wirings, this technique is quite

useful. Whatever method or concept you adopt, remember that both transmit and receive signals follow a series path through a transceiver, and you should follow a similar "straight ahead"/stage-by-stage pursuit for locating malfunctions. Think logically, maintain patience and perseverance, and keep alert to your own technical limitations.

### Conclusion

Although the ideas and techniques discussed in our two-column feature were general in nature, their concepts can be applied to almost any transceiver or any type of equipment problem. If you understood my explanations, you can also visualize ways of expanding on those ideas. If you didn't understand my explanations, you know to avoid delving that deep into home repairs. Reread that last sentence. It made an important point. Incidentally, the information presented in this two-part article is comparable to a rather expensive mini-course in amateur radio electronics. Maybe you should reread the whole thing another time for maximum benefit. Chances are good you'll find something useful that you missed previously.

There are both advantages and disadvantages to home-servicing amateur gear, and that situation should be recog-

nized before delving inside modern units. Assuming such servicings are within one's range of technical abilities, possible consequences of cross-country shipping entanglements and delays are minimized. Original equipment owners also exhibit the most tender and meticulous care of their prized possession. On the other hand, trained service technicians are usually familiar with various equipment idiosyncracies or common problems and can usually perform repairs (especially those of a heavy technical/serious nature), while we "operators" are still involved in studying schematics and board layouts.

You know, the fact that we're licensed *amateurs* doesn't necessarily mean that we understand the full internal designs of our equipment. The more we know about our units, however, the greater merit we reflect to both ourselves and our society overall. How can we be expected to know or understand how a rig functions, or generally how to keep it functioning, if we are not shown, right? This column/series has been a departure from the usual "enjoy it and forget how it works" attitude that's occasionally noticed in today's world. Your thoughts and opinions on this special column feature will thus be appreciated, closely evaluated, and used for considering similar future columns.

73, Dave, K4TWJ

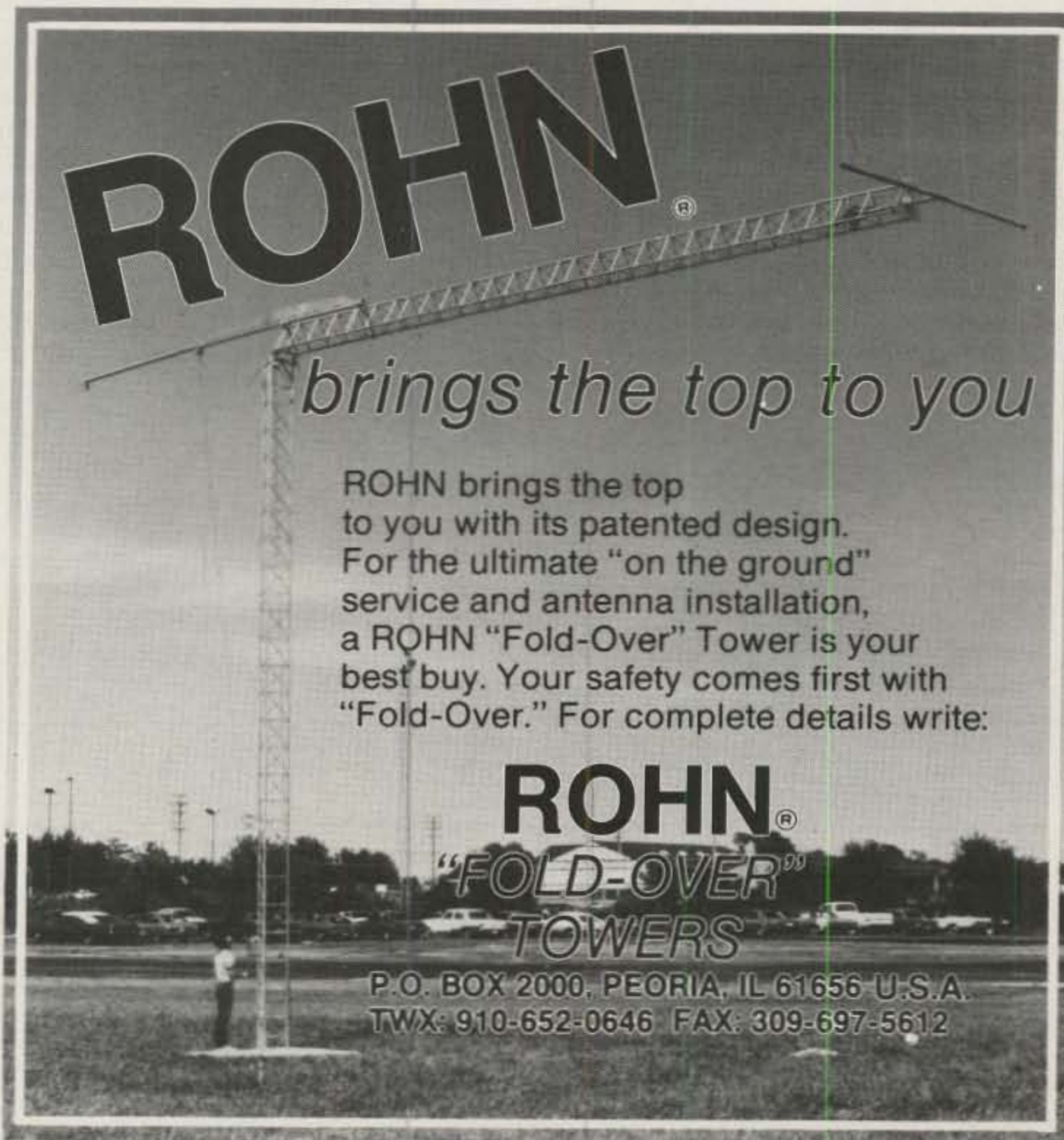

**ROHN**<sup>®</sup>

*brings the top to you*

ROHN brings the top to you with its patented design. For the ultimate "on the ground" service and antenna installation, a ROHN "Fold-Over" Tower is your best buy. Your safety comes first with "Fold-Over." For complete details write:

**ROHN**<sup>®</sup>  
"FOLD-OVER"<sup>®</sup>  
TOWERS

P.O. BOX 2000, PEORIA, IL 61656 U.S.A.  
TWX: 910-652-0646 FAX: 309-697-5612

Please send all reader inquiries directly.

## PRINCIPLES, PRACTICES, AND PROJECTS FOR THE VHFER

### A Tale of Two Preamps

As reported in this column for August, I purchased two new GaAsFET preamps at the Dayton Hamvention and intended to run them through their paces, both on the air and in the lab, and report the results. True to my promise, I have used these products on the air and spent some time making performance measurements on them in a local RF/microwave lab, and can now report my findings.

I'll break up my preamp report into two columns, with this one focusing on the laboratory evaluation of the Microwave Components of Michigan MGF1202 preamplifier for 144 MHz and a "surprise" evaluation of the Advanced Receiver Research (ARR) Model P432VDG preamplifier for 432 MHz. I say "surprise," because I hadn't intended to review this unit. I don't own the review sample. Pete, KT2B, gave it to me when he heard that I had some lab time coming up. The ARR unit, like the MCM unit, was new and unused, straight from the factory.

MCM is operated by Norm Alred, WA8EJU, whom I found selling preamps and other interesting components at the Dayton Hamvention. I don't know if this is his full-time occupation or just an avocation. In any case, he builds a nice-looking preamp in an anodized aluminum "Eddystone" type case with type N input/output connectors and a simple feedthrough capacitor for application of DC power. ARR is operated by Jay Rusgrove, W1VD, and I know that this is indeed a full-time busi-

ness. ARR offers a broad range of VHF/UHF microwave RF products, but is most famous—at least in amateur circles—for its GaAsFET preamplifiers, which are offered in frequency ranges from 50 through 432 MHz. The ARR preamps are very tiny, built in anodized aluminum, RF-tight cases using BNC input/output connectors.

I tested each preamp for gain/bandwidth characteristics, nominal gain, DC current drain, noise figure, and 1 dB compression point. I did not have the facility to test the third-order IMD performance, and although I could have measured the input and output impedance of each preamp, I neglected to do so. The preamps were tested "as received" from their respective factories with no field tuning; all tests were performed with "pure" 50 ohm sources and terminations. Recorded data was taken with DC input voltage of 12.0 volts, but I did run the power supply down to 0 VDC to monitor the point at which preamp performance degraded.

The MCM preamp DC connection was a bit annoying in that there is no factory-provided ground terminal. Normally, this wouldn't bother me. I'd simply assume the DC return was through the coaxial cable shields. But with GaAsFET devices being notorious as they are for sensitivity to static transients, I'd recommend anyone using such a preamp have a direct, soldered ground return to the power supply. To prevent potential problems, I clipped a ground lead to the case of the MCM preamp before commencing any tests. The ARR preamp has a ground terminal provided.

When I met Norm Alred at Dayton and discussed his preamps with him, he made a distinct point of mentioning that his preamp has narrower bandwidth than other popular GaAsFET preamp designs on the market. This should, he said, help to reduce the overload from out-of-band sources. He also pointed out that his preamp has two bias adjustments to allow for better field optimization of performance (noise figure versus gain). These two bias adjustments are variable resistors in both the drain lead and the source of the MGF1202. In measuring the gain/bandwidth performance of the preamp, I did not find the circuit to be particularly narrow-band: the 3 dB points are 45 MHz apart, resulting in a 31.2% bandwidth. See the gain:bandwidth plot for the whole story. The MCM preamp appears to have a bit of a high-pass characteristic, with a steep skirt on the low-frequency side of center and a much more shallow skirt on the high side.

Advanced Receiver Research makes no claim for the bandwidth of their product, but the 432 MHz model evaluated is actually quite narrowband, with 3 dB points separated 82 MHz, or a 19% bandwidth. Again, no field adjustments were made. These products were tested as received. The ARR P432VDG had its response centered on 408.3 MHz rather than 432 MHz, but the gain at 432 was only -1.2 dB from that peak. Presumably, the folks at ARR adjust for minimum noise figure and don't scrutinize each preamp for gain centered on the frequency of interest. No harm done, as the ARR preamp offered 16.8 dB gain—enough to

24 Louis Dr., Budd Lake, NJ 07828

Fig. 1—The Gain:Bandwidth plot for the Microwave Components of Michigan 2 meter GaAsFET preamp.

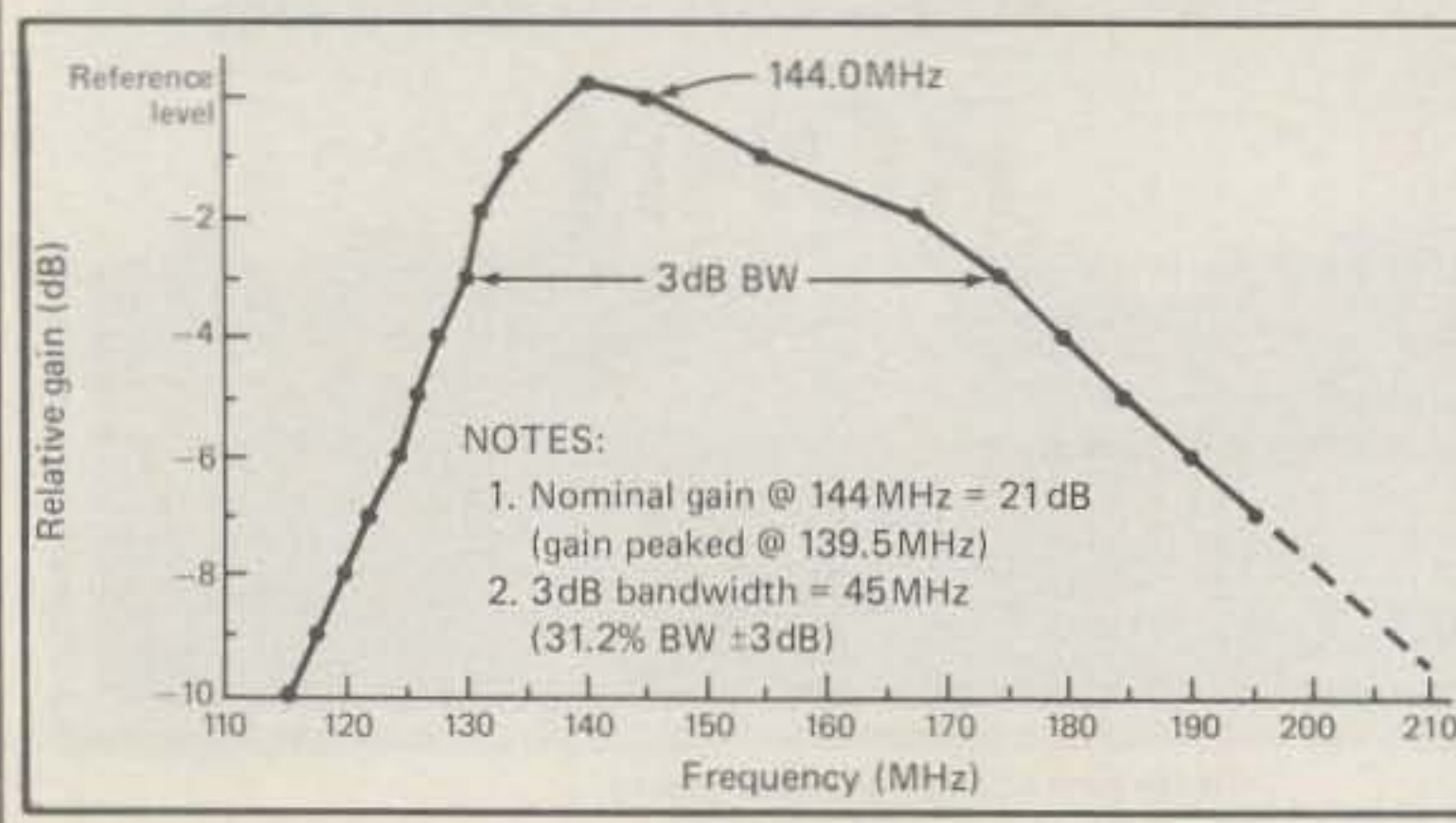
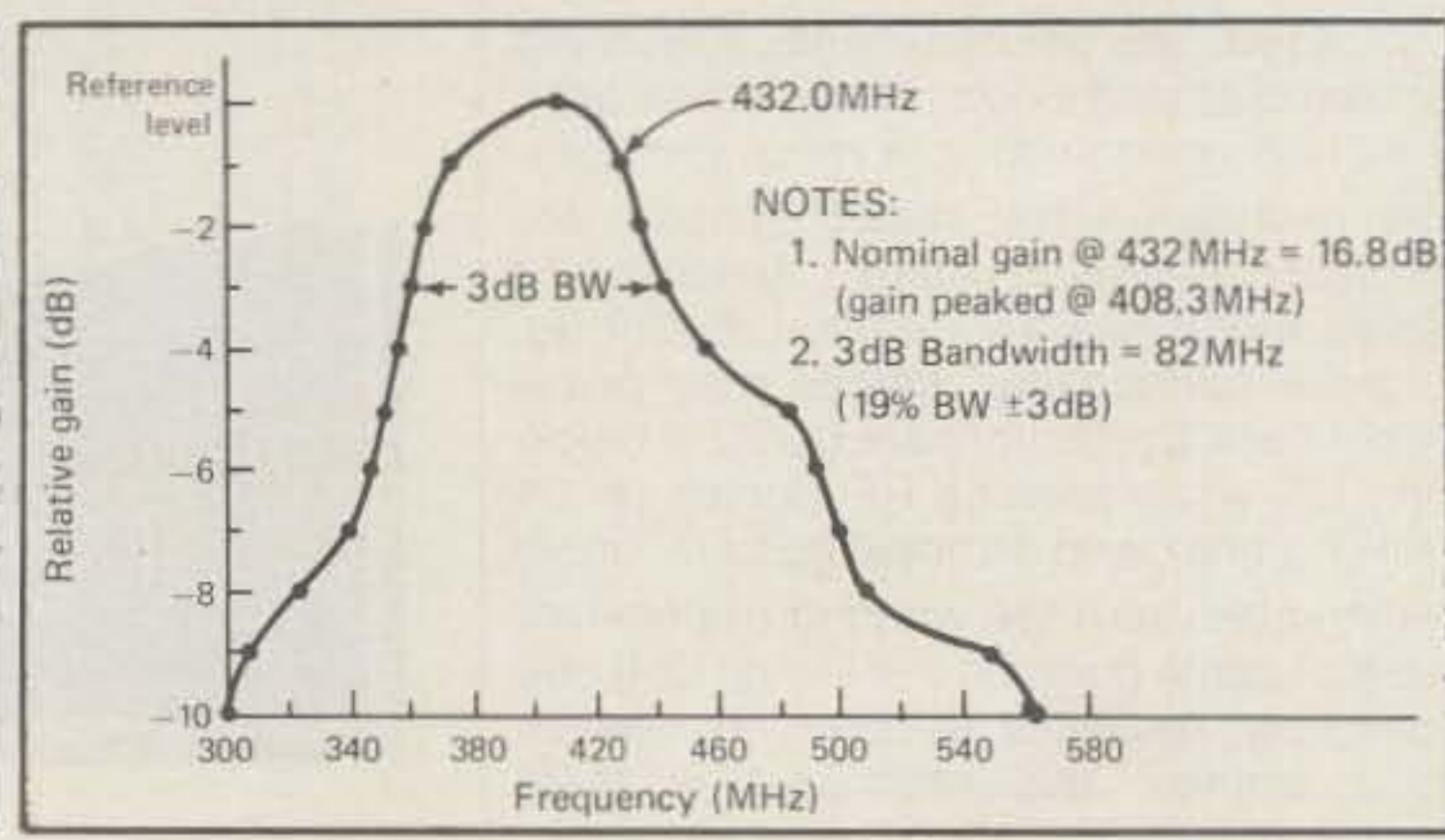
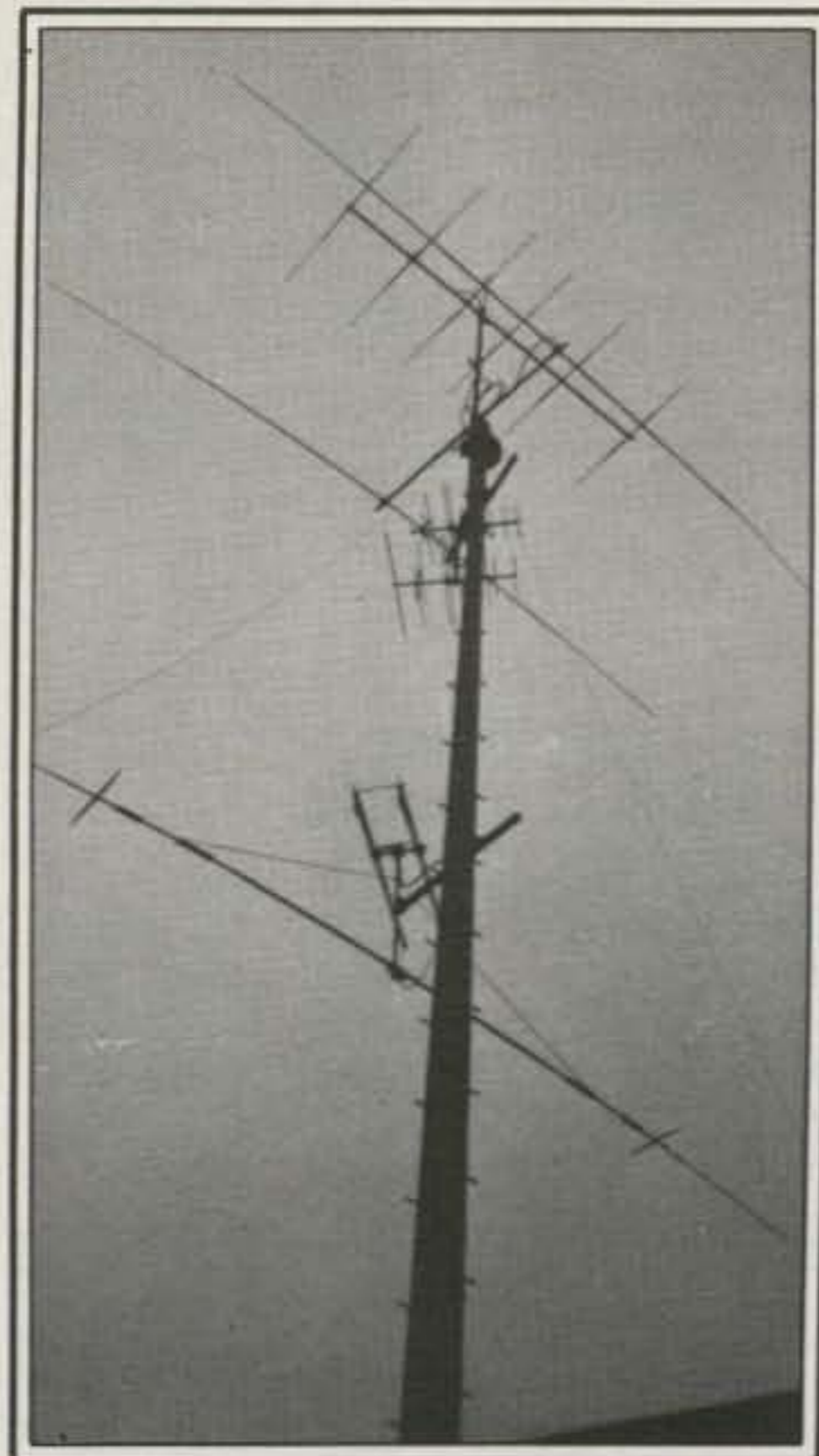

Fig. 2—The Gain:Bandwidth plot for the Advanced Receiver Research (ARR) Model P432VDG preamp.





Impressive antenna farm at JE1RXJ. Takeshi is equipped for operation from 3.5 through 432 MHz, but is mainly active on 6 meters. VHF antennas include 6 elements for 50 MHz at 80 feet and 15/15 elements at 52 feet for 70 cm. JE1RXJ intended to operate the new CQ WW VHF WPX Contest in July.

override the noise in most systems—at 432 MHz. The MCM preamp had its gain centered at 139.5 MHz, with the gain at 144.0 MHz, only  $-0.5$  dB from peak. The MCM product offered just about 21 dB gain, surely enough to override the noise in even a poor receiving system.

The noise figure of each preamp was measured using a tried-and-true Hewlett-Packard model 340 automatic noise-figure meter and then verified by calculation using an MDS measurement in a precise 1 kHz bandwidth. In each case I achieved nearly perfect corroboration between NF measurement and calculation. The MCM preamp, claimed to achieve 0.38 dB NF at 144 MHz, measured nearly exactly that figure; the ARR preamp, stated to offer  $<0.5$  dB NF, measured 0.65 dB. Rather than groan about the 432 MHz device not meeting its spec, I'll assume that the losses in my measurement system might account for the 0.15 dB difference.

The 1 dB compression point is a valuable figure of merit for any amplifier. By the time an amplifier's output compresses 1 dB with respect to the input signal, it is notably nonlinear and invariably produces considerable harmonic distortion. The MCM product does not have a claimed 1 dB compression point figure, while the ARR preamp has a published

+ 12 dBm (about 17 milliwatts!) 1 dB compression point. I made this measurement on each preamp using a Boonton Electronics Model 102F signal generator, Model 42A microwatt meter, and Hewlett-Packard 8554/141T spectrum analyzer. According to my measurements, the MCM preamp exhibited a + 8 dBm compression point, and the ARR preamp showed a + 7 dBm compression point. Harmonic distortion from both preamps was terrible at these levels, with the second harmonic (288 MHz for the MCM product and 864 MHz for the ARR) rising faster than the third. A 10 dB degradation

in the second harmonic occurred at  $-20$  dBm input (+ 1 dBm output) with the MCM product, and similar degradation occurred at  $-26$  dBm input ( $-9$  dBm output) with the ARR unit. A 10 dB degradation in the third harmonic occurred at  $-16$  dBm input (+ 4.5 dBm output) with the MCM, and  $-20$  dBm input ( $-3$  dBm output) with the ARR products. Whether this increase in harmonic distortion from the preamplifiers actually has any noticeable affect on system performance depends largely on the stages that follow. It is undesirable for the mixer to be saturated by in-band signals, as spurious mixing

*Ever wonder why honesty is so rarely advertised by amateur radio dealers?*

We do too. We believe that when you're going to spend hundreds of dollars merely on the basis of a phone call, the last thing you need to be concerned about is the integrity of the company you call. You need to know that you're going to get a deal that's fair and honest to both of us, with no surprises. At Midwest Amateur Radio Supply we're committed to honesty. ***It's our Midwestern values*** and we're not afraid to admit it.

Call with confidence...

**1-800-328-6365**

Representing all major brands:

- Yaesu • Kenwood • ICOM • Ten-Tec • Sony
- Panasonic • AEA • Bencher • McKay/Dymex
- ARRL • Mirage • B&W • Hy-Gain • Larsen

*Amateur* **Midwest** *Radio*  
Supply

3456 Fremont Avenue North  
Minneapolis, Minnesota 55412  
1-612-521-4662

products and system degradation are likely to occur.

DC current drain of both preamps is very low—10–15 mA. Apparently, both the MCM and ARR products have internal voltage regulators which allow a wide range of DC input voltage. I applied voltages from 15 VDC to nearly 0 volts to see where these internal regulators ceased performing their function. The MCM preamp showed no change in performance during the 1 dB compression test down to a voltage of 7 VDC. The ARR preamp showed no change down to 5 VDC. Below these "lower limit" voltages, the preamp outputs fell dramatically and harmonic distortion produced became intolerable.

The MCM 144 MHz preamp showed signs of instability during laboratory testing. It oscillated, producing a wide spectrum of signals from about 150 MHz to higher than 1.2 GHz, when its input port was left unterminated. In fairness to MCM, their instruction sheet does recommend a coaxial relay switching scheme which always terminates the preamp input with a 50 ohm pure impedance (see this column for August, page 66, fig. 1 for details). Also, I don't know that this oscillation harms anything. The ARR preamp seemed unconditionally stable and did not oscillate with its input unterminated.

The Microwave Components of Michigan product is available from the manufacturer in kit or wired form. Their address is 11216 Cape Cod, Taylor, MI 48180. The Advanced Receiver Research product is available from the manufacturer only in wired and tested form. Their address is Box 1242, Burlington, CT 06013.

In a future column I'll review the SSB Electronics DX1296S GaAsFET preamp for 23 cm and my brand-new ARR 50 MHz high-performance receiving converter, Model R50VDA with its accompanying P50VDG GaAsFET preamp for 6 meters.

## Fun From Fair

I'm always astonished when I come across a fellow amateur who isn't familiar with Fair Radio Sales, the veritable mecca of homebrewers and experimenters everywhere. Fair Radio has been in business nearly 40 years, specializing in government and commercial electronic surplus and offering what I've always considered excellent and honest service. Not being associated with the company, I'm really not sure who runs the show. It is obvious that they have amateurs on staff, since frequent references to amateur radio applications and publications appear throughout their catalogs.

As a homebrewer, I've used Fair Radio as a major source for all kinds of electronic parts, from power transformers to panel meters. But they also sell complete radio sets, assemblies, and subassemblies of every conceivable variety, including much that would interest VHF/UHF enthusiasts eager to conquer new frontiers.



*Ivars Lauzums, KC2PX, of Belle Mead, NJ. It was from Ivars' QTH that club group NV6O/2 operated the first CQ WW VHF WPX Contest July 20–22, 1985. Photos of the contest operation itself will follow in the November column.*

A few examples from Fair Radio's Catalog WS-85:

- A complete (minus power supply and blower) tripler/amplifier for 400–600 MHz using two 4X150-series tubes and capable of generating 300 watts output on the 70 cm amateur band: Type AM-1178/GRC, \$75.00.

- A complete (minus power supply and blower) power amplifier for 50–100 MHz using a 4X150A, capable of generating 300 watts output on the 6 meter amateur band: Type AM-1180/GRC, \$49.50.

- A really complete (including everything) power amplifier for 120–152 MHz using an 8122 tube, capable of generating 300 watts output on the 2 meter amateur band: Type AM-4351/GR, \$195.00.

- An RF changeover relay with type N connectors and coaxial housing (similar to Dow-Key), good for 500 watts at 70 cm: Type #123-0100-400, \$12.95.

- An 8 foot diameter parabolic dish antenna, aluminum mesh, with 2 GHz feed-horn and yoke, but could be modified for 23 cm with little effort: Type AS-554/TRC, \$350.00.

- An SPDT (remote) coaxial switch with type LT connectors, rated to 1 kW through 5 GHz: Type #C14K2CA, \$27.95 new.

- Coaxial cable, MIL-R-17A ("mil spec") RG-8/U, new, \$200/1000 feet.

Not listed in their latest catalog, but previously procured from Fair Radio and probably available again in the future, are items like:

- A complete (minus power supply and blower) mixer/power amplifier for 1.3–1.8 GHz using 3 type 7289/3CX100 tubes, capable of generating 50 watts output on the 23 cm amateur band after minor modification: Type AM-3204A/TRC, about \$100.00.

- Tunable bandpass filters, cavity type, in ranges to cover all the VHF amateur bands; these are capable of handling a few hundred watts and exhibit 1 dB passband loss with steep skirts to reject adjacent bands: type F194/U covers 142–163 MHz, type F198/U covers 205–224 MHz, about \$22.00.

The list of unique gear goes on and on. I've used a lot of this stuff with great success. Some equipment requires minor repairs or modification, but most works fine nearly out of the box. Fair Radio has always been very "fair" with me, in that any complaints were quickly resolved to my satisfaction. There are other surplus houses, and I'm sure some of them are terrific, but Fair Radio goes out of their way to cater to amateurs and our crazy requirements. For their latest catalog, write to these folks at P.O. Box 1105, Lima, OH 45802.

## Rebel With a Cause: Rich Whiten, WB2OTK

I'm pleased for this opportunity to introduce Rich Whiten, WB2OTK, of Piedmont, SC to our readers. Having known Rich since 1970, the year he was first licensed, I know he is very dedicated to furthering the causes of amateur radio and VHF/UHF in particular.



*Rich Whiten, WB2OTK, sitting comfortably in his well-equipped VHF shack. Rich has worked all 50 states on 6 meters, plus 38 states on 2 meters, in just 2 years from his QTH in northwest South Carolina. He's also worked 24 states on 70 cm, using just 10 watts output power, since September 1984!*

Rich has operated the VHF bands for 15 years, first from Poughkeepsie, NY, then from Jacksonville, FL, and now from his South Carolina QTH in a rare grid square EM84. He's long been a 6 meter enthusiast. I remember the days when Rich installed a pair of stacked 6-element, 24 foot long Yagis on a tower mounted to the roof of his house near Poughkeepsie. As if that wasn't tempting fate enough, he followed with a 4-bay array of 16-element, 21 foot long Yagis for 2 meters (64 elements total) on that same roof tower! From a rather poor radio location apparently several hundred feet below average terrain, Rich proceeded to work all kinds of DX on 50 and 144 MHz, proving that dedication is probably the most important ingredient for success.

In the mid-1970s, I would stop by Rich's QTH in New York to see what new tomfoolery was engaging him, and we would spend an hour or so playing tennis,



# The DX is better out here. Ask anyone who owns an FT-726R.

It's true. Linking up to OSCAR 10 is the one sure way to bring the world into your ham shack. No matter where your shack is.

FT-726R owners know. You'll find them working the world from their apartments. Attics. And from their antenna-restricted neighborhoods.

They'll even boast of a signal quality and DX potential that would make any 20-meter operator envious. Regardless of where we are in the sunspot cycle.

In fact, the FT-726R is the world's most popular link to OSCAR 10.

And for good reason. This 2-meter, 10-watt rig gives you full cross-band duplex capability. Simply plug in two

optional modules, one for 435-MHz operation, another for cross-band duplex.

You can set up your earth station just about anywhere. All you need is the 726 and two Yagi antennas: 435-MHz for transmit and 2-meters for receive.

Even as a conventional base station, the FT-726R is a real standout.

You can choose from three operating modes: SSB, FM or CW. Expand to three-band operation with your choice of optional modules for 10 meters, 6 meters, 430-440 MHz and 440-450 MHz.

Then store your preferred frequencies and modes into the eleven memories for instant recall. With

pushbutton transfer capability to either of two VFO registers. And versatile scanning functions you'd expect from a Yaesu radio.

Plus you get a lot more extras, including a built-in speech processor, all-mode squelch and a noise blanker.

So no matter where your shack is, let Yaesu's FT-726R introduce you to OSCAR 10. The world is waiting.

## YAESU

**Yaesu Electronics Corporation**  
6851 Walthall Way, Paramount, CA 90723  
(213) 633-4007

**Yaesu Cincinnati Service Center**  
9070 Gold Park Drive, Hamilton, OH 45011  
(513) 874-3100

CIRCLE 136 ON READER SERVICE CARD



Prices and specifications subject to change without notice.



# TAKE THE CURE!

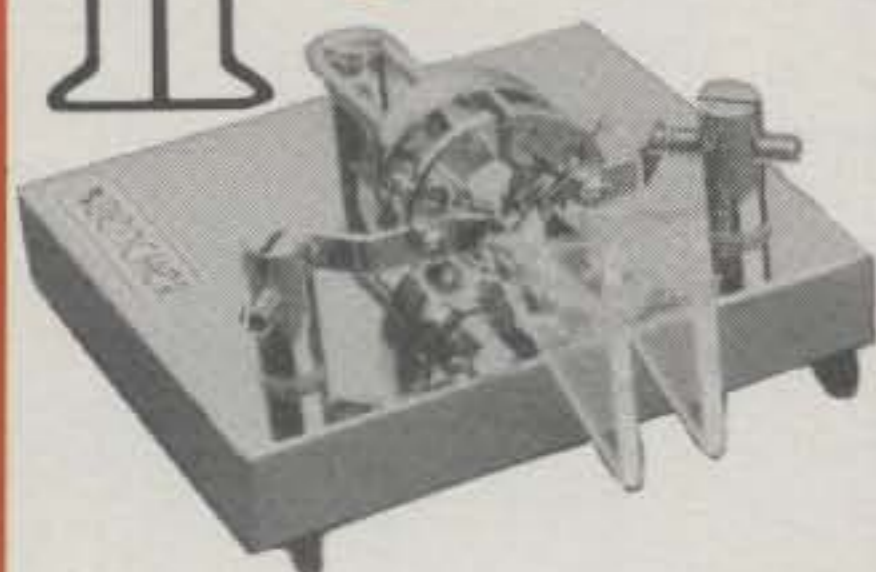

for boring QSO's and blah operating habits. A new Bencher paddle with the amazingly smooth response and perfect tracking that Bencher paddles are famous for is a sure cure for the blahs. Discover the joy that CW can be - see your dealer for one of the excitement machines.

At Bencher, we didn't invent CW— But we perfected it.

**BENCHER, INC.**

333 W. LAKE ST., CHICAGO, IL 60606—(312) 263-1808

CIRCLE 26 ON READER SERVICE CARD

## ANTENNA And TOWER ACCESSORIES IIX

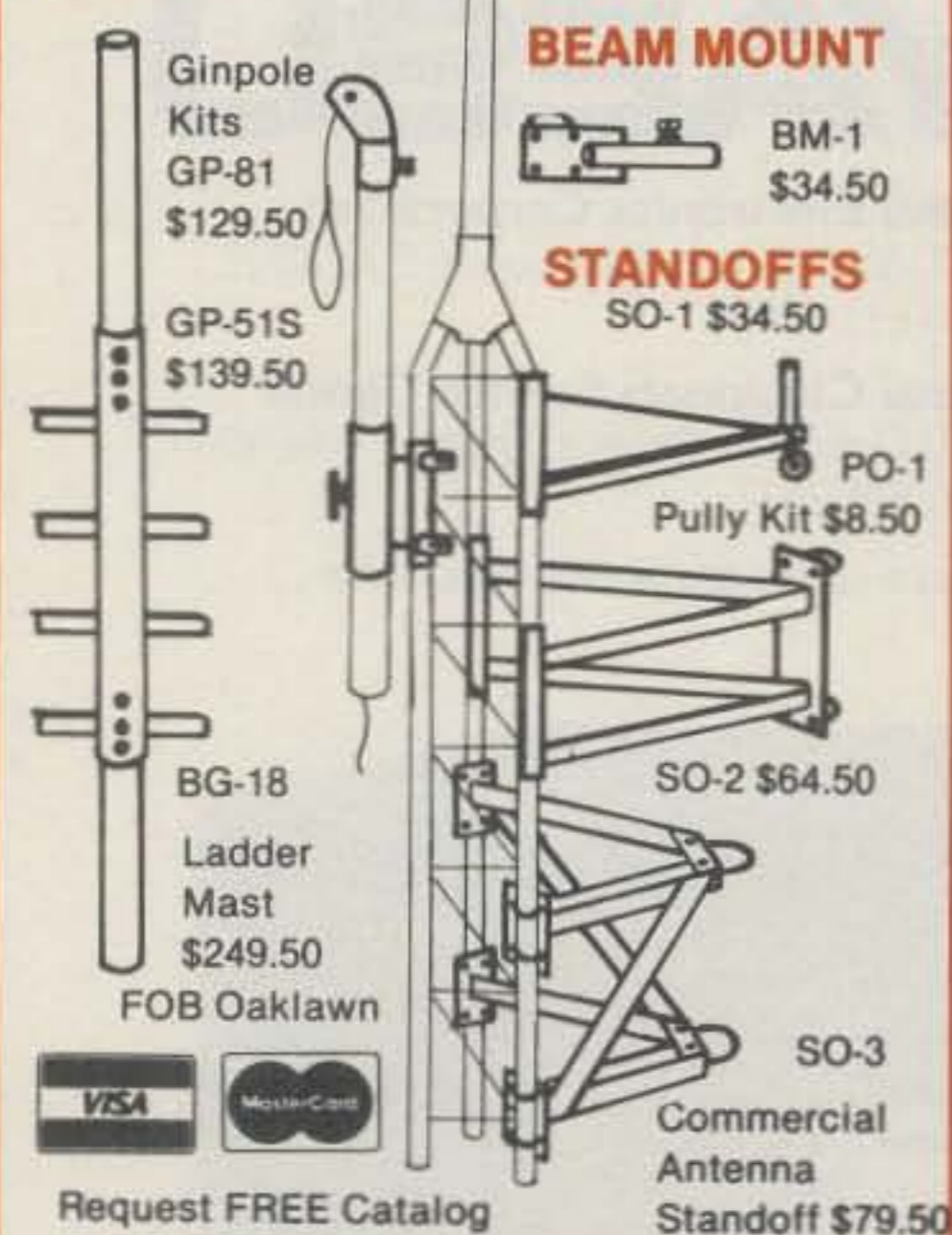

Request FREE Catalog

**NEW FREE CATALOG NOW AVAILABLE**

The 1985 Y-3 issue features new items just released that will solve your tower and antenna problems before the winter cold.

**IIX EQUIPMENT LTD.**

P.O. Box 9 Oaklawn, IL 60454  
(312) 423-0605

CIRCLE 48 ON READER SERVICE CARD

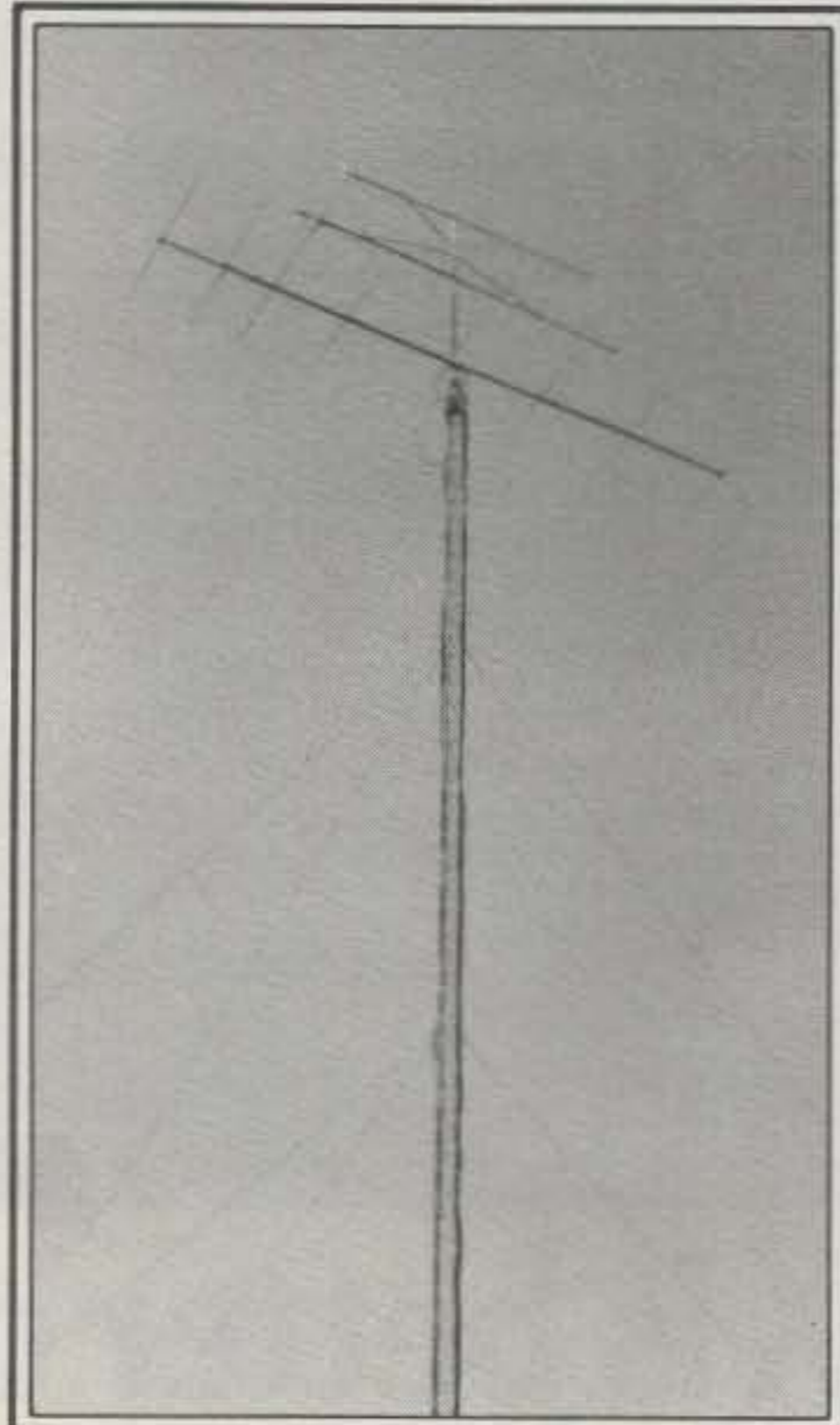

The 100 foot tower and VHF antennas at WB2OTK, Piedmont, SC. Rich has installed 8 elements (on a 37 foot boom!) for 6 meters at 100 feet, plus a 19-element "Boomer" for 2 meters at 115 feet and a 24-element "Boomer" for 70 cm at 125 feet. He had also planned to install 4 stacked 5-element beams at 20, 40, 60, and 80 feet, aligned northeast and fed in phase (16 dBd total gain) for 6 meter work in the CQ VHF WPX Contest. That should produce quite a signal.



Six and 2 meter amplifiers at WB2OTK/4. The lower unit is an 8877 and accompanying power supply for 144 MHz, and the unit sitting atop the rack cabinet is a 4-1000A for 50 MHz. Both run the legal power limit.

a game at which Rich excels and at which I'd usually be trounced. Then Rich moved to Florida, where he probably progressed even further with his tennis skills and where he began an exciting new career chasing (and working) more VHF E-skip than we Northerners are accustomed to hearing. Tiring of Jacksonville, the Whitens relocated once more, this time to the Greenville, SC area. In just two years, WB2OTK has worked 50 states on 6 meters and 38 states on 2 meters from his SC location. As if this weren't impressive enough, he's also worked 24 states on 70 cm as of this writing (mid-July) since September 1984, just 9 months ago. And all 70 cm work has been done with just 10 watts output!

All this success doesn't come without some work, and Rich has poured a good deal of effort into his antenna system: 8 elements at 100 feet for 50 MHz, 19 elements at 115 feet for 144 MHz, and 24 elements at 125 feet for 432 MHz, all fed with 7/8 inch hardline. Whiten has also spent a lot of time constructing high-powered amplifiers for the 50 and 144 MHz bands, where he runs the legal power limit. The station equipment at WB2OTK includes a Drake TR-6 transceiver for 6 meters, with any of 3 different legal-limit amplifiers (a 4-1000A, 8877 or pair of 4-400A's). The TR-6 drives a Drake TC-2 transverter and an 8877 amplifier for 144 MHz. The 432 MHz setup is a Drake TR-5 transceiver with a Microwave Modules MMT432/28S transverter. The 2 meter and 70 cm receiving converters are preceded by GaAsFET preamplifiers, and Rich intends to have a power amplifier for 432 by the time this reaches print.

To supplement his 6 meter antenna farm, Rich intends to install a 24-element array of four 6-element beams at 20, 40, 60, and 80 feet above ground, fed in phase and fixed toward the northeast. Although his home sits at a ground elevation of about 950 feet above sea level, Rich says this is not particularly high for the area. Sassafras Mountain, the highest point in South Carolina, is just 30 miles away, while Mt. Mitchell, North Carolina, the highest peak east of the Mississippi at 6684 feet, is just 75 miles to the north of Rich's location. Despite these obstacles, WB2OTK does very well on the VHF/UHF bands, having worked 31 states on 2 meters within 6 1/2 weeks of moving into his new home in Piedmont. Rich worked DX such as New Mexico (KA5EBL, some 1260 miles to the west) in his first few weeks on 144 MHz, and was busy working Minnesota on 432 MHz when I called him on the telephone the evening of July 8 to advise him that 2 meters was open! Some guys have all the luck.

WB2OTK was recently the subject of some unfortunate publicity regarding numerous TVI complaints against him received by the FCC's Atlanta field office. The TVI was apparently the result of Rich



# the HAM STATION

220 N. FULTON AVENUE  
P.O. BOX 4405  
EVANSVILLE, INDIANA 47710

LARGE STOCK OF NEW EQUIPMENT  
AT DISCOUNT PRICES

Orders 1-800-523-7731  
Indiana (812) 422-0231  
Info & Service (812) 422-0252

CALL FOR PRICES ON  
EQUIPMENT FOR OSCAR 10  
PRICES AND AVAILABILITY SUBJECT TO  
CHANGE. FREIGHT FOB EVANSVILLE.

**ACC**  
Shack Master 100 in stock call

**AEA**  
ATU-1000-Superb interface \$1100.00  
CP-100 Deluxe interface CALL  
CP-1 interface 189.95  
MP-1 Micropatch 129.95  
MBA-TOR Software CALL  
DR DX DR QSO 99.95  
PKT-1 Packet Controller 459.95  
Morse University for C-64 39.00  
Isopoles, Hot Rods, Software in Stock

**ALINCO**  
Amplifiers in stock CALL

**ASTRON**  
RS7A 5-7 Amp \$ 49.00  
RS10A 7.5-10 Amp 59.00  
RS12A 9-12 Amp 69.00  
RS20A 16-20 Amp 89.00  
RS20M 16-20 Amp w meter 109.00

**ASTRON**  
RS35A 25-35 Amp 135.00  
RS35M 25-35 Amp w meter 149.00  
RSS0A 37-50 Amp 199.00  
RSS0M 37-50 Amp w meter 225.00

**BENCHER**  
BY-1 Black Chrome By-2 Chrome \$39.49.00  
ZA-1A Balun 19.00

**B & W**  
370-15-80-10M Folded Dipole \$145.00  
AT-110-5 Band Trap Dipole 76.00  
AT-55 4 Band Trap Dipole 58.00  
Various Antennas & Coax Switches in Stock

**Butternut**  
HF38-Butterfly Compact Beam \$179.95  
HF6 80-10M Vertical 119.95  
HF2V 80-40M Vertical 115.00  
TBR-160-S 160M Resonator 49.00  
HF4B 20.14.12.10M Beam 195.00

**Cushcraft**  
A4 Tribander \$269.00  
A3 Tribander 215.00  
A147-11 2M11EL 49.00  
A449-11 450 MHZ 44.00  
215WB 2M Jr. Boomer 79.00  
230WB Stacked 215's 219.00  
32-19 Boomer 19EL 2M 95.00  
AOP-1 OSCAR PKGE 149.00  
Ringo Rangers 2M 6M, 220 450 39.95

**DAIWA**  
CN-520 1.8-60 MHZ Mtr \$ 63.00  
CN-620B 1.8-150 MHZ Mtr 110.00  
CN-630 140-450 MHZ Mtr 129.00  
CN-410M 3.5-150 MHZ Mtr 65.00  
CS-201 2 Pos. Switch 23.00  
CS-401 4 Pos. Switch 63.00

**ENCOMM**  
NEW FM-240 25W FM Xcvr CALL

**HAL**  
Computer interfaces & dedicated Terminals

**NEIL**  
Products in Stock CALL

**HUSTLER**  
G-7-144 MHZ Vertical \$119.95  
G-6-144B 2M Vertical 85.95  
G-6-440 MHZ Vertical 109.95  
6BTU-80-10M Vertical 129.95  
Mobile HF & VHF Antennas in Stock

**HYGAIN**  
TH7DXS 7EL Tribander \$479.00  
Explorer 14 3EL Tribander 329.00  
QK710 30 40 Mtr Kit 85.00  
Discoverer 2-EL 40 Mtr 339.00  
18HTS 80-10M Vertical 439.00  
18AVT WBS 80-10M Vertical 109.00  
14AVD WBS 40-10M Vertical 75.00  
2 Mtr Beams in Stock CALL  
V2, V3, V4-2M, 220, 440 Verticals CALL  
287 2 Mtr. Mag. Mnt 26.00

**ICOM**  
751 Top of the Line \$1179.00  
735 Simply Fantastic Xcvr 749.00  
1271 1.2 GHZ Base Xcvr Coming Soon  
271A H 2M All Mode CALL  
471A H 430-450 All Mode CALL  
27A H 2 Mtr Mobiles CALL  
37A 220 MHZ Mobile CALL  
47A 440 MHZ Mobile CALL  
3200 Dual Band 144 & 440 CALL  
Q2AT Q4AT 2 Mtr -440 MHZ H.T.'s 229.95  
3AT 4AT 220 MHZ-440 MHZ H.T.'s 199.95  
2AT 2 Mtr. H.T.  
R71A Commercial Grade Receiver  
Huge Inventory of Accessories & Radios

**KANTRONICS**  
Packet Communicator \$219.00  
UTU Universal Terminal Unit 179.95  
Interface II Deluxe Interface 229.95  
Challenger economical interface 89.95  
Lots of Software in Stock - CALL

**KLM**  
2M-14C 2M Circular Ant. w CS-2 \$ 85.00  
2M-22C 2M Circular Ant. w CS-2 120.00  
435-18C Circular Ant 65.00  
435-40CX Circular Ant w CS-2 149.95  
CS-2 Circularity Switch 55.00  
2M-16LBX 2 Mtr Yagi 105.00  
432-30LBX Yagi 99.75

**LARSEN**  
NLA-150 220 450 Mag. Mnt \$ 42.95  
NLA 2 70 Dual Band Mag. Mnt 59.95

**MFJ**  
1229 interface free Software \$159.95  
1224 interface free Software 85.00  
1228 interface free Software 59.95  
969 3KW Roller inductor tuner 289.95  
949C 300 W Tuner w D Load 135.00  
941D 300 W full feature tuner 89.95  
204 Antenna Bridge 71.95

**MIRAGE**  
B1016 10 160W-Preamp \$249.95  
B3016 30 160W-Preamp 204.95  
B23A 2 30W-Preamp 89.95  
D1010N 10 100W 430-450 MHZ 289.95

**NYE**  
MB-V-A The Ultimate Tuner \$499.95

**SHURE**  
444D Hi-Lo Z Desk Mic \$55.00

**TEN-TEC**  
NEW Corsair — Very Nice CALL  
Century 22 CW Xcvr \$ 349.95  
2510 Satellite Station 409.95  
Titan — Your Last Amplifier 2175.00

**TOKYO HY-POWER**  
HL 30V 3 30W Amp \$ 62.95  
HL35V 3 30 Amp w Gasfet 75.00  
HL160V 3 10-160W Amp 295.95  
HL 160V25 25-160W Amp 259.95  
HL-20U 430-449 MHZ 3 20W Amp 105.95  
HL 120U 430-449 MHZ 10 100W Amp 319.95  
HC-2000 2KW Tuner 295.95  
HC 400L Tuner w Dual Needle Mtr 175.95  
HRA-2 2 Mtr. Gasfet Preamp 119.95  
HRA-7 70 CM Gasfet Preamp 119.95

**YAesu**  
FT-980 Deluxe Xcvr \$1425.00  
FT-757 Gen. Cov Xcvr CALL  
FT-757H D.P.S. w fan 175.00  
FT-757AT Autotuner 235.00  
FT-726R Multi Band Xcvr CALL  
FT-270R 45W 2 Mtr 375.00  
FT-270RH 2 Mtr 440MHZ 489.95  
FRG-8800 HF Communications Rcvr 499.95  
FRG-9600 60-960MHZ Scanning Rcvr Call  
Large Stock of Accessories

**WELZ**  
Mtrs, Antennas, Duplexers in Stock

**ROTATORS**  
Alliance HD-73 \$115.00  
Alliance U-110 49.95  
Telex CD-45 149.00  
Telex Ham 4 239.95  
Telex T2X 269.95  
Ken Pro KR500 KR5400 KR5600 CALL

CALL FOR PRICES ON  
EQUIPMENT FOR OSCAR 10  
Send SASE for our new & used equipment list.  
MON-FRI 9AM-6PM • SAT 9AM-3PM

## FULL BREAK-IN WITH ANY AMPLIFIER

IF YOU OWN A  
QSK TRANSCEIVER



Don't be limited to low power operation with your expensive full break-in transceiver. You can run high power QSK CW and high power AMTOR.

The DEO QSK 1500 is designed using the latest in solid state switching technology and will give you full break-in operation with any one of the currently available commercial amplifiers, homebrew too! Pin diodes provide ultra high speed, noiseless switching. All you need to do is connect two RF cables and two control cables, turn it on and you are ready to go, up to 1500 watts at 1.5-1 VSWR. Fully automatic bandswitching, 1.8 - 30 MHz and mode selection, either CW or SSB, no cables to change. The QSK 1500 eliminates amplifier damage due to "hot switching" and gives you full receiver performance with an insertion loss less than .7 dB, typically .2 dB.

90 day limited warranty.

For More Info Send QSL

Come See Us At The Dayton Hamvention Booth #347

**\$299.00**



DESIGN ELECTRONICS OHIO

4925 S. HAMILTON RD. GROVEPORT, OHIO 43125

Please add \$6 for shipping and handling (US only. Foreign FOB Groveport)

New for  
**KENWOOD** TH-21A, 31A, 41A  
a *Fastcharger* by  
**Charge-Rite**  
safely charges in 15 minutes



INTRODUCTORY  
PRICE

**\$54.95**

+ \$3.00 shipping and handling  
FL res. add 5% sales tax

### Features:

- Charges in 15 minutes
- Constant Current
- Automatic Voltage cut-off
- Battery doesn't heat-up
- 12v-14vdc input
- Charge from any point in discharge cycle without developing "memory"
- Proven in daily use

Optional AC adapter with DC and mobile cords available \$19.95.

**Charge-Rite**

P.O. Box 17015-C  
Plantation, Florida 33318  
305-475-0545

transmitting on 2 meters at any power level, with any equipment, and Rich is totally convinced the problem lies with the local cable operator's lack of effective shielding and decoupling within his system. Whiten says the cable leakage (RF radiation) in his neighborhood is a real problem which noticeably degrades his own 144 MHz receiver's ability to detect weak signals. I hope that by the time this is published, all of Rich's (and his neighbors') TVI problems are solved.

### The First Annual CQ WW VHF WPX Contest

This is being written only a few days after our first CQ VHF WPX Contest, and I have not as yet received comments from participants, other than the few heard on the air during the contest. I had reported in the July column that I'd personally be active with a multi-op group in northern New Jersey, using the call K2XR. Well,

this turned out to be half true. I was active from New Jersey, but we decided to use the call NV6O/2, a much "rarer" prefix than K2! Eric, NV6O, is a new member of our S.C.O.R.E. contest club, and he is a permanent NJ resident. Using his call seemed only proper for a prefix contest, and I'm glad we had the opportunity to be "rare" in a VHF contest. We set up a multi-multi QRO (high power) station at the QTH of KC2PX in Belle Mead, NJ and made 672 QSO's with (preliminary count) 217 prefix multipliers for a total score of about 170K points.

The WPX Contest was a lot of fun for us. We had some terrific tropo on 2 meters Friday night and made numerous contacts with Ohio, Kentucky, North Carolina, and South Carolina, all areas more than 400 miles distant. Saturday offered excellent E-skip on 6 meters, allowing us to work nearly all the 48 continental states during the 4-hour opening. We had good meteor scatter Saturday morning,

making a dozen m.s. QSO's in one hour on 50 MHz. Ironically (but not surprisingly), our first scatter contact was with WB2OTK/4 in South Carolina. The weather was very hot and humid here in the northeast, and we took advantage of KC2PX's in-ground swimming pool to cool off when activities slowed down.

We were disappointed with activity on 220 MHz (what else is new?), where we made a measly 16 QSO's during the contest period. Of course, some of this poor performance was our own fault. During the Friday evening activity hour, our 220 MHz receiving converter wasn't connected (pilot error). At NV6O/2, we made 257 QSO's on 6 meters, 331 QSO's on 2 meters, 54 QSO's on 432, and 14 QSO's on 1296, in addition to the 220 total reported. I was very happy to hear NA1L—a good prefix—on the air, operated by W1XX of the ARRL. K1TR, AA2Z/1, and a few others were expending great effort to work up good totals from New England. WS4F in Georgia and W5HUQ in Florida were very active on 6 meters and had good totals when last heard. KQ3R in Pennsylvania was doing a wonderful job on all five bands: this is Tom Waldrin, proprietor of the VHF Shop, a CQ advertiser.

I heard some complaints during the contest: too long a contest period; not enough promotion; not enough activity; date too close to the ARRL contests; and so forth. These are good inputs, and I hope some of these comments are reported in writing from participants. A brand-new contest can't be perfect, and we didn't expect it to be. But we were gratified at the activity levels, especially considering the intense heat of the weekend, and look forward to making constructive changes in the contest. If you have not yet made known your comments re the VHF WPX contest, please write to us and tell us what you think.

**HI-VOLTAGE RECTIFIERS**  
14,000 VOLTS - 1 AMPERE

REPLACES 866-872 3B28 ETC. IDEAL FOR 2 KW. LINEARS 250 A. SURGE

**4 FOR \$20.00 POSTPAID**  
K2AW's "SILICON ALLEY"

175 FRIENDS LANE WESTBURY, N.Y. 11590

Please send all reader inquiries directly.

**NEW 20-PAGE CATALOG FREE**

**7 MILLION TUBES**

Includes all current, obsolete, antique, hard-to-find receiving, transmitting, industrial, radio/TV types. **LOWEST PRICES.** Major brands in stock.

Unity Electronics Dept.  
P.O. Box 213, Elizabeth, N.J. 07206



CIRCLE 51 ON READER SERVICE CARD

**When Bobby Jones  
wants to call home,  
he pushes one button.**



### THE CES MICRODIALER

- 21 digits per memory
- 10 number autodial
- 20 digit last number redial
- Field programmable ANI



**Communications Electronics Specialties, Inc.**  
P.O. Box 2930, Winter Park, Florida 32790  
Telephone: (305) 645-0474

Or call toll-free (800) 327-9956 ext. 272 (Orders Only Please)

### A Plea

Readers have written asking why this column favors reports about east-coast operators and happenings. This question deserves an answer. It is because I can only report on what I receive from readers! Please, wherever you live, write to me and let me know what's going on in your area. Tell me about your own station, activities, local band conditions, anything. Let me know if you've purchased a piece of VHF/UHF equipment with which you are especially pleased—or displeased—and tell me why. Inform us of your homebrew projects and developments. Send photographs! Your correspondence needn't be formal. Jot something on a postcard, a QSL card, a piece of tree bark. If the information is readable and interesting, I'll do my best to include it in this column. Thanks.

73, Steve, WB2WIK

CIRCLE 19 ON READER SERVICE CARD



Uncle Ben says...

**"I give you  
much more than  
just the lowest price..."**

When you get that exciting new piece of equipment *from me*, you know you are going to be completely happy... I see to it, personally! I also give you earliest delivery, greatest trade-in allowances, my friendly assistance in every possible way.

Just ask any of the many thousands of hams all over the world who have been enjoying my friendly good service for over a half a century.

73, Uncle Ben, W2SOH



"Uncle Ben" Snyder, W2SOH  
the head man of

**HARRISON**

"HAM HEADQUARTERS,  
USA®" ...Since 1925!

• **CALL ME...**

(516) 293-7995

**HARRISON**

**HAS THEM ALL!**

**KENWOOD**

• **WRITE ME...**

For my prompt,  
personal reply.

• **SEE ME...**

At one of the world's largest  
Ham Supply Centers!



Kenwood TH21AT, 31AT, 41AT



Kenwood TR-7950/7930



Kenwood TS-940S



Kenwood TS-430S



Kenwood TR-2600, TR-3600



Kenwood TS-711A (2m)  
TS-811A (70 cm)



**HARRISON** RADIO

...Since 1925!

CHARGE IT!

"HAM HEADQUARTERS, USA"

2263 Route 110 (at Smith St.)  
E. Farmingdale, NY 11735

1-(516) 293-7995

# MISSOURI RADIO CENTER

## ANTENNA SALE

### HYGAIN TOWERS

HG37SS	CALL	
HG52SS	CALL	
HG54HD	CALL	
HG70HD	CALL	

### CUSHCRAFT

A3	209.00
A4	275.00
R3	255.00
40-CD2	275.00
AV5	96.00
32-19	89.00
215WB	75.00
ARX2B	35.00
A144-11	46.00
A144-20T	69.00
424B	75.00
AOP-1	137.00

### KLM

KT34A	329.00
KT34XA	475.00
432-20LBX	64.00
432-30LBX	90.00
435-18C	109.00
435-40C	149.00
2M-13LBA	77.00
2M-14C	85.00
2M-16LBX	89.00
2M-22C	115.00

### HYGAIN

TH3JR	CALL	
TH7	CALL	
EX 14	CALL	
14AVQ	CALL	
18AVT	CALL	
V2	CALL	
V3	CALL	
V4	CALL	

### HUSTLER

25% OFF ALL MOBILE	
6BTV	125.00

### AEA

144SR	42.00
-------	-------

### BUTTERNUT

HF6V	110.00
HF2V	110.00

RG213U	\$.26/foot
--------	------------

### ROTATORS

CD45	139.00
HAM IV	228.00
T2X	275.00

AVANTI 2M	29.95
HI-Q BALUN	9.95

### KENPRO

KR400	119.00
KR500	149.00
KR600	199.00
KR5400	249.00

2900 N.W. VIVION ROAD  
KANSAS CITY, MISSOURI 64150  
816-741-8118

CALL TOLL FREE  
1-800-821-7323

MASTERCARD, VISA & C.O.D.'s WELCOME

# Announcing

•**Radio Exams in Wilbraham, MA** – The Hampden County Radio Assn. will administer exams for all classes of amateur radio license on October 18th at the Hampden-Wilbraham Regional High School, 621 Main Street, Wilbraham, Massachusetts at 9 am. Interested candidates should obtain form 610 by writing to the club. If you currently hold an amateur radio operator's license, you must bring the original and a copy. There is a \$4.00 charge to test above the beginner's level. Make checks payable to the "ARRL/VEC." Completed applications should be mailed to: Yorke Phillips, 235 Ames Rd., Wilbraham, MA 01036. You may also sign up that day (arrive at 8:30 am). If you are interested in becoming a radio amateur, classes will be held in the fall. Drop a postcard with name, address, and phone number to Hampden County Radio Assn., P.O. Box 482, West Springfield, MA 01090.

•**Association of Latin American Radio Experimenters** – This national organization of amateur radio experimenters is open to hams who can speak Spanish or Portuguese as natives and want to communicate with each other in these languages. The group is seeking members across the country to open chapters. Various nets are being established nationwide and charter members will be given special recognition. For information send SASE to Dr. Richard A. Sandell, WD6EXJ, Executive Director, ALARE, 2250 Boston Post Road, Larchmont, NY 10538.

•**Amateur Radio Classes in Agawam, MA** – Radio classes being sponsored by the Hampden County Radio Assoc. at the Agawam High School will be held this fall for the Novice, Technician, General, Advanced, or Extra class licenses. There is no charge for the course, but you must purchase the textbooks, which cost under \$10. Classes will last for ten weeks, meeting once per week from 7–9 pm. Testing for all license grades will conclude the course. To find out more or to sign up, contact Art Zavarella, at 413-786-9115, or drop a card to Hampden County Radio Assoc., P.O. Box 482, West Springfield, MA 01090. (Include your phone number.)

•**Hermiston ARC's KD7LC** – KD7LC will be on the air from Hat Rock State Park, OR on Oct. 12 from 1800–0100Z and Oct. 14 from 1800–2200Z on the General phone and Novice CW bands, with some 2 meter and 440 MHz operation. Send contact number and a 9x12 SASE for a certificate to HARC, P.O. Box 962, Hermiston, OR 97838.

•**Lexington, North Carolina** – The Healing Springs Mtn. VHF Society will operate WD4BBQ for the Lexington Barbecue Festival on Oct. 26 from 1300Z–2100Z on 40, 20, and 15. Phone: 25 kHz up from edge of General class band. Novice band: 7125 kHz as time permits. Also area 2M repeaters. Special Bar-B-QSL. SASE only. Mail to: Healing Springs Mtn. VHF Society, P.O. Box 41, Lexington, NC 27293-0041.

•**Dutch Amateurs From Guernsey** – From Oct. 23–30 the following Dutch amateurs will be active from Guernsey (GU0): PA0TUK, PA2FAS, PA3AWW, PA3CJF, and PE1FNB. They will use the callsign GU0/PA2FAS and work all bands from 10–160 meters, both CW and phone. Crossband, WARC band, and split on request. QSL via: DAGOE, P.O. Box 356, Dordrecht, Holland or via PA-buro.

•**WD4KOW From Sunbelt Expo** – The Colquitt County Ham Radio Society will operate club station WD4KOW from the site of the Sunbelt Agricultural Exposition on Oct. 15, 16, and 17 from 0900 to 1700 EDST each day. The Sunbelt Expo is held at Spence Field Airbase, near Moultrie, Georgia. Operations will be in the general portion of the HF bands. The members will also be on the local repeater 146.19/79. A special QSL card is available for those making contact during this event and submitting a SASE to Colquitt Ham Radio Society, P.O. Box 813, Moultrie, GA 31776.

•**Hot-Air Balloon Fiesta** – The annual International Hot-

Air Balloon Fiesta at Albuquerque, New Mexico will be Oct. 5–13. Special-event station KN5D will be operating on 29.600 FM, 28.625, 21365, 14.285, 7280, 3940, or 1840 kHz SSB. They also plan to operate a Gateway station through OSCAR 10 on 145.885–145.895, conditions permitting. QSL to KN5D, P.O. Box 997, Corrales, NM 87048.

•**W3DQI From Laurel, MD** – The Laurel Amateur Radio Club will operate special-event station W3DQI from 1500–2230Z to celebrate the anniversary of the restoration of the Montpelier Cultural Arts Center in Laurel, MD. Frequencies: lower 25 kHz of General bands on 75, 40, and 20 meters. Also 147.54 MHz simplex. Send SASE for 8" x 11" certificate. QSL to LARC, P.O. Box 91, Annapolis Junction, MD 20701.

•**The following hamfests, etc., are slated for October:**

Oct. 4–6, **1985, ARRL National Convention**, Louisville, KY. Contact the Greater Louisville Hamfest Assn., P.O. Box 34444, Louisville, KY 40232 (502-368-6657).

Oct. 5, **9th Annual Mid-Atlantic VHF Conference**, Warrington, PA. Contact Hamarama 85, P.O. Box 311, Southampton, PA 18966, or call Lee A. Cohen, K3MXM, at 215-635-4942.

Oct. 5, **RAGS Hamfest**, New York State Fairgrounds, east of Thruway Exit 39. Contact Viv Douglas, WA2PUU, P.O. Box 88, Liverpool, NY 13088.

Oct. 5, **CQ Radio Club of Torrington, Fleamarket**, Watertown, CT. Contact Donald D. Taylor, KA1GKJ, P.O. Box 455, Watertown, CT 06795.

Oct 5–6, **Mississippi Coast ARA Hamfest**, Biloxi, MS. Contact Mississippi Coast ARA, P.O. Box 1785, Gulfport, MS 39501.

Oct 6, **Yonkers Electronics Fair and Fleamarket**, Yonkers, NY. Contact Yonkers ARC 914-969-1053.

Oct. 6, **Computer Central Show and Swap Meet**, Des Plaines, IL. Contact Computer Central, 1506 Central Ave., Deerfield, IL 60015.

Oct. 6, **Springfield Hamfest and Computer Expo**, Springfield, OH. Contact Independent Radio Assn., 513-322-8236.

Oct. 6, **Southeast Iowa Hamfest**, West Liberty, IA. Contact Tom Kramer, KE0Y, 905 Leroy St., Muscatine, IA 52761 (319-264-3259).

Oct. 13, **Lima, Ohio Hamfest**, Lima, OH. Contact NOARC, Box 211, Lima, OH 45802.

Oct. 13, **Ham Fair 85**, Lansing, MI. Contact Rowena Elrod, KA8OBS, 111 Lancelot Place, Lansing, MI 48906 (517-482-9650).

Oct. 19, **Tri-Cities Hamfest**, Gray, TN. Contact Tri-Cities Hamfest, P.O. Box 3682 CRS, Johnson City, TN 37601.

Oct. 19, **SPARC Swapmeet and Packet Exhibit**, Lee County Fairgrounds, Opelika/Auburn, AL. Contact Ray at 205-745-2838.

Oct. 19, **Austin ARC Fall Swapfest**, Manchaca, TX. Contact Jim Strohm, KA5UXC, 1743 Cricket Hollow Dr., Austin, TX 78758 (512-837-5423)—SASE.

Oct. 26, **Tri-City ARC Auction**, Poquonock, CT. Contact WA2RYV at 203-464-6555.

Oct 26–27, **Hamarama 85**, Lake Texoma, OK. Contact Texoma Hamarama Assn., P.O. Box 610892, DFW Airport, TX 75261.

Oct. 26–27, **Hamfest Chattanooga**, Chattanooga, TN. Contact Hamfest Chattanooga, P.O. Box 3377, Chattanooga, TN 37404, or call N4DON at 404-820-2065.

Oct. 27, **Kalamazoo ARC Hamfest**, Kalamazoo, MI. Contact KA8RUA, 2825 Lake St., Kalamazoo, MI 49001.

Oct. 27, **Heart of Ohio Ham Fiesta**, Marion, OH. Contact Ed Margraff, KD8OC, 1989 Weiss Ave., Marion, OH 43302 (614-382-2608).

Oct. 29, **RF Hill ARC Hamfest**, Sellersville, PA. Contact Robert Garland at 215-674-4800 (ext 515, days) or 215-721-0278 evenings.

Nov. 1, **Hampden County Radio Assn. Radio/Electronics Auction**, Feeding Hills, MA. Contact Ron Beauchemin at 413-739-5228.

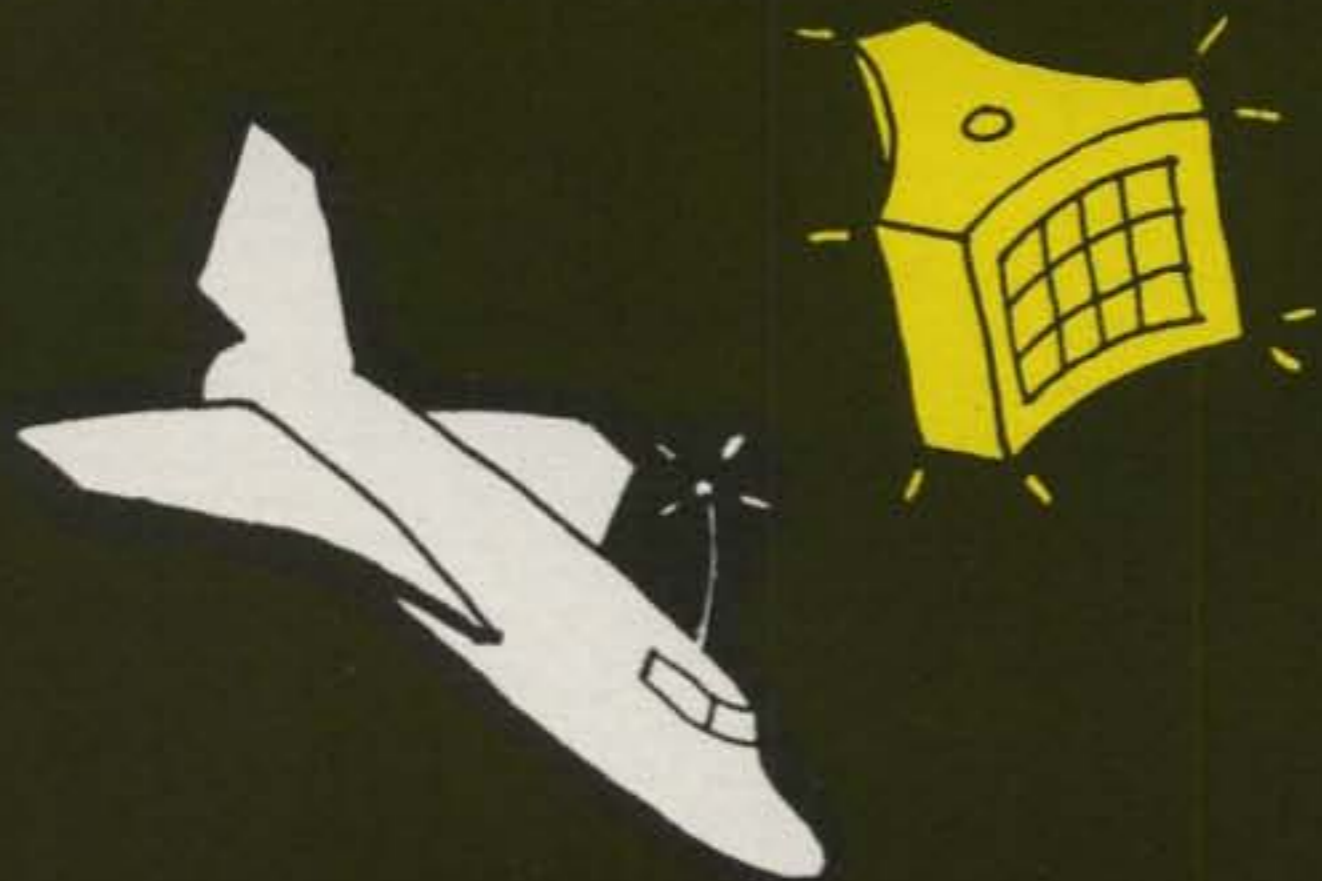

EVERYONE'S  
GOING TO

LAS VEGAS

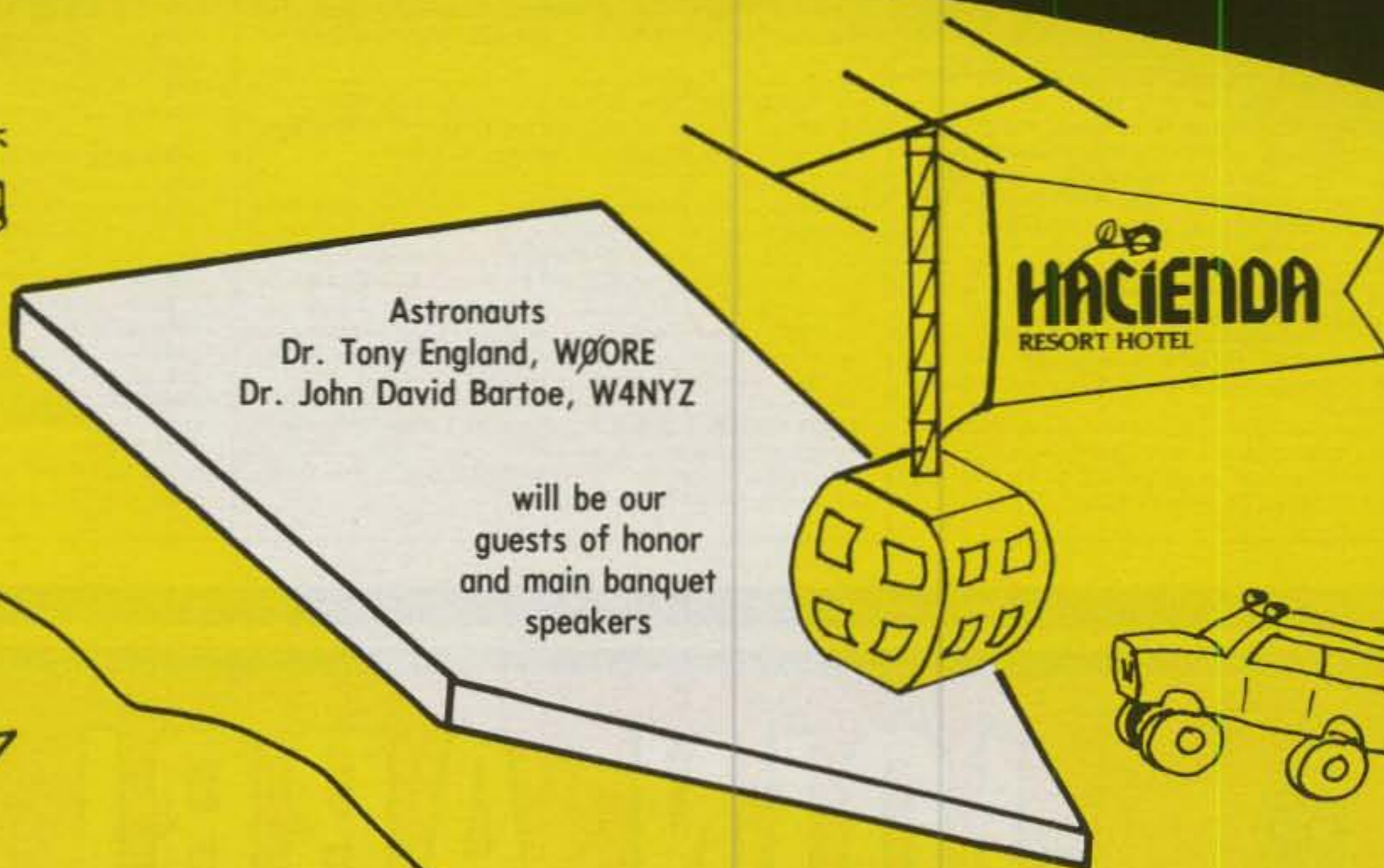

Astronauts  
Dr. Tony England, WØORE  
Dr. John David Bartoe, W4NYZ

will be our  
guests of honor  
and main banquet  
speakers

HACIENDA  
RESORT HOTEL

# OCTOBERVENTION!

We're launching Amateur Radio into the future with how-to-do-it forums on Packet Radio, OSCAR, Amateur TV, Moonbounce, VHF/UHF Tropo Openings, How to Prepare for FCC Exams, Belize DXpedition, Regulatory Issues, NTS, YL, and much more. Plus FCC exams, ARRL, MARS, QCWA, YLRL, exhibits, flea market, banquet, and cocktail party!



*Pacific  
Division  
Convention  
Oct. 31 - Nov. 3*

Registration \$15  
Banquet \$15  
Flea Market spaces \$10  
Rooms \$48, tax included.  
Airline discounts,  
call 1-800-634-6705.  
Late registration and other  
info call 702/361-3331.  
(Room rates and air fares  
subject to availability  
after October 1.)

OCTOBERVENTION, Dept. 600, P.O. Box 19675, Las Vegas, NV 89132

# Ham Shop

## FREE TO CQ SUBSCRIBERS

**Advertising Rates :** Non-commercial ads are 20 cents per word including abbreviations and addresses. Commercial and organization ads are 60 cents per word. Minimum charge \$2.00. No ad (non-subscriber) will be printed unless accompanied by full remittance. Non-commercial ads free to CQ subscribers, as space permits, maximum 3 lines each. All ads must be typewritten double spaced. Recent CQ mailing label must accompany ad.

**Closing Date:** The 10th day in the third month preceding date of publication. Because the advertisers and equipment contained in Ham Shop have not been investigated, the Publisher of CQ cannot vouch for the merchandise listed therein. Direct all correspondence and ad copy to: CQ Ham Shop, 76 N. Broadway, Hicksville, NY 11801.

QSLs & RUBBER STAMPS—Top Quality! Card Samples and Stamp Information 50¢. Ebbert Graphics D-2, Box 70, Westerville, OH 43081.

IMRA-International Mission Radio Assn. helps missionaries—equipment loaned; weekday net, 14.280 MHz, 2:00-3:00 PM Eastern, 1 Pryer Manor Rd., Larchmont, NY 10538.

KNOW FIRST! Ham radio fanatics—you need THE W5YI REPORT, a twice-monthly award-winning Hot Insider Newsletter. Acclaimed best! Confidential facts, ideas, insights, nationwide news, technology, predictions, alerts. Quoted coast-to-coast! We print what you don't get elsewhere! \$18.00 annually w/money-back guarantee! FREE SAMPLE for S.A.S.E. (two stamps). W5YI, Box 10101-C, Dallas, Texas 75207.

FOR SALE. CQ/Ham Radio/QST/73 magazines @ 35¢ (thru 1975) and 50¢ (1976-up) each, including shipping. W6LS, 2814 Empire, Burbank, CA 91504.

CERTIFICATE for proven contacts with all ten American districts. SASE to W6LS, 2814 Empire, Burbank, CA 91504 brings data sheet.

CLANDESTINE CONFIDENTIAL NEWSLETTER: Latest info on secret broadcasters. Six issues \$10 US, \$13 foreign, US funds. RR4 Box 110, Lake Geneva, WI 53147.

CHASSIS AND CABINETS KITS: SASE K3IWK.

AAA Wanted: Radio Tubes (2A3, 45's, 50's, 202, 211, 845, VT-52, VT-62). Western Electric Tubes, Amps, Mixers, Consoles, Tweeters, Drivers, Horns, Speakers, Parts, etc. Tannoy Speakers & McIntosh or Marantz Tube-Type Amps. Tel: 818-576-2642. David Yo, P.O. Box 832, Monterey Park, CA 91754.

HALLICRAFTERS Service Manuals. Amateur and SWL. Write for prices. Specify Model Numbers desired. Ardco Electronics, P.O. Box 95, Dept. C, Berwyn, IL 60402.

AMATEUR radio exhibit of National, Hallicrafter, and other early receivers, including broadcast. Early parts and tubes. Spark and tube-type transmitters, telegraph station, and keys. Write: Bruce Kelley, W2ICE, RD #3, Holcomb, NY 14469.

WANTED: Older model bugs, unusual bugs, and miniature hand keys. State price, condition. Dave Ingram, K4TWJ, Rt. 11, Box 499 #1201 South, Birmingham, AL 35210.

QUADS \* QUADS \* 2, 3 & 4 Element Kits. Also components, Fiberglass Spreaders, Spiders, Wire, etc. (3) \$.20 stamps for complete brochure. db + ENTERPRISES, Box 24, Pine Valley, NY 14872, phone 607-739-8480.

CLIMBING BELTS: OSHA Certified nylon web belt with adjustable lanyard. \$54.95 plus \$3 UPS. John Limbach, K8NN, 7397 S. Platte Canyon Drive, Littleton, CO 80123.

CODE PRACTICE SOFTWARE: IBM-PC random code 5-22 WPM \$3.00. N4CWP, 4315 S. 12th Rd., Apt. 21, Arlington, VA 22204.

COMPUTER PROGRAMS for C-64. Menu driven logs for BCL/SWL. Update formats, QSL records, other. Disk or tape. Screen/printer. Send SASE for info & sample. W3GMG, P.O. Box 5624, Baltimore, MD 21210.

C-64 HAM SOFTWARE: Headings, MUF, Morse Trainer/Practice. Send SASE for information. ULTRA HAM SOFTWARE, Box 119, Macedonia, OH 44056.

CASA MARCONI, INC. Pre-owned communication equipment. We buy and sell. 7189 S.W. 8 St., Miami, FL 33144, phone 305-264-8443.

HAM TRADER YELLOW SHEETS, in our 24th year. BUY, SWAP, SELL Ham Radio gear. Published twice a month. Ads quickly circulate—no long wait for results. SASE for sample copy. \$10.00 for one year (24 issues). P.O. Box 356, Wheaton, IL 60189.

HAVE AM CAPABILITY? Join SPAM (Society for Promotion AM). Membership is free. For free info send SASE to: SPAM, c/o F. Dunlap, WASTWF, 14113 Stoneshire, Houston, TX 77060.

THE CANADIAN AMATEUR magazine carries up-to-date Canadian regulations for DXpeditioners to VE/VO/VY, columns on DX, AMSAT, VHF/UHF, Microwaves, packets, contests. Technical projects, serialized books, tutorials. Eleven issues \$20, Box 855, K6A 3C9 Canada.

ROSS \$\$\$\$ NEW SPECIALS (October only): If you don't see what you want, send Call letters, name & phone # for personal price quote. Over 6500 ham-related items in stock. CALL-BOOK US OR FOREIGN \$14.00. ICOM # IC-735 \$729.90, IC-45A \$287.90, IC-745 \$768.90, IC-04AT \$295.90, IC-701 \$529.90, KENWOOD # TS-940S/WAT \$1699.90, TH-21AT \$194.90, TR-7930 \$303.90, TR-7950 \$356.90, TS-430S \$689.90, TM-211A \$299.90, TR-8400 \$349.90, TW-4000A \$494.90, TS-660 \$759.90, YAESU # FC-102 \$239.90, FT-757GX \$698.50, FRG-7700 \$369.90, FRG-8800 \$589.90, FRG-9600 \$486.90, FT-230RT \$279.90. All major lines stocked, L.T.O. MENTION AD. PRICES CASH, FOB PRESTON. WE CLOSE AT 2:00 ON SATURDAYS & MONDAYS. ROSS DISTRIBUTING COMPANY, 78 SOUTH STATE, PRESTON, IDAHO 83263 (208) 852-0830.



# JOIN ARRL



**BENEFITS FOR YOU: QST, QSL Bureau, Awards (DXCC, WAS, etc.), Low Cost Insurance, Operating Aids, Government Liaison and more—Much more! For You!**

USE THIS COUPON OR A FACSIMILE AND MAIL TODAY.

**The American Radio  
Relay League, Inc.  
Desk 15  
225 Main Street  
Newington, CT 06111**

### MEMBERSHIP APPLICATION

Name \_\_\_\_\_ Call \_\_\_\_\_

Street \_\_\_\_\_

City \_\_\_\_\_ Prov./State \_\_\_\_\_ PC/Zip \_\_\_\_\_

\$25 in U.S./\$30 in Canada/\$33 elsewhere (U.S. funds)

Licensed amateurs, age 17 or under or age 65 or over, upon submitting proof of age, may request the special dues rate of \$20 in the U.S. (\$25 in Canada, \$28 elsewhere, in U.S. funds)

For postal purposes, fifty percent of dues is allocated to QST, the balance for membership.

VISA or Chargex No. \_\_\_\_\_ Expires \_\_\_\_\_

Master Card No. \_\_\_\_\_ Bank No. \_\_\_\_\_ Expires \_\_\_\_\_

CQ

# USA-CA

Order one or two today and start collecting counties for one of amateur radio's most prized awards.



76 N. Broadway, Hicksville, NY 11801

Please rush me \_\_\_ copies of the USA-CA Record Book.

Enclosed is \$1.25 for each record book.

Total Enclosed \_\_\_\_\_

Name \_\_\_\_\_

Address \_\_\_\_\_

City \_\_\_\_\_ State \_\_\_\_\_ Zip \_\_\_\_\_



## AMATEUR AND COMMERCIAL COMMUNICATION SERVICES



- REPAIRS
- TESTS
- INSTALLATIONS
- ALIGNMENTS
- MODIFICATIONS
- EVALUATIONS
- FCC, NABER And SBE Licensed
- Modern Lab
- 90 Day Warranty On Work Performed
- Sales Of Commercial Land Mobile, Paging, Portable And Mobile Telephone And Marine Equipment With Antennas And Other Accessories
- KLM Electronics Repair Facility

OPEN: 6 PM to 10 PM

Sun. thru Thurs.

Geff N8CE

517-626-6044

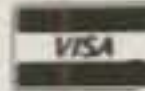

**PARSEC**  
COMMUNICATIONS, INC.  
13313 FOREST HILL RD.  
GRAND LEDGE, MICHIGAN 48837

CIRCLE 4 ON READER SERVICE CARD



# ICOM

# KENWOOD

# YAESU



**IC-735** New, compact HF Transceiver  
**IC-751** 9-band Xcvr / 1-30 MHz Rcvr. \$1399.00 Call  
**IC-745** 9-band Xcvr / 1-30 MHz Rcvr. \$ 999.00 Call



**IC-271H** 100w 2m FM/SSB/OV Xcvr ..... Call  
**IC-271A** 25w 2m FM/SSB/CW Xcvr. \$699.00 Call  
**IC-471A** 10w 430-450 SSB/CW/FM Xcvr \$799.00 Call



**IC-02AT** Call  
**IC-04AT** Call  
**IC-2AT** Call  
**IC-3AT** Call  
**IC-4AT** Call

**IC-R71A**  
GENERAL COVER RCVR



**TS-940S/AT** ..... \$1995.00 Call  
**TS-930S/AT** ..... \$1799.00 Call  
**TS-930A** ..... \$1599.00 Call



**TS-711A TS-811A** ..... Call



**TR-2600A** Call  
**TH-21A** Call  
**TH-21AT** Call  
**TH-41A** Call  
**TH-41AT** Call

**R-2000**  
GENERAL COVER



**FT-980** ..... \$1659.00 Call  
**FT-ONE** ..... Call



**FT-726R** ..... \$ 899.00 Call



**FT-209RH** Call  
**FT-709RH** Call  
**FT-203RH** Call  
**FT-103R** Call  
**FT-703R** Call

**FRG-8800**  
GENERAL COVER RCVR



**SALE!!**  
NEW RTTY/CW  
COMPUTER  
INTERFACES



**BIRD**



### THIS MONTH'S SPECIALS

**ICOM** FREE BP8 (62.50 value) w/purchase of IC02AT **ONLY \$349.95**

**KENWOOD** FREE PB26 (39.99 value) w/purchase of TR-2600A **ONLY \$299.95**

**YAESU**

FREE FTS6 (49.95 value) with purchase of FT-209RH or FT-709R **ONLY \$299.95**

**MIRAGE**

AMPLIFIER

SALE!



**AMERITRON**

AL-80



**JUN'S**  
**ELECTRONICS**

Calif. Call Collect for Order

800-882-1343  
INCLUDES ALASKA HAWAII

- AMATEUR ● TWO WAY ● MARINE
- CELLULAR MOBILE PHONE ● SCANNER
- ★ Free U.P.S. Cash Order (Most Item, Most Place)
- ★ Shoppers, call us last, save \$\$
- ★ SE HABLA ESPANOL

**(213)390-8003**

3919 Sepulveda Blvd.  
Culver City, CA 90230

MCINTOSH AUDIO EQUIPMENT bought, sold, traded. Steve Rowell, POB 176, Walton, NY 13856 (607-865-7200 8 am-5 pm EST Mon-Fri).

**HF QRP KIT**, 5 watts output on 40, 30, 20 meters, \$39.95 plus \$2.00 shipping includes one crystal, your choice of 7.035, 7.125, 10.108, 10.125, or 14.035 MHz. Write for full data and schematic. RF KIT Co., Box 27127, Seattle, WA 98125.

**PHELPS DODGE DUPLEXERS** for two meters. Model #497, 6 cavity, \$600 each. HAL ID-1A Repeater ID'er, 19" rack mount, 110V power supply, \$50. VHF Engineering two meter repeater complete with logic, \$325. K1KYI, Richard Fairweather, Harrisville, RI 02830 (401-568-3468 between 8-9:30 pm EDT).

**COCO SOFTWARE** by dataLOG! Comprehensive logbook program DXCC/WAS Database, CoCo MORSE w/interface, Disk Utilities. Write or call for free catalog. dataLOG SOFTWARE, WA4FNG, P.O. Box 10531, Jacksonville, FL 32247 (ph. 904-396-6572).

LET THE WORLD KNOW what you would really rather be doing! Get your "I'd rather be DX'ing" bumper sticker with "Amateur Radio" written down the sides. Red and black, vinyl, and removable, so it won't hurt your car. \$2.00 plus 50¢ postage to: Bumper Sticker, P.O. Box 6349, Evansville, IN 47712.

**COLLINS KWS1 and 75A4** both mint \$750.00. Pickup only. K3ES 412-621-3977.

**HELP:** I need oil-filled capacitors, .005 UF at 8 KV or higher. Also .1 UF at 20 KV or higher. Call 1-301-676-6763.

**WANTED: JOHNSON KILOWATT MATCHBOX** with directional coupler and indicator. Must be mint clean and in first-class condition. Top cash paid immediately. Write: DL 6 YU Hans MOLDNER, Box 2027, 8960 Kempton, BRD, West Germany.

**BURGLAR ALARMS: BOOMING BUSINESS: GET IN NOW.** Business-Residential. Systems easily learned. INFORMATION \$2.00 (redeemable). SECURITY ELECTRONICS INTERNATIONAL, P.O.B. 1456-QS, Grand Rapids, MI 49501.

**QSL CARDS:** 50 for \$5.00, 100 for \$8.00. Sample SASE. WB2EUF, Box 708, East Hampton, NY 11937.

FOR AN INDIVIDUAL wonderful ham holiday in Sri Lanka, contact "Spangles," 84 Templer Road, Mount Lavinia. Free call facilities. Families and groups welcome. Send SAE + 2 US for details and license application form.

**20% OFF COMPUTER SOFTWARE!** Send SASE for free catalog: ELECTRONIC PUT-ONS, 7805 N.E. 147th Ave., Vancouver, WA 98662.

**CB-TO-10M CONVERSIONS:** FM kits, frequency modification hardware, books, plans, high-performance CB accessories. Free catalog, CBCI, Box 31500CQ, Phoenix, AZ 85046 (602-996-8700).

**C64 SOFTWARE:** Send SASE for list. P.O. Box 387, Chillicothe, OH 45601.

**HI-MOUND Keying mechanisms** now available! Finest and most extensive line of hand-keys, mobile-keys, and iambic paddles. Write for free catalogue. SKYWAVE RADIO SYSTEMS, Box Q-1, 943 Boblett, Blaine, WA 98230.

**FOR SALE:** Kenwood TS930S w/AM Filter. Absolute mint! Used only few hours due certifiable medical condition. Original box, cover, etc., \$1,000 or Best Offer. Fred Berge, KD6LY, (818) 887-6829 or (818) 346-8551.

**TR7 USERS:** NB-7 noise blanker, new \$65 ppd. SL-300/SL-500 Filters @ \$50 ea, ppd. Also have HS-75 padded headset new @ \$15 ea, ppd. MN-75 antenna tuner new @ \$125 ea, ppd. Kenwood: SP-520 spkr, new @ \$35. BS5 pan adapter for SM-220 @ \$49 new. Yaesu: SP-901P spkr/phone patch, \$59, mint. Drake: MS4 speaker new @ \$35. Kenwood: TS-120S xcvr @ \$400 + postage. Call/write: Tony Musero, K3UKW, 1609 So. Iseminger St., Phila., PA 19148 (215-271-8898). Cashiers check or M/O.

**UNIVERSITY HAM CLUB** needs QST from 1980, CQ from 1976, oldies, selected HR & 73. Tax deductible! Bob May, ET-SU ARC, Box 19060A, Johnson City, TN 37614.

**MUST SELL:** Ten-Tec Digital Argosy with matching power supply, immaculate clean transceiver, very low hours, \$485. KABNQU, Tim Jenney, 7060 Cliffwood Place, Huber Hts., OH 45424 (513-236-4279).

**DIGITAL AUTOMATIC DISPLAYS** for FT-101's, TS-520's, Collins, Drake, Swan, and all others. Six 1/2" digits in a 5" wide by 1 1/4" high and 9" deep metal cabinet. Send \$1.00 for information. GRAND SYSTEMS, Dep't. D, P.O. Box 3377, Blaine, WA 98230. Canadians VE7LB.

**TRICK OR TREAT!** No candy or apples, but your unwanted equipment sure would be appreciated by the Crew learning English Thru Amateur Radio at Junior High School 22 on Manhattan's Lower East Side. Send it today, feel better tomorrow and get the tax advantage for 1985. Contact WB2JKJ.

**ESTATE SALE** for the family of N5CIP. All equipment in mint condition, some brand new: TR7, PS7, R7, MN2000, MN2700, WH7, P75, SP75, HAL DS3100ASR, ST6000, AEA150, IC271H, SPS20, TB5EM and other parts. Send SASE for complete list. Call KD5E 409-632-5625 or 409-634-43173.

**ROSS \$\$\$ USED October SPECIALS:** (OVER 200 USED ITEMS IN STOCK) KENWOOD TS-130S \$419.00, TS-830S \$599.90, TS-180S \$359.00 TO \$499.90, TR-9500 \$439, TS-820S/DG1 \$459.90, TS-820S \$479.90. YAESU FT-101E \$429.90, FT-301D \$369.90, FT-620B \$279.00, ICOM IC-751 \$999.90, IC-730 \$469.90, IC-701 \$389.90. If this month's special is not what you are looking for send SASE. Call letters, name & phone # for used list. Over 7,500 NEW ham-related items in stock. MENTION AD. PRICES CASH, FOB PRESTON. WE CLOSE AT 2:00 ON SATURDAYS & MONDAYS. ROSS DISTRIBUTING COMPANY, 78 SOUTH STATE, PRESTON, IDAHO 83263 (208) 852-0830.

**FREE 3 month subscription.** Send callsign to Westlink Report-C10, 28221 Stanley Court, Canyon Country, CA 91351. New only!

**ELECTRON TUBES:** Radio & TV types 75% off List Price—Huge Inventory! Also industrial types. Send for Free Catalog Today or Call Toll Free (800) 221-5802. Box CC, Transletronics, Inc., 1365 39th St., Brooklyn, NY 11218. See Our Display Ad This Issue.

**FOR SALE:** German hand Morse keys as used during WWII by the German army. 40 years old and in very good shape. Screws for adjustments in brass, silver contacts. Cord line with 2-pole plug, black plastic case, and hinged cover. Old emblem in the main base. Weight: 0.8 lbs. Measurements: 3.1" x 1.6" x 5.8". Each \$35 incl. seammil. New keys from GDR. Black plastic case, hinged cover with label. Screws in nickel-plated steel, built-in steel plate. Without cord line. Weight: 0.88 lbs (2.5" x 1.9" x 5.3"). Each \$16 incl. seammil. Ask for pictures. Payment with bank draft. Klaus Gramowski, DL7NS, Kaiserin-Augusta-Allee 91, D-1000 Berlin 10, West Germany.

**\*NOVICE RADIO OUTLET\*** New and used equipment dealer catering to the beginner in amateur radio! October Special! AEA's MORSE UNIVERSITY for the C-64, \$38.95: 919-286-7927, 1604 Delaware Ave., Durham, NC 27705.

**FREE SHIPPING,** Continental USA. Mini-Quads, Nye Tuners, B&W, Van Gorden, Mosley, Unadilla/W2AU products, Butter-nut Antennas and Accessories, Great Dipole Packages and more. Canadians we export. Stamp for flyer. Don, HART EASTERN COMMUNICATIONS, 1444 Darlington, Derby, NY 14047 (near Buffalo) 716-947-4840.

## NEMAL ELECTRONICS INTL, INC.

your one stop COAX supplier!

### SATELLITE CONTROL CABLE 5 TYPES AVAILABLE!

TYPE 1 (General Purpose)	TYPE 2 (MTI)	TYPE 3 (Interstat)	TYPE 4	TYPE 5
1 - RG59/U 96% Copper Braid	1 - RG59/U 96% Copper Braid	2 - RG59/U 96% Copper Braid	1 - RG6/U 18 Gauge, 96% Copper Shield	2 - RG6/U 18 Gauge, 96% Copper Shield
2 @ 16-Gauge	2 @ 12-Gauge	2 @ 12-Gauge	2 @ 12-Gauge	2 @ 12-Gauge
5 @ 22-Gauge	3 @ 18-Gauge	6 @ 18-Gauge	3 @ 18-Gauge	3 @ 18-Gauge
3 @ 20-Gauge	3 @ 20-Gauge	3 @ 22-Gauge	3 @ 20-Gauge	3 @ 18-Gauge
Shielded plus Tinned Copper Drain Wire	Shielded plus Tinned Copper Drain Wire	Shielded plus Tinned Copper Drain Wire	Shielded plus Tinned Copper Drain Wire	Shielded plus Tinned Copper Drain Wire
	3 @ 22-Gauge Shielded plus Tinned Copper Drain Wire		3 @ 22-Gauge Shielded plus Tinned Copper Drain Wire	3 @ 22-Gauge Shielded plus Tinned Copper Drain Wire
<b>55¢ FT</b>	<b>75¢ FT</b>	<b>95¢ FT</b>	<b>79¢ FT</b>	<b>89¢ FT</b>

Call for 1000 FT pricing

#### HARDLINE

Two styles, two sizes for all installation needs

**Aluminum Outer Conductor with Polyethylene Jacket**  
 1/2 inch loss .48 dB/100 ft @ 30 MHz  
 3.68 dB/100 ft @ 1000 MHz \$54/ft  
 7/8 inch loss .26 dB/100 ft @ 30 MHz  
 2.54 dB/100 ft @ 1000 MHz \$3.25/ft

**Corrugated Copper Outer Conductor with Polyethylene Jacket**  
 1/2 inch loss .36 dB/100 ft @ 30 MHz  
 (FLC12-50J) 2.78 dB/100 ft @ 1000 MHz \$1.58/ft  
 7/8 inch loss .13 dB/100 ft @ 30 MHz  
 (FLC12-78J) 1.3 dB/100 ft @ 1000 MHz \$3.92/ft

COMPARE RG 213 1.25 dB/100 ft @ 30 MHz  
 8.5 dB/100 ft @ 1000 MHz!

#### HARDLINE CONNECTORS

1/2 inch aluminum UHF M/F \$19.00 Type N M/F \$22.00  
 7/8 inch aluminum UHF M/F \$49.00 Type N M/F \$49.00  
 1/2 inch copper UHF M/F \$22.00 Type N M/F \$22.00  
 7/8 inch copper UHF M/F \$49.00 Type N M/F \$49.00

shipping  
 Cable — \$6.00 per 100 ft.  
 Connectors — \$3.00 per order.  
 Orders under \$20 add \$2 additional plus shipping.  
 Charge card — orders over \$30 only.  
 COD add \$2.00. Florida Residents add 5%.

FACTORY AUTHORIZED DISTRIBUTOR  
 AMPHENOL, CABLEWAVE, COLUMBIA, KINGS  
 BLONDER-TONGUE, TYTON, B&K

- COAXIAL CABLE
- MULTICONDUCTOR CABLE
- CONNECTORS-ADAPTERS
- HARDLINE
- CABLE TIES
- SMATV PRODUCTS
- COAX-SEAL
- COMPUTER CABLE
- CRIMP TOOLS
- FIELD STRENGTH METER

#### COAXIAL CABLE SALE POLYETHYLENE DIELECTRIC

RG-8/U 99% shield Mil Spec (\$29.00/100) or 31"/ft  
 RG-11U 99% shield 75 ohm mil spec 25"/ft  
 RG-59B/U double shield (RG-58 size) 50 ohm 45"/ft  
 RG-58U mil spec 99% shield (\$10.00/100) or 11"/ft  
 RG62A/U 99% shield mil spec 33 ohm 12"/ft  
 RG-174/U min. 50 Ω mil spec 10"/ft  
 RG-213 noncontaminating 99% shield mil spec 36"/ft  
 RG-214/U double silver shield 50 ohm \$1.65/ft  
 RG-214/U lined copper 65"/ft  
 RG-217/U double shield 500 5/8" OD 85"/ft

#### LOW LOSS FOAM DIELECTRIC

RG-8X (Mini B) 99% shield (\$15.00/100) or 17"/ft  
 RG-8U 80% shield (\$15.00/100) or 22"/ft  
 RG-8/U 97% shield 11 ga. (eq. Belden 8214) 31"/ft  
 RG-58U 80% shield 67"/ft  
 RG-58U 95% shield 10"/ft  
 RG-59U 100% foil shield TV type 10"/ft  
 RG-59/U 70% copper shield 89"/ft  
 HEAVY DUTY ROTOR CABLE 2-18 ga 5-22 ga 36"/ft  
 Rotor cable 2-18 ga 5-22 ga Poly bural Jet 19"/ft  
 Complete line of multiconductor cables available

#### CONNECTORS MADE IN USA

Amphenol PL 259 89¢  
 PL 259 and/or 50-239 65¢ ea. or 10/\$5.90  
 Double Male Connector \$1.79  
 PL 258 Double Female Connector 90¢  
 PL 259 Silver-Teflon Kings \$1.59 ea.  
 Reducer UG-175 or 176 22" or 10/\$2.00  
 UG-255 (PL-259 to BNC) \$2.95  
 Elbow (MDS) UHF Elbow \$1.79  
 F59A (TV type) 24" or 10/\$2.00  
 UG 21 (DU) Type N Male for RG8, Amphenol \$3.00  
 UG-BNC(U) BNC Male for RG-58, Amphenol \$1.25  
 UG 273 BNC-PL259 Amphenol \$3.00  
 3/16 inch Mike Plug for Collins etc. (cutoff) \$1.25

shipping  
 Cable — \$3.00 per 100 ft.  
 Connectors — add 10%, \$3.00 minimum.  
 Orders under \$20 add \$2 additional plus shipping.  
 Charge card — orders over \$30 only.  
 COD add \$2.00. Florida Residents add 5%.

# DOCKING BOOSTER

Converts Your HT to a Powerful Mobile Unit

30 or 50 watts output  
 16 DB GaAs FET pre-amp  
 Fits on most car doors  
 Mic hang-up clip  
 Icom, Yaesu, Kenwood  
 2 Meters & 70 cm

**\$149<sup>95</sup>**



CMC COMMUNICATIONS, INC.  
 5479 Jetport Industrial Blvd. • Tampa, FL 33614  
 Phone: 813-885-3996

# KT-34XA Triband Performance

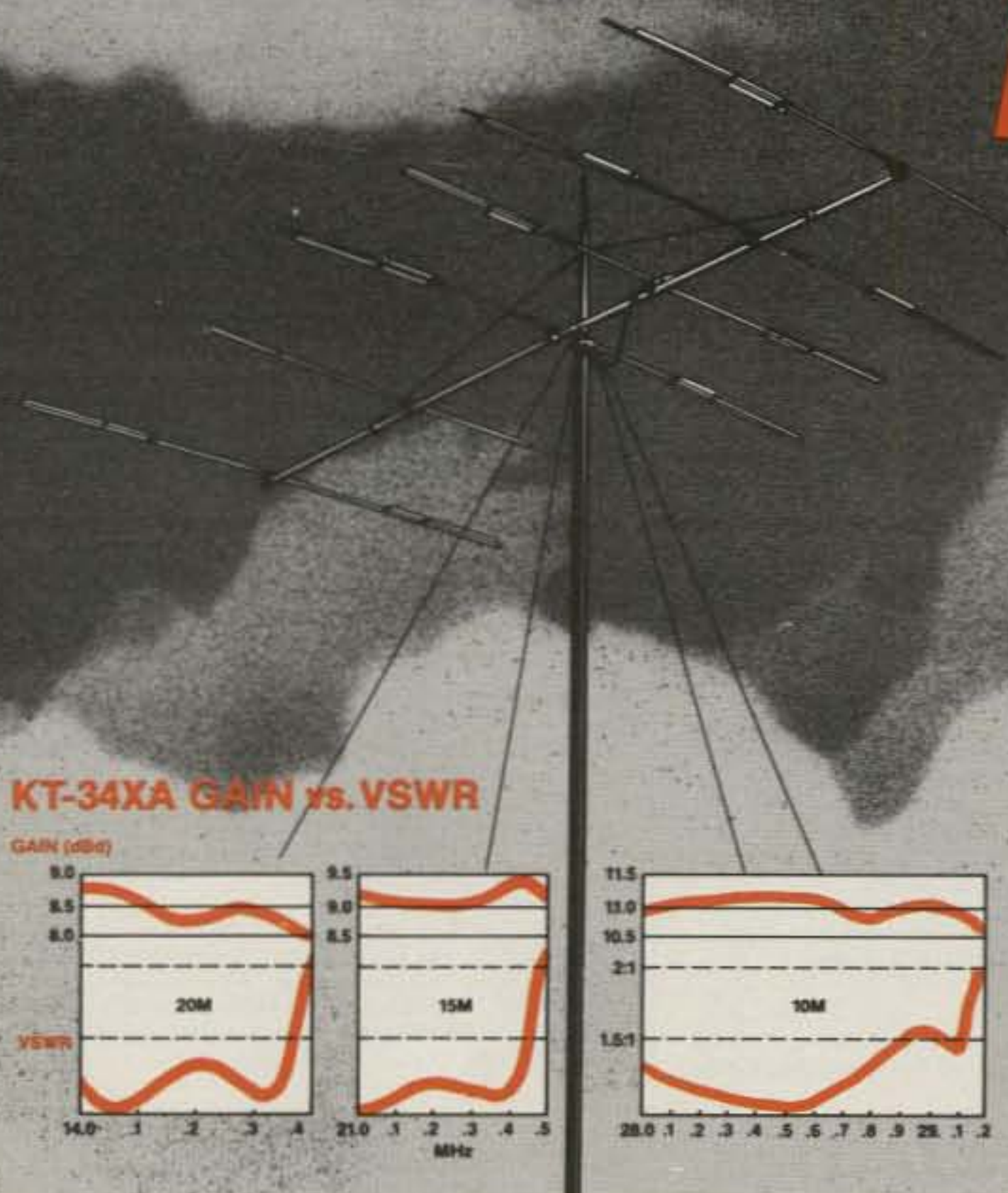

Takes you through the sunspot lull with solid QSO's and exciting DX.

The unequalled performance of the KT-34A and KT-34XA Triband Antenna Systems are the result of KLM's uncompromising approach to antenna performance and reliability.

Our unique design utilizes lossless linear loading techniques with High Q Air Capacitors for peak efficiency. Dual driven elements deliver "Monobander" gain and low VSWR to make even barefoot solid state rigs work like kilowatts.

The four element KT-34A is expandable to the latest KT-34XA using the available KT-34XA upgrade kit.

See the complete line of KLM's antennas and equipment at your local dealer, or write for our catalog.

**KLM** electronics, Inc.  
P.O. Box 816  
Morgan Hill, CA 95037

CIRCLE 69 ON READER SERVICE CARD



## NEWS we'll treat you like a NEWS BULLETIN

For more than 40 years we have been serving the amateur community with QUALITY PRODUCTS and DEPENDABLE "S-E-R-V-I-C-E" and, we fully intend to carry on this proud tradition with even MORE new product lines plus the same "fair" treatment you've come to rely on. Our reconditioned equipment is of the finest quality with 30, 60 and even 90-day parts and labor warranties on selected pieces.

And, remember...

### — WE SERVICE WHAT WE SELL —

- |                     |               |                  |
|---------------------|---------------|------------------|
| AEA                 | DRAKE         | MOSELEY          |
| AMECO               | ENCOMM        | NYE              |
| AMERITRON           | HUSTLER       | PALOMAR          |
| ANTEK               | ICOM          | RADIO CALLBOOK   |
| ARRL                | JANEL         | ROBOT            |
| ASTRON              | KANTRONICS    | ROHN             |
| ANTENNA SPECIALISTS | KDK           | TELEX / HYGAIN   |
| B & W               | LARSEN        | TEN-TEC          |
| BENCHER             | MFJ           | TRIO-KENWOOD     |
| BUTTERNUT           | MINI-PRODUCTS | UNADILLA / REYCO |
| CUSHCRAFT           | MIRAGE        | YAESU            |
| DIAWA               |               |                  |

Write today for our latest Bulletin/Used Equipment List.

Say You Saw It In CQ

**SELECTION**  
**S-E-R-V-I-C-E**  
and  
**SATISFACTION!**

**STORE HOURS:**  
9-5 P.M. (CST)  
MONDAY thru FRIDAY  
OPEN SATURDAYS  
from 9-1 P.M. (CST)  
CLOSED  
SUNDAYS/HOLIDAYS

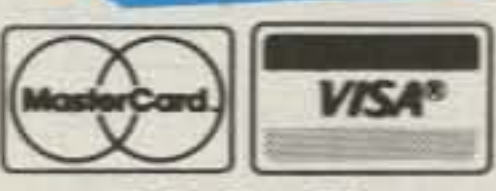

P.O. Box 73  
208 East Kemp  
Watertown, SD 57201

CIRCLE 32 ON READER SERVICE CARD

## Burghardt INC. AMATEUR CENTER

"AMERICA'S MOST RELIABLE AMATEUR RADIO DEALER"

### SELL-TRADE

New & Reconditioned

### HAM EQUIPMENT

Call or Write Us Today For a Quote!

You'll Find Us to be Courteous, Knowledgeable and Honest

PHONE (605) 886-7314

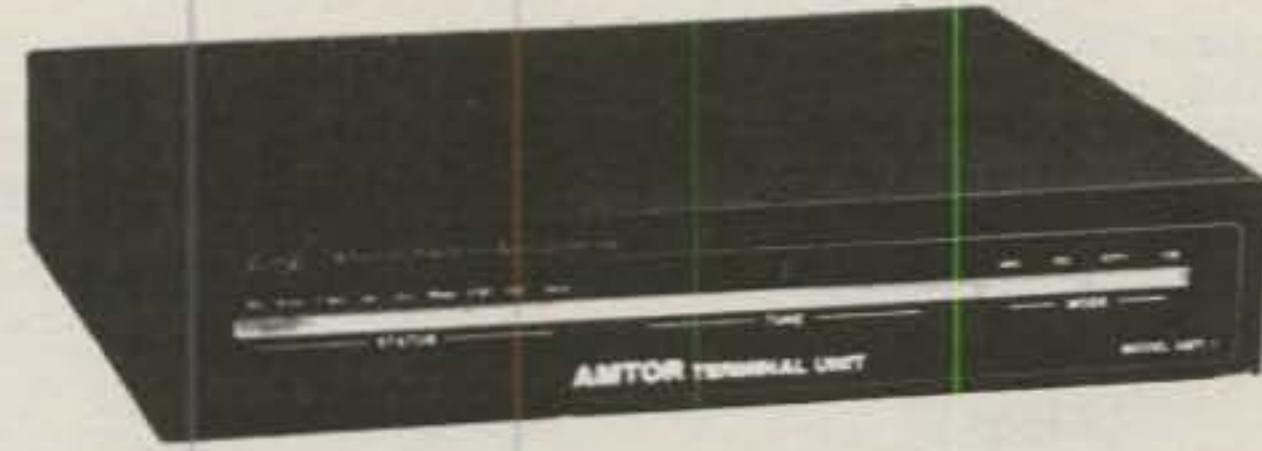

AEA AMT-1. REGULARLY \$479.95  
NOW ONLY \$299.95

THE AMTOR TERMINAL UNIT!!! Works with any ASCII terminal or personal computer with a terminal program. Also works RTTY, CW, ASCII.

ORDER YOURS TODAY! Limited quantities.

## RECEIVE OSCAR 10 TELEMETRY



Complete Kit  
**\$134.95**

plus \$3.00  
shipping and  
handling

**PSK DEMODULATOR**—  
decodes satellite's housekeeping status  
reports, environmental data collected and  
plain text bulletins

**INPUT**—  
audio output of SSB receiver or cassette player.

**OUTPUT**—  
RS232 compatible serial bit stream at 1200 baud.

1985-86  
CATALOG  
50¢



RADIO KIT  
BOX 411 C  
Greenville, NH  
03048  
(603) 878-1033  
telex 887697

CIRCLE 123 ON READER SERVICE CARD

# QSLs

★ Reasonable prices  
★ Quality printing  
★ Fast service

100% GUARANTEED

**QSLs** By W4MPY

WAYNE CARROLL  
705 AUDUBON CIRCLE  
BELVEDERE, SC 29841 USA

CIRCLE 163 ON READER SERVICE CARD

**VIEWSTAR LINEAR AMPLIFIERS** for Amateur Radio use. Note these linears are made in Canada (see many CQ ads in '84). Frequency coverage 1.8-30 MHz with overlapping ranges. Model PT2500A uses 2 x 3-500Z Eimac tubes for 2.5 kW output or better. Model PT1000A uses 3-500Z single tube for about 700 watts output or better. Gentleman please note that these linear amplifiers are the finest 3-500Z linears ever made for Amateur Radio use, can be used for commercial use. Both models in original factory sealed cartons with all matching accessories needed to put right in use. Replacement parts are available, warranty service is available. The price will be 30% off retail. Model PT2500A retail \$1,495. Model PT1000A \$995. I will ship FOB N.Y. or anywhere in the free world. All inquiries will be answered. Mark, P.O. Box 0280, Baldwin, New York U.S.A. 11510.

**AMATEUR RADIO EQUIPMENT.** Three generations of radios that must be sold. All either new, like new or mint. Original cartons, manuals, accessories, etc. Signal One Transceiver Model CX7, new \$700; CX7B, Speaker, new ltrs, parts mint, \$750. Collins linear 30S1, \$1,495; 30L1 linear, \$349; 62S1, \$450. Drake Cline factory sealed cartons, never used \$849; SB220, \$400. Tempo 2 mtr 2002 two kilowatt desk top, \$500. KWM2A, \$675; KWM2, \$575. Collins KWM380, new \$2,500. Collins 75S2, \$250. 75A4, \$300. Collins 516-F2, \$100. 312B4 \$150. Send for list, there is much more. I will answer every inquiry. Also will ship anywhere in the free world. Mike, P.O. Box 0280, Baldwin, New York U.S.A. 11510.

**TENNATEST:** Antenna noise bridge outperforms others, accurate, costs less, satisfaction guaranteed. 1-150 MHz. Send stamp for details. W8URR, 1025 Wildwood Rd., Quincy, MI 49082.

**SELLING:** TS-830S Morse keyboard, EV664 mic, Turner mic, Gentec dummy, Mosley beam. Box 623, Coventry, RI 02816.

**FOR SALE:** Three 572B, used less than 5 hours, \$25 each. Two 811 new \$15 both. John Guthrie, W3GJ, St. Marys, PA 15857.

**ICOM 730** with PS-45 supply. Like new, only 36 "On-Air" hours. Must sell—\$495.00. N6JPH, 702-827-2266.

**SELL:** Pkg 1, exc. and new condx, Kenwood TS430S, PS430, SP430, \$750 firm. Pkg2, HBX 48' tower, 15 ft. Schedule 80 mast, Alliance rotator, thrust bearing, Ant. Mast 7-position switch box, Cushcraft A-4 beam, \$700 firm. Both pkgs \$1400 firm. All new condx. Call 704-541-3368. You ship or pick up.

120" GUYED STEEL TOWER, 18" square 20' sections, \$150, whole tower, \$700. WANTED: TV signal strength meter with UHF. T.N. Colbert, WA8MLV, Burton, OH 44021.

**CLANDESTINE CONFIDENTIAL NEWSLETTER:** Latest info on secret broadcasters. Six issues, \$10 US, \$13 foreign, US funds. RR4 Box 110, Lake Geneva, WI 53147.

**WANTED:** Uniden CR-2021 General Coverage Communications Receiver. WB2IMB, Tom Chwalek, 205 Herbert St., Syracuse, NY 13208.

**SELL:** Hy-Gain 18HT \$225. 160 coil \$20. Palomar Eng RX noise bridge \$45. All new not used. Joe Bedlovies, 241 Dover St., Bridgeport, CT 06610.

**FOR SALE:** Robot Model 400 (SSTV converter), RCA TV-1000 B&W camera, Sanyo 9" B&W monitor \$450 total + UPS. Drake MN-2000 ant. tuner, excellent condx. \$200. Drake TR-33C, \$85. Regency HR2B XCVR for 2 meters, \$35. Kenwood TR-7950 radio only & mike, \$275. Robot Model 70 monitor, converter, \$95. B&W dummy load, \$95. Mirage B-108 amplifier, \$110. PC-1 Kenwood phone patch, \$40. Bearcat \$60 scanner, \$125. Astatic D-104 mike, \$35. Coleco cassette tape recorder (mfg by GE) \$15 (new). Heathkit power/SWR xtr, \$25. Heathkit VHF wattmtr \$25. Please include UPS to all pricing. Contact: K3UKW, 1609 So. Iseminger St. Phila., PA 19148 (215-271-8898).

CX7 with many improvements, \$3400. Mark Mandelkern, KN5S, 2315 Derby St., Berkeley, CA 94705 (415-549-9210).

**NEED BASKETCASE LINEAR(s)** 30L-1, SB-200, etc. Price first letter, please. AA4DF, POB 13322, Tallahassee, FL 32317.

**WANTED:** SBE 33 or 34 in good condition with manual. W1BLR, R1 Box 75, Gilmanton, NH 03237.

**SELL:** Info-tech keyboard, Model 150, \$150 or will trade for a general-coverage receiver. Joseph Schwartz, 11 Windham Loop, 1JJ, Staten Island, NY 10314 (718) 698-6069.

**WANTED:** Drake L-7, WH-7, ICOM IC-551D/FM, IC-PS35, IC-EX-241, Astron RS-35, Ten-Tec 229, Daiwa CN540. K0MK, 690 Vermillion Trail, Gilbert, MN 55741.

MINT IC-02AT, spare BP-3, AEA mike, \$259. TR-7800, KPS-7, \$259. Yaesu FC-700 80-10 tuner, \$79. K1LEC, N. Springfield, VT 05150-0073 or (802) 886-8121.

**WANTED:** 2-3 sections of Rohn 11 tower. State price and condition. KA9FCZ via Callbook.

**SELL:** Ten-Tec Argonaut 505 & PS \$210.00 mint. SASE for list. Joe Bedlovies, 241 Dover Street, Bridgeport, CT 06610.

**NOW HEAR THIS!** Rockbound Novice needs clean operable HG-10B or HA-5 VFO. Ed Kelly, KA0RKJ, 2109 Buena Vista Drive, Greeley, CO 80631 (303-330-7323).

HEATH VTM \$10, Electronic Scope Switch \$5, H.P. Chart Recorder \$35, H.P. 415-B SWR meter \$70, SASE for large list. K6KZT, 2255 Alexander, Los Osos, CA 93402.

**DEMAND ATTENTION** on 80 and 160 meters. Rush \$2.50 to Discage, Box 125, Holton, KS 66436, for details by return mail.

**NAVY TYOE RCK** Radio Receiver, RCA reconditioned, 115-156 MHz AM, mint condition, best offer. R.W. Boyd, Box 793, Stn "A," Montreal, Quebec, (514) 481-4830 after 18:00 hrs.

**NATIONAL RADIO** equipment manual and NCL-2000 parts lists SASE. Maximilian J. Fuchs, 11 Plymouth Lane, Swampscott, MA 01907.

**WANTED:** YAESU FR-100 SD or D receiver, M-28 stunt box, and Teletype "windfall" enclosure. C.T. Hunt, 130 Hunter St., Tiffin, OH 44883.

**WANTED:** Shortwave Craft Magazines any issues. Sell 40 year collection of vacuum tubes. Send list of needs. M. Leavy 4141 Krupp Drive, Apt. 1, E.P. TX 79902.

CALL (412) 733-1555  
M & Th 10-8:00 PM  
T & W 10-6:00 PM  
F & Sat 10-4:00 PM

**WESTECH ELECTRONICS**

WESTECH ELECTRONICS, CO.  
Route 286, Presque Isle Plaza  
Pittsburgh, Pa. 15239

## KENWOOD PACKAGE SAVINGS

<p><b>TR2600A</b> Deluxe 2M HT with extra PB26, SC9, HMC1 or SMC30 and UPS Delivery</p> <p><b>\$359</b></p> <p>TR3600A 440 MHz HT Package \$369</p>	<p><b>TH21AT</b> Pocket 2M HT with extra PB21, SC8T, HMC1 or SMC30, and UPS Delivery</p> <p><b>\$249</b></p> <p>TH41AT 440 MHz HT Package \$259</p>	<p><b>TR7950</b> 45W 2M Mobile with MC46, Larsen LM-MM-Q or Butternut 2MCV, and UPS Delivery</p> <p><b>\$429</b></p> <p>TR7930 25W 2M Mobile Package \$389</p>	<p><b>TS430S</b> HF Transceiver with MC42, PS430, FM430, and UPS Delivery</p> <p><b>\$899</b></p> <p>CALL for other Package Savings</p>	<p><b>TS940S</b> HF Transceiver with AT940, VS1, MC60A, YG455C1, YK88C1, YK88A1, and UPS Delivery</p> <p><b>\$1999</b></p> <p>TS940S w/o AT940 Package \$1799</p>
---	---	--	---	---

Other Packages at similar savings—All HT's shipped with charged battery. FREE UPS 48 states (most rigs)—Pre-shipment checkout at your request

**KENWOOD • ICOM • YAESU • TEN-TEC**

Butternut • Cushcraft • HyGain • Rohn • AEA • Astron • B&W • Bencher  
Daiwa • Kantronics • MFJ • Mirage • Nye • Regency • W2AU • Vibroplex

CIRCLE 129 ON READER SERVICE CARD



# 1986 CALLBOOKS



## The "Flying Horse" has a great new look!

It's the biggest change in Callbook history!  
Now there are 3 new Callbooks for 1986.

The North American Callbook lists the amateurs in all countries in North America plus those in Hawaii and the U.S. possessions.

The International Callbook lists the calls, names, and address information for licensed amateurs in all countries outside North America. Coverage includes Europe, Asia, Africa, South America, and the Pacific area (exclusive of Hawaii and the U.S. possessions).

The Callbook Supplement is a whole new idea in Callbook updates. Published June 1, 1986, this Supplement will include all the activity for both the North American and International Callbooks for the preceding 6 months.

Publication date for the 1986 Callbooks is December 1, 1985. See your dealer or order now directly from the publisher.

<input type="checkbox"/> North American Callbook incl. shipping within USA	\$25.00
incl. shipping to foreign countries	27.60
<input type="checkbox"/> International Callbook incl. shipping within USA	\$24.00
incl. shipping to foreign countries	26.60
<input type="checkbox"/> Callbook Supplement, published June 1st incl. shipping within USA	\$13.00
incl. shipping to foreign countries	14.00

### SPECIAL OFFER

<input type="checkbox"/> Both N.A. & International Callbooks incl. shipping within USA	\$45.00
incl. shipping to foreign countries	53.50

\*\*\*\*\*  
Illinois residents please add 6 1/4% sales tax.  
All payments must be in U.S. funds.

RADIO AMATEUR  
**callbook** INC.

Dept. Q  
925 Sherwood Dr., Box 247  
Lake Bluff, IL 60044, USA

Tel: (312) 234-6600

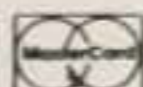
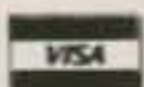

CIRCLE 162 ON READER SERVICE CARD

# THE CHOICE IS YOURS

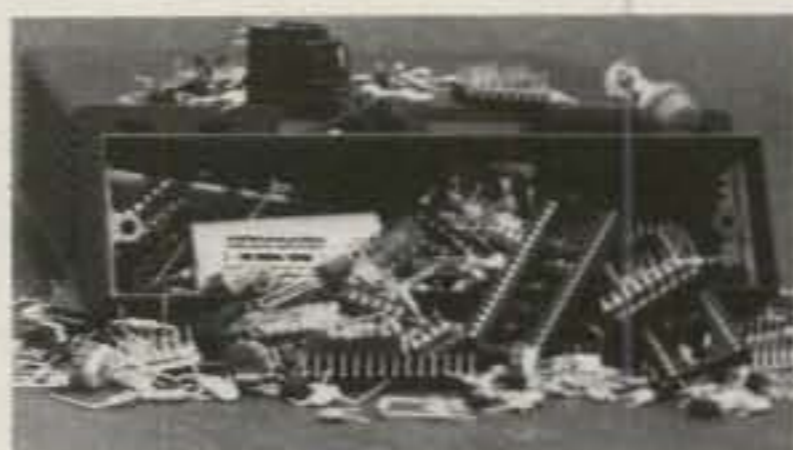

Available: August (?)

- Unassembled Kit
- No Warranty
- Service Assistance (?)



Available: April, 1985  
Dayton

Price: **NOW \$219.00**

- Fully Assembled Unit
- Full One-Year Warranty
- Complete Service Facility & Staff

## BUT LOOK BEFORE YOU LEAP

Both units are Packet Radio Terminal Node controllers with AX.25 protocol, a standard RS-232 compatible port, and command format software. But many differences exist too.

**B**uying the Kantronics Packet Communicator makes sense. You know our reputation for quality products and after-sales-support. You know the Kantronics tradition of making computer interfaces and software that work. So take your pick, the unassembled kit with no warranty, or the guaranteed Kantronics Packet Communicator, ready to work in your shack.

With a price of \$219 we think the Kantronics Packet Communicator is more than a bargain, it's the smartest buy you'll make this year.

**Kantronics**

1202 E. 23rd Street (913) 842-7745  
Lawrence, Kansas 66046

## R-X Noise Bridge



- Learn the truth about your antenna.
- Find its resonant frequency
- Adjust it to your operating frequency quickly and easily.

If there is one place in your station where you cannot risk uncertain results it is in your antenna.

The Palomar Engineers R-X Noise Bridge tells you if your antenna is resonant or not and, if it is not, whether it is too long or too short. All this in one measurement reading. And it works just as well with ham-band-only receivers as with general coverage equipment because it gives perfect null readings even when the antenna is not resonant. It gives resistance and reactance readings on dipoles, inverted Vees, quads, beams, multiband trap dipoles and verticals. No station is complete without this up-to-date instrument.

Why work in the dark? Your SWR meter or your resistance noise bridge tells only half the story. Get the instrument that really works, the Palomar Engineers R-X Noise Bridge. Use it to check your antennas from 1 to 100 MHz. And use it in your shack to adjust resonant frequencies of both series and parallel tuned circuits. Works better than a dip meter and costs a lot less.

The price is \$59.95 in the U.S. and Canada. Add \$4.00 shipping/handling. California residents add sales tax.



Send for FREE catalog describing the R-X Noise Bridge and our complete line of SWR Meters, Preamplifiers, Toroids, Baluns, Tuners, VLF Converters, Loop Antennas and Keyers.

# Palomar Engineers

Box 455, Escondido, CA 92025  
Phone: (619) 747-3343

## Advertiser's Index

AEA/Adv. Elec. Applications	7, 14
ARRL	61, 110
AVC Innovations	83
Advanced Computer Controls	57
Allinco Corp.	15
All Electronics	84
Alpha-Delta Comm.	55
Amateur Electronic Supply	35
Amidon Associates	51
Antique Electronic Supply	51
ArcSoft Publishers	98
Astron Corp.	53
Austin Custom Antennas	68
Autotenna	61
Barker & Williamson	21
Barry Electronics	91
Bencher, Inc.	104
Britt's 2-Way Radio	61
Burghardt Amateur Center	113
Butternut Electronics	18
CES, Inc.	106
CMC Communications	98, 112
C.O.M.B. Co.	45
CQ Book Shop	77
Caddell Coil	83
CeCo Communications Inc.	57
Certified Communications	61
Charge-Rite	105
Computer Trader Magazine	61
Crumtronic	42
Cushcraft Corp.	32
DC Sales	42
Design Electronics Ohio	105
DX Edge	71
EGE, Inc.	81
ENCOMM, Inc.	9
Engineering Consulting	43, 97
Fair Radio Sales	98
Fox Tango Corp.	52, 83
G.I.S.M.O.	55
Golden State Communications	41
Hall Electronics	77
Hal-Tronix	86
Ham Radio Outlet	12
The Ham Station, Inc.	105
Harrison Radio	107
Heaster, Inc.	77
Henry Radio	39
ICOM America, Inc.	10, 11, Cov. IV
IIX Equipment Ltd.	104
JL Industries	68
Jensen Tools	68
Jun's Electronics	111
K2AW's Silicon Alley	106
KLM	113
Kantronics	115
Kenwood	Cov. II, 1, 2
LaCue Communications	22
Lance-Johnson	52
LaRue Electronics	74
Little Wolf Time	83
MFJ Enterprises	29
Madison Electronics	49
Magnum Distributing	84
Martin Engineering, Inc.	52
Memphis Amateur Electronics	57
Microlog Corp.	98
Microwave Filters	44
Midwest Amateur	101
Mini-Products, Inc.	93
Mirage	80
Missouri Radio Center	62, 108
Mor-Gain	97
NCG Co.	43
Nemal Electronics	112
Newsome Electronics	52
Nuts & Volts	75
Nye Co.	76
Octobervention	109
Omega Concepts, Inc.	77
PC Electronics	88
Pacific Cable Co.	97
Palomar Engineers	8, 116
Panasonic	19
Parsec Comm.	111
Pipo Communications	43
QSLs by W4MPY	83
RF Enterprises	31
RF Parts	90
RF Products	75
Radio Amateur Callbook, Inc.	115
Radio Engineers	97
Radio Shack	25
Radiokit	114
Ross Distributing	51
S-F Amateur Radio	71
Satellite Express, Inc.	43
Satman	83
Schultz, Jack Contest Programs	43
Spectrum International	21
Spi-Ro Distributing	83
Sultronics	87
TEP Trio Electronics	42
TNT Amateur Radio Sales	88
Talktronics, Inc.	38
Tel-Com Electronic Comm.	38
Telex/HyGain	3
Telrex Labs	56
Teltemp	41
Ten-Tec	4, 85
Texas Towers	58, 59
Translertonic, Inc.	38
Unity Electronics	106
UNR-Rohn	99
VHF Communications	98
VHF Shop	97
W5Y1	87
W9INN Antennas	75
Wacom Products	38
Westech	114
Western Electronics	87
Williams Radio	41
Woody's Amateur Trader	43
Wrightapes	61
Yaesu Electronics	16, 103, Cov. III

## Palomar Loop Antenna for low noise reception from VLF to 15 MHz.



- Unique and flexible receiving antenna!
- Nulls out interference!
- Accurate direction finder!
- Loop Antenna system connects to any receiver or to your VLF Converter!

The Loop Antenna is far superior for reception in a noisy location. The difference is particularly noticeable on the lower frequency bands where vertical antennas are often used to work DX. On transmit the vertical gets out fine, but on receive it is highly susceptible to noise pickup. Loops pick up far less noise than most other antennas.

The Loop Antenna is compact enough to be used on your operating table. A Loop Amplifier serves as the mounting base for the antenna. It contains a tuning capacitor to resonate the loop and an amplifier to boost the signal and to preserve the high "Q" of the loop. It connects to your receiver through any convenient length of coaxial cable.

Palomar's unique design allows the Loop Antenna to cover a wide range of frequencies. Six plug-in loops are available.

HF-1	5000-15000 KHz
160/80	1600-5000 KHz
BCB	550-1600 KHz
LF	150-550 KHz
WWVB	40-150 KHz
Omega	10-40 KHz

Order one or more loops. Specify loops with order.

The exclusive calibrated tilt design gives a far better null than ordinary loops. The electrical balanced construction and the high gain differential amplifier preserve the symmetry and low noise pickup properties of the loop to give outstanding performance in a compact package.

Order today! LA-1 Loop Amplifier \$84.95. Plug-in Loops \$62.95 each. Add \$4 shipping/handling. Calif. residents add sales tax.

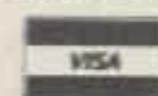

Send for FREE catalog describing the Loop Antenna and our complete line of Noise Bridges, SWR Meters, Preamplifiers, Toroids, Baluns, VLF Converters, Audio Filters, and Computer Interfaces.

**PALOMAR ENGINEERS**  
Box 455, Escondido, CA 92025  
Phone: (619) 747-3343



# Presenting two small cases for a lot of mobile power.

You won't find a 45-watt, 2-meter FM mobile rig that's built smaller than the Yaesu FT-270RH.

Nor will you find a dual-band FM mobile that offers the crossband full-duplex capability found in the 25-watt Yaesu FT-2700RH.

It shouldn't be surprising. We've been coming up with a lot of innovative concepts lately.

The FT-270RH measures just 2 x 6 x 7 inches. Conveniently fitting its high-power punch into many small spaces of your car. Places where other 45-watt mobiles just won't fit.

The FT-2700RH is small too. Smaller than other dual-banders. But with one big difference: a "DUP" button. Push it, and you're operating full duplex, 2 meters on one VFO, 440 MHz on the other. Each at 25 watts. So you can simultaneously

transmit and receive in true telephone style.

Once installed, you'll find the FT-270RH and the FT-2700RH equally simple to operate. Just turn the rig on, dial up a frequency, select offset or duplex split, and you're on the air.

Each rig gives you 10 memories for storing your favorite frequencies. Dual VFO capability. A clean, uncluttered LCD display for easy readout. Push-button jumps through the band in 1 MHz steps. Band scanning with programmable upper and lower limits. And priority channel operation.

You don't even have to take your eyes off the road to determine your operating frequency and memory channel. An optional voice synthesizer announces them both at the push of a button on the microphone. The FT-2700RH announces both your

2-meter and 440 MHz operating frequencies.

Also, tone encode and encode/decode capability is programmable from the front panel, using an optional plug-in board.

So when you need a lot of power in a compact mobile radio, discover Yaesu's FT-270RH and FT-2700RH. There's nothing else like them on the road.

## YAESU

**Yaesu Electronics Corporation**  
6851 Walthall Way, Paramount, CA 90723  
(213) 633-4007

**Yaesu Cincinnati Service Center**  
9070 Gold Park Drive, Hamilton, OH 45011  
(513) 874-3100

Prices and specifications subject to change without notice.

CIRCLE 34 ON READER SERVICE CARD



ICOM HF Transceiver

# IC-751



## The Standard of Excellence in HF Base Stations

The IC-751 is the most advanced transceiver available today. It's a competition grade ham receiver, a 100KHz to 30MHz continuous tuning general coverage receiver AND a full-featured all mode solid-state ham band transmitter. The IC-751 also covers the new WARC bands, MARS frequencies, and is AMTOR compatible.

**Important Standard Features.** Compare these important standard features in this "top of the line" base station:

- 100KHz - 30MHz Receiver
- 105dB dynamic range
- QSK — full break-in CW (nominal speed 20WPM)

- FM Mode Standard
- High-grade FL-44A 455KHz SSB filter
- 32 tunable Memories with lithium battery backup
- 100% Duty Cycle Transmitter
- Passband Tuning
- 12V DC operation
- Adjustable AGC
- Adjustable Noise Blanker
- RIT/XIT with separate readout
- IC-HM12 Microphone with Up/Down Scan
- Continuously adjustable transmit power

**Options.** IC-EX310 speech synthesizer, internal IC-PS35 power supply, external IC-PS15 or IC-PS30 system supply, IC-SM8 two-cable desk mic,

IC-SM6 desk mic, RC-10 external controller, and a variety of filters.

### FILTER SPECIFICATIONS

Filter	Model	Center Freq. (KHz)	-6dB (KHz) Width
<b>STANDARD FILTERS</b>			
AM Ceramic	CFW 455 IT	455	6.0
SSB (PBT) XTAL	FL-30	9011.5	2.3
FM Filter	9M15A	9011.5	15 (-3dB)
SSB Narrow (Hygrade Crystal)	FL-44A	455	2.4
<b>OPTIONAL FILTERS</b>			
CW Narrow	FL-52A	455	0.500
CW Narrow	FL-53A	455	0.250
SSB Wide	FL-70	9011.5	2.8
CW Narrow	FL-32	9010.6	0.500
CW Narrow	FL-63	9010.6	0.250
AM	FL-33	9010.0	6.0

**Operating From 12V,** the IC-751 is also available with an optional internal AC power supply, the IC-PS35...for the winning edge in field day competition.



Shown with IC-PS35

The IC-751 provides superior performance for all amateur radio operators...from novice to extra class. See the IC-751 at your local ICOM dealer.

Now with a ONE YEAR Warranty!



First in Communications

CIRCLE 23 ON READER SERVICE CARD

ICOM America, Inc., 2380-116th Ave NE, Bellevue, WA 98004 / 3331 Towerwood Drive, Suite 307, Dallas, TX 75234  
All stated specifications are approximate and subject to change without notice or obligation. All ICOM radios significantly exceed FCC regulations limiting spurious emissions. 751385