

# Amateur Radio

ICD 08241

SERVING AMATEUR RADIO SINCE 1945

NOVEMBER 1990 \$2.95

CANADA \$3.95

# CQ

Including  
**HAM  
RADIO**

## Special Issue: Digital Communications

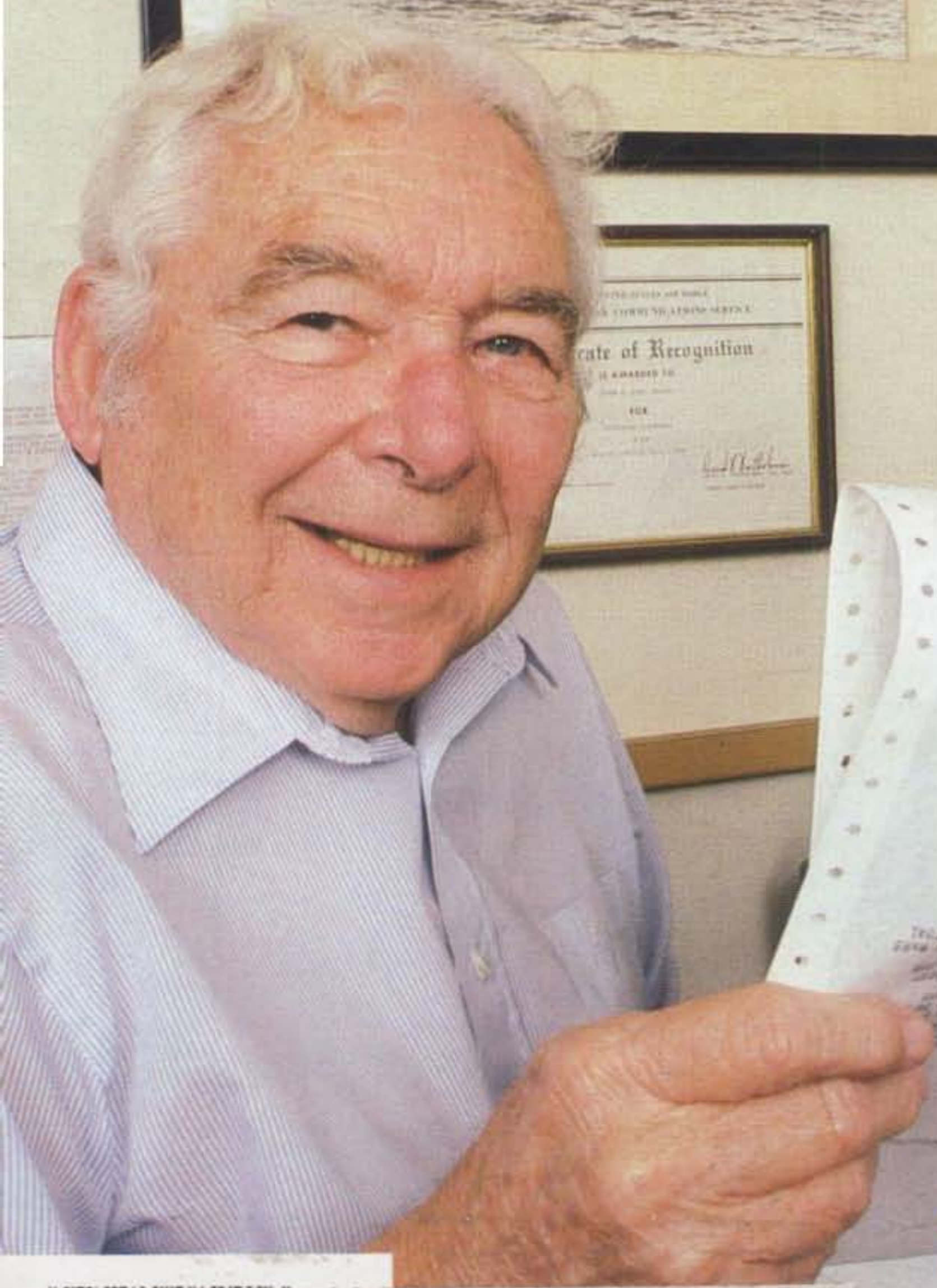

On the cover: W7FCQ enjoys some "old-fashioned" digital communications: RTTY.

AMATEUR'S JOURNAL

# KENWOOD

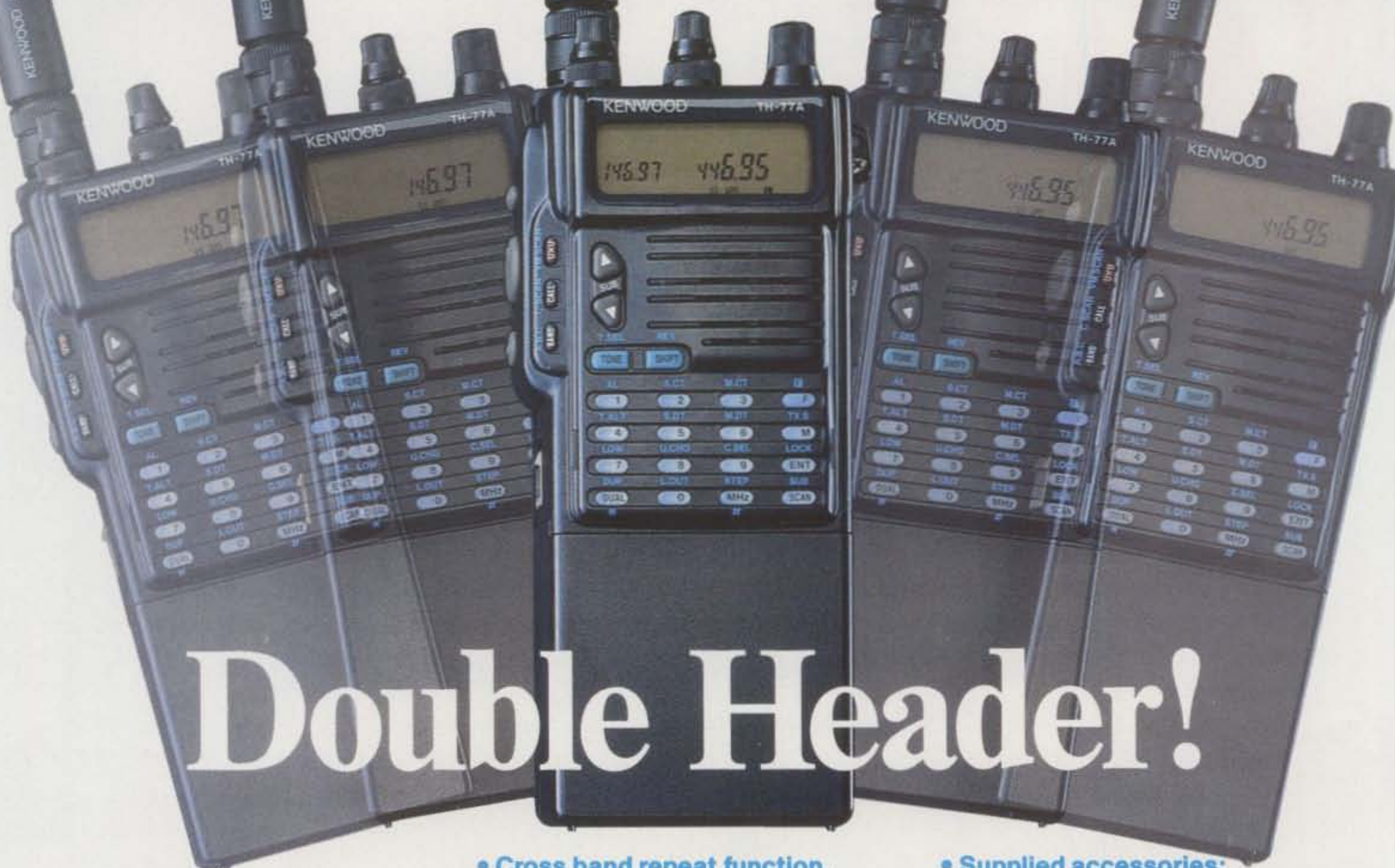

## Double Header!

### TH-77A

#### Compact 2m/70cm Dual Band HT

Here's a radio that deserves a double-take! The TH-77A is a feature-packed dual band radio compressed into an HT package. The accessories are compatible with our TH-75, TH-25, and TH-26 Series radios. Repeater and remote base users will appreciate the DTMF memory that can store *all* of the DTMF characters (\*, #, A, B, C, and D) that are usually required for repeater functions!

- **Wide band receiver coverage.** 136-165 (118-165 [AM mode 118-136] MHz after modification) and 438-449.995 MHz. TX on Amateur bands only. (Two meter section is modifiable for MARS/CAP. Permits required.)
- **Dual receive/dual LCD display.** Separate volume and squelch controls for each band. Audio output can be mixed or separated by using an external speaker.

- **Cross band repeat function.**
- **Dual Tone Squelch System (DTSS).** Uses standard DTMF to open squelch.
- **CTCSS encode/decode built-in.**
- **Forty-two memory channels.** All channels odd split capable.
- **DTMF memory/autodialer.** Ten 15-digit codes can be stored.
- **Direct keyboard frequency entry.** The rotary dial can also be used to select memory, frequency, frequency step, CTCSS, and scan direction.
- **Multi-function, dual scanning.** Time or carrier operated channel or band scanning.
- **Frequency step selectable for quick QSY.** Choose from 5, 10, 12.5, 15, 20, or 25 kHz steps.
- **Two watts (1.5 W on UHF) with supplied battery pack.** Five watts output with PB-8 battery pack or 13.8 volts. Low power is 500 mW.
- **DC direct-in operation** from 6.3-16 VDC with the PG-2W.
- **T-Alert with elapsed time indicator.**
- **Automatic repeater offset on 2 m.**
- **Battery-saving features.** Auto battery saver, auto power off function, and economy power mode.

- **Supplied accessories:** Flex antenna, PB-6 battery pack (7.2 V, 600 mA), wall charger, belt hook, wrist strap, keyboard cover.

- Optional accessories:**
- **BC-10:** Compact charger • **BC-11:** Rapid charger • **BH-6:** Swivel mount • **BT-6:** AAA battery case • **DC-1/PG-2V:** DC adapter
- **DC-4:** Mobile charger for PB-10 • **DC-5:** Mobile charger for PB-6, 7, 9 • **PB-5:** 7.2 V, 200 mAh NiCd pack for 2.5 W output
- **PB-6:** 7.2 V, 600 mAh NiCd pack • **PB-7:** 7.2 V, 1100 mAh NiCd pack • **PB-8:** 12 V, 600 mAh NiCd for 5 W output • **PB-9:** 7.2 V, 600 mAh NiCd with built-in charger
- **PB-11:** 12 V, 600 mAh OR 6 V, 1200 mAh, for 5 W OR 2 W • **HMC-2:** Headset with VOX and PTT • **PG-2W:** DC cable w/fuse
- **PG-3F:** DC cable with filter and cigarette lighter plug • **SC-28, 29:** Soft case
- **SMC-30/31:** Speaker mics. • **SMC-33:** Speaker mic. w/remote control • **WR-1:** Water resistant bag.

KENWOOD U.S.A. CORPORATION  
COMMUNICATIONS & TEST EQUIPMENT GROUP  
P.O. BOX 22745, 2201 E. Dominguez Street  
Long Beach, CA 90801-5745  
KENWOOD ELECTRONICS CANADA INC.  
P.O. BOX 1075, 959 Gana Court  
Mississauga, Ontario, Canada L4T 4C2

# KENWOOD

...pacesetter in Amateur Radio

Complete service manuals are available for all Kenwood transceivers and most accessories. Specifications and features are subject to change without notice or obligation.

# KENWOOD



## TS-950SD

### "DX-clusive" HF Transceiver

The new TS-950SD is the first Amateur Radio transceiver to utilize Digital Signal Processing (DSP), a high voltage final amplifier, dual fluorescent tube digital display and digital meter with a peak-hold function.

#### • Dual Frequency Receive Function.

The TS-950SD can receive two frequencies simultaneously.

• **New! Digital AF filter.** Synchronized with SSB IF slope tuning, the digital AF filter provides sharp characteristics for optimum filter response.

#### • New high voltage final amplifier.

50 V power transistors in the 150-watt final section, resulting in minimum distortion and higher efficiency. Full-power key-down time exceeds one hour.

#### • New! Built-in microprocessor controlled automatic antenna tuner.

#### • Outstanding general coverage receiver performance and sensitivity.

Kenwood's Dyna-Mix™ high sensitivity direct mixing system provides incredible performance from 100 kHz to 30 MHz. The Intermodulation dynamic range is 105 dB.

• **Famous Kenwood interference reduction circuits.** SSB Slope Tuning, CW VBT (Variable Bandwidth Tuning), CW AF tune, IF notch filter, dual-mode noise blanker with level control, 4-step RF attenuator (10, 20, or 30 dB), switchable AGC circuit, and all-mode squelch.

Complete service manuals are available for all Kenwood transceivers and most accessories.

Specifications, features and prices subject to change without notice or obligation.

## The Ultimate Signal.

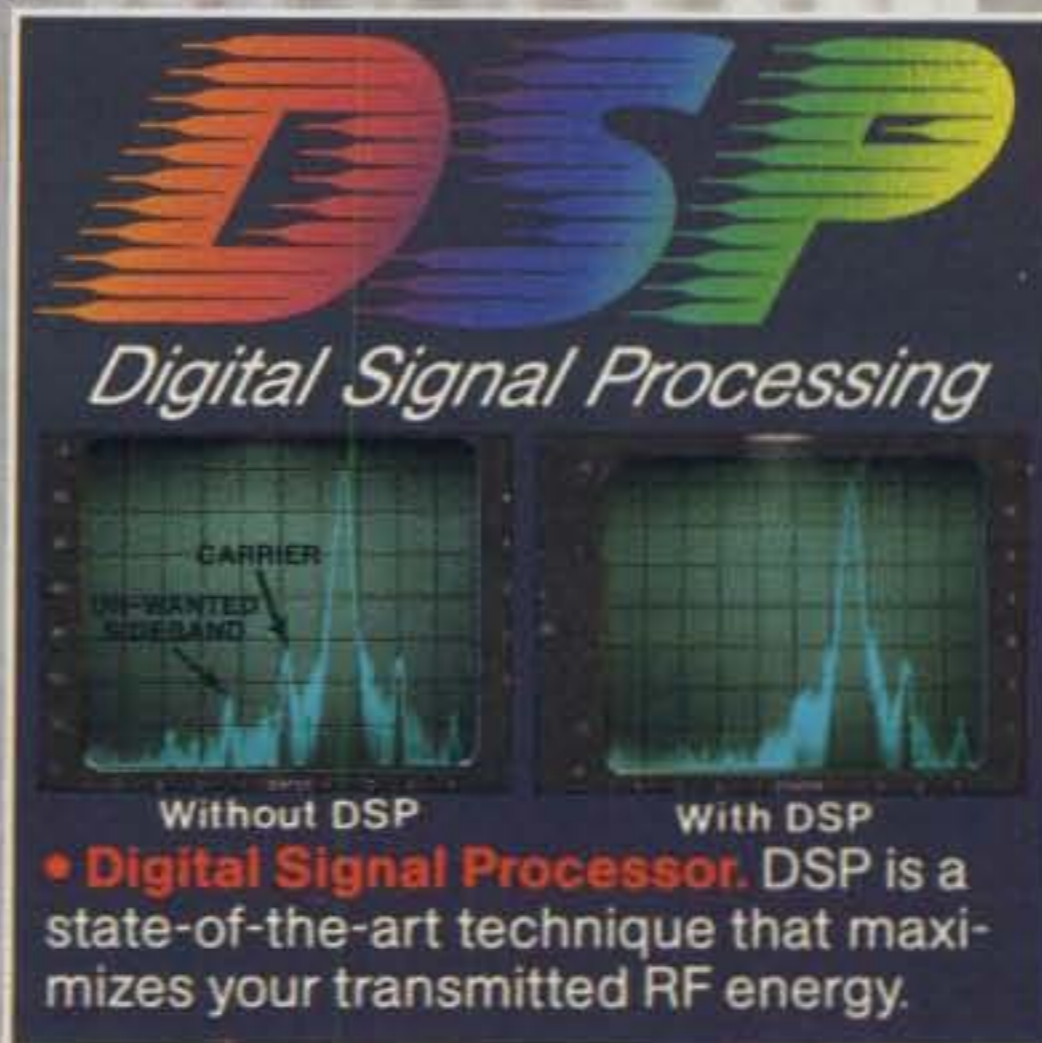

• **High performance IF filters built-in †** Select various filter combinations from the front panel. For CW, 250 and 500 Hz, 2.4 kHz for SSB, and 6 kHz for AM. Filter selections can be stored in memory!

• **Multi-Drive Band Pass Filter (BPF) circuitry.** Fifteen band pass filters are available in the front end to enhance performance.

#### • Built-in TCXO for the highest stability. †

#### • Built-in electronic keyer circuit.

• **100 memory channels.** Store independent transmit and receive frequencies, mode, filter data, auto-tuner data and CTCSS frequency.

#### • Digital bar meter.

**Additional Features:** • Built-in interface for computer control • Programmable tone encoder • Built-in heavy duty AC power supply and speaker • Adjustable VFO tuning torque • Multiple scanning functions • MC-43S hand microphone supplied

#### Optional Accessories

- DSP-10 Digital Signal Processor \*
- SO-2 TCXO \* • VS-2 Voice synthesizer
- YK-88C-1 500 Hz CW filter for 8.83 MHz IF \*
- YG-455C-1 500 Hz CW filter for 455 kHz IF \*
- YK-88CN-1 270 Hz CW filter for 8.83 MHz IF \*
- YG-455CN-1 250 Hz CW filter for 455 kHz IF \*
- YK-88SN-1 1.8 kHz SSB filter for 8.83 MHz IF \*
- YG-455S-1 2.4 kHz SSB filter for 455 kHz IF \*
- SP-950 External speaker w/AF filter
- SM-230 Station monitor w/pan display
- SW-2100 SWR/power meter
- TL-922A Linear amplifier (not for QSK)

\* Built-in for the TS-950SD

† Optional for the TS-950S

KENWOOD U.S.A. CORPORATION  
COMMUNICATIONS & TEST EQUIPMENT GROUP  
P.O. BOX 22745, 2201 E. Dominguez Street  
Long Beach, CA 90801-5745

KENWOOD ELECTRONICS CANADA INC.  
P.O. BOX 1075, 959 Gana Court  
Mississauga, Ontario, Canada L4T 4C2

## KENWOOD

...pacesetter in Amateur Radio



# KENWOOD

## Compact Champion!

### TH-27A/47A

#### 2 m and 70 cm Super Compact HTs

Here is a great new addition to Kenwood's HT family — the all new TH-27A for 2 meters and TH-47A for 70 cm! Super compact and beautifully designed, these pocket-sized twins give you full-size performance.

- **Large capacity NiCd battery pack supplied.** The standard battery pack is 7.2 volts, 700 mAh, providing extended transmit time with 2.5 watts. (TH-47A: 1.5 W.)
- **Extended receive coverage.** TH-27A: 118–165 MHz; TH-47A: 438–449,995 MHz. TX on Amateur bands only, (TH-27A modifiable for MARS/CAP. Permits required. Specifications guaranteed for Amateur bands only.)
- **Multi-function scanning.** Band and memory channels can be scanned, with time operated or carrier operated scan stop.
- **Frequency step selectable for quick QSY.** Choose from 5, 10, 12.5, 15, 20, or 25 kHz steps.
- **Built-in digital clock** with programmable timer.
- **Dual Tone Squelch System (DTSS).** Compatible with the TH-26AT Series and the TM-941A Triple bander, as well as other Kenwood series transceivers, this selective calling system uses standard DTMF to open squelch.
- **Five watts output** when operated with PB-14 battery pack or 13.8 volts.
- **T-Alert for quiet monitoring.** Tone Alert beeps when squelch is opened.
- **Auto battery saver, auto power off function, and economy power mode extends battery life.**
- **DTMF memory.** The DTMF memory function can be used as an auto-dialer. All characters from the 16-key pad can be stored, allowing repeater control codes to be stored!

- **41 memories.** All channels store receive and transmit separately for "odd split"
- **DC direct in operation.** Allows external DC to be used (7.2 – 16 volts). When external power is used, the batteries are being charged. (PB-13 only.)

#### Optional accessories:

- **BC-14:** Wall charger for PB-13, 14
- **BC-15:** Rapid charger for PB-13, 14
- **BH-6:** Swivel mount
- **BT-8:** Six cell AA Alkaline battery case
- **HMC-2:** Headset with VOX and PTT
- **PB-13:** 7.2 V, 700 mAh NiCd pack
- **PB-14:** 12 V, 300 mAh NiCd pack
- **PG-3F:** DC cable with filter and cigarette lighter plug
- **PG-2W:** DC cable
- **SC-30:** Soft case
- **SMC-31:** Standard speaker mic
- **SMC-32:** Compact speaker mic
- **SMC-33:** Compact speaker mic with controls
- **WR-2:** Water resistant bag.

- **Automatic offset selection (TH-27A).**
- **Direct keyboard frequency entry.** The rotary dial can also be used to select memory, frequency, frequency step, CTCSS, and scan direction.
- **CTCSS encode/decode built-in.**
- **Supplied accessories:** Rubber flex antenna, battery pack, wall charger, belt hook, wrist strap, dust caps.

KENWOOD U.S.A. CORPORATION  
COMMUNICATIONS & TEST EQUIPMENT GROUP  
P.O. BOX 22745, 2201 E. Dominguez Street  
Long Beach, CA 90801-5745  
KENWOOD ELECTRONICS CANADA INC.  
P.O. BOX 1075, 959 Gana Court  
Mississauga, Ontario, Canada L4T 4C2

# KENWOOD

...pacesetter in Amateur Radio

# MASTHEAD

## EDITORIAL STAFF

Alan M. Dorhoffer, K2EEK, Editor  
 Gail M. Schieber, Managing Editor  
 Terry Northup, KA1STC, Associate Editor  
 Lew McCoy, W1ICP, Technical Representative  
 Robert D. Wilson, WA1TKH, Technical Advisor  
 Peter O'Dell, WB2D, Special Projects Editor

## CONTRIBUTING STAFF

John Dorr, K1AR, Contest Calendar  
 Chod Harris, VP2ML, DX  
 Dave Ingram, K4TWJ, OSCAR & Antiques  
 George Jacobs, W3ASK, Propagation  
 Dorothy H. Johnson, WB9RCY, Awards & USA-CA  
 Frederick O. Maia, W5YI, FCC Correspondent  
 Buck Rogers, K4ABT, Packet Radio Editor  
 Karl T. Thurber, Jr., W8FX, Antennas & Software  
 Bill Welsh, W6DDB, Novice

## AWARD MANAGEMENT

Jim Dionne, K1MEM, WAZ Award  
 Dorothy H. Johnson, WB9RCY, USA-CA Award  
 Norman Koch, K6ZDL, WPX Award  
 Billy Williams, N4UF, CQ DX Award

## CONTEST MANAGEMENT

Steve Bolia, N8BJQ, WPX Contest Director  
 Larry Brockman, N6AR, WW DX Contest Director  
 Robert Cox, K3EST, WW DX Contest Director  
 John Dorr, K1AR, WW DX Trophies & Certificates  
 Roy Gould, KT1N, RTTY Contest Director  
 Donald McClenon, N4IN, 160 M Contest Director

## BUSINESS STAFF

Richard A. Ross, K2MGA, Publisher  
 Dorothy Kehrwieler, General Manager  
 Arnie Sposato, N2IQO, Advertising Manager  
 Tracy Parbst, Sales Assistant  
 Frank V. Fuzia, Controller  
 J. Craig Clark, NX1G, Circulation Director  
 Catherine Ross, Circulation Manager  
 Melissa Kehrwieler, Data Processing  
 Carol Minervini, Customer Service

## PRODUCTION STAFF

Dorothy Kehrwieler, Production Manager  
 Elizabeth Ryan, Art Director  
 Barbara Terzo, Artist  
 Pat Le Blanc, Phototypographer  
 Florence V. Martin, Phototypographer  
 Linda Romanello, Typesetting  
 Hal Keith, Illustrator  
 Larry Mulvehill, WB2ZPI/VK5AAY, Photographer

A publication of

 CQ Communications, Inc.  
 76 North Broadway  
 Hicksville, NY 11801-USA.

Offices: 76 North Broadway, Hicksville, NY 11801.  
 Telephone: 516 681-2922. FAX (516) 681-2926. CQ  
 (ISSN 0007-893X) is published monthly by CQ Com-  
 munications Inc. Second Class postage paid at  
 Hicksville, NY and additional offices. Subscription  
 prices: Domestic—one year \$22.95, two years \$43.00,  
 three years \$63.00; Canada/Mexico—one year \$25.00,  
 two years \$47.00, three years \$69.00; Foreign—one  
 year \$27.00, two years \$51.00, three years \$75.00; For-  
 eign Air Mail—one year \$80.00, two years \$157.00,  
 three years \$234.00.

U.S. Government Agencies: Subscriptions to CQ are  
 available to agencies of the United States govern-  
 ment, including military services, only on a cash with  
 order basis. Requests for quotations, bids, contracts,  
 etc. will be refused and will not be returned or pro-  
 cessed. Entire contents copyrighted CQ Communi-  
 cations Inc. 1990. CQ does not assume responsibility  
 for unsolicited manuscripts. Allow six weeks for  
 change of address. Printed in the United States of  
 America.

Postmaster: Please send change of address to CQ  
 Magazine, 76 North Broadway, Hicksville, NY 11801.



# The Radio Amateur's Journal

**ON THE COVER:** Truman O. Moore, W7FCQ of Scottsdale, Arizona reads RTTY copy from an old Teletype® machine ... the type that had that wonderful machine smell and occasionally dripped oil on the floor. (Photo by Larry Mulvehill, WB2ZPI)



## NOVEMBER 1990

## VOL. 46, NO. 11

## FEATURES

SPECIAL PACKET USER'S NOTEBOOK: ROSES ARE RED AND BEAUTIFUL.....	Buck Rogers, K4ABT	10
CQ REVIEWS: THE GENWEST ENGINEERING VOICEBOX	Lew McCoy, W1ICP	18
HOW TO ADD 2400 BPS TO THE AEA PK-232	Buck Rogers, K4ABT	20
DXPEDITION TO JARVIS ISLAND, AH3C/KH5J	Peter H. Grillo, AH3C	24
CQ SHOWCASE: NEW AMATEUR PRODUCTS.....		36
CQ REVIEWS: THE ASTRON RS-50M AND RM-50M POWER SUPPLIES.....	Peter J. Bertini, K1ZJH	40
CQ REVIEWS: THE SIERRA TECHNOLOGIES 80386SX COMPUTER SYSTEM.....	Buck Rogers, K4ABT	42
<b>COMPLETE RULES FOR THE CQ WAZ AWARD PROGRAM.....</b>		50
AMTOR FOR BEGINNERS.....	Bill Henry, K9GWT	52
CQ REVIEWS: THE MFJ-1274/T 2400 BPS PACKET RADIO CONTROLLER.....	Buck Rogers, K4ABT	58
<b>ANNOUNCING: THE 1991 CQ WORLD-WIDE 160 METER DX CONTEST.....</b>		64
ANTENNAS & ACCESSORIES: ANTENNAS AND ATTICS, DO THEY MIX?.....	Karl T. Thurber, Jr., W8FX	66
WORLD OF IDEAS: TELEGRAPH KEY BONANZA	Dave Ingram, K4TWJ	79
WASHINGTON READOUT: FROM 15 BPS TO 50 MILLION— PROCESSING DIGITAL DATA.....	Frederick O. Maia, W5YI	98
BILL'S BASICS: PRINTED MATERIAL, PART I	Bill Welsh, W6DDB	104

## DEPARTMENTS

PROPAGATION: CW CONTEST TIPS, SHORT-SKIP CHARTS FOR NOV. AND DEC.....	George Jacobs, W3ASK	88	
AWARDS: STORY OF THE MONTH—HAROLD C. GRIFFIN, N4OA.....	Dorothy Johnson, WB9RCY	92	
CONTEST CALENDAR: RESULTS OF "ARE CONTESTERS REAL HAMS" SURVEY, CONTESTS FOR NOV. AND EARLY DEC.	John Dorr, K1AR	108	
DX: IS PACKET RADIO RUINING DX?; BEGINNER'S CORNER; NOV. DX ACTIVITY.....	Chod Harris, VP9ML	114	
ZERO BIAS.....	4	HAM SHOP.....	126
ANNOUNCEMENTS.....	9		

# ZERO BIAS

## EDITORIAL

**T**he other day I listened in on a QSO during which two amateurs were bemoaning the fact that a rare DX station was collecting loads of IRCs and green stamps and as a result could afford to buy a first-rate station. Obviously, they thought something was wrong with this situation and that somehow it was unfair that the DX station had better equipment than they did, while they as average amateurs seemed to subsidize the DX station in return for a QSL.

First, we have to appreciate the notion that the rare (or not so rare) DX station's reason for being is not just to give us a signal report and send a free QSL card. I know it's a silly notion, and a number of amateurs still feel that everything connected with the hobby should be for free. However, the best things in life usually have a price tag attached if you look close enough, and amateur radio is no exception.

While there is a modicum of truth to the saying "money can't buy happiness," if you managed to send a few IRCs and/or a few green stamps, tell me you were unhappy when you opened the envelope and took out the 3Y5X QSL card. I'll even bet that the memories of the pile-ups, the rudeness, and the bad operating faded away. That QSL card, in hand, was suddenly worth a few bucks, and most of us would gladly do it again.

The two cynics I overheard are certainly not alone. Amateur radio has a number of them. However, I'm glad to say that we also have a goodly number of optimists. Without the optimists we wouldn't have any of the new and yet-to-come technologies that the rest of us enjoy and look forward to. As you look through this issue and read the articles and examine the advertising, keep in mind that optimism created it all.

People write articles generally because they have found a solution to a problem and they would like to share it, or they have come up with something new that perhaps might be of benefit and can be built upon.

The people who advertise with us all believe that they truly offer a beneficial product we can utilize and enjoy. All in all, a lot of work and effort goes into writing articles, manufacturing products, selling products and providing services, and yes, even producing monthly amateur radio magazines. All of it is optimistic, for we all feel that something good is coming from this effort. Part of that good is the ability to earn a living or to augment our

income out of what we do.

The above group of optimists share the common trait of being visible. We all know who they are either individually or by company name. Even the rare DX station who justifiably asks for return postage (to do with as he chooses) is known to us and the cynics. However, there is another group of optimists out there whom most of us never get to meet.

There are the optimists among us who dream and push the edges of technology out farther and farther. For the most part, we never know who they are or, even if we thought about it, how to thank them. These unrecognized creators of technology go unnoticed and unnamed by those of us who seize upon the new technology and use it as if it has always existed for our benefit. I don't know most of their names either, but I guess I can offer a collective thank you from all of us.

We look at the articles and ads in this issue and probably never stop to think of the individual or individuals who came up with the ideas for the technology. We accept the multi-featured modern transceiver or the multi-mode TNC as a given. Both use technology that probably wasn't around ten years ago, and in some cases five years ago. We find it hard enough to try to utilize and understand these features. Imagine having to devise and engineer them in the first place.

Perhaps somewhere down the line some manufacturer, for example, will put a page in the operating manual stating that the following people helped to create the product that you are about to use and enjoy. If necessary, it could even be amended to include a statement that the original work in this field was done by whomever. Somehow in our rush to consume technology we lose an appreciation of that technology and what it took to create it.

In amateur radio we zip through the overwhelming complexity of modern gear and really give no thought to how it was created. The cynics will examine the latest ultimate (for now) transceiver and slough it off, stating that *if* they were going to buy one, they would wait for the B Model. If and when there was a B Model, they would wait for a C Model.

Let's face it. The cynics of our hobby produce nothing but aggravation for themselves and occasionally for others. A lot of optimists helped to create this issue for you to enjoy. The technology that you are about to read and examine in our ads is exciting, but in the course of things

it will be a source of amusement in 20 years. However, the time is now, and there is a tremendous amount of amateur radio technology that is *here* right now, devised by fellow amateurs for us to enjoy, learn from, and, for a few, to be afraid of.

It's November, and Christmas is only a month away. If you haven't started your shopping or haven't left your "Wish List" around by now, shame on you. This month's issue might trigger some new items for your "Wish List" and give you a few new areas of amateur radio expression to think about.

We've worked Buck Rogers, K4ABT, pretty hard in this issue as you can tell by checking the table of contents. Buck has come up with some new twists to packet radio and some reports on where packet is heading. If you've been putting off trying AMTOR, check Bill Henry, K9GWT's article "AMTOR For Beginners" and get in on what's happening there.

Now we can't forget amateur radio's cynics this holiday season either. For those who think everything is too much money and people should build their own rigs exclusively, we are working on a special deal for them (or you). First, for a modest sum, a carton containing 3,894 discrete components plus 11 pounds of assorted hardware will be made available. For larger metal pieces or similar fabrication, a time-sharing allotment has been arranged with several mines and smelting and forging plants. For another slight fee a list of where to buy, lease, or rent test and programming equipment will be provided. Oh, this isn't a kit. A kit implies plans and how-to information. This package contains some blank paper and a few pencils so you can roll your own. After all, real hams can do these things.

For the rest of us who are trying to enjoy amateur radio and have some fun with it, there's still a sense of amazement and awe connected with some of these new "toys." No, I can't design or build most of it, but then again I can't build a car either. I can and do appreciate the people who can do those things, and I can spend some time trying to learn about what's new. Still, to me the most curious aspect of new technology is what went on in the mind of the first person to think of it. It's seeing or imagining something that didn't exist before and then figuring out a way to do it, all without a frame of reference.

73, Alan, K2EEK

# KEEP YOUR COOL

## with AEA's NEW LA-30 HF Linear Amplifier

### WHAT DO HAMS EXPECT WHEN THEY SEE THE AEA NAME ON A PRODUCT?

#### Quality and Value.

They expect mechanical and electrical integrity.

They expect the best possible physical construction. They expect a product that will look and perform as advertised for years to come.

They expect the support they need, before, during and after the sale.

They don't expect promises that can't or won't be delivered.

They don't expect the frustration that comes from products that don't perform as advertised, or technical support that's less than supportive.

They don't expect to spend their hard-earned money, just to lose their cool.

#### THE LA-30 DELIVERS!

The LA-30 HF Linear Amplifier delivers what hams expect from AEA.

Designed to provide reliable, stable, high RF output power, the LA-30 is equipped with a pressurized plenum and chimney cooling system to ensure extended periods of continuous use and longer tube life. We use a low-noise "squirrel-cage" blower that moves 30 cubic feet of air per minute past the tube and its base seal to help the LA-30 keep its cool. Others use computer type "muffin" blowers that don't cool the tube seals, and therefore shorten tube life.

Have you priced RF power tubes lately? They're not cheap. And when one goes out before you expect, you're bound to lose your cool.

#### QUALITY

We install parts that are designed to last, rather than cutting corners to reduce costs.



You won't find any shortcuts in our amplifiers. The LA-30 is the latest in a long line of high quality AEA products, going back over 12 years.

All aluminum parts are "alodized" to keep your LA-30 looking new. Alodizing is an expensive priming process that improves the metal's appearance and helps protect against scratching and corrosion. Make sure the amplifier you choose has alodized aluminum to keep it looking new for years to come.

We could cut manufacturing costs in other ways—such as using cheaper "self-tapping" screws and lower-quality aluminum—but then the unit just wouldn't meet our standards. Remember, only AEA amplifiers are built with AEA quality.

#### EASY TO USE.

With the LA-30's patent-pending cross-needle tuning bar meter system, we've eliminated the guesswork. You always know at a glance if the LA-30 is in tune. One dual-movement meter measures both plate and grid current simultaneously, which are both crucial to proper operation and extended tube life. The front panel controls are logically arranged and are marked with clear, easy-to-read markings and scales.

#### KEEP YOUR COOL!

Don't be fooled into buying an imitation when you can own an AEA. This compact self-contained tabletop unit will provide you with years of excellent performance. The LA-30 Linear Amplifier is the best HF

amplifier value on the market today, because of AEA.

### Engineering Makes the Difference!

#### SPECIFICATIONS:

<b>Freq. Range</b>	Amateur Bands 160-10 meters*
<b>RF Input Power</b>	SSB 1.2 KW P.E.P. CW/RTTY/AM/FM/ SSTV 1.0 KW
<b>Power Tube</b>	3-500Z zero-bias triode
<b>Supply Voltage</b>	110 VAC
<b>Dimensions</b>	14"W x 7½"H x 16½"D (36 x 19 x 42 cm)
<b>Weight</b>	35 lbs. (15.9 Kg.)

QSK modification available.

\* 10 meter mod. requires amateur license.



Advanced Electronic Applications, Inc.

2006-196th St. S.W./P.O. Box C2160 Lynnwood, WA 98036 (206)775-7373

Prices and applications subject to change without notice or obligation.

©Copyright 1990 by AEA, Inc. All Rights Reserved.



# ALINCO ELECTRONICS INC.



## DR-590T (NEW)

### VHF/UHF Twin Band Mobile

144-147. 995Mhz(RX137—173. 995Mhz)  
440-449. 995Mhz(RX410—469. 995Mhz)

45W Hi, 10W Mid., 5W Low on VHF

35W Hi, 8W Mid., 5W Low on UHF

Cross Band Repeater Function Simultaneous Receiving and Scanning on both Band

Front Control Panel is detachable. Remote Control will be available (Option)

MARS and CAP Modifiable (permit required)



## DR-570T

### Set your sights for dual!

The Alinco DR-570T "Twin Bander" has dual LCD readout, volume, squelch and tuning controls. Double barreled power with 45W on 2M and 35W on 70 cm, plus simultaneous receive on both bands or intermix with four modes of scan. The DR-570T will win the "battle" with its illuminated front function panel and LCD readout, readable in any lighting conditions. Don't let the "Tiny" DR-570T fool you! It's fast, and leaves the competition in the dust with many standard features you expect. Cross band-repeat with the flick of a switch. Full duplex, 20 memory channels, call channels, 16-key DTMF Microphone, and subtones are just a few. "Reach" for the DR-570T today!

## DR-110T & DR-410T

### Tiny 2M Power From Alinco!

DR-110T, this 2M Alinco, enters the nineties a proven winner with the "reputation" of best value. The DR-110T packs a powerful 45W on 2M and sports all the features you expect in today's transceivers. Tuning is a snap with the multi-functioned easy-to-see keyboard, 14 memory channels, subtones, scan, multi-colored LCD readout, reverse, are a few of the many features of the DR-110T. The mobile of the future-today! DR-410T available for 70 cm.



## DR-510T

### Best Dual Value on the Market!

The Alinco DR-510T has most of the outstanding features of its sister the DR-570T, including 14 memory channels, cross band duplex and cross band repeat. The multi color LCD display, and simple tune control panel makes simplicity the key word. The DR-510T with 45/35 watts is the best, featurepacked dual bander on the Amateur market today. See the DR-510T along with the other Alinco "Magnificent" ones at your favorite dealer today!

## DR-112T (NEW)

### Full Featured 2M Power Pack

The DR-112T is a "True FM" full-power (45 watts) transceiver. The backlit LCD display is ideal for bright or dim lit conditions. And, as with most Alinco products, the control panel is engineered to be "User friendly" and still offer a full range of features.







# ALINCO ELECTRONICS INC.

## DJ-560T (NEW)

Full Featured  
Twin Band Handy

We packed almost all of the features you would find in a full sized mobile Twin Bander into this compact HT. The DJ-560T has key board entry, CTCSS encode built in, several scanning modes, 40 memories, fully programmable, Autodialer, Dual Display (2 Meter & 70 Cm). The DJ-560T is sitting on top of the mountain.



## DJ-100T & DJ-120T & DJ-200T

Best 2M Micro Value

The Alinco DJ-100T/DJ-120T is "Magnificent" for its tiny size, but stands up to the competition with power and capability. 10 memory channels store offsets and subtones. Has LCD readout with call channels and reverse at your fingertips. 500 mah battery with direct DC to DC is standard. 3W on standard battery, 6W on optional battery leaves the competition in the dust! DJ-200T for 220 Mhz.

## DJ-500T

Power-Packed Dual Handil!

20 Memory channels, subtones, built-in DC to DC, 700 mah nicad battery, LCD readout with 6W on 2M and 5W on 70cm (with optional battery) call channels, DTMF Touchtone, and direct keyboard entry, are just the few winning features of the Alinco DJ-500T Dual Band Handheld. Easy to use, and Value Priced at your Alinco Dealer.

## DJ-160T & DJ-460T

2M H/T is here! And wow!

"Bells & Whistles" is a tame word to use for the new DJ-160T, newest "Magnificent" one from Alinco. Keyboard entry is just one of four ways to enter a frequency in the extended receiver (137-173.995 Mhz) of the DJ-160T. You can store duplex /simplex pairs in any of 20 Memories, or Call Channel, with offsets, and any of 38 encoding subtones. Choose one of 3 scan modes, "Band" "Program" or "Memory" and one of five step ranges in VFO. Priority mode can be used in VFO, Memory or Call. "Dual Watch" allows the DJ-160T to scan 3 seconds alternately on CALL, VFO or one MEMORY. "Pager" is for group or single person alert. Other features include: Auto "Battery Save", Auto "Power Off", and 2-Memory Autodialer. Get 3-watts on standard 700 mah battery, or increased power from built-in DC to DC, or optional 12V battery. The Alinco DJ-160T, now the "Top Gun" with the competition today! DJ-460T for 70 cm.



CIRCLE 10 ON READER SERVICE CARD

ALINCO ELECTRONICS INC.

438 AMAPOLA AVE., LOT 130, TORRANCE, CALIFORNIA 90501  
TEL: (213) 618-8616 • FAX: (213) 618-8758

**NEW  
DUAL BAND RINGO**

# Cushcraft

## AR-270 (2m/70cm)

*The engineering hams at Cushcraft bring to you an all new computer aided design.*

AR-270 uses the latest technology to give excellent gain and low angle radiation in a durable all aluminum antenna. It is a perfect choice for FM simplex, repeater or packet radio. Enjoy the full performance of your dual band radio with this exciting new antenna.

- Excellent gain
- Broadband, minimum VSWR
- All aluminum - reduces static build-up
- No painted surface to chip peel or crack
- UV stabilized insulators
- Precision wound coils won't detune
- SO-239 connector
- Less than 4 feet high
- DC ground for lightning protection
- Mounting flexibility
- Rust free stainless steel hardware
- RF de-coupling eliminates TVI
- Amazing performance

AR-270 144-148 MHz  
435-450 MHz

## RINGO RANGERS

*The world's most popular 2 meter, 1 1/4 meter and 70 cm antennas.*

They stand tall to give you more performance and wider area coverage. Ringo Rangers are your best single band antenna choice for FM repeaters, simplex or packet radio. There are many imitations, but none equal the value of a Ringo Ranger.

- Excellent gain and bandwidth
- Optimum low angle radiation
- Broadband with low VSWR
- Highest power rating
- Built in lightning arrester
- RF de-coupling radials
- All weather performance
- SO-239 connector
- Rust free stainless steel hardware
- Slim profile for better appearance
- Durable static free aluminum
- Traditional Cushcraft value

ARX-2B 135-160 MHz  
ARX-220B 220-225 MHz  
ARX-450B 435-450 MHz  
ARX-450BN\* 435-450 MHz

\* N connector

AVAILABLE THROUGH  
DEALERS WORLDWIDE

 **Cushcraft**  
CORPORATION

P.O. BOX 4680 • 48 PERIMETER ROAD  
MANCHESTER, NH 03108 USA  
TEL: 603-627-7877 • FAX: 603-627-1764

CIRCLE 69 ON READER SERVICE CARD

# ANNOUNCEMENTS

• **N3EKX from Washington, DC** - HAM-VETS will operate N3EKX near the Vietnam Veterans Memorial in Washington, DC on Nov. 10 and 11 to commemorate Veterans Day. Operation will be on 20, 40, and 75 meters in the General portion of bands. For QSL send QSL and SASE to K9ICF, 13300 Wye Oak Drive, Darnestown, MD 20878.

• **WB3L from Pittsburgh, Pennsylvania** - WB3L will operate on Nov. 10-11 to commemorate "Light Up Night at the Point" from 1300-2400Z on 7.240, 14.240, 21.340, and 28.340. For QSL send your QSL and SASE to ARS WB3L, 3444 Bench Drive, Pittsburgh, PA 15236.

• **AB4TT from Clinton, North Carolina** - The Sampson County ARS will operate AB4TT on Nov. 8 from 1700-2400Z for the Sampson County Expo and Pork Festival. Operation in lower portion of General bands plus 10 meters, 28.100-28.500. QSL via SCARS, P.O. Box 64, Clinton, NC 28328.

• **K4AIF from Brevard, North Carolina** - The Transylvania County ARC will operate K4AIF to celebrate Halloween from the Devil's Courthouse in Transylvania County. Operation from 2100Z Oct. 31 to 0200Z Nov. 1 on 3.860, 14.295, 50.150, all SSB and 146.52 (FM simplex). For certificate send SASE (legal size or 9 x 12) to K4AIF, Dick Gustafson, 302 Wilson Drive, Brevard, NC 28712.

• **W4IAX from Dauphin Island, Alabama** - W4IAX will be "Live from the Island," Dauphin Island, from 1300Z Nov. 17 to 0000Z Nov. 18 on 3925, 7225, 14225, 21325, and 28325 MHz. QSL with business-size SASE and \$1.00 for certificate to W4IAX, Mobile ARC, P.O. Box 9315, Mobile, AL 36691.

• **W4MM from Calvary, Georgia** - The Albany ARC will operate W4MM from the 18th Mule Day Festival on Nov. 3 from 1300-2000Z on 28.383, 14.320, 7.260, and 3.975. For certificate send SASE to AARC, P.O. Box 70601, Albany, GA 31707-0011.

• **The following hamfests, etc., are slated for Nov.:**

Nov. 3-4, **Ham Radio & Computer Expo 1990**, Gwinnett County Fairgrounds, Lawrenceville, GA. Contact Alford Memorial Radio Club, P.O. Box 3100, Lithonia, GA 30058.

Nov. 4, **Fox Cities ARC Hamfest**, Starlite Club, Kaukauna, WI. Contact Don Baker, 621 W. Seventh St., Ksukauna, WI 54130 (414-766-3886). (Testing at 9 AM)

Nov. 10, **New England DX Convention**, Sheraton Tara, Framingham, MA. Contact Joe Green, K2VUI, 8 Wedgewood Rd., Wellesley, MA 02181 (617-239-1370).

Nov. 10, **"6.91 Friendly Fest,"** Serb

Hall, Milwaukee, WI. Contact The Milwaukee Repeater Club, P.O. Box 2123, Milwaukee, WI 53201 (SASE). (Exams)

Nov. 10, **Twin Cities Hamfest**, West Monroe Convention Center, West Monroe, Louisiana. Contact Benson Scott, AE5V, 745 40 Oaks Farm Rd., West Monroe, LA 71291-9432 (318-323-3478). (Handicapped facilities; VE exams)

Nov. 11, **Shore Area Ham Radio & Computer Clubs Hamfest**, Allaire Expo Center, Allaire, NJ. Contact Al Jackson, NK2O, P.O. Box 635, Eatontown, NJ 07724 (201-922-8121). (VE exams)

Nov. 11, **SCARA Ham Radio & Computer Fleamarket**, North Haven Park and Recreation Center, North Haven, CT. Contact SCARA Fleamarket, P.O. Box 81, North Haven, CT 06473 (SASE), or call Brad at 203-265-6478 from 7 to 9 PM.

Nov. 11, **Massillon ARC Auctionfest '90**, Massillon K of C Hall, Massillon, OH. Contact MARC, P.O. Box 73, Massillon, OH 44648 (SASE).

Nov. 17-18, **18th Annual Ft. Wayne, Indiana Hamfest**, Allen County War Memorial Coliseum Exposition Center, Ft. Wayne, IN. Contact ACARTS, P.O. Box 10342, Ft. Wayne, IN 46851 (SASE), or call 219-693-3766 (evenings). (VE exams)

Nov. 17-18, **1990 ARRL Suncoast Convention**, Curtis Hixon Convention Center, Tampa, FL. Contact Jean Endicott, KC4KZU, 813-525-5178. (Exams)

Nov. 18, **Tri-State Hamfest & Computer Fair**, The Meadows Racetrack, south of Pittsburgh, PA. Contact Walt Piroth, N3BKW, PBBS N3BKW KA3MZS, (D) 412-258-5353; or WACOM, P.O. Box 1386, Washington, PA 15301. (VE exams)

Nov. 24, **Montgomery, Alabama Hamfest**, Garrett Coliseum, South Alabama State Fairgrounds, Montgomery, AL. Contact Hamfest Committee, c/o 2141 Edinburgh Drive, Montgomery, AL 36116, or call Phil at 205-272-7980 (after 5 PM CST). (Exams)

Dec. 3-9, **Africa Telecom 90**, Harare International Conference Centre, Harare, Zimbabwe. Organized by the ITU and Posts and Telecommunications Corp. of Zimbabwe, the event will be an exhibition and special session of the World Telecommunication Forum. For more information, contact Posts and Telecommunications Corp., P.O. Box 8061, Causeway, Harare, Zimbabwe (telephone + 263 4 728811; FAX + 263 4 731989).

**Corrections Department:** Please note that the author of "A Remote Base Controller for the ICOM 2AT" in the September issue has moved. Ron DeSilva, NU6F's new address is P.O. Box 9216, Auburn, CA 96504.

## STOCK SERVICE SUPPORT

The **Sierra Technologies 386 SX** Advanced Mini-Tower Computer operates at 16 MHz providing reliable high-speed performance for the most demanding user...contest logging to packet radio.

*It does it all!*

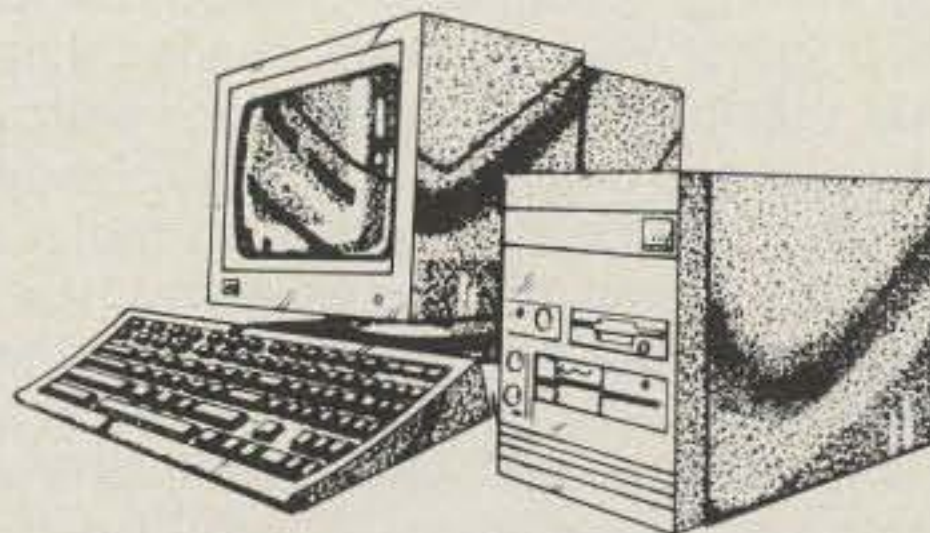

Sierra Technologies stands behind their products with factory service. Additionally, the technical support staff will handle call-in problems. A one year parts and labor guarantee is provided on your purchase.

### What You Get

Sierra Advanced 386 SX 16 MHz Mini-Tower Computer

- 1 MB of 80 ns Dynamic Random Access Memory (DRAM)
- 40 MB Hard Disk — IDE 28 ms Access Time
- 5¼" 1.2 MB High Density Floppy Drive
- 3½" 1.44 MB High Density Floppy Drive
- 2 Serial, 1 Parallel, 1 Game Port
- Clock / Calendar
- Floppy / Hard Drive Controller Card
- Enhanced 101 Click Keyboard
- 14" Super VGA Monitor 1024 x 768, .29 dot pitch. Tilt Swivel Stand.
- 16 bit VGA Card with 512K memory

Amateur Net: **\$1895\***  
Call to Order **1-800-543-2237**

Free Shipping on prepaid and credit card orders

**Sierra**  
TECHNOLOGIES GROUP

143 John Sims Parkway  
Valparaiso, FL 32580  
Tech Support 1-904-729-3447  
See Review in November 1990 *CQ Magazine*  
\*Prices Subject to Change Without Notice

CIRCLE 15 ON READER SERVICE CARD

November 1990 • CQ • 9

**"A rose is a rose is a rose," said Gertrude Stein many years ago. However, as K4ABT points out in this special "Packet User's Notebook" column, a rose can be so much more.**

# ROSEs are Red and Beautiful

BY BUCK ROGERS\*, K4ABT

The very thought of a rose brings thoughts of a silky, smooth cluster of petals that presents the observer with a bouquet and beauty that can only be described by one's own optical and fragrance-sensing palettes. In some distant past there was a meaningful cliché that went something like this: "Beauty is in the eyes of the beholder." Well, here in this month's special column we are going to discuss that very truism: The Beauty of the "ROSE."

## What is a "ROSE" Packet Switch?

The ROSE switch is the first amateur

\*506 Pheasant Ridge Drive, Warner Robins, GA 31088

packet networking program that uses the International Standard protocol for packet networks—CCITT X.25. The program is meant to be installed in place of the EPROM found in a TNC-2 (or clone) packet controller. It easily replaces TheNet and Net/Rom systems. It provides greater throughput with less overhead and less node updating garbage. Without deliberating, we'll use the list of features from the ROSE documentation:

ROSE X.25 packet switch offers the following features.

- Hop-by-Hop Acknowledgments between Switches—provides reliability and higher throughput.
- On-line Information—Information/Help SYSPO text supplied.
- FCC and foreign PTT acceptable AX.25 Level 2 SOURCE and DESTINATION Identification—the callsigns of both

the station of origination and termination appear at each end of the connection.

- Proper Transmitter Licensee Identification—switch always identifies its transmissions with its own callsign, not the callsign of any user. Callsigns traverse the network without adding any extra SSID or other changes.

- Backbone is Fully Transparent to Users—can add or remove switches in the backbone, change callsigns, bands/frequencies without having to inform users or modify BBS forwarding files.

- True Implicit Addressing—only need to know the address of the desired exit point of the network, not all the intermediate steps.

- Network Determined Routing—network manager determines best path, eliminating need for broadcasting of routing information to other switches.

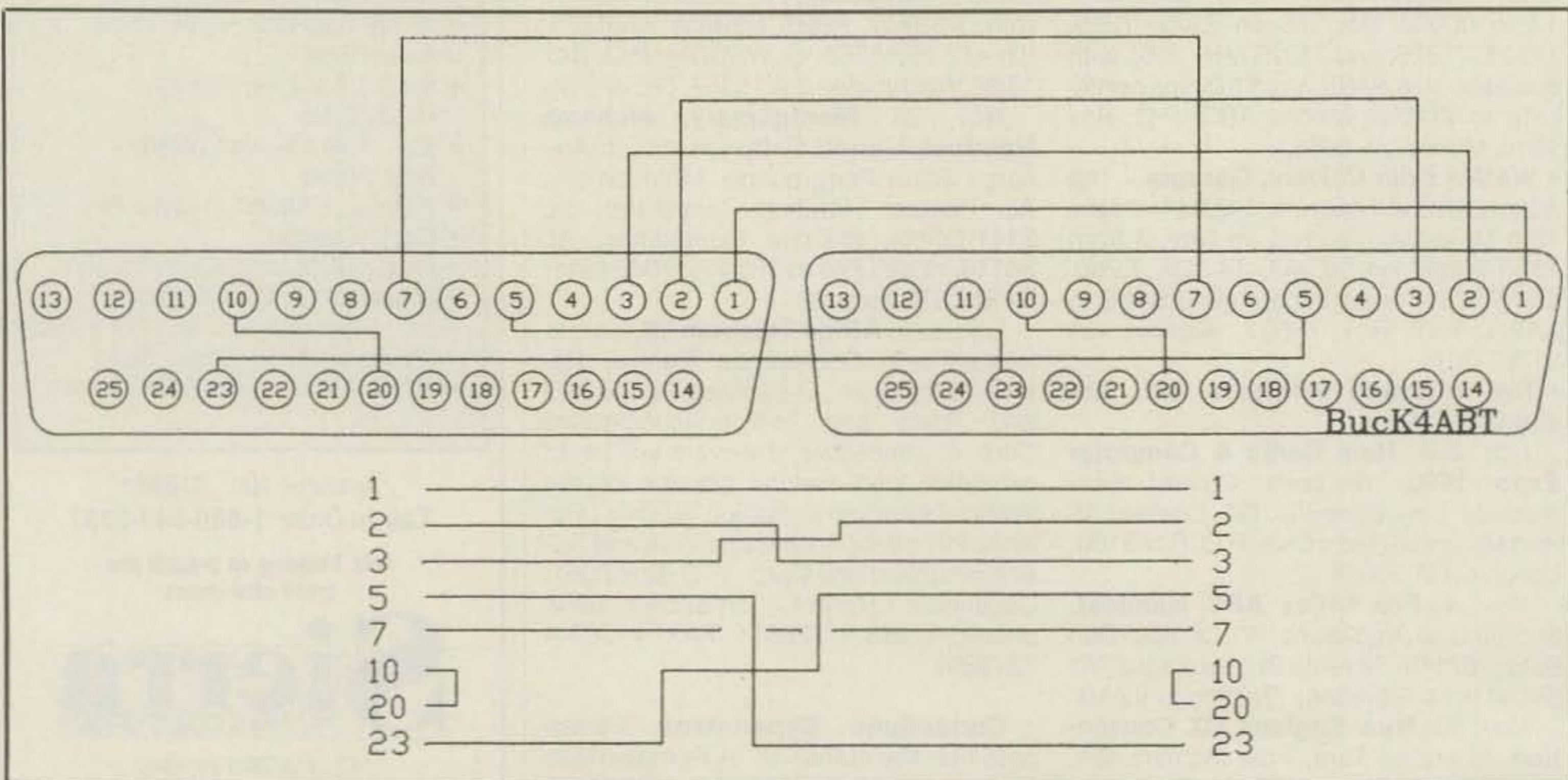

Fig. 1—RS232 interface cable/connectors used to interconnect two ROSE switches for the purpose of "gateway" between two different frequencies, or from 1200 to 2400 bps and vice versa. Note the transition of pins 2 to 3 and 3 to 2. Also notice that pins 5 and 23 are "transitioned."

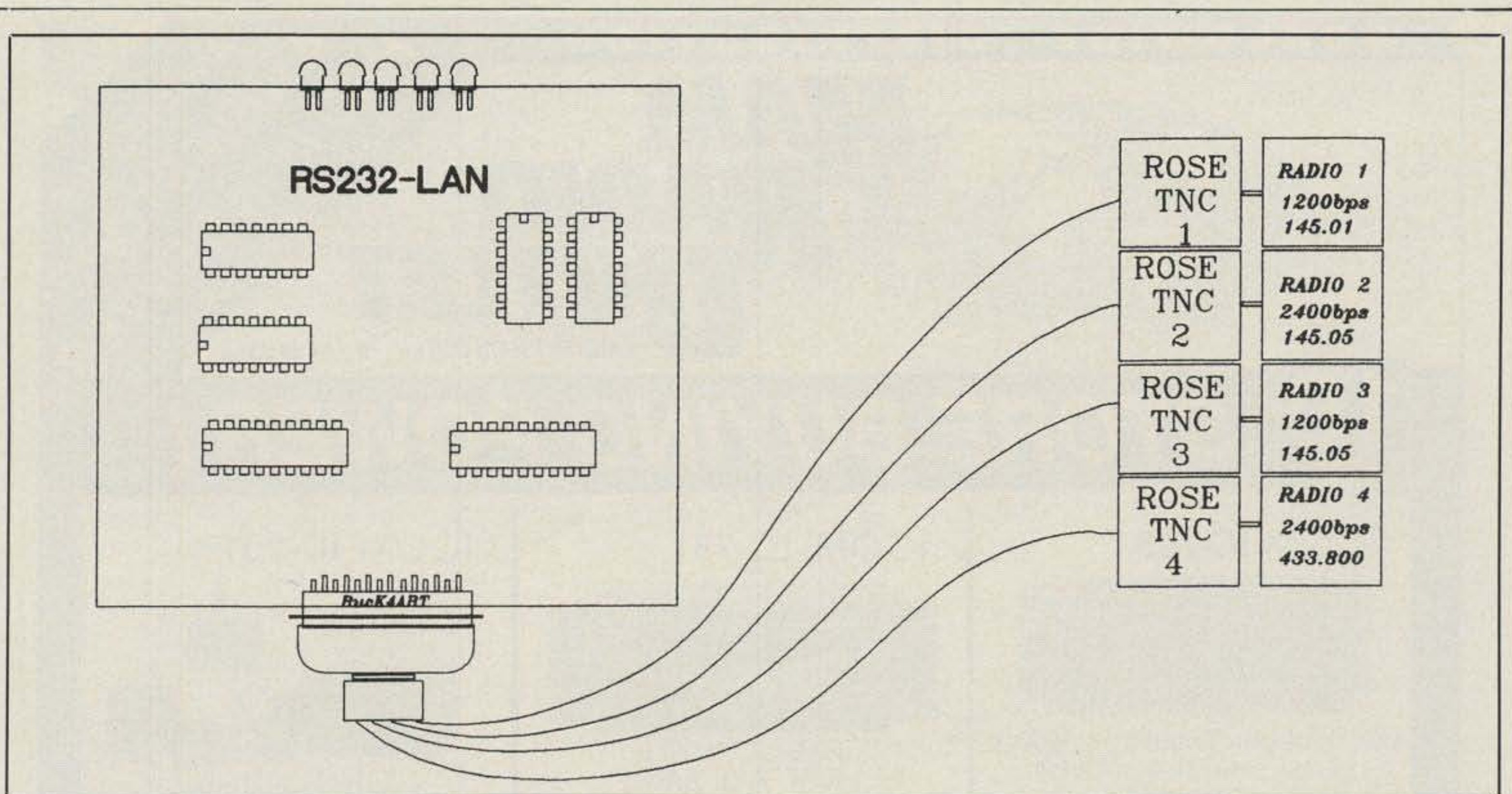

Fig. 2- If your "bouquet" of ROSES is in a cluster of more than two switches, then you will need to use the "RS232-LAN" (see text). The switches can "gateway" to each other in any manner you choose. Configuration is the option of the network manager.

- Dynamic Route Selection—network will automatically attempt alternative paths to remote switches, based on information the network manager provides.

- Predetermined Network Paths—network manager tells each switch which paths to use, will not attempt impossible links because another switch was heard during a band opening.

- Support for Emergency Operations—a switch can be added to the network to provide service from the afflicted area without modifications to the existing network.

- Security System for Remote Control—authentication of user who requests to view or modify configuration.

- The ROSE X.25 packet switch runs on any TNC-2 clone or compatible TNC. Some of the TNCs that are used in our system are the MFJ-1270B, MFJ-1274, MFJ-1270T (with turbo, 2400 bps), PacComm TNC200, PacComm Tiny-2, PacComm MicroPower, and Pac-Comm Dual Port DR-200.

- Full Radio Support on Asynchronous Port—the asynchronous port of a TNC can be attached to a 202, or any other modem with an RS-232 interface and radio, providing a dual port system. The second port is AX.25 using the Asynchronous Framing Technique (AFT) that was proposed by Toby Nixon of Hayes, which is pending CCITT adoption as the accepted method for sending X.25 over asynchronous links.

- Multi-Synchronous Ports using TNCs—since the asynchronous port has full radio support, it also can support one

or more switches via a special (commonly available) RS-232 cable.

- Complete Remote Configuration—all configuration is done over the air; many parameters can also be burned into the EPROM.

- Battery Backed-up Configuration—all routing information is retained when the power is removed. No need for manual intervention when power is restored.

## Background

A few years ago an organization called the Radio Amateur Telecommunications Society (RATS) was formed. Within this organization there is a young man who stands tall among the greatest software writers. In addition, he is well studied in the field of telephony and packet switching systems. His name is Tom Moulton, W2VY. Tom wrote and developed a networking matrix with a different twist and named it in a manner that commemorated "RATS." He called it "RATS Open Systems Environment." Thus, we have the foundation from which the ROSE began. From this point on I'll refer to the "RATS Open System Environment" as the ROSE.

I picked up some information about ROSE technology from some other packet enthusiasts at the Dayton Hamvention two years ago. Having read the documentation that I received at Dayton, my interest was more than just keen. It was razor-sharp. I could not rest until I had talked with the author of this system.

There was no doubt about it. W2VY had developed something good and it was time to let the rest of the packet radio and digital communications world experience it. I gave Tom a call.

## The True Meaning Of "Multi-Tasking"

The task of installing a new topology into a packet network can be monumental. However, the end results can often be worth the effort many times over. I've spent many months studying this networking scheme developed by W2VY. I first wrote about the ROSE in the "Packet User's Notebook" a little over a year ago. At that writing I mentioned, "Here could be a far better network format, and a possible alternative to the nodes that a lot of folks have been bickering about."

Between the time I first introduced the readers of CQ to the ROSE and the present, the author has built more features into the ROSE code. A big improvement is also noted in some needed SYSOP functions.

In an open-minded effort to give this new version of ROSE my best shot, I set up two ROSE switches to make some tests. They worked, and they worked so well that I added a third switch to the system. This was some kind of evolution, for it was not long before there were 23 ROSE switches in use throughout the state of Georgia on 145.05 MHz. We are presently running version 900713.

WORLDWIDE DISTRIBUTION

EA  
RONICS  
CUSHCRAFT  
ICOM  
HY-GAIN  
BIRD  
MFJ  
YAesu  
CUSH  
IRD  
US TOWER  
BUTTERNUT  
TEC  
ALLIA  
BIRD

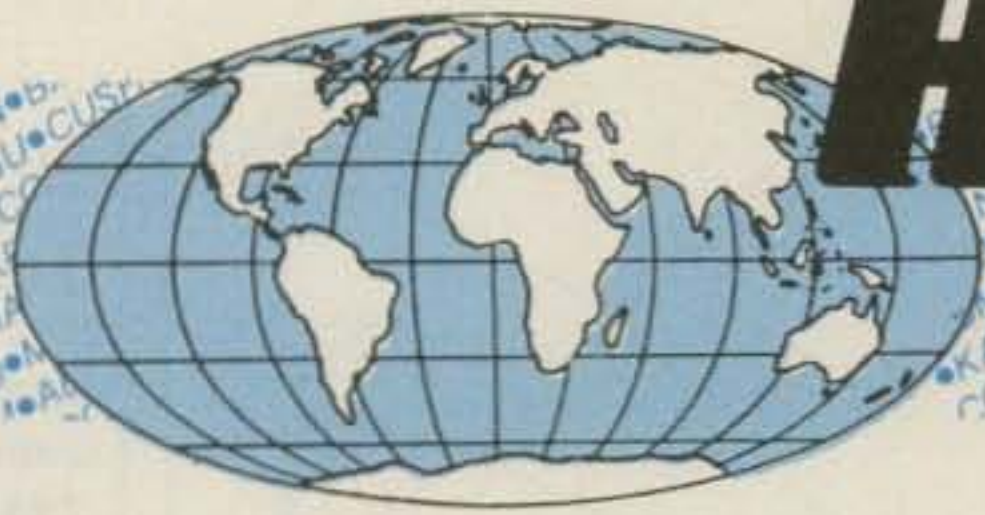

# HAM RADIO OUTLET

LARGEST HAM OUTLET IN THE WORLD

ANNOUNCING  
A NEW STORE!  
HRO is in DENVER!  
— GRAND OPENING THIS MONTH! —

## 10 STORE BUYING POWER!

### ICOM IC-765



100W GENERAL COVERAGE RECEIVER  
HF ALL BAND TRANSCEIVER  
Maximum Operation Flexibility

**SALE! CALL FOR PRICE**

### ICOM IC-781



THE ULTIMATE  
150 W, ALL BAND  
HF TRANSCEIVER

**GREAT PRICE!**

### ICOM IC-901

FIBER OPTIC  
MULTI-BAND  
TRANSCEIVER



2 METER AND 440 MHz  
EXTRA-LARGE MULTI COLOR LCD  
HM14 TOUCH TONE MICROPHONE

**CALL FOR PRICE**

### ICOM A Models 25 WATTS H Models 100 WATTS

IC-275A/275H, 138-174 MHz  
IC-475A/475H, 430-450 MHz



**LOW PRICE!**

### COAST TO COAST



**HRO = Rapid deliveries from the store nearest you!**

### ICOM HAND-HELD VHF/UHF MICRO SIZE

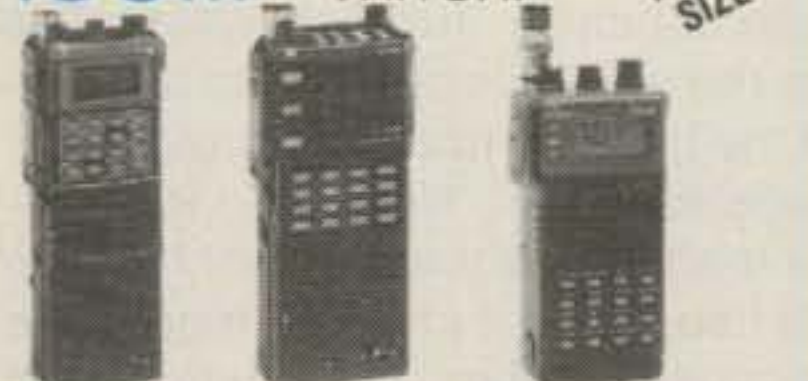

IC-32AT Dual Band Hand Held  
IC-2GAT 2 Meter HT 7 WATT  
IC-4GAT 440 MHz 5 WATT  
IC-2SAT, 2 MTR  
IC-3SAT, 220 MHz  
IC-4SAT, 440 MHz  
IC-24AT, Duo-Band

### ICOM IC-2400A/3220 2m/440 MHz / 2m/440 MHz



IC-2400A shown

VHF/UHF DUAL BAND  
FM TRANSCEIVER

### ICOM IC-229H 2 METER MOBILE



50 W/20 Memories/Small Size  
Extended RX Coverage, 118-174 MHz

**GREAT PRICE**

### ICOM IC-725



100W GENERAL COVERAGE RECEIVER  
HF ALL BAND COMPACT TRANSCEIVER

**GREAT PRICE**

**FREE Shipment!**

most items over \$100 UPS surface



**Bob Ferrero W6RJ**  
President/Owner

**Jim Rafferty N6RJ**  
VP - National Sales Manager

**ANAHEIM, CA 92801**  
2620 W. La Palma  
(714) 761-3033  
(213) 860-2040  
Between Disneyland & Knotts Berry Farm

**ATLANTA, GA 30340**  
6071 Buford Highway  
(404) 263-0700  
Larry, WD4AGW, Mgr.  
Doraville, 1 mi. north of I-285

**BURLINGAME, CA 94010**  
999 Howard Av.  
(415) 342-5757  
Rich, WA9WYB, Mgr.  
5 mi. south of SFO on 101

**NEW STORE!! DENVER, CO 89231**  
8400 E. Iliff Ave., #9  
(303) 745-7373  
(800) 444-9476

**OAKLAND, CA 94606**  
2210 Livingston St.  
(415) 534-5757  
Rich, WA9WYB, Mgr.  
I-880 at 23rd Ave. ramp

**PHOENIX, AZ 85015**  
1702 W. Camelback Rd.  
(602) 242-3515  
Gary, WB7SLY, Mgr.  
East of Highway 17

**SALEM, NH 03079**  
224 N. Broadway  
(603) 898-3750  
(800) 444-0047  
Paul, NW1U, Mgr.  
Exit 1, I-93, 28 mi. no. of Boston

**SAN DIEGO, CA 92123**  
5375 Kearny Villa Rd.  
(619) 560-4900  
Tom, KM6K, Mgr.  
Highway 163 and  
Claremont Mesa Blvd.

**VAN NUYS, CA 91411**  
6265 Sepulveda Blvd.  
(818) 988-2212  
Al, K6YRA, Mgr.  
San Diego Fwy. at Victory Blvd.

**WOODBIDGE, VA 22191**  
14803 Build America Drive  
(703) 643-1063  
(800) 444-4799  
Curtis, WB4KZL, Mgr.  
Exit 54, I-95, South to US 1

**CALL TOLL FREE NOW! Toll free in California!**

WEST 1-800-854-6046 MID-WEST/COLORADO 1-800-444-9476 SOUTHEAST 1-800-444-7927 MID-ATLANTIC 1-800-444-4799 NEW ENGLAND 1-800-444-0047

(call routed to nearest store) Toll free incl. Hawaii. Local phone hours, 9:30 AM to 5:30 PM. AZ, CA, CO, GA, VA residents, add sales tax. WALK-IN HOURS: 10AM-5:30PM - CLOSED SUNDAYS. Prices, specifications, descriptions, subject to change without notice.

WORLDWIDE DISTRIBUTION

# HAM RADIO OUTLET

LARGEST HAM OUTLET IN THE WORLD

ANNOUNCING  
A NEW STORE!  
HRO is in DENVER!  
— GRAND OPENING THIS MONTH! —

**10 STORE BUYING POWER!**



## YAESU FT-4700 RH

2 MTR/440 MHz 50W/40W

REMOTE HEAD DESIGN



**GREAT PRICE!**



## YAESU FT-1000

200 WATTS RF power output  
Built-in TCXO Dual VFO's



**CALL FOR PRICE**



## YAESU FT-470

COMPACT DUAL BAND  
2m/70cm  
FM Transceiver  
Built-in 10 memory  
DTMF autodialer



**GREAT PRICE!**



## YAESU FT-736R

VHF/UHF All Mode Transceiver

THE ULTIMATE OSCAR MACHINE



**• November 17 •  
GRAND OPENING  
DENVER STORE!!**

**YAESU**

• See YAESU product demos!

**DAY IN**

• Talk to YAESU representatives!

**DENVER**

• Prizes! Free refreshments!



## YAESU FT-757GX/II



Compact HF Mobile Transceiver



## YAESU FT-411 HANDHELD

Standard 2.5W  
49 Memories  
2m/140 to 174 MHz  
EXTENDED RECEIVE



**CALL FOR PRICE**

## FT-811

440 MHz VERSION  
REG. \$410.00 **SALE \$339.95**  
**SALE PRICE**



## YAESU FT-767GX



DUAL VFO's, FULL CW BREAK IN  
Optional Modules 50/144/430-440 MHz



## YAESU FT-747GX



100 WATTS, DUAL VFO'S  
Receives 100KHz to 30 MHz  
BUILT-IN CW FILTER

**FREE Shipment!**

most items over \$100 UPS surface

**ALL MAJOR BRANDS IN STOCK NOW!**



**Bob Ferrero W6RJ**  
President/Owner

**Jim Rafferty N6RJ**  
VP - National Sales Manager

**ANAHEIM, CA 92801**  
2620 W. La Palma  
(714) 761-3033  
(213) 860-2040  
Between Disneyland & Knotts Berry Farm

**ATLANTA, GA 30340**  
6071 Buford Highway  
(404) 263-0700  
Larry, WD4AGW, Mgr.  
Doraville, 1 mi. north of I-285

**BURLINGAME, CA 94010**  
999 Howard Av.  
(415) 342-5757  
Rich, WA9WYB, Mgr  
5 mi. south of SFO on 101

**NEW STORE!!  
DENVER, CO 89231**  
8400 E. Iliff Ave., #9  
(303) 745-7373  
(800) 444-9476

**OAKLAND, CA 94606**  
2210 Livingston St.  
(415) 534-5757  
Rich, WA9WYB, Mgr  
I-880 at 23rd Ave. ramp

**PHOENIX, AZ 85015**  
1702 W. Camelback Rd.  
(602) 242-3515  
Gary, WB7SLY, Mgr.  
East of Highway 17

**SALEM, NH 03079**  
224 N. Broadway  
(603) 898-3750  
(800) 444-0047  
Paul, NW1U, Mgr.  
Exit 1, I-93; 28 mi. no. of Boston

**SAN DIEGO, CA 92123**  
5375 Kearny Villa Rd.  
(619) 560-4900  
Tom, KM6K, Mgr.  
Highway 163 and  
Claremont Mesa Blvd.

**VAN NUYS, CA 91411**  
6265 Sepulveda Blvd.  
(818) 988-2212  
Al, K6YRA, Mgr.  
San Diego Fwy. at Victory Blvd.

**WOODBIDGE, VA 22191**  
14803 Build America Drive  
(703) 643-1063  
(800) 444-4799  
Curtis, WB4KZL, Mgr.  
Exit 54, I-95, South to US 1

**CALL TOLL FREE  
NOW! Toll free  
in California!**

WEST 1-800-854-6046 MID-WEST/COLORADO 1-800-444-9476 SOUTHEAST 1-800-444-7927 MID-ATLANTIC 1-800-444-4799 NEW ENGLAND 1-800-444-0047

(call routed to nearest store) Toll free incl. Hawaii. Local phone hours, 9:30 AM to 5:30 PM. AZ, CA, CO, GA, VA residents, add sales tax  
WALK-IN HOURS: 10AM-5:30PM • CLOSED SUNDAYS Prices, specifications, descriptions, subject to change without notice

## GARDS ROSE Network

Callsign	Address	Location	User Freq/Speed
W4MM-4	912888	Albany, GA	145.05 MHz 2400 bps
W4MM-5	912883	Albany, GA	145.05 MHz/1200 bps
KS4C-4	404834	Bowdon, GA	145.05 MHz/2400 bps
KS4C-5	404832	Bowdon, GA	145.05 MHz/1200 bps
K4ICT-5	912781	Macon, GA	145.05 MHz/1200 bps
K4ABT-4	912744	Macon, GA	145.05 MHz/2400 bps
N4IGI-5	912452	Milledgeville, GA	145.05 MHz/1200 bps
K4ABT-6	912987	Perry, GA	145.05 MHz/2400 bps
K4ABT-7	912929	Perry, GA	145.05 MHz/1200 bps
K4ABT-8	912868	China Hill/MacRae, GA	145.05 MHz/2400 bps
K4ICT-8	912833	Jacksonville, GA	145.05 MHz/1200 bps
K4ICT-7	912934	Cochran, GA	145.05 MHz/1200 bps
K4ABT-5	912836	Knoxville, GA	145.05 MHz/2400 bps
K4ICT-1	912745	Macon, GA	145.01 MHz/1200 bps
WA4PQK-4	404461	Fayetteville, GA	145.05 MHz/2400 bps
WA4PQK-5	404460	Fayetteville, GA	145.05 MHz/1200 bps
K4ABT-3	404892	ATLANTA link at	433.8 MHz/2400 bps
KF4ZB-5	912863	Sylvania, GA	145.05 MHz/1200 bps
KB4ACE-5	912272	Dublin, GA	145.05 MHz/1200 bps
N5BCH-4	912245	Valdosta, GA	145.05 MHz/2400 bps
N5BCH-5	912244	Valdosta, GA	145.05 MHz/1200 bps

Table 1— This is GARDS (Georgia Amateur Radio Digital System) ROSE switch KS4C-4,404834 145.05 MHz 400 bps co-located with KS4C-5,404832 at Carrollton, Georgia. SYSOP is Ray.

### Southnet Rekindles The Urge

Tom was the featured speaker at the Southnet Packet Conference in Albany, Georgia (see September 1990 "Packet User's Notebook"). There was a large gathering of SYSOPs and packeteers all ready to hear his address when he was finally introduced. For some reason he had chosen the ROSE as the topic for his forum. After his forum, I had an opportunity to chat with Tom and discuss some of his future plans for the ROSE.

### The Future is Now

By mid-August he had completed the implementation of the HEARD, INFO, USERS, and some other SYSOP-related functions into the ROSE. At the Jacksonville Hamfest Bob Grant, WD4BIW, told me there was a new version of ROSE for me that would be in my hands the following day. He said the new features were installed, and there was "security" now included. Thanks to Tom and Bob, the ROSE is now in full swing in many parts of the United States and the Caribbean. Many HF users are beginning to see ROSE addresses appearing from other countries.

ROSE is ready, and Tom has enhanced the features beyond the scope that anyone had expected. Without becoming overly excited when I speak about the ROSE, I can only say that this is by far the easiest and most exciting method of packet communicating I've experienced.

Following are explanations of two features of the ROSE.

**HEARD:** This provides the users with a tool to connect to a distant LAN ROSE switch and request a list of all the users of that area that have been active in the last few hours. This gives us a vehicle to discover who is operating packet beyond the horizon. Once you have connected to HEARD at the distant switch, the user presses <enter> a second time, and the HEARD list is initialized. A USER list will be sent to your station with information for the distant ROSE LAN. For a shortened version of the HEARD list, I recommend sending an asterisk (\*) instead of the second <enter>. The display which you receive will be from the most recent heard stations to the oldest heard. The list covers approximately three hours of time. The time may vary in accordance with the amount of switch use.

It would be to everyone's benefit if we refrain from downloading HEARD lists during "high-traffic" periods. Remember, there may be heavy traffic at the other end of the HEARD path. This can become a very useful feature if we don't abuse it.

Here is an example of how I would download a HEARD list of a 2400 bps ROSE at Albany, Georgia (about 100 miles) from the local Macon, Georgia ROSE switch:

(Using 2400 bps):

C HEARD V K4ABT-4,912888 <enter>

After I receive the message "CALL COMPLETED" I send an asterisk \*.

(Using 1200 bps):

C HEARD V K4ICT-5,912883 <enter>

After I receive the message "CALL COMPLETED" I send an asterisk \*.

**INFO:** The same scenario applies to the INFO command when connecting to a distant switch. As a convenience, I place a DIRECTORY into the INFO of each switch that will display all the ROSE switches that are available throughout Georgia. The list will be the same at all locations, since the network is state wide, so pulling an INFO list from a distant switch will render the same INFO as that of a local ROSE switch.

Table 1 is an INFO download from the Carrollton/Bowdon, Georgia switch. Here is an example of how we would download INFO from KS4C-4,404834:

(Using 2400 bps):

C INFO V K4ABT-5,404834

(Using 1200 bps):

C INFO V K4ICT-5,404834

### The ROSE Blooms To Perfection

The ROSE Version 900713 has given me an abundance of reasons for implementing the ROSE on the Georgia Amateur Radio Digital System's (GARDS) network of 23 switches. The ROSE switching system makes packet connecting as easy as making a telephone call!

Hold it! What was that last statement? As easy as making a telephone call! Well, alright, maybe a "long-distance" call. Once this LAN is linked to the Florida system at Tallahassee, a link will soon be added to link into Tampa. At this point and maybe as you read this column, I will simply call Tom's QTH with the following entry (no more, no less).

C W2VY V K4ABT-6,813989

That's it—no more, no less. In about one second the local switch returns "Call being set up," and in a very short time I'm greeted with "CALL COMPLETE TO W2VY."

We are ready to QSO, or as it sometime happens, I'll leave a message in his HandiPacket mailbox.

I'm not going to print the SYSOP or user's manual. That is something you will receive when you send the formatted 360K disk and a return SASE mailer to Tom Moulton, W2VY, 4812 East Busch Blvd. #7, Tampa, FL 33617-4066.

To make matters even easier, try downloading it from the "HAM" section of your favorite landline BBS. The manual is being revised to reflect many of the new features and instructions that make the configuration of the ROSE switch a breeze.



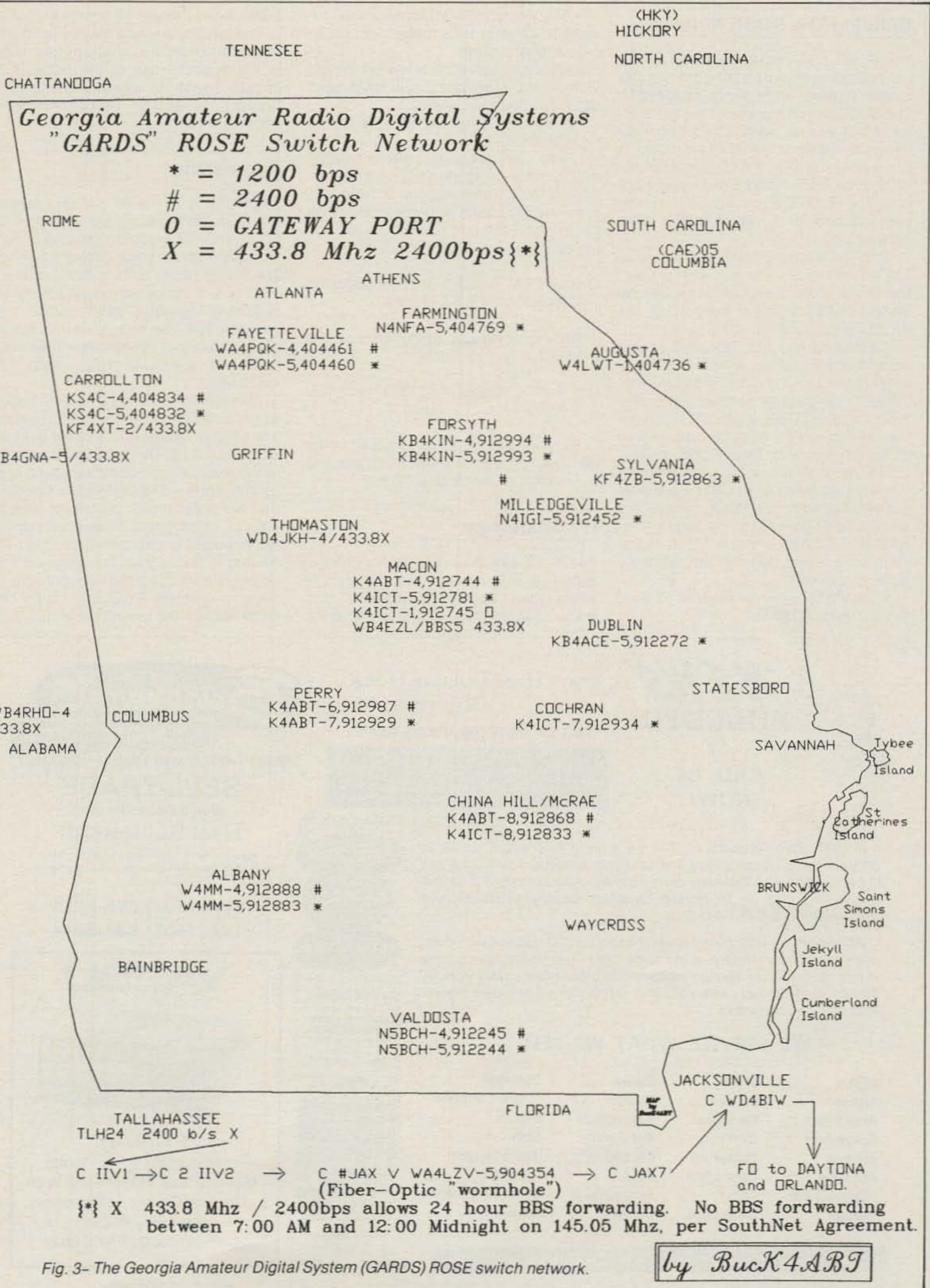

Fig. 3- The Georgia Amateur Digital System (GARDS) ROSE switch network.

## Building The ROSE Network

The ROSE X.25 packet switch is an advanced replacement for the common digipeater or other node switching EPROM. The ROSE switch represents the state-of-the-art in packet switching technology using international standard protocols. It is based on the CCITT X.25 Network Layer, and the ARRL AX.25 Link Layer Protocols. The ROSE X.25 packet switch is the best solution for amateur packet radio networking.

With the exception of the Kantronics TNCs running 2.85 or earlier firmware, the ROSE switch can be accessed by standard AX.25 TNCs supporting the AX.25 Link Layer Protocol.

Kantronics has just released a new version 3.0 firmware which has many new features for the Kantronics TNC line. While building a large number of new features into this new version 3.0 firmware, they also cured the bug which prevented a normal connect to a ROSE switch. Don't feel that you are buying the new firmware update just to clear a problem connecting with the ROSE. There are some meaningful reasons to update your KAM or KPC to the version 3.0 firmware. Here are a few of the new features of the Kantronics V 3.0:

- The PBBS will now reverse forward to the standard BBSes.

- The Kantronics 3.0 firmware will re-route to another BBS if you wish to bypass a local system.

- Beacon intervals are now in 1 minute increments. (*This one could have been dropped altogether.*—ed.)

- Software Carrier Detect added to the KAM and KPC-4.

If you wish to connect into the ROSE system while using the KAM or other Kantronics TNCs with the earlier version 2.85 firmware, you must remember to use an "i" in place of a one (1) and use the "o" instead of a zero (0). For example:

C K4ABT V K4ICT-5,912744 becomes  
C K4ABT V K4ICT-5,9i2744

Another example using an address field with a zero (0) in it is:

C KS4C V K4ABT-4,404834 becomes  
C KS4C V K4ABT-4,4o4834

By using the "i" or "o" instead of the one or zero the KAM will perform well and will not return the familiar "EH?"

## It's Shareware

The ROSE switch is a shareware product within the amateur radio community. The executable firmware is available from many sources, including many land-line

BBSs, as well directly from the author.

The switch firmware may be used free of charge for amateur radio purposes only. Commercial use of the ROSE X.25 packet switch is expressly forbidden. Contact the author for commercial licensing information.

## Addressing

The ROSE X.25 packet switch supports the global addressing plan adopted by CCITT and ISO. This plan includes a country code and a national network number. The ROSE switch follows the numbering plan in use in the national X.25 packet switching network; most packet networks follow the telephone numbering plan used in that country. North America uses the telephone area code and exchange.

This system will allow a user to request a connection with another station without any concern given to the exact path the data will follow. This is in sharp contrast to the explicitly specified approach used by digipeaters. The motivation for this is that the general user population doesn't care to, or have time to, keep abreast of the networking changes over time. The routing is under your complete control, so users can't clog the network with retries on obsolete RF paths. Users only need to know the network address of the



CALL US  
NOW!

In 1937, Stan Burghardt (WØIT), because of his intense interest in amateur radio, began selling and servicing amateur radio equipment in conjunction with his radio parts business. We stand proud of this long-lasting tradition of *Honest Dealing, Quality Products and Dependable "S-E-R-V-I-C-E"!*

*Above all*, we fully intend to carry on this proud tradition with even more new product lines plus the same "fair" treatment you've come to rely on. Our reconditioned equipment is of the finest quality with **30, 60** and even **90-day** parts and labor warranties on selected pieces. *And always remember:*

— WE SERVICE WHAT WE SELL —

AEA	B & W	Daiwa	Palomar
Alinco	Belden	Hustler	Radio Callbook
Ameritron	Bencher	Kantronics	Ritron
Amphenol	Bird	Kenwood	Rohn
Ampire	Butternut	Larsen	Telex/Hygain
Antenna Specialists	Centurion	MFJ	Ten-Tec
Astron	CES	Mirage/KLM	Unadilla/Reyco
	Cushcraft	Mosley	Yaesu

Write today for our latest Bulletin Used Equipment List.

YOUR HAM DOLLAR GOES  
FURTHER AT ...

CALL OR WRITE FOR SPECIAL QUOTE

When it comes to  
FAST DELIVERY, HONEST DEALING and  
PROMPT DEPENDABLE SERVICE back-up  
We don't just advertise it — WE GIVE IT!

*we'll treat you*

SELECTION

SERVICE

and

SATISFACTION!

STORE HOURS:

9-5 P.M. (CST)  
MONDAY thru FRIDAY  
OPEN SATURDAYS  
from 9-1 P.M. (CST)  
CLOSED  
SUNDAYS/HOLIDAYS



182 N. Maple  
P.O. Box 73  
Watertown, SD 57201

**Burghardt** INC.  
AMATEUR CENTER

"AMERICA'S MOST RELIABLE AMATEUR RADIO DEALER"

SELL-TRADE

New & Reconditioned  
HAM EQUIPMENT

Call or Write Us Today For a Quote!  
You'll Find Us to be Courteous, Knowledgeable  
and Honest

PHONE (605) 886-7314

FAX (605) 886-3444

**YAESU**



FT-747GX

Lightweight HF All Mode  
Mobile/Base Transceiver With  
General Coverage Receiver  
Specially Priced!  
Call, Write, Or FAX Today

destination, which is like a telephone number.

The ROSE switch may be configured with several paths to remote area codes or countries. Each of the specified links will be tried in the order it was specified to find an operational route.

### Improvements Over The Other Network Protocols

This is an improvement over several existing amateur systems which can only provide destination routing to switches known by the source switch.

These next few lines are for the SYSOP who builds the first ROSE system in his area. Please remember this old adage: "Humans are creatures of habit, and they resent change." I encountered nothing short of "the wrath" when I began implementing the ROSE network into the GARDS system. I hope your hide is as tough as mine. I was even called late at night with protests and names (other than Buck). In less than three weeks after the ROSE was in place, I was being praised as the guru of all packetdom (Tom Moulton, I bequeath that turban to you).

### The User Has The Ease of It All

Now that the users have discovered how easy it is to use and how much the throughput has improved, I really would have trouble if I tried to remove or take away the ROSE.

One of the first things you'll notice when using ROSE for the first time is how you stay connected over the long hauls. This is part of the "Virtual Circuit" aspect of the ROSE. You may find yourself momentarily disconnected, then suddenly you are reconnected. This is one feature of which I was not aware until I found that the ROSE would reestablish a "dropped" link via the alternate routes without any help from me. Many times the re-direct or automatic re-connect will go totally unnoticed by the users.

### True, RS232

Different from the other nodes that we are accustomed to, the ROSE switch uses "true" RS232 for communications between switches. If your system uses two switches for a gateway from 1200 to 2400 bps, or if it gateways from one frequency to another, then use the RS232 cable configuration shown in fig. 1. If your ROSEs are in a bouquet of more than two switches, such as a cluster of gateways and cross-links, then you will need the "RS232 LAN." The difference in building the gateways and bridges is in the manner in which we let them talk to each other. The nodes use a complex of di-

odes in a matrix that makes the builder "Kathode-Krazy" by the time he has tied four nodes together. In turn, the ROSE uses true RS232 through an electronic switching device called the "RS232 LAN."

This device can be fabricated by the switch SYSOP using the bare PC board from PacComm. Of course you can do as I've done, and call PacComm at 1-800-223-3511 and ask Linda to ship the "wired-and-tested" version via next day air. (We needed it fast.) The RS232 LAN can be ordered three ways: bare PC

board for \$25; complete kit (less case) for \$60; or wired and tested for \$75.

I opted for wired and tested for the three-way, gateway system shown in fig. 2, because we needed it fast. Lightning had destroyed our 145.01 MHz network "node" port, so what better time to add the ROSE. I'll go for the kit for future additions, since I now have a pattern to use as reference. LAN SYSOPs operate on a very limited budget—Hi!

Stop and smell the ROSEs!

73, de Buck4ABT

## "Become Enlightened, Not Lightning'd!"



**Flash! The RC-96 Repeater Controller two year warranty now includes lightning coverage.**

The '96 is tough. A three-terminal gas discharge tube across the phone line and transient suppressors on each input and output signal stop lightning from taking your system down. The '96 is so well protected that its proven performance in the field allows us to offer two year warranty coverage which includes damage caused by lightning!

You'll hear thunderous applause when you install a '96 controller on your repeater. Remote programming will let you easily make changes to your repeater from anywhere without a trip to the hill. Change codes, autodial numbers, ID and tail messages and more, with reliable storage in E<sup>2</sup>PROM memory.

Your users will be thunderstruck by the outstanding patch and auto-dialer, with room for 200 phone numbers. The talking S-meter will let them check their signal strength into the repeater. Remote base support for up to six bands allows linking your repeater to others. Plus support for pocket pagers and a bulletin board.

Your technical crew will light up when they see the built-in keypad and indicators. And the ease of hookup with shielded DIN cables. With pots and DIP switches easily accessible at the rear of the unit.

Rugged, capable, easy to hook up. The RC-96 Repeater Controller - an enlightening experience for your repeater.

**acc** advanced computer controls, inc.

2356 Walsh Avenue, Santa Clara, CA 95051 (408) 727-3330

CIRCLE 44 ON READER SERVICE CARD

# CQ REVIEWS:

## The GenWest Engineering Voicebox

BY LEW McCOY\*, W1ICP

**T**he Voicebox manufactured by GenWest Engineering is truly an amazing device which incorporates many new computer techniques. It is a piece of equipment that eliminates much of the stress in ordinary operating, plus prevents or alleviates vocal-cord over-use. I know that contesters and DX chasers will welcome the Voicebox into their station. What is it? Read on.

In the past many contest and DX operators who did a lot of voice or phone operation have tried tape recorders and other devices to do the actual calling such as "CQ,CQ,CQ SS," or "CQ Contest, CQ Contest, this is W1!" and so on until their collective throats got very sore. It doesn't take many hours of operating before the vocal chords take a beating. Wouldn't it be better to have a device that would do all this work for you—sound *exactly* like yourself and be simple to operate? Well, that's what the Voicebox does.

The Voicebox is similar to a tape-loop cassette in what it puts out, but it is much more efficient in operation. The heart of the recording mode is an Adaptive Delta Modulation Algorithm that duplicates your recording to a point where the listener cannot distinguish between your actual voice or the recorded voice. One advantage over a loop recorder is that you don't have to wait for your recorded message to come around. You begin by recording whatever message you want. For example, I could record "Hello CQ—CQ—CQ. This is W1ICP calling CQ and listening for any calls." I merely need to push the **Play/Record** switch on the front of the Voicebox and the message is transmitted. Of course, you can record other types of calls and fit them into their operating procedure. More on operating in a moment.

The Voicebox is available as a kit or a fully wired and tested unit. I chose the kit route to see what was involved. (I enjoy wiring kits!) The completed Voicebox

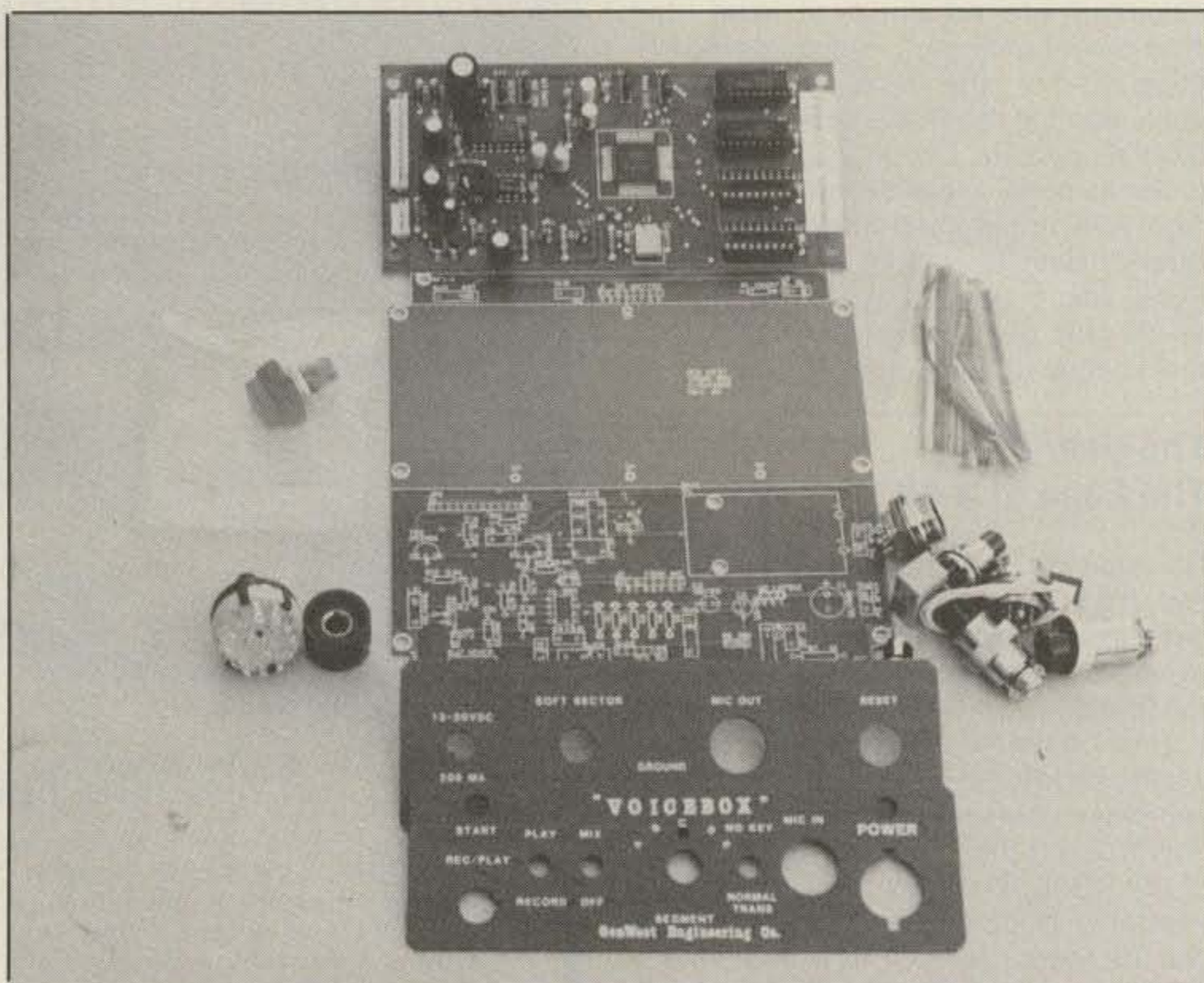

*Here is the kit as it comes from the manufacturer.*

measures 6¼ inches wide, 2¼ inches high, and 7½ inches deep. I found it took me about three hours to wire the kit. A very excellent step-by-step instruction manual is provided, so the construction is easy. I don't think I would recommend the kit as a first-time project because you do need experience in soldering. However, if you have that experience, no problem.

One thing I liked very much about the kit is that much of the wiring, cables, etc., is pre-cut to length, saving a lot of tedious work. All materials are first rate. There are two circuit boards. One requires wiring, but the voice board with its memory is factory wired and tested, saving the builder considerable work.

I found when I turned on the unit the first time it didn't play. Upon careful examination I found I had goofed in wiring the jack for the external power supply.

Once I corrected my wiring error the Voicebox worked FB.

There are several switches across the front panel, but their operation is simple to learn and clearly explained in the manual. There are two **Play/Record** switches, the first a pushbutton switch for operation and the second a toggle for setting the **Play** or **Record** mode. Next are the **Mix/Off**, **Segment**, **No Key/Normal**, and **Power** switches. Let's discuss the **Segment** switch operation first.

The unit is provided with two DRAMs that have 1 meg × 1 memory each. This provides a total recording time of 64 seconds. (This may not sound like much, but believe me it is adequate.) If you were going to transmit a bulletin, then there is space for two additional DRAMs to provide a total of two minutes-plus recording time. There are five **Segments** available

\*Technical Editor, CQ, 200 Idaho St., Silver City, NM 88061



The completed Voicebox is a well-engineered unit.

—A, B, C, D, and E—with a total recording time of 64 seconds (two DRAMs), or 128 seconds with the added DRAMs. In the circuit there are five timing resistors that are used to determine the length of time for each segment—A = 4 to 5 seconds, B = 9 to 10 seconds, C = 9 to 10 seconds, D = 14 to 15 seconds, and E = 19 to 20 seconds. These recording lengths can be altered by changing the timing resistors.

The **Play/Record** switches are just what the name implies. You place the toggle switch in the **Record** position and record your message. A red LED comes on whenever you push the **Play/Record** pushbutton switch, during the record segment or when the recorded segment is transmitted. To repeat, when you move the toggle to **Play** and you push the first switch, your transmitter is turned on.

Next the red LED comes on, and the message is transmitted. Your transceiver mike is plugged into the Voicebox and the unit is connected via a cable to your transceiver mike input. More about this in a moment.

There is one real "cute" feature about the Voicebox that bears special mention. Suppose you are working a rare DX station in a pile-up but his QTH and QSL information goes by too quickly for you. All you need to do is switch to the record mode and record him into one of the segments, and go back and get the information when you need it!

The **Mix** switch, when it is turned on, makes your microphone live. Suppose you are working a 10-10 contest. You would record your QSL, QTH, etc., information. In using this information on the air, you would send the message and



An inside view of the unit from the back.

then add "your 10-10 number is" after which the Voicebox recording would drop out.

The **No Key** switch is just what the name implies. It permits you to record or play messages without going on the air. I didn't mention it before, but the unit has its own speaker and monitoring system. Checkout procedure is simple and easy to accomplish. No exotic equipment is needed.

Your regular transceiver microphone is plugged into the front microphone jack. You are provided with two appropriate microphone jacks and cable to interconnect the Voicebox from the microphone jack on the back panel to the normal mike input on your rig.

### Final Observations

To be honest, I think the Voicebox is one of neatest pieces of gear to come along in amateur radio. There are countless ways it can be used in voice transmissions, saving the operator much wear and tear. I know the unit I have will get plenty of use, particularly in contest work. Also, prospective DXpeditioners would be wise to look at the opportunities the Voicebox will afford them.

The price of the kit is \$189.95 and the completed unit is \$259.95. The Voicebox is manufactured by GenWest Engineering, 1217 W. Hatcher Rd., Suite 11C, Phoenix, AZ 85021 (602-943-5255). 



### BASE STATION ANTENNA

HF SSB ANTENNA  
50Ω BROADBAND

Model SG-103 and SG-103T

### Continuous Frequency Coverage

For commercial and professional base station services or tactical operations. The special SG-103T tactical version can be deployed and erected in less than 10 minutes. Both are supplied with all installation items.

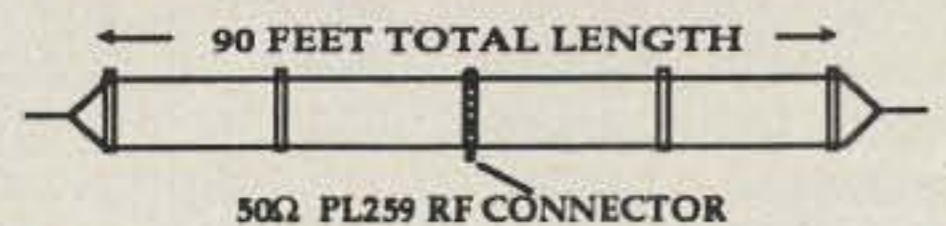

HIGH RADIATING PERFORMANCE

1.8-30 MHz RANGE  
3 to 6 DB GAIN

(above 6 MHz)

**\$195.00\***

Low receiving noise  
Low VSWR typical below 2:1  
90 Feet overall length

SGC, Inc., Box 3526  
Bellevue, WA 98009 USA

Tel: 206-746-6310

Fax: 206-746-6384

\*UPS shipping included (SG103T quoted on request)

Visa & Master card accepted

*The world is moving faster and faster, and why shouldn't you? K4ABT presents an interesting modification to your PK-232 to speed up your packeteering fun.*

## How To Add 2400 BPS To The AEA PK-232

BY BUCK ROGERS\*, K4ABT

**N**ot long ago I wrote an article in the "Packet User's Notebook" explaining how to add the 2400 bps QPSK feature to several different manufacturers TNCs. The article was written to complement the modem and TNC of each of the manufacturers mentioned in the article. Each company told me that the modem could be installed by the user, and the modem was available to the end user. At that writing I reported that the 2400 bps modems were available from these manufacturers, and they could be added by the end users. That was true at the time I researched and wrote that column (see May 1990 CQ).

After I had written the column, and after it was in print, one of the manufacturers felt that an installation of this kind might be too difficult for the packeteer. Therefore, they decided to make the 2400 bps update a factory modification.

With a lot of folks calling and writing to me about their plight, I went to my files and dug out some old data on the PK-232 and an earlier 2400 bps modification that Glynn, WB4RHO, had made to a friend's PK-232 about two months ago.

Several packeteers and I spent long hours building the modification that we are about to discuss in this article. Special thanks to Glynn, WB4RHO, and to Dick Mills, W4MTP. There's not enough room to send kudos to all those packeteers who participated in this project to develop an economical means to put 2400 bps PSK into the PK-232.

We've developed a 2400 bps modem installation for the PK-232 for under \$80. To do so we had to make a trade-off in the method of switching used to go between 1200 and 2400 bps. The reason was to eliminate the cost of new firmware and a new EPROM.

\*506 Pheasant Ridge Drive, Warner Robins, GA 31088

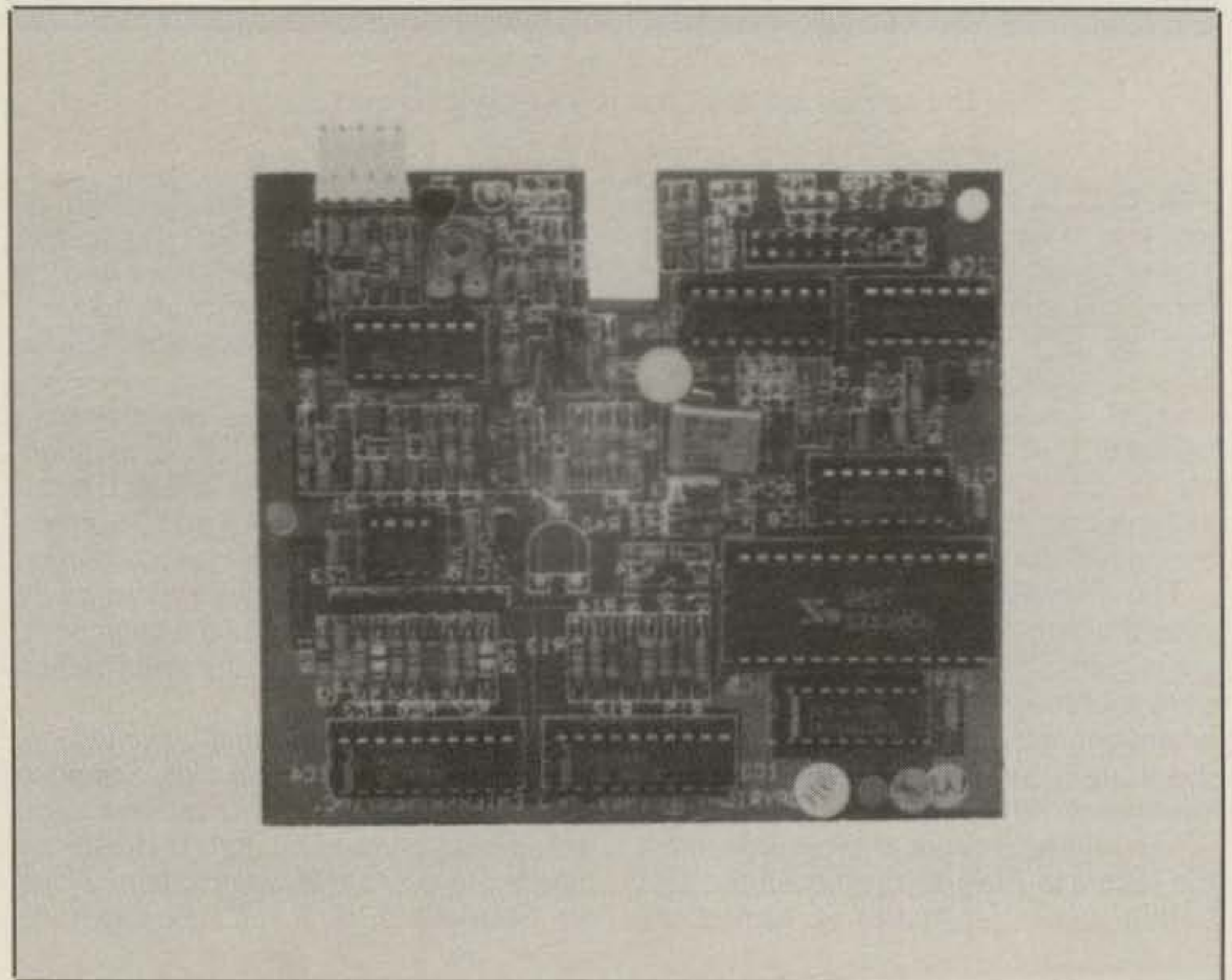

*The MFJ-2400X add-on can make your AEA PK-232 operate on 2400 BPS.*

The trade-off amounted to using "hardware" switching instead of "software" switching. The move towards economy included making use of a modem from another supplier.

MFJ packages 2400 bps Add-On Modem Kits for other makes of TNCs, including the turbo additions to their own line of packet controllers. We purchased some of these kits and made the necessary changes to them so they would easily adapt to this PK-232 modification.

After we modified the modems and had the PK-232 operating at 2400 bps, we asked MFJ if they would add these changes to one of their kits and give it an "X" rating (PUN). Thus, the 2400 bps PSK Modem Add-On Kit that may be added to

a PK-232 is called the **MFJ-2400/X**. The cost is \$79.95, and it is available from MFJ or one of the MFJ distributors.

The MFJ-2400/X Kit contains a completely wired and tested modem and the following items necessary for the addition of 2400 bps to a PK-232:

1. Modem with seven wires already soldered to the "HEADER" location of the MFJ-2400/X.
2. Five-pin Molex connector (plug) pre-wired.
3. One  $\frac{7}{8}$  inch aluminum spacer.
4. One  $\frac{7}{8}$  inch plastic spacer.
5. Two #6 flat fiber washers.
6. One 6-32  $\frac{1}{4}$  inch screw.
7. One switch.

The results of this mod are pleasing, to

# OFF THE BENCH AND RUNNING

When **OPTOELECTRONICS** took frequency counters off the bench we created a whole new dimension - Frequency Finding.

Our Handi-Counters™ make Frequency Finding a reality by allowing you to pick-up radio transmitters at the maximum possible distance.

Monitoring Enthusiast, Security Specialists, Broadcast and Design Engineers, Two Way and Amateur Radio Operators and Service Technicians have all made the move. *Shouldn't you?*



**3000**  
Top of the Line Universal  
Handi-Counter™.  
\$375.



**2600**  
Super Sensitive RF  
Frequency Finder.  
\$325.



**2210A**  
Full Range  
Pocket  
Size LED.  
\$239.



**8030**  
Bench Portable (Fits in an attache  
case) with ALL the Handi-Counter™  
Features plus More. \$579.



**1300H/A**  
Low Cost Ultra  
Sensitive (HF,  
UHF, VHF).  
\$179.

Model	Range Low High	Display 8 Digit LED	Display 10 Digit LCD	Signal Strength Bargraph	Universal Counter	TCXO Option
8030	10Hz 2.4GHz		•	•	•	± .1ppm add \$125.
3000	10Hz 2.4GHz		•	•	•	± .2ppm add \$ 80.
2600	1MHz 2.4GHz		•	•	•	± .2ppm add \$ 80.
2210A	10Hz 2.4GHz	•				± .5ppm add \$ 75.
1300H/A	1MHz 1.3GHz	•				± .5ppm add \$ 75.

Sensitivity: <1 to <10mV typical. NiCads & AC Charger/Adapter included. Carry Case, Antennas and Probes extra. One year parts & labor warranty on all products.

## OPTOELECTRONICS

Toll Free Order Line:

**1-800-327-5912**

In Florida call (305)771-2050

**FAX (305)771-2052**

5821 NE 14th Avenue • Ft. Lauderdale, FL 33334  
Visa, MC, COD, Cash, M.O. accepted. Personal  
Check allow 3 weeks. 5% Shipping, Handling,  
(Maximum \$10) U.S. & Canada. 15% outside  
continental U.S.A.

CIRCLE 125 ON READER SERVICE CARD





JP5 and JP6 later. **JP4** (jumper) will *not* be replaced, but it is wise to store one of these jumpers in a safe place, should you need it at a later time.

The seven (modem) wires discussed in the next steps are already attached to the MFJ-2400/X Modem PCB. They are 9 inches in length and should be trimmed to the length that is required in each step. *Carefully* solder the indicated color to the location specified. Refer to the point-to-point wiring guide in fig. 1.

1. "**Modem**" **VIOLET WIRE** from modem to GROUND near J1.
2. "**MODEM**" **WHITE WIRE** from modem to PIN 17 of U7.
3. "**MODEM**" **BLUE WIRE** from modem to CENTER PIN of JP4.
4. "**MODEM**" **GRAY WIRE** from modem to CENTER PIN of JP5.
5. "**MODEM**" **PINK WIRE** from modem to PIN 3 of U8.
6. "**MODEM**" **WHITE w/RED TRACER** from modem to PIN 14 of U7.
7. "**MODEM**" **RED WIRE** from modem to the inside PIN of JP4 (pin towards the front of the PK-232).
8. The balance of the modem header pin locations, 2 through 4, 6 through 11, 13, 15, 16, and 20 *have no connections*.

### Wiring The Molex 5-Pin Plug (Audio/Control)

The connecting points described here can be located by using the PK-232 "Parts Pictorial Diagram" in the PK-232 manual. You may wish to use the illustration in fig. 1 in conjunction with the PK-232 parts pictorial.

"**A**"—Solder the **GREEN** wire from the 5-pin plug to the ANODE end of D9 (-10 volt, end toward the back panel of the PK-232).

"**B**"—Solder the **YELLOW** wire to the CATHODE end of D12 (+5 volt, end towards the front of the PK-232).

"**C**"—Solder the **ORANGE** wire to the (Ground) solder pad near the right rear corner (near J1, same point as MODEM VIOLET wire).

"**D**"—Solder the **RED** wire to *outside pin*, second row from rear of **SW2**. Designated "**D**" **RED** in fig. 1 (RxAudio).

"**E**"—Solder the **BROWN** wire to *inside pin*, second row from rear of **SW2**. Designated "**E**" **BROWN** in fig. 1 (TxAudio).

Next we attach the MFJ-2400/X modem to the PK-232 main PC board. Install the nylon stand-off (just plugs in) at the hole near modem IC U5. If the RAM/EPROM MBX PCB was attached to your PK-232, replace and secure it with the original screws. **CAUTION:** When replacing the MBX PCB, *do not* bend any of the pins. Attach the BLACK wire that was removed earlier to its original location (Pin 1 of JP1).

Remove the front, center screw from

the underside of the PK-232 case, and replace it with the one supplied with the MFJ-2400/X Kit.

Install the 7/8 inch aluminum spacer (also supplied) on the screw that was just installed at the bottom of the case. Tighten snugly; *do not over-tighten*.

Attach the MFJ-2400/X modem to the top of the aluminum spacer using two fiber washers (supplied), *one above* and *one below* the modem PC board. Secure with the 1/4 inch screw (supplied).

### Adding 1200/2400 "Speed-Shifter" (Switch)

The switch included with the kit is to be installed in an easy-to-reach location. The location for the switch is at the discretion of the user. Install the switch in a convenient location and within reach of the 9 inch **BLACK** and **ORANGE** wires at "F" and "G".

I mounted the switch on the rear apron of the PK-232 using a couple of drops of the "quick set" syanacate, type super glues. Being careful not to crimp or pinch the wires, I partially replaced the top cover of the PK-232. Next I routed the BLACK and ORANGE wires out an opening near one of the radio ports of the PK-232. The switch supplied with the MFJ-2400/X bps Kit contains a single-pole double-throw switch. The connection is easy if you remember to connect the ORANGE "F" wire to the center, or *common* post of the switch. The BLACK "G" wire then goes to either of the outside switch posts. The Make/Break function of the switch is all that is required for the transition from 1200 to 2400 bps.

### Replacing The Jumpers (Strapping Options)

Using only two of the three jumpers that were removed earlier from **JP4**, **JP5**, and **JP6**, replace one of the jumpers on the two inside pins (center pin, and pin to-

wards the front of the PK-232) of **JP5**. Follow the same procedure with the jumper installation at **JP6** by placing the second jumper on the center pin and the inside pin of **JP6** (see fig. 1). JP4 jumper will *not* be used.

Make a note of the **jumper** on the MFJ-2400/X Add-On modem at location **CN6**. This is the jumper that is used to set the transmit audio level to your transceiver. The level settings correspond to the position of the jumpers indicated below:

Jumper Position of Modem Jumper CN6	Level
Jumper Removed (attached to only one pin)	Low
Jumper Pins 1 & 2	Medium
Jumper Pins 2 & 3	High

Begin operation with the **CN6** Jumper set to the **MEDIUM** position, and after you run some tests with the 2400 bps mode you may discover that no changes are needed.

### 1200 BPS Operation

After you double-check all the wiring and "smoke" test the PK-232, you are ready to make the on-air test. At the cmd: prompt type: **HB 1200** and press the <enter> key.

Set the switch that you installed earlier to wires "F" and "G", to the open or such that +5 volts is present at the COMMON post of the switch. You are now ready to operate at 1200 bauds.

### 2400 BPS Operation

To operate 2400 bps PSK set the switch to the position that grounds the COMMON (orange wire) post and sets it to 0 (zero) volts. At the command (cmd:) prompt type: **HB 2400** and press the <enter> key. You are ready to operate at 2400 bps.

HavFun and enjoy the new world of 2400 bps. 

## The DX EDGE: The 1 and Only.



### SPECIAL

on IBM and C64/128 versions  
~~\$24.95~~  
**\$19.95**

### The DX operating aid used around the world.

- **Sunrise and sunset times** for any location in the world, and areas of daylight and darkness.
- **Local times (solar times) anywhere** in the world.
- **Best times for daylight or darkness paths** on the appropriate bands.
- **Best times for Gray Line** and long path openings between any two locations.

IBM version requires 2 disk drives; 384K; Hercules, CGA, or EGA graphics; DOS 2.1 or later.  
 All ppd. in U.S., Canada. Add \$5.00 elsewhere, air mail. Add tax in NYS. U.S. funds only. Sorry, no credit cards.  
 Please make checks or M.O. payable to the DX EDGE and mail to:

**The DX EDGE, P.O. Box 834, Madison Square Station, New York, NY 10159**

An information flyer is available free of charge. A product of Xantek, Inc. © Xantek, Inc. 1990  
 C64 and C128 are trademarks of Commodore Electronics Ltd.

***This year certainly has been a great year for DXpeditions. AH3C tells us what it was like to be part of the Jarvis Island group.***

## **DXpedition To Jarvis Island, AH3C/KH5J**

BY PETER H. GRILLO\*, AH3C

**A**s Danny Weil and the YASME spirit demonstrated so well, braving the open sea alone is probably the highest risk DXpedition. On a larger scale, is there mystique or luck involved in putting together a major group sailing-type DXpedition? Dreamers are best left alone in their naivete. The fact is, such an event requires hard work, commitment, incredible stamina, total belief that it can be done, a team of dedicated operators and supporters, strong financial support, and a little bit of help from above! Yet we want to do it because there is enough adventure to make it exciting. The burning desire must come from within.

The reward? A completely fulfilling sense of accomplishment. "Where are you going next?" they all ask. Totally drained, we only respond with a shrug, a smile, and a trip to our own shacks to chase that elusive one that also went to fulfill the next DXpedition dream.

### **Identifying With The Dream**

Having been a DXer for most of a generation and then off the air for a 10 year lapse, I found great fortune when employment on Johnston Island (KH3) was offered to me. Occasional chats with old friends brought back the ache for doing an even rarer island. However, something is different with DX. Large quantities of new prefixes abound. Countries are still being added and deleted. The DXCC rules have changed. At least we know that habitation of a piece of land is still not required to be declared a country. The mileages have changed, but the concept has not. Government and geography are better defined. There still seems to be a problem in defining an island nation. Where is the baseline? What is the shape of an island nation? Drawing straight lines over open water between islands of island countries could falsely disqualify a potential new one. The Pacific continues to look enticing.

A host of "problem children" remain on the DXCC list—for example, Midway Island and Kure Island, US possessions smack in the middle of Hawaii. These were grandfathered into the current list as a result of previous operations when "separate administration" was a part of the rules. Why are there two KH5s and



*Our vessel, Makanalani, en route with Pete, AH3C, and Judy, XYL, on regular watch, 4 hours/day for 8 days.*



*It's high noon, Friday the 13th, and the work has just begun. That water looks so inviting. Look out for that shark, Eric!*

\*P.O. Box 1139, Johnston Island, APO San Francisco, CA 96305

# GREAT RADIO AND ANTENNA BUYS

## KENWOOD



**TS-950SD**  
Digital - 150W - Dual RX - And Much More!  
Also Available Without The Digital Signal Unit.  
A Top Performer. **Call For Your Price!**

**TS-940SAT**  
General Coverage HF Xcvr - 100W - More.  
A Great Performer. **Call For Your Price!**



**TS-440SAT**  
General Coverage Xcvr - Optional Auto  
Tuner. A Good Performer. **Call For Price.**

**TS-140S / TS-680S**  
General Coverage Xcvr - TS-680S Has 6M!  
Economical HF Radios. **Call For Price!**

### VHF / UHF MOBILES AND HANDIES

TM-731A - 2M / 70CM TM-631A - 2M / 220  
TM-701A - 2M / 70CM TM-231A - 2M, 45W  
TM-331A - 220, 25W TM-431 - 70CM, 25W  
TM-2530A - 2M, 25W TM-2550A - 2M, 45W  
TM-2570A - 2M, 70W TM-3530A - 220, 25W  
TR-751A - 2M, SSB TH-75 - 2M / 70CM HT  
TH-26 - 2M Tiny HT TH-25 - 2M Tiny HT  
TH-225 - 2M, 5W HT TH315 - 220 HT  
**Call For Your Special Kenwood Pricing!**

## YAESU



**FT-1000D**  
Digital - 200W - Dual Rx - Deluxe And Standard  
models Are Available. **Call For Your Price!**

### MORE YAESU RADIOS - IN STOCK

FT-767GX - General Coverage - With Tuner.  
FT-757GXII - General Coverage Xcvr - 100W.  
FT-747GX - Economical HF Xcvr - 100W.  
FT-736R - VHF / UHF All Mode Base Xcvr.  
FT-470R - 2M / 70CM Deluxe Dual Band HT.  
FT-411R - 2M Full-Featured Handie Talkie.  
**Please Call For Your Special Low Price!**

## ALINCO

### VHF / UHF MOBILES AND HANDIES

DR-570T - 2M/70CM - Dual Band Mobile.  
DR-510T - 2M/70CM - Dual Band Mobile.  
DR-110T - 2M - 45W - VHF Mobile.  
DJ-500T - 2M/70CM - Dual Band Talkie.  
DJ-160T - 2M - Tiny - Full Featured Talkie.  
DJ-100T - 2M - Tiny VHF Handie Talkie.  
ELH-230G / ELH-230D - 30W HT Amplifier.

## AMERITRON

AL-1500 - 1500W AL1200 - 1500W  
ALB2 - 1500W AL80A - 1000W  
ALB4 - 600W **CALL FOR PRICE!**

**FREE SHIPPING ON RADIOS!**

## ICOM



**IC-781A**  
General Coverage - HF Xcvr - Full  
Dual RX - With Built in Band Scope.  
Top Performer. **Call For Price!**

**IC-785A**  
Digital - General Coverage - 100W -  
HF Xcvr. Great Performer. **Call!**



**IC-735A**  
General Coverage HF Xcvr - 100W.  
Good Performer. **Call For Price!**

### MORE ICOM RADIOS - IN STOCK

IC-725 - Economical HF Xcvr.  
IC-726 - Economical HF W/ Xcvr.  
IC-970 - VHF / UHF All Mode Base.  
IC-2400 - VHF / UHF Mobile Xcvr.  
IC-228A - 2M - 25W Mobile Xcvr.  
IC-228H - 2M - 45W Mobile Xcvr.  
IC-32AT - VHF / UHF - 2M Talkie.  
IC-24AT - VHF / UHF - 2M Tiny HT.  
IC-2GAT - 2M - 7W Super Talkie.  
IC-2SAT - 2M - Tiny Handie Talkie.

## MFJ IN STOCK

New Product - 948 Tuner \$119  
901B / 941 D Tuners ..... 59 / 99  
945C / 949D Tuners ..... 89 / 139  
986 / 989C Tuners ..... 259 / 299  
1278 / 1270B TNC's .... 249 / 129  
202 / 204 Nx Bridges ..... 59 / 79  
250 / 260 / 262 Loads 49 / 29 / 69  
407 / 401 Keyers ..... 69 / 49  
422 MFJ / Bencher Combo .... 129

## ASTRON 12 VDC POWER SUPPLIES

MODEL	AMPS	ICS	PRICE
RS4A	3	4	\$ 49
RS7A	5	7	59
RS12A	9	12	79
RS20A	16	20	99
RS20M	16	20	119
RS35A	27	35	159
RS35M	27	35	179

Models With "M" Suffix Have Meters.

### OTHER ACCESSORIES

AEA PK232MBX - All Mode TNC.  
KANTRONICS KAM - All Mode  
NYE MBV-A - 3KW Antenna Tuner.  
RF CONCEPTS - Amplifiers.  
MIRAGE - VHF / UHF Amplifiers.  
OTHERS TOO. - PLEASE CALL!

## HEATH

HW2P - 2M Tiny Handie Talkie.  
HW-24T - 2M/70CM Handie Talkie.  
**Call For Price All Heath Models!**

## TEN - TEC

Paragon - General Coverage Xcvr.  
Omni V - Ham Bands Only Xcvr.  
Titan - 1500W HF Linear Amplifier.  
**Call For Price On All TEN - TEC  
Equipment! Most Items In Stock.**

## BUTTERNUT ANTENNAS



HF5B Butterfly - Compact Triband  
Beam. 6FT Boom Length - 12.5 FT  
Element Length. \$ 259.95

HF6VX - 6 Band Vertical Antenna.  
Handles Full Legal Power \$ 159.95

HF2V - 80/40M Vertical Antenna.  
Handles Full Legal Power \$ 149.95

RMKII - Roof Mount Kit \$ 59.95  
STR11 - Radial Kit 59.95  
TBR160 - 160M Coil 59.95  
30MRK - 30M Kit 39.95  
**Free Shipping On Butternut!**

### COAX AND CONNECTORS

RG213/U - 95% Shield - Non Cont-  
aminating Jacket. \$ .39 / FT.

RG8X - 95% Shield - Mini-Size Co-  
ax. Uses UG176 Adapt. \$ .25 / FT.

9086 International - Equivalent to  
Belden 9913 - 100% Shield - Solid  
Center Conductor \$ .45 / FT.

### Connectors:

Amphenol PL259 - Silver - \$ 1.50.  
Amphenol UG21B - N Male 3.50.  
Amphenol N Male For 9913 4.95.

### ANDREW HELIAX®

LDF4-50 - 1/2 Copper (1/Ft.) \$ 2.19  
LDF5-50 - 7/8 Copper (1/Ft.) .. 5.49  
Connectors: 1/2" - 29.00, 7/8" - 69.00

### ROTOR CABLE

Standard 8 Conductor Rotor Cable.  
(2 # 18Ga. & 6 # 22Ga.) \$ .25 / FT.

Heavy Duty 8 Cond. Rotor Cable.  
(2 # 16Ga. & 6 # 18Ga.) \$ .45 / FT.

### ROTATORS

Telex CD45II - 8.5 SQ. FT.  
Telex HAM4 - 15 SQ. FT.  
Telex TAILTWISTER - 20 SQ. FT.  
Telex HDR300 - 25 SQ. FT.  
Yaesu G500A Elevation Rotor.  
**Please Call For Prices On Rotator!**

## cushcraft

A3S - 3 Element Triband Beam.  
A4S - 4 Element Triband Beam.  
A743 / A744 - 30/40 Kit For Above.  
R5 - 20-10M, No Ground Vertical.  
AP8 - 80-10M Vertical Antenna.  
D40 - 40M Rotatable Dipole.  
40-2CD - 2 Element, 40M Beam.  
A50-5 - 5 Element, 6M Beam.  
215WB - 15 Element, 2M Beam.  
230WB - 30 Element, 2M Beam.  
4218XL - 18 Element, 2M Beam.  
3219 - 19 Element, 2M Beam.  
ARX2B - 2M Vertical antenna.  
**Call For Prices On All Cushcraft!**

### PHILLYSTRAN GUY CABLE

HPTG1200I - 1200 Lb. Rating. \$ .32  
HPTG2100I - 2100 Lb. Rating. \$ .36  
HPTG4000I - 4000 Lb. Rating. \$ .59  
HPTG6700I - 6700Lb. Rating. \$ .79  
Phillystran Guy Cable Is Non-  
conducting - No More Insulators.  
Also, The New Phillystran No  
Longer Uses Potting Heads, But  
Uses Regular Cable Clamps.  
**Please Call Us For Details!**

## TELEX hy-gain

### CRANKUP SALE

All Models Shipped  
Factory Direct - Prepaid.  
Features: All Steel - Hot  
Dipped Galvanized - Self-  
Supporting - With Rotor  
Shelf and Wench.

Model	Height	Load
HG37SS	37 FT.	9 S.F.
HG52SS	52 FT.	9 S.F.
HG54HD	54 FT.	16 S.F.
HG70HD	70 FT.	16 S.F.

Accessories For Hygain Towers  
Are Also Available For Immediate  
Delivery. **CALL FOR PRICE!**

### TELEX HYGAIN ANTENNAS

New DX88 HF Vertical Antenna.  
7-2 Discoverer - 2 El., 40M Beam.  
7-3 Discoverer - 3rd El. add-on Kit  
Explorer14 - 3 Element Tribander.  
QK710 - 30/40M Add-on Kit  
V2S - V3S - V4S - VHF/UHF Vert.  
TH5MK2S - 5 El., Triband Beam.  
TH7DXS - 7 El., Triband Beam.  
20SBAS - 5 El., 20M Beam.  
155BAS - 5 El., 15M Beam.  
105BAS - 5 El., 10M Beam.  
204BAS - 4 El., 20M Beam.  
64BS - 4 El., 6M Beam Antenna.  
18AVT/WBS - 80-10M Vertical.  
18HTS - 80-10M Hytower Vertical.  
**Call For Prices On All Hygain.**

## ROHN

### GUYED TOWER PACKAGES

HEIGHT	25G	45G	55G
50	849	1229	1549
60	939	1389	1939
70	999	1719	2159
80	1199	1869	2369
90	1289	2039	2579
100	1369	2199	2989
110	1449	2459	3209
120	1669	2619	3429

These Towers Are Shipped Com-  
plete With The Following: All Guy  
Hardware, Base Section, Rotor  
Plate; According To ROHN Specifi-  
cations. 70 MPH Design. Towers  
Are Shipped Freight Collect From  
Plano, TX. **IN STOCK NOW!**

### FOLDOVER TOWERS

Model	Height	Load Cap.
FK2548	48 Ft.	15.4S.F.
FK2558	58 Ft.	13.3 S.F.
FK2568	68 Ft.	11.7 S.F.
FK4544	44 Ft.	34.8 S.F.
FK4554	54 Ft.	29.1 S.F.
FK4564	64 Ft.	28.4 S.F.

GGK25GII - Double Guy Kit \$ 299.  
GGK45GII - Double Guy Kit \$ 319.

The Above Specifications Are At 70  
MPH, With The Above Double Guy  
Kit Properly Installed. ROHN Fold-  
over Towers Are Drop Shipped  
Freight Paid; Cost 10% Higher West  
Of The Rockies.

### STACKED SECTIONS

20G - Light Duty 12 Inch \$ 54.50  
25G - Medium Duty 12 In 65.50  
45G - Heavy Duty 18 Inch 153.50  
55G - Extra Heavy 18 Inch 197.50  
**Please Call For Pricing On All  
Rohn Accessories. Most Are In  
Stock For Immediate Delivery!**

## US TOWERS

All Steel Crank Up Towers And  
Poles. Hot Dip Galvanized To  
Withstand Rust. Totally Self  
Supporting - No Guy Wire!  
Coax Arms, Thrustbearings, Masts,  
Motor Drives, Optional Bases, And  
More Are Also In Stock For Quick  
Delivery. **Call For Special Pricing.**

Model	Min Ht.	Max Ht.	Load	Price
MA40	21 Ft.	40 Ft.	10 Sq.'	629
MA50	22 Ft.	50 Ft.	10 Sq.'	999
TX438	22 Ft.	38 Ft.	18 Sq.'	919
TX455	22 Ft.	55 Ft.	18 Sq.'	1385
TX472	22 Ft.	72 Ft.	18 Sq.'	2279
HDX555	22 Ft.	55 Ft.	30 Sq.'	2079
HDX572	22 Ft.	72 Ft.	30 Sq.'	3559

Shipping On US Tower Models is Collect From Visalia-  
California. Calif. Residents Please Add 6% State Tax.

### ROHN SELF SUPPORTING BX TOWERS

Model	Height	Load	Weight	Price
HBX40	40 Ft.	10 Sq.'	228	\$ 449
HBX48	48 Ft.	10 Sq.'	303	589
HBX56	56 Ft.	10 Sq.'	385	699
HDBX40	40 Ft.	18 Sq.'	281	569
HDBX48	48 Ft.	18 Sq.'	363	689

All ROHN BX Series Towers Are Shipped Freight  
Prepaid In The Continental United States. These  
Towers Come With The Base Stubbs At No  
Additional Charge As Well As The Rotor And Top  
Plates. The Above Antenna Load Ratings Are At 70  
MPH. Please Note That ROHN Does Not  
Recommend Using This Tower With Antennas That  
Have A Boom Length Exceeding 10 Foot.

### GUY WIRE AND HARDWARE

3/16 EHS Guywire (3990 Lb. Rating)	.15 / Ft
1/4 EHS Guywire (6650 Lb. Rating)	.18 / Ft
5/16 EHS Guywire (11,200 Lb. Rating)	.29 / Ft
5/32 (7X7) Aircraft Cable (2700 Lb. Rating)	.15 / Ft
3/16 CCM - Cable Clamp For 3/16 or 5/32	.45
1/4 CCM - Cable Clamp For 1/4	.55
1/4 TH - Thimble For All Guywire Listed	.45
3/8 EE - 3/8 X 6 Eye And Eye Tumbuckle	6.95
3/8 EJ - 3/8 X 6 Eye And Jaw Tumbuckle	7.95
1/2 X 9 EE - 1/2 X 9 Eye And Eye Trnkl.	9.95
1/2 X 9 EJ - 1/2 X 9 Eye And Jaw Trnkl.	10.95
1/2 X 12 EE - 1/2 X 12 Eye And Eye Trnkl.	12.95
1/2 X 12 EJ - 1/2 X 12 Eye And Jaw Trnkl.	13.95
5/8 X 12 EJ - 5/8 X 12 Eye And Jaw Trnkl.	16.95
3/16 Preformed Guy Grips (Replaces CCM)	2.49
1/4 Preformed Guy Grips (Replaces CCM)	2.99
GAS604 - 6 In. X 4 Ft. Earth Screw Anchor	19.95
500D - Guy Insulator (Up To 3/16)	1.99
502 - Guy Insulator (Up To 1/4)	3.49
Ground Rod - 5/8 X 8 Ft. Copper Clad	12.95
Coax Seal - Waterproofs Coax Connectors	2.50

### GALVANIZED STEEL MASTS

Wall	5'	8'	10'	12'	15'	20'
.12	29	39	49	59	69	89
.18	49	75	89	109	129	149
.25	69	109	129	159	189	249

These Galvanized Steel Mast Measure 2 Inch, Out-  
side Diameter And Are Available In 3 Different Wall  
Thicknesses. They Are All Galvanized, High Carbon  
Steel. Mast Measuring 8 Feet Or Less Can Be  
Shipped By Ups. Mast That Are Longer Than 8 Feet  
Must Be Shipped By Collect Freight.

### HUSTLER ANTENNAS

6BTV - 6 Band Vrt...149 5BTV - 5 Band Vrt...129  
G7-144B - 2M Vrt...129 G6-144B - 2M Vrt...89  
Hustler HF Mobile Resonators Are Also In Stock.  
**Please Call For Pricing On Other Hustler Items.**

**PLEASE ADD ESTIMATED SHIPPING ON  
TOWER AND ANTENNA RELATED PRODUCTS.**

**ORDER TOLL FREE 1 - (800) 272 - 3467**

**LOCAL AND TECHNICAL INFORMATION PHONE: 1 - (214) 422 - 7306**

**FAX ORDER AND INFORMATION PHONE: 1 - (214) 881 - 0776**

HOURS: 9AM - 5PM  
SAT. 9AM - 1PM

# TEXAS TOWERS

C.O.D.  
MC / VISA

Div. of Texas RF Distributors, Inc., 1108 Summit Ave. Suite # 4, Plano, TX 75074

CIRCLE 136 ON READER SERVICE CARD

770-25-26



*Jarvis Island is a National Wildlife Refuge, and a bird-watcher's paradise.*



*"Let's use both landings. That way we can mobilize quickly while still keeping at least 1000 foot separation between the two sites," we argue (N7NG, K3NA, OH2BH, AH3C, and Mark Rauzon).*

not just one, or maybe even three? Kingman Reef is only 50 miles away from Palmyra. Jarvis is over 450 miles away from Palmyra but it is still tied to Palmyra on the current list! Each has its parent as the USA. The geography has changed also. In 1983 the Republic of Kiribati entered into an agreement with other nations to honor their respective 200 mile economic zones. This created an intervening country between Palmyra and Jarvis and would qualify Jarvis as separate from Palmyra, if the baseline were defined based on the area of influence around Washington Island. Also, we can show that there were amateur radio operations on Jarvis during a period when the DXCC desk would have quickly added Jarvis, but it was merely overlooked because those amateurs then operating simply did not follow DXCC and didn't make a case for it.

Why not make a run for it, make a presentation that clears the air? When the smoke clears, a new DXCC country just may surface.

### Gathering the Muscle

Who could be more knowledgeable about this sort of thing than Martti Laine, OH2BH, who successfully launched four new DXCC countries? It is December 1989 and Martti is in California poring over the maps with Wayne, N7NG, looking for a new one. Together we research Jim, W6CF's files for historical DXCC information. Eric, K3NA, is brought in to review our initiative. He wants to help and makes his and Toni, KN3T's commitment to join the group to operate on Jarvis Island.

"Sleep on it," says Martti. "Then call me or



*A true multi-national flag-raising ceremony.*

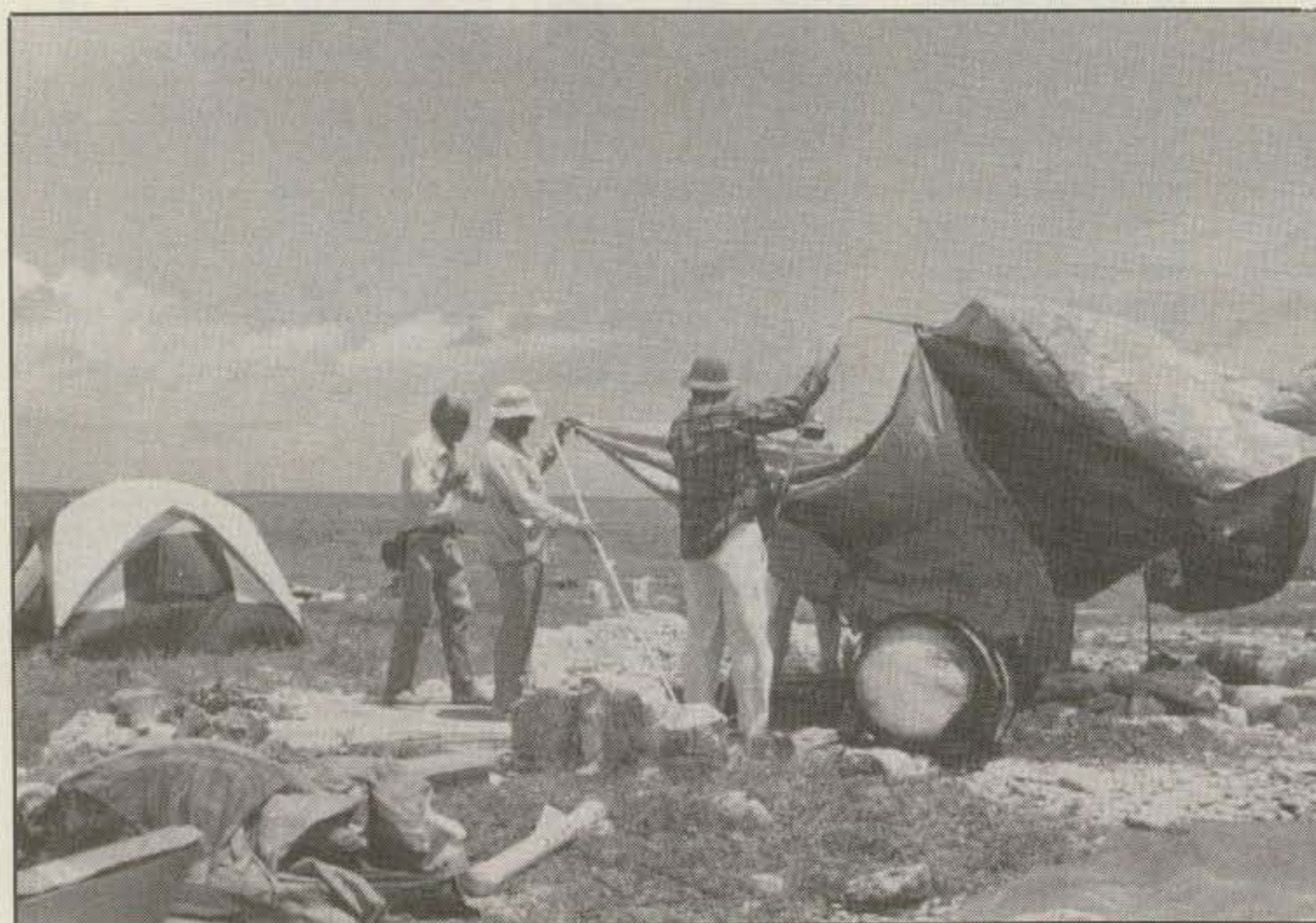

*Let's see . . . how does this thing go together, anyway? It's beginning to look like a kite.*

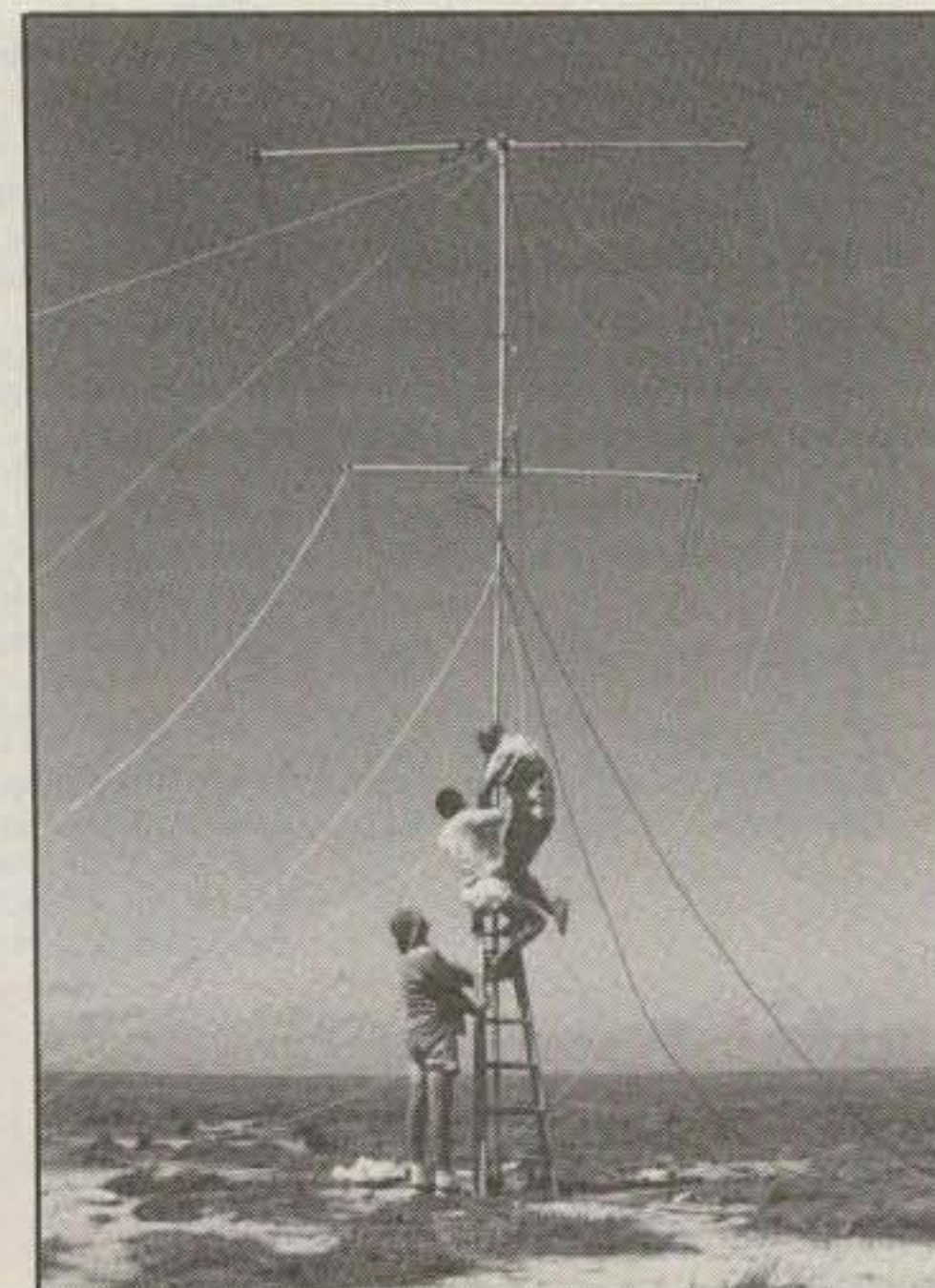

*Stacking antennas calls for real team effort. Now we know what the ladder was for.*

BAND	JAPAN	USA	EUROPE	OTHER	TOTAL	TOTAL
28 CW	1243	4377	178	358	6156	
28 SSB	1299	8068	74	956	10397	
28 RTTY	25	23		21	69	
					TOTAL 28	16622
					MHz	
21 CW	1371	3454	1936	504	7265	
21 SSB	2621	3239	2638	701	9199	
21 RTTY	36	272		14	322	
					TOTAL 21	16786
					MHz	
14 CW	1257	2886	2526	544	7213	
14 SSB	1213	3288	2038	735	7274	
14 RTTY	5	8	27	2	42	
					TOTAL 14	14529
					MHz	
7 CW	657	1338	182	136	2313	
7 SSB	747	1598	184	214	2743	
					TOTAL 7	5056
					MHz	
3.5 CW	73	387		31	491	
3.5 SSB	48	253		33	334	
					TOTAL 3.5	825
					MHz	
					TOTAL 1.8	35
					MHz	
					TOTAL 10	65
					MHz	
					TOTAL 18	100
					MHz	
					TOTAL 24	147
					MHz	
					TOTAL 50	450
					MHz	
<b>TOTALS</b>	<b>10595</b>	<b>29191</b>	<b>9783</b>	<b>4249</b>		<b>54615</b>

fax me the information. We Finns always find fresh, clearer thinking after a good rest."

The team is growing. Our friend Kan, JA1BK, not only offers to be our spokesman for securing Japanese support, but also selects Japanese operator Masahiro "Misa," JG2BRI, to manage 6 meters and to represent JA ranks for this operation. Now we are six. Still, we need more help. NCDXF offers solid financial and logistics support. ICOM recognizes the value of this major gathering of forces and offers to help with loaning seven modern IC-735

transceivers which are aimed at portable operations like ours.

Our transportation must have just the right combination. Navigation must be impeccable, weather must be hospitable, customs must be understanding, and everyone must be on time. We commit personal funds to get us there and back. The boat charter alone is approaching \$20,000—up front!

While meeting on the air we decide to go for four HF stations. Jim, WA6AUE, is brought in to beef up our CW operation. Pertti, OH2RF, with



Site 1—The Cushcraft A3 tribander is about 60 feet above the water. Most of our phone contacts were made from here.

## GORDON WEST RADIO SCHOOL

### #04 21-DAY NOVICE . . . . . \$22.95



- 112-page textbook
- two stereo code learning tapes
- sample 5 wpm Novice code test
- over \$50 in radio manufacturers' discount coupons.

### #01 COMPLETE NOVICE . . . \$62.95

2 theory tapes, 2 textbooks, FCC Rule Book, 4 code tapes, code oscillator set, examiner test packet, and over \$50 in radio discount coupons.

### #02 NOVICE CODE COURSE \$32.95

6 cassette tapes make it easy to learn the code from scratch.

### #07A 2-WEEK TECH . . . . . \$22.95

This Technician course includes 2 theory tapes and 1 illustrated textbook.

### #05 COMPLETE GENERAL. . \$62.95

6 code tapes, 4 theory tapes, and 2 textbooks. Ideal for upgrade from Novice to General.

### #06 GEN. CODE COURSE . . \$32.95

This General course includes 6 tapes for speed building from 5 to 13 wpm.

### #08B COMPLETE ADVANCED \$62.95

This Advanced course includes 4 theory tapes, 1 textbook, and 6 code tapes (13 to 22 wpm).

### #09 ADV. THEORY COURSE \$32.95

4 tapes and 1 illustrated textbook

### #10 COMPLETE EXTRA. . . \$62.95

4 theory tapes, 1 textbook, and 6 code tapes (13 to 22 wpm).

### #12 EXTRA THEORY COURSE \$32.95

4 theory tapes and 1 illustrated textbook for Extra class theory.

### #11 EXTRA CODE COURSE \$32.95

6 tapes for speed building from 13 to 22 wpm for the Extra code exam.

### #13 BRASS KEY & OSC. . . . \$25.95

### #15 PLASTIC KEY & OSC. . . \$21.95

#### SINGLE CODE TAPES

\$10.95 each including shipping

- #19 5 wpm Novice QSO tests
- #20 5 wpm Random Code
- #21 5-7 wpm Speed Builder
- #22 7-10 wpm Speed Builder
- #23 10 wpm Plateau Breaker
- #24 10-12 wpm Speed Builder
- #25 12-15 wpm Calls & Numbers
- #26 13 wpm Random Code
- #27 13 wpm Test Preparation
- #28 13 wpm Car Code
- #29 13-15 wpm Speed Builder
- #30 15-17 wpm Speed Builder
- #31 17-19 wpm Speed Builder
- #32 20 wpm Random Code
- #33 20 wpm Test Preparation
- #34 20 wpm Car Code
- #43 3-15 wpm Code Review
- #40 12-21 wpm Code Review

Prices include shipping & handling  
IL residents add 6½%

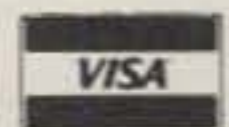

### RADIO AMATEUR CALLBOOK INC.

925 Sherwood Dr., Lake Bluff, IL 60044  
Mon.-Fri. 8-4pm (708) 234-6600

CIRCLE 151 ON READER SERVICE CARD

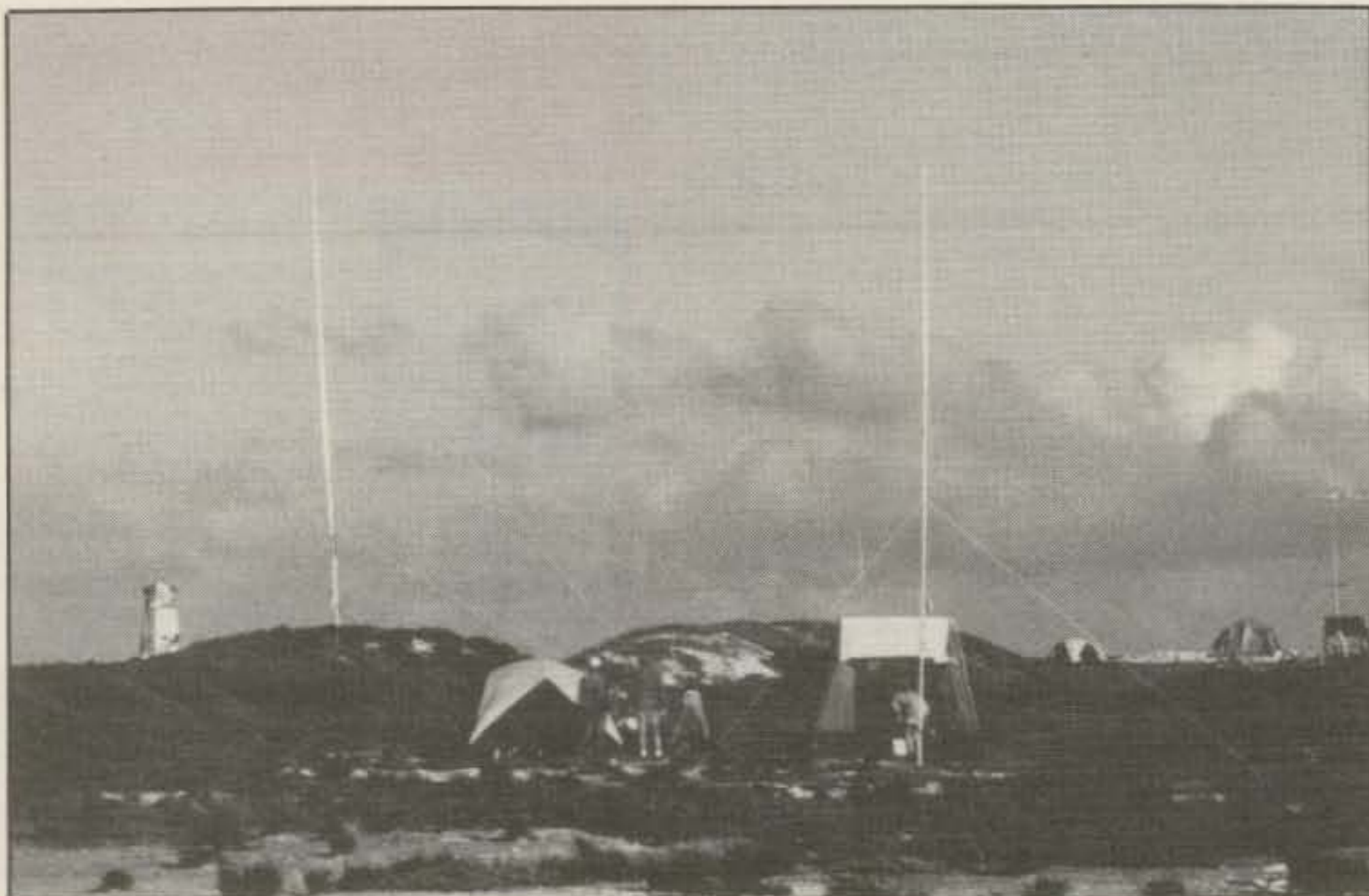

A view of both sites. It is now time to erect the stacked array at site 2. Do we have any volunteers?



AH3C/MM—the main cabin below is no place for landlubbers on the high seas.

his knowledge of European operators and propagation adds a refinement to smooth our total team effort.

"Don't forget the ladder," says Wayne.

"Six foot? Ten foot? Wood? Aluminum?" asks Pete.

"Make it a standard 6 foot, sturdy, wooden, self-supporting ladder."

"OK. That will be item 127. Do we need amplifiers for this operation?"

Martti immediately announces, "Regardless of power requirements, we should be using a minimum of 1 KW at each radio to keep full command of the pile-ups. We definitely want to reach our small audience by building up the balance with our power and having our beams high enough."

The U.S. Fish & Wildlife Service grants permission for our visit. However, we must not disturb any of the wildlife on the island, and we will

have Mark Rauzon, wildlife biologist, with us. He will survey the wildlife population.

Equipment and supplies must be staged in Honolulu, identified, checked out, and loaded on the boat. I commit to an extra week off from work. Our supportive KH6 group—KH6VP, AH6IO, KH6JEB, KH6IJ, and Mrs. Nose—help tie the ribbon. In the meantime, Eric, K3NA, is busy researching the history of Jarvis Island and preparing the first-draft DXCC initiative. The fax machines are smoking from all the action. Three weeks before departure we make the announcement of our intentions to go to Jarvis and to introduce our proposal to ARRL.

Our sailing vessel, the 71 foot ketch *Makanalani*, is properly outfitted with satellite navigation equipment, sextant, radar, depth finder, powerful engine, two rafts, berths for ten, a deck crew of two, galley complete with first mate as chef, and expert captain. The bright

red diesel fuel containers stand like soldiers in the sparkling Pacific sun.

## Bon Voyage

It is Sunday, April 1, five days before the Visalia International DX Convention as Judy, my XYL, and I wave good-bye from the *Makanalani* to Manny Pires, KH6AY, and his XYL, standing at the dock. Manny was one of the first amateur radio operators on Jarvis Island in 1938.

A 20 meter dipole is strung between the two masts and AH3C/MM maintains daily contact with the rest of the team. After three days of trying to operate below deck, setup of the IC-735 is moved to the cockpit. The main cabin is no place for a greenhorn landlubber. After six days of rough, choppy sailing the seas get much bigger as a storm passes directly over

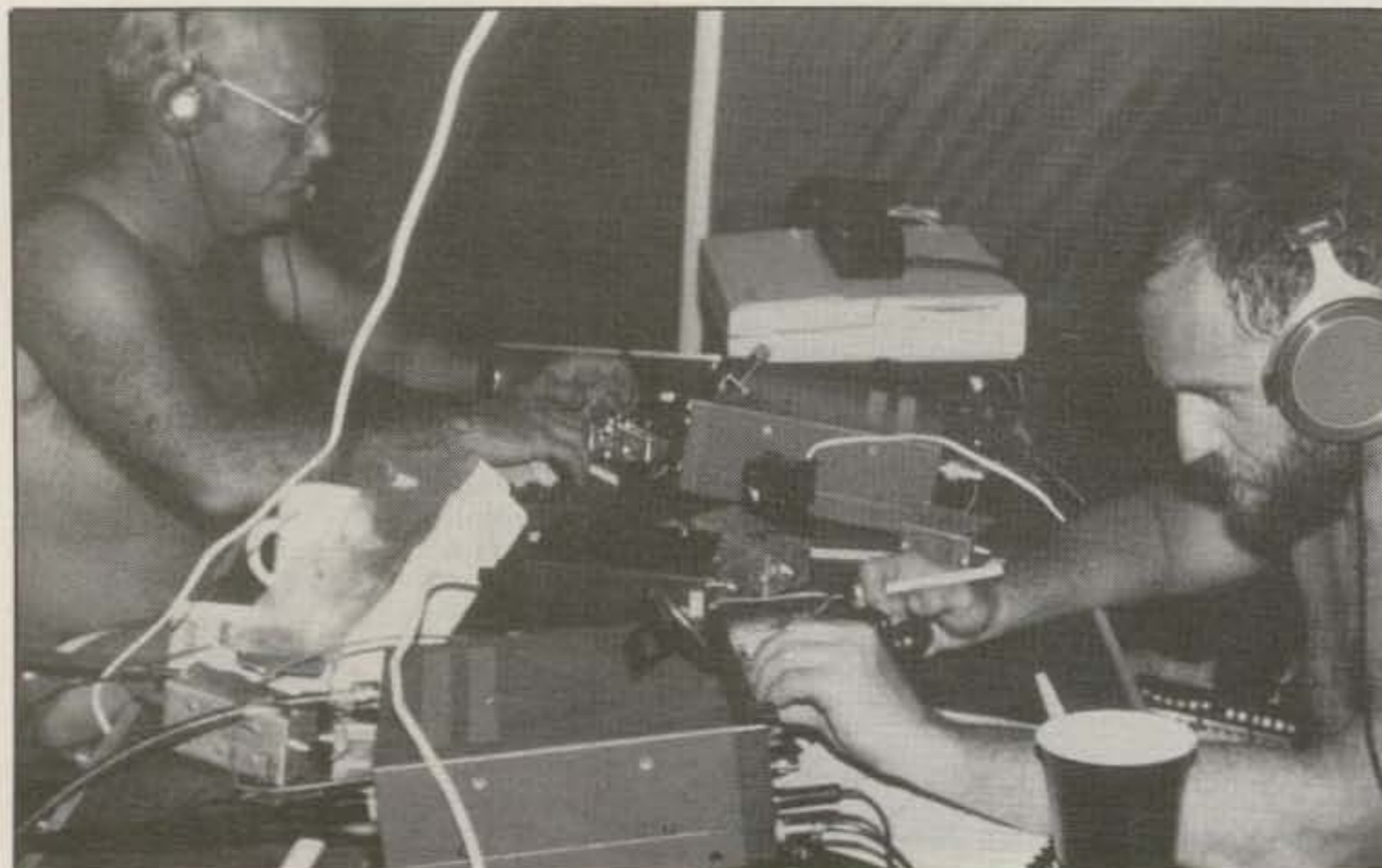

Now are having some real "fun"! The Jarvis work-em-all contest has begun! Wayne, N7NG, and Eric, K3NA, banging it out on CW.



If you heard that fast-talking YL signing "QRZ?" you nabbed a new one for YLDXCC—Toni, KN3T.

# MFJ gives you *all 9* digital modes and *keeps on* bringing you state-of-the-art advances . . . while others offer you *some* digital modes using 3 year old technology!

MFJ-1278

**\$279<sup>95</sup>**



No 3 year old technology at MFJ! Using the latest advances, MFJ brings you 9 exciting digital modes and *keeps on* bringing you state-of-the-art advances like new ASA™.

You get tons of features other multi-modes just don't have.

### Only MFJ gives you *all 9* modes

Count 'em -- you get 9 fun modes -- Packet, AMTOR, RTTY, ASCII, CW, FAX, SSTV, Navtex and Contest Memory Keyer.

You can't get all 9 modes in *any* other multi-mode at *any* price. Nobody gives you modes MFJ-1278 doesn't have.

### The best modem you can get

Tests in *Packet Radio Magazine* prove the modem used in the MFJ-1278 copies HF packet more accurately than all other modems tested.

MFJ-1278 is the *only* multi-mode with a *true* DCD circuit. This dramatically reduces sensitivity to noise and dramatically increases completed QSOs.

### Exclusive Built in Printer Port

Only the MFJ-1278 has a dedicated printer port that lets you plug in your Epson or IBM compatible printer.

You don't need to buy a silly \$40 cable just to plug in your printer.

### 20 LED Precision Tuning Indicator

MFJ's unequalled tuning indicator makes it really easy to work HF packet. Unlike others, you use it the same for all modes -- not different for each mode. Just tune your radio to center a single LED and *you're precisely tuned in to within 10 Hz* -- and it shows you which way to tune!

### New Easy Mail™ Personal Mailbox

You get MFJ's new Easy Mail™ Personal

### MFJ Packet Radio



MFJ-1274

**\$159<sup>95</sup>**

MFJ-1270B

**\$139<sup>95</sup>**

MFJ-1270B super clone of TAPR's TNC-2 gives you more features than *any* other packet controller -- for \$139.95

You can double your fun by operating VHF and HF because you get *high performance* switchable VHF/HF modems.

You get the Easy Mail™ Personal Mailbox with soft-partitioned memory so you and your buddies can leave messages 24 hours a day.

In MFJ's new WeFAX mode you can print full-fledged weather maps to screen or printer and save to disk using most computers.

A new KISS interface lets you run TCP/IP and MSYS. NET ROM compatible.

You also get 32K RAM and a free 110 VAC power supply (or use 12 VDC).

For dependable HF packet tuning, the MFJ-1274 gives you a high resolution tuning indicator -- and it's only \$20 more.

New 2400 baud Turbo models available: MFJ-1270BT, \$209.95; MFJ-1274T, \$229.95.

Mailbox with soft-partitioned memory so you and your ham buddies can leave messages for each other 24 hours a day.

### Multi-Gray Level FAX/SSTV Modem

You'll see tomorrow's news today when you copy outstanding FAX news photos with crisp clear details. MFJ-1278 is the *only* multi-mode with a built-in multi-gray level modem. It lets you transmit and/or receive multi-gray level pictures with an appropriate terminal program.

### MFJ's new Automatic Signal Analysis™

**NEW!** gives you *exclusive* HF packet identification!

MFJ's new ASA automatically identifies HF packet, RTTY, ASCII and AMTOR signals. A

kiss interface or dumb modem, fast throughput anti-collision technology, independent transmit level for each radio port, random code generator, lithium battery backup, RS-232 and TTL serial ports, socketed ICs, tune up command, peripheral I/O port, automatic serial numbering, programmable message memories, dual radio ports (*each* HF or VHF), CW paddle jack, audio amplifier and speaker jack so you can monitor CW sidetone, transmit and receive audio and packet connect bell, *new* fully integrated instruction manual with *Fast Start™* booklet and more. 9½ x 9½ x 1½ inches.

### No Matter What™ Guarantee

You get MFJ's one year No Matter What™ Guarantee.

That means we will repair or replace your MFJ multi-mode (at our option) *no matter what* happens to it for a year.

Others give you a *limited* warranty. What if *they* say, "Sorry, your *limited* warranty doesn't cover *that*?"

### Get 9 new ways of having fun

Don't settle for 3 year old technology.

Choose the *only* multi-mode that gives you the latest advances and all 9 modes.

Get 9 new ways of having fun *today!*

### Software Pack gets you on the air *instantly!*

MFJ software packs with interface cable get you on the air *instantly* if you use an IBM compatible, Commodore or Macintosh computer. Here are some of the programs available:

MFJ-1289, \$59.95. Menu driven. Super IBM compatible program. See ad below for details.

MFJ-1282B, \$39.95. New with multi-gray receive for Commodore 64/128. Menu driven.

MFJ-1287, \$24.95. Macintosh starter pack.

quick "OK" command selects the mode!

### One FREE Upgrade!

When you buy your MFJ-1278 *today*, you don't have to miss new modes and features that come out *tomorrow*. **Why?** Because your 1278 comes with a coupon good for one *free* eeprom upgrade exchange that'll add new features.

### Plus More . . .

Plus you get . . . 32K RAM, *free* AC power supply, Host mode that lets MFJ-1278 serve as

### New MFJ MultiCom™ . . . exciting new 1278 software

*High resolution AP news photo received on 20.738 MHz using MFJ MultiCom and MFJ-1278 with multi-gray modem.*



MFJ-1289 New menu-driven MultiCom™ brings out the full power of your MFJ-1278 with multi-gray modem. **\$59<sup>95</sup>**

No set-up required -- just load and use. You get incredible high resolution WeFAX maps and AP news photos right off HF. You also get color packet pictures and multi-gray SSTV.

**Bursting** with features . . . One-Key Macros™ combine multiple keystrokes into a single touch, Call-Alert™ sounds an alarm when any characters you tell it to watch for come in, Auto-Set™ instantly switches entire stored sets of parameters, Auto-Router™ stores digipeater node routes for instant use, Packet Multi-Plex™ lets you transmit or receive a binary file and continue your QSO, Multi-Word™ gives a powerful word processor that is tailor-made for multi-mode communications.

Custom QSL created with paint program

*Multi-Gray WeFAX weather map received on 16.410 MHz using MFJ MultiCom and MFJ-1278 with multi-gray modem.*

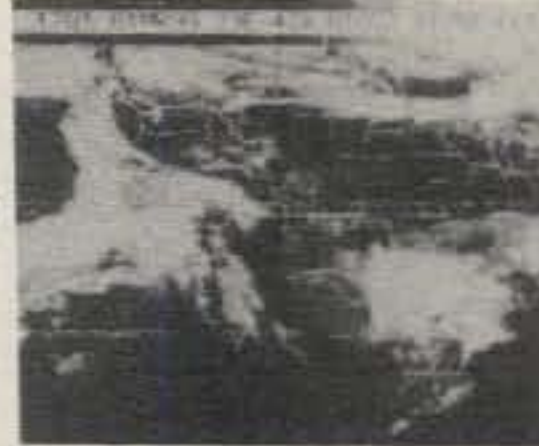

can be transmitted by FAX, SSTV or Packet. On-line help. RS-232 cable. Tons more. Call for *free* MFJ catalog for full information: 800-647-1800.

**Optional MFJ-1292 digitizer, \$199<sup>95</sup>** . . . lets you *instantly* point, shoot and transmit a video picture -- all in one smooth sequence

Transmit your very own digitized pictures all over the world by packet, FAX or SSTV. MFJ MultiCom™ lets you integrate the MFJ-1292 "Picture Perfect" Video Digitizer, \$199.95 with your MFJ-1278 for shooting and transmitting your pictures in one smooth sequence.

Nearest Dealer/Orders: 800-647-1800



MFJ ENTERPRISES, INC.  
Box 494, Miss. State, MS 39762  
(601) 323-5869; TELEX: 53 4590  
FAX: (601) 323-6551; Include s/h.

MFJ . . . making quality affordable

© 1990 MFJ Enterprises, Inc.

# SUPER LONG PLAY TAPE RECORDERS

12 Hour Model —  
USES 120 TAPE  
\$119.00\*

Modified Panasonic Slimline, high quality AC-DC provide 6 continuous hours of quality recording & playback on each side of cassette for 12 hours total. Includes • Voice level control • Digital counter, etc. TDK -120 Cassette Furnished.



## PHONE RECORDING ADAPTER

Records calls automatically. All Solid state connects to your telephone jack and tape recorder. Starts recording when phone is lifted. Stops when you hang up.

\$28.50\*  
FCC APPROVED

## VOX VOICE ACTIVATED CONTROL SWITCH

Solid state. Self contained. Adjustable sensitivity. Voices or sounds automatically activate and control recorder. Uses either recorder or remote mike.

\$28.50\*

\*Add for ship & hdg. Phone Adapter & Vox \$1.50 ea. Recorders \$4.00 ea. Cal. Res. add tax. Mail order, VISA, M/C, COD's OK. Money Back Guarantee. Qty. disc. avail. Dealer Inquiries invited, Free data.

AMC SALES INC. Dept. Q 9335 Lubec St.  
Box 928, Downey, CA 90241.  
Phone (213) 869-8519  
FAX (213) 923-1478

CIRCLE 46 ON READER SERVICE CARD

## Enjoy NEVER CLIMBING YOUR TOWER AGAIN

Are you too scared or too old to climb? Never climb again with this tower and elevator tram system. Voyager towers are 13 and 18 inch triangular structures stackable to any height in 7 1/2", 8 3/4" or 10" section lengths. Easy to install hinge base, walk up erection. Next plumb tower with leveling bolts in base. Mount rotor and large heavy beams on Hazer tram and with one hand winch to top of tower for normal operating position. Safety lock system operates while raising or lowering. At last a cheap, convenient and safe way to install and maintain your beam. This is a deluxe tower system that you can enjoy today.

**SPECIAL TOWER PACKAGE:** 50 ft. high by 18" face tower kit, concrete footing section, hinged base, HAZER kit, Phillystran guy wires, turnbuckles, earth screw anchors, 10' mast, thrust bearing, tool kit, ground rod and clamp, rated at 15 sq. ft. antenna load @ 100 MPH. **\$1974.95.**

50' by 18" wide tower, same pkg as above	\$1670.95
HAZER 2 for Rohm 25-hvy duty alum 12 sq ft wind ld	\$24.95
HAZER 3 for Rohm 25-std alum 8 sq ft wind load	\$32.95
HAZER 4 for Rohm 25-hvy galv 16 sq ft wind ld	\$63.95
TB 25 Ball thrust bearing, 2" max mast dia.	74.95
NEW HAZER 448 Thrust System for Rohm 45, 22 sq ft wind load	892.00
NEW HAZER 449 Thrust System for Rohm 55, 22 sq ft wind load	895.00

Satisfaction guaranteed. Call today and order by Visa, M/C or mail check. Immediate delivery.

Glenn Martin Engineering, Inc.  
Dept. C  
RR 3, Box 322,  
Boonville, MO 65233  
**816-882-2734**  
FAX: 816-882-7200



CIRCLE 32 ON READER SERVICE CARD

*Makanalani*. Ten foot seas combined with blinding rain and 40 knot winds make us all aware of our vulnerable position. Ten hours later the storm subsides and we take inventory. No damage to equipment, but the boat bites are numerous.

We inch our way toward Christmas Island late at night on April 8th. Phil, T32AN, guides *Makanalani* by VHF radio to a suitable harbor at midnight. On the next day, as soon as the sun clears the palm trees, we don the scuba gear and jump overboard for a refreshing dive. The customs officials arrive at 10 AM and we are cleared to land.

The Captain Cook Hotel has hosted many T32 hams. It is set up with a special bungalow with two radio operating positions. We gather up the ICOM gear to check it over. The station and antenna are put together with help from the hotel staff and T32BS is on the air by 7 PM. Conditions are terrible! Boulder A-index is 48 and K-index is over 7. A major proton event is in progress. Absolutely no luck over the pole. Only 300 QSOs during the one and only night of operating. Oh well, at least the equipment is functional.

The weekly 737 from Honolulu is on time. Phil, T32AN, greets us in his well-rigged truck. His support is like manna from heaven. It is 20 miles from the airport to the dock. We cannot leave without our passports being stamped by customs. All the officials are still at the airport. We "cool our heels" and get acquainted. The waiting in the searing sun is an omen of things to come. Humidity is 95% and it is 95 degrees F outside. Four hours later the officials return from the airport and we are finally free to go on to Jarvis Island.

Once on board, the detailed plotting of each site comes together. Two teams are created. Site 1 has OH2BH as team captain with OH2RF, AH3C, and JG2BRI. Site 2 has N7NG as team captain, with WA6AUE, K3NA, and KN3T. Layout is visualized and landing party selected.

Two hours before dawn early in the morning of the third day at sea our skipper, Tony Clarke, points about 30 degrees to port (the left) and announces he has sighted land. We stare in disbelief. After all, it is Friday the 13th. We can expect everything to go wrong this day. Moments later the first blip of radar appears on the screen about 6 miles away. Who can be sleeping at a time like this? We all gather in the cockpit as the glow of first light begins to silhouette Jarvis Island. Volunteering for watch, two Brown Boobies sweep in and plant themselves on top of the masts. A dozen Frigate Birds hover overhead like sentinels. A school of porpoises dashes across our bow, and a lone Manta Ray lazily cuts the surface with his dorsal fin. If all goes well, today will be our first day of operation.

## Staging, Construction, and Startup

We are able to drop anchor just outside the break in the reef. Wayne, N7NG, is first of our group to land. Our 2 meter HTs provide the first two-way radio contact with Jarvis Island since 1983 when George, AD1S's team was there. Each trip to shore we bring at least one passenger in the first zodiac and a full load of gear on the second zodiac. There is no movement of air. The work must be accomplished at the hottest time of day. We are consuming water at an



"There are 24 hours in a day, Misa. Don't you dare miss a single 6 meter opening!" JG2BRI remembers his instructions from JA1BK.

alarming rate. Six trips and 4 hours of hauling up the 25 foot hill to the SSB site, plus 2 more hours of dragging over to the CW site wilts the entire team.

The tents are identified and the teams go to work. Two non-campers (myself and Martti) wrestle the flimsy floorless wall tent in the 15 knot breeze. Jim and Wayne (our experienced campers, we later find out) are too weak from their struggle with the generators to find the tent erection project humorous. Yet once the corners of the airy tent are secured, they are ready for a new assignment. Site 2 is selected approximately 1000 feet due west of the shoreline SSB site so as to be separated just far enough to permit CW and SSB operating on the same band at any time to optimize propagation conditions. Broadside to the north is required so we can be absolutely assured that we have maximum attenuation of transmitted signals



"Get off my frequency! Can't you tell we are busy here?" Pertti, OH2RF, commands!



# BEST OF MFJ

MFJ, Bencher and Curtis team up to bring you America's most popular keyer in a compact package for smooth easy CW



MFJ-422B

\$134<sup>95</sup>

The best of all CW world's -- a deluxe MFJ Keyer using a Curtis 8044ABM chip in a compact package that fits right on the Bencher iambic paddle!

This MFJ Keyer is small in size but big in features. you get iambic keying, adjustable weight and tone and front panel volume and speed controls (8-50 WPM), dot-dash memories, speaker, sidetone and push button selection of automatic or semi-automatic/ tune modes. It's also totally RF proof and has ultra-reliable solid state outputs that key both tube and solid state rigs. Use 9 volt battery or 110 VAC with MFJ-1305, \$12.95.

The keyer mounts on a Bencher paddle to form a small (4-1/8 x 2-5/8 x 5/2 inches) attractive combination that is a pleasure to look at and use.

The Bencher paddle has adjustable gold plated silver contacts, lucite paddles, chrome plated brass and a heavy steel base with non-skid feet.

You can buy just the keyer assembly, MFJ-422BX, for only \$79.95 to mount on your Bencher paddle.

## Deluxe 300 W Tuner



MFJ-949D

\$149<sup>95</sup>

MFJ-949D is the world's most popular 300 watt PEP tuner. It covers 1.8-30 MHz, gives you a new peak and average reading Cross-Needle SWR/Wattmeter, built-in dummy load, 6 position antenna switch and 4:1 balun -- in a compact 10 x 3 x 7 inch cabinet. Meter lamp uses 12 VDC or 110 VAC with MFJ-1312, \$12.95.

## Antenna Bridge

MFJ-204B

\$79<sup>95</sup>

Now you can quickly optimize your antenna for peak performance with this portable, totally self-contained antenna bridge.

No other equipment needed -- take it to your antenna site. Determine if your antenna is too long or too short, measure its resonate frequency and antenna resistance to 500 ohms. It's the easiest, most convenient way to determine antenna performance. Built in resistance bridge, null meter, tunable oscillator-driver (1.8-30 MHz). Use 9 V battery or 110 VAC with AC adapter, \$12.95.



## SuperActive Antenna

"World Radio TV Handbook" says MFJ-1024 is a "first rate easy-to-operate active antenna ... quiet ... excellent dynamic range ... good gain ... very low noise ... broad frequency coverage ... excellent choice."

Mount it outdoors away from electrical noise for maximum signal, minimum noise. Covers 50 KHz to 30 MHz.

Receives strong, clear signals from all over the world. 20 dB attenuator, gain control, ON LED. Switch two receivers and aux. or active antenna. 6x3x5 in. Remote unit has 54 inch whip, 50 ft. coax and connector. 3x2x4 in. Use 12 VDC or 110 VAC with MFJ-1312, \$12.95.



MFJ-1024 \$129<sup>95</sup>

## VHF SWR/Wattmeter

MFJ-812B

\$29<sup>95</sup>

Covers 2 Meters and 220 MHz. 30 or 300 Watt scales. Also reads relative field strength 1-170 MHz and SWR above 14 MHz. 4 1/2 x 2 1/4 x 3 in.



## MFJ Coax Antenna Switches



\$34<sup>95</sup> MFJ-1701



\$21<sup>95</sup> MFJ-1702B



\$59<sup>95</sup> MFJ-1704

Select any of several antennas from your operating desk with these MFJ Coax Switches. They feature mounting holes and automatic grounding of unused terminals. They come with MFJ's one year unconditional guarantee.

MFJ-1701, \$34.95. Six position antenna switch. SO-239 connectors. 50-75 ohm loads. 2 KW PEP, 1 KW CW. Black alum. cabinet. 10x3x1 1/2 inches. MFJ-1702B, \$21.95. 2 positions plus new Center Ground. 2.5 KW PEP, 1 KW CW. Insertion loss below .2 dB. 50 dB isolation at 450 MHz. 50 ohm. 3x2x2 in. MFJ-1704, \$59.95. 4 position cavity switch with lightning/surge protection device. Center ground. 2.5 KW PEP, 1 KW CW. Low SWR. Isolation better than 50 dB at 500 MHz. Negligible loss. 50 ohm. 6 1/4 x 4 1/4 x 1 1/4 in.

## "Dry" Dummy Loads for HF/VHF/UHF



MFJ-260B \$28<sup>95</sup>

MFJ-262 \$69<sup>95</sup>

MFJ-264 \$109<sup>95</sup>

MFJ has a full line of dummy loads to suit your needs. Use a dummy load for tuning to reduce needless (and illegal) QRM and save your finals.

MFJ-260B, \$28.95. VHF/HF. Air cooled, non-inductive 50 ohm resistor. SO-239 connector. Handles 300 Watts. Run full load for 30 seconds, derating curve to 5 minutes. SWR less than 1.3:1 to 30 MHz, 1.5:1 to 150 MHz. 2 1/2 x 2 1/2 x 7 in.

MFJ-262, \$69.95. HF. 1 KW. SWR less than 1.5:1 to 30 MHz. 3x3x13 in.

MFJ-264, \$109.95. Versatile UHF/VHF/HF 1.5 KW load. Low SWR to 650 MHz, usable to 750 MHz. Run 100 watts for 10 minutes, 1500 watts for 10 seconds. SWR is 1.1:1 to 30 MHz, below 1.3:1 to 650 MHz. 3x3x7 inches.

## MFJ Ham License Upgrade Theory Tutor



MFJ Theory Tutor practically guarantees you'll pass the theory part of any FCC ham license exam. Versatile MFJ software is the best computer tutor ever tailor-made for ham radio. You can study the entire FCC question pool, selected areas and take (or print) sample tests. Auto. saves each study session (ex. sample tests), gives you all FCC test graphics (ex. mono.), explanations of hard questions, pop-up calculator, weighted scoring analysis, color change option and more. Order MFJ-1610-Novice; MFJ-1611-Tech.; MFJ-1612-Gen.; MFJ-1613-Adv.; MFJ-1614-Ex. for IBM compatible. For Macintosh: MFJ-1630-N; MFJ-1631-T; MFJ-1632-G; MFJ-1633-A; MFJ-1634-E, \$29.95 per license class. MFJ-284 or MFJ-286

## MFJ Speaker Mics

\$24<sup>95</sup>

MFJ's compact Speaker/Mics let you carry your HT on your belt and never have to remove it to monitor calls or talk.

You get a wide range speaker and first-rate electret mic element for superb audio on both transmit and receive.

Earphone jack, handy lapel/pocket clip, PTT, lightweight retractable cord. Gray. One year unconditional guarantee.

MFJ-284 fits ICOM, Yaesu, Santec. MFJ-286 fits Kenwood.



## MFJ-1278 Multi-Mode Data Controller

MFJ-1278

\$279<sup>95</sup>

Use computer to transmit/receive in all 9 digital modes: Packet, AMTOR, ASCII, CW, RTTY, FAX, SSTV, Contest Memory Keyer and Navtex receive. Easy-Mail™ Personal Mailbox, Built-in printer port, 20 LED tuning indicator, AC power supply, Host/KISS, 32K RAM, Multi-gray level FAX/SSTV modem, CW key paddle jack and tons more. Options include 2400 baud modem (MFJ-2400, \$79.95) and software starter packs with computer cables, \$24.95 each, for IBM compatible, Commodore 64/128, Macintosh and VIC-20.



## 12/24 Hour LCD Clocks



\$19<sup>95</sup> MFJ-108B \$9<sup>95</sup> MFJ-107B

Huge 5/8 inch bold LCD digits let you see the time from anywhere in your shack. Choose from the dual clock that has separate UTC/local time display or the single 24 hour ham clock.

Mounted in a brushed aluminum frame. Easy to set. The world's most popular ham clocks for accurate logs. MFJ-108B 4 1/2 x 1 x 2; MFJ-107B 2 1/4 x 1 x 2 in.

## Cross-Needle SWR/Wattmeter

MFJ-815B \$69<sup>95</sup>

MFJ Cross-Needle SWR/Wattmeter has a new peak reading function! It shows you SWR, forward and reflected power in 2000/500 and 200/50 watt ranges. Covers 1.8-30 MHz.

Mechanical zero adjusts for movement. SO-239 connectors. Lamp uses 12 VDC or 110 VAC with MFJ-1312, \$12.95.

## Deluxe Code Practice Oscillator

MFJ-557 \$24<sup>95</sup>

MFJ-557 Deluxe Code Practice Oscillator has a Morse key and oscillator unit mounted together on a heavy steel base so it stays put on your table. Portable because it runs on a 9-volt battery (not included) or an AC adapter (\$12.95) that plugs into a jack on the side.

Earphone jack for private practice, Tone and Volume controls for a wide range of sound. Speaker. Key has adjustable contacts and can be hooked to your transmitter. Sturdy. 8 1/2 x 2 1/4 x 3 3/4 in.

## MFJ Multiple DC Outlet

MFJ-1112 \$29<sup>95</sup>

New MFJ DC Power Outlet saves you space and money. Hook it to your 12 VDC power supply and get 6 DC outlets for connecting your accessories. RF bypassing keeps RF out of power supply from DC line outlet. 1 3/2 x 2 3/4 x 2 1/2 in.

Nearest Dealer/Orders: 800-647-1800

**MFJ** MFJ ENTERPRISES, INC.  
Box 494, Miss. State, MS 39762  
(601) 323-5869; FAX: (601) 323-6551  
TELEX: 53 4590 MFJ STKV

• One year unconditional guarantee • 30 day money back guarantee (less s/h) on orders from MFJ • Add \$5.00 each s/h • FREE catalog MFJ . . . making quality affordable

© 1990 MFJ Enterprises, Inc.

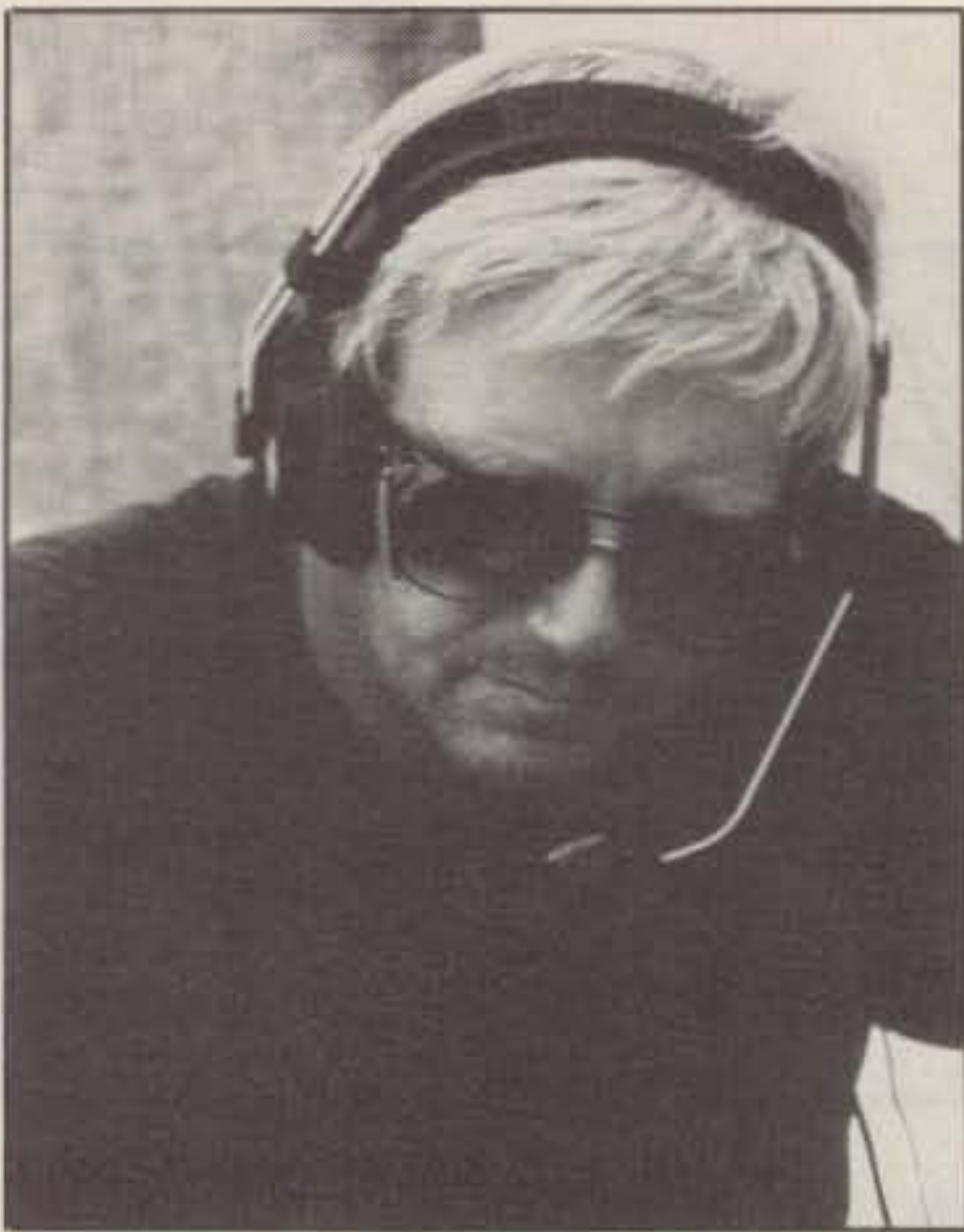

*That beard started two weeks ago when we left KH6 land.*



*"Victory at sea! Now we know how to keep Martti quiet. So Pertti, you're next," says Jim.*

from each site when clawing for European contacts. We get the nod from Mark, our U.S. Fish & Wildlife representative, to proceed with the operation.

The startup blood is boiling. Everyone digs deep inside their soul to find energy to continue. It is late Friday night before we have our first station plugged in as we listen to the 20 meter band on the trap vertical. Our first QSOs are quite historic. We sign our call one time on 14,285. The band explodes. Somehow JA1BK surfaces out of the commotion. Manny, KH6AY, is next, followed by the first mainland U.S. contact, W6KTE, and first European, DJ6OV. Each operator is given a couple of hours operating time so as to provide rest for the others. Our first CW QSO was W6RGG on 7,023 at 0700 UTC followed by KL7H/6, W6GO, and K5UR.

The island is desert-like. Recent rains give

the vegetation a soft light-green hue. We all feel the presence of the millions of birds. Their sounds change as the day progresses. The searing sun beats down quickly. During daylight we are the only creatures still moving about. We must put up the beams at the worst time of the day. By evening we have all five stations running. The campsite comes alive with thousands of visitors. First we stumble on the persistent hermit crabs. These creatures will eat anything laying about. In the morning the trash bags resemble a mini-landfill area after the dumpster has emptied its load. Next we see a gradual buildup of small Miller moths. Within 2 hours of evening, the minor distraction becomes an invasion of thousands of these winged pests. We have to be careful about inhaling while attempting to make contacts. These moths are everywhere and concentrate around the lights. "POW, ZAP! We

have heard that sound before! It's the amplifier. One more moth has met his fate at the hands of the powerful DX machine. We wonder if the station at the other end of our QSO heard the arc over.

Waiting his turn at the radio, Pertti sees a little white mouse. It braves its way into the tent, first peeking its nose in and then making a quick run across the floor. Minutes later, reconnoitering for the rest of his clan, it jumps up on the operating table, snaps up a piece of cracker, and skitters back out of sight. All night long this search and pounce mission gets more and more daring. We take a certain delight in the antics, but are more protective of the supplies.

The first 24 hours result in 6000 QSOs. Our captain comes ashore with more water and advises us we are consuming entirely too much. Our original estimate of 1 gallon per person per day is thrown out the window. He posts the sign: "½ gallon per person per day. Use this marking pen to label your jug."

### Working the Multitude

The team goal is 50,000 QSOs, and individual goals are 1000 QSOs per day. We want to make 10,000 European contacts within the 50K. Communication between the two sites is useless. If the other site is not using a given frequency, then it is available. In this way we focus the primary station of each site on its primary mode, while the secondary station is the swinger. We also find it impossible to make firm operating schedules.

Propagation starts from a low and improves continuously throughout the 8½ days of operating. We experience a mild solar flare on the third day. This impacts the polar path, but JAs and Ws abound, keeping a normal rate. Fifteen meters becomes the primary European band with outstanding conditions from 10 PM local time (0800 UTC) to 7 AM (1700 UTC). Even 10 meters opens up at midnight to Europe.

Pile-up management is made easy with our big signal from four stations. The frustration level is reduced tremendously as the "worthy DXer" has a choice of frequencies to go to for



*"Is that you, Paulo? ... I2UIY, 59 ... thanks!" Martti, OH2BH, logs QSO number 15,972.*

his first QSO. This also cuts the pile-up in segments allowing for 10-15 kHz spread maximum. The Yanmar diesel generators hum beautifully. No spark plugs leads to no man-made noise. We are able to hear the weakest watery-sounding signal while maintaining domination of our frequency, just as Martti and Wayne had predicted. US signals on 10 meters are booming from 1800 to 0400 UTC. JAs show up in the log on almost every page. The operating tables are arranged so that we face each other with rigs side by side. When two bands are hot, it is almost like what happens when two sailboats meet at sea, going in the same direction. Instant contest! At last we are having some real "fun."

On the fourth day we notice the *Makanalani* has gone. The wind has come up to 15 knots and has shifted from northeast to southeast. Huge waves break across the opening in the reef. They are about 4 miles out, fishing for skipjack tuna. The water is so clear the crew is able to see numerous sharks. Swimming and scuba diving are ruled out. The boat slowly paces the shoreline. Each afternoon some of the operators had been taking dips in the water near the landing. However, the crew now unloads a 6 foot reef shark that they caught while patrolling offshore. We are told these sharks are everywhere. It is not advisable to do any swimming.

By the end of the sixth day the big-signal stations have worked us on virtually every available band. However, the pile-ups continue. There is no end to the numbers of stations out there. We work the South Sudan, Bangladesh, and Spratly operations. It appears that "DX-plosion 1990" was a reality. April was the month for DX widows!

## Closing Down, Departure, And Tying Up The Loose Ends

We must weigh anchor no later than noon on Sunday, or we will most certainly be stuck on T32 another week. Site 2 is first to be dismantled. One station is left operational most of the day with a vertical, while beams are broken down for staging on shore. During the night, site 1 slowly gets torn down. Dawn of the 22nd, Pertti, OH2RF, is calling CQ on 20 meter phone. No takers. Have we worked them all? Finally WB6RFI gives us our last contact as Wayne pulls the plug. We clean up each site and depart Jarvis Island in jubilation. Our celebration fades rapidly as the boat is fully loaded with bodies collapsed about the deck. We arrive at T32 just in time. We wave to the crew of *Makanalani* as we depart for Honolulu.

After living together for two weeks in a most uncommon fashion, we hold a delicate bond that must suddenly be broken as we reach Honolulu. The empty feeling is somewhat eased by sharing a few hours together before our various flights spread us around. The glow persists as we each head home to recover from our adventure.

Editing involves identifying each operator's pages, numbering, and sorting. WB2DND sends each of us a disk for data entry. We send it back. He compiles the data, checks it for accuracy, and forwards a complete set of labels to OH2BN. A fresh new team of dedicated DX-ers in Finland is gathered together to assist in the gargantuan task of sorting and assembling the QSLs for mass distribution and direct mail. Final statistics are shown in Table I.

## Post Log

For some, "Let's do it" can mean "Sounds like a good idea. What do you want me to do?" To hear it from Martti, it was, "How many passengers allowed? How much fuel must we carry? How much water?" There was a constant sense of urgency as target dates were hammered out. Each step was clearly worked out as individual roles were adopted. We tried to leave nothing to chance.

Often during slack times Martti and Pertti would banter back and forth in their native tongue, testing each other on what they were hearing from their most familiar European audience, never giving up on the learning aspect of this event. Our dinner gatherings would bring forth all kinds of interesting discoveries on propagation. Through our own experiences and from each other we learned a bit more on how to plan ahead, execute effectively, and analyze the result. A quote from OK3JW sums up our objective: "The 10 meter band was absolutely closed. I heard only noise and AH3C/KH5J."

Granted, Jarvis Island is not as rare a DX location as it was before April. There are many who wished we had operated other modes, such as satellite, or spent more time on other band modes. We believe that sometime in the next decade, a follow-up trip to Jarvis will be warranted.

## Acknowledgements

Special thank you and acknowledgment goes to the following:

Kan, JA1BK, and *Japan CQ Magazine* for financial support and a complete 6 meter station.

The Northern California DX Foundation for financial and technical assistance. In particu-

lar, Rusty, W6OAT, who was always there when things got especially tight.

ICOM, who loaned us seven model IC-735 transceivers which performed flawlessly.

Jarmo Jaakola, OH2BN, and the host of OH friends who are our QSL management team.

Vic, K9UIY, my Johnston Island QSL manager, who patiently fielded question after question from the DX community regarding Jarvis.

Katashi, KH6IJ, and Matsuyo Nose, our Hawaiian logistics friends, without whose help we would not have ever left KH6 land!

Tom, KH6VP, and Richard, AH6IO, who kindly offered their help, warehouse, equipment, antennas, and experience.

Rick, KH7JEB, who ran around Honolulu to find materials for us in between his own DXpeditions to Kure Island.

Rod, NZ7E, who was always available on frequency while we were on Jarvis Island in the event of an emergency.

TG9VT and gang, who loaned us RTTY gear.

Burt, W0RLX, and George, AD1S, Jarvis experts who volunteered vital detailed information about Christmas and Jarvis Islands.

Chod, VP2ML, editor of *The DX Bulletin* and *DX Magazine*, and Bob Winn, W5KNE, editor of *QRZ DX*. Both offered free press to help the DX community, our precious audience, find us on the bands.

Don, WB2DND, who supplied us with software and helped us compile the computer data.

Phil, T32AN, who guided us to Christmas Island and gave us warm support with logistics while on the island.

Larry, NF6S, and Ken, N6SYP. Both were most helpful in kicking off our adventure with logistics support.

Manny, KH6AY, who shared his experiences and documentation about his Jarvis Island stay and his emergency evacuation in 1938.

CQ

## NEMAL ELECTRONICS

- \* Complete Cable Assembly facilities MIL-STD-45208
- \* Commercial Accounts welcome - Quantity pricing \* Same day shipping most orders
- \* Factory authorized distributor for Alpha, Amphenol, Belden, Kings, Times Fiber

Call NEMAL for computer cable, CATV cable, Flat cable, semi-rigid cable, telephone cable, crimping tools, D-sub connectors, heat shrink, cable ties, high voltage connectors.

### HARDLINE 50 OHM

FXA12 1/2" Aluminum Black Jacket.....	.89/ft
FLC12 1/2" Cablewave corr. copper blk jkt.....	1.69/ft
FLC78 7/8" Cablewave corr. copper blk jkt.....	4.35/ft
NM12CC N conn 1/2" corr. copper m/f.....	25.00
NM78CC N conn 7/8" corr. copper m/f.....	54.00

### COAXIAL CABLES (per ft)

1180 BELDEN 9913 very low loss.....	.55
1102 RG8/U 95% shield low loss foam 11ga.....	.36
1110 RG8X 95% shield (mini 8).....	.19
1130 RG213/U 95% shield mil spec NCV jkt.....	.39
1140 RG214/U dbl silver shld mil spec.....	1.85
1705 RG142B/U dbl silver shld, teflon ins.....	1.50
1310 RG217/U 50 ohm 5000 watt dbl shld.....	1.05
1450 RG174/U 50 ohm .100" od mil spec.....	.14

### ROTOR CABLE-8 CONDUCTOR

8C1822 2-18ga and 6-22ga.....	.24/ft
8C1620 2-16ga and 6-20ga.....	.39/ft

### CONNECTORS-MADE IN USA

NE720 Type N plug for Belden 9913.....	\$3.95
NE723 Type N jack for Belden 9913.....	4.95
PL259AM Amphenol PL259.....	.89
PL259TS PL259 teflon ins/silver plated.....	1.59
PL258AM Amphenol female-female (barrel).....	1.65
UG175/UG176 reducer for RG58/59 (specify).....	.22
UG21DS N plug for RG8,213,214 Silver.....	3.35
UG83B N jack to PL259 adapter, teflon.....	6.50
UG146A SO239 to N plug adapter, teflon.....	6.50
UG255 SO239 to BNC plug adapter, Amphenol.....	3.75
UG255TS SO239 to BNC Teflon Silver.....	5.95
SO239AM UHF chassis mt receptacle, Amphenol.....	.89
UG175S/UG176S reducer (silver) specify.....	.45
UG88C BNC plug RG58,223,142.....	1.45

### GROUND STRAP-GROUND WIRE

GS38 3/8" tinned copper braid.....	.35/ft
GS12 1/2" tinned copper braid.....	.50/ft
HW06 6ga insulated stranded wire.....	.35/ft

\* Prices do not include shipping. Visa/Mastercard \$30 min., COD add \$3 (min. ship. charge \$3)  
Call or write for complete price list. NEMAL's new 40 page CABLE AND CONNECTOR SELECTION GUIDE is available at no charge with orders of \$50 or more, or at a cost of \$4 with credit against next qualifying order.

NEMAL ELECTRONICS, INC., 12240 NE 14th Ave. N., Miami, FL 33161  
(305) 893-3924 Telex 6975377 24 hr. FAX (305) 895-8178

Please send all reader inquiries directly.

# CQ SHOWCASE

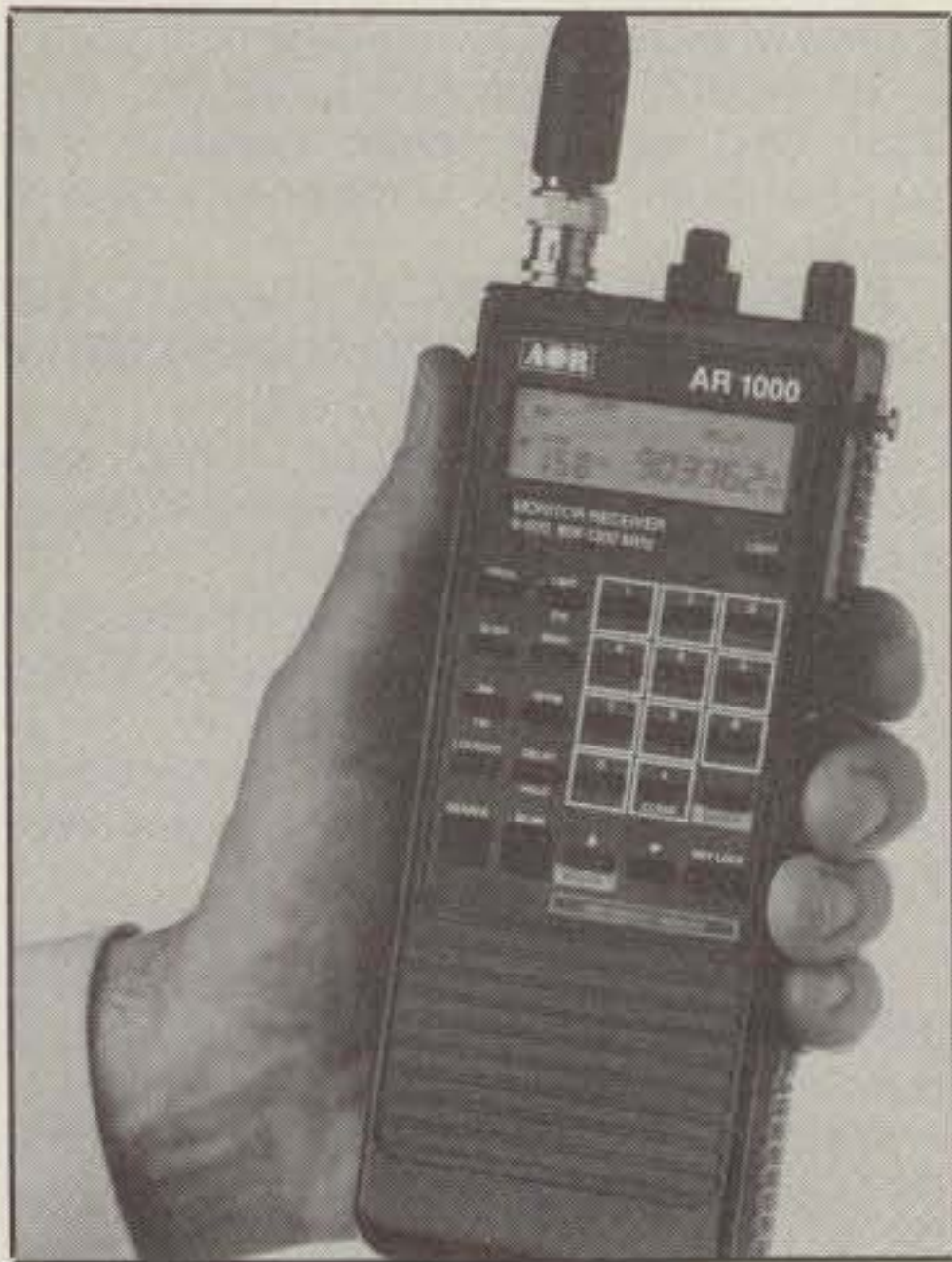

## ACE Communications Hand-Held Receiver

ACE's 1000-channel hand-held receiver has continuous frequency coverage from 8 MHz to 600 MHz and 805 to 1300 MHz, allowing reception of civil and military aviation bands plus all public-service bands. AM or narrow FM reception modes in addition to FM broadcast and TV

audio modes are selectable at any frequency. The unit is compact and weighs 12 ounces. Twenty-six front-panel keys allow programming of 1000 total scan memory channels. Extra features include selectable single channel priority, keyboard lockout, BNC antenna connector, and a display backlight for night use.

The \$499 price of the unit includes 120 to 12 volt wall plug adapter/charger, DC cigarette lighter plug charger cord, flexible antenna, carrying case, and AA rechargeable batteries. For more information, contact ACE Communications, Monitor Division, 10707 East 106th St., Indianapolis, IN 46256, or circle number 102 on the reader service card.



## MFJ-817 144/440 MHz SWR/Wattmeter

The MFJ-817 is a peak and average reading 144/440 MHz cross-needle SWR/wattmeter which shows forward power, reflected power, and SWR at a single glance. There are two

power scales—200 or 20 watts forward and 5 or 50 watts reflected. Meter lamp and a large two-color meter simplify across-the-room reading. The black aluminum cabinet measures 7 1/4" x 4 1/2" x 3 1/2". Meter lamp uses 12 VDC or 110 VAC with the MFJ-1312 AC adapter (\$12.95).

The MFJ-817 sells for \$79.95 and carries MFJ's one-year unconditional guarantee. For more information, contact MFJ Enterprises, Inc., P.O. Box 494, Mississippi State, MS 39762, or circle number 101 on the reader service card.



## Kantronics Telemetry Unit With Weathernode EPROM

The Kantronics Telemetry Unit (KTU) is a piece of terminal equipment that interfaces with any packet TNC and with optional sensors, providing temperature, wind speed, and



## 31st ANNUAL TROPICAL HAMBOREE AMATEUR RADIO & COMPUTER SHOW ARRL SOUTHEASTERN DIVISION CONVENTION FEBRUARY 2-3, 1991



DADE COUNTY YOUTH FAIR & EXPOSITION FAIRGROUNDS

- 200+ EXHIBIT BOOTHS • 1,000 INDOOR SWAP TABLES • 300 CAMPSITES WITH HOOK-UPS
- FREE PARKING 15,000 VEHICLES • EXAMS FOR AMATEUR LICENSES • WOUFF HONG INITIATION
- SPECIAL CONVENTION PROGRAMS & ACTIVITIES FOR EVERYONE

### FRIDAY SPECIAL!!!

## EDUCATIONAL C.E.U. WORKSHOP FOR PROFESSIONAL & VOLUNTEER INSTRUCTORS

CONDUCTED BY THE ARRL EDUCATIONAL ACTIVITIES DEPARTMENT

Registration: \$5.00 Advance — \$6.00 Door • Valid Both Days (Advance deadline Jan. 22)

Swap Tables: \$20.00 each + Registration • Power: \$10.00 per User.

Campsites: 3 Days (Fri., Sat., Sun.) \$40.00 • 4 Days (Thurs., Fri., Sat., Sun.) \$55.00

Headquarters Hotel: Miami Airport Marriott — \$65.00 Single, Double

Call: (305) 649-5000 — Speak Only to Reservation Department

**Must** Mention "Tropical Hamboree" to Get Special Rate. Deadline Jan. 19, 1991.

After Deadline, Special Rates on Room Available Basis Only

**WRITE TODAY  
FOR DETAILED BROCHURE  
& RESERVATION FORMS**

Send to: Chairman, Evelyn Gauzens, W4WYR  
2780 N.W. 3rd Street, Miami, FL 33125  
Tel.: (305) 642-4139 • Fax: (305) 642-1648

# COMPUTERIZE YOUR SHACK

Control up to eight digital radios simultaneously from your MS-DOS microcomputer! We offer a series of software/hardware packages that interface with most current synthesized rigs.

**ICOM:** IC-781, 765, 761, 751A, 735, 725, 726, 745 R71A, R7000, R9000, 271, 471, 1271, 275, 375 475, 575, CI-V

**KENWOOD:** TS-940, 440, 140, R-5000, 680, 711, 811

**YAESU:** FT-767, 757 GXII, 757 GX, 747, 9600, 736 212, 712

**JRC:** NRD 525

**COLLINS:** 651 S1

Knowledge of MS-DOS is not necessary - the installation program does it all! Datacom allows complete control of your rig from the keyboard. Move your cursor to the desired frequency and the radio will be set automatically.

### A few of its many features:

- Adds sweep and scan to radios that don't allow this from front panel.
- Adds unlimited memories. Stores frequency, description call sign, sked time, and comments for each frequency, limited only by disk storage.
- Allows radio to be tuned from keyboard by use of arrow keys.
- Tabular screen display of all of the channels stored in memory, along with a full description of each including: MODE (LSB, USB, FM, etc.), eight character alphanumeric description, call sign, sked time, comments. Data files may be sorted by frequency, description, call sign, time, etc.
- Now with mouse control
- Built-in latitude/longitude calculator with database
- Pre-Program multiple schedules—sets frequency and mode at a given time and date.

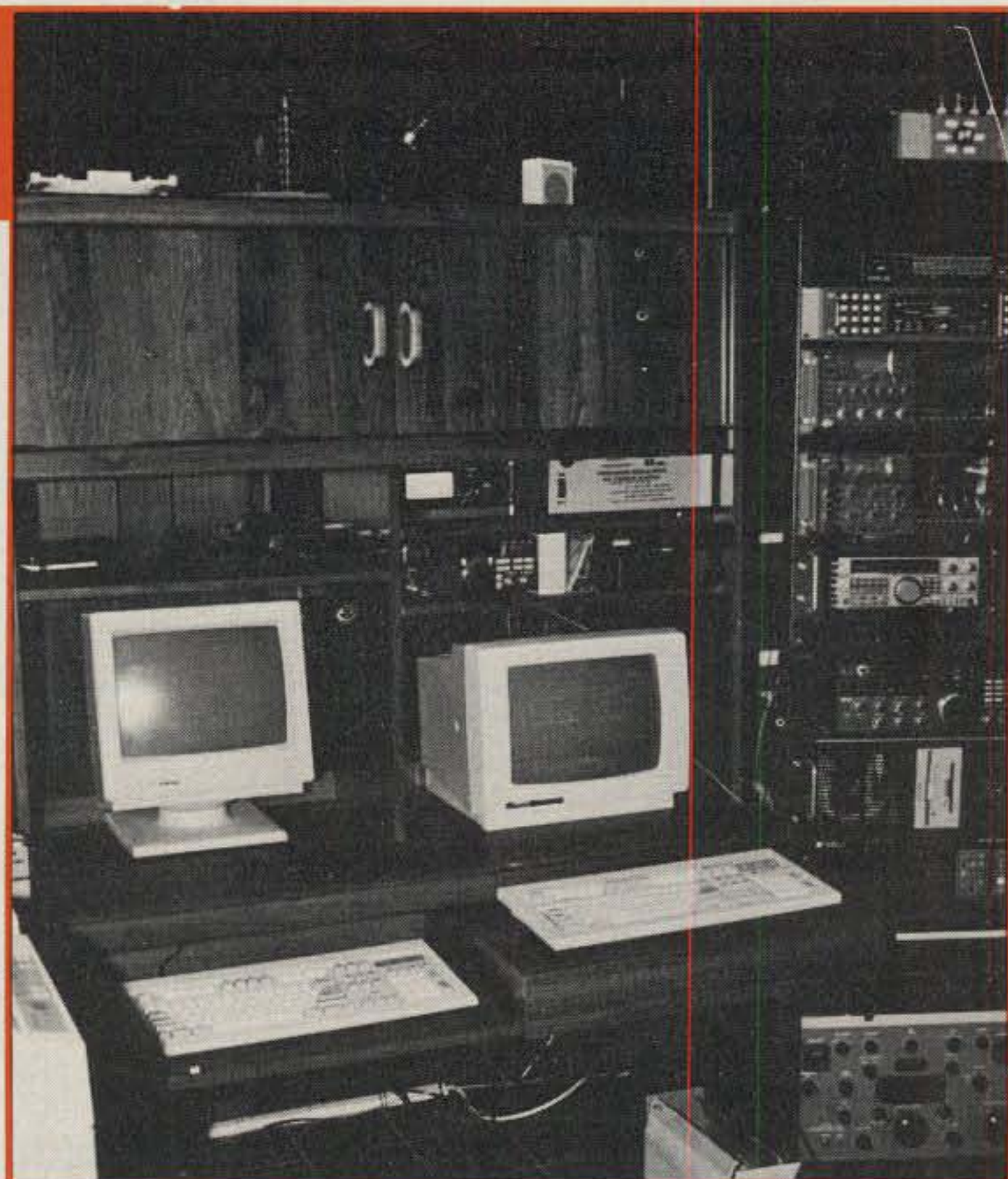

- Full featured logging utility allows searching for previous entries by call sign. Separate log for each service.
- Able to automatically log hits while sweeping or scanning.
- Color coded program for easy use (will run on a monochrome system).
- Menus for amateur, AM-FM broadcast, television broadcast, S/W, aviation, marine, FAX, satellite with most popular frequencies stored. Menu maker utility allows custom menus defined by user.
- 50 page comprehensive user manual.
- Optional radio direction finder allows bearing information to be logged automatically.

*Call or Write today for more information.*

**AVAILABLE FOR IBM PC,XT,AT, 80386 256K RAM 1 SERIAL PORT AND 1 FLOPPY MINIMUM**

- PROGRAM WITH INITIAL LIBRARIES.....129.95
- RS-232 TO TTL INTERFACE (NEEDED IF DON'T HAVE MFRS INTERFACE)
- EXT. INTERFACE ALLOWS 4 RADIOS (WITH SQUELCH DETECT)129.95
- INTERNAL PC INTERFACE W/1 SERIAL & 1 RADIO PORT.....129.95
- may be addressed as com1, com2, com3, com4 includes cables to radio
- SPECTRUM ANALYZER MODULE.....(CALL FOR PRICE)
- DIAGNOSTIC PROGRAM.....25.00
- COMSET ALLOWS OPERATION ON COM3 AND COM4.....25.00
- PROG. FOR UNIVERSAL M-7000, AEA PK232, KANTRONICS KAM
- DIGITAL VOICE RECORDER OPTION!
- ICOM UX-14 INTERFACES IN STOCK
- COMPLETE SYSTEMS (RADIOS, INTERFACE, & COMPUTERS). (CALL)
- NEW! TSR COMMANDER, SETS FREQUENCY, MODE, ETC. POP-UPS
- OVER ANY OTHER APPLICATION.....\$50.00
- 30 MINUTE VIDEO TAPE GUIDE TO SETUP AND OPERATION....19.95

CURRENT MENU		..... MAIN MENU .....		VERSION 9.1	
MEM 394 K	STACK 1 K			LOCAL :	16:54:00
DATE: 10-24-1989		SELECT FUNCTION	MODE= USB	U.T.C.:	20:54:00
1. READ MEMORY CHANNELS		7. MEMORY CHANNEL	DIAL		
2. INPUT DESIRED FREQUENCY		8. WRITE MEMORY TO VFO	VFO A		
3. 500 KHZ. UP		9. UTILITY MENU			
4. 500 KHZ DOWN		ALT-P. CHANGE MENU PAGE			
5. ACTIVATE/DEACTIVATE CLARIFIER		ALT-Z. DISPLAY OR PRINT LOG			
6. SWEEP BETWEEN 2 LIMITS		ALT-Q. END			
A. AVIATION (VHF) COMMUNICATION		D. F.M. BROADCASTING			
B. TELEVISION BROADCASTING		E. AMATEUR FREQUENCIES (VHF)			
C. COASTAL MARINE FREQUENCIES		F. MISCELLANEOUS FREQUENCIES (VHF)			
PORT= COM2	BAUD= 9600	CURRENT PARAMETERS		RDLY= 0.138	
UPPER - BAND LIMIT - LOWER	FREQUENCY	MODE	FILTER	SQ. ACTIV.	ADDR
30.000 MHZ	0.100 MHZ	17.44300 MHZ	USB	WIDE	38

- icom 781 MF/HP TRANSCEIVER -  
F1 781 F2 R9000 F3 R9000 F4 R9000 F5XCH A/BF6 VFOA F7 VFOB

**UPDATE ANY PREVIOUS DATACOM TO NEW DATACOM V For \$50.**

**Order direct or from Universal Radio 800-431-3939, Gilfer Shortwave 800-GILFER-1**

## CALL FOR COMPETITIVE ICOM PRICING



IC-R9000



IC-R7000



IC-R71



**IC-R72**

And All Your Other ICOM Favorites



Authorized Dealer  
JST-135 Transceiver  
NRD-525 General Coverage Receiver

**DATACOM, INT.**

7678 Venetian St., Miramar, FL 33023

Orders: (800) 780-9505 • Info: (305) 987-9505

# RFI KIT

Use ferrite beads to keep RF out of your TV, stereo, telephone, etc. Kit includes one dozen beads, one dozen toroids 1/2" to 1 1/4" diameter, three "split beads" and our helpful RFI tip sheet. Everything needed to fix most RFI problems. \$15 + \$4 S&H U.S. and Canada. 7 1/4% tax in CA.

Free catalog and RFI tip sheet on request.

## PALOMAR ENGINEERS

Box 455, Escondido, CA 92033  
Phone: (619) 747-3343

# DELTA LOOP ANTENNAS

- "Open and Close the Band" with our Delta design, full wave DX performance mono-band, duoband and tri-band antennas
- High Quality construction using 6061-T6 Aluminum and Stainless Steel hardware
- Heavy duty design • "Quiet" DX reception
- Excellent Gain, FB Ratio and SWR
- 50 ohm gamma feed • 2 kw PEP power

DELTA LOOP ANTENNAS, INC.  
12 BRUSH DR., P.O. BOX 8063  
NEW FAIRFIELD, CT 06812  
(203) 746-6368

wind direction to node users. The KTU with Weathernode EPROM includes a microcomputer-based data acquisition system, RS-232 interface, TNC interface, sensors interface configured for up to seven analog inputs, two temperature sensors, and comes equipped with an EPROM and RAM supporting the temperature sensors, a packet interface, PC interface, and optional anemometer inputs.

The KTU with Weathernode EPROM combined with the optional anemometer is a plug-and-go weather source for amateurs in a packet local-area network. For more information, contact Kantronics Inc., 1202 E. 23rd Street, Lawrence, KS 66046, or circle number 106 on the reader service card.

## Yaesu 1.2 GHz Radios

Yaesu has recently introduced two new 1.2 GHz radios to its line. The FT-911 handheld is a lightweight and compact 1 watt radio with basic features the same as the other handheld radios in the FT-411/811 series: 49 memories, 2 independent VFOs, built-in CTCSS and DTMF, automatic power off, programmable channel

# COLORADO COMM CENTER

**800-227-7373**

M/C, VISA, DISCOVER, COD

Same Day Shipping Nationwide

### YAESU



**FT-212RH**  
45 WATT 2 METER MOBILE  
• 18 Memories  
• Receive 140-174 MHz

### KENWOOD



**TS-440S**  
COMPACT HF PERFORMANCE  
• General Coverage Receiver  
• Covers All Amateur Bands  
• USB, LSB, CW, AM, FM, AFSK

### ICOM IC-725



**HF ALL BAND TRANSCEIVER**  
• Compact and Lightweight  
• Receive .03 to 30 MHz  
• Transmit 180-10 Meters  
• SSB, CW, AM, Optional FM  
• 100 Watts Output

### YAESU

**FT-470**  
DUAL BAND  
• 2 Meter/70cm  
• Multi Scanning  
• 2.3 to 5 Watt Output



**FT-411**  
"MAXI" 2 METER HT  
• 49 Memories  
• Built-in PL Encode/Decode  
• Up To 5 Watt Output



### KENWOOD



**TM-731A**  
144/450 FM DUAL BANDER  
• Extended Receive Range  
• 30 Memory Channels  
• 50 Watts/2M, 35 Watts/70cm  
• TM-631A, 2 Meter/220 MHz

### ICOM

**IC-24AT**  
2 METER/440 MHZ HT  
• Super Compact and Lightweight  
• Crossband Full Duplex  
• Up To 5 Watts Output



**IC-2SAT**  
COMPACT  
2 METER FM, HT  
• 48 Memories  
• Built-In NiCd Batteries  
• Multi Scan Functions



### AEA PK-232 MBX

WORLD'S LEADING MULTI-MODE DATA CONTROLLER

PK-88 FEATURE LOADED PACKET CONTROLLER

### MFJ

ANTENNA TUNERS & ACCESSORIES



MFJ 1270B, 1274, 1278

### KENWOOD

**TH-27A**  
SUPER COMPACT 2 METER HT  
• Receive 118-165 MHz  
• Up to 5 Watts Output  
• CTCSS Encode/Decode Built-in  
• Multi Function Scanning



### ALINCO



**DR-112T**  
2 METER MOBILE  
• 45 Watts Output  
• Full Feature, User Friendly  
• Backlit LCD Display

525 E. 70th Unit 1W • Denver, CO 80229  
303-288-7373 Mon. - Fri. 9-5 MT Sat. 9-2



steps, 10 memory auto-dialer, and more. Vinyl case, 117 VAC wall charger, belt clip, and battery are included. Price: \$505.

The FT-912RH is the mobile 1.2 GHz version that has been added to the FT-212/712 series. It delivers 10 watts of power output and has the same basic features as other mobiles in the



series: 18 general-purpose memories, one-touch call channel memory, two scanning range memories, and more. Price: \$581. For additional information, contact Yaesu USA, 17210 Edwards Rd. Cerritos, CA 90701, or circle number 105 on the reader service card.

# TUCKER SURPLUS STORE

1717 RESERVE ST.  
GARLAND, TX 75042

ALL UNITS GUARANTEED OPERATIONAL WITH MANUAL  
ORDER WHILE SUPPLIES LAST!

## FM DEVIATION METER

A must for checking your FM transmitter's modulation circuit!

- FREQUENCY RANGE 4 MHz TO 1024 MHz
- FULL SCALE DEVIATION RANGES OF 5, 25, 75, AND 125 kHz



- DEVIATION FREQUENCIES FROM 50 Hz TO 125 kHz
- 50 OHM INPUT IMPEDANCE

Both negative and positive deviation can be measured without retuning.  
Marconi TF-791D  
Deviation Meter . . . . . \$ 175.00

## HIGH FREQUENCY OSCILLOSCOPE PROBE

A switchable X1, X10 rugged probe. Bandwidth on X1 is 15 MHz and on X10 is 200 MHz. Includes sprung hook, 6" ground lead, spare tip, IC test tip, tip insulator, trimmer tool, and storage pouch.

Probemaster 4101 . . . . . \$24.95



## COAX SWITCHES

Highest commercial quality! Made by Transco and TRW. Type "N" connectors, 28 VDC. Handle maximum legal power into VHF range, good to 12.4 GHz at reduced power. Use for remote antenna switching, amplifier switching, other applications.

Type C4N4AB SP4T . . . . . \$ 85.00

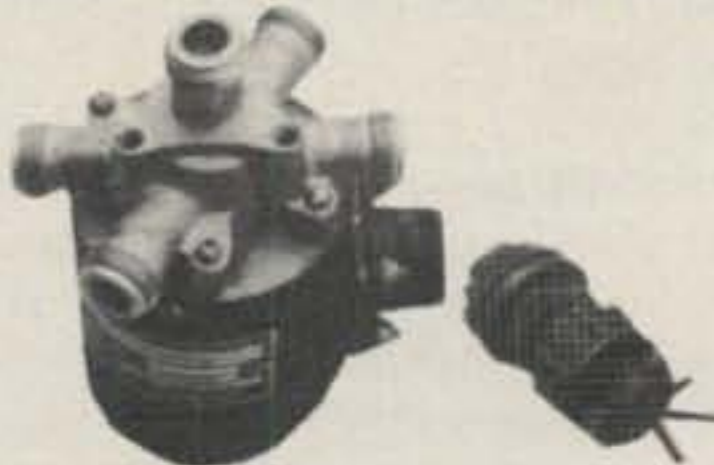

- 805C00100 SPDT Latching . . . \$ 75.00
- 310C00100 Transfer Latching \$ 89.00
- 15100-T101 SPDT . . . . . \$ 59.00
- 810C00100-30 SPDT Failsafe \$ 85.00

Other Types Available, Please Inquire!

## STEREO WATT-METER/VOLTMETER

- WATTMETER RANGE 10 nW TO 140 W IN 9 RANGES
- VOLTMETER RANGE 300  $\mu$ V TO 37 V IN 9 RANGES
- FREQUENCY RANGE FROM 4 Hz TO 500 kHz

This versatile instrument also has a measuring amplifier that has a calibrated gain from -30 dB to +50 dB. Another feature is a monitoring amplifier with built in speaker. You can select 2, 4, 8, and 16 ohms input impedance for power measurement. Voltmeter has a 1 megohm input impedance. Bang and Olufsen

AM-1 Audio Monitor . . . . . \$ 195.00



Thousands of Operator and Service Manuals For Sale. Call Us with Instrument Model Number.

## SSB50 SPECTRUM ANALYZER SYSTEM

This solid state unit is ideal for checking the performance of amateur or commercial radios. The system consists of an MF50 mainframe, a CA5 analyzer signal indicator, a TTG3 two-tone generator, and an RF8 tuning head. The standard range is 20 MHz to 40MHz but is usable to 200 MHz at reduced sensitivity. Two-tone generation is from 20 Hz to 20 kHz.

Singer SSB-50 . . . . . \$ 795.00  
SSB50'S MANY USES

- SIGNAL ANALYSIS FOR SET-UP, OPERATION AND MAINTENANCE OF SSB, AM, FM, AND MULTIPLEXED COMMUNICATIONS EQUIPMENT
- MEASURES TRANSMITTER LINEARITY BY TWO-TONE INTERMODULATION DISTORTION TEST
- ANALYZE SIDEBAND HUM
- CALIBRATE FM SIGNAL GENERATORS

## AM/FM SIGNAL GENERATOR/UNIVERTER HP 202H/207H



This combination gives you a frequency coverage from 100 kHz to 216 MHz. Provides AM, FM, CW, and pulse outputs. Output is 0.1  $\mu$ V to 0.2 V into 50  $\Omega$ . FM deviation to 250 kHz.

HP 202H AM/FM Signal Generator & HP 207H Univerter  
Both . . . . . \$ 375.00

## MILITARY EQUIPMENT TRANSIT/STORAGE CASES

Ideal for enclosing antenna networks, phasing lines, relays, and related outdoor assemblies. Also excellent for use as a tool or storage box or ?? Features weather-resistant construction. Metal covered wood designed to military specifications. Used, but good condition. Size: 18 1/2" (H) X 14 3/4" (W) X 25 1/2" (L), Wt. 34 lbs. UPS shippable.



Price . . . . . \$18.00

Other sizes also available. Please call with your needs.

## URM-127 OSCILLATOR

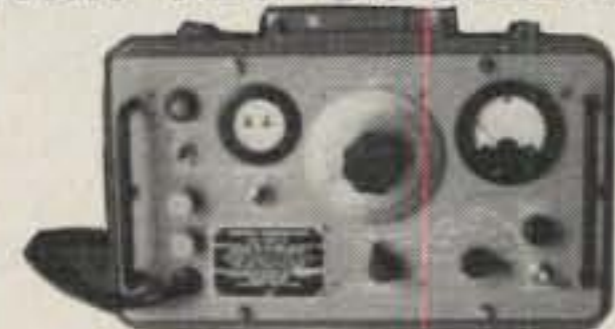

- 20 Hz - 200 kHz FREQ. RANGE
- 10  $\mu$ V - 10 V OUT
- < 1% DISTORTION

This lovely little audio oscillator will be a welcome addition to any lab. A convenient output meter allows you to set the voltage to the amount you want out. The easy-to-read frequency dial lets you set your frequency within  $\pm$ 2%. It comes in its own ruggedized carrying case.

ONLY . . . . . \$ 119.00

Used Ham Equipment, Antennas, and Accessories, Test Equipment, Power Supplies, Computer Surplus Parts, Wire and Cable, Unique Electronic Assemblies and Gadgets.

ALL EQUIPMENT F.O.B. GARLAND, TX - VISA & MASTERCARD OK - NO C.O.D.s

HOURS:  
T, W, Th, F Noon-6PM  
Sat. 8:30 AM-1 PM

Call for a copy of Tucker's  
Equipment/Manual Listing!

\*Ask for Hazen Smith  
in Dallas (214) 340-0631  
TX WATTS 1-800-749-4642 ex 135  
WATTS 1-800-527-4642 ex 135

# CQ REVIEWS:

## The Astron RS-50M and RM-50M Power Supplies

BY PETER J. BERTINI\*, K1ZJH

Our club's repeater sites are often inaccessible for months, thanks to our New England winters! We chose Astron power supplies to fill the need for reliable power sources for our repeaters. Three Astron RS-50M supplies and one RM-50M supply have been in continuous service for several years at different mountain-top locations.

This review centers on Astron's higher current supplies, those with a 20 amp or greater rating. A 100 watt mobile HF transceiver in your shack needs upwards of 20 amps during transmit, and if you also have a VHF packet station, VHF transceivers, VHF power amplifiers, etc., the advantage of having a hefty 12 VDC power source in the shack is obvious!

### The Product Line

Astron offers many different models and styles of supplies, from 3 amps to 50 amps. The prefix number designates the style—RS models are tabletop units, RM models are rack mounts, and the VS and VRM prefixes indicate tabletop or rack supplies with adjustable current-limiting and voltage controls. The number gives the ICS rating. For example, the RS-50M supply will deliver 50 amps with a 50% duty cycle, 5 minutes full load, 5 minutes idle. Supplies with current and voltage metering have an "M" suffix.

Options such as rack mounting, metering, and adjustable voltage and current limiting are available only in the 12 amp and higher models. At the specified 13.8 VDC output the 50 amp models can deliver 37 amps continuously. You may set the output voltage lower, but this increases the voltage drop across the pass regulators and reduces the current rating accordingly. Setting a 50 amp supply to 10 VDC output reduces the continuous rating to 22 amps; at 5 VDC only 10 amps is available.

The supplies will hold output regulation to plus or minus 0.05 volts deviation, with less than 5 mV ripple, from no load to full load.

\*20 Patsun Rd., Somers, CT 06071

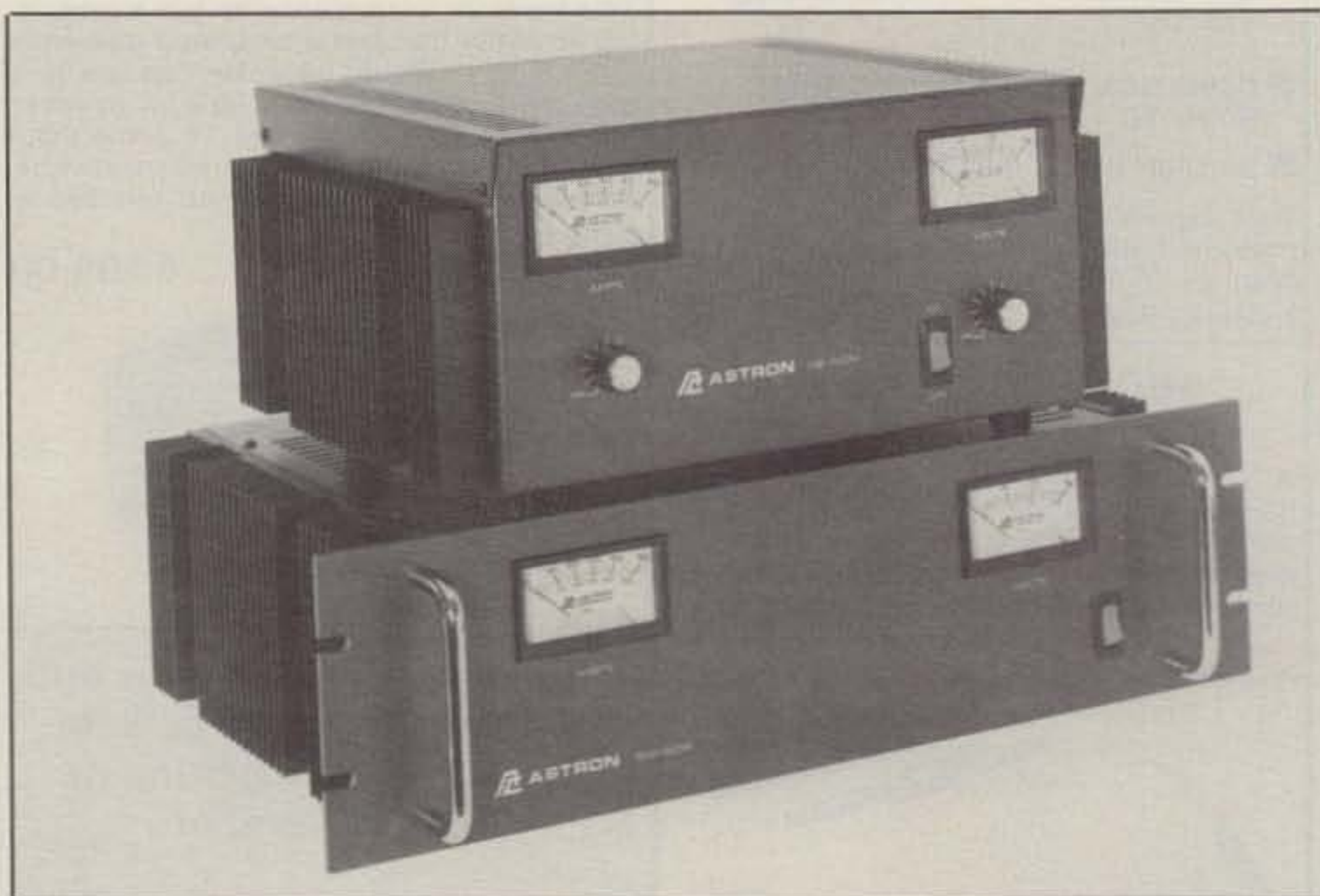

One of Astron's tabletop power supplies sitting on a rack-mountable power supply.

### Construction

The power supplies are housed in rugged steel cases. They are heavy; both 50 amp models weigh close to 50 pounds. It took two of us to install the rack-mount model! Most of the weight is the power transformer. The transformers run cool with no load; Astron didn't skimp on core material quality. The heatsinks are also hefty and do their job well. The rack-mounted supplies are electrically identical to their tabletop cousins, except a different style case is used.

These are linear supplies. Switching-type supplies offer better efficiency, lighter construction, and smaller size—but few amateurs are willing to try repairing one. The heart of the power supply is the LM723 voltage regulator IC, and provides the voltage regulation and current sensing functions. 2N3771 pass regulators are used; eight of them handle the 50 amp models. Almost all of the parts are generic and available from larger supply houses. Over-voltage protection is provided by an SCR crowbar circuit. If crow-

barred or presented with a short-circuit load, the current folds back to a very low value. We ran two supplies for several days with shorted outputs with no ill effects. Available are 220 VAC models. The standard models are rated for 105 to 125 line voltages.

Besides my experiences with the 50 amp models, several of my friends are using 20 and 35 amp Astron supplies and have had no problems. Our RM-50M arrived with a meter damaged in shipment. Astron quickly responded with a replacement meter. One of the RS-50M supplies had the annoying tendency to crowbar from line glitches during lightning storms. The factory was called and a capacitor value change was suggested that cured the problem. The supplies are fairly immune to RF, but strong RF fields, especially VHF, can cause erratic operation. Don't put your mag-mount antenna on the power supply!

The Astron RS-50M is priced at \$314.95 and the RM-50M is \$354.95 amateur net. They are manufactured by Astron Corp., 9 Autry Lane, Irvine, CA 92718.







**IC-765**  
Official Radio Of The World  
Radiosport Team Championships



**IC-575A/H**  
6 and 10 Meter Performance  
With Either 10 or 100 Watts

# ICOM



**IC-2400A**  
DualBand FM With 45 Watts on 2 Meters  
and 35 Watts on 440 MHz

**IC-901**  
Dual Band FM With Remote Controller  
and Up to 6-Band Capability



**IC-2SAT**  
Mini 2 Meter Handheld With  
Built-in NiCd Batteries and Keyboard

**IC-24AT**  
Super Compact, 2 Meter/70 cm  
Dual Band With 40 Memories

Large Inventory of Everything ICOM—HF, VHF, UHF and Plenty of Accessories. When You Need Service, DOC's is Famous for Fast and Thorough Repairs. Call Today!

## DOC's Communication

702 Chickamauga Ave.  
Rossville, GA 30741

404-866-2302

404-861-5610

FAX 404-866-6113



**Traxit** **CENTRO DE VENTAS**  
**AUTORIZADO**  
**YAESU**  
LIDER MUNDIAL EN  
RADIOCOMUNICACION  
HF VHF UHF

DISTRIBUIDORES AUTORIZADOS DE:  
**Yaesu • Astron • Cushcraft**  
**Connect Systems • Larsen**  
**MAYOREO Y MENUDEO**  
Embarcamos a cualquier lugar del mundo

INDUSTRIAL, COMERCIAL, PRIVADO,  
RADIOAFICION GARANTIA DE FABRICA!

Traxit, Inc.  
707 West Pecan Blvd. • McAllen, TX 78501  
Tels: (512) 682-6559/682-0844  
FAX: (512) 682-1658

EN MEXICO  
Av. del Bosque 6144-A  
Col. Bugambillas • Puebla, Pue., Mexico  
Tels: (22)445193/459180/459201  
FAX: (22)445691

CIRCLE 143 ON READER SERVICE CARD

## AMATEUR TELEVISION

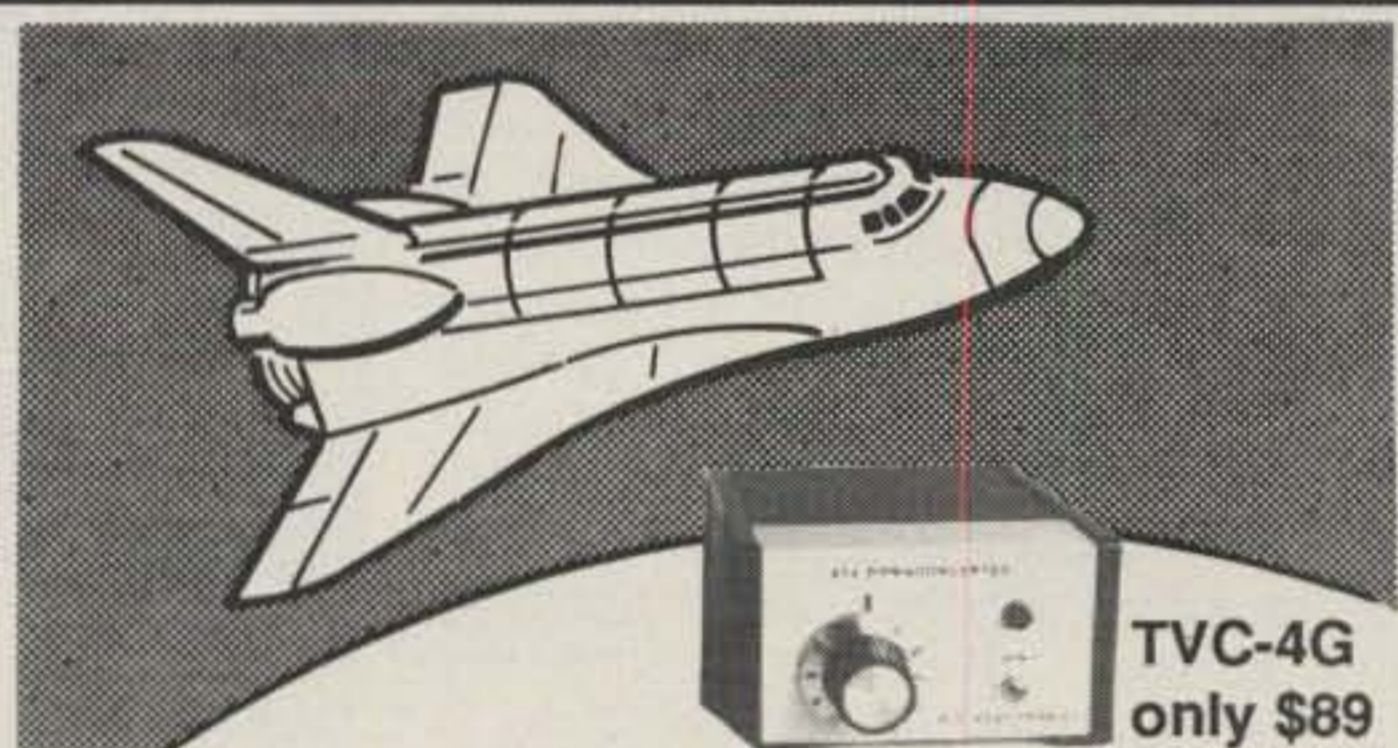

**TVC-4G**  
only \$89

### SEE THE SPACE SHUTTLE VIDEO

Many ATV repeaters and individuals are retransmitting Space Shuttle Video & Audio from their TVRO's tuned to Satcom F2-R transponder 13. If it is being done in your area on 70 CM, all you need is one of our TVC-4G ATV 420-450 MHz downconverters, add any TV set to ch 3 and 70 CM antenna. Others may be retransmitting weather radar during significant storms. Once you get bitten by the ATV bug - and you will after seeing your first picture - show your shack with the TX70-1A companion ATV transmitter for only \$279. It enables you to send back video from your camcorder, VCR or TV camera. ATV repeaters are springing up all over - check page 411 in the 90-91 ARRL Repeater Directory. Call for a copy of our complete 70, 33 & 23 CM ATV catalog.

(818) 447-4565 m-f 8am-5:30pm pst.

**P.C. ELECTRONICS**  
2522 S. Paxson Ln Arcadia CA 91007

Visa, MC, COD  
Tom (W6ORG)  
Maryann (WB6YSS)

CIRCLE 110 ON READER SERVICE CARD

# CQ REVIEWS:

## The Sierra Technologies 80386SX Computer System

### Computer Considerations For The Cost Comparison Shopper!

BY BUCK ROGERS\*, K4ABT

**C**omputers have become the wave of the present and future. No longer is the computer reserved just for the work place. It has taken its place in our everyday living environment in many ways, and the number of uses are increasing in quantum leaps.

The increase in the number of households that support at least one PC is accelerating faster than did the growth of the "one TV per household" statistic some years back. The use of computers in schools and classrooms has also increased dramatically. The decade of the eighties inspired educators to give computers a second look, as many teachers were less computer literate than some of their students. In many parts of the country this statement continues to hold true.

There are classrooms which provide computerized audio/visual teaching aids. The educator who has teaching skills built around computer literacy is here for the long-haul. This kind of teaching and learning supports the reasons why our children often use the computer in the home.

From their early years our youngsters become involved in an interactive participation with the computer. It is no wonder then that our educational process is moving toward this means of gaining the attention of the student. The groundwork for this kind of teaching and learning aid began when the student was playing "Pak-Games."

The student discovers all too soon how the computer can be used to perform homework at a faster pace and with greater precision. The student may compose text or develop a database for future homework assignments.

\*506 Pheasant Ridge Drive, Warner Robins, GA 31088



*Note the sleek design of the compact column cabinet. It has all ON/OFF, RESET, and TURBO controls within easy reach of the user. Drive indicators and drive access doors are also up front. No more looking and searching for the correct button to push. Additional security is provided in the form of a "key-lock" adjacent to the POWER switch.*

The presence of the computer in the home also allows the parent to explore its many uses. In addition, the parent may soon discover how the computer can be used as a tool to keep track of the family income. The parent quickly learns how easy it is to use the computer, because the software that is being developed now uses a "common sense" approach. We can take a few minutes each week to sit at the home PC and balance the budget, update our bank books, and record tax information. These are just a few of the uses of the personal computer.

Because of this onslaught of data processing, computer-based working, and

living environments, educators have discovered a totally new curriculum. Schools and colleges are teaching the use of the PC in the classroom.

No sooner had schools of higher learning discovered the need for computer instruction courses, then they learned they had an added requirement. Software programs for the personal computer had risen to a seemingly complex level. This brought on a new application for both business and industry. Schools had to add specialized courses to teach database, spread-sheet, Computer Aided Design (CAD), and Computer Aided Manufacturer (CAM) courses.



# rf enterprises

Call us for all your amateur needs.  
We ship worldwide. We service amateur equipment.

## YAESU



FT-1000D

FT-767GX; FT-757 GX-II; FT-747GX; FT-736R;  
Handhelds for 2M, 220, & 440MHz; Mobile rigs;  
Dualbanders; and other Yaesu equipment &  
accessories. Call!

## ICOM



IC-735

160-10M, General Coverage Receive, Dual VFO  
& 12 Memory Channels, QSK, Compact.

### ICOM SPECIALS!

ICOM 2 Meter Mobile FM Transceivers  
CALL US!

## TEN-TEC



OMNI V

### OTHER TEN-TEC PRODUCTS:

Model 561 Corsair II HF Transceiver  
Model 585 Paragon  
Model 425 Titan Linear Amplifier  
Model 420 Hercules Solid State HF Amplifier  
Model 238 Antenna Tuner

## ANTENNAS & TOWERS

### CUSHCRAFT

A3S Tribander  
A4S Tribander  
A3WS 18 and 24 MHz Beam  
R5 (10,12,15,17,20) **SPECIAL!!**  
AP8 (80 - 10 Vertical)  
A50-5 5-el 6M. beam  
617-6B 6 Mtr "Boomer"  
ARX-2B, ARX-450B & AR-270  
A147-11 11-el 146-148 MHz  
215WB 15-el wide band 2M  
32-19 19-el. 2M beam  
4218XL 18-el 2M Boomer  
424B 24 el. 432 MHz  
AOP-1 OSCAR pack  
Call for prices on the entire line!

### ROHN TOWERS:

#### SELF-SUPPORTING

(6 sq. ft. model)

BX64 64 ft. .... \$Call

(10 sq. ft. models)

HBX40 40 ft. .... \$Call

HBX48 48 ft. .... \$Call

HBX56 56 ft. .... \$Call

(18 sq. ft. models)

HDBX40 40 ft. .... \$Call

HDBX48 48 ft. .... \$Call

(Ratings based on 10 ft. boom.)

#### GUYED TOWER SECTIONS

25G, 45G, 55G & accessories

Call for current prices.

**New! 7 ft. UPS shippable 25G sections**

#### FOLD-OVER TOWERS

Call for current prices.

### TELEX/hy-gain

Crank-up towers: 37 -70'

TH7DXS: 7-el. tribander

TH5 Mk2: 5-el. tribander

Explorer-14: tribander

Discoverer: 40 Meter beams

205 CA: 5-el, 20 M. beam

204BAS: 4-el, 20 M. beam

155BAS: 5-el, 15 M. beam

105BAS: 5-el, 10 M. beam

18HTS: 8-10 M. vertical

18ATV/WBS: 80-10 M. vertical

V2S; V3S; & V4S

215-DX: 15 el. 144 MHz beam

7031-DX: 31 el. 432 MHz beam

64BS & 66BS: 6 Meter beams

OSCAR Link Antennas

Complete inventory. Call for prices.

## ROTATORS

### TELEX/hy-gain

AR-40

CD 45 II

Ham IV

T2X

HDR-300

ORION

New Heavy duty

### M<sup>2</sup>

MT-3000 Heavy duty elevation

rotor for LARGE VHF and

EME arrays

### ALLIANCE

U-110 Light duty elevation.

HD-73 Rotor... Available Again.

### KLM

KT34A ..... \$Call  
KT34XA ..... \$Call  
HF Monobanders, VHF, UHF, & OSCAR  
antennas in stock.

### ALPHA-DELTA

DX-A Sloper ..... \$46.95  
DX-CC ..... \$79.95  
DX-DD ..... \$65.95

### HUSTLER

6BTV 80-10 mtr vertical  
5BTV 80-10 mtr vertical  
G6-144B 2 mtr base antenna  
G7-144 2 mtr base antenna

Complete mobile systems.

### BUTTERNUT

HF6VX Vertical, 80-10M.  
HF2V Vertical, 80 & 40M.  
HF5B Compact beam, 20-10M  
We have all Butternut accessories.

### DIAMOND

Our best selling dual band antennas.  
Antennas for 2 meters and 440 MHz.  
NEW! U-5000: 2M, 440 MHz, 1.2 GHz.

## ACCESSORIES

### SPECIAL MFJ



989C TUNER

Complete MFJ inventory!

### HEATH

SB-1000 Linear Kit

SA-2060 Tuner Kit HT's  
Packet Gear HW-9 QRP Rig  
Twin Band Mobile Xcvrs

Call us to order HEATH gear.



PK-232

Morse, Baudot, ASCII, AMTOR,  
Packet, Facsimile, & Navtex



AT-300 TUNER  
**SPECIAL!**

ISOPOLES & ISOLOOPS



NYE Viking MBV-A



rf concepts



AMERITRON AL-82A

### ASTRON POWER SUPPLIES

RS-4A ..... \$ 39.95      RS-7A ..... \$ 49.95      RS-12A ..... \$ 69.95  
RS-20A ..... 88.95      RS-35A ..... 139.95      RS-50A ..... 199.95  
RS-20M ..... 109.95      RS-35M ..... 159.95      RS-50M ..... 219.95  
VS-20M ..... 124.95      VS-35M ..... 174.95      VS-50M ..... 232.95

## WIRE & CABLE

### BELDEN COAX: (Performance.....not problems)

9913 low loss, 50 ohm      RG-8X (9258), 50 ohm, Foam.  
RG-213U (8267), 50 ohm, mil spec.      RG-11A/U (8261), 75 ohm  
RG-8/U (8237), 50 ohm      RG-58/U (8259), 50 ohm  
RG-8/U (8214), 50 ohm, Foam.      RG-59/U (8241), 75 ohm

RG-214/U (8268), 50 ohm, double shield.

Don't settle for less than the best. Call us for Belden.

### COPPERWELD ANTENNA WIRE:

Solid: 12 ga...\$0.12/ft.; Solid: 14 ga...\$0.09/ft.; Stranded 14 ga...\$0.10/ft.

### ROTOR CABLE:

Standard (6-22, 2-18) . . . \$0.23 Heavy Duty (6-18, 2-16) . . . \$0.39/ft.

Call For Jumpers And Custom Cable Assemblies.  
We stock Amphenol Connectors and Andrew Heliax.

## VISA Mastercard

Personal checks verified with  
Telecheck

Prices subject to change without notice.  
Shipping additional except as noted.  
Returns subject to 15% restocking fee.

## ORDER TOLL FREE

# 1-800-233-2482

Shipping info., Technical, Inside Minnesota, & DX

218-765-3254

FAX: 218-765-3308

## rf enterprises

HCR Box 43

Merrifield, MN 56465

More than a source .....a solution.



# ...Brings You A

## Keyers



### The Morse Machine MM-3 Keyer

The Morse Machine has all the features you need in a memory keyer, including 2 to 99 WPM speed selection and over 8,000 characters of soft-partitioned memory. Twenty memories store your messages...as short or as long as you like. Memory can be expanded to 36,000 characters. All memory is backed up by an internal lithium battery.

Comprehensive Morse training facilities are built-in. **A Proficiency Trainer** for random code group practice. **A Random Word Generator** which generates four-letter words and **A QSO Simulator** which allows you to call stations, answer a CQ or listen to realistic on-the-air QSO's.

The MM-3 also features automatic serial number insertion and incrementing in any memory message. Use the front panel knob to adjust your sending speed or enter a precise speed with the keypad, toggling between the two at any time. Exchanges can be expedited by having parts of your message sent at a higher speed. You can even add remote switches for four of the memories to send your response or call CQ. The MM-3 can also be programmed for automatic beacon use. The RS-232 compatible serial I/O port provides computer control of the MM-3 and monitoring of the Morse training features.

## Packet

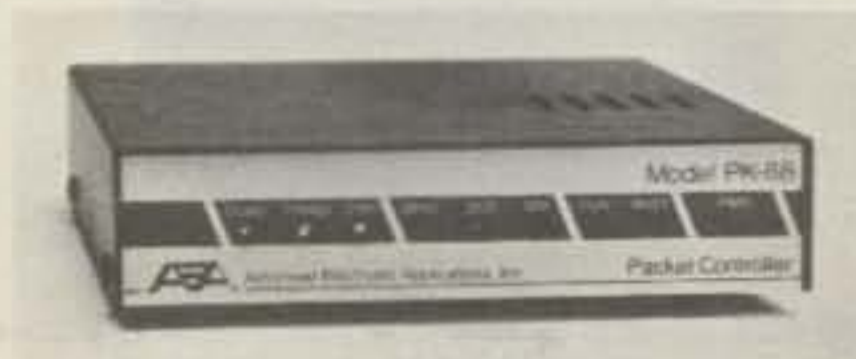

### PK-88 Packet Radio TNC

Unique operating features with a proven hardware and software design make AEA's PK-88 your best choice in packet radio--now with MailDrop, an 8KByte efficient personal Mailbox. The PK-88 also allows multiple single frequency QSO's, digipeating and networking. It's a superb value, packed with all the most needed packet radio features such as direct interface capability with NET/ROM and TCP/IP. In addition to all the features of a "standard" TNC, the PK-88 offers features not found in any other TNC:

- **WHYNOT** command - Shows reasons why some received packets are not displayed.
- **"Packet Dump Suppression"** - Prevents dumping unsent packets on the radio channel when the link fails.
- **CUSTOM** Command - Allows limited PK-88 customization for non-standard applications.
- **Enhanced MBX** command - Permits display of the data in I- and UI-frames, without packet headers and without packet headers or retried frames.
- **Enhanced MPROTO** command - Suppresses display of non-ASCII packets from Level Three switches and network nodes.

## Multi-Mode



### PK-232MBX Multi-Mode Data Controller

With over 40,000 units sold worldwide, the PK-232MBX is the world's leading multi-mode data controller. Combining all amateur data communication modes in one comprehensive unit, the PK-232MBX offers Morse Code, Baudot, ASCII, AMTOR/SITOR 476 and 625, HF and VHF Packet, WEFAX receive and transmit, TDM, as well as commercial standard NAVTEX automated marine information services.

All software is on ROM.

- 20 front panel status and mode LED indicators
- RS-232 compatible
- Exclusive SIAM™ Signal Identification and Acquisition Mode
- TDM Time Division Multiplex decoding
- PakMail™ mailbox with selective control of third-party traffic
- FAX printing - supports most printers
- Two radio ports
- Host mode for efficient program control of the PK-232MBX
- KISS mode for TCP/IP networking protocol compatibility
- 32K RAM lithium battery-backed
- Many features for the digital SWL

## Antennas

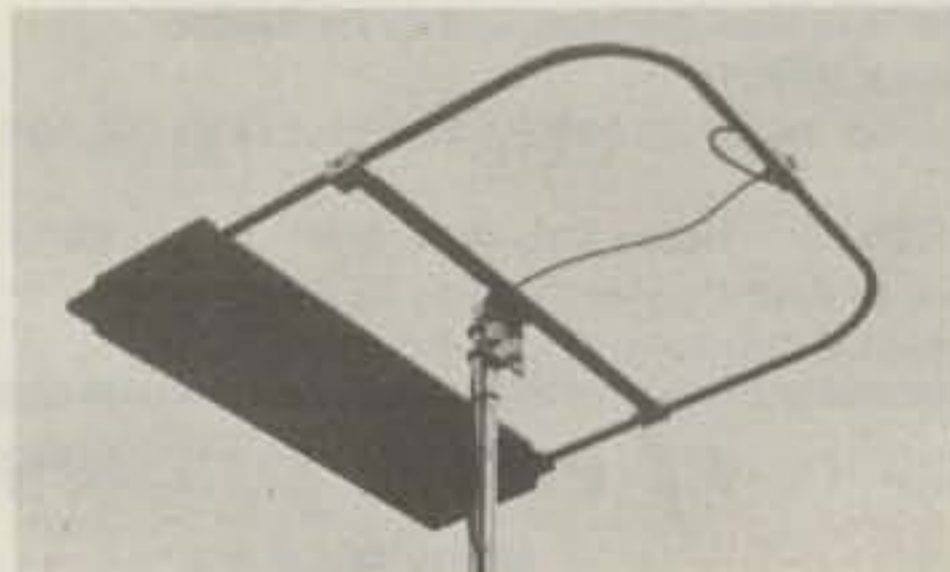

### IsoLoop™ 14-30 MHz Compact HF Antenna

AEA brings you the breakthrough in compact HF antenna design with its high-performance, low-profile IsoLoop HF antenna. Designed specifically for hams with limited space or antenna restrictions, the 32"-square IsoLoop covers all frequencies from 14 to 30 MHz, at up to 150 watts continuous.

No ground radials are needed and its balanced, shielded feed-loop isolates the antenna from the feedline. This ensures that your signal is radiated by

the antenna, not the feedline, which helps eliminate TVI and stray RF in the shack.

The inherent hi-Q of the IsoLoop makes it like a very sharp tunable filter that radiates. The narrow bandwidth suppresses harmonics from your transmitter, and also attenuates out-of-band signals that could overload your receiver.

The omni-directional IsoLoop makes an excellent attic or balcony antenna, and because it weighs only 12 pounds is also perfect for portable use.

# Better Experience

## Dummy Load



### DL-1500

#### DC-650 MHz Up to 1500 Watts

AEA's dry dummy load simulates a perfect 50 ohm antenna up to 650 MHz so you can test your transmitter without radiating a signal on the air.

- DC-650 MHz
- Simulates matched 50 ohm transmission line to test your transmitter
- Handles short-term RF power up to 1500 watts
- VSWR of less than 1.3:1 at 650 MHz
- Compact and lightweight
- Air cooled dry load

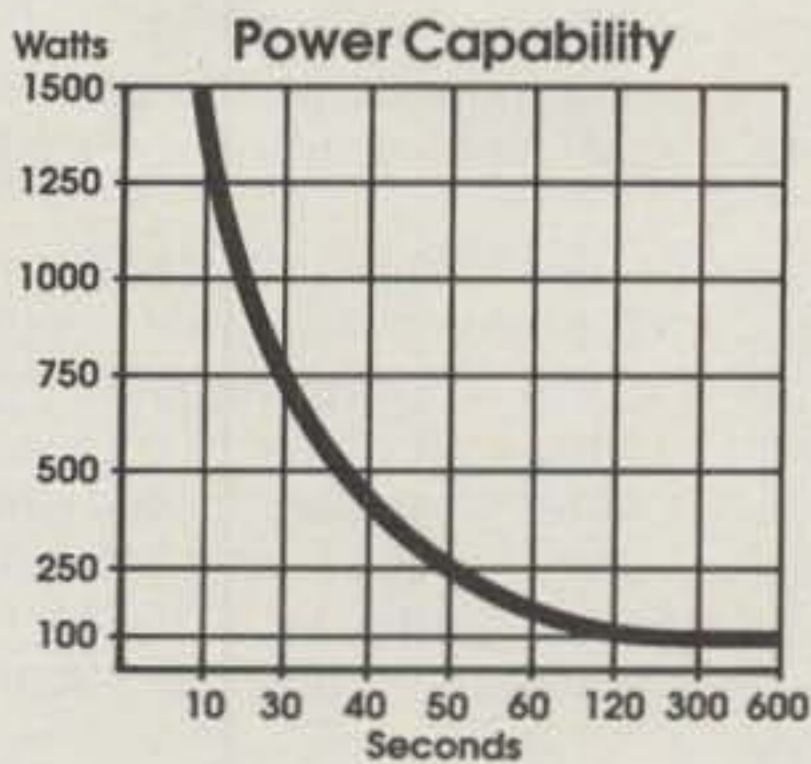

## EconoTuner



### ET-1 Antenna Tuner

#### 300 Watts of All-Band Tuning

Meet your match with AEA's new ET-1 Econo-Tuner™. A quality, economical antenna tuner for under \$150, the ET-1 Econo-Tuner is designed to match virtually any receiver, transmitter or transceiver from 1.8 to 30 MHz with up to 300 watts of RF power.

Compatible with almost ANY antenna including verticals, dipoles, inverted vees, beams and mobile whips that are fed by coax cable, balanced lines or a single wire. For easy connection to balanced lines, a 4:1 balun is built-in.

A front panel switch control allows you to switch between two coax-fed antennas (direct or through the tuner). You can also switch to a balanced line or wire antenna. The BYPASS position allows you to switch to a dummy load (such as AEA's DL-1500 dry dummy load) or a direct connected coax antenna. In the BYPASS position, COAX 1 OUT or COAX 2 OUT can be selected so that the tuner is bypassed, but not the meter circuit.

The ET-1 features a precision dual-movement meter to simultaneously monitor power and SWR.

Unique engineering designs have made AEA one of the leading innovators in the amateur radio industry. That same quality and superior technical support make the ET-1 your best deal for an antenna tuner.

## Antennas

### IsoPole™ Omni-Directional VHF and UHF Base Station Antennas



An outstanding mechanical and electrical design make the IsoPole the best choice for an economical omni-directional VHF or UHF base station antenna. All IsoPole antennas yield the maximum gain attainable for their respective lengths and a zero degree angle of radiation which puts the most signal on the horizon. Exceptional decoupling results in simple tuning and a significant reduction in TVI potential. Decoupling cones offer great efficiency over obsolete radials which radiate in the horizontal plane. The IsoPoles also have a broader frequency coverage than any comparable antennas. Typical SWR is 1.4 to 1 or better across the entire band!

All mounting hardware is stainless steel. The decoupling cones and radiating elements are made of corrosion-resistant aluminum alloys. Aerodynamic cones are the only appreciable wind load and are attached directly to the support (a standard TV mast, not supplied).

IsoPoles are ideal for packet radio. The decoupling cones stop computer hash picked up by the outer shield of the coaxial cable from being passed to the receiver.

## Amateur TV

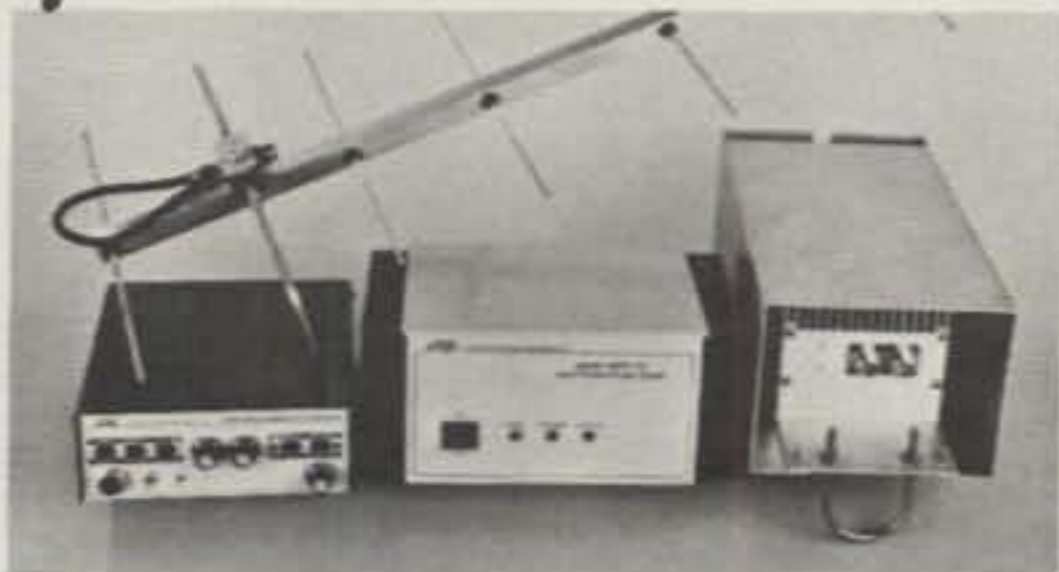

### AEA's New ATV System

Add a new dimension to your amateur radio communications with AEA's Amateur Television (ATV) system. If you hold at least a technician-class license, you can transmit and receive live or taped audio and video Fast-Scan TV (FSTV) information that rivals broadcast quality. Now you can share more than conversation over the air with this new mode of "personal communications."

**It's Easy and Inexpensive.** If you have a video camera or camcorder and a standard TV set, you may already own the most expensive components of an ATV system. AEA's ATV system includes a transceiver and antenna. Simply connect the camera, TV and the antenna to the transceiver, and you're on the air LIVE with one watt P.E.P.! If you want to broadcast with more power, AEA also offers a 50 watt mast-mounted linear amplifier and GaAsFET preamp with power supply. Your TV set will monitor your transmitted and received pictures.

Amplifier Now Available.

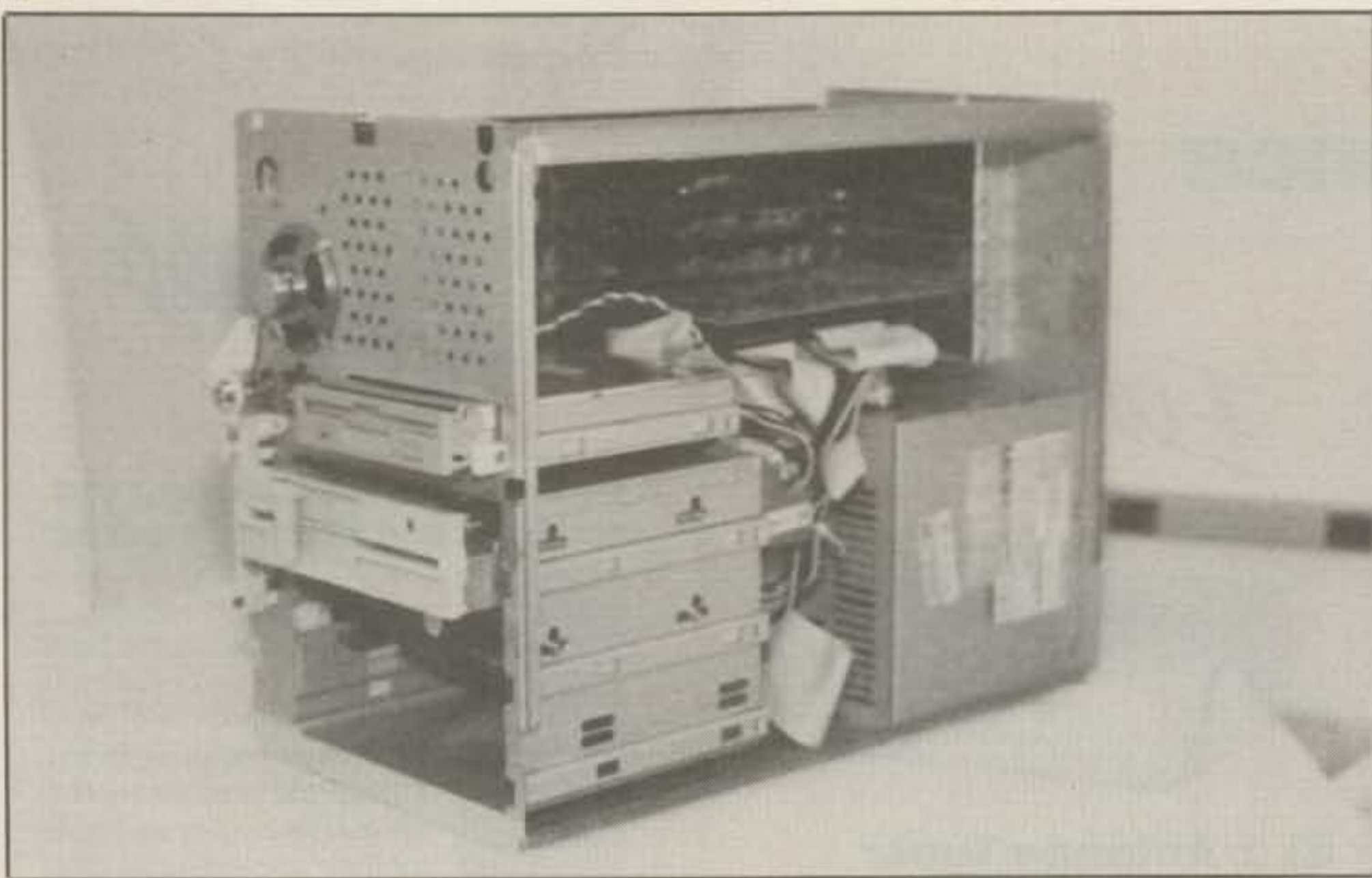

With the sturdy steel cabinet removed, the Sierra Technologies 80386SX continues to display a strong and rugged personality.

## Just Another Member Of The Family

Soon each family in America will find the need to "adopt" a computer. There are already small single- and dual-task computers in the household, but these support specific chores or actions such as timing, make/break, ON/OFF or start/stop functions in the automatic washers, climate control, energy control, etc. Even the small smoke detectors that are required in all new homes are microprocessor based.

When we think of the differences the computer has made in our lives, we begin to understand how great the impact of the PC really is. Our society has accepted the personal computer as a quiescent member of the household who stands ready to dash into action at the simplest command.

In many ways our home computer has a "personality" all its own. It has become a probing force behind our day-to-day decision making and productivity. The computer has given us more leisure time, and with the same offering, we've included it as a participant in much of our leisure.

## Tools or Toys?

I use the PC as a tool, but when I'm not "tooling" around, I'm at one PC building another article for the "The Packet User's Notebook" column. Another PC is being used in a packet QSO with a DX station on 20 meters. Still another is passing binary files with a station on 2 meters, and a fourth computer is transferring a 256-color, high-resolution picture to a friend via packet video. I can use the PC just as easily on AMTOR, RTTY, CW, ASCII, or any other digital mode that

comes to mind. The PC when associated with amateur radio can be summed up in the following sentence: The computer is one of the most useful components in today's ham shack simply because of its versatility, dependability, and durability.

## A Search for Tomorrow

I used to look through the "swapper" magazines and shopping guides for a bargain-basement price on a PC. The problem I ran into with this "shopping-blind" method was all too often I came up short on the parts I had ordered by means of "back orders," or I was disappointed with what I had received.

The element of surprise was very often just that. When the merchandise I thought I had purchased arrived, we were surprised! In some instances items that were "supposed" to be included weren't, and other times such items were included but were defective. I was on the phone long distance on my nickel calling the vendor to discuss how we were going to resolve my dilemma.

I've spent too much time and expense recently searching for the next generation of PC for my writing, drawing, and packeting. This is why I'm writing this article and review. I truly feel that I might save a prospective computer purchaser some time and money by pointing out the possible pitfalls that can be encountered.

## Look Before You Leap

My next PC purchase had to be thought out carefully, because I wanted this PC to be around for awhile. In the writing business there is no longer time to spend

shopping for "just the right" mouse trap. I didn't care to go through the "shopping rags" to find all the bits and pieces that I needed to build an 80386 machine. I have the 8088s, the 8086s, and 80286 XTs and ATs.

This time it had to be short, sweet, and ready to run. I had decided that I wanted the 80386SX system. I went first for quality, with best price second. My plans were to purchase the system from a dealer who had a good reputation as a supplier and the best technical support record after the sale.

This 80386SX would be completely outfitted with all the elements that are needed to support DesignCAD for my drawings in the "Packet User's Notebook" column, as they are drawn using the DesignCAD and AutoSketch.

In addition to a serial port for the Trak-Ball, I needed a second serial port to attach another data transfer switch that fans out to five TNCs.

My "search for tomorrow's" PC is over. I had a reason to look for the best bang for my buck, and I found it.

While in a packet QSO with my son Glynn, WB4RHO, I mentioned that I was searching for a good deal in a 386 system. He quickly suggested "Randy's Discount Disks." He told me that he and a friend, Jimmy, KC4HFK, had each purchased new systems from Randy, and had found the PCs to be perfect in every option they had ordered.

Coming from my son, that had to be an endorsement if I ever heard one. Glynn is aware of how meticulous I am with my equipment purchases, and he seemed so positive that I had to at least give Randy's a try.

I asked Glynn to give me the telephone number. The next packet that appeared contained the toll-free number. I "hot-keyed" to the text editor feature of the MULTICOM terminal program and sent the toll-free number to the printer. While I was in the editor feature of MULTICOM, I sent the phone number to disk as "RANDYS.NUM."

Glynn and I completed our packet QSO, so I decided to give Randy a call. I dialed order-line number 1-800-543-2237. When the operator answered "Sierra Technologies," I thought for a moment that I may have dialed an incorrect number. As it turns out, Sierra Technologies is the parent company of Randy's Discount Disks.

Randy was outside, so I left my telephone number, and in about ten minutes he returned my call. We discussed my wants, needs, likes, and dislikes. In a very short time I had the bottom line figure for the system I wanted and needed. As a matter of fact, Randy had the exact system I needed already put together in a "package," so to speak.

I didn't make my decision at that moment, because we were a few days away

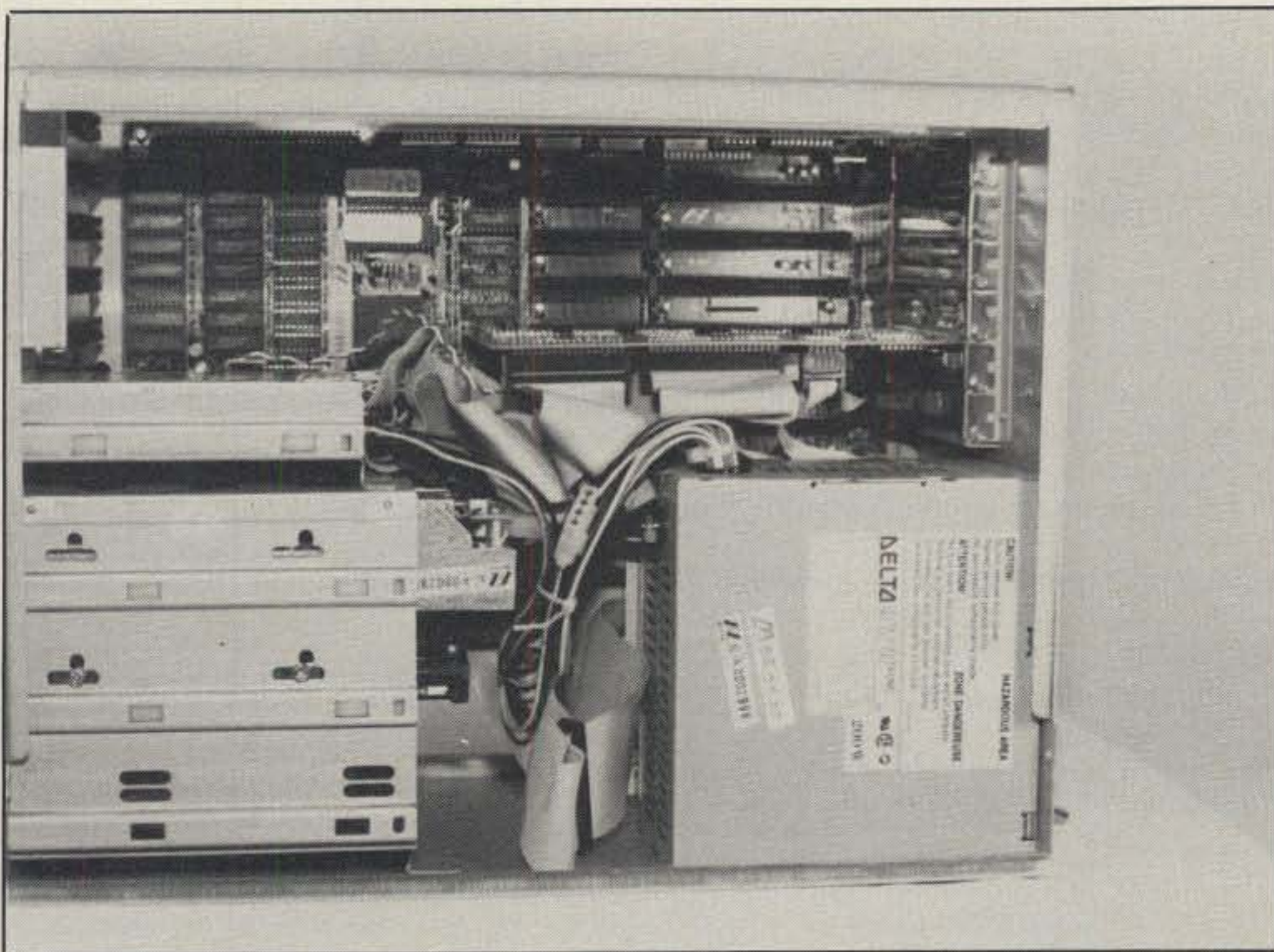

Even after the standard features are added, there are empty expansion ports that can allow adding future features and peripherals.

from the 1990 Dayton Hamvention and I wanted to do more shopping around.

As usual, I enjoyed the Dayton Hamvention, and I did more shopping around for the system I needed. With every price quotation the arithmetic kept me shopping. I finally got around to visiting Randy's booth at Dayton. There was no denying that Randy Bridges was present at Dayton. That was not a booth, but rather that was wall to wall computers. From the looks of it, I thought I would have to take a number or make an appointment to see Randy. We amateurs have a sixth sense when it comes to finding a bargain, and it was apparent that Randy was making some available. We discussed the previous quote, and he continued to be as good as his word. His "deal" was the best yet, and what's more, Randy had the system in stock and ready to ship. I asked him to ship it to me as soon as he got back from Dayton.

A few days later UPS made the delivery, and I was in PC heaven. I methodically put together the system in a calm and reserved manner.

Now if you believe that last sentence, then I have a "deal" for you. What really happened is this: I had that system unpacked, connected together, and humming in no time flat. The best part of all is that "Randy 2" (that's the way I keep the two Randys separate—Randy 1 is Randy Bridges, and Randy 2 is Randy Zipper) had already installed my Disk Operating System (DOS) formatted and partitioned on the hard disk for me. My job was simple because all I had to do was connect the keyboard, short-stack, and monitor

together, apply power, and the system booted to the "C>" prompt.

I had briefly mentioned to Randy that I wanted the disk partitioned into two segments as drive(s) "C" and "D." I could just as easily have had the full 40 megabytes as one "C" drive if I wanted to run it in that configuration. MS/DOS 4.01 and above will easily support the full 40 megabyte hard disk.

### A Lot of Computer For The Money

There it was, 1 megabyte of memory (RAM), 40 megabyte hard disk, one 1.2 mb 5.25 inch floppy, one 1.44 mb 3.5 inch drive, two serial (COM) ports, a parallel printer port, column cabinet (short-stack), the TTX VGA monitor, PVGA 1024 VGA color card with 512K of graphics memory (RAM) installed on the color card, and the 80386SX CPU. It was up and running in very short order. I connected my printer to the parallel port and ran a printer test to confirm communications between the computer and the printer.

Next I installed my PCTOOLS.EXE 4.3 (older version—someday I'll buy version 6.0) and prepare to transfer some of my favorite word-processor and other often-used programs and files from the old 8088 machines.

### Several Days Later

What did I do before the 80386SX? This computer is *fast*, and it didn't cost an arm



- IC-725 HF Xcvr./Gen. Cov. Rcvr. . . . . \$799.00
- IC-726 HF/6-Mtr. Xcvr./Gen. Cov. Rcvr. . . . 1099.00
- IC-735 HF Xcvr./Gen. Cov. Rcvr. . . . . 939.00
- AH-2A HF Automatic Antenna Tuner . . . . . 479.00
- AT-150 HF Automatic Antenna Tuner . . . . . 369.00
- PS-55 AC Power Supply . . . . . 196.00
- IC-765 HF Xcvr./Gen. Cov. Rcvr. . . . . 2679.00
- SM-8 Desk Microphone . . . . . 89.00
- IC-R7000 Communications Receiver . . . . . 1019.00
- AH-7000 Omnidirectional Ant. For IC-R7000 . . . 99.00
- IC-28H 2-Meter, FM, 45 Watt Xcvr. . . . . 384.00
- IC-228H 2-Meter, FM, 45 Watt Xcvr. . . . . 419.00
- IC-229H 2-Meter, FM, 50 Watt Xcvr. . . . . 409.00
- IC-2400A 2-Mtr./440-MHz, FM, 45W/35W . . . 689.00
- IC-2GAT 2-Mtr., FM, Handheld With T-T . . . 364.50
- IC-4GAT 440-MHz, FM, Handheld With T-T . . . 384.50
- IC-32AT 2-Mtr./440-MHz, FM, Handheld W/T-T . . 534.50
- IC-2SAT 2-Mtr., FM, Mini Handheld W/T-T . . . 349.50
- IC-3SAT 220-MHz, FM, Mini Handheld W/T-T . . . 359.50
- IC-4SAT 440-MHz, FM, Mini Handheld W/T-T . . . 384.50
- IC-24AT 2-Mtr./440-MHz, FM, Mini H-H W/T-T . . 534.50
- BP-5 10.8 VDC, 425 mA., Ni-Cad Batt. Pack . . . 65.00
- BP-7 13.2 VDC, 425 mA., Ni-Cad Batt. Pack . . . 79.00
- BP-8 8.4 VDC, 800 mA., Ni-Cad Batt. Pack . . . 79.00
- BP-83 7.2 VDC, 600 mA., Ni-Cad Batt. Pack . . . 49.00
- BP-84 7.2 VDC, 1000 mA., Ni-Cad Batt. Pack . . 75.00
- BP-85 12.0 VDC, 340 mA., Ni-Cad Batt. Pack . . 99.00
- BC-16U AC Wall Charger For IC-BP7, 8, 23, 24 . . 21.25
- BC-74A AC Wall Chg.; BP-81, 82, 83, 84, 85, Int. . . 21.25
- BC-35 Drop-In Rapid Charger; IC-BP2, 5, 7, 8 . . 79.00
- BC-72A Drop-In Chg.; BP-81, 82, 83, 84, 85, Int. . . 99.00
- CP-11 Cigarette Lighter Cable W/Noise Filter. . . 18.99
- CP-12 Cigarette Lighter Cable W/Noise Filter. . . 18.49
- BA-12 Bat. Chg. Adap.; IC-2SAT/Int. Bat./BC-72A . . 16.99
- HM-46 Speaker/Microphone . . . . . 31.99

### AMPHENOL

- 83-1AP UHF, Right Angle Adapter . . . . . \$3.37
  - 83-1J UHF, Barrel Adapter . . . . . 2.00
  - 83-1SP UHF, Male, Silver-Plated PL-259 . . . . 1.50
  - 83-168 UHF, RG-59/U Reducer . . . . . .41
  - 83-185 UHF, RG-58/U Reducer . . . . . .37
  - 82-101 Type-N, Barrel Adapter . . . . . 5.47
  - 82-202 Type-N, Male, For RG-8/U . . . . . 3.19
  - 82-202-1006 Type-N, Male, For Belden 9913 . . . 3.48
  - 31-3202 BNC, Male, For RG-58/U, 142/U, 223/U . . 2.26
  - 31-4541 BNC, Male, For RG-59/U, 62/U . . . . 3.07
- Other Amphenol Connectors And Adapters Are Available

### CUSHCRAFT

- A3 14, 21, 28-MHz, 3-Element Beam . . . . \$274.00
- AP8 3.5, 7, 10, 14, 18, 21, 24, 28-MHz Vertical. . . 172.00
- R5 14, 18, 21, 24, 28-MHz Vertical . . . . . 245.00
- ARX-2B 2-Meter, Ringo Ranger II Vertical. . . 44.00
- ARX-450B 450-MHz, Ringo Ranger II Vertical . . . 44.00
- 124WB 144 to 148-MHz, 4-Element Beam . . . 44.00
- 215WB 144 to 148-MHz, 15-Element Beam . . . 95.00
- A147-11 146 to 148-MHz, 11-Element Beam . . . 56.00
- A449-11 440 to 450-MHz, 11-Element Beam . . . 49.00

### ASTRON

- RS-7A 13.8 VDC, 7 Amp Int., 5 Amp Cont. . . . \$47.94
- RS-12A 13.8 VDC, 12 Amp Int., 9 Amp Cont. . . . 69.54
- RS-20A 13.8 VDC, 20 Amp Int., 16 Amp Cont. . . . 86.14
- RS-35A 13.8 VDC, 35 Amp Int., 25 Amp Cont. . . . 138.94
- RS-12M Same As RS-12A, With Meter. . . . . 80.34
- RS-20M Same As RS-20A, With Meter. . . . . 105.34
- RS-35M Same As RS-35A, With Meter. . . . . 156.94
- RM-35M Rack Mount Version Of RS-35M. . . . 223.94
- VS-35M Same As RS-35M, Adj. Volt./Curr. . . . 168.74
- VS-50M 13.8 VDC, 50A Int., 37A Cont., Adj. . . . 232.34

UPS/Insurance Charges Are Additional  
MC And VISA Orders Are Accepted  
Prices Subject To Change Without Notice

*LaRue Electronics*

1112 GRANDVIEW STREET  
SCRANTON, PENNSYLVANIA 18509  
PHONE (717)343-2124

and a leg. With DesignCAD my drawings seem to "pop" to the screen. With my old version of Professional Write word processor, I used to be able to type faster than the screen could update. Not so anymore. This is "speed" in the greatest sense of the word.

## Resolution

Perhaps now is a good time to describe the viewing capabilities. With the PVGA 1024 card stuffed with 512K (standard with the Sierra) of RAM, the color rendition that it exhibits is certainly a treat for the palette of the eye.

The PVGA 1024 color graphics card can deliver 1024 x 768 resolution modes that provide 16 colors with the accompanying software that is supplied with the Sierra 80386SX system. It has all the capabilities of the IBM Personal System/2™ VGA Display Adapter including full VGA compatibility at the hardware level.

With support for a 16-bit bus and high-

speed memory access, the Data Bus allows the PVGA 1024 to present a data path between the system processor and the video display memory that is two times the width of the 8-bit video display systems. This also includes the 16-bit video BIOS implementation of the AutoSense™ feature.

The graphics card also supports 640 by 400 dot enhanced graphics with 256 simultaneous colors from a palette of over 262,000 possible colors, with the 512K of display memory.

As most readers already know, I'm obsessed with computer pictures and graphics. I collect pictures of airplanes, cars, women, and flowers, especially roses. Many of the "GIF" format picture disks that readers send to me are in my collection. Most of my graphics collection are in VGA, and many are converted to the packet VGA picture format. With this new TTX VGA monitor and PVGA 1024 color display combination, I've begun admiring and "showing-off" my picture collection more often.

As I view these brilliant and extreme regions of the visible light spectrum on this Sierra system, I cannot help but be thankful for the blessing of good eyesight. This kind of resolution and color-imagery is where we discover a strange form of solace and gratification that has mystified the artist and art lovers for eons.

## In Retrospect

As I look back over the last several months, I'm proud and happy with the purchase of the 80386SX system from Sierra Technologies. If you find yourself at an impasse about which system to purchase, then you owe it to yourself and your checkbook to give Randy a toll-free call at 1-800-543-2237. You may discover they have the exact system for which you are shopping. If you need other information, try the info line, 904-729-3444. For technical assistance, you may call the tech hot-line at 904-729-3447. The mailing address is Sierra Technologies Group, 143 John Simms Parkway, Valparaiso, FL 32580.

The Sierra Technologies System that I purchased and described here is 100% IBM compatible and runs at 16 (or 8) MHz speed, with a zero wait state. It is supplied with the VGA color monitor and the PVGA color card described above.

One 3.5 inch 1.44 megabyte and one 5.25 inch 1.2 megabyte floppy disk drive are included. The workhorse of the drives is the 40 megabyte hard drive that has an access time of better than 20 milliseconds.

One megabyte of RAM is installed, and the system can be expanded to eight megabytes of on-board RAM. There are two serial ports and a parallel printer port. A battery-backed real-time clock/calendar board is also included. A 101 key, IBM-style keyboard is standard with the Sierra system.

It is a complete PC with all the trimmings, and the mother board is socketed for the addition of a math co-processor if so desired. There are extra, vacant expansion slots in the upright "short-stack" for future additions such as digitizers and other hardware peripherals.

The Sierra system retails for \$2495, and the amateur net price is \$1895.

## Trademarks

IBM is a registered trademark of International Business Machines Corporation.

XT, AT, PS/2, and Personal System/2 are trademarks of International Business Machines Corporation.

AutoSense is a trademark of Western Digital Imaging.

Microsoft is a registered trademark of Microsoft Corporation.

Hercules is a registered trademark of Hercules Computer Technology, Inc. 

## ASSOCIATED RADIO

8012 CONSER BOX 4327  
OVERLAND PARK, KANSAS 66204

CALL 913-381-5900

FAX 913-648-3020

### EVERY DAY A HAMFEST

WE'LL BUY  
YOUR  
EXTRA RIG  
STATIONS -  
ESTATES ETC.

### BUY—SELL—TRADE

All Brands new and reconditioned.



Send \$3.00 for our current catalog and wholesale sheet.

# PETER DAHL CO

## Heavy Duty Components

### FOR THE SERIOUS HAM

Hipersil Plate & Filament Transformers  
High Voltage Rectifiers, DC Filter  
Chokes & Capacitors, Vacuum  
Variables, Roller Inductors, RF Plate &  
Filament Chokes.



Write today for  
a complete  
free listing.

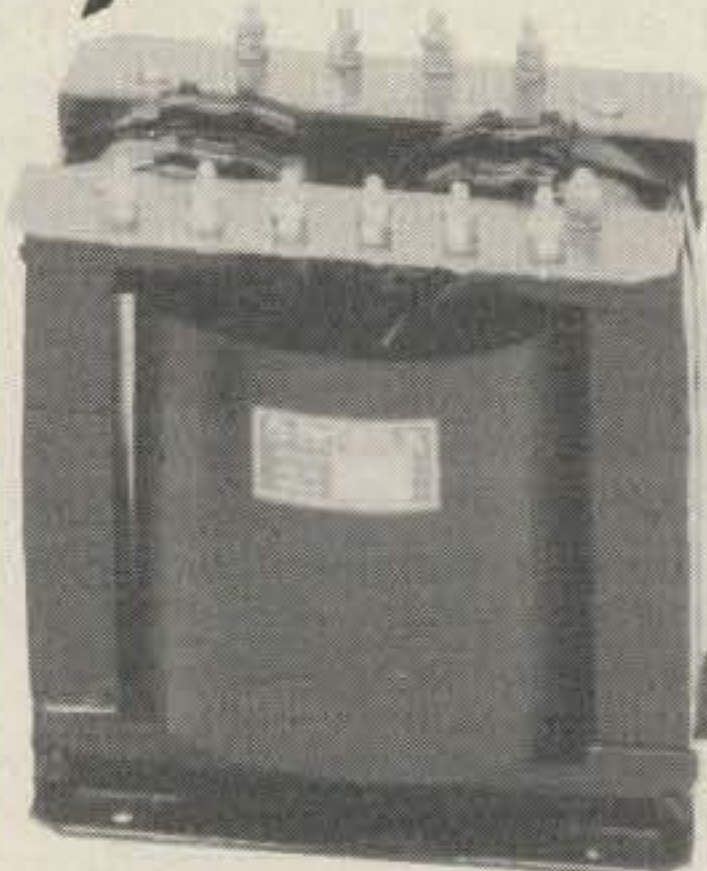

5869 Waycross Avenue El Paso, Texas 79924  
(915) 751-2300 Telex: 76-3861 PWDCO Fax: (915) 751-0768

CIRCLE 38 ON READER SERVICE CARD





# AFFORDABLE 10-METER DXING

## With This Realistic® Ham Transceiver

Hams are working the world with this value-packed rig and here's what they're saying about it: "Great audio . . . Sounds like a much bigger radio . . . Best mobile I've ever owned . . . Very easy to install."

Realistic HTX-100 is a compact SSB/CW transceiver that gives you full 10-meter coverage in selectable 10kHz, 1 kHz or 100 Hz steps. You get a 10-frequency memory, mike-mounted up/down tuning, effective noise blanker and 5 or 25-watt power output.

The HTX-100 operates USB or semi break-in CW with sidetone. Packet compatible? Yes, with 40 ms rx/tx turnaround. Eight-pin mike connector. Requires 12VDC at 7 amps. Only \$259.95

**More Super Values!**  
 Magnetic-Mount Antenna, \$37.95  
 General Class Course, \$19.95  
 Add-On External Speaker, \$13.95

## World-Class Quality, First-Class Service

HTX-100 is backed by a 1-Year Limited Warranty and Realistic's outstanding quality control. The optional Tandy® Service Plan extends warranty to five years for just pennies a month!

See this high-performance transceiver now at one of the 7000 Radio Shack locations, along with our big selection of accessories for improving your home or mobile station. Your nearby Radio Shack store offers excellent values in coax cable, antenna wire and hardware, RF connectors and adapters, fuses, power strips and more.

NOTE: You must have a current FCC Amateur Radio License to transmit with this transceiver. Prices apply at participating Radio Shack stores and dealers. Radio Shack is a division of Tandy Corporation

### CREATING NEW STANDARDS

**PROVEN LEADERSHIP.** Over 7000 USA locations, 39,000 employees, seven R&D centers, 31 USA and overseas manufacturing—**NOBODY COMPARES**

**GUARANTEED SATISFACTION.** Over 35 million customers benefit from our Satisfaction Guarantee. Putting you first made us #1 in electronics—**NOBODY COMPARES**

**Radio Shack®**  
**AMERICA'S**  
**TECHNOLOGY**  
**STORE™**



# Rules For The CQ WAZ Awards Program



**T**he CQ Worked All Zones (WAZ) Award and its variations are issued to any licensed amateur station presenting proof of contact with the appropriate number of CQ zones of the world. This proof consists of proper QSL cards which in many cases may be checked by any of the authorized check points or sent directly to the WAZ Award Manager. Many of the major DX clubs in the USA and Canada and most national amateur radio societies are authorized CQ check points. If in doubt, consult the WAZ Award Manager. Any legal type of emission may be used, providing communication was established after November 14, 1945 for the basic award.

1. The Official CQ WAZ Zone Map and the printed zone list which follows these rules are used to determine the zone in which a station is located.

2. Confirmations must be accompanied by a list of claimed zones, using CQ form 1479 or a facsimile, showing the callsign of the station contacted within each zone, with the date, time, band, and mode of each contact. The list must also clearly show the applicant's name, callsign, and complete mailing address. The applicant must show the type of award for which he or she is applying, such as Mixed Mode, All SSB, or All CW (see #7 below). A hand-written list may be submitted and will be accepted for processing, provided that the above information is shown.

3. All contacts must be made with licensed, land-based, amateur service stations operating in authorized (on the date of contact) amateur bands. Contacts with non-land-based stations, such as ships at sea, aeronautical mobile, or polar ice stations are not acceptable.

Awards obtained by any mobile station will be endorsed as such, as will awards obtained by QRP stations, providing that the QSL cards submitted specify these modifiers.

4. All contacts submitted by the applicant must be made from within the same DXCC country. It is recommended that each submitted QSL clearly show the contacted station's zone number, if possible. When the applicant submits cards made out to different callsigns, evidence should be provided to show that he or she also holds or has held those callsigns at the time of the contact.

5. Any altered or forged confirmations submitted by an applicant for WAZ credit may result in permanent disqualification. The WAZ Manager may request the resubmission of certain confirmations as required. While a QSL card is normally accepted as proof of a contact, the final proof is an entry in the DX station's logbook for the listed QSO. Failure to resubmit QSLs in a timely manner when requested by the WAZ Manager may result in the recall of the award in question. Submission of an application for any WAZ award acknowledges consent to abide by the decisions of the CQ WAZ Manager and the CQ Awards Committee.

6. An application must be accompanied by the processing fee (subscribers must include a recent CQ mailing label with the application fee of \$4.00; nonsubscribers \$10.00) and a self-addressed envelope with sufficient postage or International Reply Coupons (IRCs) to return the QSL cards by the class of mail desired and indicated. International Reply Coupons equal in redemption value to the processing fee are acceptable. The 1990 redemption value of IRCs is \$.50 each. Checks should be made out to the name of the WAZ Award Manager.

7. In addition to the basic certificate for which any and all HF bands may be used, specially endorsed and numbered certificates are available for Phone (including AM), Single Sideband, and CW operation. The Phone certificate requires that all contacts be Two-Way Phone, the SSB certificate requires that all contacts be Two-Way SSB, and the CW certificate requires that all contacts be Two-Way CW.<sup>1</sup>

8. If at the time of the original application a note is made stating the possibility of a subsequent application for an endorsement or special certificate, only the missing confirmations required for that endorsement need be submitted with the later application, providing a copy of the original authorization signed by the WAZ Manager is enclosed.

9. Decisions of the CQ Awards Committee on any matter pertaining to the administration of this award are final.

10. All applications should be sent to the WAZ Award Manager after the QSL cards have

been checked by an authorized CQ check point. If the application is for 160 meters or 5 Band WAZ, all QSL cards must be checked by the WAZ Award Manager.

11. Zone maps, printed rules, and application forms are available from the WAZ Award Manager. Send a 6 x 9 inch self-addressed envelope with \$.65 postage, or \$1.00 and your address label. For DX stations, send an address label and 3 IRCs.

The following list of zones is presented as a guide. Any questions will be decided by the CQ Zone Map. For rulings on borderline areas, consult the WAZ Award Manager.

**Zone 1.** Northwestern Zone of North America: KL7, VY1/VE8 Yukon, the Northwest Territories west of 102 degrees. (Includes the islands of Victoria, Banks, Melville, and Prince Patrick.)

**Zone 2.** Northeastern Zone of North America: VO2 Labrador, the portion of VE2 Quebec north of the 50th parallel, the VE8 Northwest Territories east of 102 degrees. (Includes the islands of King Christian, King William, Prince of Wales, Somerset, Bathurst, Devon, Ellesmere, Baffin, and the Melville and Boothia Peninsulas.)

**Zone 3.** Western Zone of North America: VE7, W6, and the W7 states of Arizona, Idaho, Nevada, Oregon, Utah, and Washington.

**Zone 4.** Central Zone of North America: VE3, VE4, VE5, VE6, and W7 states of Montana and Wyoming, W0, W9, W8 (except West Virginia), W5, and the W4 states of Alabama, Tennessee, and Kentucky.

**Zone 5.** Eastern Zone of North America: 4U1UN, CY9, CY0, FP, VE1/VY2, VO1, the portion VE2 Quebec south of the 50th parallel, VP9, W1, W2, W3, and the W4 states of Florida, Georgia, South Carolina, North Carolina, Virginia, and the W8 state of West Virginia.

**Zone 6.** Southern Zone of North America: XE/XF, XF4 (Revilla Gigedo).

**Zone 7.** Central American Zone: FO (Cliperton), HK0 (San Andres), HP, HR, TG, TI, TI9, V3, YN, and YS.

**Zone 8.** West Indies Zone: C6, CO, FG, FJ, FM, FS, HH, HI, J3, J6, J7, J8, KG4 (Guantanamo), KP1, KP2, KP4, KP5, PJ (Saba, St. Maarten, St. Eustatius), V2, V4, VP2, VP5, YV0 (Aves Is.), ZF, 6Y, and 8P.

**Zone 9.** Northern Zone of South America: FY, HK, HK0 (Malpelo), P4, PJ (Bonaire, Curacao), PZ, YV, 8R, and 9Y.

**Zone 10.** Western Zone of South America: CP, HC, HC8, and OA.

**Zone 11.** Central Zone of South America: PY, PY0, and ZP.

**Zone 12.** Southwest Zone of South America: 3Y (Peter I), CE, CE0 (Easter Is., Juan Fernandez Is., San Felix Is.), and some Antarctic stations.<sup>2</sup>

**Zone 13.** Southeast Zone of South America:

<sup>1</sup>The Two-Way CW Award is a new addition to the WAZ Program. Previously all Mixed WAZ Awards were numbered consecutively, with All CW noted. This practice will continue for mixed mode applications. In addition, a new WAZ Award is being announced. Beginning January 1, 1991, the All CW WAZ Award will be issued. This is a new award, and certificate numbers will start with number 1. To qualify, the QSL card from each zone must indicate a contact on two-way CW and must be dated after January 1, 1991.

<sup>2</sup>Antarctic notes. The boundaries of CQ zones 12, 13, 29, 30, 32, 38, and 39 converge at the South Pole. Stations KC4AAA and KC4USN are at the South Pole, and will count for any one of the listed zones. Most Antarctic stations indicate their zone on the QSL card. A few stations and their zones are: 4K1A 39, 4K1B 29, 4K1C 29, 4K1D 38, 4K1E 29, 4K1F 13, 4K1G 30, 4K1H 12, 4K1J 13, 8J1RL 39, CE9 13, DP0 38, FT-Y 30, HF0POL 13, HL5BDS 13, KC4AAC 13, KC4AAD 13, KC4AAE 29, KC4USB 32, KC4USV 30, LU-Z 13, VK0GM 29, VP8ME 38, Y38ANT 38, and ZL5AA 30. This list changes frequently. Questions regarding the zone location of a particular Antarctic station should be directed to the WAZ Award Manager.

CX, LU, VP8 Islands, and some Antarctic stations.<sup>2</sup>

**Zone 14.** Western Zone of Europe: C3, CT, CU, DL, EA, EA6, EI, F, G, GD, GI, GJ, GM, GU, GW, HB, HB0, LA, LX, ON, OY, OZ, PA, SM, Y2, ZB, 3A, and 4U1ITU.

**Zone 15.** Central European Zone: ES (UR), HA, HV, I, IS0, LY (UP), OE, OH, OH0, OJ0, OK, SP, T7, TK, UA2, YL (UQ), YU, ZA, 1A0, 9H.

**Zone 16.** Eastern Zone of Europe: UA1, UA3, UA4, UA6, UA9(S,W), UB, UC, UO, and 4J1 (M.V. Island).

**Zone 17.** Western Zone of Siberia: UA9 (A,C,F,G,J,K,L,Q,X) and UH, UI, UJ, UL, and UM.

**Zone 18.** Central Siberian Zone: UA9 (H,O,U,V,Y,Z) and UA0 (A,B,H,O,S,T,U,V,W).

**Zone 19.** Eastern Siberian Zone: UA0 (C,F,I,J,K,L,Q,Z).

**Zone 20.** Balkan Zone: JY, LZ, OD, SV, TA, YK, YO, ZC4, 4X and 5B.

**Zone 21.** Southwestern Zone of Asia: A4, A6, A7, A9, AP, EP, HZ, UD, UF, UG, YA, YI, 4W, 7O, 9K, and J2/A (Abu Ail).

**Zone 22.** Southern Zone of Asia: A5, S2, VU, VU (Laccadive Is.), 4S, 8Q, and 9N.

**Zone 23.** Central Zone of Asia: JT, UA0Y, BY3G-L, BY9A-L, BY9T-Z, and BY0.

**Zone 24.** Eastern Zone of Asia: BV, BY1, BY2, BY3A-F, BY3M-S, BY3T-Z, BY4, BY5, BY6, BY7, BY8, BY9M-S, VS6, and XX.

**Zone 25.** Japanese Zone: HL and JA.

**Zone 26.** Southeastern Zone of Asia: HS, VU (Andaman and Nicobar Islands), XV, XU, XW, XZ, and 1S (Spratly Islands).

**Zone 27.** Philippine Zone: DU (Philippines), JD1 (Minami Torishima), JD1 (Ogasawara), KC6 (Republic of Belau), KH2 (Guam), KH0 (Marianas Is.), V6 (Fed. States of Micronesia).

**Zone 28.** Indonesian Zone: H4, P2, V8, YB, 9M, and 9V.

**Zone 29.** Western Zone of Australia: VK6, VK8, VK9X (Christmas Is.), VK9Y (Cocos-Keeling Is.), and some Antarctic stations.<sup>2</sup>

**Zone 30.** Eastern Zone of Australia: VK1-VK5, VK7, VK9L (Lord Howe Is.), VK9 (Willis Is.), VK9 (Mellish Reef), VK0 (Macquarie Is.), and some Antarctic stations.<sup>2</sup>

**Zone 31.** Central Pacific Zone: C2, FO (Marqueses), KH1, KH3, KH4, KH5, KH6, KH7, KH9, T2, T3, V7, and ZK3.

**Zone 32.** New Zealand Zone: A3, FK, FO (except Marqueses and Clipperton), FW, KH8, VK9 (Norfolk Is.), VR6, YJ, ZK1, ZK2, ZL, 3D2, 5W, and some Antarctic stations.<sup>2</sup>

**Zone 33.** Northwestern Zone of Africa: CN, CT3, EA8, EA9, IG9, S0, 3V, and 7X.

**Zone 34.** Northeastern Zone of Africa: ST, ST0, SU, and 5A.

**Zone 35.** Central Zone of Africa: C5, D4, EL, J5, TU, TY, TZ, XT, 3X, 5N, 5T, 5U, 5V, 6W, 9G, and 9L.

**Zone 36.** Equatorial Zone of Africa: D2, TJ, TL, TN, S9, TR, TT, ZD7, ZD8, 3C, 9J, 9Q, 9U, and 9X.

**Zone 37.** Eastern Zone of Africa: C9, ET, J2, T5, 5H, 5X, 5Z, and 7Q.

**Zone 38.** South African Zone: A2, ZD9, Z2, ZS1-9, 3DA0, 3Y (Bouvet Is.), 7P, and some Antarctic stations.<sup>2</sup>

**Zone 39.** Madagascar Zone: D6, FT-W, FT-X, FT-Z, FH, FR, S7, VQ9, 3B6/7, 3B8, 3B9, 5R8, and some Antarctic stations.<sup>2</sup>

**Zone 40.** North Atlantic Zone: JW, JX, OX, TF, and 4K2 (Franz Josef Land).

### Single Band WAZ

Special WAZ Awards will be issued to amateur radio stations presenting proof of contact

with the 40 zones of the world on *one* of the bands: 80, 40, 20, 15, 10. Contacts for a single band WAZ must have been made after January 1, 1973. Single band certificates will be awarded for ALL SSB or for ALL CW only.

### 5 Band WAZ

Applicants who succeed in presenting proof of contact with the 40 zones of the world on the 80, 40, 20, 15, and 10 meter bands (for a total of 200) receive a special certificate in recognition of this achievement. A prerequisite for 5 Band WAZ is that the applicant must already be a holder of any 40-zone WAZ.

The 5 Band WAZ Award is offered for any combination of CW, SSB, RTTY, or other mode contact, mixed mode only. Separate awards will not be offered for the different modes. Contacts must have been made after 0000Z January 1, 1979. Initial proof of contact shall consist only of QSL cards checked by the WAZ Manager, and all provisions of Rule 5 of the WAZ rules are strictly enforced. The first plateau is a total of 150 zones on a combination of 5 bands. Applicants should use a separate sheet for each band, using CQ form 1479 or a facsimile.

After the 150 zone point, each 10 zones requires the submission of the QSL cards and a \$1.00 fee. At the 200 zone point the applicant will be awarded a gold sticker for the certificate and the opportunity to purchase an engraved plaque to commemorate the achievement.

All applications should be sent to the WAZ Award Manager. The 5 Band Award is governed by the same rules as the regular WAZ Award and uses the same boundaries.

### WARC Bands WAZ

Effective January 1, 1991 single band WAZ Awards will be issued to amateur radio stations presenting proof of contact with the 40 zones of the world on any *one* of the WARC bands: 30, 17, or 12 meters. (Each band constitutes a separate award, and each may be applied for separately.) This award is available for Mixed Mode, All SSB, All CW, or All RTTY. Contacts for each one of these WARC WAZ Awards must have been made after each station involved in the contact had permission from its licensing authority to operate on the band and mode.

### RTTY WAZ

Special WAZ Awards are issued to amateur radio stations presenting proof of contact with the 40 zones of the world using RTTY. For the mixed band award QSL cards must show a date of November 15, 1945 or later. The RTTY WAZ is also available with a single band endorsement. For a single band endorsement for 80, 40, 20, 15, or 10 meters the QSL cards must show a date of January 1, 1973 or later.

### WNZ

WNZ stands for "Worked Novice Zones" and is available *only* to holders of a U.S. Novice or Technician class license. Proof of contact with at least 25 of the 40 CQ zones as defined by the WAZ rules is required. All contacts must be made using the 80, 40, 15, and 10 meter Novice bands. All contacts must be made while holding a Novice or Technician class license, although the application may be submitted at a later date. Contacts must be made prior to receiving authorization to operate with

higher class privileges. The WNZ is available as a Mixed Mode, CW Only, or SSB Only award. It may also be endorsed for a single band. The WNZ Award may be used to fulfill part of the application requirement for the WAZ Award when all 40 zones are confirmed.

1. The basic award may be secured by submitting QSL cards for 25 zones. The processing fee is \$5.00 for all applicants.

2. All QSL cards must show a date of January 1, 1952 or later.

3. Use CQ form 1479 or a facsimile to make application for this award.

### 160 Meter WAZ

The WAZ Award for 160 Meters requires that the applicant submit directly to the WAZ Manager QSL cards from at least 30 zones. All QSL cards must be dated January 1, 1975 or later, and a \$5.00 application fee must accompany all applications. The 160 WAZ is a mixed mode award only. The basic 160 WAZ Award may be secured by submitting QSL cards from 30 zones. Stickers for 35, 36, 37, 38, 39, and 40 zones may be secured from the WAZ Manager upon the submission of the QSL cards and \$2.00 for each sticker.

### Satellite WAZ

The Satellite WAZ Award is issued to amateur radio stations submitting proof of contact with all 40 CQ zones through any amateur radio satellite. The award is available for Mixed Mode only. All QSL cards must show a date of January 1, 1989 or later.

The WAZ Award Manager is Jim Dionne, K1MEM, 31 De Marco Rd., Sudbury, MA 01776.

## NAVY SPECIAL HF MOBILE 3-BAND WHIP

MODEL (A) 40-30-20 Meters  
MODEL (B) 17-15-12 Meters



#### Featuring:

Instant Band switch,  
Direct SO 239 fitting,  
low profile, 52" long,  
needs no guys or  
springs, rugged construction,  
stainless steel brass and nickle,  
anodised alloy, nitrile rubber,  
corrosion proof.

WE SHIP WORLD-WIDE  
**ORDER NOW**

CARDS ONLY  

FAX: 011 44 691 670235  
or mail direct to our factory

**\$68.50** single

**\$129.00** pair

## NAVY SPECIAL CO.

73 CROGEN, CHIRK  
CLWYD LL14 5BJ  
UNITED KINGDOM

CIRCLE 149 ON READER SERVICE CARD

**For many of us AMTOR is an abstraction, a simple click away on a mode switch. What is it? How does it work? How do I use it? These and many more questions are answered by K9GWT in simple, everyday terms.**

# AMTOR For Beginners

BY BILL HENRY\*, K9GWT

**A**MTOR is a relatively new and exciting "RTTY-type" mode. However, I find that many would-be "AMTORites" suffer from "chirp-fright." At first, the alphabet-soup of acronyms, strange modes, and transmitter pulsing can be very intimidating. Not to worry. It's all quite simple once you get your feet wet.

This is not the first—nor the last—beginner's article on AMTOR. The references list a number of other authors and articles on the same topic. You may find that their words are even more informative than mine. Multiple opinions always help. Take heart in the knowledge that AMTOR is actively used by many amateurs and is growing. You do *not* have to be a Ph.D. or computer-whiz to have fun on AMTOR!

## What Is AMTOR?

Very simply, AMTOR is "modern RTTY." It is very similar in many ways to the plain old "teletype" we have used since the 1950s. AMTOR is also similar to packet. Some would say that AMTOR is the "technical bridge" between RTTY and packet. However you want to think of it, AMTOR is a mode which we use to send text back and forth between radio stations. Like RTTY (and packet), AMTOR uses an FSK (Frequency Shift Keyed) modulation mode. Unlike RTTY, but similar to packet, AMTOR includes *error correction*. On poor signals, receiving RTTY can become tedious as the errors and misprints pile up. A good RTTY modem can help, but there will still be some errors when the other fellow's signal fades to "zip." Not generally so on AMTOR. It just keeps repeating until it "gets it right"!

## AMTOR Modes

AMTOR is not just one mode to send text; it includes *several* related, but different modes. The major modes of AMTOR are:

**ARQ:** In ARQ mode the sending station sends three characters at a time. He then turns his transmitter OFF and the receiving station sends a one-character control signal to signify "OK, go ahead" or "Please Repeat Last Group." In ARQ mode both stations alternate between transmit and receive. The station sending text is called the ISS for "Information Sending Station," and the station receiving text is called the IRS for "Information Re-

ceiving Station." ARQ mode is the normal mode used by amateurs when in QSO. ARQ may also be called "Mode A" on some controllers. This is the "chirp-chirp" stuff you hear between 14070 and 14080! ARQ mode is similar to packet in this respect.

**FEC:** FEC (Forward Error Correction) mode is a lot like RTTY. One station turns on his transmitter, sends an entire message, and then stands-by for the other station to transmit his response. FEC does not have the "Acknowledge/Repeat" pulse exchange of ARQ mode for error correction. However, FEC corrects errors by the simple expedient of transmitting each character twice. The receiving controller has the "smarts" to know when an error has occurred and to then look at the repeated character. FEC mode is primarily used for calling CQ to set up a QSO in ARQ mode, but it may also be used for RTTY-like QSOs and is especially useful when "broadcasting" bulletins to many stations. The W1AW bulletins are sent via FEC; commercial shore stations often transmit weather information using FEC mode. On some controllers FEC mode may be called "Mode B" or "Mode F."

**SFEC:** SFEC (Selective FEC) mode is almost identical to FEC mode, but it includes a special call-up code so that it may be directed to selective stations; your controller won't lock onto SFEC unless you have coded the same Selective Call sign as that sent by the transmitting station. SFEC has to date seen little use in amateur radio. Its major use is for messages to a group of ships in the maritime service. SFEC may or may not be included in your AMTOR controller. SFEC is sometimes called "Mode S."

**STBY:** STBY (Standby) Mode is just what it sounds like. This is the normal "rest" condition of your AMTOR controller when you are monitoring and waiting for someone to call you. AMTOR controllers are intelligent and can distinguish between ARQ, FEC, and SFEC signals. When a valid AMTOR signal is received (and you have a "SELCAL match" in ARQ or SFEC mode—more on this in a bit), the controller automatically switches to the correct mode and starts printing. The AMTOR controller should not respond or produce receive print when a RTTY, CW, or packet signal is received.

**MON:** MON (Monitor) mode allows you to listen to ARQ, FEC, or SFEC signals. MONitor is also called "LISTEN" mode on many AMTOR controllers. This is a receive-only mode and therefore you do *not* get the error-correction feature when listening to ARQ signals. The controller does the best it can, but you will probably get some "hits" that would not be noticed if you were "connected" in ARQ mode. In

some AMTOR controllers, MONitor mode automatically accepts and prints ARQ, FEC, and SFEC signals; in others, MON or LISTEN will *only* receive ARQ mode signals and you must go back to STBY mode to listen to FEC or SFEC signals. Read your manuals on this one! Monitor is an amateur invention for AMTOR (credit G3PLX<sup>1,2,3</sup>); it is not specified by CCIR-476 or CCIR-625, and is generally not available in commercial "SITOR" equipment.

## What Is This "SELCAL" Business?

In ARQ mode (and SFEC mode) a special "station identifier" is sent at the start of the "link." This "identifier" specifies which station you wish to establish communications with. Without it, all AMTOR stations on your frequency might start "chirping-back" to you and your controller could not sort out the mess. The acronym "SELCAL" stands for **SE**lective **CAL**I. The SELCAL letters can actually be any letters we choose, but amateur convention is to use a contraction of your callsign to make up your own SELCAL. Eddie Schneider, (G0AZT<sup>4</sup>) has the best table for figuring out your own SELCAL:

- 1 × 2 Callsign—Drop the # and duplicate the first letter (example: K9CW SELCAL = KKCW).
- 1 × 3 Callsign—Drop the # and use all four letters (example: K9GWT SELCAL = KGWT).
- 2 × 1 Callsign—Drop the # and duplicate the first letter (example: KS9I SELCAL = KCSI).
- 2 × 2 Callsign—Drop the # and use all four letters (example: AB1CD SELCAL = ABCD).
- 2 × 3 Callsign—Drop the # and second letter (example: WA9YLB SELCAL = WYLB).

This is a very convenient system first proposed and used by Peter Martinez, G3PLX. It is logical, easy to figure out, and in use by practically all amateurs. However, it is *not* infallible! Consider the SELCAL for W9CD, "WWCD." The above formulas also say that "WWCD" would be used by W9WCD, W1CD, W6WCD, and even "WW9CD" (if we ever get to that callsign). Fortunately, this happens rarely, but will occur more often as AMTOR grows in popularity. The "solution" is simply to pick another four-letter combination.

*Common Misconception:* The FCC (or any other regulatory body) does *not* require that your AMTOR SELCAL be related to your callsign! The practice is simply a convenient way to construct a SELCAL. It is *not* required and a SELCAL does *not* relieve us from sending our *full* callsign for identification!

\*616 W. Church Street, Champaign, IL 61820

# uniden®

## \$12,000,000 Scanner Sale

Uniden Corporation of America has purchased the consumer products line of Regency Electronics Inc. for \$12,000,000. To celebrate this purchase, we're having our largest scanner sale in history! Use the coupon in this ad for big savings. Hurry...offer ends January 31, 1991.

### ★★★ MONEY SAVING COUPON ★★★

Get special savings on the scanners listed in this coupon. This coupon must be included with your prepaid order. Credit cards, personal checks and quantity discounts are excluded from this offer. Offer valid only on prepaid orders mailed directly to Communications Electronics Inc., P.O. Box 1045 - Dept. UN14, Ann Arbor, Michigan 48106-1045 U.S.A. Coupon expires January 31, 1991. Coupon may not be used in conjunction with any other offer from CEI. Coupon may be photocopied. Add \$12.00 for shipping in the continental U.S.A.

RELM RH606B-A .....\$419.95  
 RELM RH256B-A .....\$294.95  
 Bearcat 800XLT-A .....\$229.95  
 Bearcat 200XLT-A .....\$229.95  
 Bearcat 100XLT-A .....\$179.95  
 Bearcat 70XLT-A.....\$139.95  
 Bearcat 55XLT-A .....\$99.95  
 Bearcat 210XLT-A .....\$164.95  
 Uniden CARD-A1.....\$144.95  
 Uniden RD3XL-A1 .....\$144.95  
 Uniden RD9XL-A.....\$119.95

### ★★★★ VALUABLE COUPON ★★★★★

## Bearcat® 760XLT-A

List price \$499.95/CE price \$254.95/SPECIAL 12-Band, 100 Channel • Crystalless • AC/DC Frequency range: 29-54, 118-174, 406-512, 806-956 MHz. Excludes 823.9875-849.0125 and 868.9875-894.0125 MHz. The Bearcat 760XLT has 100 programmable channels organized as five channel banks for easy use, and 12 bands of coverage including the 800 MHz band. The Bearcat 760XLT mounts neatly under the dash and connects directly to fuse block or battery. The unit also has an AC adaptor, flip down stand and telescopic antenna for desk top use. 6-5/16" W x 1 1/2" H x 7 3/8" D. Model BC 590XLT-A1 is a similar version without the 800 MHz. band for a new low price of only \$194.95. Order today.

## NEW! Uniden® Telephones

AM470D-A Uniden answering machine.....\$69.95  
 AM464-A Uniden answering machine.....\$49.95  
 AM468V-A Uniden answering machine.....\$49.95  
 AM460-A Uniden answering machine.....\$49.95  
 AM480-A Uniden answering machine.....\$69.95  
 FP300-A Uniden feature phone.....\$34.95  
 FP302-A Uniden feature phone.....\$49.95  
 FP320S-A Uniden feature speakerphone.....\$49.95  
 FP322S-A Uniden feature speakerphone.....\$59.95  
 XE570-A Uniden cordless phone.....\$74.95  
 XE422S-A Uniden cordless speakerphone.....\$109.95  
 XE777S-A Uniden cordless speakerphone.....\$109.95  
 BT100-A Uniden Trimstyle phone.....\$17.95  
 KT280-A Uniden Family phone with 911 feature.....\$29.95  
 FF150-A Uniden Executive phone.....\$39.95

## RELM® RH256B-A

List price \$587.50/CE price \$299.95/SPECIAL 16 Channel • 25 Watt Transceiver • Priority The RELM RH256B is a sixteen-channel VHF land mobile transceiver designed to cover any frequency between 150 to 162 MHz. Since this radio is synthesized, no expensive crystals are needed to store up to 16 frequencies without battery backup. All radios come with CTCSS tone and scanning capabilities. A monitor and night/day switch is also standard. This transceiver even has a priority function. The RH256 makes an ideal radio for any police or fire department volunteer because of its low cost and high performance. A 60 Watt VHF 150-162 MHz. version called the RH606B-A is available for \$429.95. A UHF 15 watt, 16 channel version of this radio called the RU156B-A is also available and covers 450-482 MHz. but the cost is \$454.95.

### ★★★ Uniden CB Radios ★★★

The Uniden line of Citizens Band Radio transceivers is styled to compliment other mobile audio equipment. Uniden CB radios are so reliable that they have a two year limited warranty. From the feature packed PRO 810E to the 310E handheld, there is no better Citizens Band radio on the market today.

PRO310E-A Uniden 40 Ch. Portable/Mobile CB...\$83.95  
 PRO330E-A Uniden 40 Ch. Remote mount CB...\$104.95  
 ER100-A Uniden Emergency CB Mobile.....\$49.95  
 GRANT-A Uniden 40 channel SSB CB mobile.....\$166.95  
 PC122-A Uniden 40 channel SSB CB mobile.....\$119.95  
 PRO510XL-A Uniden 40 channel CB Mobile.....\$38.95  
 PRO510AXL-A Uniden CB Mobile with antenna...\$49.95  
 PRO520XL-A Uniden 40 channel CB Mobile.....\$56.95  
 PRO640E-A Uniden 40 channel SSB CB Mobile...\$137.95  
 PRO810E-A Uniden 40 channel SSB CB Base...\$174.95

### ★★★ Uniden Radar Detectors★★★

Buy the finest Uniden radar detectors from CEI today.  
 RD3XL-A Uniden 3 band radar detector.....\$159.95  
 RD8-A Uniden visor mount radar detector.....\$89.95  
 RD9GTL-A1 Uniden "Passport" size radar detector...\$99.95  
 RD9XL-A1 Uniden "micro" size radar detector...\$124.95  
 RD27-A Uniden visor mount radar detector.....\$54.95  
 RD99GT-A Uniden remote mount radar detector...\$119.95  
 CARD-A1 Uniden credit card size radar detector...\$159.95

## Bearcat® 200XLT-A

List price \$509.95/CE price \$239.95/SPECIAL 12-Band, 200 Channel • 800 MHz. Handheld Search • Limit • Hold • Priority • Lockout Frequency range: 29-54, 118-174, 406-512, 806-956 MHz. Excludes 823.9875-849.0125 and 868.9875-894.0125 MHz. The Bearcat 200XLT sets a new standard for handheld scanners in performance and dependability. This full featured unit has 200 programmable channels with 10 scanning banks and 12 band coverage. If you want a very similar model without the 800 MHz. band and 100 channels, order the BC 100XLT-A for only \$189.95. Includes antenna, carrying case with belt loop, ni-cad battery pack, AC adapter and earphone. Order your scanner now.

## Bearcat® 800XLT-A

List price \$549.95/CE price \$239.95/SPECIAL 12-Band, 40 Channel • No-crystal scanner Priority control • Search/Scan • AC/DC Bands: 29-54, 118-174, 406-512, 806-912 MHz. Now...nothing excluded in the 806-912 MHz. band. The Uniden 800XLT receives 40 channels in two banks. Scans 15 channels per second. Size 9 1/4" x 4 1/2" x 1 1/2". With nothing excluded in the 806-912 MHz. band, this scanner is an excellent choice for law enforcement agencies. If you do not need the 800 MHz. band, a similar model called the BC210XLT-A is available for \$178.95.

## NEW! Bearcat® 147XL-A

List price \$189.95/CE price \$94.95/SPECIAL 10-Band, 16 Channel • No-crystal scanner Priority control • Weather search • AC/DC Bands: 29-54, 136-174, 406-512 MHz. The Bearcat 147XL is a 16 channel, programmable scanner covering ten frequency bands. The unit features a built-in delay function that adds a three second delay on all channels to prevent missed transmissions. A mobile version called the BC560XLT-A featuring priority, weather search, channel lockout and more is available for \$94.95. CEI's package price includes mobile mounting bracket and mobile power cord.

## NEW! Ranger® RCI2950-A

List price \$549.95/CE price \$249.95/SPECIAL 10 Meter Mobile Transceiver • Digital VFO Full Band Coverage • All-Mode Operation Backlit liquid crystal display • Auto Squelch RIT • 10 Programmable Memory Positions Frequency Coverage: 28.0000 MHz. to 29.6999 MHz. The Ranger RCI2950 Mobile 10 Meter Transceiver by Ranger, has everything you need for amateur radio communications. The RF Power control feature in the RCI2950 allows you to adjust the RF output power continuously from 1 watt through a full 25 watts output on USB, LSB and CW modes. The RCI2950 also features a noise blanker, roger beep, PA mode and more. The Mic Gain Control adjusts the gain in transmit and PA modes to maximize talk power. Digital VFO. Built-in S/R/F/ MOD/SWR meter. Frequency selections may be made from a switch on the microphone or the front panel. There is even a repeater split switch for repeater offsets. The RCI2950 lets you operate AM, FM, USB, LSB or CW for full mode operation. The digitally synthesized frequency control gives you maximum stability. There's also RIT (Receiver Incremental Tuning) to give you perfectly tuned signals. With memory channel scanning, you can scan ten pre set frequencies to keep track of all the action. An optional CTCSS tone board is available (order # RTONE) for \$59.95. For technical questions, call Ranger at 714-858-4419. Order your Ranger RCI2950 from CEI today.



BC760XLT  
800 MHz.  
mobile scanner  
SPECIAL!

### ★★★ Extended Service Contract ★★★

If you purchase a scanner, CB, radar detector or cordless phone from any store in the U.S. or Canada within the last 30 days, you can get up to four years of extended service contract from Warrantech. This service extension plan begins after the manufacturer's warranty expires. Warrantech will perform all necessary labor and will not charge for return shipping. Extended service contracts are not refundable and apply only to the original purchaser. Warrantech does not have an extended warranty plan for handheld scanners. For mobile or base scanners, CB radios or radar detectors a 1 year extended warranty is \$19.99, two years is \$39.99 and four years is \$59.99. Order your service contract today.

### OTHER RADIOS AND ACCESSORIES

BC55XLT-A Bearcat 10 channel scanner .....\$114.95  
 AD100-A Plug in wall charger for BC55XLT.....\$14.95  
 PS001-A Cigarette lighter cable for BC55XLT.....\$14.95  
 VC001-A Carrying case for BC55XLT.....\$14.95  
 BC70XLT-A Bearcat 20 channel scanner.....\$159.95  
 BC172XL-A Bearcat 20 channel scanner.....\$134.95  
 BC1-A1 Bearcat Information scanner with CB.....\$119.95  
 BC310A-A Bearcat Information Radio.....\$79.95  
 BC330A-A Bearcat Information Radio.....\$104.95  
 UC102-A Regency VHF 2 ch. 1 Watt transceiver...\$114.95  
 UC202-A Regency VHF 2 ch. 2 Watt transceiver...\$149.95  
 VM200XL-A Uniden Video monitoring system.....\$179.95  
 BP205-A Ni-Cad batt. pack for BC200/BC100XLT...\$39.95  
 FBE-A Frequency Directory for Eastern U.S.A.....\$14.95  
 FBW-A Frequency Directory for Western U.S.A.....\$14.95  
 RFD1-A MI, IL, IN, KY, OH, WI Frequency Directory...\$14.95  
 RFD2-A CT, ME, MA, NH, RI, VT Directory.....\$14.95  
 RFD3-A DE, DC, MD, NJ, NY, PA, VA, WV Dir.....\$14.95  
 RFD4-A AL, AR, FL, GA, LA, MS, NC, PR, SC, TN, VI...\$14.95  
 RFD5-A AK, ID, IA, MN, MT, NE, ND, OR, SD, WA, WY...\$14.95  
 RFD6-A CA, NV, UT, AZ, HI, GU Freq. Directory...\$14.95  
 RFD7-A CO, KS, MO, NM, OK, TX Freq. Directory...\$14.95  
 SMH-A Scanner Modification Handbook.....\$14.95  
 ASD-A Airplane Scanner Directory.....\$14.95  
 SRF-A Survival Radio Frequency Directory.....\$14.95  
 TSG-A "Top Secret" Registry of U.S. Govt. Freq....\$14.95  
 TTC-A Tune in on telephone calls.....\$14.95  
 CBH-A Big CB Handbook/AM/FM/Freeband.....\$14.95  
 TIC-A Techniques for Intercepting Communications...\$14.95  
 RRF-A Railroad frequency directory.....\$14.95  
 EEC-A Embassy & Espionage Communications.....\$14.95  
 CIE-A Covert Intelligence, Elect. Eavesdropping...\$14.95  
 MFF-A Midwest Federal Frequency directory.....\$14.95  
 A60-A Magnet mount mobile scanner antenna.....\$34.95  
 A70-A Base station scanner antenna.....\$34.95  
 USAMM-A Mag mount VHF ant. w/ 12' cable.....\$39.95  
 USAK-A 3/4" hole mount VHF ant. w/ 17' cable.....\$34.95  
 Add \$4.00 shipping for all accessories ordered at the same time. Add \$12.00 shipping per radio and \$4.00 per antenna.

### BUY WITH CONFIDENCE

To get the fastest delivery from CEI of any scanner, send or phone your order directly to our Scanner Distribution Center. Michigan residents please add 4% sales tax or supply your tax I.D. number. Written purchase orders are accepted from approved government agencies and most well rated firms at a 10% surcharge for net 10 billing. All sales are subject to availability, acceptance and verification. On all credit card orders, the ship to address must exactly match the credit card billing address. If the billing address is a P.O. Box or a P.O. Box Zip\* Code, UPS can not deliver to that address. When this occurs, the order must be shipped by mail at a higher cost to you. To avoid this extra charge, you may mail us a check with your order. Prices, terms and specifications are subject to change without notice. All prices are in U.S. dollars. Out of stock items will be placed on backorder automatically or equivalent product substituted unless CEI is instructed differently. A \$5.00 additional handling fee will be charged for all orders with a merchandise total under \$50.00. Shipments are F.O.B. CEI warehouse in Ann Arbor, Michigan. No COD's. Most items listed have a manufacturer's warranty. Free copies of warranties on these products are available by writing to CEI. Non-certified checks require clearance. Not responsible for typographical errors.

Mail orders to: Communications Electronics, Box 1045, Ann Arbor, Michigan 48106 U.S.A. Add \$12.00 per scanner for U.P.S. ground shipping and handling in the continental U.S.A. For Canada, Puerto Rico, Hawaii, Alaska, or APO/FPO delivery, shipping charges are two times continental U.S. rates. If you have a Discover, Visa, American Express or MasterCard, you may call and place a credit card order. 5% surcharge for billing to American Express. Order toll-free in the U.S. Dial 800-USA-SCAN. In Canada, dial 800-221-3475. FAX anytime, dial 313-971-6000. If you are outside the U.S. or in Michigan dial 313-973-8888. Order from CEI today.

Scanner Distribution Center™ and CEI logos are trademarks of Communications Electronics Inc. Sale dates 7/15/90 - 1/31/91 AD #071590-A Copyright © 1990 Communications Electronics Inc.

For credit card orders call  
**1-800-USA-SCAN**

**COMMUNICATIONS ELECTRONICS INC.**

**Consumer Products Division**  
 P.O. Box 1045 □ Ann Arbor, Michigan 48106-1045 U.S.A.  
 For orders call 313-973-8888 or FAX 313-971-6000

Recently, the FCC added a new version of AMTOR to Part 97 of our Rules and Regulations, the "CCIR-625" version. The major difference between CCIR-625 and the original CCIR-476 version is that the new version has a seven-letter rather than a four-letter SELCAL. At this writing, CCIR-625 is brand new and only a few amateurs have made use of it. The seven-letter SELCAL does, however, solve the confusion caused by the four-letter algorithm discussed above. To date, there is no one strong recommendation for just how these seven letters are chosen. I suggested one idea in November 1989 *CQ* (K9GWT<sup>3</sup>), but there are many other schemes that will also work. CCIR-625 includes "downward compatibility", so don't fear, it will also recognize your "older format" signal and communicate. CCIR-625 includes several other nice features and some much-needed clarifications of "gray-areas" of CCIR-476. Use of CCIR-625 will increase as our older AMTOR equipment is upgraded or replaced.

I should also mention that this whole business of "making-up" letter-style SELCALs is strictly an amateur radio invention. The commercial SITOR systems are *required* to use number SELCAL codes that relate to a permanently assigned ship or land-based station identifier. In theory, each marine ship or shore station has a unique SELCAL that can be used to identify the station in an emergency. In practice, that wasn't the case for CCIR-476, since the available number pool has long since been exhausted. This was, in fact, the major reason for commercial adoption of CCIR-625. CCIR 491-1 defines how these SELCAL numbers are converted to letters that are actually sent on the radio link. CCIR-476 will support 4- and 5-digit numbers; CCIR-625, 9-digit numbers. Amateurs are not required to use CCIR-491 procedures to define a SELCAL. Be glad, as it's *not* a simple translation! G3PLX's scheme makes a *lot* more sense.

## How Do I Use This SELCAL Thing?

Simple! You "mash" the magic SELCAL button on your terminal, type in four letters, and away you go—hi! Actually, it's a little more involved than that, but not by much.

In ARQ mode there are two SELCAL codes to worry about—yours and the other guy's. Your SELCAL identifies your station so that other stations may call you and "link-up." Assuming that you do not change callsigns often, this is something you have to do when the controller is new and may never have to mess with again. This SELCAL may be called "LOCAL SELCAL," "MYSELCAL," "MYS," or "MYA." Whatever it's called, read your manual, enter four letters, and store it ("perm" on some controllers; save "CONFIG" on the PCI-3000).

The second ARQ SELCAL is the one of the other station. This SELCAL will need to be changed *each time* you call a different station. This SELCAL may be called "REMOTE CALL," "HISSELCAL," or just be a prompt when you start to send in ARQ mode. Enter the four letters corresponding to the other station's SELCAL.

There are actually two more SELCAL codes, both associated with SFEC (Selective FEC) mode. These are often called the "GROUP CALLS"—"local" and "remote." They will only be required when you are receiving or sending

in SFEC mode. The "local" GROUP CALL corresponds to the SFEC SELCAL that your station will recognize when receiving SFEC messages. The "remote" GROUP CALL is the SFEC SELCAL you will send when transmitting in SFEC. Other stations must have this same SELCAL loaded as their "local GROUP CALL" to receive your SFEC transmission.

## How Do I Call CQ?

We use FEC mode when calling CQ in AMTOR. This is a whole lot like RTTY, but with some special recommendations:

**1. Keep your CQ short—2 or 3 lines.** A short CQ is just common sense—and courteous. Two or three short CQs on a frequency will probably be a *lot* more productive than a long wordy call. I may have gone to sleep by the time you get done calling!

**2. Include your SELCAL as part of the CQ text.** What you want is for the other guy to call you in ARQ mode. He can't do this if he doesn't know your SELCAL!

**3. Start each CQ with a blank line.** The "official" requirements of CCIR-476 and CCIR-625 say that FEC printing does not start until *after* receipt of a CR/LF. Not all AMTOR controllers require this, but it's best to be safe!

**4. Do NOT include a string of "RYRYRYRYRY . . ." letters.** AMTOR uses a special 7-bit data code. The combination "RYRYRY . . ." is the worst bit combination you can imagine for FEC synchronization. In fact, few (if any) AMTOR controllers will ever synchronize to a string of "RYRYRY . . ." and some will lose sync! "RYRYRYRYRY . . ." is a poor idea on RTTY and a disaster for FEC!

I suggest the following AMTOR FEC CQ message:

```
Transmitter ON, AMTOR controller in FEC
mode
(blank line)
CQ CQ CQ DE K9GWT K9GWT K9GWT SEL-
CAL: KGWT KGWT KGWT
CQ CQ CQ DE K9GWT K9GWT K9GWT SEL-
CAL: KGWT KGWT KGWT
CQ CQ CQ DE K9GWT K9GWT K9GWT SEL-
CAL: KGWT KGWT KGWT
CQ DE K9GWT (KGWT), BILL IN URBANA, IL
ZZZZ (HAL PCI-3000)—or—END command
Transmitter OFF, AMTOR controller returns to
STBY mode
```

Paul Newland (AD7I<sup>6,7</sup>) also suggests that we delay between transmitter ON and the start of the CQ text, sending 5 to 30 seconds of "FEC idles" at this start. This is a good idea, since "idles" are required for FEC receive synchronization. However, many AMTOR controllers do not include a way to delay text transmission. The CCIR "rules" require that synchronizing "idles" be sent at the end/start of each line, so the first CR/LF (blank line) gives you a headstart, and there are "idles" sent at the end of each line. Some AMTOR controllers also insert extra idle characters within each line. As G0AZT and AD7I both point out, this is a *very* good idea and one we all hope all manufacturers will soon adopt.

## How Do I Answer A CQ?

First we have to assume that you have successfully received an FEC CQ call and that it is formatted like the example. You must know the

other guy's SELCAL to answer his CQ! Assuming that you did get his SELCAL, enter it as required and start sending in ARQ mode. (The procedure is different for every AMTOR controller. *Read your manual!*) If your answer is successful, the other station will soon start chirping back to you, and "away we go."

## I'm Linked—Now What?

Ha! Wasn't that easy? Now all you have to do is start typing text. Assuming that you have all the weird and wonderful computer buffer controls set correctly (read your manual), text will now be sent to the other station—three characters per "chirp."

Even though our FCC regulations are now considerably relaxed concerning ID, I still like to start each major transmission with the standard "CW style" ID line—"K9CW DE K9GWT," for example. Old habits die hard for me! I also must admit that I send the ID line again at the end of each of my transmissions. It's not necessary, but few have complained!

## Over

ARQ mode has a special command to use when you have typed all you want and it's time for the other guy to beat on the keys. We call this the "OVER" command. The OVER command is actually the transmission of "plus" and "question mark" characters in sequence (+ ?). Once you send (+ ?), the AMTOR controllers take over and "turn the channel around"—you become the "IRS" and the other guy becomes the "ISS." On some controllers there is a special key to press or command to enter for OVER; on others you just type +?. *Note:* If you are still using an old Model 15 or 28 TTY machine as your AMTOR terminal, you must type "quote" and "question mark"; the U.S. Baudot keyboard has a "quote" where the CCIR terminal has a "plus." It's the same bit pattern, but different key-top labels!

## Master/Slave

Note that I referred to an exchange of "ISS" and "IRS." This has *nothing* to do with "MASTER" or "SLAVE." Since you were the original calling station in ARQ mode, we call you the MASTER station. In ARQ mode the MASTER station is simply the station that first started the link. The SLAVE station is the called station in ARQ mode. The terms "MASTER" and "SLAVE" have nothing to do with who is sending text and who is receiving text. The only real distinction between "MASTER" and "SLAVE" is that the "MASTER" sets the timing standards for the link and will be the station initiating a re-call if conditions get so bad that the link fails. In an ARQ QSO the ISS and IRS designations change with each OVER operation; the MASTER/SLAVE designation does not change during an ARQ mode QSO.

## Forced Over

The above describes how a "normal" OVER is done. However, what do you do if the other guy is long-winded ("long-fingered"?) and you want to interject a comment? Ha! We have a solution called "FORCED OVER." In this case the receiving station (IRS) can push another

special button and take command—instantly (at least within three characters). Once you do this, you are again the ISS and what you type is sent to the other station. Here you had better hope that the "flow-control" between your terminal and AMTOR controller works right (and that of the other station as well).

Properly configured, what should happen is that transmit text from the original ISS will be held at the FORCED OVER. When you again return control to the other station (by typing +?), his transmit text should resume *exactly* where it was interrupted. Most computer systems can do this; most mechanical machines *cannot* do this! A FORCED OVER can be rude and may result in loss of some text if flow-control is not working properly at both stations. Most of us now use "computer-controlled terminals," so it is rarely a problem. However, beware if the other guy says he is using an old TTY machine as a terminal!

## End Command

An ARQ link will go forever if you don't end it. ARQ has a special "END" command that is used to shut-down the chirping link. How you send the END command varies a lot between AMTOR controllers. On some it's a special CTRL key; on others you type "ZZZZ" to end. Read your manual! You may observe some of us saying quaint things like "I'LL LET YOU DOWN THE LINK" or simply "LINK DOWN." Obviously, we about to end the link! By the way, don't forget to send an ID line before dropping the link.

The above has been just one example of how to use AMTOR. Eddie Schneider, (G0AZT<sup>4</sup>) Paul Newland, (AD7I<sup>6,7</sup>), and CQ's Buck Rogers (K4ABT<sup>8</sup>) have also written excellent step-by-step beginner's operating instructions. You will learn other techniques and tips with a close reading of their articles.

## Won't All That Chirping Destroy My Radio?

Baloney and poppy-cock! This is by far the *greatest* concern of every AMTOR beginner I have met. It was my biggest concern when I started. In spite of what you hear, AMTOR does *not* destroy rigs; at least it shouldn't. Modern transceivers will take all the click-click operation of the TX/RX relays I have been able to give them. I have never worn out a relay or lost a rig to ARQ chirping. In fact, since the duty cycle of ARQ mode is only 47% at worst, ARQ is a lot easier on the transmitter than RTTY or FEC mode (100% duty cycle).

I do know of two cases where we thought we had wiped-out a TX/RX relay—both on a TS-830s. What actually happened is that multiple relay operations vibrated the relay out of its socket! The TS-830s TX/RX relay is mounted upside down; judicious placement of a 1/4 inch piece of foam rubber fixed both cases!

## Can I Use My Linear?

Now I am going to "hedge my bet"! First of all, you do *not* need a linear for AMTOR. The error correction feature means that while you may get more repeats on weak signals, you can almost always get through with 100 watts or less. Second, with very few exceptions, linears

have large and slow relays. These relays are *not* suited for fast ON/OFF switching required in ARQ mode. The relays often switch high voltages and/or currents. Yes, you can get some pretty spectacular arcs and sparks in the linear, and they will cost *big bucks* to fix!

So unless your linear manufacturer makes a big deal out of "QSK" operation of his linear, forget high power on AMTOR. You don't need it! Actually, we could all probably drop our output power to 10 watts or less and never notice the difference. If you have TVI, AMTOR with low power may be your solution!

## How About Switching Times?

This is another supposed "problem" that has been blown out of proportion. Switching times used to be a concern. It really is *not* a major concern with the current and previous generation of transceiver models. They can *all* be used on AMTOR. However, switching time can be a *big* problem on older equipment. Some models are in fact unusable on AMTOR or may require substantial modifications to use ARQ mode. Many radio manufacturers now have data sheets that give switching times and suggested modifications. Active AMTOR operators are also a good source for modification information—"Caveat Emptor"! By the way, if your rig has a "QSK" mode, use it!

There is also a lot of on-the-air discussion about what values to use when setting the programmable delays in your AMTOR controller. Some amateurs say "set them as low as they will go." Good luck if you do! Here again, *read your manual* and start with the manufacturer's recommended settings. Messing with delays is a two-edged sword. Shorter delays extend your longest distance in ARQ mode, *but* may also increase your minimum distance. The number and purpose of programmable delays varies with each AMTOR controller—*read your manual!* A "delay" time of 20 to 50 ms will work with practically all radios—and cover the world. You do *not* need to set delays to "5" or "10" to work DX! Chances are your radio is not that fast and you may actually be trashing some of your own data while the poor radio is trying to switch! Each controller/radio combination is slightly different. Do some experimenting and determine your own parameters.

## What About The Shift For AMTOR?

In my opinion, there is only one shift that AMTOR stations should use, and that is **170 HZ SHIFT**. This has been the amateur radio RTTY shift for years, is the shift used in all commercial SITOR stations, and is usually the *only* shift supported in the FSK mode of modern transceivers. 170 Hz shift *is* the standard, and you are only doing yourself a disfavor if you attempt to run AMTOR using another shift.

A second shift, 200 Hz, has recently appeared on the amateur bands. 200 Hz shift originated with the Bell 103 telephone-line modem and was adopted for inclusion in packet controllers. When packet moved from VHF to HF, the 200 Hz shift PLL modems came "for free." I think all who run HF packet would have to admit that 200 Hz shift really does not work well for packet. There is an active and much needed drive for improvement in HF packet

# ANTENNA TUNERS



1500W

## MODEL VS1500A ANTENNA COUPLER

The Barker & Williamson VS1500A antenna coupler is designed to match virtually any receiver, transmitter or transceiver in the 160 to 10 meter range (1.8 to 30 MHz) with up to 1500 watts RF power to almost any antenna, including dipoles, inverted vees, verticals, mobile whips, beams, random wires and others, fed by coax cable, balanced lines or a single wire. A 1:4 balun is built-in for connection to balanced lines.

### FEATURES INCLUDE:

- Series parallel capacitor connection for greater harmonic attenuation.
- In-circuit wattmeter for continuous monitoring.
- Vernier tuning for easy adjustment.

Front panel switching allows rapid selection of antennas, or to an external dummy load, or permits bypassing the tuner.

Dimension (Approx.): 11" wide x 13" deep x 6" high

Weight: 6 1/2 lbs.

Price: **\$499.00**

SHIPPING & HANDLING \$4.00

FOB Factory. Fully warranted for one year.



## MODEL VS-300A ANTENNA TUNER GUARANTEED THE BEST VALUE YOU'LL EVER FIND!

**\$111.00**

SHIPPING AND HANDLING \$3.50

- FULL COVERAGE - 1.8 - 30 MHz
- HANDLES UP TO 300 WATTS
- MATCHES VIRTUALLY ALL ANTENNAS  
DIPOLE BEAM  
INVERTED VEE RANDOM WIRE  
VERTICAL MOBILE WHIP
- ACCEPTS COAX BALANCED LINE OR SINGLE WIRE FEEDLINE
- BUILT-IN ANTENNA SWITCH
- BUILT-IN WATTMETER WITH FORWARD AND REFLECTED POWER FOR SWR MEASUREMENTS
- WATTMETER ACTIVE EVEN WITH TUNER IN BYPASS POSITION
- ATTRACTIVE CHARCOAL GRAY FINISH AT HOME IN ANY HAM SHACK
- RUGGED 4:1 BALUN FOR BALANCED FEEDLINE

Please send all reader inquiries directly.

ALL OUR PRODUCTS MADE IN USA  
**BW BARKER & WILLIAMSON**  
Quality Communication Products Since 1932.  
At your Distributors Write or Call  
10 Canal Street, Bristol, PA 19007  
(215) 788-5581

modem standards. Changing the shift (and modulation type) is a recognized requirement for improved HF packet operation. If 200 Hz shift doesn't work for HF packet, why use it on AMTOR?

If your controller has 200 Hz shift, you face a double disadvantage when talking to the rest of us. First of all, your 200 Hz shift transmit signal does not match our 170 Hz spaced receive filters. This makes our receiver tuning much more critical and increases the odds that we will get "hits," many repeats, and eventual link failure. Second, your receive filters do not match our 170 Hz transmitted signal. You also have to "straddle-tune," face tuning errors, and accept less than optimum demodulator performance. A 30 Hz difference does not sound like a lot, but it can make a *big* difference on marginal links.

If you have an AMTOR controller with a 200 Hz shift modem, I suggest that you consider re-

tuning the receive filters and transmit tones for 170 Hz shift. Your AMTOR will be much better for the effort! By the way, retune for 2125 Hz MARK and 2295 Hz SPACE. That's the standard and what your transceiver FSK circuit is set up for! You will not be "true transceiver" with any other tone frequencies.

### What Is APLink?

APLink is a very nice message-forwarding computer program written by Vic Poor, W5SMM. APLink serves as a link between HF AMTOR and VHF packet networks. APLink is run in an "IBM-Compatible" Personal Computer (PC) and provides two data ports—one for the AMTOR controller and one for the packet controller (TNC). The two ports share a common message storage; each can access the other's message files (with some guidance

from the control operator). Vic has written APLink drivers for the AEA PK-232, AMT-1, and HAL PCI-3000 AMTOR controllers. Only a "Gateway" or message relay station needs to run APLink software, so it's a program that many of us will never need. However, we may all want to use the long-haul message relay feature of an APLink Gateway station.

Many Gateway stations also include frequency scanning to monitor 8 to 16 different bands and/or frequencies. These stations therefore avoid many of the problems associated with skip distance and changing band conditions with time. It's also an efficient use of radio spectrum, since the control circuitry automatically skips frequencies which are already in use. The best way to find out more about APLink is to tune around 20 meters, find an APLink station, and watch the fun in MONITOR or LISTEN mode. You will get the idea after a couple of listening sessions and then be able to call and request HELP files for more data. APLink is an exciting new use of RTTY, one that makes full use of the error correcting and robust nature of AMTOR.

### Conclusions

AMTOR is great mode. It is really not hard to run. AMTOR has fewer cryptic commands and is actually simpler to use than packet. HF AMTOR is a whole lot more reliable than HF packet or "straight RTTY." AMTOR does not require high transmitter power. Practically all modern transceivers can run all AMTOR modes. There are now a lot of amateurs all over the world running AMTOR. Whether you like to rag-chew or run traffic, AMTOR is an ideal mode. I must admit that running ARQ mode in a RTTY contest is a lot of work, but it can also be very rewarding! All around, AMTOR is *the* HF data mode for many of us long-time RTTY fanatics.

### References

1. Peter Martinez, G3PLX, "Amtor, an improved radioteletype system, using a microprocessor," *Radio Communications*, August 1979, RSBG, Chelmsford, Essex, England, pp. 714-719.
2. Peter Martinez, G3PLX, "Amtor, the easy way," *Radio Communications*, June/July 1980, RSBG, Chelmsford, Essex, England, pp. 610-615.
3. Peter Martinez, G3PLX, "Amtor, an Improved Error-Free RTTY System," *QST*, June 1981, ARRL, Newington, CT 06111, pp. 25-27.
4. Eddie Schneider, W6/G0AZT, "AMTOR" (monthly column), *RTTY Journal*, April, May/June, July/August 1990, 9085 La Casita Ave., Fountain Valley, CA 92708.
5. Bill Henry, K9GWT, "New AMTOR Mode!", *CQ, The Radio Amateur's Journal*, November 1989, CQ Communications, Hicksville, NY 11801, pp. 36-40.
6. Paul Newland, AD7I, "An Introduction to Amtor," *QST*, July 1983, ARRL, Newington, CT 06111, pp. 11-13.
7. Paul Newland, AD7I, "A User's Guide to AMTOR Operation," *QST*, October 1985, ARRL, Newington, CT 06111, pp. 31-34.
8. Buck Rogers, K4ABT, "The Newcomer's Guide to AMTOR," *CQ, The Radio Amateur's Journal*, November 1989, CQ Communications, Hicksville, NY 11801, pp. 51-55. 

## "VOICEBOX"

### Digital Voice Recorder

#### Features:

- Use for any repeat message.
- Send your CQ, QTH, NET, Contest QSL, ID info, etc., in your own voice without saying a word!
- Create messages by talking into your Station Mic, then replay them instantly at the touch of a button.
- Up to 5 varied-length switch-selectable messages.
- "Soft Sector" pushbutton enables instant reprogram of message lengths — up to 1 minute (up to 2 minutes with additional memory chips ordered below).
- "No Key" switch enables Record or Replay message "off air". Messages heard thru built-in monitor speaker.
- "Mix" switch allows recorded message with Mic override.
- Microphone functions work normally (Up/Down, etc.)

#### Specifications:

Can be operated with ANY equipment, ANY audio signal. Operates from 12 volt DC, with AC adaptor supplied. Front panel controls. Cabinet is RFI shielded and measures 6 1/4" W x 2 1/4" H x 7" D. Includes built-in monitor speaker with volume control. Battery backup keeps messages for 8-12 hours without external power. State-of-the-Art 32KBPS Sampling Rate for natural sounding audio.



#### Prices

In Kit Form with Digital Voice Board	<b>\$189.95</b>
Assembled and Tested	
Complete Unit Assembled and Tested	<b>\$279.95</b>
(1 Year warranty, allow 30 days delivery)	
Additional 1 Meg x 1 Dram (30 seconds per Dram)	<b>\$9.95 ea.</b>
Manual with Schematic and Parts List	<b>\$5.95</b>
(credit applied upon purchase)	

### GenWest Engineering

14401 North 51st Street  
Scotsdale, AZ 85254 (602) 996-9264

CIRCLE 41 ON READER SERVICE CARD

## BUY—SELL—TRADE

All brands new and reconditioned



JST-135  
HF Transceiver

- All Modular Construction
- 150 W Output
- General Coverage Receiver
- 1 Chip, Direct Digital Synthesis
- U/LSB, AM, FM, AFSK

**JRC** ASK FOR SPECIAL SALES PRICES

Find out why thousands of customers have switched to us.

KENWOOD, ICOM, TEN-TEC, Astron, Cushcraft, Larsen, MFJ, Butternut, B&W, Hustler, Antenna Specialists, AEA, Amertron, Van Gorden, ARRL, RF Concepts, Diamond, Kantronics, CallBook, Alpha Delta, Heli, Grundig, Uniden, Bearcat, Mirage, Ameco, Alliance, Dalwa, Hy-Gain & others

**AZDEN**  
AUTHORIZED DEALER



**BW**

**N4EDQ** Amateur Radio  
Sales & Service  
4400 Hwy. 19-A  
Mount Dora, FL 32757

FOR THE BEST DEAL!

**1-800-828-6433**

10:00 to 5:00 P.M. EST. (Mon.-Fri.)



WE SHIP WORLDWIDE

# Barry Electronics Corp.

WORLD WIDE AMATEUR RADIO SINCE 1950

Your one source for all Radio Equipment!

For the best buys in town call:

212-925-7000

Los Precios Mas Bajos en Nueva York

WE SHIP WORLDWIDE!



Gobble Up Our Thanksgiving Savings

See you November 6, LIMARC (speech), Syosset, LI, NY  
November 11, Ham Expo '90, Selden, LI, NY

Technical help offered upon purchase

## KENWOOD



ANTENNAS  
A-S, AES, Cushcraft, Hy-Gain,  
Hustler, KLM, METZ, Mosley,  
Urban, MODUBLOX, TONNA,  
Butternut, Multi-Band

TS440S/AT, R-5000, TS-940 S/AT,  
TM 231A/431A, TM-2570A/50A,  
TR-751A, Kenwood Service Repair,  
TM-731A, TS-711/811A, TH205AT,  
TH225A, TM-631A, TM-331A, TS140S,  
TS680S, RZ-1, TS-790A, TS950SD,  
TH-75A, TH27/47AT, TM-941A

AMPLIFIERS  
STOCKED:  
RF Concepts  
Mirage  
TE Systems

MARINE RADIOS  
ICOM M5, M56, M700TY, M800  
AVIATION PORTABLE ICOM A-20  
KING KX-99

Budwig ANT. Products  
NEL-TECH DVK-100 Digital Voice Keyer  
FLUKE 77, 83, 85, 87 Multimeters

Wanted: HF Radio Technician

VoCom/Mirage/Alinco  
Tokyo Hy-Power/TE SYSTEMS  
Amplifiers & 5/8λ HT Gain  
Antennas IN STOCK

G&G ELECTRONICS ART1,  
Air Disk, SWL, Morse Coach

Professional  
Soldering  
Station  
48 Watts  
\$79

METRON  
KW HF Mobile  
Amplifier  
Stocked

Alpha Delta  
Products  
Stocked

AEA Isopoles  
(144, 220, 440  
MHz), Isoloop.



EIMAC  
3-500Z  
572B, 6JS6C  
12BY7A &  
6146B

BIRD  
Wattmeters &  
Elements  
In Stock

AOR, AR-900, AR-1000—  
wide range, hand held scanners



## Panasonic

Shortwave Radios/Marine

FREQUENCY  
COUNTERS:  
1MHz-1.3GHz

COMMERCIAL  
& HAM  
REPEATERS  
STOCKED.  
WRITE FOR  
QUOTES

MOTOROLA AUTHORIZED DEALER  
KACHINA COMMUNICATIONS DEALER

AUTHORIZED

## SONY

DEALER

DIGITAL FREQUENCY COUNTERS  
OPTOELECTRONICS model 1300 H/A, 0-1300MHz  
2210 H, 0-2200 MHz, 2600H, UTC-3000

Long-range Wireless  
Telephone for export in stock

BENCHER PADDLES,  
BALUNS, LOW PASS FILTERS  
IN STOCK

MIRAGE AMPLIFIERS  
ASTRON POWER SUPPLIES  
Belden Wire & Cable, Int'l Wire  
OPTO KEYERS STOCKED



Kantronics  
KAM, KPC II,  
KPC IV, Data Engine,  
DVR 2.2



Covercraft/Coaxseal Stocked  
SHORTWAVE RECEIVERS  
STOCKED



JRC  
NRD-525,  
JST135

Radios for Business,  
Gov't, 2-way, etc.  
Stocked & serviced,  
call for great prices!

COMET ANTENNAS  
STOCKED

HEIL  
EQUIPMENT  
IN STOCK

Media Mentors—  
Amateur Radio Course



New TEN-TEC  
PARAGON, OMNI V

Hy-Gain Towers  
will be shipped  
direct to you  
FREE of  
shipping cost.

IIX Towers, Antennas,  
Mobile Radio mounts  
stocked. Call.

AMERITRON AUTHORIZED DEALER

KITTY SAYS: WE ARE NOW OPEN 7 DAYS A WEEK.  
Saturday & Sunday 10 to 5 P.M.

Monday-Friday 9 to 6:30 PM Thurs. to 8 PM  
Come to Barry's for the best buys in town.



DRSI

ONV Safety  
belts-in stock

YAESU

FT-767GX, FT-757GXII, FT-747GX,  
FRG-8800, FT-736R, FT-1000D,  
FT-4700RH, FT 212/712RH, FT-470

YAESU ICOM  
FT-23R IC2/3/4SAT  
FT411E-811-911 IC02AT/32AT  
FTC-1903/1123 IC2/4GAT/24AT  
FTH-2008/7008 IC-A20/U16

Landmobile HT's  
ICOM: U16, H16, V100, U400  
MAXON, MOTOROLA,  
YAESU: FTH 2008/7008  
UNIDEN, REGENCY, KING,  
MARINE ICOM: M5, M56, M700  
AVIATION ICOM: A20 H.T., TAD



IC-32AT



IC-H16/U16



MOTOROLA RADIUS  
COMMERCIAL RADIOS



TH-75A



FT-470



ICOM

IC-R71A, 751A, 781, 229H, R-7000,  
IC-765, 275A/H, 3220A, 475A/H, 735,  
IC-901, IC725, IC-2400A/2500A



CES

Simplex Autopatch SDI-50 Will Patch FM  
Transceiver To Your Telephone. Great For  
Telephone Calls From mobile To Base. Simple  
To use. SDI-50, SS1-68.

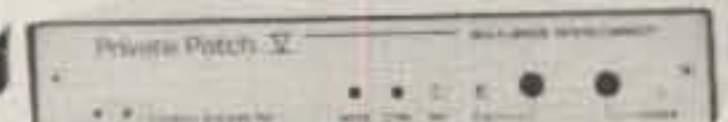

Connect Systems (CSI)  
PRIVATE PATCH V, Duplex 8200,  
CS700

TUNERS STOCKED:  
NYE MBV-A 3 Kilowatt Tuner



MFJ-989C

MAIL ALL ORDERS TO: BARRY ELECTRONICS CORP., 512 BROADWAY, NEW YORK CITY, NY 10012 (FOUR BLOCKS NORTH OF CANAL ST.)

New York City's LARGEST STOCKING HAM DEALER  
COMPLETE REPAIR LAB ON PREMISES

"Aqui Se Habla Espanol"

BARRY INTERNATIONAL TELEX 12-7670  
MERCHANDISE TAKEN ON CONSIGNMENT  
FOR TOP PRICES

Monday-Friday 9 A.M. to 6:30 P.M. Thursday to 8 P.M.  
Saturday & Sunday 10 A.M. to 5 P.M. (Free Parking)

IRT/LEX-"Spring St. Station". Subways: BMT-  
"Prince St. Station". IND-"F" Train-Bwy Station"

Bus: Broadway #6 to Spring St. Path-9th St./6th Ave.  
Station.

COMMERCIAL RADIOS  
STOCKED: ICOM, Motoro-  
la, MAXON, Standard,  
Yaesu. We serve munici-  
palities, businesses, Civil  
Defense, etc. Portables,  
mobiles, bases, re-  
peaters...

ALL  
SALES  
FINAL

We Stock: AEA, ARRL, Ameco, Ameritron, Antenna Specialists, Astatic,  
Astron, B&K, B&W, Bencher, Bird, Butternut, CDE, CES, Cushcraft, Daiwa,  
Eimac, Henry, Heil, Hustler, Hy-Gain, Icom, KLM, Kantronics, Larsen, MFJ,  
J.W. Miller, Mirage, Nye, Palomar, RF Products, Saxton, Shure, Tempo,  
Ten-Tec, TUBES, Yaesu, Vibroplex, Duplexers, Repeaters, Scanners, Radio  
Publications, Uniden, Kenwood, Maxon, RFC.

WE NOW STOCK COMMERCIAL COMMUNICATIONS SYSTEMS  
HAM DEALER INQUIRES INVITED PHONE IN YOUR ORDER & BE REIMBURSED  
COMMERCIAL RADIOS stocked & serviced on premises.

Amateur Radio Courses Given On Our Premises, Call  
Export Orders Shipped Immediately. TELEX 12-7670

FAX: 212-925-7001

# CQ REVIEWS:

## The MFJ-1274/T 2400 BPS Packet Radio Controller

BY BUCK ROGERS\*, K4ABT

I went to bed last Thursday with a problem on my mind, and when I awoke at 6 AM Friday morning I had the solution to the problem.

How many times has this scenario been repeated? There is some kind of mechanism in the human brain that produces a memory management enhancement and problem-solving techniques that we have not yet fully understood. Needless to say, though, while we sleep the facts and figures seem to sort out themselves, and we come up with a solution to the problem in the morning.

Not so long ago I had a similar problem, and the topic of this discussion is the outgrowth of that "solution."

### The End Justifies The Means

To affirm that statement in a more comprehensible manner, we will simply say, "A method will be found to satisfy the necessity." I was groping for a way to build a gateway, node, and conference switch into the GARDS (Georgia Amateur Radio Digital System), and at the same time I wanted to accommodate an HF gateway within the complex.

Now placing an HF gateway into a node cluster is not a great feat provided there is someone to oversee the activities of the HF port. There are still some restrictions that relate to the use of HF digipeating. Maybe someday the League and the FCC will determine that we are not trying to circumvent the system by calling China, via the North Pole, by digipeating via "MOORE" node in Oklahoma (when you figure that out, you will be eligible for a seat on the committee).

My need for a TNC with HF tuning capability, and the addition of a ROSE switch EPROM had become somewhat of a problem. There was another requirement that went along with this dilemma. I also had to add a similar TNC with HF tuning cap-

506 Pheasant Ridge Drive, Warner Robins, GA 31088

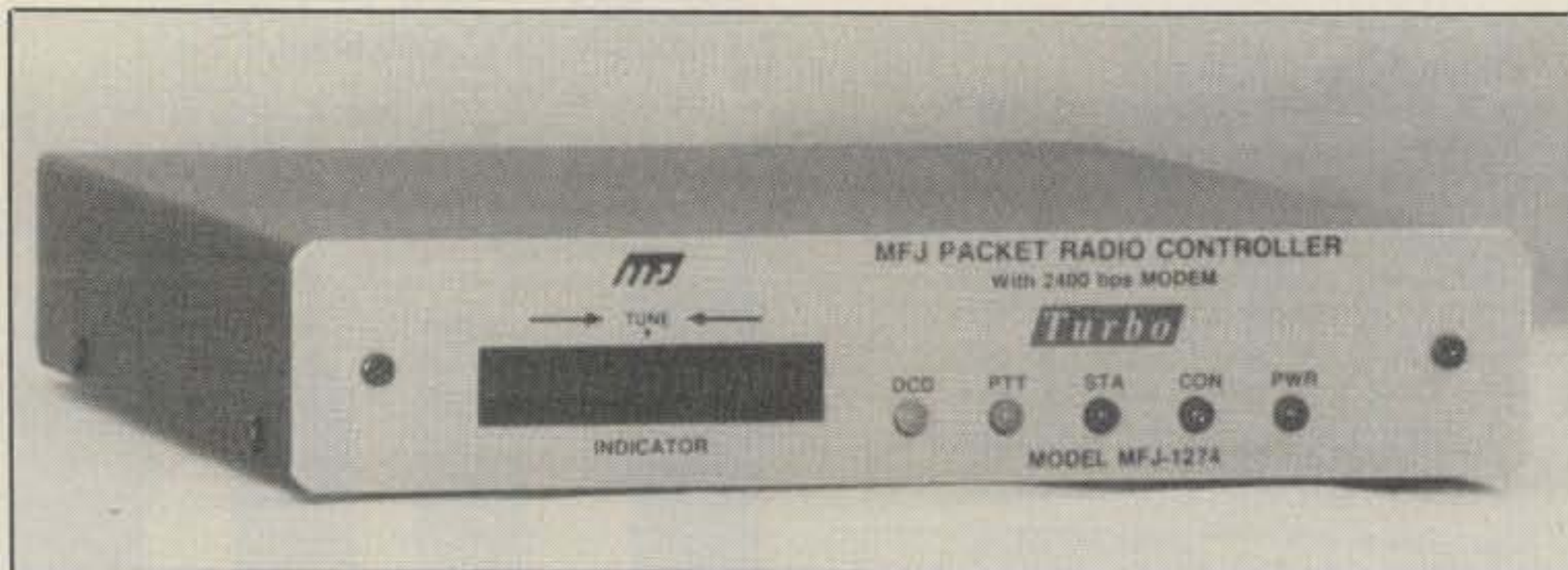

Front view of the MFJ-1274/T TNC.

abilities to this same cluster as a conference node.

### The Solution

I awoke with the solution: The MFJ-1274

was the answer. Here is a TAPR II, TNC 2 clone which has the best of all worlds already built in. Not only is it Net/Rom, ROSE, and TheNet ready, but it has the HF tuning indicator built-in. The MFJ-1274/T is available with the 2400 bps (turbo) modem installed.

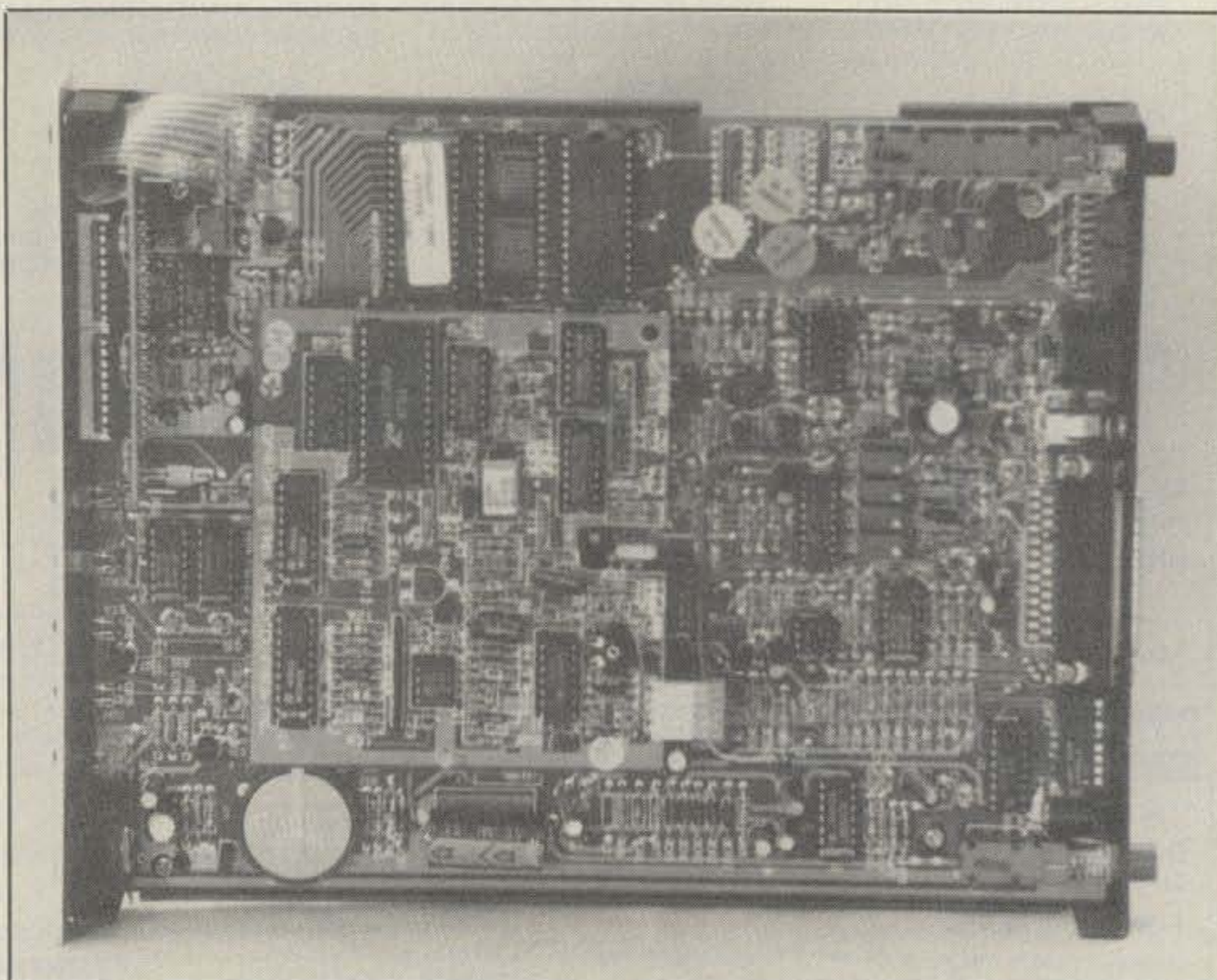

Interior view of the packet radio controller.

# MININEC \$35

MNjr 1.5 offers fast, powerful, inexpensive antenna analysis. MNjr models antennas in free space or over ground, uses 3-times faster FSS analysis, has automatic frequency sweep, simple definition of feeds and loads, and displays & prints standard ARRL polar plots. MNjr has everything you need for most antennas. 8087 and extra-fast no-8087 versions both included. MNjr 1.5, \$35. Full credit towards MN 3.5.

MN 3.5 is the fastest, most powerful, and most advanced MININEC program available. MN 3.5 displays 3-D views of antenna geometry & phasor wire currents, does sophisticated polar & rectangular plots of H, V, RCirc, LCirc, MaxLin, MinLin, & Max polarization components, uses up to 254 pulses for complex antennas, calculates near-fields for TVI & RF-hazard analysis, computes far-fields for repeater coverage, does current feed for phased arrays, has automatic frequency sweep, and simple definition of feeds & loads. 8087 or extra-fast no-8087 version. MN 3.5, \$85. 500-pulse option, \$25.

MN & MNjr are up to 10 times faster than standard MININEC implementations. Comprehensive antenna design library, easy-to-use full-screen editor, and extensive documentation included. Add 6.25% CA, \$5 overseas. U.S. check, cash, or money order. For IBM PC, 3.5" or 5.25" disk.

Brian Beezley, K6STI, 507-1/2 Taylor, Vista, CA 92084



## VHF COMMUNICATIONS

9:00 am - 5:30 pm  
weekdays

Weekends and evenings  
by appointment.

280 Tiffany Avenue  
Jamestown, New York 14701

Western New York's finest... amateur radio dealer!  
PH. (716) 664-6345  
(800) 752-8813 for orders only

### Six Function DTMF Controller



Auto-Kall  
AK-4

- Outputs: 2 or 3 latched, 1 or 2 momentary, 1 timed and 1 manually reset group-call latched for remote alarm
- Different codes for turning outputs on/off NOT toggle on/off like most others! • Wrong number reset
- 4-digit access code - can use \* up # down
- Multiple group-call response • On-board 1-amp relay

- AK-4K (board/kit).....\$69.95
- AK-4W (wired/tested board).....\$89.95
- AK-4C (Complete unit in metal enclosure with in/out jacks, built-in speaker, etc.).....\$139.95

Plus \$3.00 shipping & handling

### MoTron Electronics

310 Garfield St. • Suite 4  
Eugene, OR 97402

Call Toll Free 1-800-338-9058 or (503) 687-2118

FAX (503) 687-2492



CIRCLE 90 ON READER SERVICE CARD



### The Complete DX Tracking System for the IBM PC

DXLOG is used by serious DXers in more than 50 countries. Now version 1.5 has the features you asked for, and more!

- Produce checklists for Countries, Zones, and Russian oblasts, by band and mode.
- Automatic determination of Country, Zone, and Russian oblast by callsign.
- Complete DXCC & Russian oblast lists included. You can edit & add new ones!
- Print Logbooks, QSLs Needed Lists, Countries Needed Lists, QSL labels & more.
- Determine eligibility for DXCC, WAZ, Oblast awards & endorsements.
- Print completed forms for awards & endorsements. Just sign them!
- New QSL Label formats allow attractive layouts with popular cards.
- Import QSOs from the K1EA ConTest program, or print ConTest QSL labels!
- Print or display beam headings calculated from your QTH.
- Quick, easy, professional. No copy protection. Support hotline! Demo available!

Shouldn't you be using the leader in DX software?

Send a check for \$44.95 (DX add \$5.00 shipping), or \$5.00 for a functional DXLOG Demonstrator disk and manual. PA add \$2.40 tax. Include callsign.

PAYL Software  
P.O. Box 926  
Levittown, PA 19058-0926 USA  
(215) 945-4404

CIRCLE 37 ON READER SERVICE CARD

Say You Saw It In CQ

## Feeling Left Out?



Have your favorite communications (Police, Fire, etc) moved to the 800MHz band? Are the scanners available which access this band too expensive? If you are like many scanning enthusiasts, this can be a real dilemma. For those of you who are still in a futile search for 800 MHz coverage on your hand held scanning radio, GRE America, Inc. has a product for you. Introducing the newly developed **Super Converter™ II** which has all of the features that you have come to enjoy in our

**Super Converter™ 8001** (810 - 912 MHz coverage, etc.), and more.

The **Super Converter™ II** has a convenient switch which allows for an instant return to normal scanning frequencies without disconnecting the unit. It is also equipped with BNC connectors for easy adaptability to your handheld scanner.



Introducing the **Super Converter 8001™** from GRE America, Inc. The **Super Converter 8001™** once attached allows any UHF scanning or monitoring receiver to receive the 810 to 912 MHz band.

It has been our experience that most scanning radios suffer from a lack of sensitivity due to antenna and power limitations. Introducing the GRE **Super Amplifier™**. The **Super Amplifier™** is a compact pre-amp designed to work with scanners and it amplifies the reception of the VHF/UHF bands (from 100MHz to 1GHz) as high as 20db.

The **Super Amplifier™** has an adjustable gain which is controlled from the back of the unit and allows amplification level of up to 20db through all frequencies, equipped with a bypass switch to return to normal scanning frequencies. As with all other GRE products, you will find the quality and design of the **Super Amplifier™** to be of the highest standard.



Wide range frequency (up to 1GHz) antenna is exclusively available from GRE America, Inc.

For more information, or a dealer near you (new dealers are welcome), contact GRE America, Inc. at the address below.

## GRE America, Inc.



GRE America, Inc.  
425 Harbor Blvd.  
Belmont, California 94002

Telephone (415) 591-1400  
Outside CA: (800) 233-5973  
Fax: (415) 591-2001

CIRCLE 66 ON READER SERVICE CARD

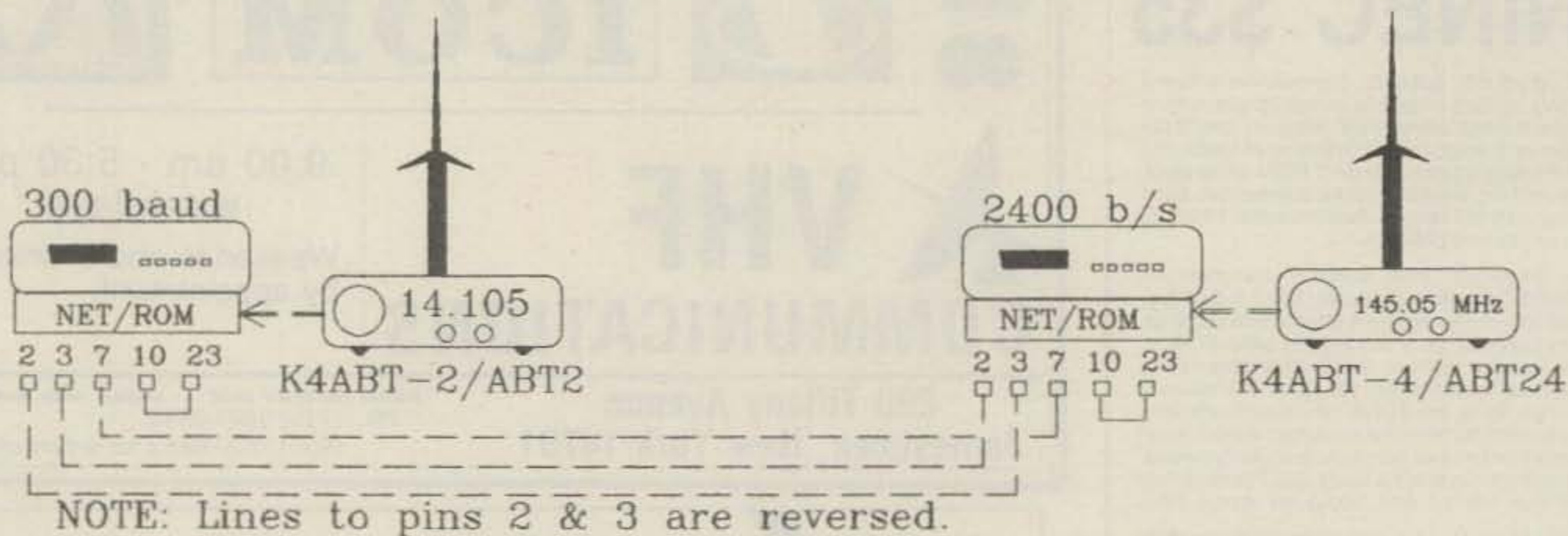

Fig. 1- Two meter to 20 meter gateway. The "jumper" mod in fig. 4 must also be included in these nodes.

In the turbo configuration this TNC offers everything the serious packeteer might need to operate the popular packet modes. The MFJ-1274/T is equipped with a built-in tuning indicator for HF (300

bauds) packet operation. The "mailbox" is a standard feature, and it is ready to operate 300, 1200, or 2400 bits-per-second (bps).

Phase Shift Keying (PSK) is the latest

trend-setter to come along. It lets us improve the speed and throughput of data without making any modifications to the transceivers. With the MFJ-1274/Turbo, we are able to connect it to the transceiv-

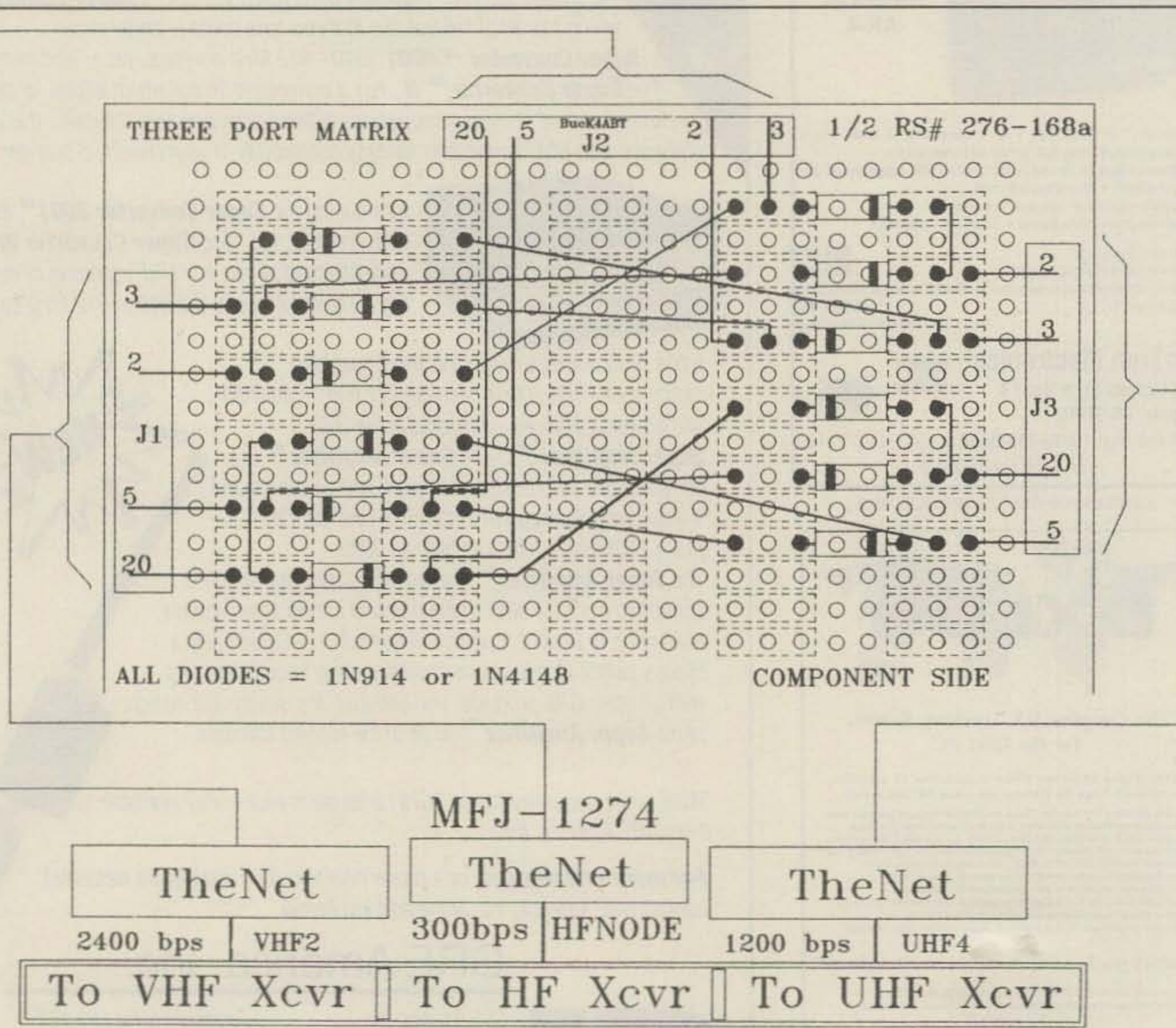

Fig. 2- Note the similarity between this VHF, UHF, and HF "cluster" gateway and the multi-frequency conference node in fig. 3. The same modifications apply to each cluster.

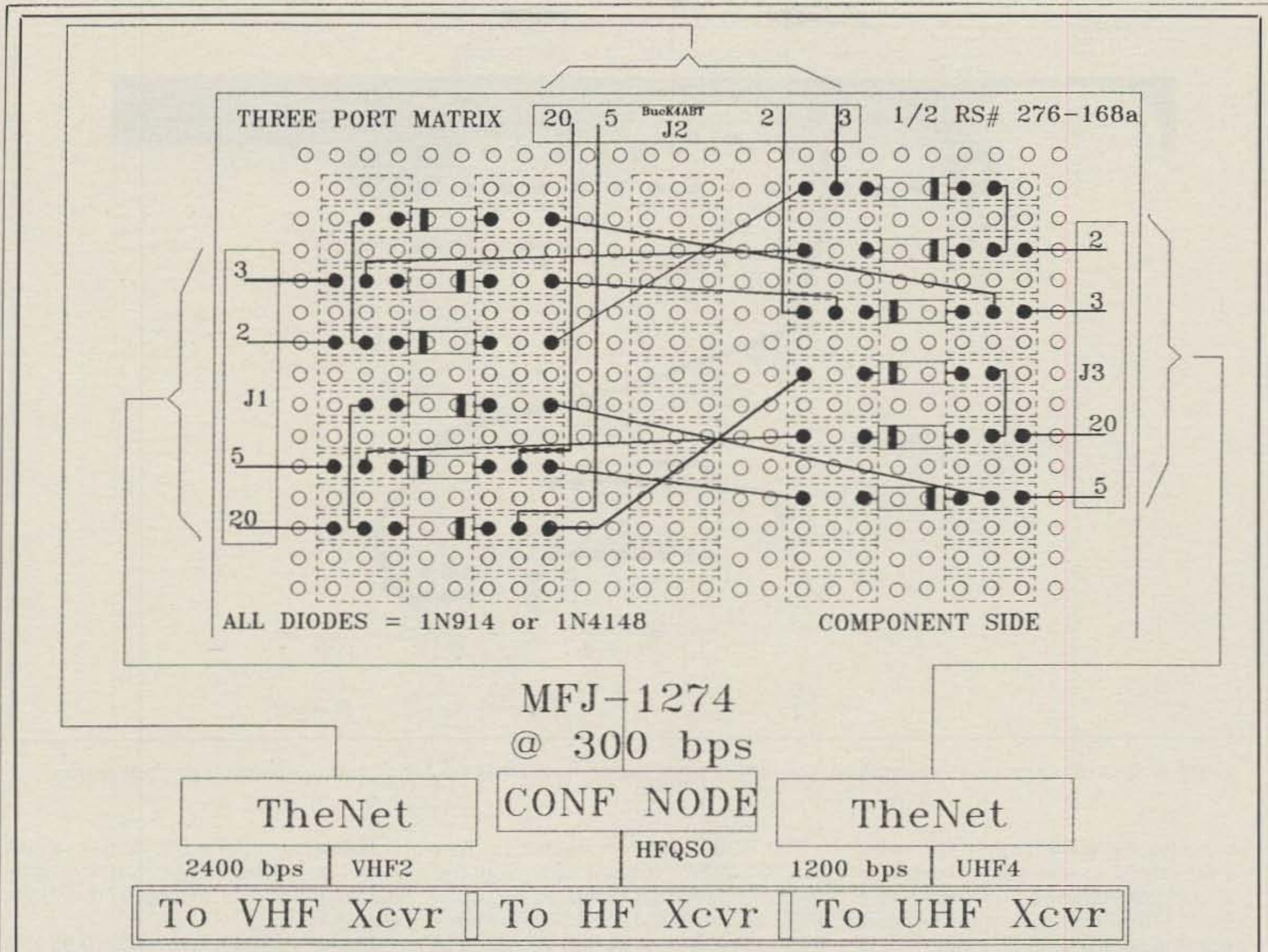

Fig. 3- This diode matrix enables access to the conference node direct and through VHF2 or UHF4. The "jumper" mode shown in fig. 4 must be installed in each of the TNCs. It is also necessary to add the jumpers between pins 10 and 23 of the individual DB25 connectors.

er mic input as we would any other TNC and operate an even higher speed of 2400 bps.

The MFJ-1274, or MFJ-1274/Turbo, is ideal as a node, switch, gateway port, conference node, or KISS mode controller. The latter is useful when used with some Bulletin Board Systems (BBS) software.

When operating the MFJ-1274 as a port to HF, it can be configured with any one of the three types of networking standards. At present, the ROSE switch seems to be the system that is gathering more support all across the US and in some countries outside the US. (See the article on the ROSE switch in this issue.)

In the illustrations that accompany this article I've included the gateway, node, conference switch, and ROSE switch configurations (both HF/VHF/UHF and 300/1200/2400 types). There are other ways to configure the MFJ-1274/T, but that would limit space for other articles about digital and data communications in this month's issue.

Fig. 1 is an illustration of the gateway

application for use with the VHF and UHF switches. Fig. 2 provides us with a means to communicate from VHF or UHF into the HF bands. Fig. 3 shows us how to make use of the MFJ-1274 in a conference node that is accessible from HF, VHF, or UHF. Here we are able to use one

conference node from two or even three bands. It is advisable to keep the access to the conference node away from busy or "through-put" frequencies.

When using the MFJ-1274 or MFJ-1274/Turbo in a cluster or complex that contains two or more MFJ-1274s that are

## AMATEUR RADIO EQUIPMENT

CALL **Comm Pute Inc.** **800-942-8873**

**For Your Best Price**

**Authorized dealer for Icom, Kenwood, Yaesu, ASTRON, Belden, Bencher, AEA, Cushcraft, MFJ, RF Concepts, Hustler, Kantronics, Wilson, Diamond, Ham-10, Larsen, Wm. M. Nye, B&W, ARRL, Ameritron, Epson, Farr Corner, DTK**

**1057 East 2100 South, Salt Lake City, UT 84106**

**801-467-8873**

CIRCLE 95 ON READER SERVICE CARD

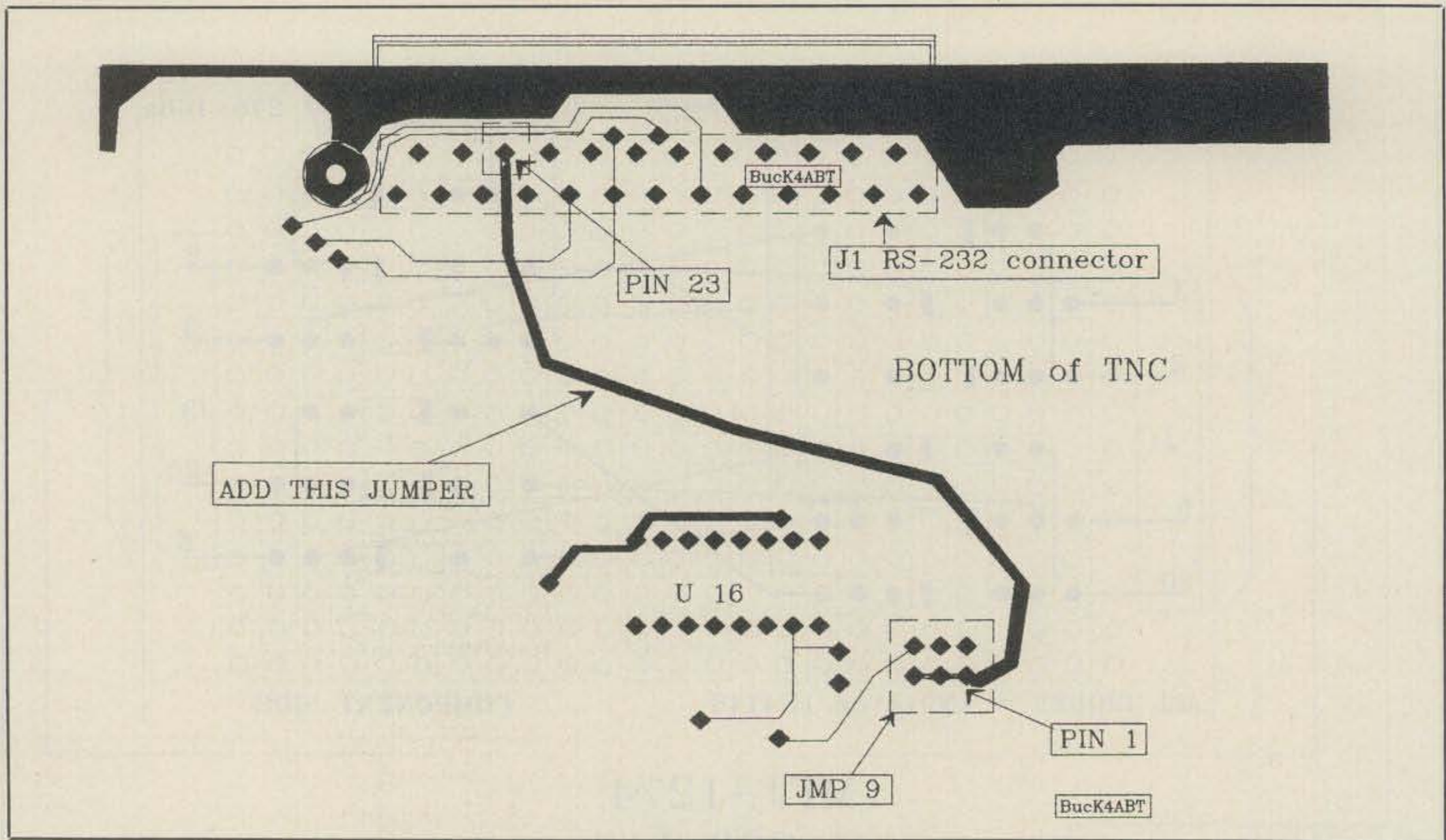

Fig. 4- This minor modification enables flow control when two or more TNCs are configured in a gateway or node cluster.

connected via the RS232 port, it is necessary to add the jumper shown in fig. 4.

Fig. 5 describes how we implement the MFJ-1274/Turbo as a part of a two-speed, single-frequency node and gateway. In this case, the gateway is from 1200 to 2400 bps, instead of the usual band-to-band gateway.

The ROSE switch is written by Tom Moulton, W2VY. It is available from the author by sending a formatted 360K 5 1/4 inch floppy disk and an SASE disk mailer with sufficient postage for the return to you. Send to Tom Moulton, W2VY, 4812 East Busch Blvd. #7, Tampa, FL 33617-4066.

TheNet is in the public domain, available from many BBSes. Net/Rom is a trademark of and available from Software 2000.

The MFJ 1274/T sells for \$229.95 and is available from MFJ Enterprises, Inc., Box 494, Mississippi State, MS 39762 (601-323-5869).

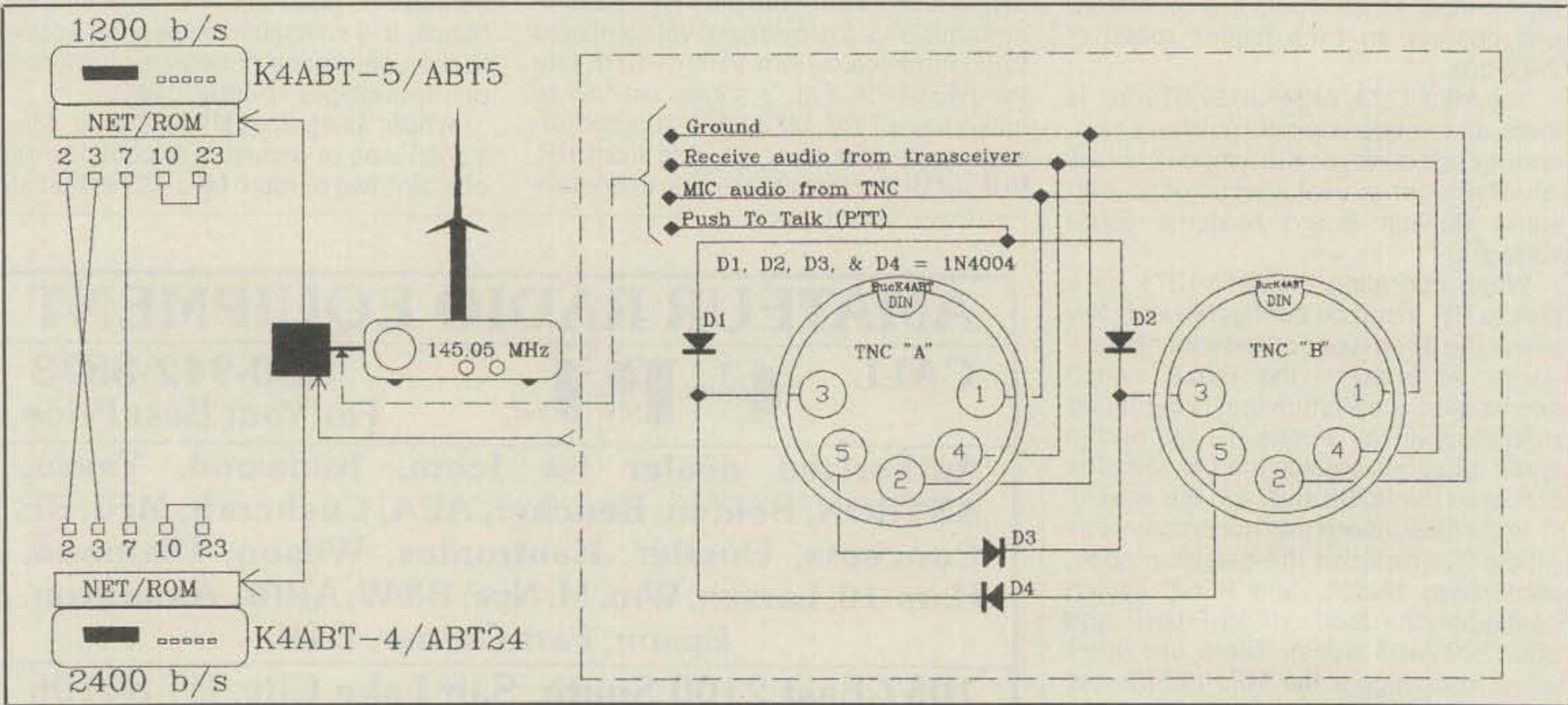

Fig. 5- This drawing describes the manner used to implement a dual-baud gateway. In this application either the MFJ-1270B/T or the MFJ-1274/T TNC may be used. Note: The diodes can be 1N4004 or 1N4005, silicon. If the ROSE code is used instead of NET/ROM, use the cable shown in the ROSE DOC file.



**Now, A Choice of Three Great Amplifiers— One is Ideal for Your Operating Interests!**

**NEW!**

# Centurion ... The Classic Kilowatt!

The Model 422 Centurion uses the classic pair of Eimac® 3-500Z tubes. The RF deck and power supply are combined into a single, attractively styled, desk top cabinet. The power output is rated at 1300 watts on ssb, 1000 watts cw and 650 watts using "key-down" modes. Drive required for full power ssb operation is 100 watts. The duty cycle is 50%.

Semi-break-in cw is achieved using a fast acting, non-vacuum, relay and the excellent QSK electronics used in the Hercules II. This system is also suitable for the fast switching digital modes. (For the "heavy duty" QSK cw operator, an accessory board is available incorporating a Jennings vacuum relay.) VOX ssb operation is silky smooth and virtually noiseless. This versatile control system assures compatibility with all exciters with amplifier control provisions.

A tube-axial fan is used for forced air cooling. Air flow is routed through the power supply as well as the upper and lower sections of the RF compartment. Air inlets and outlets are in the sides and top of the cabinet to optimize low pressure, low noise, air movement.

A dedicated meter for plate current, a multi-meter for plate voltage, grid current and forward or reflected power. A full time 10 element LED bargraph instantly displays peak power output.

The Centurion operates on all bands from 1.8 to 21.5 MHz. 21.5 to 29.7 MHz is enabled with the installation of an expansion board, supplied no-charge upon proof of licensed authority.

A tough, easy to handle, amplifier that doesn't really mind a little abuse. The Centurion is a great value.

## SPECIFICATIONS

**Band Coverage:** 1.8-2.0, 3.2-4.7, 6.5-10.3, 13.4-19.6, 17.6-21.5 MHz. 21.5-29.7 MHz after authorized modification.

**Input Power:** 2000 watts, maximum.

**Power Output:** 1300 watts ssb, 1000 watts cw. RTTY and SSTV 650 watts, 50% duty cycle.

**Drive Power:** 100 watts for full rated output.

**Efficiency:** 50-65%, depending on frequency and load impedance.

**Input/Output Impedances:** 50 Ohms, unbalanced. SWR <2:1.

**Distortion:** -35 dB from 1 kw rf output level.

**Harmonics:** -50 dB typical.

**CW Break-In:** QSK capable. Relay switching.

**Tube Compliment:** Two Eimac® 3-500Z.

**Power Amplifier Circuit:** Class AB2, grounded grid.

**Plate Voltage:** 3100 volts, no load. 2600 volts, full load.

**Cooling:** Forced air with full chassis air flow.

**Metering:** Dedicated plate current meter. Selectable multi-meter for plate voltage, grid current, forward or reflected power. Ten element LED bargraph display for peak power indication.

**Front Panel Status Indicators:** Standby, operate, transmit.

**Primary Power:** 220-250 Vac @ 15 A. 110-125 Vac @ 30 A, 50/60 Hz. For full power operation, 220-250 Vac is strongly recommended.

**Circuit Protection:** Primary line fuses. Plate transformer primary interlock and high voltage shorting bar.

**Front Panel Controls:** Power on/off, standby/operate, control mode select (QSK - PTT/VOX), plate TUNE and LOAD, band switch, meter switch.

**Tune and Load Controls:** 6:1 vernier drives with calibrated dial skirts.

**Construction:** Aluminum chassis, front and rear panels, interior partitions and top and bottom covers.

**Size:** HWS 8.25" x 15.25" x 18.5". (20.3 x 38.7 x 46.9 cm).

**Weight:** 47 lbs (21.3 kg).



**Hercules II  
Solid State,  
No Tuning!**

High tech simplicity, base or mobile. A compact, lightweight HF amplifier that offers a unique combination of virtues that can only be achieved using modern, solid state technology. Instant on, 12 - 14 Vdc operation, general coverage from 160 through 10 meters, no-tune operation and compact size. Add to that, lightning fast QSK cw, remote control, superb linearity and a low drive requirement. Outstanding!

The Hercules II is attractively styled to match our HF base station transceivers and will interface nicely with virtually all transceivers. The front panel includes an analog multi-meter for collector current, voltage, forward power and SWR. A ten element LED bargraph instantaneously displays peak power output. Band selection is either with the front panel switch or remotely via a rear panel connector. A front panel speaker is built in.

The internal heat sinks are air cooled by a temperature controlled tube axial fan. Whisper quiet in ssb operation, yet enough air capacity for cool operation in the key-down modes. The Hercules II is compact, good looking and generates a signal that is within one S-unit of the mighty Titan.

## MODEL 9420 115/230 VAC POWER SUPPLY



Housed in a separate utility enclosure and remotely controlled through the 6 foot power cable. 100 amperes at 13.7 Vdc is provided. 80 amperes for the amplifier and 20 amps for the exciter. An alternate power supply can be a heavy duty, deep cycle, lead acid battery and an automatic 10 amp charger. This low cost alternative power source will support the Hercules II during sustained amateur service.

**The Mighty  
Titan ... Simply  
Unbeatable!**



The Titan has it all! Maximum legal power with ease, all full power bands 160 through 15 meters (10 and 12 meters after authorized modification), lightning fast QSK for break-in cw and the digital modes and a two speed blower for quiet operation. This awesome performance from a desk top amplifier is made possible by the remote power supply and a pair of Eimac® 3CX800A7 ceramic triodes. The heart of the power supply is our own four core, tape wound Hypersil® transformer. This 41 lb behemoth is conservatively rated at 2.5 kVa CCS (9.2 kVa IVS) and is nearly noiseless, even at 1500 watts output!

Other features include a front panel, peak reading wattmeter using an instantaneous ten element LED bargraph display. PTT/VOX or QSK control line select switch, built-in SWR meter and an "over-drive" warning LED. 3:1 vernier TUNE and LOAD controls in combination with an outstanding RF deck design, make the Titan a real "pussy cat" to load and operate.

The Titan is styled to match our transceivers but it interfaces beautifully, no matter what exciter you are using. If you are ready to choose your dream amplifier, the Titan has it all! Check it out.

**...America's Best!**



Highway 411 East  
Sevierville, TN 37862, U.S.A.  
(615) 453-7172  
Fax: 615-428-4483  
Customer Service: 615-428-0364

# The 1991 CQ World-Wide 160 Meter DX Contest

**CW: January 25-27  
Starts: 2200 GMT Fri.**

**SSB: February 22-24  
Ends: 1600 GMT Sun.**

**H**ere is your chance to run up your state and country totals in a very short time. We can expect activity from all 50 states and over 100 countries on both CW and Phone. Pacific DX is encouraged to transmit 1907-1912 kHz and specify a listening frequency. WVE transmission there usually gets no answer and makes lots of enemies.

**Classes:** Single and multi-operator. Use of packet, a spotting net, or a logging assistant makes you multi-op. Use of a computer does not. Multi-ops show who was operating for each QSO.

**Exchange:** RS(T) and state for USA, area for Canada. DX stations send the prefix, or a country abbreviation. It's good insurance for those prefixes often confused by bad handwriting, such as OK/DK, OL/DL, etc. Stations omitting this information for non-multiplier QSOs will not receive credit for them.

**Scoring:** Contacts with stations in own country, 2 points. Contacts with stations in other countries in same continent, 5 points. Contacts with stations in other continents, 10 points. Maritime mobile points determined by location. All Canadian QSOs count 5 points for USA and vice versa.

If you persuade someone not usually on 160 to get on and work you, be sure to mention it in your log so you get credit for the "rare" call, if he doesn't work several others. Some public-spirited ops such as W2GD have considerably increased participation this way.

**Multiplier:** Each U.S. state (48), Canadian area (13), DX country, and maritime mobile. KH6 and KL7 are considered countries, but not also states. *No one may count USA or Canada as a country multiplier.* Canadian areas: VO1, VO2, NB, NS, PEI, VE2, VE3, VE4, VE5, VE6, VE7, NWT, Yukon. ARRL and WAE country lists and WAC boundaries are the standards.

**Final Score:** Total QSO points times the sum of all multipliers (States + VE areas + DX countries + Maritime mobiles).

**Penalties:** Three additional contacts may be deleted for each unacknowledged duplicate or unverifiable contact removed from the log. A second multiplier may be removed for each one lost by the above action.

**Disqualification:** You may be disqualified for violation of your country amateur radio regulations, unsportsmanlike conduct, or claiming excessive duplicate or false multiplier contacts. If the corrected score without penalties shrinks more than 3% from that claimed, disqualification will be considered.

**Awards:** Certificates to the top scorers in each class for each state, Canadian area, and DX country. In close races, also to runners-up. Also the following plaques with donating sponsors indicated.

	Single Operator	
	CW	SSB
World (N5JJ Memorial)	K5AAD	K5AAD
USA	K4TEA	K4JRB
Zone 3	KM4MG	N4ONI
Zone 4	K5NA	KC4MJ & KM4IH
Zone 5	WA4CUG	K4ODL
Europe	K4UEE	N4NX
Africa	K4SB	WB4ZNH
Oceania	K4TKM/6	K4DLI & KB4SSS
Asia	NE4S	W4LVM
South America	K4JAG	KL7JAR/4

	Multi-Operator	
World	N4RJ	Southeastern DX Club

Sample log and summary sheets may be obtained from CQ by sending a large SASE with sufficient postage to cover your request. You can make up your own, 40 contacts per page, columns for GMT, exchanges, multiplier, and points. Show the multiplier and its sequential number only the first time it is worked. Please don't write on the back of the pages. Dupe sheets are requested for logs over 200 QSOs. They should check the total QSO claim. Computer alphabetized sheets are especially welcome.

Include a summary sheet with your entry showing the scoring and other essential information. Include a printed name and mailing address, and a signed declaration that all rules have been observed. Mailing deadline for CW entries is February 28, and March 31 for the SSB section.

Send logs to 160 Meter Contest Director Donald McClenon, N4IN, 3075 Florida Avenue, Melbourne, FL 32904 USA. They may also be sent to CQ 160 Meter Contest, 76 North Broadway, Hicksville, NY 11801. Please indicate CW or SSB on the envelope.



**ALPHA 87A MONEY-BACK  
GUARANTEE: THE "CATCH" IS,  
YOU'LL NEVER GIVE IT UP**

I've had an ALPHA 87A on the air for six months and it outclasses in all respects every other amplifier I've used. Nothing else is even close. Use it and you truly will wonder how you ever got along without it.

**POWER** matches the famed ALPHA 77dx. A brute 45 pound tape-wound Hipersil® transformer . . . full wave bridge rectifier . . . 50 mike filter.

**CONVENIENCE IS INCREDIBLE.** A rare one shows up on another band: *as you call him* your '87A automatically changes bands and tunes up, reaching full power in just about one second. With any transceiver and no special cable or hookup. It's impossible to make a bandswitching mistake.

**DELIVERS FULL POWER INTO 2:1 SWR** without a tuner; just tweak tuning exactly the way you want it—once for each band/segment. Your '87A never forgets after that.

**TUBE & AMPLIFIER PROTECTION IS FULLY AUTOMATIC . . .** including grid and plate overcurrent, overdrive, RF flashover and load VSWR trips plus step-start turn-on and filament inrush current limiting. It will take determination to damage an ALPHA 87A or its tubes. That's why it carries *the only four year limited warranty in ham radio.*

**DX MAGAZINE'S** August issue presented WX7K's (paraphrased) "casual survey . . . of 35 big gun . . . truly outstanding . . . 40M signals . . . that commanded the frequency . . . especially in pileups . . ." Results: "About 50% of amplifiers were an ALPHA model."

And the new ALPHA 87A is the best ALPHA yet!

73,



*Dick Ehrhorn*

Dick Ehrhorn  
W4ETO



# New ALPHAs, New Standards of Excellence

- \* Maximum legal power, no time limit, all modes
- \* **ALPHA 87A** — Fully automatic bandchange in one second
- \* **ALPHA 86A** — Same great HF amplifier, manually tuned



Contact Ray Heaton or Alysa Drew for detailed information.

**ALPHA:** Twenty years' unchallenged leadership in RF power

**ETO EHRHORN TECHNOLOGICAL OPERATIONS, INC.**  
4975 North 30th Street ■ Colorado Springs, Colorado 80919 ■ (719) 260-1191 ■ FAX (719) 260-1106

CIRCLE 83 ON READER SERVICE CARD

# ANTENNAS & ACCESSORIES

A LOOK AT THE SHACK FROM BOTH ENDS OF THE COAX

BY KARL T. THURBER, JR., W8FX

## Antennas and Attics—Do They Mix?

**T**his month we'll discuss HF attic antennas, drawing on the extensive resources of Bill Fanckboner, W9INN, the man behind W9INN Antennas. We'll also briefly run through some new antennas and antenna products. We'll round out the column with some software notes on HAM-TIME, DXdB, and Quorum, as well as some update information on Logger, Morseman Plus, and one of our very favorite utilities, PC Tools Deluxe™ Version 6. Let's begin by dusting off some of the cobwebs in the attic.

### Antennas and Attics

Very frequently we're asked questions about using indoor HF antennas when it's difficult or impossible to erect an outdoor flattop for some reason. First, to make one thing "perfectly clear," it's always better to install an antenna outdoors, regardless of what claims may have been advanced for an antenna's performance indoors.

You can often get away with an indoor antenna for receiving. However, you may never know the *real* differences between antenna performance indoors and outdoors, differences and complications that turn up when the antenna is used to transmit. Still, many operators must consider using an attic antenna for transmitting due to partial or complete restrictions against outside antennas, if they are to get on the air with any kind of a creditable signal.

Bill Fanckboner, W9INN, is a longtime wire-antenna experimenter and designer, and he's corresponded with us several times about antenna design and philosophy. Bill is especially mindful of the problems many amateurs have in working with attic-mounted antennas. He tells me that his best-selling antenna is his MPD-5C, an 87 foot long 80-10 meter "no traps" coax-fed dipole. Some of these skyhooks have gone into the attics of multiple-unit condominiums, which often are 100 feet long. Another popular antenna is his five-band (80-10 meter) SSD-5-42' 42 foot dipole, many of which have gone into smaller attics.

Any comparison of an equivalent attic antenna with a similar one installed outdoors is highly subjective. But Bill's experience (and that of many of his customers) tells him that a shortened HF attic antenna tends to be "down" about 1½ to 2 S-units, or 9 to 12 dB, when compared to a full-size outdoor antenna at the same height. Many factors account for this difference, such as the presence of nearby conduit, ducts, and plumbing, as well as the type of roofing shingles used. Bill notes that common asphalt shingles are slightly conductive. Thus, they can affect both antenna reso-

nant frequency and the overall performance of an antenna installed in an attic.

As Bill notes in one of the "fact sheets" he sends out along with his antenna catalog, locating an antenna—especially a multiband antenna—in an attic can be tricky. This is because it's difficult to compensate for the antenna's exact surroundings, its environment. All of the building's conductors are coupled to the antenna to a greater or lesser extent. This coupling causes a change in the resonant frequency, which is usually lower than the same antenna hung in the clear. However, it isn't necessary that the antenna be exactly resonant on all of the desired frequencies, as a wide-range tuner can be used to provide a match that the transmitter will accept.

When hanging the attic antenna, keep it as clear of "things" as possible. Run it a couple of feet below the roof, because of the effects of the slightly conductive asphalt shingles. Also, keep the end sections at least a foot or two from walls, the ceiling, and the floor. If you need to bend the antenna slightly to keep it clear of obstructions, you can use Dacron line to do so, as it is an excellent insulator. Tie it directly to small loops in the antenna element: make small loops ½ inch in diameter, twisting the wire a turn or two.

After you've hung the antenna, determine the antenna's resonant frequency on each band. This normally will be the frequency at which the minimum SWR occurs. Check the SWR every 10-20 kHz across the entire band. Write down the frequency at which minimum SWR occurs on each band. If it's a multiband antenna, repeat the process for each band you'll be using.

It's possible that the antenna's resonant frequency will be out of the band. You can use an antenna noise bridge or similar accessory to find the resonant frequency. Once you've determined where the antenna is resonant, you can adjust each band's point of resonance using whatever technique is appropriate to the particular antenna: adjusting impedance matching stubs, end stubs, traps, wire element length, etc.

Bill suggests starting adjustments with the highest band first: if that's 10 meters, start with it. He notes that there is a great deal of coupling between bands. He's found the greatest coupling effects to occur on the bands adjacent to (on either side of) the band being changed. For example, a change in the 40 meter resonant frequency will mostly affect 20 and 80 meters.

As a practical matter, with most coax-fed HF wire antennas you can often use a tuner to avoid making any adjustments to the antenna itself, as long as resonance is somewhere in the band. However, since the 80 meter band is so broad, and the antenna bandwidth typically is very narrow, you should adjust resonance on this band to within 50 kHz of the desired fre-

quency before resorting to using the tuner.

If you feed the attic dipole with ladderline or other parallel conductor feedline, you must use a tuner. However, in most cases you probably can just hang the antenna and operate. If you want to make resonant frequency adjustments, one way to do so is to **temporarily** attach a 50-75 ohm transmission line to the antenna and make adjustments with the tuner out of the circuit. Then attach the ladder line after you've completed adjustments using the temporary coax feedline.

Bottom line: If you have a little patience, you'll likely find that an attic antenna can "work out" surprisingly well. And a tip of the hat to W9INN for sharing his thoughts on HF attic antenna installation with us!

### Antenna Shorts

**Tice Flagpole Vertical.** Sometimes an outdoor wire antenna or a tower-mounted beam is out of the question. Either there isn't sufficient room, or the antenna would be an eyesore if installed in the only place there is room for it. And as most of us know, many cities, developments, condominiums, and apartments restrict antenna placement. One solution to the operating problem is the attic antenna, but there are others.

On more than one occasion a reader has sent us a snapshot and description of his personal solution to the "no antennas allowed" rule. Many amateurs find they can get on HF by patriotically disguising their vertical antenna as a flagpole. The idea is to make the antenna look as much like a flagpole as possible.

The first commercial HF flagpole antenna I've seen is the Tice Electronics FP3V Flagpole Vertical, a small, three-band (10, 15, and 20 meter), 10 foot trap antenna designed to fit almost anywhere. The active part of the 8 lb. antenna is copper wire, while the supporting structure is sunlight-resistant electrical-grade PVC plastic that folds in half for portability. The helical loading circuits are enclosed to be weatherproof. Installation consists of digging the included mounting post in the yard, unfolding and securing the two portions of the antenna, and placing it on the mounting post. The antenna requires a ground rod and/or radials.

The Tice antenna is fed with 50 ohm coax and can handle 200 watts. SWR is claimed to be less than 1.4:1 at resonance, and is typically 1.2:1 or less. All of 15 and 20 meters are covered, while bandwidth on 10 meters is 600 kHz. The FP3V triband model is priced at \$59.95. There's also the similar FP4V; it covers 40 meters as well and is 15 feet tall with a capacity hat. Its price is \$98. The instruction manuals, accessories, and even a US flag are available separately.

For information contact Patrick W. Tice,

317 Poplar Drive, Millbrook, AL 36054

# All-day power for your H-T!

Actual size.  
7" deep.

## INTRODUCING THE QUANTUM HAM BATTERY

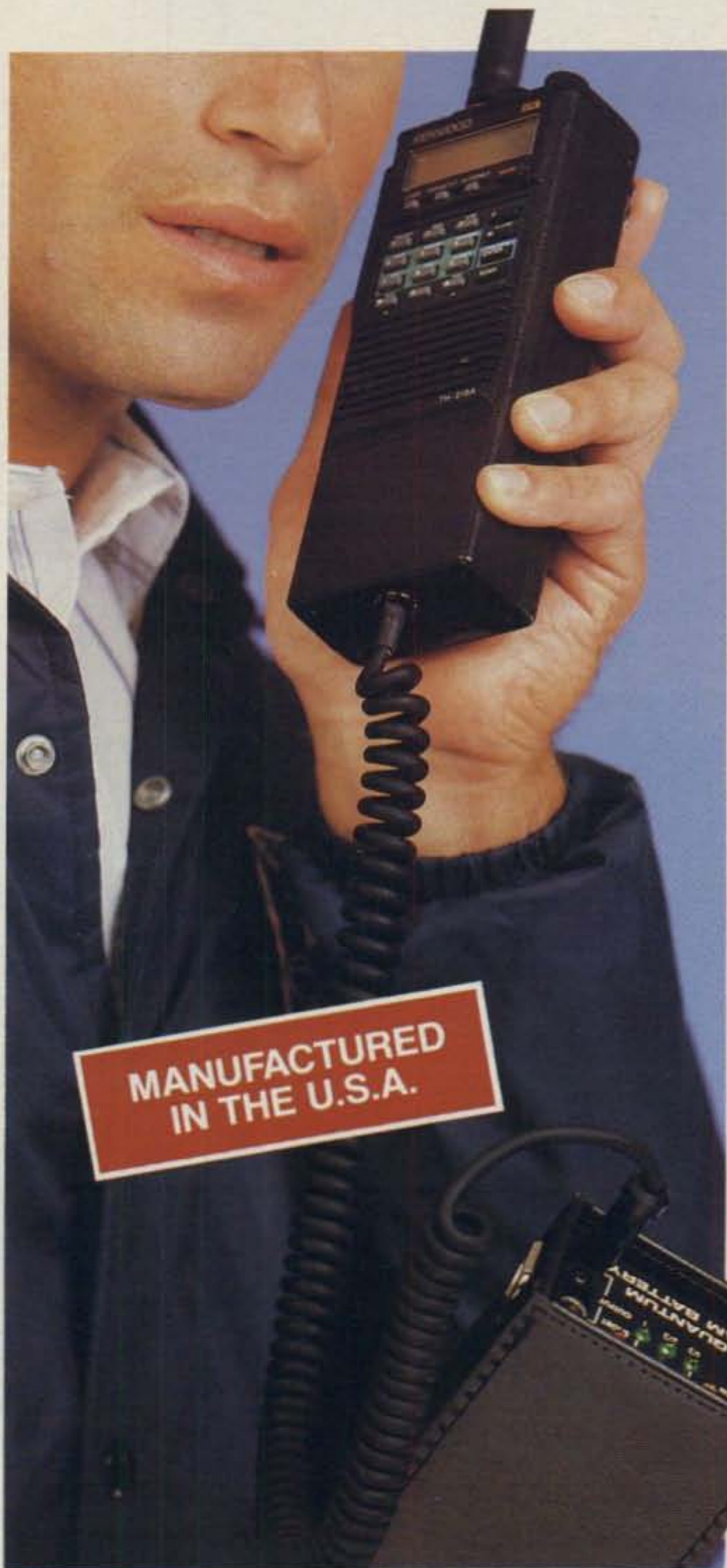

Finally ... a power source that keeps up with today's higher powered handi-talkies. The *Quantum Ham Battery* packs 25 watt-hours ... typically six times the power of nicad packs ... enough for intensive all-day 5 watt operation.

The battery's status is continuously monitored and displayed by three LED's ... you'll always know how much power remains. And it's powered by sealed lead cells which maintain a charge for months without the "memory" problems of nicads.

Remove the heavy battery pack from your H-T. Clip the slim shock-proof *Quantum Ham Battery* to your belt or shoulder strap, and hook it up to your H-T with an Adapter Cable.

Now, for those long QSO's, your handi-talkie is feather-light. And you don't have to lug spare batteries ... the *Quantum Ham Battery* takes the place of as many as six nicad packs.

**MAIL OR PHONE (516-222-0611) YOUR ORDER TODAY.**  
VISA/MasterCard accepted. *UPS Delivery included.*  
NY State Residents please add applicable sales tax.



<b>QUANTUM HAM BATTERY</b> Including power pack, charger, instructions .....	\$125.00
<b>ADAPTERS TO FIT HANDI-TALKIE MODELS LISTED:</b>	
HB3, fits: ICOM "S" series (e.g. IC-2ST) and IC-24 .....	\$ 28.00
HB4, fits: ICOM "A" & "G" series (e.g. IC-2A, 3AT, 04AT, 12GAT, etc.) .....	\$ 28.00
HB5, fits: Kenwood TH-205AT, -215AT, -315AT, -415AT .....	\$ 30.00
HB6, fits: Kenwood TH-25AT, -45AT .....	\$ 30.00
HB9, fits: Yaesu FT-23R, -33R, -411, -470, -73R, -811 .....	\$ 28.00
HB0, (coiled power cord) .....	\$ 15.00
Connects to Quantum Ham Battery only, with unconnected leads for adapting to any 12-volt H-T. Requires an empty battery case that fits your H-T, plus drilling and soldering.	

<b>Warranty:</b>	1 year, limited
<b>Power:</b>	12 volt, 2.1 amp-hours (25 watt-hours)
<b>Size/weight:</b>	7 x 3 x 1 3/4" / 36 oz.
<b>Outputs:</b>	Two available for simultaneous operation.
<b>Charging:</b>	115V AC regulated charger included. Charging light.
<b>Output protection:</b>	Automatic resetting circuit breaker. Indicator lights when tripped.
<b>Temperature range:</b>	-40° to 122°F (-40° to 50°C)
<b>No. recharges:</b>	250-1000 depending upon depth of discharge.
<b>Cell replacement:</b>	Available. Check factory or dealer.

**DEALER INQUIRIES INVITED**

QUANTUM INSTRUMENTS INC., (516) 222-0611 • FAX: (516) 222-0569 • 1075 Stewart Ave., Garden City, NY 11530

CIRCLE 71 ON READER SERVICE CARD

# hy-gain®

## NO.1 FOR PACKET & FM

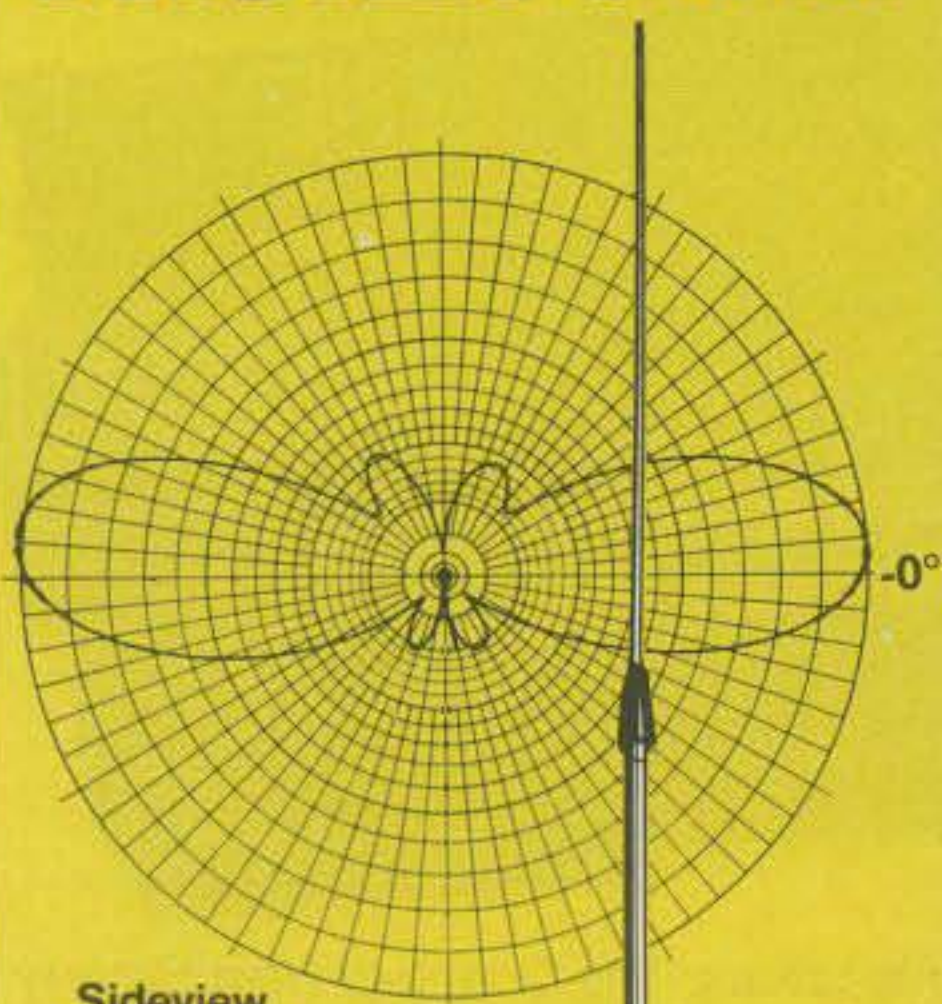

Sideview

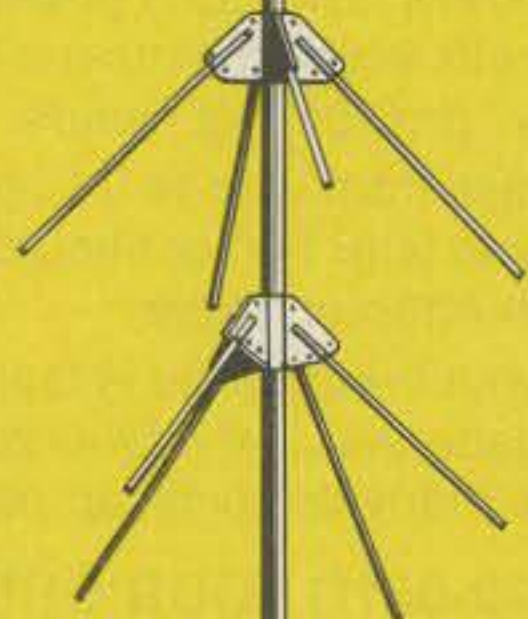

Model **V4** 420-470 MHz\*

Model **V3** 220-225 MHz

Model **V2** 138-174 MHz\*

- Maximum feedline decoupling eliminates computer lock-up and rf feedback
- Low vertical radiation angle allows maximum distance
- Rugged construction and stainless steel hardware withstand severe environmental conditions
- 120 mph (190 km/hr) wind survival

For detailed information, write to Telex/Hy-Gain, RF Consumer Department, 9600 Aldrich Avenue South, Minneapolis, MN 55420, or call 612-887-5528.

\*Charts included for pre-tuning to an exact frequency for amateur or commercial applications.

© 1990 Telex Communications, Inc.

# TELEX®

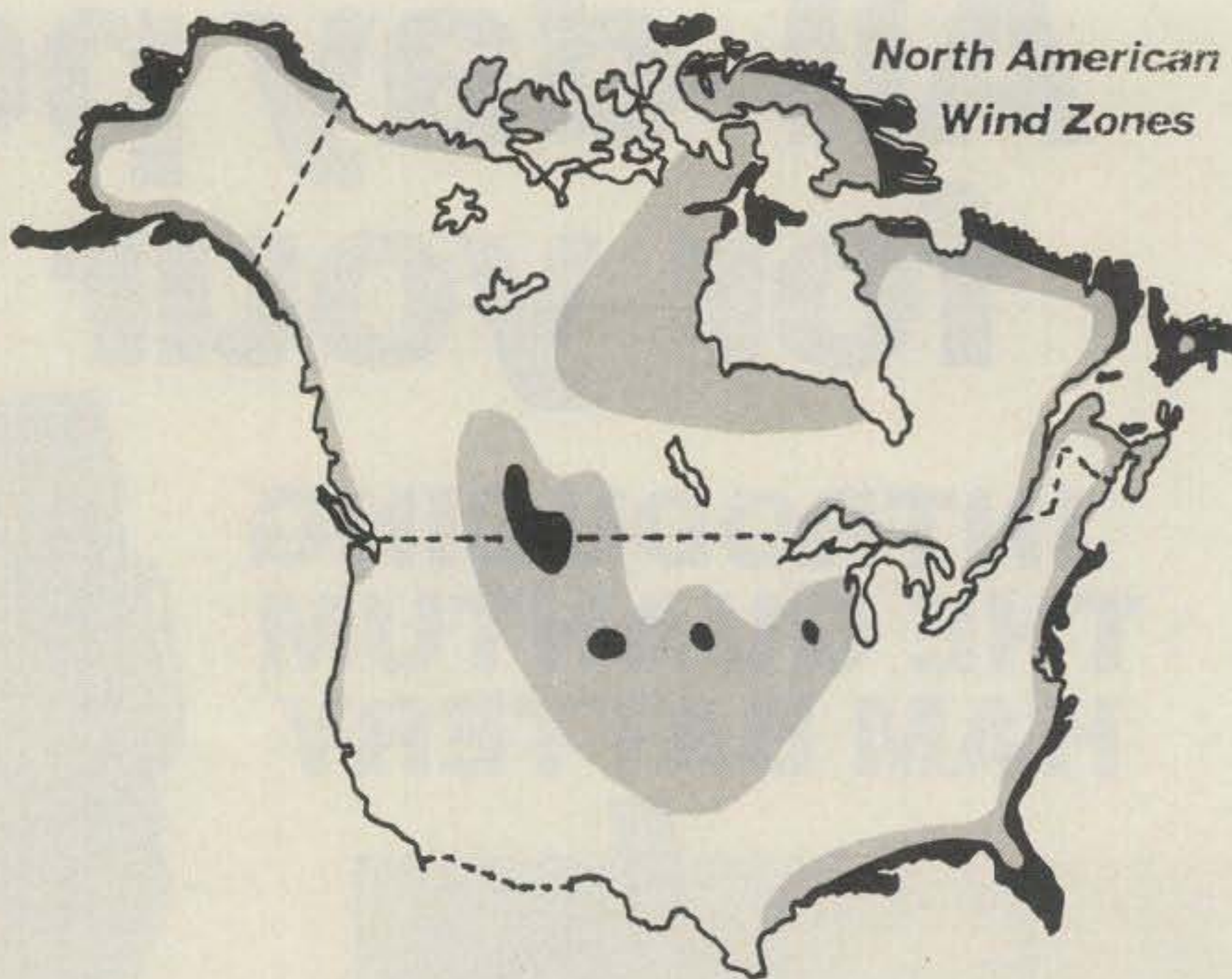

Fig. 1- Here's a synoptic sketch of North American wind zones. It shows the normal maximum wind velocities you should consider in tower selection. The solid areas are 100 MPH, the shaded areas 85 MPH, and the clear areas 70 MPH. Like other tower manufacturers, Trylon provides a chart using this information and the surface area of your load to help you determine the wind thrust value at the top of the proposed tower. This enables you to select the most appropriate tower for your area. (From Trylon tower literature)

WAØTDA, Tice Electronics Company, 933 W. St. Croix Ave., Stillwater, MN 55082.

**Rutland Arrays Yagis.** This Pennsylvania manufacturer specializes in K1FO-style Yagis covering 144 through 440 MHz. They offer eight models designed for 144, 220, 222, 432, and 440 MHz operation in their latest spec

sheets. The company also offers 2-, 4-, 6-, and 8-port power dividers covering 144-148, 220-230, and 430-450 MHz, as well as stacking frames to stack 4, 6, or 8 K1FO-type Yagis.

A particularly interesting addition to the product lineup is the RA8-2UWB, an 8-element 2 meter "ultra wideband array" that is espe-



Fig. 2- Shown here is the HAM-TIME Main Clock Menu. It displays the local and GMT time, along with the correct date for each. The major function keys are shown at the bottom of the screen. You also can access three additional menus from this menu: the Event Timer, Lap Timer, and Time Zones Menus. (Screen display courtesy ECode Systems, Inc.)

cially intended for use with 2 meter all-mode transceivers. The array's length is 11 feet 9 inches, and it sports a claimed gain of 13.3 dBi. The operating bandwidth is greater than 4 MHz. Front-to-back (F/B) ratio is 22 dB and maximum power-handling capability is 400 watts.

For spec sheets and pricing contact Rutland Arrays, 1703 Warren St., New Cumberland, PA 17070.

**Trylon Titan Towers.** Information received from Bert Martin, Sales Manager, Trylon Towers, says the company has introduced what they call their "second generation tower system," the Titan™ line. The Titans replace the Trylon ABC towers and are designed for very heavy-duty operation. They may be self-supported or guyed. The towers boast a newly designed base and lower section for improved stability.

The Titan towers are available in kit form or factory assembled 8 foot sections that allow you to match your height and load requirements to the prevailing weather conditions. The towers are engineered to handle top-mount loads of up to 300 lbs. Seven different models are available to handle various load surface areas and maximum wind strengths, which combine to form an overall "wind thrust value." In its tower literature Trylon provides an easy-to-use chart for determining the proper tower model to take into account these factors. Towers are available to handle wind thrust values from 200 to 1300 lbs. The towers are priced according to height and strength, ranging from a 16 foot T200 that runs \$380 list, up to a 96 foot bruiser that goes for \$2425.

The kits are shipped FOB Buffalo, New York and are complete with splice bolts, top mount plates, clamping brackets, and stub legs. You can erect the towers using a crane or boom truck (the most efficient method) or by using a Gin Pole. Trylon also offers anti-climb shields, mast bearings, ground kits, base foot "weldments" (for attaching the tower to flat roofs or concrete), grounding and lighting kits, antenna mounting pipes, light-fixture supports, and antenna side-mount kits.

For more information, contact Trylon Manufacturing Co., Ltd., P.O. Box 186, Elmira, Ontario N3B 2Z6, Canada.

Fig. 1 shows a North American Wind Zone Chart, as included in Trylon's literature.

**Cushcraft WARC Band Dipole.** The WARC bands are relatively new, and there seems to be a real lack of commercial antennas that recognize the bands' existence. Cushcraft has taken a step in filling this void with its D3W rotatable dipole which covers the 12, 17, and 30 meter bands.

The new antenna is a trapped tubular aluminum dipole. It physically resembles the driven element of a tri-band beam, though of course it lacks the directivity of the beam. The antenna is designed to cover all three bands with an SWR of 2:1 or less, with SWR at resonance 1.5:1. The antenna has a mast diameter of 2 inches and a length of 34 feet. It weighs in at 11 lbs., so you can turn it with a TV-type rotator. It features all stainless-steel hardware and rugged construction. Price class is about \$200.

For specs contact Cushcraft Corp., 48 Perimeter Rd., Box 4680, Manchester, NH 03108.

**TCE Labs Filters.** TCE Labs offers three types of filters for amateur use: cable TV, telephone, and AC line. The Type BX Cable TV Filter is intended to eliminate interference from TV set overload as a result of close proximity of



**YAESU**  
replacement batteries

ALL SUPPLIED WITH WALL/DC



**KENWOOD**  
replacement batteries



**ICOM**  
replacement batteries



### Professional Quality at Amateur Prices

Don't spend a fortune replacing your hand-held's battery.

Alexander Batteries give you the same professional quality as OEM replacements, at a lower cost.

Color, fit and texture compatibility are exact and Alexander guarantees to meet or exceed OEM specifications.

Put the power of Alexander Batteries to work for you.



P.O. Box 1508, Mason City, IA 50401

Tel: 515-423-8955 or 1-800-247-1821  
FAX: 515-423-1644

CIRCLE 82 ON READER SERVICE CARD

Made in the USA

ICOM

IC-781 HF Transceiver



# THE FUTURE OF AMATEUR COMMUNICATIONS

Once in a lifetime, a transceiver is introduced that's so extraordinary and innovative that it opens a totally new era in HF communications. ICOM's pacesetter IC-781 proudly exhibits that hallmark achievement with futuristic designs and features of true legendary proportions. Whether DX'ing, contesting, pioneering new interests or enjoying unquestionable top-of-the-line performance, the IC-781 is indeed today's standard of excellence!

**Multi-Function Five Inch CRT.** Displays frequencies, modes, memory contents, operating notes, RIT, two menu screens, plus a panoramic view of all signals in a selected range. A portion of the screen also serves as a display for data modes like RTTY, AMTOR, and PACKET.



**Unique Spectrum Scope.** Continuously indicates all signal activities and DX pileups with your operating frequency in the center. Selectable horizontal frequency spans of 50,

100, and 200KHz for each side of the frequency you're listening to. Vertical range indicates relative signal strengths. A contesteer's dream!



**Dual Width Noise Blanker** includes MCF filter plus level and width controls to eliminate pulse and woodpecker noise with minimum adjacent-signal interference.

**Incomparable Filter Flexibility.** Independent selection of wide and narrow SSB filters plus CW filters. Second and third CW IF filters are independently selectable!

**Dual Watch.** Simultaneously receives two frequencies in the same band! Balance control adjusts VFO A/B receive strength levels. You can check additional band activity, even tune in your next contact, while in QSO without missing a single word!

**DX Rated!** 150 watts of exceptionally clean RF output. Easily drives big amplifiers to maximum power.

**Twin Passband Tuning with separate controls for second and third IF stages!** Increases selectivity and narrows bandwidth, independently varies low and high frequency response, or functions as IF shift. It's DX'ing Dynamite!

**A Total Communications System!** Includes built-in 100% duty AC supply, high speed automatic antenna tuner, iambic keyer, semi-automatic or full QSK CW break-in to 60 wpm, Audio Peaking Filter (APF), RF speech processor, multiscanning, 105dB dynamic range, all-band/all-mode receiver with general coverage, and much more!

**ICOM Dependability.** The phenomenal IC-781 is built for action and backed with the most extensive warranty in the industry.

See the IC-781 at your local ICOM dealer.

CIRCLE 7 ON READER SERVICE CARD



# ICOM

First in Communications

ICOM America, Inc., 2380 116th Avenue N.E., Bellevue, WA 98004  
Customer Service Hotline (206) 454-7619  
3150 Premier Drive, Suite 126, Irving, TX 75063  
1777 Phoenix Parkway, Suite 201, Atlanta, GA 30349  
ICOM CANADA, A Division of ICOM America, Inc.,  
3071 - #5 Road, Unit 9, Richmond, B.C. V6X 2T4  
All stated specifications subject to change without notice or obligation.  
All ICOM radios significantly exceed FCC regulations limiting spurious emissions. 781188.

# BREAKING THE BARRIER OF DUAL BAND COMMUNICATION



The dual banders of the future are here! ICOM's IC-24AT dual band handheld and IC-3220 dual band mobile provide you all the advantages with the most feature packed, power packed dual banders available.

Whether your needs require the mobility of the IC-3220 or the convenience of the IC-24AT mini-handheld, ICOM has the dual bander fit for you.

The IC-24AT mini-handheld and the IC-3220 mobile give you full operation on the 2-meter and 440MHz

amateur bands with outstanding flexibility and performance!

The IC-24AT offers 40 memories, 5 watts, programmable scanning, priority watch, a battery saver, plus a DTMF pad for autopatching...the list is endless. Among the many features

of the compact IC-3220 are a built-in duplexer, simultaneous dual band receive, auto dialing and a memory transfer function. For full details and specs on the IC-24AT and IC-3220, call the **ICOM Brochure hotline at 1-800-999-9877**. See them today at your quality ICOM amateur dealer.

  
**ICOM**  
First in Communications

CORPORATE HEADQUARTERS: ICOM America, Inc.  
2380-116th Ave. N.E., Bellevue, WA 98004  
CUSTOMER SERVICE HOTLINE (206) 454-7619  
CUSTOMER SERVICE CENTERS:  
3150 Premier Drive, Suite 126, Irving, TX 75063  
1777 Phoenix Parkway, Suite 201, Atlanta, GA 30349  
3071 - #5 Road, Unit 9, Richmond, B.C. V6X 2T4 Canada  
2380-116th Ave. N.E., Bellevue, WA 98004

All stated specifications are subject to change without notice or obligation. All ICOM radios significantly exceed FCC regulations limiting spurious emissions. 3220990

CIRCLE 72 ON READER SERVICE CARD

HF transmitting equipment. A high-pass filter, it attaches directly to the coax input connector of the VCR or TV set and uses industry standard F-type connectors. It's priced at \$24.95.

TCE Labs also offers two other filters. One is the TP-12 Telephone Filter, said to offer highly effective suppression of RFI from SSB transmitters in standard telephones. The filter has a standard telephone jack and plug so it can be installed either at the wall outlet or (preferably) at the telephone instrument's base plug. It's \$18.95.

A third filter is the KW-1 AC Line Filter, a commercial-quality filter said to provide an attenuation ratio of 8000:1 of RF in AC lines. The 2 lb. filter has two three-wire standard AC line sockets for plugging in amateur equipment, a TV, VCR, or other AC line sensitive equipment drawing up to 1000 watts. The filter also eliminates most types of noise and hash generated by electrical machinery. Its price is \$42.95.

For more information contact TCE Labs, 5818 Sun Ridge, San Antonio, TX 78247.

## Software Topix

**HAM-TIME.** The June issue of *Popular Electronics* featured an interesting hands-on review of the ECode Systems' HAM-TIME software, and I was intrigued by it. A letter to ECode Systems' Robert W. Ellis, WB9JBI, brought me an evaluation copy.

HAM-TIME is a digital clock simulator or "large format clock program" for the IBM PC. The program is especially for those who use GMT. It provides a convenient way to keep track of time without constantly making conversions between local time and GMT. While of greatest interest to amateurs and SWLs, outside of the hamshack the program's counters and timers are also useful for lab or hobby-room use.

Some of the program's main features include a local/GMT time dual display, as shown in fig. 2; a digital alarm clock; a snooze alarm; 12 or 24 hour mode; a time-remaining event count-down timer; an audible time indicator; and a handy sports lap timer. The large, near-screen-filling display makes it easy to read the time even from across a room.

There are two special displays. One of these is the Time Zone Display, which provides a quick way to check the time across the country. A second is the Cities Around the World display. This display gives you a way to keep track of time in any area of interest. You can customize this display by preparing a text file to replace the preset city names with other city names or even callsign prefixes from that area.

I found the program to be very well done, with the combination function key and menu format easy to use. The fact that you can install HAM-TIME on a laptop computer opens up many portable and on-the-road possibilities, too. The program is intuitive in its operation, and the accompanying manual is concise and brief. However, I would like to see a resident pop-up version of the program that one could hot-key into from another program, such as a logging or contesting program, if possible.

HAM-TIME is available for the IBM PC and compatibles having at least 128K memory. You need a CGA- or EGA-compatible display screen. A speaker and a real-time clock in your PC are desirable. The program is \$24.95 and is available from ECode Systems, Inc., 335 West Virginia, Phoenix, AZ 85003.

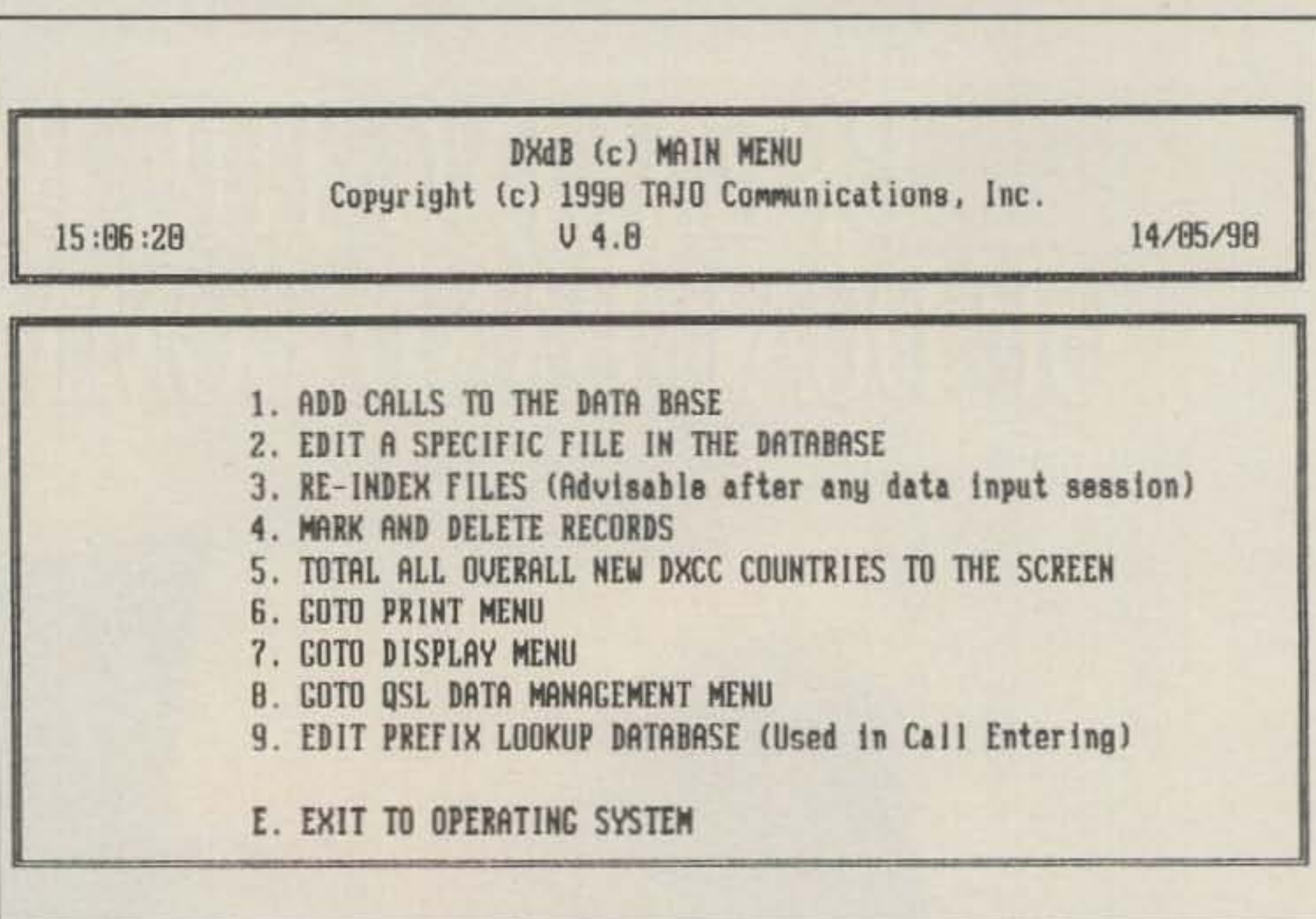

Fig. 3- The DXdB Main Menu allows you to access a variety of features of this DX data tracking program that boasts very fast sorting and data-management capabilities. Though sophisticated, the program is completely menu driven and easy to use.

**DXdB DX Database Program.** TAJD Communications has come up with DXdB©, a special-purpose DX data tracking program for the IBM PC and compatibles. Not a logger in the conventional sense, DXdB is a fast, menu-operated data management program for those who need to keep track of information and accomplishments such as DXCC, WAZ, new country "want lists," and Russian oblast to-

tals. DXdB, claims the manufacturer, should allow you to access and analyze your DX records faster and more accurately than by any other means.

In data entry, which is very sophisticated and includes error checking, you enter the call of the station worked, date, time, mode, and signal report. There's a field for you to enter the "standard" prefix for the country. After

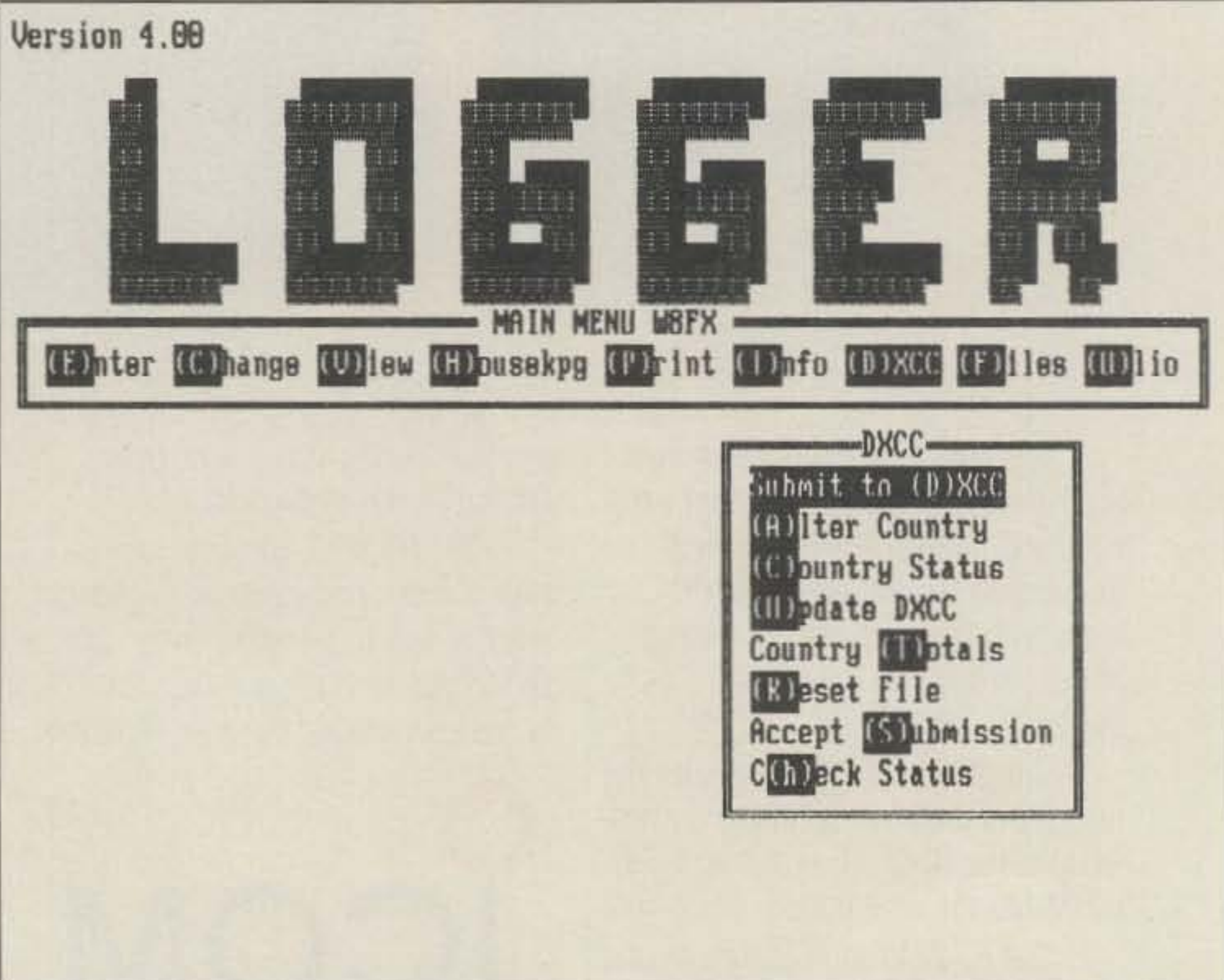

Fig. 4- A screen dump of the LOGGER Version 4 Main Menu shows a variety of features in a logging program that focuses on tracking DXCC and other DX awards. Our first look at LOGGER in the January 1989 column revealed an outstanding program, and it appears that the new version is even better. See the text of this month's column for more details.



you do this, the program supplies the country name and the CQ Zone (if there's only one for the country). There also is an "oblast" field, but you can use the field for other tracking purposes.

Once you've entered the data, it can be edited, listed, browsed, printed, searched, and sorted by various criteria such as band, mode, zone, or oblast, or by a combination of criteria. The program also includes a complete QSL data management facility that lets you keep track of outstanding QSLs and print labels for outgoing QSLs.

I found the program to be an excellent one for its stated purpose of tracking DX data, and it comes with a short but well-written manual. However, the program disk is copy protected, and you should be aware of this. The "key program protection scheme" used is fairly simple but means that you have to follow carefully certain procedures should you de-install and then re-install DXdB, to prevent being locked out of the program and your valuable DX records.

DXdB is priced at \$35 and is sold by TAJO Communications, Inc., P.O. Box 050372, Roseville, MI 48066-0372.

Fig. 3 shows the DXdB Main Menu.

**Quorum WEFAX Card.** The Quorum Communications WEFAX PC Adapter is an "intelligent" scan converter for HF FAX, NOAA APT, GOES WEFAX, and Russian Meteor images on your IBM PC or compatible EGA or VGA display. It contains a built-in 8-bit analog to digital converter that, in connection with software running on the PC, provides a very easy to use and integrated weather FAX reception system. The program allows display of up to 640 x 480 pixels in up to 16 levels of gray or colors. The card's built-in microcomputer provides all of the timing and synchronization needed to receive the images without being concerned with timing loops or the PC processor or clock speed. The PC acts as a display, control, and file system for the adapter.

Some of the main features include a menu-driven interface; automatic synchronization, file save, aspect ratio correction, and level control; tape recorder inputs and outputs; built-in audio amplifier; software-selectable video bandwidth; keyboard selection of major system functions; and a user-configurable timer that allows unattended operation. The system can even be configured for satellite path direction so that, for example, a south-to-north pass builds from the bottom of the screen.

The WEFAX PC Adapter is priced at \$399; a companion 135-139 MHz weather satellite receiver, the SL-137, is \$375. More information, along with a demo disk that allows you to view and manipulate stored images, is available from Quorum Communications, Inc., P.O. Box 277, Grapevine, TX 76051.

**801A Scanning System.** Using this system in conjunction with the ICOM R7000 communications receiver's interface lets your IBM PC or compatible computer control your receiver. This allows faster scanning, more useful scan-delay modes, and several other capabilities. Some of these include storage of up to 1800 channels in as many as 200 banks in a database, storage of a text description of each channel for display during scanning, setup of as many as 100 search ranges, function key access to scan-timer values and three scan-continue modes, and channel lockout by function key. Other system features include the ability to program R7000 memories from the 801A database, search multiple ranges for ac-

tivities to build a list of up to 500 active frequencies, and more.

The complete system includes the program (available on 5.25 inch or 3.5 inch diskette), a half-slot serial interface card, a serial interconnection cable for the R-7000, and a detailed instruction manual. The system is priced at \$98. A demo program disk is available for \$6; it's the same as the real program, except it doesn't "talk to" the R7000.

For more information contact 801-SCAN, 397 Dal-Rich Village, Suite 12, Richardson, TX 75080.

**Morseman Plus Update.** In the March column we surveyed Morseman Plus Version 2.52, a very competent Morse Code trainer for the IBM PC. Upon reading our comments in the column, the program's developer, Robin Gist, NE4L, of Renaissance Development, sent us the latest Version 3 update.

The new version includes some nifty new features. One is a new "effective speed" parameter. This allows a straightforward Farnsworth implementation so that you can keep a certain character speed, but have more spacing between characters. Use of this feature is desirable so that you can learn the characters by their respective sounds and not by counting the dits and dahs.

There's also a new "practice only" mode. With it you can practice only the characters that are giving you trouble. To use it you simply enter the characters that you need to practice, and the program sends only those characters. There's also an expanded word dictionary for the random-word generator. This gives you access to 50,000 words (as opposed to 1500 in Version 2.52), with the option to add another 50,000 words. Other enhancements include improvements to the FCC/VEC Test feature as

## What makes this clock unlike any other clock in the world?

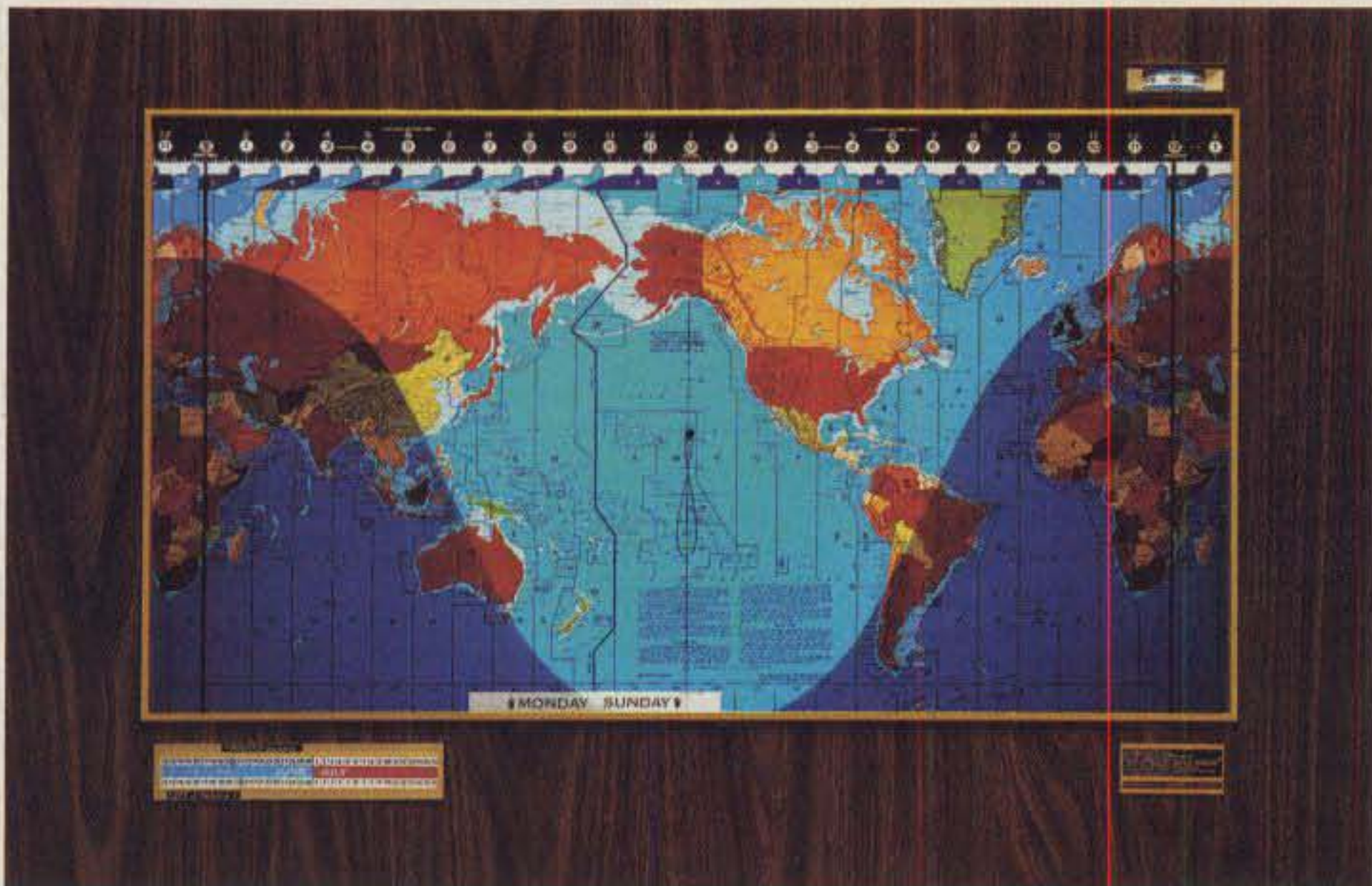

### The difference is night and day.

While some clocks claim to offer world time, only the fascinating Geochron® shows you complete global time — in vivid color.

It's everchanging, illuminated map actually replicates the earth's rotation — allowing the Geochron to accurately depict sunrise and sunset, the sun's declination and meridian passage, along with the time, day and date anywhere on the planet.

It's a true global time indicator. And, it's like nothing you've ever seen.

Whether your orientation needs are that of an educator, international executive, ham operator, navigator, or world traveller — Geochron is the industry's ultimate time keeping device.

For ordering information or brochures, call 1(800) 342-1661. In California, call (415) 361-1771.

Currently distributed by Ham Radio Outlets,® The Nature Company,® BN GENIUS,® Rand McNally & Company,® and finer stores everywhere.

# GEOCHRON®

GEOCHRON ENTERPRISES INC. (415) 361-1771  
899 ARGUELLO STREET FAX (415) 361-1780  
REDWOOD CITY, CA 94063



CIRCLE 81 ON READER SERVICE CARD

well as scripts that allow you to embed commands in text files to control the program. The package is priced at \$24.95 plus \$2.00 shipping and handling.

Robin notes that some users have had problems using Version 3 on "near compatibles" running versions of DOS earlier than V3.2, such as older Tandy and AT&T 6300s. He should have these minor problems worked out by the time this appears in print.

Incidentally, Robin also operates the Renaissance Software Library, which offers a good selection of top-rated shareware and public-domain software for the IBM PC and compatibles. Included in the library are a large number of amateur radio programs, including several I have not seen elsewhere. The 5.25 inch disks are \$3 each; 3.5 inch disks are \$4.

For details contact Renaissance Development, Box 640, Killen, AL 35645.

**LOGGER Update.** You may recall our first visit to LOGGER, the IBM PC logging program that specially focuses on tracking DXCC and other awards, in the January 1989 column. The early version was an outstanding program, and it appears that the new Version 4 that Jim Bobo, W5ODD, sent me is even better, with several new features.

To review, LOGGER is far from generic. It is a system of six related programs used to keep a log of contacts and to work contests easily. You can use the log it produces to print out lists of contacts, DXCC lists, and WAZ lists, or to display contacts on the monitor screen. As we noted in the earlier column, LOGGER offers a wide range of features, including the generation of monthly calendars; country, zone, state, and province count; display of contact records; bearing and distance as well as sun-

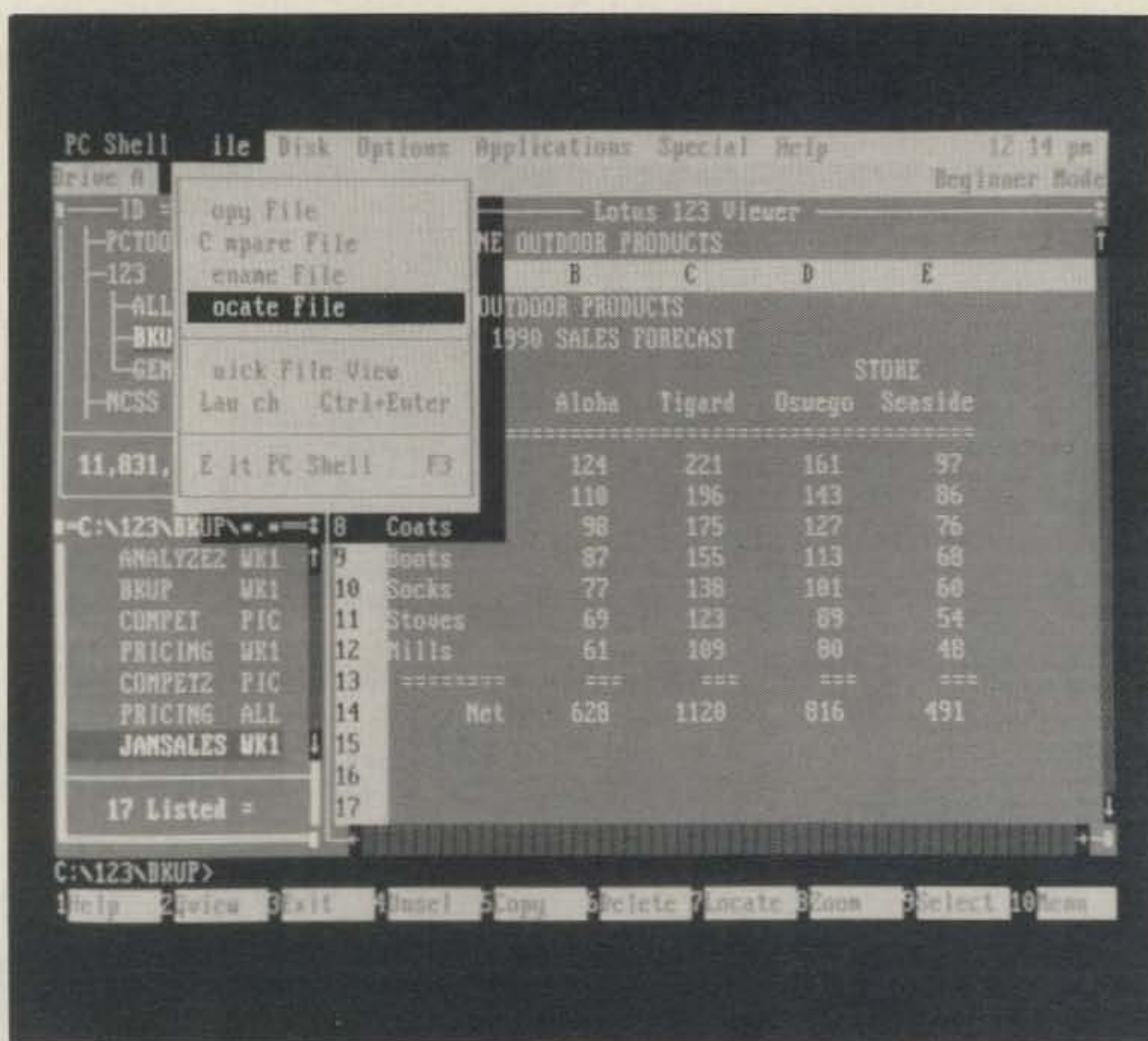

Here's a typical pull-down screen from PC Shell, the superb DOS shell included in the PC Tools Deluxe V6 utility package. You can configure the shell to different levels of user expertise. Here it's shown in beginner mode. You also can use the shell to access other programs in the package. (Photo courtesy Central Point Software, Inc.)

## DAIWA

### Coaxial Switches

PAT. No. 59-0003803



CS-201

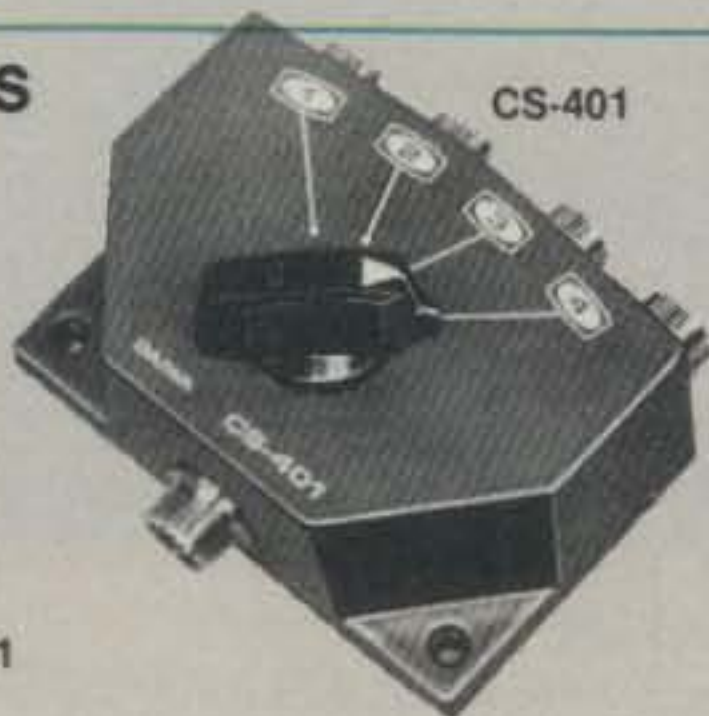

CS-401

	CS-201 2 Position	CS-201G II 2 Position	CS-401 4 Position	CS-401G 4 Position
Frequency:	500 MHz	1.3 GHz	800 MHz	800 MHz
Connectors:	SO-239	N type	SO-239	N type
Isolation:	+60 dB	+60 dB	+50 dB	+50 dB
Power Rating:	2.5 kW PEP 1 kW CW	2.5 kW PEP 1 kW CW	2.5 kW PEP 1 kW CW	2.5 kW PEP 1 kW CW

Insertion Loss: All models less than 0.2 dB

### POWER SUPPLIES



MODEL PS140II

MODEL:	24A	18 lbs.
PS304	24A	18 lbs.
PS120M	9A	11 lbs.

Daiwa power supplies consist of quality IC's, transistors and diodes. Each model contains an over-current limiting protection circuit. This protects the power supply circuitry when shorting positive and negative line or when over current flows through the power supply circuitry.

Input Voltage	117 VAC ± 10%
Output Voltage	13.5 V
Output Current	12A
Volt Fluctuation	Less Than 1%
Ripple Voltage	Less Than 3 mv
Protection Circuit	When 14-2A
Pwr Consumption	350W Max.
Dimensions	128 x 104 x 225 mm
Weight	11 lbs.

### Cross Needle SWR/Power Meters for All Bands

NS-660PA



Model	Freq. Range Int. Sensor	Forward Power	Connectors
NS-660A/PA	1.8-150 MHz	30/300 W/3 kW	SO-239
NS-663BM/BN*	140-525 MHz	30/300 W	SO-239/N type
DP-810	1.8-150 MHz	0-1.5 kW	SO-239
DP-820/N	140-525 MHz	0-150 W	SO-239/N type
DP-830	1.8-525 MHz	0-1.5 kW/0-15 W	SO239/N type
CN-101	1.8-150 MHz	15/150 W/1.5 kW	SO-239
CN-103	140-525 MHz	20/200 W	SO-239/N

All models back lit

\*Average Power Reading Only

### MOBILE/BASE CROSS NEEDLE SWR/POWER METERS



CN-460M

CN-520

Model	Freq. Range Int. Sensor	Forward Power	Connectors
CN-410M*	3.5-150 MHz	15/150 W	SO-239
CN-460M*	140-450 MHz	15/150 W	SO-239
CN-465M*	140-450 MHz	15/75 W	SO-239
CN-520**	1.8-60 MHz	200 W/2 Kw	SO-239

\*Back lit with mobile bracket

\*\*Optional mobile bracket available

For more information or dealer nearest you call:



**ELECTRONIC DISTRIBUTORS CO.**  
325 Mill Street • Vienna • VA 22180  
Ph 703-938-8105 FAX 703-938-6911

# Cosmic Uplink.



## **FT-736R: For the serious satellite operator.**

Reach beyond the limits of other transceivers... Reach for the stars... with the FT-736R, the overwhelming choice of satellite users. The FT-736R includes: Normal and inverted frequency tracking for easy transponder operation and elite-class receiver features for EME, Tropo, Meteor Scatter and other weak-signal work. The FT-736R delivers up to twenty-five watts RF power output on the 144 and 430 MHz amateur bands. With extensive microprocessor control for ease of operation, the FT-736R proves to you that the sky...and the stars...are no longer the limit.

- Frequency range incorporates up to 4 band modules. 144 and 430 MHz are built-in with 50, 220 and 1200 MHz optional.
- An innovative memory system includes 100 general purpose memories, plus 10 full duplex crossband memories, one global call channel that can be recalled from any band or mode and up to 4 band-specific call channel memories which store RX and

TX frequencies independently — a total of 115 memories storing up to 230 frequencies.

- An 8-bit CMOS main microprocessor and 4-bit I/O coprocessor provide exceptional digital integration and control.
- The FT-736R is equipped with 2 general purpose VFOs plus one PMS (programmable memory unit scanning) on each band, 2 special-purpose full duplex VFOs and up to 4 clarifier (RX offset) memories, one per band.
- **Optional accessories:** 50 MHz, 220 MHz and 1.2 GHz band modules • Desktop microphone • Internal electronic iambic keyer • Amateur television modulator/demodulator • FIF-CAT interface unit • External loudspeaker • AQS message processor • Voice synthesizer and CTCSS tone squelch unit.

## **Yaesu can make it all happen.**

For information on the FT-736R and FT-767GX or Yaesu's full line of products, contact your nearest dealer now.

Yaesu Announces  
**One Year  
Limited Warranty**  
on all Amateur Radio Products

## **FT-767GX: Leading the way.**

The FT-767GX was the first HF transceiver designed to operate on all HF bands plus 6m, 2m and 70m.

- Transmit coverage from 10 to 160 meters and receive coverage from 100 kHz to 30 MHz.
- The FT-767GX features SSB, CW, AM and FM modes. Optional 2 meter, 6 meter and 70 cm plug-in modules (10 watts per band) provide that extra flexibility. Built-in accessories include AC power supply; antenna tuner with its own memories and iambic keyer.
- Forced-air circulation through the FT-767GX unique chassis design permits 100 watt output at 100% transmitter duty cycle in all modes.
- Optional accessories include CTCSS tone squelch unit, speaker patch and desk link.

# YAESU

Performance without compromise.<sup>SM</sup>

© 1990 Yaesu USA, 17210 Edwards Road, Cerritos, CA 90701

Optional external speaker (SP-767) and desk microphone (MD-1BS) shown.

CIRCLE 2 ON READER SERVICE CARD

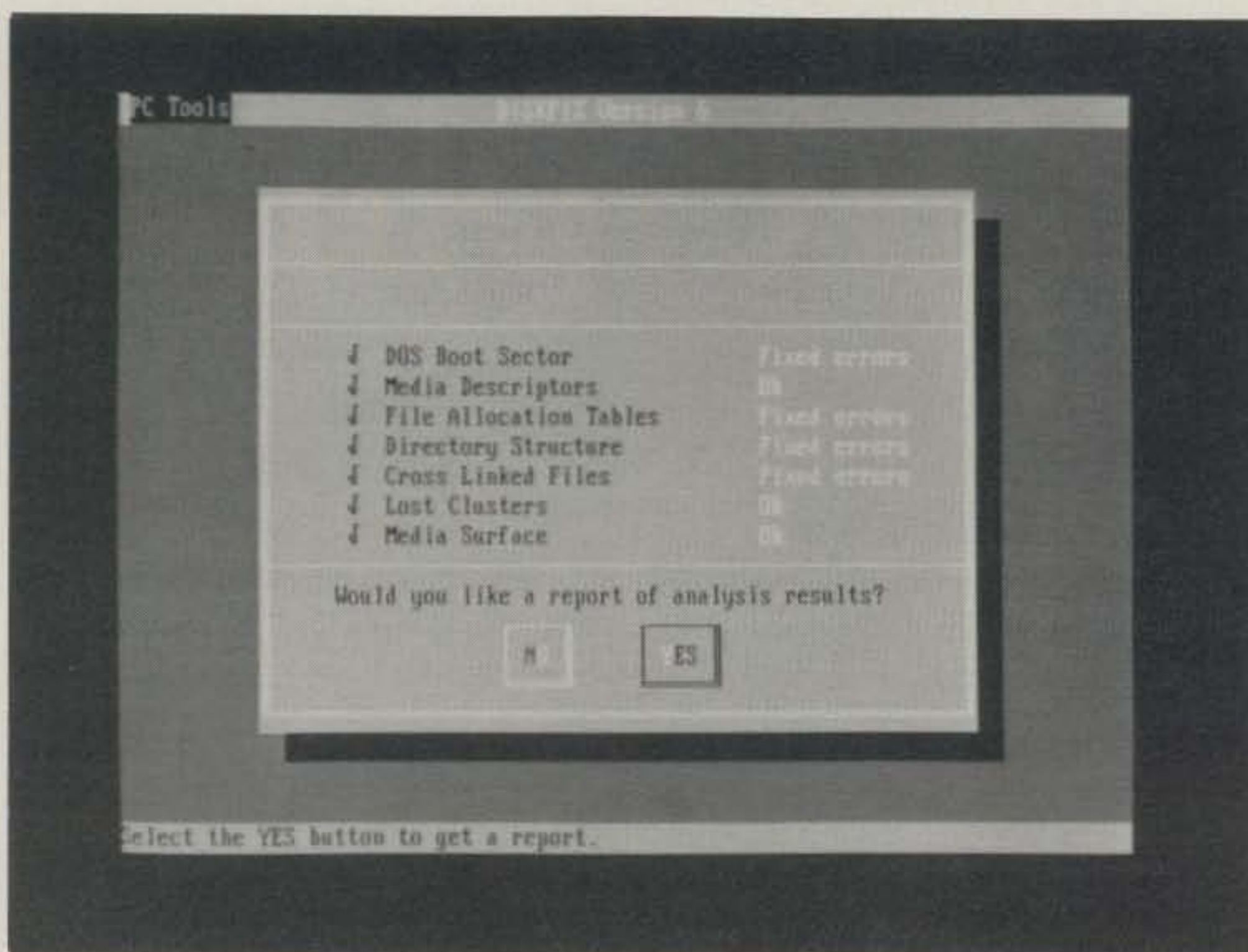

Shown here is a new addition to the extensive array of PC Tools utilities. It's DiskFix™, a comprehensive disk repair program. The new program handles disk corruption nicely; it can rebuild hard-disk partition tables and logical boot sectors, repair File Allocation Table (FAT) and directory information, recover lost files and subdirectories, lock out bad disk sectors, and much more. (Photo courtesy Central Point Software, Inc.)

rise/sunset time calculation; a grid locator function; various print options, including QSL labels; and much more that we don't have space to detail here. Suffice it to say that the new version has the look and feel of a polished commercial software package, including a shell-to-DOS feature, a complex calculator, and a number base conversion routine.

The LOGGER program isn't public domain, although it is freely distributed and nonregistered users can use the program for a short while to see if it meets their needs. The registration fee is \$35. This fee entitles you to re-

ceive the latest version of all of the programs in the package, except for a special contesting program known as CONTEST; you can get it for \$15 extra. Registration entitles you to receive future upgrades for 2 years for a \$5 nominal fee.

For information contact Jim Bobo, W5ODD, at Alamo DX Amigos, 196 Tomahawk Trail, San Antonio, TX 78232. Fig. 4 depicts the LOGGER Main Menu.

**PC Tools Deluxe V6.** Again, the best gets even better. Once more, the software wizards at Central Point Software have improved their

award-winning utility package with the release of Version 6. (We reviewed earlier versions on four separate occasions—in the March and October 1988, October 1989, and March 1990 columns—the last review that of PC Tools V5.5 in March.)

With each new version Central Point adds to the utility's collection of programs and strengthens the existing ones. The new version is more than a comprehensive set of disk utilities; it's actually evolved into something that is more of a complete operating environment for your PC. This makes it suitable as one of the first program packages you might purchase.

Just in case you're not familiar with PC Tools, some of its major features include a multipurpose DOS shell; disk backup and maintenance utilities; a desktop program that includes a database, outline, notepad, appointment scheduler, modem communications, and four different calculators for algebraic, scientific, business, and programming tasks.

Version 6 includes communications capabilities to very easily send and receive E-Mail from MCI Mail, Easylink, and CompuServe®. There's also a facility to quickly write up a memo and send it via FAX, if you have a FAX card on your PC. Also included is an integrated version of Traveling Software's LapLink® program, to connect a laptop or other PC to your PC via the serial ports, enabling quick and easy PC-to-PC file transfer. And the new database function generates dBASE-compatible database files, with indexing, mail merge, append/transfer, and field editing; it handles up to 10,000 records per file.

Another completely new feature is Disk-Fix™, an automatic and powerful disk repair program. Still another is the many new file viewers to allow you to see directly files produced by more than 30 different applications in their native format, without having to load the software that created the files. The PC Backup program now includes appended backups and comparison of backups with the original files as well as support of several different tape backup drives.

There's also a new PC-Cache program that speeds hard-disk operations using expanded memory (EMS), extended memory, or conventional memory. A nice touch, too, is the selectable user levels in both the PC Backup and PC Shell programs.

The new version is big in two ways. It requires about 3 megabytes (MB) of hard-disk space, and the three fat manuals contain nearly 1000 pages of documentation for you to digest. The price now stands at \$149. This may seem high, but upgrades for registered users of earlier versions are bargain-priced at only \$35. Overall, PC Tools V6 does everything well. When taken as a whole, the collection is priceless—especially should you need to repair a crashed disk and recover highly valuable data.

For detailed information, contact Central Point Software, Inc., 15220 NW Greenbrier Pkwy., #200, Beaverton, OR 97006.

## SUPER PERFORMANCE BATTERIES

### UPDATED SUPER ICOM

**SUPER ICOM BP-7S.** 13.2 volts, 1200ma triple the capacity of the Icom BP-7, 5w output.

**SUPER ICOM BP-8S.** 9.6 volts, 1200ma, 50% more capacity than the Icom BP-8.

Both are rapid base charge only, or slide in wall charger, 4 inches high. BP-7S or BP-8S. \$65.00

### SUPER KENWOOD

**SUPER KENWOOD PB-25S/PB-26S.** 8.4 volts, 900ma, double the capacity of the PB-25/PB-26 for the 2500/2600/3500/3600. Charge with either the standard wall charger or drop in charger. 3 inches high. \$65.00.



Exact replacement FNB-2 Nicad pack for Yaesu FT-404R/207R/208R/708R \$22.50

### SPEAKER/MICS

Icom HM-9 \$35.00  
Yaesu MH12A2B \$31.00

### SUPER YAESU

**SUPER YAESU FNB-4SH.** 12 volts, 1000ma, double the capacity of the Yaesu FNB-4, 5 watt output. Rapid charge only. \$71.00

**SUPER YAESU FNB-3S.** 9.6 volts, 1200ma, triple the capacity of the Yaesu FNB-3, 3.5 watt output. Rapid or wall charge. \$65.00

Both are perfect for the 03, 09 and 727 series radios and are 4 inches high.

Inserts for:  
Kenwood PB-25, 25H, 26 \$25.00  
Icom BP-3 \$18.95  
Icom BP-5 (500ma) \$24.95  
Icom BP-7 (500ma) \$29.50  
Icom BP-8 \$29.50

Full line for Yaesu 411/811/470, FNB-10/11/12/14 available. Add \$4.00 shipping & handling for first pack. CT residents add 8% tax.

Complete line of NICAD packs for Icom, Kenwood, Yaesu, Tempo, Santec, Azden, Cordless Telephones, Akaline, Nicad & Gell-Cells. All NICAD packs include 1 year guarantee. Commercial Radio Packs available. For all your battery needs, write or call today for a complete catalog. Dealer inquiries invited.

MADE BY HAMS FOR HAMS

**PERIPHERAL Inc.**

149 Palmer Road • Southbury, CT 06488

(800) 634-8132 In CT (203) 264-3985 FAX: (203) 262-6943

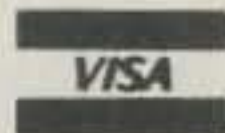

## Wrapping It Up

That's all for this month, guys and gals. Next time more Antennas & Accessories topics of current interest. See you then.

*Overheard:* The Fourth Law of Computing is "On a clear day you can wait forever."

73, Karl, W8FJ



**rfconcepts DualBand**

## revolutionary AMP

Designed for use with dual band hand-helds (HT's), the rfconcepts DualBand Power Amplifier represents a revolutionary step in the state of the art. This dual band amp and preamp combination is the first to amplify both 2m and 70cm automatically.

The DualBand Amp senses power output from your HT through dual narrow band peak detectors using fast switching low insertion loss relays for automatic keying (RF sense and transmit).

Features including PIN diode protected twin GaAsFet preamplifiers for extended range in fringe areas, and an all-component PC board mount design for reliable performance and serviceability, make the DualBand ideal for both mobile and ham shack applications.

For a detailed technical specification sheet, call your rfconcepts dealer or contact rfconcepts direct.

The rfconcepts DualBand, extra power for both 2m and 70cm, automatically.

rfconcepts - Division of Kantronics - P.O. Box 11039, Reno, NV 89510, 702.827.0133



# CALL 1-800-423-2604

**FRIENDLY SERVICE  
TEXAS STYLE!**

**Multi Store  
Prices!**

**HOURS**  
M-F 9:00 - 5:30 (PHONE)  
10:00 - 5:00 (WALK-IN)  
SAT 9:00 - 5:00 (PHONE)  
9:00 - 1:00 (WALK-IN)  
CENTRAL TIME

**AUSTIN AMATEUR  
RADIO SUPPLY**

**SERVICE, INFO,  
TEXAS RESIDENTS  
(512)-454-2994**

5325 NORTH I-35  
AUSTIN, TEXAS 78723



**ICOM**



IC765 • IC735 • IC725



IC229H • IC24AT • IC2SAT • IC2400A

**Special Sale Prices!**

IC2SAT

Battery  
Promo!  
Call Now!

IC24AT

IC229H

IC735

IC2400A

**KENWOOD**



• TS950SD •  
TS940SAT • TS440SAT • TS140S



TM941A • TM731A • TM241A  
TH75A • TH225A • TH27A

**Special Sale Prices!**

TH27A

TM731A

New!  
TM941A

TS440S  
w/AT

Battery  
Promo!  
Call Now!

TH225A

**YAESU**



FT1000D • FT767GX • FT757GX/II



FT212RH • FT470 • FT411E

**Special Sale Prices!**

FT470

FT212RH

FT757  
GX/II

FT411E

**ANTENNA  
ROTATORS  
ON SALE!**

ALLIANCE  
HD-73 In Stock!

TELEX  
CD45-II • HAM-IV  
TAILTWISTER

YAESU  
G400RC

**LARSEN  
DUAL BAND  
ANTENNA  
ON SALE!**

Your Choice.  
Mag Mount  
Trunk Lid  
Mount  
Hole Mount



DR-590T  
**Now In Stock!**  
DR-570T  
**A Great Buy!**



DR-110T • DR-112T  
2M - 45 Watt  
**Super Value!**



**DJ-160T**  
Full Featured  
2 Meter  
Handheld  
Always  
Competitive  
Pricing!

**MFJ  
ANTENNA TUNERS  
& ACCESSORIES**



986 • 949D • 941D • AND MORE...

New  
Low  
Pricing



MFJ 1270B • 1278 • 1278T



AEA PK-232MBX • PK-88

New  
Low  
Pricing



KANTRONICS KAM

## A LOOK AT THE WORLD AROUND US

### A Keys Bonanza!

Thanks to your continuing interest and support, this month's column features yet another blowout celebration of amateur radio's favorite accessory—the telegraph key. This time we have a fascinating collection of views and information that spans the most prized bugs to the latest handmade paddles. Some special treats and ever-popular items are also included to balance our photographic tour and inspire your own interest in key collecting. This whirlwind review is once again overflowing available space, so hold onto your magnifying glass and pay close attention as we move at our usual fast pace. I will postpone soapboxing until later and jump right to the details.

The star contributors of this month's views are Jim Aguirre, WB7DHC, of Preston, Washington; Evelyn Garrison, WS7A, of ICOM America fame; Charles Tryor, N4LMY, U.S. liaison for G4ZPY's keys; MFJ Enterprises; and Kent keys. CQ Editor Alan Dorhoffer, K2EEK, and yours truly, K4TWJ, also added some of our own keys. Additional details are included as we continue. Let's begin with WB7DHC.

Jim Aguirre (P. O. Box 527, Preston, WA 98050) has an impressive collection of over 100 bugs, and he specializes in Vibroplexes. His knowledge of keys is equalled only by the accuracy of his documentation of bugs. Let's look at his key delights.

#### Photo 1

Surely the rarest and most unusual Vibroplex ever made is the "Midget," or pocket bug. A very limited number of this little marvel were produced between 1917 and 1925. They are so scarce, in fact, that Jim has only a single photograph shot from W7GAQ's collection to share with us (and we promised its safe return to WB7DHC after use!). Advertisements of the Midget appeared mainly in trade magazines (such as the *Railroad Telegrapher* ad shown in fig. 1), so many amateurs were not aware of its existence.

Close ad and photo inspection reveals the Midget's design. Its base is apparently 2 inches wide by 5½ inches long, with a

## Are You at Your Best?

To be at his best is the patriotic duty of every Telegraph Operator.

With a Vibroplex, you attain maximum efficiency with a minimum of effort.

The Vibroplex quickly develops ability not possible with the hand, and insures you being at your best.

**Martin "MIDGET"**  
Weight 15 ounces. Fits vest pocket. Nickel-plated. \$15

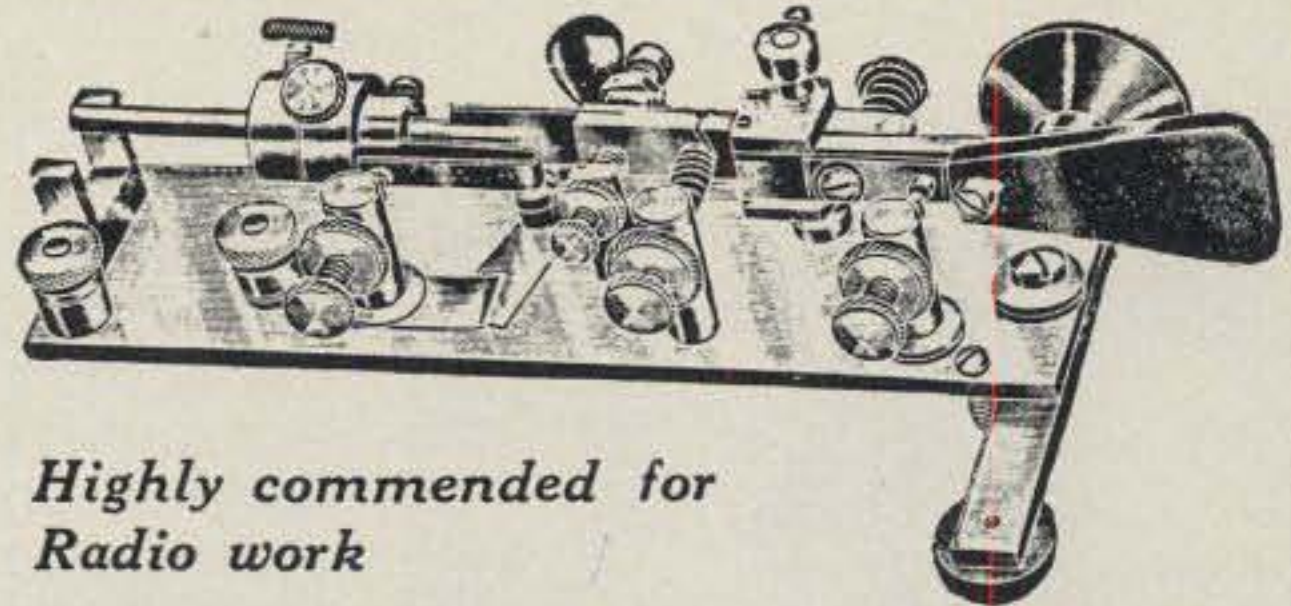

Highly commended for  
Radio work



**VIBROPLEX No. 4**  
Blue-Enameled Base - \$ 15  
Nickel-plated Base - \$ 17  
(Mounted on Old Style Base - - - - - \$ 15

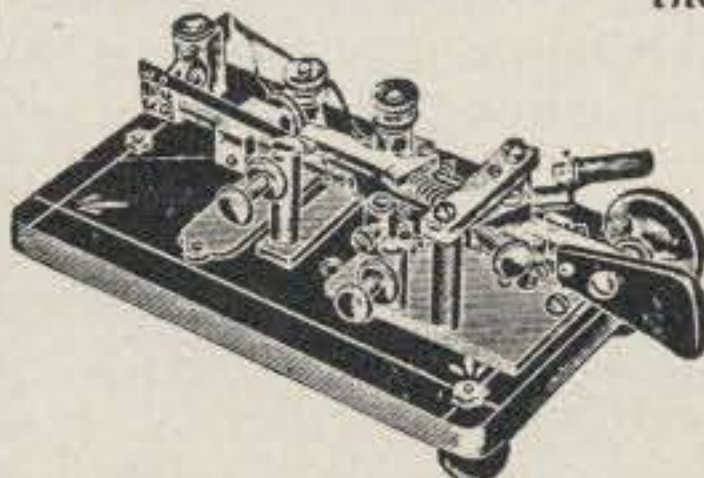

**MODEL X**  
Japanned Base - - - - - \$ 15  
Nickel-plated Base - - - - - \$ 17

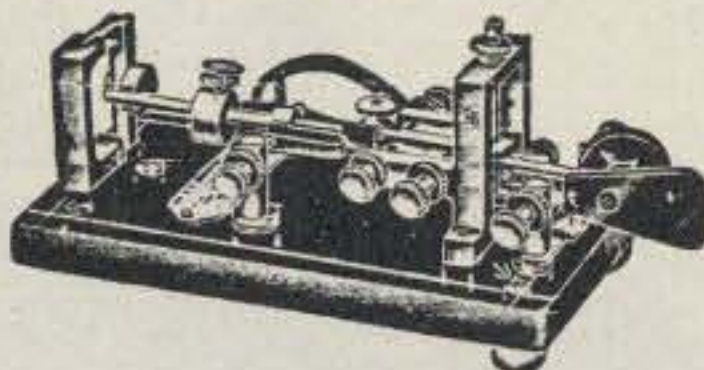

**OLD STYLE SINGLE LEVER**  
Japanned Base - - - - - \$ 15  
Nickel-plated Base - - - - - \$ 17

## Martin Vibroplex

The Vibroplex transmits **STRONG, CLEAR** Morse and carries thru over the longest, heaviest circuits without visible effort on the part of the sender.

A never-ending surprise to Telegraph Operators everywhere, is the **EASE** with which a Vibroplex is operated.

There's no cramped, tiresome muscular movements in Vibroplex sending. Instead—a smooth, pendulumlike motion of the arm in pressing the lever from side to side—the machine does the work.

### Why Not Get That Vibroplex To-day?

When you have learned to use a Vibroplex—and it is **EASY** to master—you have found the **QUICKEST** and **EASIEST** way to telegraph.

You do your work in half the time, and with half the labor. Actually pays for itself in labor saved.

Any Telegraph Operator can use the Vibroplex. The old and young use it with equal success. Many have mastered it the first day. What they have done you can do.

You owe it to yourself to take advantage of the **EASY ACTING** Vibroplex. **DO IT RIGHT NOW**

#### SEND FOR A VIBROPLEX

**Immediate shipment**—Money order or registered mail. Liberal allowances on old machines.

To get the best results—Get a Vibroplex for your own personal use. Adjust to suit your hand. Don't tinker. Don't let others use or change the adjustment.

#### CATALOG ON REQUEST

**THE VIBROPLEX CO., Inc.**  
253 Broadway, NEW YORK

J. E. ALBRIGHT, General Mgr., Member N. Y. O. R. T., N. Y. Div. 26. Cert. 68

Fig. 1—This advertisement featuring the Vibroplex Midget appeared in a 1924 edition of *The Railroad Telegrapher* magazine. (Tnx to WB7DHC)

swivel foot bracket for pocket carrying. There is no conventional yoke; a single ball-bearing-equipped post holds the main arm (obviously to reduce height). That post was evidently "borrowed" from

the classic vertical bug shown in photo 2. The Midget's rear damper is a miniature version of that used on Model 4/Blue Racers. We do not have details on the Midget's "feel" during use, but judging by that

4941 Scenic View Drive, Birmingham, AL 35210

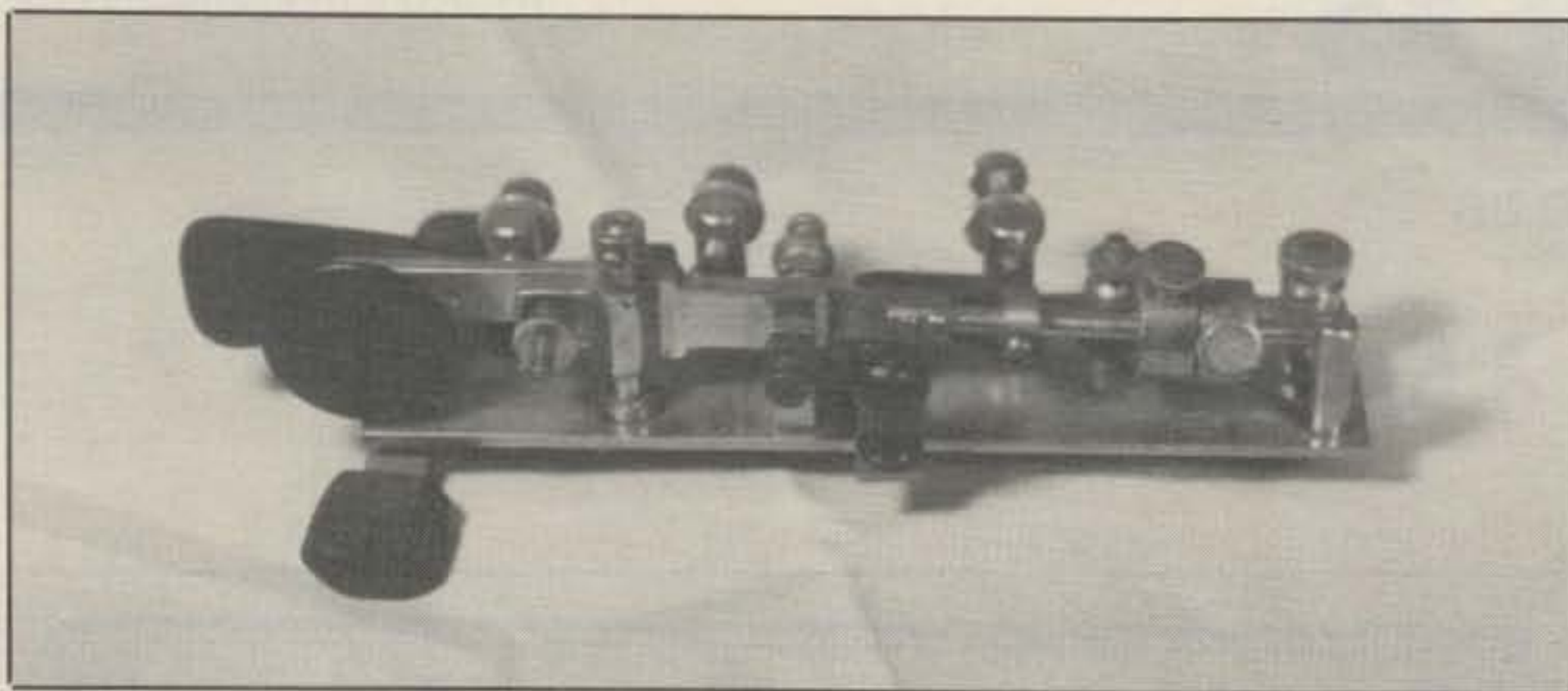

*Photo 1— The extremely rare and highly prized Vibroplex Midget. A very limited number of these pocket-size bugs were made between 1917 and 1925. As you can see, its "yokeless" construction is unique. (Photo from W7GAQ's collection and courtesy of WB7DHC.)*

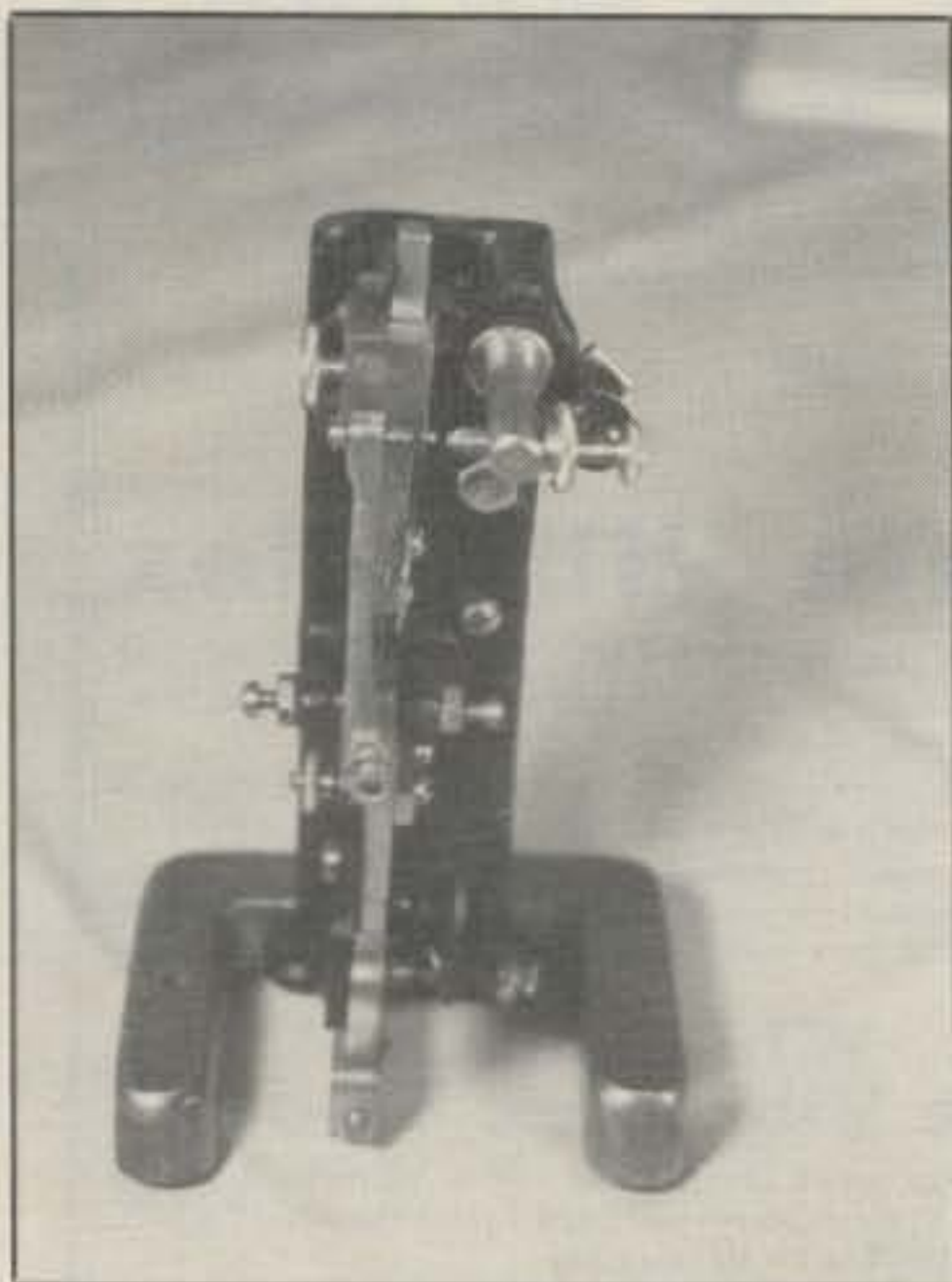

*Photo 2— A serious collector's delight—the famous and rare vertical Vibroplex. Visualize this marvelous item standing by your favorite rig today. Ham heaven indeed! (Key owned by W7GAQ; photo via WB7DHC.)*

short mainspring and pendulum, it would surely be a real high-speed thrill!

### Photo 2

This quite rare and classic vertical Vibroplex was designated the "Upright" model and affectionately dubbed the "Wire Chief's key" because it occupied minimum space on a busy operator's desk. Like the Midget, the Upright was also produced in very limited quantity. Look closely and you will see it uses a single contact for making both dots and dashes. Its horse-shoe-shaped base is necessarily heavy to maintain stability during use. Although barely visible in this WB7DHC photo from W7BAQ's collection, the Up-

right's fingerpieces are mounted horizontally and face directly at the camera.

Visualize setting one of these glamorous bugs by your main rig and using it on the air today. Absolutely breathtaking! And imagine pulling out one for a DX pile-up contest at your local club meeting. The other operators would simply topple over and give up!

### Photo 3

The Double Lever model Vibroplex shown in this photo belongs to WB7DHC, and it is especially appealing to dedicated collectors. Look closely inside its round yoke and notice the unusual "cloverleaf" pattern. Although strictly a personal opinion, I visualize that as a carrying aid and fore-

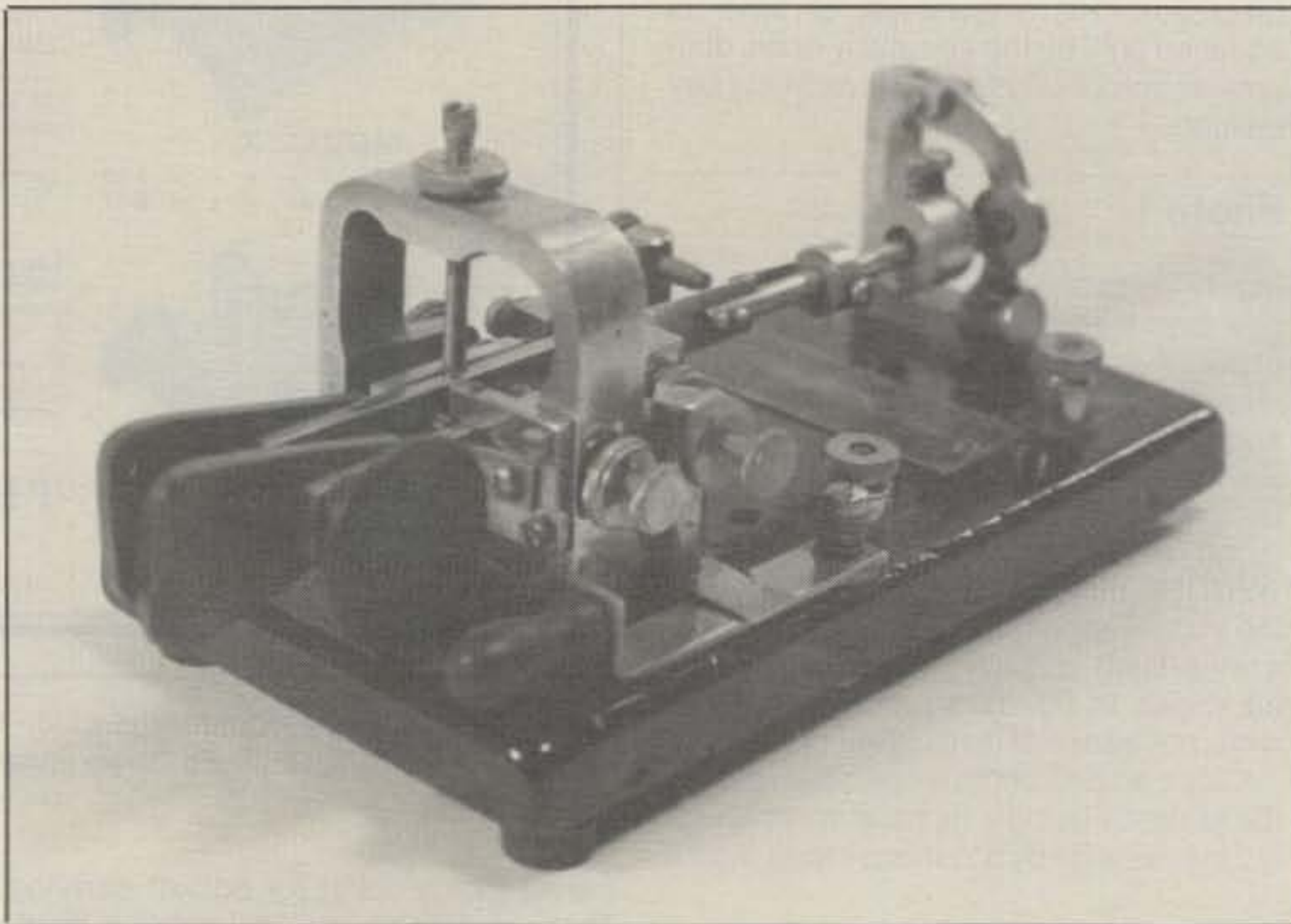

*Photo 3— The Double Lever model Vibroplex with its standard square yoke is a true collector's item, but this later (and more rare) version is even more special. Notice the unusual "cloverleaf" pattern inside its rounded yoke. (Key and photo via WB7DHC.)*

runner to the famed Tee Bar used on Mac Keys and Speed-X bugs. An owner could hook two fingers inside the cloverleaf yoke, lift the key, and tromp off to his post of duty. The Double Lever was manufactured from 1911 to 1914 with a regular square yoke, and in limited quantity from 1914 to 1917 with a cloverleaf yoke. The common design in both models was their dual fingerpieces—a semi-automatic squeeze key without iambic action!

### Photo 4

This photo is loaded with juicy information, some apparent, some not. First, the middle bug is WB7DHC's Martin Junior. On its right is his Model 4, which preceded the Blue Racer (note U-shaped damper), and on its left is his late-model (1950s era) deluxe/chrome Blue Racer (note small Original-style damper).

The Junior is identical to an Original model Vibroplex, except it has a 3 inch base rather than the standard 3½ inch base. This size seems ideal to me; it is not as massive as a regular bug, but it does not tend to "walk" during heavy use like a 2½ inch based Blue Racer. Only one other Vibroplex was manufactured on a 3 inch base—the Zephyr. Except for its smaller base and the addition of a circuit closing lever, the Zephyr was identical to the popular Champion that I featured in a previous "Keys Revisited" column (also see photo 5). One additional note: the little Blue Racer could also be special ordered on a standard 3½ inch base if desired (although that reminds me of having a gold medal bronzed!).





**MEANS A LOT TO YOU  
Because We Provide**

- Better Facilities
- Better Quality
- Better Service
- Better Prices

**ON  
JAN CRYSTALS**

Radio Control    Microprocessor  
Industry        Telecommunications  
Marine         Satellite  
Amateur        Two-Way

WRITE OR CALL FOR FREE CATALOG

**JAN CRYSTALS**

P.O. Box 06017

Ft. Myers, FL 33906

(813) 936-2397

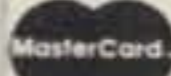
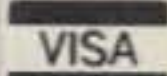

**TOLL FREE 1-800-526-9825**

**FAX ORDERS 1-813-936-3750**

CIRCLE 84 ON READER SERVICE CARD

**The HF5B "Butterfly"™**  
A Compact 2 Element Beam  
for 20-15-12-10 Meters  
Operate As A Di-Pole on 17 Meters

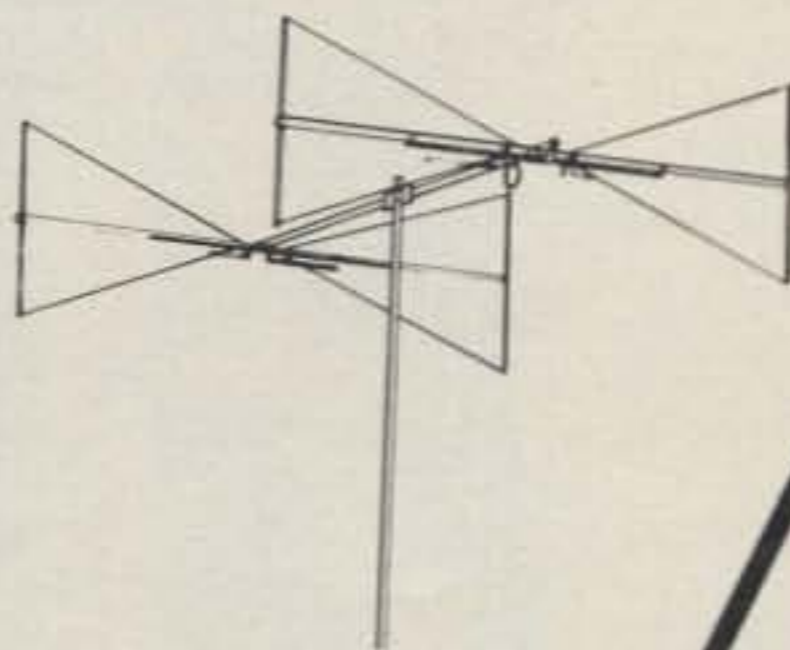

- Unique design reduces size but **not** performance.
- No lossy traps; full element radiates on all bands.
- Turns with TV rotor
- 19 lbs.

**HF ANTENNAS FROM BUTTERNUT**

**Butternut Verticals**

Butternut's HF verticals use highest-Q tuning circuits (not lossy traps!) to outperform all multiband designs of comparable size!

**Model HF6V**

- 80, 40, 30, 20 15 and 10 meters automatic bandswitching.
- Add-on kit for 17 and 12 meters available now.
- 26 ft. tall

**Model HF2V**

- Designed for the low-band DXer
- Automatic bandswitching on 80 and 40 meters
- Add-on units for 160 and 30 or 20 meters
- 32 feet tall - may be top loaded for additional bandwidth.

For more information see your dealer or write for a free brochure

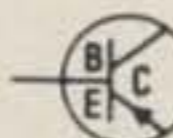

**BUTTERNUT ELECTRONICS CO.**

405 East Market, Lockhart, TX 78644

**HAM LICENSE PREPARATION**

**WRITTEN TEST STUDY GUIDES**

All ham radio questions and answers *with explanations*. Choose Novice, Technician, General, Advanced or Extra Class.

\$5.95 Each + \$1.50 shipping.  
All five manuals: \$26.95 postpaid.

**HAM RADIO LICENSING MANUAL**

All 1,931 questions, multiple choices and answers found in every ham license exam, Novice through Extra. (300 pages)

\$11.95 postpaid.

**WRITTEN TEST COMPUTER SOFTWARE**

Take sample ham tests at your IBM compatible keyboard. Study all 1,931 questions by license class and subelement. Four 5 1/4" disks cover every amateur radio license class.

\$19.95 postpaid.

**MORSE CODE TEST PREPARATION**

Set contains two 2-hr. cassette tapes

Code Teacher,        0-5 WPM        \$9.95  
General Code,        3-15 WPM       \$9.95  
Extra Code,            12-21 WPM      \$9.95

All Manuals, Code tapes, Software: \$69.95  
New Part 97 Ham Rules: \$ 2.95

**THE W5YI GROUP**

P.O. Box #565101 - Dallas, TX 75356

VISA/MasterCard

(Toll free) 1-800-669-9594

CIRCLE 33 ON READER SERVICE CARD

Wire, Cable, Connectors

**SALE**

PL-259, Nickel-Teflon USA	69¢ or \$15/25
PL-259, Silver-Teflon USA	\$1.29 or \$25/25
PL-259, Gold & Teflon, USA	\$1.49 or \$30/25
Matching UG-176s available from	25¢
N connector for 9913, 9086, etc.	\$ 3.25
UG-255 convert HT BNC to SO-239	\$ 1.79
RG-8X 95%, braid, premium quality	14¢
RG-8X 95%, type II non-contaminating	23¢
RG-8X 95%, solid dielectric, "	27¢
RG-213 Enhanced, extra braid 95%++	39¢
9086 International (like 9913)	42¢
NEW! Flexible 9913-type, low-loss for crank-up towers, rotators	59¢

Rotator cable 8 cond. (2x18, 6x24)	20¢
Rotator cable 8 cond. (2x16, 6x18)	34¢
Rotator cable 8 cond. (2x14, 6x18)	48¢
#14 Hard-drawn (7x22) antenna wire	7¢
#14 Copper-clad (7x22) ant wire	8¢
Ladder Line, Poly insul, 450 ohms	10¢
Ladder Line, Poly insul, 300 ohms	11¢
KW Twin-lead 300 sim to orig. Belden	11¢
RADIO WORKS' Center Insulator	\$ 7.95
Dog-Bone end insulator, plastic	60¢

MilSpec 3/16" Dacron Line 100'	\$ 5.00
5/16" Double Dacron(r) #1700 100'	\$15.00

Wire, rope & cable- 50' increments only

**RG-213 Mil-type 31¢**

**CAROLINA WINDOM**

- ONE ANTENNA = All Bands, WARC + 80-10M
- Coax feed + your transmatch = BigSignal
- Out performs dipoles, trap antennas, verticals, and other wire antennas.
- It's a top performer.
- 6 product reviews say so
- Special matching transformer and Line Isolator for max radiation efficiency.
- Performance secret is the exclusive ground independent INVERTED VERTICAL radiator. No other antenna has it

Can't put up a beam, but need BIG SIGNAL performance? Try a CAROLINA WINDOM!

- 80 - 10 M model 132" long, 30' height
- 40 - 10 M model 66" long, 25' height
- 160- 10 M model available

• A Big Signal on all bands, **\$69.95**

**'Current-type' BALUNS**



**WHAT'S SO DIFFERENT?**

- 10 models fit every application.
- Stainless Steel eye-bolts.
- Large, saturation resistant, ferrite cores = high power
- L-C compensation for max bandwidth
- Teflon(r) insulation in high power models
- Completely potted

- We publish specifications for all baluns
- Internal wires brought outside of case for direct connection to your antenna.
- Excellent Output balance and load tolerance

**1:1 "CURRENT-TYPE" BALUNS**

B1-2K	2KW High Isolation 80-10M	\$15.95
B1-4K	4KW High Isolation 80-10M	\$19.95
B1-5K	5KW Precision 160-10M	\$26.95
C1-2K	2KW Precision Retro-Fit	\$16.95
C75-4K	4KW 75 ohm for loop matching	\$19.95
4K-LI	4KW RFI Line Isolator	\$19.95

**4:1 BALUNS**

B4-1.5K	80-10M 1.5 KW balun	\$17.95
B4-2K	Precision 2 KW 80-10M balun	\$26.95
B4-2KX	'Current-type' 160-10M 2KW+	\$35.95
REMOTE BALUN,	coax/open-wire interface	\$27.00

**RADIO WORKS**

Everything For wire antennas

Free 72 pg Discount Catalog  
Allow 4-6 Weeks Delivery of Your Catalog or Send \$2.00 for Catalog By Priority Mail

**The RADIO WORKS**

(804) 484-0140

FAX (804) 483-1873

Box 6159

Portsmouth, VA 23703

Mention this ad for sale prices  
ADD SHIPPING - Visa & MC welcome  
Give card #, exp. date, signature  
COD add \$3.30 + shipping  
Virginia residents add 4.5% sales tax  
Dealer Inquiries Invited

CIRCLE 87 ON READER SERVICE CARD



# AUSTIN CUSTOM ANTENNA

## MODEL 500-C

AUSTIN, the leader in multi-band technology brings you state of the art low angle radiation performance in a compact design.

The Model 500-C is available in single or dual band configurations. Various combinations of frequencies are available from 100 MHz to 2 Ghz. and a Soft Top model for HT's.

MOUNTS: LOW PROFILE, BNC, TNC, UHF POWER RATED 160 WATTS ICAS

\$29.95

"PATENT APPLIED FOR"  
!!A Better Idea From AUSTIN!!

!!NEW!!

!!NOW AVAILABLE!!

"The Ferret"

Super Broadband Coverage  
25 to 1300 MHz

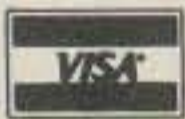

10 Main Street  
Gonic, NH 03839  
(603) 335-6339

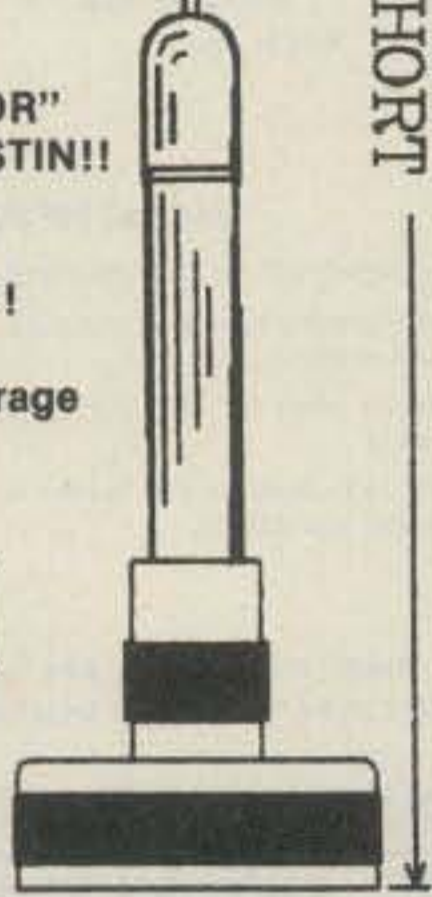

18 INCHES SHORT

CIRCLE 79 ON READER SERVICE CARD

## AMIGA commodore CHIPS... PARTS... UPGRADES

### Replacement Chips

6526	\$12.25
6567	\$15.95
6581	\$12.25
PLA	\$12.95
All 901 ROMS	\$10.95
8362 DENISE	\$39.95
8364 PAULA	\$39.95
8520A	\$17.95

8372 SuperAgnus	*\$99.50
1750-512K Clone	\$129.00
A501-512K RAM/Clock	\$69.95

\*Includes FREE Agnus Chip Puller

### JUST RELEASED C-64 POWER SUPPLY "REPAIRABLE"

- Heavy Duty, 1.8 Amps
- Schematic Included
- 13 Month Warranty
- UL Approved
- External Fuse
- Large Heat Sink

Super Price **\$24.95**  
(+ UPS)

### COMMODORE DIAGNOSTICIAN #6

(For all C-64 computers and 1541 drives)

REFERENCE AID #6 allows you to save money on repairs and downtime by promptly locating faulty IC chips on all Commodore computers and 1541 drives. Different sections contain "cross referencing" of chips and "block layout". (A schematic is included but not needed). Over 20,000 "DIAGNOSTICIANS" sold worldwide... see fantastic full page review in Computer Shopper Magazine. Price is \$6.95 prepaid in the U.S.

### • IMPORTANT CATALOG ANNOUNCEMENT •

We have a new 27 page catalog of specialty items for Amiga, Commodore and IBM. This FREE catalog contains: low cost chips, upgrades, diagnostics, tutorial video tapes, interfaces, heavy duty power supplies and other super products you cannot find anywhere else. Call for your catalog.

The Grapevine Group, Inc.  
3 Chestnut Street • Suffern, NY 10901  
(914) 357-2424 (FAX 914 357-6243)

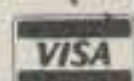

1-800-292-7445



We Ship Worldwide Prices Subject to Change

CIRCLE 35 ON READER SERVICE CARD

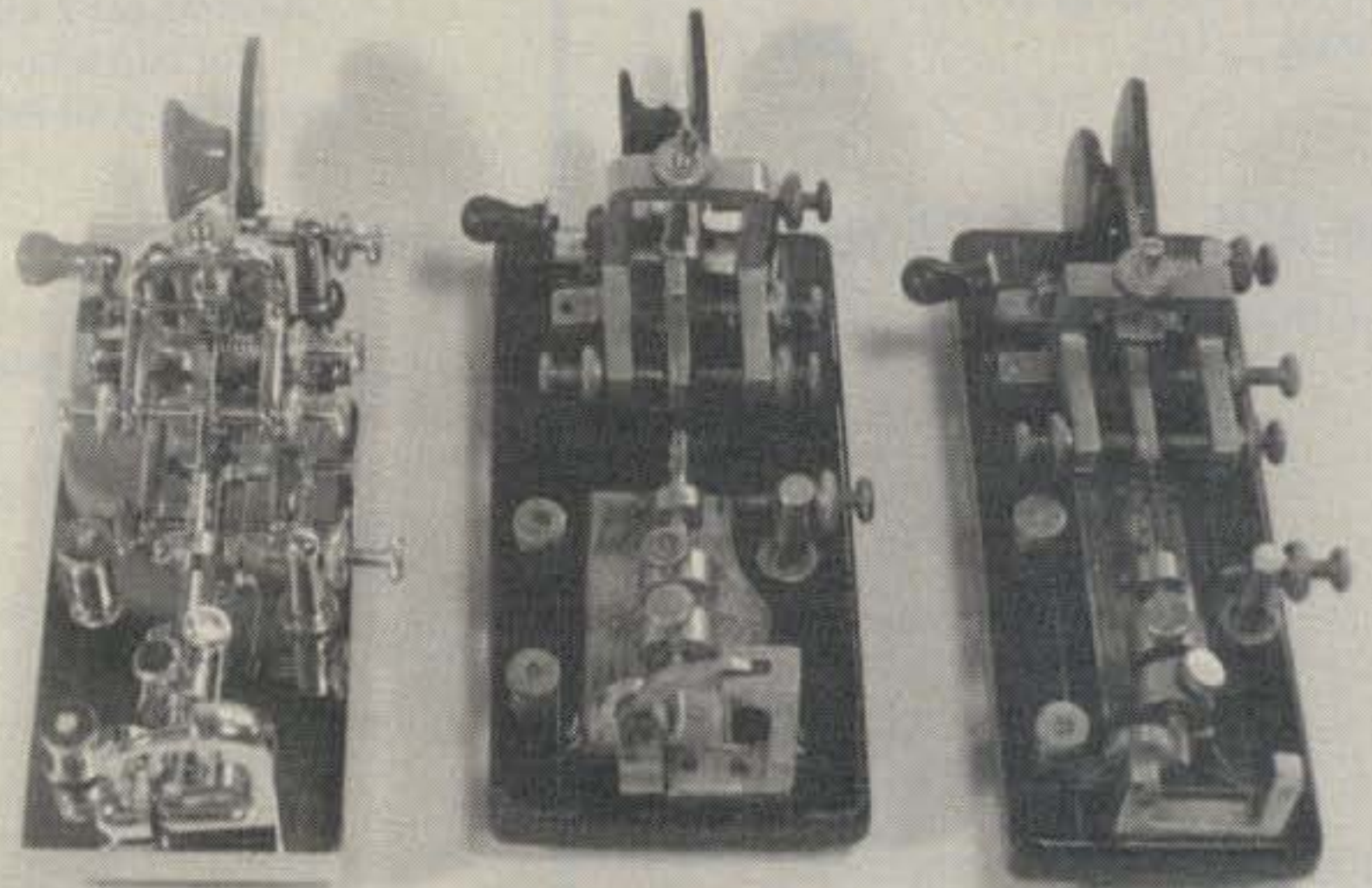

Photo 4- A triple treat! The key on the left is a late-model deluxe Blue Racer. The middle key is a Martin Junior, and the key on the right is an old Model 4. Full details are in the text. (Keys and photo via WB7DHC.)

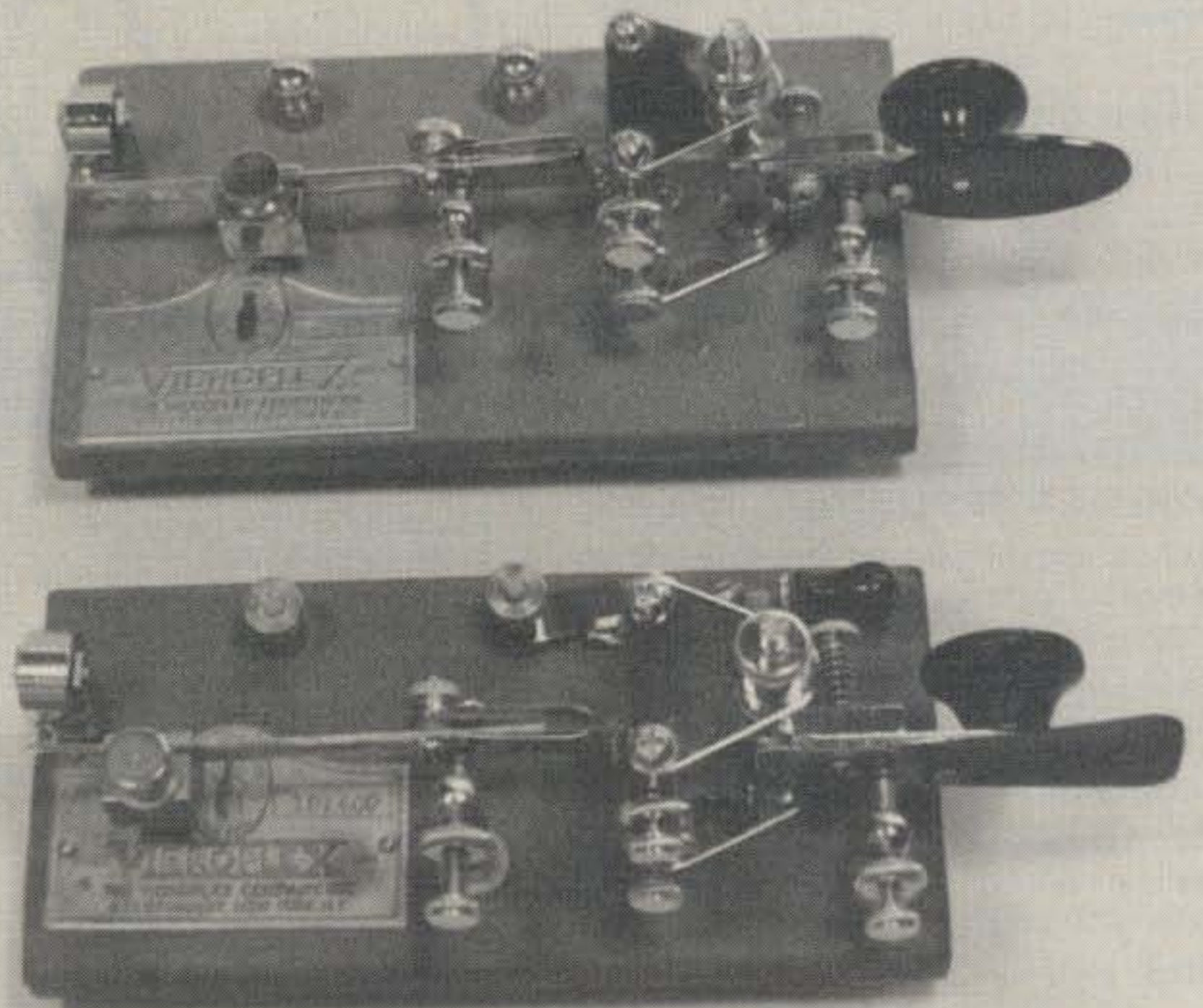

Photo 5- Comparison of Champion model Vibroplex with its 3 1/2 inch wide base (top) and Zephyr with its 3 inch base (bottom). (Keys and photo via WB7DHC.)

The Junior, Blue Racer, and Zephyr are fabulous bugs to use on the air today with a modern transceiver. They add a special air and personality to your fist that simply cannot be achieved with an electronic keyer. Just remember my previous columns' notes on adjustment. Add plenty of lever travel and tension during setup, include an extra weight to calm high-speed dits, and get some real wrist action going for a beautiful sound. Vibroplex, incidentally,

has plenty of extra weights, and you can order them (please!) by telephoning 1-800-AMATEUR. When you call, ask about their new book on the history of Vibroplex. Didn't I tell you this month's column was loaded with good information?

### Photo 6

This trio of Speed-X bugs comes from my own (K4TWJ) hands-on and used-daily

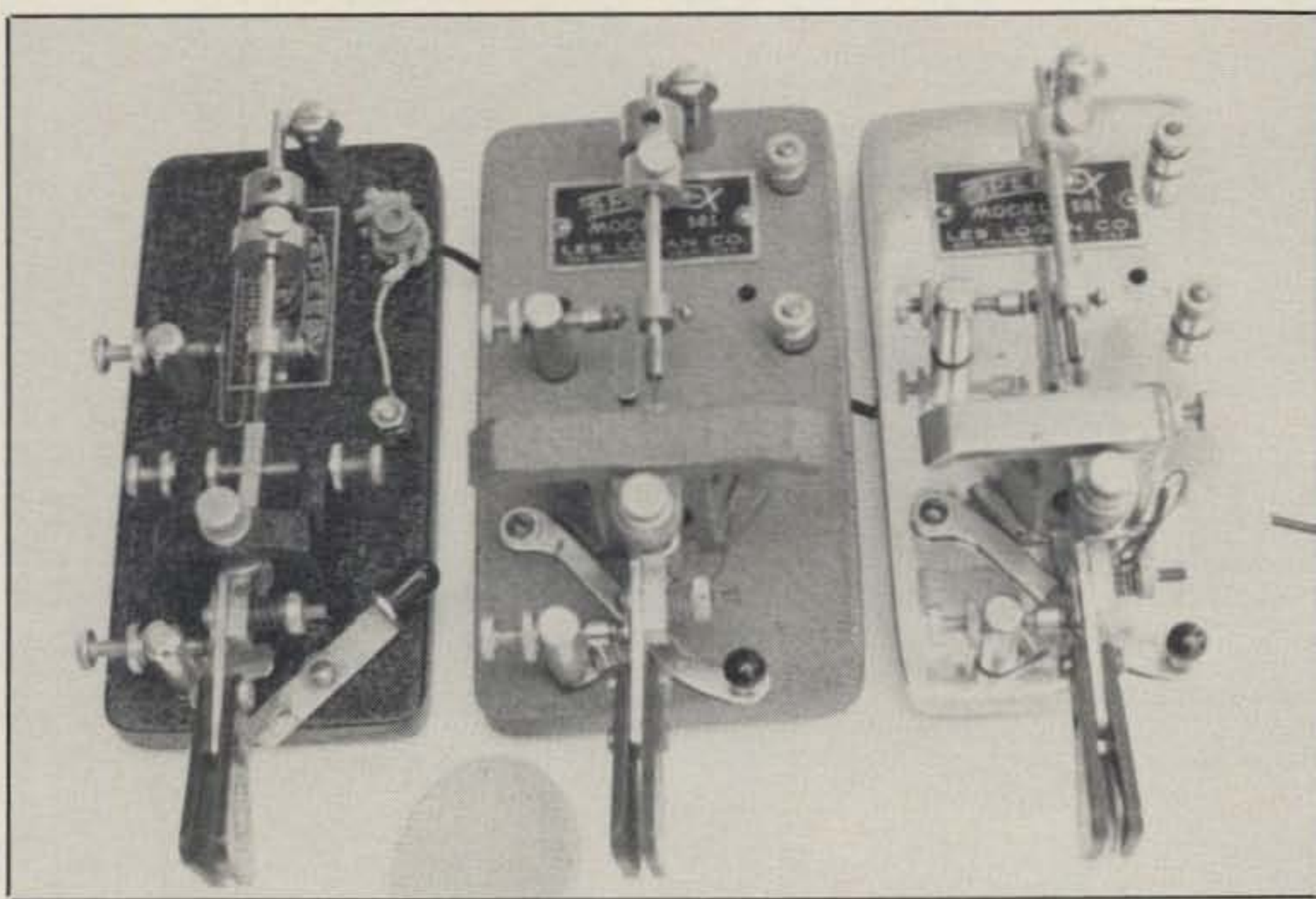

Photo 6- The Speed-X team used daily by K4TWJ. The bug on the left has the E.F. Johnson name and a 3 inch base like Junior in photo 4. The two bugs on the right are Les Logans and have 3½ inch bases like Vibroplex Originals. The round foam item between bugs one and two is a windscreen for mobile use. (See text for details.)

collection. The left item carries an E.F. Johnson label and has a 3 inch base like the previously discussed Vibroplex Zephyr or Junior. Jerry, K9UT, passed this delightful bug over to me, and I love it (note tell-tale cable to rig)! The bug is a docile little critter with a great feel and a wee tad of paddle "feedback," and it can be slowed to 10 wpm with only two weights.

The middle Speed-X sports a Les Logan nameplate, and it has the same congenial personality as the little Johnson Speed-X. I acquired this gem from CQ contributor Ted Cohen, N4XX. It has a

3½ inch base like a Vibroplex Original, except this model 501 is battleship gray. It also has replaceable dot/dash contacts and a Tee Bar for carrying.

The Speed-X on the right is an all-chrome/deluxe 501, but it has only half a Tee Bar. Surprisingly, this bug's feel is more like that of a regular Vibroplex. My only explanation is every mainspring is different, and that is the main factor in each bug's personality. That's true, and you heard it right from the voice of prophecy!

The small and barely visible item in lower part of photo 5, incidentally, is a

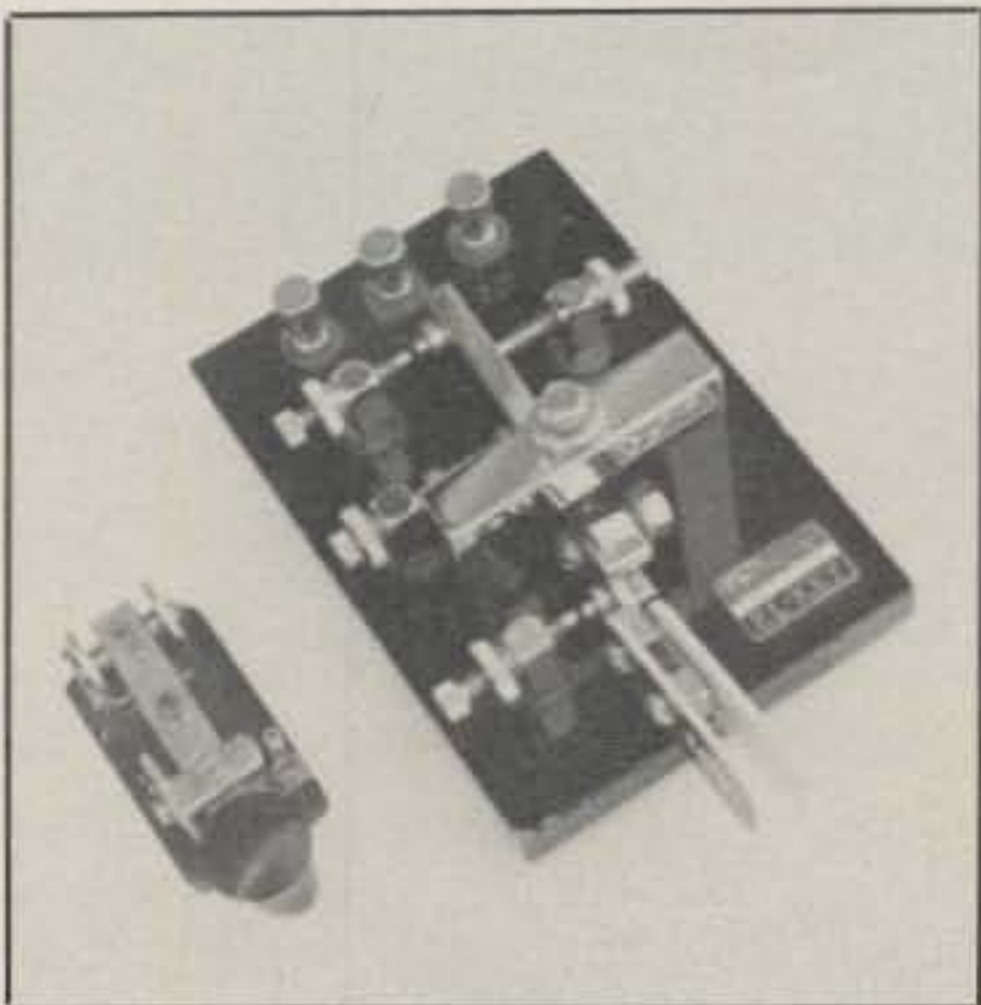

Photo 7- The item on the left in this picture is a miniature lineman's hand key from India. On the right is an EI Key paddle from France. (K4TWJ collection.)

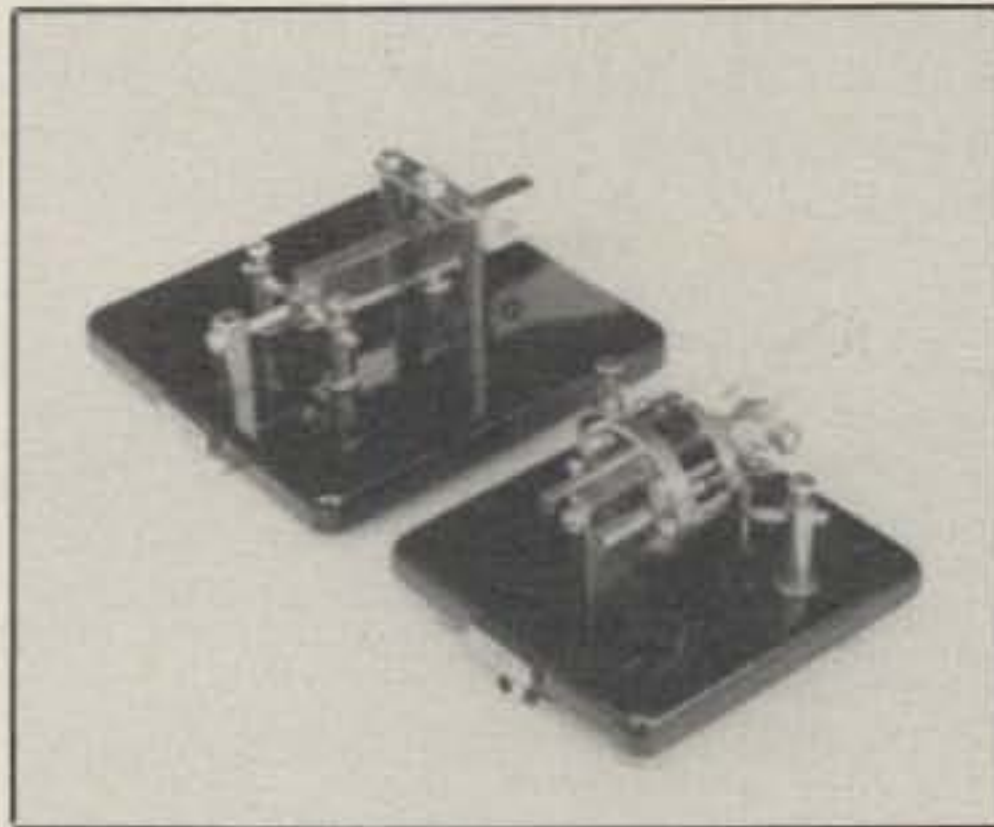

Photo 8- These beautiful hand-crafted paddles are being made right now by Gordon, G4ZPY, in England. They look like fine jewelry and handle like silk. Single Paddle model has a white fingerpiece. Dual Lever has clear plastic fingerpieces. (N4LMY keys.)

**"The Best Prize Life has to Offer is the Chance to Work Hard, at Work Worth Doing"**

*Teddy Roosevelt*

CIE, the world leader in home study electronics, provides the quality training and hands on experience you'll need to excel in these exciting career opportunities in electronics.



**Data Communications**



**Avionics**



**Computer Assisted Manufacturing**

**Research and Development Technician • Medical Technician • Junior Engineer • Instructor • Instrumentation Technician • Field Service Engineer • Engineering Technician • Design Technician • Computer Technician • Automated Equipment Technician • Digital Technician • Automotive Technician • Audio Technician • Customer Engineer • Robotics Engineer • Industrial Maintenance Technician • Mobile Radio Technician • Marine Technician • Communications Technician • Transmitter Engineer • Broadcast Engineer...**

If you want a job worth doing you'll need the education CIE has been providing their graduates (over 150,000 of them) for over half a century.

Getting started is easy! Just fill out the coupon below and mail it today for your free catalog about the facts on a career in Electronics.

Name \_\_\_\_\_  
 Address \_\_\_\_\_  
 City \_\_\_\_\_ State \_\_\_\_\_ Zip \_\_\_\_\_  
 Age \_\_\_\_\_ Phone (\_\_\_\_) \_\_\_\_\_

**CIE**

CLEVELAND  
 INSTITUTE OF  
 ELECTRONICS  
 1776 East 17th Street  
 Cleveland, Ohio 44114  
 (216) 781-9400

ACQ-16



Photo 9- Unique cut-in-crystal version of a hand key sitting atop a dome. This conversation piece was presented to Evelyn Garrison, WS7A, by Soviet competitors at WRTC '90. (WS7A photo.)

wind screen I use on my bug's finger-piece for mobile work. It reduces road rumble and wind noise, you know.

### Photo 7

Let's now shift to more recent items of interest. If you were hamming during the late '50s, you probably remember a US-made electronic keyer paddle called the EI-Key. The EI-Key in this picture, however, was made by Poucel Electronics of France. It has a blue, white, and red nameplate and heavy black base. Construction is quite rugged, yet it has a very smooth feel. My EI-Key's fingerpieces were broken, so I replaced them with handmade ones sporting my call.

The small item in this photo is an Indian "spy key." Actually, it is a telegraph line-man's test key. The "spy" term evolved from its small size. The key's parts are nickel-plated brass. They are mounted on a plastic base. The knob's design reflects British influence. I acquired this key from Charles, N4LMY, who purchased two from a chap listed in CQ's classified ads. Read our magazine's rear pages closely, gang. There's gold hidden in those hills!

### Photo 8

Okay, modern-day key buffs, here are two destined to become classic beauties you can purchase right now and enjoy using with the electronic keyer built into your deluxe home transceiver. These paddles are meticulously handcrafted like fine jewelry by Gordon Crowhurst, G4ZPY (41 Mill Dam Lane, Burscough, Ormskirk, Lancs, L407TG England). The Single Lever model (left) has highly polished and glazed brass parts mounted on a glossy black steel base. Particularly unique is its single front spring adjustment and its tiny ball bearing race assembly at the main arm's pivot point.



Photo 10- A commemorative version of this WRTC-awarded keyer is being made in limited quantities by MFJ Enterprises. The word "winners" is replaced by "WRTC '90." (Details in text.)

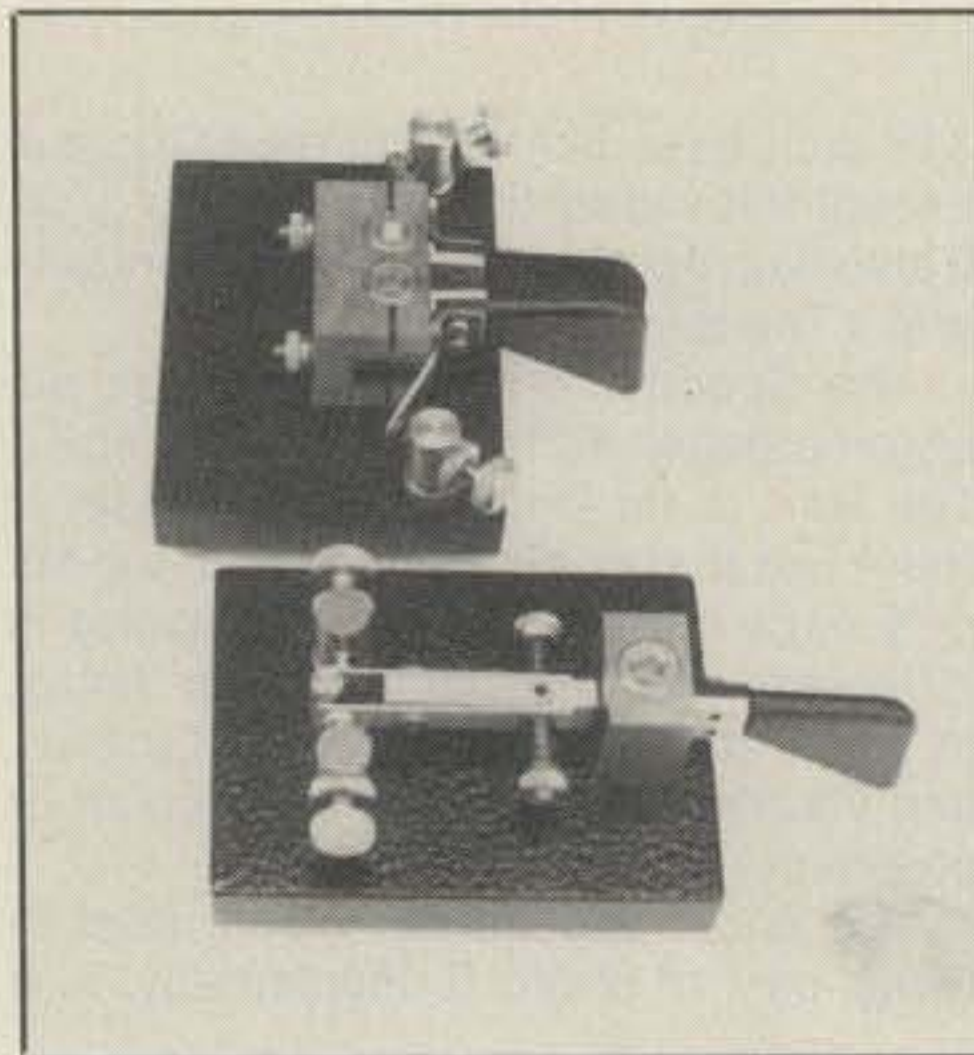

Photo 11- These two presently available Kent paddles look good, handle great, and are built like a battleship. (K2EEK collection.)

The Twin Paddle also has highly polished brass parts mounted on a similar glossy base. Its pivot points also have mating concave and convex surfaces that wear in rather than out with use. Both G4ZPY keys are very precision instruments. Their contacts are typically set for 1 to 3 thousandths of an inch clearance, for example, with an automotive feeler gauge. These paddles are perfect for effort-free CW, and they add elegance to any setup.

I learned of G4ZPY's keys from his CQ ad and through Charles Tryor, N4LMY. Charles bought a pump key and the paddles shown here. He and Gordon became

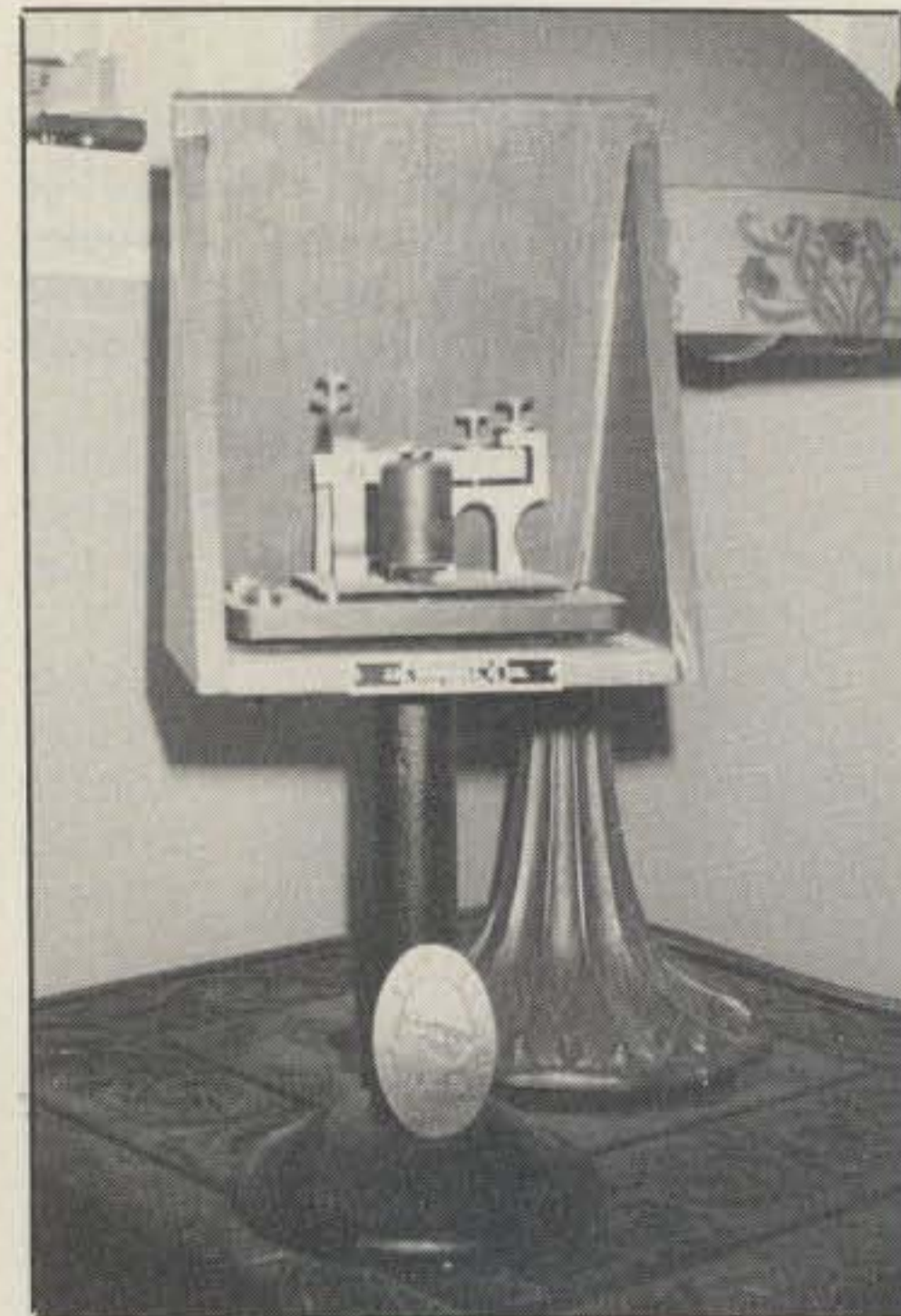

Photo 12- This is a mint-condition J.J. Bunnell & Co. sounder and sounder box. The brass object resting on the base is an employee's badge from the Postal Telegraph Union.

pen pals, so Charles offered to mail info and price lists of G4ZPY keys to US inquiries. Key orders, however, should go directly to G4ZPY in England. A helpful hint: To avoid the additional and high cost of exchanging dollars and pounds, order via your MasterCard or Visa. A computer automatically makes the conversion, and

## 2m Amateur Transverter

Convert Your 10m Multimode Transceiver to a 2m Multimode Transceiver



ST144-28 model shown

I.F.: 28-30 MHz — R.F. 144-146 MHz

Transmit Section: 15 watts output; Spurious—40 dB typ.  
Receive Section: Low Noise; 20 dB conversion gain

Other Products Available

Model	Description	Price
ST144-28	2m Transverter	\$259.00
ST220-28	220MHz Transverter	\$259.00
WJ-100	2 water cooling jackets with rubber gaskets for 7289 and 7815R tubes	\$20.00

### 2-way Coaxial Power Dividers (N-connectors)

SPD2-144/432N	2m/70cm	\$49.00
SPD2-220N	220MHz	\$49.00
SPD2-902N	33cm (902-928MHz)	\$49.00
SPD2-432/1296N	70cm/23cm	\$49.00

### 6 foot Coaxial (RG213) Jumper Cables

SJU-NM-NM	N-Male : N-Male	\$30.00
SJU-NM-NF	N-Male : N-Female	\$30.00
SJU-NM-UM	N-Male : UHF-Male	\$30.00
SJU-UM-UM	UHF-Male : UHF-Male	\$30.00

### Available from:

East Coast Amateur Radio, Inc.  
496 McConkey Drive  
Tonawanda, New York 14150  
(716) 835-8530

Complete line of Amateur Products available

CIRCLE 73 ON READER SERVICE CARD

Manufactured by: **Sinclabs Inc.**

Specialty Products Division  
85 Mary Street  
Aurora, Ontario L4G 3G9

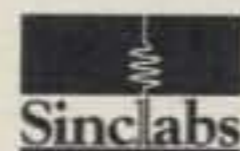

## DUPLEXERS

PROFESSIONAL DUPLEXERS FOR APPLICATION IN THE TWO METER, 220, AND 440 MHz AMATEUR BANDS. OTHER MODELS ARE AVAILABLE FOR UHF ATV AND 1.2 GHz.



MODEL 28-66-02A (442-450 MHz)

100 dB ISOLATION AT 5.0 MHz SEPARATION  
350 WATT POWER RATING

The TX RX Systems Inc. patented Vari-Notch® filter circuit, a pseudo-bandpass design, provides low loss, high TX to RX, and between-channel isolation, excellent for amateur band applications. TX RX Systems Inc. has been manufacturing multicoupling systems since 1976.

### TX RX SYSTEMS INC.

8625 INDUSTRIAL PARKWAY, ANGOLA, NY 14006  
TELEPHONE 716-549-4700 FAX 716-549-4772 (24 HRS.)

CIRCLE 99 ON READER SERVICE CARD



### Antenna Mounting Hardware

Side Mount—Vent Mount—Wall Mount  
Roof Mount—Chimney Mount  
Alliance Rotors Model U-110  
Ground Wire—A-B Switch—Ground Rod  
3 Foot Tripod—VHS Rewinder

SASE For Catalog

Antenna Service • 165 Olympia Street  
Pittsburgh, PA 15211

(412) 431-5171 or (412) 431-9330

Ask for Joe, KA3TDQ



### Call Sign Jewelry Shows Your Pride

14 Karat Gold jewelry with your Call Sign. Collar pins, necklaces, tie pins, lavalieres, charms, Operator Rings, Call Sign Watches. Look great! Quality craftsmanship. Send for free information:

KB2MB, H&M Jewelry

26 Edgecomb Road • Binghamton, NY 13905  
607-797-5458

## TNR The Battery Store

If You're Serious About Radios  
You Want The Best Batteries!

### Sanyo Battery Inserts

ICOM	Kenwood
BP-2.....\$14.00	PB 2500.....\$18.00
BP-3.....15.00	PB 2600.....18.00
BP-5.....21.00	PB 2400 (Tabs) 15.00
BP-7.....23.00	PB 2100.....12.00
BP-8.....21.00	

### Complete Replacement Battery Packs

Yaesu	
FNB-1.....\$24.00	FNB-11.....57.00
FNB-2.....24.00	FNB-12.....47.00
FNB-4.....58.00	FNB-14.....48.50
FNB-10.....37.00	FNB-17.....39.50

ICOM	
BP-2.....\$36.50	BP-7.....65.00
BP-3.....35.50	BP-8.....65.00
BP-5.....42.50	BP-11.....65.00

Add \$3.00 Shipping

### SPECIAL!

Sanyo "AA" Nicad Batteries.....\$1.50 each

Complete Line of Sanyo Nicads, Gell Cells, Lithium, Cordless Telephone, Camcorder and Computer Batteries

MasterCard VISA FREE CATALOG

**1-800-346-0601**

FL Residents Add 6% Sales Tax

TNR Technical, Inc.

279 Douglas Ave., Suite 1112

Altamonte Springs, FL 32714

(407) 682-4311

## THE BEST DEALS FOR BUYERS AND SELLERS

All radios  
All accessories  
All brands

Sell your gear  
at top dollar  
Never an ad fee

The superior way  
to exchange quality  
used equipment risk free!

Whether you're shopping  
or selling call us first!

## INTERNATIONAL RADIO EXCHANGE

To Sell, Place An Ad Or Buy

**1-800-321-1069**  
(914) 425-2429

Monday-Saturday  
12:00 Noon • 12:00 Midnight

I.R.E.  
19 Ann Boulevard  
Spring Valley, New York 10977

**Factory  
Authorized  
CLOSE OUT**

**AEA'S  
10 Meter  
DX Handy**

Surplus Sales has the last remaining stock of 10 Meter DX Handies and we are closing them out at a 50% savings! This is your last chance to purchase a classic AEA Handy. 6 Meter units are sold out!

**Features:**

- 2- VCOs (Variable Crystal Oscillators), each tuning 50 KHz with a top selectable crystal from 28.0 - 29.0 MHz. Crystals for 28.25 - 28.30 & 28.30 - 28.35 included.
- SSB operation with a built-in microphone, or plug your own into optional jack.
- CW operation with push-button key or use your keyer when plugged into optional jack.
- Powered by six AA batteries (supplied) or seven AA Nicads.
- Noise blanker, switchable from top, is included.
- Telescoping, boom loaded antenna included.
- 5-Meter, power output meter.
- Optional card for external DC operation is included.
- Many crystals available for added frequency coverage.
- Operate QRP with a quality rig.

**Now only \$159 singly**  
or **\$300 per pair**

Please add \$3 per H.T. for UPS

**Surplus Sales of Nebraska**

1315 Jones St. • Omaha, NE • 68102 • 402-346-4750 • fax: 402-346-2939

CIRCLE 115 ON READER SERVICE CARD

**AEA'S  
AT-300  
Antenna Tuner**



**Limited Time Offer**

**Features:**

- 300 Watts continuous power handling capability will handle most any rig.
- 3.5 - 30 MHz (Don't overlook this superior tuner just because it does not cover 160 Meters! After all, when was your last 160 Meter contact logged?)
- Low Pass Filter's two-coil design provides greater harmonic reduction, more power transfer and a wider range of impedance matches than most tuners on the market.
- Peak reading cross-needle meter shows forward power, reflected power and SWR.
- All steel, quality cabinet is 12.8" W x 15" D x 5.8" H. Weight is 8.14 pounds.
- Large cabinet provides more internal space for higher "Q" and greater efficiency.
- High and low power switch for versatile operation.
- 6 position "Antenna Selector" switches between 2 coax fed inputs, both tuned and bypassed, a dummy load position and balanced or wire antenna.
- Back lit meter is switchable from front. 12 volts must be supplied externally to jack on back.
- Still want to more facts? Then dig out your April 1990 CQ and read Lew McCoy's review!

**Now only \$145**

U.S.: Please add \$4.50 per Tuner for UPS. We pay all shipping on 2 or more AT-300s.

With all of these features, the regular Ham Net price of \$219 is a bargain. So, at Bob's new low price of \$145 (66% off), this may be the best deal in Ham Radio, ever!

Catalog 6, 200 pages, over 10,000 electronic PARTS, is in production. Those of you who are waiting, we appreciate your patience! A free copy will be sent to you if an order is or has been placed, when available. Otherwise, send \$3 a/carte (US delivery) or \$5 (DX). We accept Visa, MC, American Express, checks (TeleCheck used, please give driver's license #). Cash On Delivery (UPS only, no US Mail CODs) add \$3.

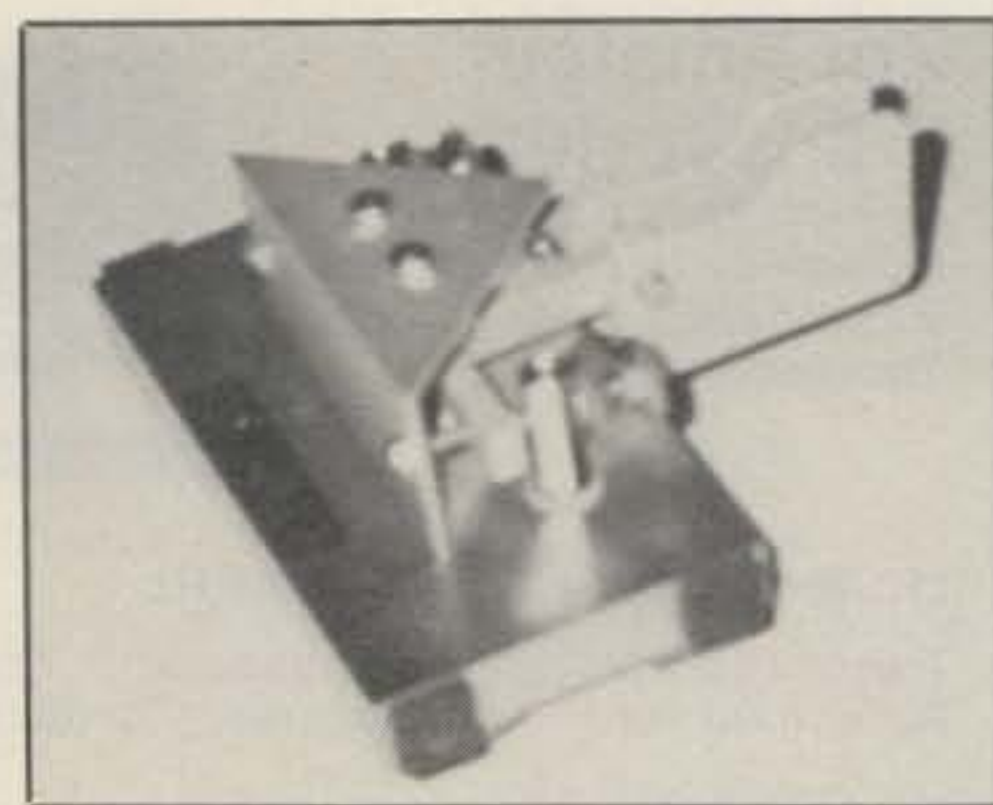

Photo 15- A modern-day key imported from West Germany is this one made from aluminum and manufactured by Samson.

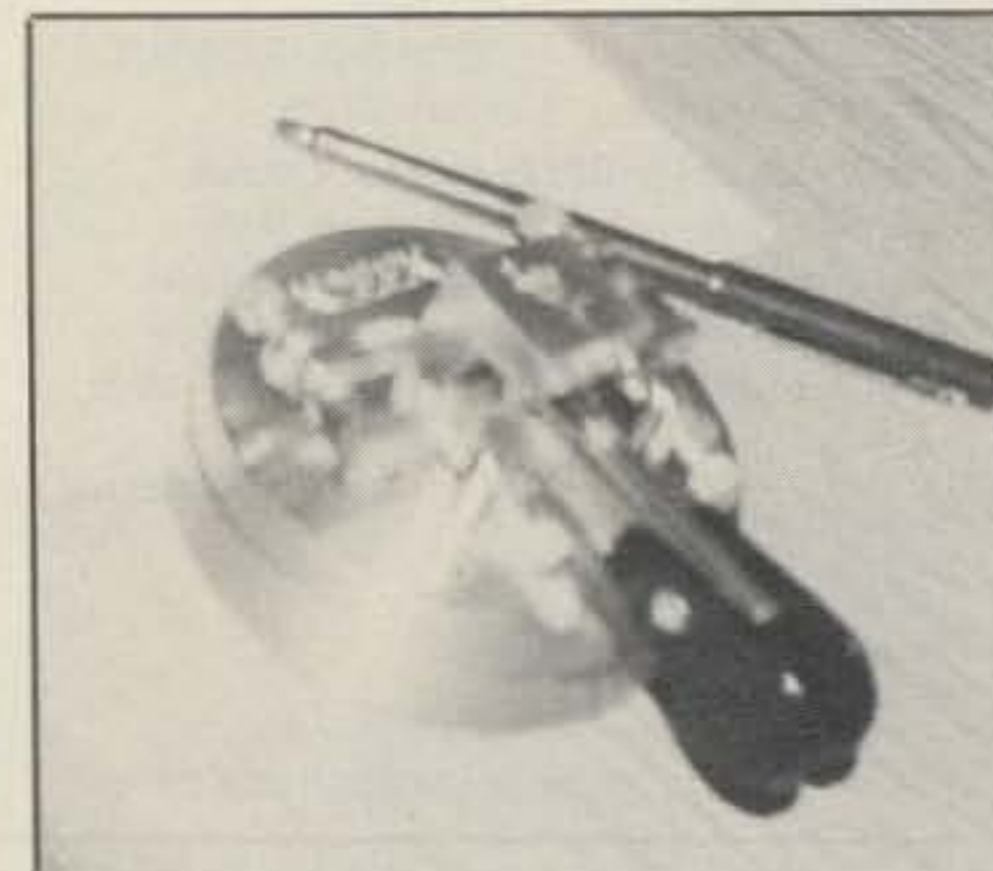

Photo 16- This key is bound to become a collector's item. Featuring magnetic contacts and made from machined brass, these keys are hand-made by Steve Nurkiewicz, N2DAN/4, who lives in Florida.

you save \$15 or \$20. I learned of that technique from the English magazine *Radio Bygones*, which recently expanded to include the outstanding *Morse Magnificat* magazine that highlights old-time keys. *Radio Bygones* is a terrific magazine if you like classic rigs and keys. It is loaded with good info. Charge-card subscriptions go to: Radio Bygones, 8 Corfe View Rd., Corfe Mullen, Wimborne, Dorset, BH21 3LZ England.

**Photo 9**

This unbelievably unique conversation piece is a cut-in-crystal version of a hand-key sitting atop a similar clear dome. It was made in Russia and presented to Evelyn Garrison, WS7A, by the Soviet competitors in WRTC '90 (last month's feature story). It may well be the only one of its kind in the world. Inscribed inside the dome is "AREL," their equivalent to our own ARRL. Truly a fascinating item!

**Photo 10**

This WRTC-related item also has an interesting story to share. First, the unit is a combination Curtis keyer and Bencher paddle MFJ Enterprises sells as a self-contained electronic keyer (Model 422-B). The keyer shown here was customized with a silk-screened logo of WRTC '90 and six models were presented to the six WRTC winners. MFJ is now replacing the word "winners" with "WRTC '90" (and retaining the logo) and making it available to interested amateurs. This is a limited-edition key, so contact MFJ directly to order (telephone 1-800-647-1800).

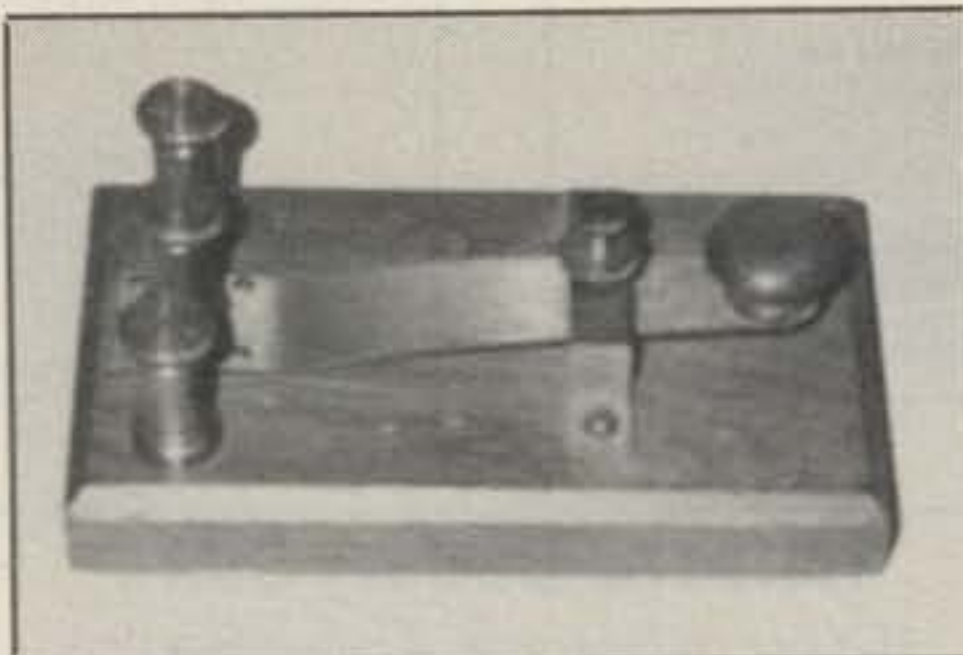

Photo 13- Also from J.J. Bunnell & Co. is this example of their strap key.

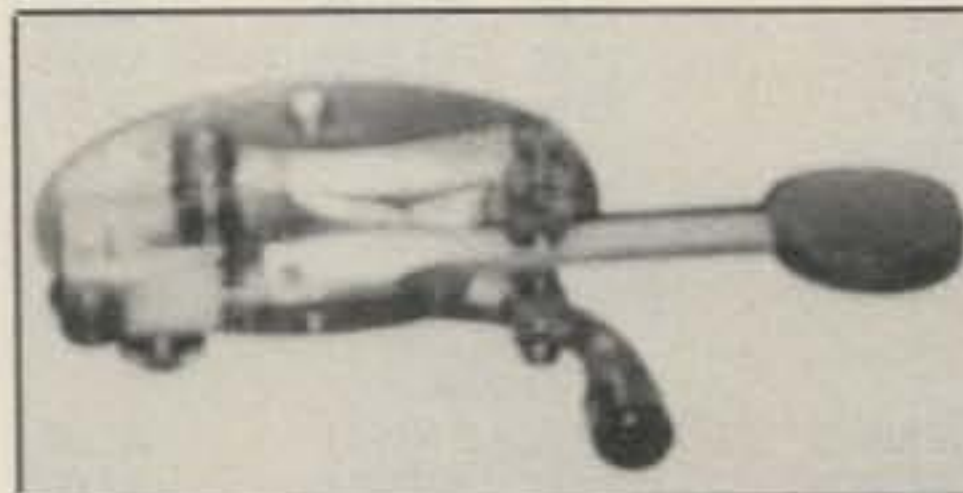

Photo 14- One other J.J. Bunnell & Co. item is their famous "sideswiper" key.

**Photo 11**

Here we have two very impressive paddles available right now in kit form from R.A. Kent (Engineers), 243 Carr Lane, Tarleton, Preston, Lancs, PR46YB England. Assembly is fairly easy and takes roughly an hour. The Single Lever model (lower area of picture) has a solid-brass arm that manipulates brass strips on each side for making dots and dashes. Springs fitted against knurled nuts on

fine-pitch screws adjust tension on each side. A permanently lubricated ball bearing assembly is set into the brass yoke at the pivot point.

The Dual Lever paddle (upper area of picture) has dual ball-bearing assemblies and neat rear adjustments for each arm's tension. Arm travel is set by a fine-thread screw on each contact's post. Both paddles have a very comfortable feel, and construction of these paddles is superb. These Kent keys, incidentally, are part of CQ Editor Alan Dorhoffer's collection. Photos 12 through 16 are also from K2EEK's collection.

That winds down another "Keys Special," and we trust you enjoyed the views. Shall we do it again next year? You tell me. Let's see more pictures of your unusual key items and hear more tales of their use. Meanwhile, I will look forward to chatting with all of you on 30 CW week-nights or on 14.180 to 14.225 Sundays 2200-2300 GMT.

73, Dave, K4TWJ

# ALL PURPOSE TERMINALS



MANUFACTURED BY  
RCA

**\$75**

RCA's APT is a high quality, self-contained computer, a smart terminal, loaded with many features. Originally selling for about \$500, this terminal is a super value for anyone needing a computer to access bulletin boards, word process, operate a TNC on PACKET RADIO or simply free up a larger PC.

- Built-in dual speed telephone modem with RJ-11 port for easy hookup.
- Composite video or RF (channels 3&4) allow use of either a monochrome or TV type monitor.
- Parallel printer port for connection of a Centronics type printer.
- Serial (DB-25) RS-232 port allows connection of TNC, hard drive, modem or other peripheral.
- Keyboard selectable 40 or 80 column display.
- Built-in word processor with word wrap feature.
- All terminal parameters are fully adjustable allowing emulation of many terminal systems.
- Also includes acoustical coupler input, auto log-on, 8 customizable function keys plus more!

Our APT's are very clean units removed from service. Instruction manual, wall cube power supply and TV/APT selector switch included. Optional 6' Centronics printer cable - \$25. Optional DB-25 male Gender Changer - \$7.95. Add \$5 for UPS.

**SPECIAL: Purchase our RCA APT today, along with a PK-232MBX Controller and we will pay the shipping anywhere in the cont. U.S., an \$8 value (DX orders \$8 credit).**

## IRON POWDER TOROID CORES

CORE	O.D.	I.H.	I-10	I1-99	CORE	O.D.	I.H.	I-10	I1-99	CORE	O.D.	I.H.	I-10	I1-99
15-6	.850"	10	35	25	144-2	.440"	57	70	60	115F-4	1.57"	115	3.25	2.75
112-7	1.125"	40	35	30	144-4	.440"	41	70	60	1200-2	2.80"	170	4.00	3.60
112-6	1.125"	37	35	30	150-2	.500"	49	80	68	1200-6	2.80"	100	4.75	4.25
112-17	1.125"	7.5	40	35	150-4	.500"	40	80	68	1200-12	2.80"	900	3.00	2.40
116-52	1.60"	150	35	30	150-17	.500"	18	90	78	1225-28	2.25"	215	6.00	5.40
125-2	2.55	34	40	35	150-26A	.500"	420	90	78	1225-4	2.25"	190	6.00	5.40
125-4	2.55"	37	40	35	150-28	.500"	330	80	68	1300-2	3.04"	114	6.00	5.40
125-17	2.55"	12	40	35	168-2	.695"	57	80	68	1300-30	3.04"	228	13.00	12
130-2	3.00"	43	40	35	168-6	.695"	67	80	68	1300-52	3.04"	850	8.00	7.20
130-4	3.00"	38	40	35	168-12	.695"	490	80	68	1400-2	4.00"	180	13.00	12
130-17	3.00"	18	40	35	180-2	.795"	55	95	82	1400-30	4.00"	240	22.00	20
130-52	3.00"	73	40	35	180-6	.795"	45	95	82	1400-52	4.00"	1400	12.00	11
130-2	3.75"	40	40	35	180-12	.795"	500	85	72	1520-2	5.20"	300	22.00	20
130-4	3.75"	35	40	35	1130-4	1.30"	15	100	140					
130-17	3.75"	15	40	35	1130-2	1.57"	140	3.25	2.75					

Toroid cores are used in most radio frequency projects because of their relative small size. EMI/RFI filters are made with a core in the interference's frequency range. The suffix of each core (eg. -2 or -6) indicates the mix.

- 2 mix - Maximum Q range: 25-10 MHz. Permeability (μ<sub>0</sub>)=10. RF transformer below 1.0 meters.
- 6 mix - Maximum Q range: 2-30 MHz. Permeability (μ<sub>0</sub>)=6.5. RF transformer to 10 meters.
- 17 mix - Maximum Q range: 20-200 MHz. Permeability (μ<sub>0</sub>)=4.0. RF transformer HF-VHF.
- 26 mix - Maximum Q range: DC-8 MHz. Permeability (μ<sub>0</sub>)=7.5. DC, 60 Hz and EMI/RFI filtering.
- 52 mix - Maximum Q range: DC-1 MHz. Permeability (μ<sub>0</sub>)=7.5. DC, 60 Hz and EMI/RFI filtering.

\* Note: Toroids operate at 4 to 100 times the stated frequency range with reduced Q and efficiency.

**"Where the hard to find parts are found..... and on hand"**  
 3-500Z Grounded Grid Sockets \$ 29 SG-230 Smarttuner, Incredible Auto Tuner \$495  
 DL4-40 Termination, 4 GHz @ 40 watts \$135 DL1.5-75 Termination, 1.5 GHz @ 75 watts \$145  
 1/2" x 8" FERRITE Rods, DC-30 MHz \$ 15 COLLINS Equipment Overstock SALE! Make Offer!  
 Transformer, new, for KWM-380, 34 v.c.t. (2 x 17 v.), 20 amp, 105 to 250 v primary \$ 50

Catalog 6 included with your order (or sent upon completion) [\$3 a/c to carts US or \$5 DX]. 200 pages, over 10,000 electronic PARTS. Please add adequate shipping, 30¢ per lb. to 70 lbs. (1st - 3lbs, add \$3 min). We accept Visa, MC, Amexco, checks, Cash On Delivery (UPS), add \$3.

**1315 Jones St. • Omaha, NE 68102**  
**402-346-4750 • fax: 402-346-2939**

## NEW COLLINS PARTS

We purchase Collins replacement parts from many of the same vendors used by Collins, made to original specs. You have the choice. Keep it original for optimum operation and resale.

Manuals: Brand New, Fresh and Crisp!! KWM-2 & 2A, 315-1, 305-1, 325-3A, 73A-4, 539, 735-3B & C, 755-1, 325-3, 532, 755-3A, A, 325-1, 30L-1, 535, 1805-1, 516F-2, 519, 312B-4 & 5, 522, 22V-3, 75A-3, 595, HF-380 Operators Manual, 138A 1(B) Blanket - \$20, 4515-1 - \$165, Photo Copied: HF / KWM-380 Service - \$99, PM-2 - \$5, MP-1, 516E-2 - \$30, 180L-2 & 3, R390, R390A, 550-1 - \$75, 32V-1, 2 or 3 - \$65, 511-2, 3 or 4 - \$50, 425-1, 75A-1, 2 or 4, KWS-1 - \$49, 299B-4 or 5, 399C-1 - \$15, 671B-1 - \$95, 789T-1 - \$140.

Plastic Trim Rings: Large fit all S-Line and KWM-2. Small fit 516F-2, 312B-3, 4 or 5. \$29ea. or 4/5100 Front Feet Extensions: Aluminum, tapered, black anodized feet rig up. \$8 ea. or 6/542 Point: (1/2 oz. spray) Primer-Zinc Chromate, Collins Trim Ring #126 Gray, Cabinet #180, Front Panel #250, St. James Gray #270, KWM-380 Cabinet Earth Brown. (1/2 pt. can) KWM-380 Front Panel or Cabinet. \$17ea. or 4/5180 Power Cards: \$15-1 - \$21.95; 75S-1 - \$15; 516F-2 power - \$9.95; 516F-2 interconnect - \$38.95 Crystals, operating frequencies: HC 6/U holders. \$8 each or 5 or more, \$7 Crystals, BFO, Calibrator: 456.350, 453.650 & 455.8 KHz - \$35 each 100 KHz - \$42 each

KWM-2A Plug-in Relays: 970-2439-010 (X96) or 970-2439-020 (X97) \$49.95ea. or 4/5180 KWM-2A Plug-in Relay Mod Kit: Converts open frame to plug-in relays, incl. instructions, relays & misc. \$119 TR Relay for KWM-2/A, 325- & 30L-1: Authentic KR-2565-1 P&B Relay \$50ea. or 4/590 Panel Meters: New Meters for most all Collins equipment. \$85

Plastic Trim Rings: Large fit all S-Line and KWM-2. Small fit 516F-2, 312B-3, 4 or 5. \$29ea. or 4/5100 Mechanical Filters: S-Line: 500 Hz CW (526-9494-00) \$29ea. • 1500 Hz RTTY/SSB (526-9495-00) \$325 ea. 75A-4, 6 kHz AM (526-9091-00) F-4.55J60 \$399ea. • 500 Hz CW (526-9154-00) F-4.55J60 \$399ea.

Oak Switches for Collins: New LOW PRICES! KWM-2/A Function Switch (259-1075-00) \$50 • 755 Function Switch (259-9949-00) \$35 • 10070-4 on/off "ALC" end switch for repair of KWM-2 & 325 Function Switch. \$12 ea. 4/540 Optional Crystal Disk Water for modification of 755-3 or KWM-2 when adding extended frequency coverage (269-1177-00) \$16

Potentiometers: KWM-2 & 325 Mic Gain (376-7404-00) \$29ea. • 755 AF/RF Gain (376-2151-00) \$32ea. 30L-1: Power Switch - \$19; Plate Choke, L-121(44)H - \$10; 100μF-450V Filter Caps - 6/\$40 Power Transformers: 516F-2 - \$145, 30L-1 - \$190, 515-1 - \$90, KWS-1 - \$225, PM-2 - \$125 KWM-380 to HF-380 Conversion Kit: Includes A3 Filter, 040 RDM, instructions and HF-380 Emblem. \$525 MM-280 Mobile Mike - \$35; AC-2830 Headset - \$35; AC-2801 Rack Mount - \$165; AC-282B Footswitch - \$45; AC-3802 Speech Processor - \$330; 140 Hz CW Filter - \$199; 360 Hz CW Filter or 1.7 KHz RTTY/SSB Filter - \$139 & KHz AM Filter - \$99; Complete Knob Set - \$99.

**COLLINS EQUIPMENT ON HAND:** 511-5, 511-4, 511-3, 75A-4, 75A-1, 32V-1, 325-1, 325-3, 755-1, 755-2, 755-3, 755-3B, 755-3C, KWM-2, KWM-380 (converted to HF), 30L-1, 30S-1. Other COLLINS Parts On Hand: IF Transformers, Front Panels, Escutcheons, Knobs, Transformers.

3-500Z (JEKAC) \$145 (PENTA) \$110	<b>Cover Craft Dust Covers</b>
4-400A (JEKAC) \$189 (PENTA) \$169	Complete selection for ham rigs including:
4CX1000A (PENTA) \$499	Collins KWM-2, 325, 755, 312B-4 & 5, KWM-380,
572B (JEKAC) \$75 (PENTA) \$68	811A (PENTA) \$15 (HORIZ USE) \$22
811A (PENTA) \$15 (HORIZ USE) \$22	30L-1, 51-1, Drake: R4, T4X, MS4, RV4, SPR4, TR4,
6146B (PENTA) \$15 (MTH PAIR) \$38	MM2000, TR6, L7, L75, Icom, Kenwood, Yaesu,
4CX250B (PENTA) \$95	Alpha, Heath....All CoverCraft models stocked!
4CX300A (PENTA) \$145	
6JB6A, 6KV6A, 6KM6 \$15.50	<b>Each for one low price..\$8.95</b>
6LQ6, 6KD6, 6JS6C \$16.50	<b>Special: 5 or more \$7.95 ea</b>
6LB6, 6MJ6, 12JB6 \$17.50	

## Other AEA products at super prices!

Shouldn't you try AEA this time? Get the quality your paying for!

<b>DX Handy</b>	10 Meter Hand Held Transceiver	\$159
<b>PK-232MBX</b>	All mode TNC	\$319
<b>PK-88</b>	Packet only TNC	\$119
<b>IsoLoop</b>	14 - 30 MHz omni-directional Antenna	\$315
<b>MM-3</b>	Memory Keyer (Morse Machine)	\$179
<b>AVT</b>	Amiga Video Slow-Scan	\$279
<b>ET-1</b>	300 watt all band tuner	\$125
<b>DL-1500</b>	650MHz, 1500W Dummy Load	\$109
<b>HPF-1</b>	75/300Ω High Pass Filter for TV/VCR	\$ 12
<b>144 MHz IsoPole</b>	Antenna for 2 Meters, omni-directional	\$ 55
<b>220 MHz IsoPole</b>	Antenna for 220, omni-directional	\$ 55
<b>440 MHz IsoPole</b>	Antenna for 416-465 MHz, omni-dir.	\$ 85
<b>AT-300</b>	300 watt antenna tuner *Special Price!	\$145
<b>AT-3000</b>	3000 watt antenna tuner	\$369

# Surplus Sales of Nebraska

# WARNING

## SAVE YOUR LIFE OR AN INJURY

Base plates, flat roof mounts, hinged bases, hinged sections, etc., are not intended to support the weight of a single man. Accidents have occurred because individuals assume situations are safe when they are not.

Installation and dismantling of towers is dangerous and temporary guys of sufficient strength and size should be used at all times when individuals are climbing towers during all types of installations or dismantlings. Temporary guys should be used on the first 10' or tower during erection or dismantling. Dismantling can even be more dangerous since the condition of the tower, guys, anchors, and/or roof in many cases is unknown.

The dismantling of some towers should be done with the use of a crane in order to minimize the possibility of member, guy wire, anchor, or base failures. **Used towers in many cases are not as inexpensive as you may think if you are injured or killed.**

Get professional, experienced help and read your Rohn catalog or other tower manufacturers' catalogs before erecting or dismantling any tower. A consultation with your local, professional tower erector would be very inexpensive insurance.

**Paid for by the following:**

**ROHN.**  
 6718 West Plank Road  
 P.O. Box 2000  
 Peoria, Illinois 61656

CIRCLE 88 ON READER SERVICE CARD

CIRCLE 51 ON READER SERVICE CARD

# Spider Antenna

Presenting the family of Spider™ Multi-Band Antennas

Four amateur bands (10, 15, 20, and 40 meters) at your command without having to change resonators or retune — just band switch your rig. Also available are the 75, 12, 17 and 30 meter bands. Needs no antenna tuner. Custom made with highest quality workmanship and materials.

**Wherever you roam, on Land or Sea . . . or even at Home**

**On Land**  
 Suitable for use on any motor vehicle from a compact automobile to a motor home or trailer. Work four bands without stopping to change resonators.

**Or Sea**  
 The Spider™ Maritimer is for use on or near the ocean. Highly polished stainless steel and nickel-chrome plated brass. Commercial marine frequencies (8, 12, 16 and 22 MHz) are also available.

**At Home**  
 If you live in an apartment, condominium or restricted area, the Spider™ may well be the answer to your antenna problems.

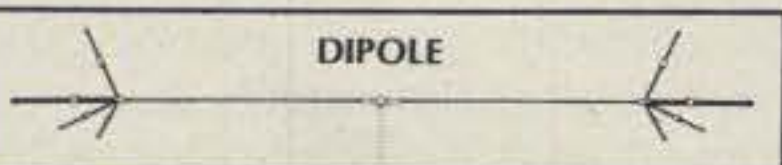

**MULTI-BAND ANTENNAS**  
 7131 OWENSMOUTH AVENUE, SUITE 263C  
 CANOGA PARK, CALIFORNIA 91303  
 TELEPHONE: (818) 341-5460

Say You Saw It In CQ

## THE SCIENCE OF PREDICTING RADIO CONDITIONS

The CQ World-Wide DX CW Contest will be held on the weekend of November 24 and 25. Last month's column contained comprehensive HF band-opening predictions to all areas of the world from North America for use during both the Phone and CW weekends. Special DX Propagation Charts for use during the CW weekend appeared in last month's column, along with several valuable tips and suggestions for piling up contest points. Be sure to refer to last month's column if you are planning to participate in the CW Contest weekend. Some additional tips are contained in this month's column, along with a sample multi-band contest operating schedule centered on the western half of North America.

### Sunspot Cycle Progress

Although there may still be some disagreement among the experts, it looks almost certain now that Cycle 22 has passed its peak and is slowly declining. The Royal Observatory of Belgium reports a monthly mean sunspot number of 147 for July. This results in a 12-month running smoothed sunspot number of 151 centered on January 1990. This is a drop of three points from the previous month's level, and a drop of almost eight points from the peak value recorded for Cycle 22 to date—a level of 159 centered on July 1989. A smoothed sunspot number in the low 130 range is expected during November 1990.

Corresponding to the drop in sunspot number, the 10.7 cm solar flux level also declined during July 1990. The Algonquin Radio Observatory at Ottawa, Ontario reported a mean level of 178 for the month. This results in a smoothed level of 200 centered on January 1990. A smoothed level in the low-to-mid 180 range is expected during November.

Be sure to check the Last Minute Forecast appearing at the beginning of this column for a day-to-day forecast of general conditions expected on the HF bands during November.

In addition to tips for the CW Contest weekend, this month's column contains Short-Skip Propagation Charts for use between distances of approximately 50 and 2300 miles, and between Hawaii and Alaska and the continental areas of North America.

11307 Clara Street, Silver Spring, MD 20902

### LAST MINUTE FORECAST

Day-to-Day Conditions Expected for November 1990

Propagation Index .....	Expected Signal Quality			
	(4)	(3)	(2)	(1)
Above Normal: 2-3, 22, 27, 30	A	A	B	C
High Normal: 1, 4, 6-7, 13, 19, 24-25, 28-29	A	B	C	C-D
Low Normal: 5, 8, 11-12, 17-18, 21, 23, 26	A-B	B-C	C-D	D-E
Below Normal: 9-10, 14, 16, 20	B-C	C-D	D-E	E
Disturbed: 15	C-E	D-E	E	E

Where expected signal quality is: A—Excellent opening, exceptionally strong, steady signals greater than S9.

B—Good opening, moderately strong signals varying between S6 and S9+, with little fading or noise.

C—Fair opening, signals between moderately strong and weak, varying between S3 and S6, with some fading and noise.

D—Poor opening, with weak signals varying between S0 and S3, and with considerable fading and noise.

E—No opening expected.  
3dB per S-Unit.

### HOW TO USE THIS FORECAST

1. Find propagation index associated with particular band opening from Propagation Charts appearing on the following pages.
2. With the propagation index, use the above table to find the expected signal quality associated with the band opening for any day of the month. For example, an opening shown in the charts with a propagation index of 3 will be good (B) on November 1, excellent (A) on the 2nd and 3rd, good (B) on the 4th, good-to-fair (B-C) on the 5th, etc. Good conditions (B) should occur during the CQ World-Wide CW Contest Weekend of November 24-25.

### CW Contest Tips

Look for excellent DX conditions on 10, 15, and 20 meters during the daylight hours from shortly after sunrise through sunset.

From sundown to midnight it should be a toss-up between 20 and 40 meters for DX honors. Openings on 20 meters should mainly be towards the quadrant extending from southeast through west to northwest, while 40 meters should open towards the north, east, and south.

Some good openings can also be expected during this period on 15 meters, particularly towards southern and western areas, and on 80 and 160 meters where propagation patterns should be similar to those on 40 meters, but with somewhat weaker signals and higher noise levels.

The best bands for DX propagation between midnight and sunrise should be 40 and 80 meters, with openings possible to most areas of the world, but peaking to-

### WW Contest Bulletin

Since this issue of CQ should reach most subscribers prior to the start of the CQ World-Wide DX Phone Contest weekend of October 27 and 28, here is an up-to-the-minute forecast made at press time for general HF propagation conditions expected during the Phone Contest weekend. The CQ crystal ball is now calling for considerably better than the Low Normal rating given in last month's column. It looks almost certain that at least High Normal conditions should exist on October 27th, as the contest begins. Openings to several areas of the world may approach Above Normal at times. Conditions may drop off somewhat on Sunday, October 28th, but they are expected to remain between Low Normal and High Normal to almost all areas of the world. The relatively quiet geomagnetic conditions expected, along with an expected sunspot number in the low 130s, should result in a great weekend propagationally for the 1990 WW Phone Contest.

The initial forecast for the CW Contest weekend of November 24 and 25 is very similar to the above forecast for the Phone Contest weekend. Great propagation conditions are also expected for the CW Contest. Generally High Normal conditions should prevail on Saturday, November 24th, and they are very likely to continue into Sunday the 25th. There will be a fine-tuned update for the CW Contest weekend as a bulletin in next month's column.

Although solar activity was in the high 150s during the 1989 contest weekends, it is possible that conditions during the 1990 contest will be as good as they were during the 1989 contest, and possibly somewhat better! This is all based on the hope that a Sudden Ionospheric Disturbance (SID) will not occur. While it is not possible to predict an SID, the chances of one occurring during the contest weekends are considered to be less than 15%.

wards the south, southwest, and west. Good openings should also be possible on 20 meters, but mainly towards the south and west. Also check for 160 meter DX openings during this period. Again, propagation patterns will be similar to



## HOW TO USE THE SHORT-SKIP CHARTS

1. In the Short-Skip Chart, the predicted times of openings can be found under the appropriate distance column of a particular Meter band (10 through 160 Meters) as shown in the left hand column of the Chart. For the Alaska and Hawaii Charts the predicted times of openings are found under the appropriate Meter band column (10 through 80 Meters) for a particular geographical region of the continental USA as shown in the left hand column of the Charts. An \* indicates the best time to listen for 80 meter openings.

2. The propagation index is the number that appears in ( ) after the time of each predicted opening. On the Short-Skip Chart, where two numerals are shown within a single set of parenthesis, the first applies to the shorter distance for which the forecast is made, and the second to the greater distance. The index indicates the number of days during the month on which the opening is expected to take place, as follows:

- (4) Opening should occur on more than 22 days
- (3) " " " between 14 and 22 days
- (2) " " " between 7 and 13 days
- (1) " " " on less than 7 days

Refer to the "Last Minute Forecast" at the beginning of this column for the actual dates on which an opening with a specific propagation index is likely to occur, and the signal quality that can be expected.

3. Times shown in the Charts are in the 24-hour system, where 00 is midnight; 12 is noon; 01 is 1 A.M.; 13 is 1 P.M., etc. On the Short-Skip Chart appropriate standard time is used at the path midpoint. For example on a circuit between Maine and Florida, the time shown would be EST, on a circuit between N.Y. and Texas, the time at the midpoint would be CST, etc. Times shown in the Hawaii Chart are in HST. To convert to standard time in other USA time zones add 2 hours in the PST zone; 4 hours in the MST zone; 3 hours in the CST zone, and 5 hours in the EST zone. Add 10 hours to convert from HST to GMT. For example, when it is 12 noon in Honolulu, it is 14 or 2 P.M. in Los Angeles; 17 or 5 P.M. in Washington, D.C.; and 22 GMT. Time shown in the Alaska Chart is given in GMT. To convert to standard time in other areas of the USA subtract 8 hours in the PST zone; 7 hours in the MST zone; 6 hours in the CST zone and 5 hours in the EST zone. For example, at 20 GMT it is 15 or 3 P.M. in N.Y.C.

4. The Short-Skip Chart is based upon a transmitted power of 75 watts c.w. or 300 wattsp.e.p. on sideband; the Alaska and Hawaii Charts are based upon a transmitter power of 250 watts c.w. or 1 kw p.e.p. on sideband. A dipole antenna a quarter-wavelength above ground is assumed for 160 and 80 meters, a half-wave above ground on 40 and 20 meters, and a wavelength above ground on 15 and 10 meters. For each 10 db gain above these reference levels, the propagation index will increase by one level for each 10dB loss, it will lower by one level.

5. Propagation data contained in the Charts has been prepared from basic data published by the Institute for Telecommunication Sciences of the U.S. Dept. of Commerce, Boulder, Colorado, 80302.

## CQ Short-Skip Propagation Charts November & December, 1990 Local Standard Time at Path Mid-Point (24-Hour Time System)

Band (Meters)	Distance From Transmitter (Miles)			
	50-250	250-750	750-1300	1300-2300
10	Nil	Nil	07-09 (0-1) 09-11 (0-2) 11-15 (0-3) 15-16 (0-2) 16-18 (0-1)	07-08 (1) 08-09 (1-2) 09-11 (2-3) 11-15 (3-4) 15-16 (2-4) 16-18 (1-4) 18-19 (0-3) 19-20 (0-2) 20-21 (0-1)
15	Nil	08-10 (0-1) 10-16 (0-3) 16-17 (0-2) 17-18 (0-1)	07-08 (0-1) 08-09 (1-3) 09-10 (1-4) 10-16 (3-4) 16-17 (2-4) 17-19 (1-4) 19-20 (0-3) 20-21 (0-1)	07-08 (1) 08-09 (3-2) 09-19 (4) 19-20 (3) 20-21 (1-2) 21-00 (0-1)
20	09-11 (0-1) 11-15 (1-2) 15-17 (0-1)	09-11 (1-4) 11-15 (2-4) 15-17 (1-4) 17-18 (0-4) 18-19 (0-3) 19-20 (0-2) 20-07 (0-1)	07-09 (2-3) 09-18 (4) 18-19 (3-4) 19-20 (2-4) 20-21 (1-4) 21-23 (1-3) 23-02 (1-2) 02-07 (1)	07-09 (3) 09-12 (4) 12-15 (4-3) 15-21 (4) 21-23 (3-4) 23-02 (2-3) 02-06 (1-2) 06-07 (1)
40	07-08 (0-2) 08-09 (1-3) 09-19 (4) 19-21 (2-3) 21-00 (1-2) 00-07 (0-1)	07-08 (2-4) 08-09 (3) 09-15 (4-3) 15-19 (4) 19-21 (3-4) 21-00 (2-4) 00-02 (1-3) 02-06 (1-2) 06-07 (1-3)	07-08 (4) 08-09 (3-2) 09-15 (3-1) 15-17 (4-2) 17-00 (4) 00-02 (3-4) 02-06 (2-4) 06-07 (3-4)	06-07 (4-3) 07-08 (4-2) 08-09 (2-1) 09-15 (1-0) 15-17 (2-0) 17-19 (4-3) 19-06 (4)

80	08-15 (4-3) 15-02 (4) 02-04 (3-4) 04-07 (2-3) 07-08 (3-4)	08-09 (3-2) 09-15 (3-1) 15-18 (4-3) 18-04 (4) 04-07 (3-4) 07-08 (4-3)	08-09 (2-1) 09-15 (1-0) 15-18 (3-1) 18-06 (4) 06-07 (4-3) 07-08 (3-1)	08-09 (1-0) 09-15 (0) 15-18 (1-0) 18-20 (4-1) 20-05 (4) 05-06 (4-3) 06-07 (3-1) 07-08 (1)
160	07-09 (3-2) 09-11 (2-0) 11-17 (1-0) 17-19 (3-2) 19-07 (4)	07-09 (2-1) 09-17 (0) 17-19 (2-1) 19-04 (4) 04-07 (3-2)	07-09 (1-0) 09-17 (0) 17-19 (1-0) 19-21 (4-2) 21-04 (4) 04-06 (2) 06-07 (2-1)	07-19 (0) 19-21 (2-1) 21-04 (4-3) 04-06 (2-1) 06-07 (1-0)

## ALASKA November & December, 1990 Openings Given in GMT#

TO:	10 Meters	15 Meters	20 Meters	40/80 Meters
Eastern USA	17-18 (1) 18-20 (2) 20-22 (3) 22-00 (2) 00-01 (1)	15-16 (1) 16-17 (2) 17-21 (3) 21-23 (4) 23-00 (3) 00-01 (2)	12-16 (1) 16-18 (2) 18-21 (1) 21-23 (2) 23-02 (3) 02-03 (2) 03-05 (1)	06-12 (1) 07-11 (1)*
Central USA	17-18 (1) 18-20 (2) 2-00 (3) 00-01 (2) 01-02 (1)	15-16 (1) 16-17 (2) 17-20 (3) 20-23 (4) 23-01 (3) 01-02 (2) 02-03 (1)	12-16 (1) 16-18 (2) 18-20 (1) 20-22 (2) 22-00 (3) 00-02 (4) 02-03 (3) 03-04 (2) 04-06 (1)	06-08 (1) 08-13 (2) 13-14 (1) 07-12 (1)*
Western USA	18-19 (1) 19-20 (2) 20-21 (3) 21-23 (4) 23-00 (3) 00-01 (2) 01-02 (1)	16-17 (1) 17-18 (2) 18-20 (3) 20-01 (4) 01-02 (3) 02-03 (2) 03-04 (1)	12-16 (1) 16-18 (2) 18-22 (3) 22-02 (4) 02-04 (3) 04-05 (2) 05-07 (1)	02-03 (1) 03-05 (2) 05-14 (3) 14-15 (2) 15-16 (1) 04-06 (1)* 06-14 (2)* 14-16 (1)*

## HAWAII November & December 1990 Openings Given In Hawaiian Standard Time #

TO:	10 Meters	15 Meters	20 Meters	40/80 Meters
Eastern USA	06-07 (1) 07-08 (2) 08-13 (4) 13-14 (3) 14-15 (2) 15-16 (1)	06-07 (1) 07-09 (4) 09-12 (3) 12-15 (4) 15-16 (3) 16-17 (2) 17-18 (1)	12-14 (2) 14-17 (4) 17-21 (3) 21-00 (2) 00-06 (1) 06-08 (3) 08-09 (2) 09-12 (1)	17-18 (1) 18-20 (2) 20-02 (3) 02-03 (2) 03-04 (1) 19-20 (1)* 20-01 (2)* 01-03 (1)*
Central USA	06-07 (1) 07-08 (3) 08-15 (4) 15-16 (3) 16-17 (2) 17-18 (1)	06-07 (1) 07-09 (4) 09-13 (3) 13-17 (4) 17-19 (3) 19-20 (2) 20-21 (1)	08-13 (2) 13-14 (3) 14-20 (4) 20-00 (3) 00-02 (2) 02-05 (1) 05-06 (2) 06-08 (3)	17-18 (1) 18-20 (2) 20-21 (3) 21-01 (4) 01-03 (3) 03-04 (2) 04-05 (1) 19-20 (1)* 20-22 (2)* 22-01 (3)* 01-03 (2)* 03-04 (1)*
Western USA	07-08 (1) 08-09 (2) 09-16 (4) 16-17 (3) 17-18 (2) 18-19 (1)	06-07 (1) 07-08 (2) 08-12 (3) 12-18 (4) 18-20 (3) 20-21 (2) 21-22 (1)	08-10 (4) 10-15 (3) 15-22 (4) 22-01 (3) 01-04 (2) 04-06 (1) 06-08 (3)	17-18 (1) 18-19 (2) 19-20 (3) 20-03 (4) 03-05 (3) 05-06 (2) 06-07 (1) 19-20 (1)* 20-21 (2)* 21-04 (3)* 04-05 (2)* 05-06 (1)*

#See explanation in "How To Use Short-Skip Charts" at the beginning of this column.

Note: The Alaska and Hawaii Propagation Charts are intended for distances greater than 1300 miles. For shorter distances use the preceding Short-Skip Propagation Chart.

\*Indicates best time for 80 meter openings. Openings on 160 meters are also likely to occur during those times when 80 meter openings are shown with a propagation index of (2) or higher. For 12 meter openings interpolate between 10 and 15 meter openings. For 17 meter openings interpolate between 15 and 20 meter openings. For 30 meter openings interpolate between 40 and 20 meter openings.

those on 80 meters, but signals will be weaker and noise levels higher.

Table I is a sample work chart for the CW Contest section, devised from the DX Propagation Charts which appeared in last month's column. This particular example is for multi-band operation and for a PST zone QTH. Similar work charts can be devised for other bands, for other operating conditions, and for other time zones. The work chart shows when propagation conditions are expected to be optimum to various areas of the world (propagation index 3 or more, unless otherwise shown) for each three hour time period throughout the day.

## VHF Openings

Lots of 6 meter F-2 layer DX openings are expected this month. Solar activity continues at a high enough level to permit openings to most areas of the world. Conditions should peak towards Europe and in a generally easterly direction before noon. Openings should pick up towards Africa shortly after noon, and continue to swing towards a southerly direction during the early afternoon hours. By late afternoon start looking for openings more towards the southwest and west. It's possible that signal levels may at times be quite strong during many of these 6 meter openings.

## EVERY ISSUE OF CQ on microfiche!

The entire run of CQ from January, 1945 thru last year is available.

You can have access to the treasures of CQ without several hundred pounds of bulky back issues. Our 24x microfiche have 98 pages each and will fit in a card file on your desk.

We offer a battery operated hand held viewer for \$75, and a desk model for \$220. Libraries have these readers.

The collection of over 800 microfiche, is available as an entire set, (no partial sets) for \$325.00 plus \$5 for shipping (USA). Annual updates available for \$10.

Your full satisfaction is guaranteed or your money back. VISA/MC accepted. Ham Radio magazine available for \$205.00.

## BUCKMASTER PUBLISHING

"Whitehall"

Route 3, Box 56

Mineral, Virginia 23117

703: 894-5777

800: 282-5628

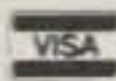
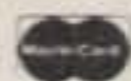

# NEVER PANIC AGAIN...

after missing a few Morse code letters.

Start copying words instead of letter-by-letter. Time-proven, easy-to-learn methods. Money-back guaranteed! Order today!

<b>QSO-TRAINER™</b> Code Course.	<b>QSO-MASTER™</b> Practice Tapes.	<b>QSO-PRO™</b> Practice Tapes.
Copy words the very first day! Ideal, moderate speed. \$16.95	The "plateau" buster! 8, 10, 12, 14 wpm. \$14.95	Go all the way to EXTRA! 16, 18, 20, 22 wpm. \$14.95

Each set contains two, high-quality, 60-min. tapes and complete written instructions.

Shipping & Handling: \$3.00 US and CAN; \$4.00 elsewhere. IL, IN, MI, MN, OH, WI add sales tax. Send Check, Money Order, Visa, or MasterCard to:

**AVC INNOVATIONS, INC. DEPT. CQ**  
P.O. BOX 20491, INDPLS., IN 46220-0491

**Business Size SASE Gets Details**

CIRCLE 30 ON READER SERVICE CARD

## THE NEXT GENERATION OF 10 METER TRANCEIVERS IS HERE!

Features—10 Memories—Cap/Mars Coverage  
(Upon proof of authorization)

Selectable TX Power—PA Function—Programmable

Repeater Offset and an Honest to Goodness CW Keying Jack  
M.S.R. Price \$449.00 AXM Introductory Price \$279.95 CASH

ASK FOR IT BY NAME—THE RCI-2950 BY



**RANGER**  
Communications, Inc.

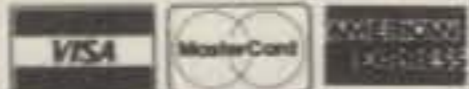

**AXM Incorporated**

Serving the radio amateur who needs more than an amateur radio.

11791 Loara Street, Suite B  
Garden Grove, California 92640

Tel: (714) 638-8807 FAX: (714) 638-9556

CIRCLE 86 ON READER SERVICE CARD

## INTERNATIONAL RADIO AND COMPUTERS, INC/ FOX TANGO

OUR 11TH YEAR

### SALES

Kenwood, Icom & Yaesu Equipment & most Amateur Radio Products! Icom authorized dealer!

### SERVICE

Optimized Alignment Service Installation of IRCI & Fox Tango Crystal Filters  
Enhancement Kits  
Tuning Upgraders  
Bank Controllers  
We service what we Sell.

**KENWOOD  
AUTHORIZED  
SERVICE CENTER**

### FILTERS

8 & 10 Pole International Radio & Fox Tango Crystal Filters for Icom, Kenwood, & Yaesu: F. Tango Filters also for Drake, Collins & Heath.

### NEWSLETTERS & PUBLICATIONS

Icom, Kenwood, Yaesu Separate Newsletters, just \$11.00 annually. Years of Back Issues.  
Back Issue Index - \$4.00. User's Supplements.

### HAM-IBM® COMPATIBLE COMPUTERS

FCC approved, starting at \$429.00  
IBM Ham Public Domain Software at \$3.00 per disk

Send 45c/SASE for FREE Amateur Radio 20 page Catalog of products & services available or complete software catalog. STATE WHICH!

VISA, MasterCard, AMERICAN EXPRESS  
SEND TO:

**INTERNATIONAL RADIO  
AND COMPUTERS, INC. / FOX TANGO**

(407) 879-6868 FAX No. (407) 878-8856  
751 South Macedo Blvd., Port St. Lucie, FL 34983

**PLACE YOUR CHRISTMAS ORDERS NOW!**

Time PST	Band Meters	Areas To Which DX Conditions Expected To Be Optimum
00-03	20	Southeast Asia, Far East, South Pacific & New Zealand, Australasia, Caribbean, Central America, Antarctica, Africa*, South America*
03-06	20	South Pacific & New Zealand, Australasia, Caribbean, Central America, Southeast Asia*, Far East*, South America*, Antarctica*
06-09	20	Caribbean, Central America, South America, Southeast Asia, Far East, South Pacific & New Zealand, Australasia, Central and South Asia, Europe*, Eastern Mediterranean*, Middle East*, Antarctica*
09-12	15	Europe, Southeast Asia, Far East, South Pacific & New Zealand, Australasia, Caribbean, Central America, Western Africa, Eastern Mediterranean*, Middle East*, Eastern, Central & Southern Africa*, South America*
12-15	10	Africa, South Pacific & New Zealand, Australasia, Caribbean & Central America, South America
15-18	10	Central & South Asia, Southeast Asia, Far East, South Pacific & New Zealand, Australasia, Caribbean & Central America, South America
18-21	15	Southeast Asia, Far East, South Pacific & New Zealand, Caribbean & Central America, South America, Central & South Asia*, Australasia*, Antarctica*
21-00	20	Far East, South Pacific & New Zealand, Australasia, Caribbean & Central America, South America, Antarctica, Europe*, Africa*, Southeast Asia*

\* Propagation index (2), all others (3) or (4)

Table I—Sample multi-band contest operating schedule, western USA.

Some trans-equatorial (TE) type 6 meter propagation may also be possible during November. The best time to check for such conditions is between approximately 8 and 11 PM local standard time. TE openings favor locations in the southern tier states, and generally take place to South American countries south of the equator. Signals at best are expected to be weak, erratic, and with considerable flutter fading.

Some meteor shower activity is expected during November which could make possible meteor-scatter-type openings on the VHF bands. The *Taurids* shower, which should last for a day or two, is expected to peak on November 3 with a meteor count of approximately 15 an hour. A second shower of about the

same duration and intensity, called *Leonids*, should reach peak intensity during the early evening hours of November 16 (EST).

November is generally a month in which some fairly intense auroral activity can occur, bringing with it conditions for auroral-type short-skip openings on the VHF bands. Auroral activity is usually associated with periods of radio storminess and is most likely to occur on those days shown as Below Normal or Disturbed in the Last-Minute Forecast, which appears at the beginning of this column.

Good luck in the CW section of the 1990 CQ Word-Wide DX Contest, and be sure to let me know how these special contest propagation forecasts work out.

73, George, W3ASK

## GEM QUAD PRODUCTS (1987) LTD.

Chosen By Amateurs For Over 15 Years. Winner of the Manitoba Design Institute Award of Excellence. Will Accommodate New Bands From 2 To 20 Meters.

### Fiber Glass Quad Antenna For 10, 15, and 20 Meters

2 Element \$265.00  
3 Element \$420.00  
4 Element \$565.00



Kit Includes: Spider, Arms, Wire, Balun Kit and Boom Where Needed  
Price is F.O.B. Boishevain. Includes U.S. Customs Duty.

Boishevain, Manitoba, Canada R0K 0E0  
P.O. Box 291, Telephone (204) 534-6184

# HUGE 92 PAGE CATALOG

- Communications Receivers
- Portable Receivers
- Amateur Transceivers
- HT's & Mobile Transceivers
- Amateur & SWL Antennas
- Scanners
- RTTY and FAX Equipment
- Books, Manuals & Accessories

Send \$1 to

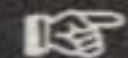

**Universal Radio**  
1280 Aida Drive Dept. CQ  
Reynoldsburg, OH 43068  
Tel. 614 866-4267

## ARRL DX Contest Software by Contest Radio, Inc.

Following the success of our CQ WW DX Advantage® Software, we are proud to announce the ARRL DX Advantage® Software System for a PC. The ARRL DX Advantage features:

- Up to 10,000 QSO's/band
- Real Time Dupe Search
- Partial Call Search
- Keyboard Memory Keyer
- Alerts For Each New Band Multiplier
- Eye Pleasing Display Colors
- True ASCII Log Output As Required by ARRL
- Complete Documentation Included
- On Line/Off Line Modes
- Power Interrupt Protected
- Automatic Scoring
- Snapshot Score Status
- Pop-Up Windows
- Prints Dupe/Log/Summary Sheets In ARRL Format
- Displays Needed Multipliers
- And Much More

\$39.95 + \$3.00 S/H. Del. USA and Possessions (State 3.5" or 5.25" disks)

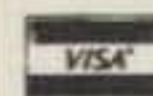

Contest Radio, Inc.  
449 Widow Sweets Rd. • Exeter, RI 02822  
401-295-2130



# ASTRON CORPORATION

9 Autry  
Irvine, CA 92718  
(714) 458-7277

## ASTRON POWER SUPPLIES

- HEAVY DUTY • HIGH QUALITY • RUGGED • RELIABLE •

### RS, RM and VS SERIES SPECIAL FEATURES

- SOLID STATE ELECTRONICALLY REGULATED
- FOLD-BACK CURRENT LIMITING Protects Power Supply from excessive current & continuous shorted output.
- CROWBAR OVER VOLTAGE PROTECTION on all Models except RS-4A, RS-5A.
- MAINTAIN REGULATION & LOW RIPPLE at low line input Voltage.
- HEAVY DUTY HEAT SINK • CHASSIS MOUNT FUSE

- THREE CONDUCTOR POWER CORD
- ONE YEAR WARRANTY • MADE IN U.S.A.

### PERFORMANCE SPECIFICATIONS

- INPUT VOLTAGE: 105 - 125 VAC
- OUTPUT VOLTAGE: 13.8 VDC ± 0.05 volts (Internally Adjustable: 11-15 VDC)
- RIPPLE: Less than 5mv peak to peak (full load & low line)
- Also available with 220 VAC Input Voltage



MODEL VS-50M

### RM-A SERIES



MODEL RM-35M

### 19" X 5 1/4" RACK MOUNT POWER SUPPLIES

MODEL	Continuous Duty (Amps)	ICS* (Amps)	Size (IN) H x W x D	Shipping Wt. (lbs.)
RM12A	9	12	5 1/4 x 19 x 8 1/4	16
RM-35A	25	35	5 1/4 x 19 x 12 1/2	38
RM-50A	37	50	5 1/4 x 19 x 12 1/2	50
• Separate Volt and Amp Meters				
RM-35 M	25	35	5 1/4 x 19 x 12 1/2	38
RM-50 M	37	50	5 1/4 x 19 x 12 1/2	50
RS-4A	3	4	3 3/4 x 6 1/2 x 9	5
RS-5A	4	5	3 1/2 x 6 1/8 x 7 1/4	7
RS-7A	5	7	3 3/4 x 6 1/2 x 9	9
RS-10A	7.5	10	4 x 7 1/2 x 10 3/4	11
RS-12A	9	12	4 1/2 x 8 x 9	13
RS-20A	16	20	5 x 9 x 10 1/2	18
RS-35A	25	35	5 x 11 x 11	27
RS-50A	37	50	6 x 13 3/4 x 11	46

### RS-A SERIES



MODEL RS-7A

### RS-M SERIES



MODEL RS-35M

### RS-S SERIES



MODEL RS-12S

### VRM/VS-M SERIES



MODEL VS-35M

- Separate Volt and Amp Meters • Output Voltage adjustable from 2-15 volts
  - Current limit adjustable from 1.5 amps to Full Load
- |                                      | @ 13.8VDC @ 10VDC @ 5VDC | @ 13.8V |    |    |
|--------------------------------------|--------------------------|---------|----|----|
| VS-20M                               | 16                       | 9       | 4  | 20 |
| VS-35M                               | 25                       | 15      | 7  | 35 |
| VS-50M                               | 37                       | 22      | 10 | 50 |
| • Variable rack mount power supplies |                          |         |    |    |
| VRM-35M                              | 25                       | 15      | 7  | 35 |
| VRM-50M                              | 37                       | 22      | 10 | 50 |

\*ICS—Intermittent Communication Service (50% Duty Cycle 5 min. on 5 min. off)

## NEWS OF CERTIFICATE AND AWARD COLLECTING

**T**he Story of the Month for November is:

**Harold C. Griffin, N4OA  
USA-CA All Counties #611,  
Mixed 3-6-89**

"I am 44 years old and teach school. I work with children who are severely/profoundly mentally retarded, blind, and have cerebral palsy. They are a wonderful group of children whose needs are a real challenge to meet. I am married to Linda and have five children: Andrew, age 20; Sarah, 18; James, 16; Laura 6; and Genie, 5.

"I started county hunting in earnest in December 1979 when my brother, James Griffin, N4JG, told me about the county hunting operation on 14.336 MHz. He had heard of it from one of his associates at work, Ed Daigre, W5ILR. At that time I had worked about 500 counties on code.

"It took me ten years to complete USA-CA All Counties #611. The time might have been shorter, but I have a dipole antenna and low power, which limits the strength of the signal. During these ten years I have talked with many good friends. At the MARAC convention in Manchester, Tennessee a few years ago I had a chance to actually meet some of them in person. They are a wonderful group of people.

"I would like to thank a number of individuals who have really helped me along the way. I thank my brother, James, N4JG, for getting me started in county hunting. I also would like to personally thank Dave, N0GYN, for going to get my last county—Sherman, Nebraska—in 20-degree below zero temperatures. Also I would like to thank Galen, KB5FU, for the many counties he went out of his way to give me. His mobile trips have added a new dimension to working counties on multiple bands in a very time-efficient and professional manner. Third, I would like to say thank you to Arnie, K9DCJ. Arnie has done so very much for county hunting. He has a tremendous ability to remember names and make newcomers and old timers feel welcome. Others who come to mind and who have been good friends are Karl, WA6MAR; Carl, WA9PQY; Ed, W5ILR; Gene, N4ANV; Pete, K4QFK; Bill, KM4W; Orv, VE3BFJ; Dorothy, WB9RCY; and the many other amateurs who went out of their way for a



*Harold Griffin, N4OA (left), USA-CA All Counties #611, with his brother, James, N4JG.*

needed county or who relayed me in as they served as net control.

"As someone once said, the nice thing about this award is that it requires each one to help the other. Again, I thank all of you for your assistance in making USA-CA All Counties #611 a reality.—Sincerely, Harold, N4OA."

### Awards Issued

Lloyd B. Glasscock, K0GEN, collected a full complement of confirmed county contacts and received USA-CA All Counties #668, USA-CA 3000 #696, USA-CA 2500 #773, USA-CA 2000 #838, USA-CA 1500 #922, USA-CA 1000 #1121, and USA-CA 500 #2425, All SSB Mobiles, dated 7-2-90.

Leonard A. Postage, N4UMR, filled out his good record and claimed USA-CA All Counties #669, and USA-CA 3000 #697, All SSB, dated 7-3-90.

Ed Dranchak, NT9V, filed his completely filled record book claiming USA-CA All Counties #670, USA-CA 3000 #698, USA-CA 2500 #774, USA-CA 2000 #839, USA-CA 1500 #923, USA-CA 1000 #1122, and USA-CA 500 #2427, All SSB, dated 7-5-90.

Edgar E. Newman, W2RPZ, put together his final group of confirmed contacts

### USA-CA Honor Roll

	3000	NV6L	926
K0GEN	696	NW10	927
N4UMR	697		
NT9V	698		
NW10	699		
		1000	
	2500	K0GEN	1121
K0GEN	773	NT9V	1122
NT9V	774	K6PQA	1123
N7FQQ	775	NV6L	1124
NW10	776	NW10	1125
		500	
	2000	K0GEN	2425
K0GEN	838	TF5BW	2426
NT9V	839	NT9V	2427
N7FQQ	840	JA3MNY	2428
NV6L	841	JR8AY1	2429
NW10	842	KF7RU	2430
		K6PQA	2431
		KB4HBH	2432
	1500	EA6MQ	2433
K0GEN	922	OH3OJ	2434
NT9V	923	NV6L	2435
KB9YY	924	VE4ROY	2436
N7FQQ	925	NW10	2437

The total number of counties for credit for the United States of America County Award is 3076. The basic award fee for subscribers to CQ is \$4.00. For nonsubscribers it is \$10.00. Initial application must be submitted in the USA-CA Record Book, which may be obtained from CQ Communications, 76 North Broadway, Hicksville, NY 11801 USA for \$1.25. To qualify for the special subscriber rate please send a recent CQ mailing label with your application. To be eligible for the USA-CA, applicants must comply with the rules of the program as set forth in the revised USA-CA Rules and Program dated April 2, 1985. A complete copy of the rules may be obtained by sending an SASE to Dorothy Johnson, WB9RCY, USA-CA Custodian, 333 South Lincoln Avenue, Mundelein, IL 60060 USA. DX stations must include extra postage for airmail reply.

and claimed USA-CA All Counties #671, All CW, dated 7-20-90.

Louis R. Bligh, NW10, filed his good application and received USA-CA 3000 #699, USA-CA 2500 #776, USA-CA 2000 #842, USA-CA 1500 #927, USA-CA 1000 #1125, and USA-CA 500 #2437, All CW, dated 7-28-90.

Beatrice I. Wilson, N7FQQ, received USA-CA 2500 #775, and USA-CA 2000 #840, Mixed, dated 7-21-90.

Ada (Jan) J. McLernon, NV6L, claimed USA-CA 2000 #841, USA-CA 1500 #926, USA-CA 1000 #1124, and USA-CA 500 #2435, Mixed, dated 7-26-90.

John L. Biester, KB9YY, received USA-CA 1500 #924, All SSB, dated 7-13-90.

Robert P. Banner, K6PQA, claimed USA-CA 1000 #1123, and USA-CA 500 #2431, Mixed, dated 7-23-90.

USA-CA 500 certificates went to:

Lloyd B. Glasscock, K0GEN, USA-CA 500 #2425, All SSB Mobiles, 7-2-90.

Brynjolfur Jonsson, TF5BW, USA-CA 500 #2426, Mixed, 7-2-90.

Ed Dranchak, NT9V, USA-CA 500 #2427, All SSB, 7-5-90.

333 South Lincoln Ave., Mundelein, IL 60060

**ATTENTION HAMS!**  
**UNIVERSAL**  
 ALUMINUM  
**.. GREAT TOWERS!**



**UNIVERSAL TOWERS**

Universal Manufacturing Co.  
 43900 Groesbeck Hwy.  
 Mt. Clemens, MI 48043

313-463-2560  
 FAX 313-463-2964

CIRCLE 78 ON READER SERVICE CARD

**The Radiokit DVR-60 Digital Voice Recorder**  
 State of the art surface mount technology provides unequalled price/performance benefits in a unit that measures only 2 3/8" x 3 1/8" inches.

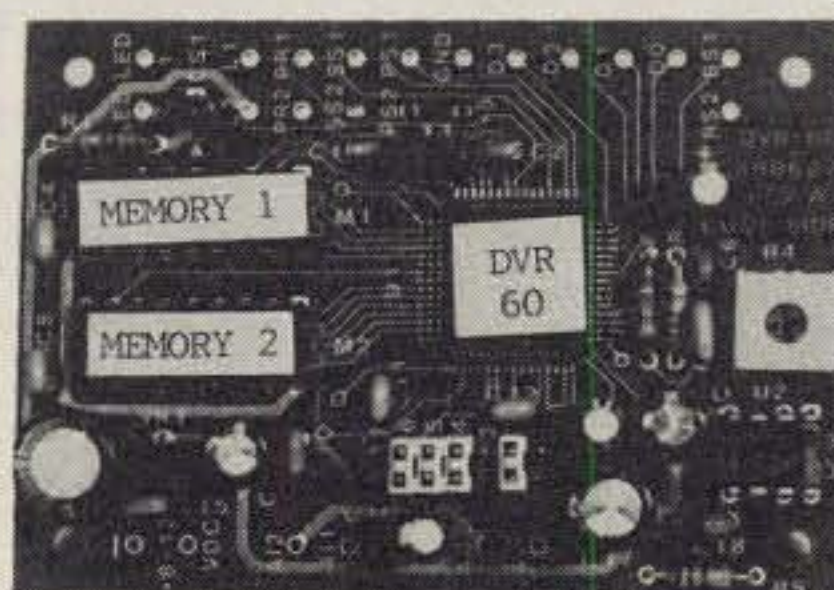

**PRICE**  
**\$149.95**

**Numerous Amateur/Commercial/Educational Applications:**

- Repeater ID and Messaging • Simplex Repeater • Voice Mailbox
- Contester/DXER Voice Messaging, Interface with Popular Contest Logging Programs.
- Missed or Busted Call Playback. Works on ANY Audio Signal.
- Instant Replay of Emergency or Traffic Messages. • Home Security
- Talking Sign • Public Address System—Emergency Announcements

**Specifications:**

- Up to 16 Variable Length Messages
- 60 Seconds Recording/Playback Available as Shipped, User Expandable to 4 Minutes.
- Message Buffers Completely Soft Sektored
- Random Access Playback
- Selectable Continuous Loop on Record
- Manual or Computer Controlable
- 32KBPS Sampling Rate for Natural Sounding Audio
- Selectable Input Gain Levels, 0, 20, or 46 dB. 2V PP Max
- Message Select: Up to 4 Lines Binary Code
- Signal to Noise Ratio 55 dB
- Power Requirements 9-15 VDC @ 50 ma Peak
- Distortion Less Than 2% THD
- Completely Wired and Tested. NOT a Kit.

**1 Meg x 1 Drams \$9.95 ea.**  
**30 Seconds Per DRAM**

The DVR-60 is provided with full documentation. Four holes are provided on the PC board for mounting convenience. All input/output lines and component designations are clearly silk screened on the board.

*OEM and Dealer Inquiries Welcome*  
*Custom Design and Production Facilities Available*

**RADIOKIT • P.O. Box 973-C • Pelham, NH 03076**  
**(603) 635-2235**

CIRCLE 42 ON READER SERVICE CARD

**HI-PERFORMANCE DIPOLES**

Antennas that work! Custom assembled to your center freq. ea. band - advise ht. of center and each end - hang as inverted "V" - horizontal, vert dipole, sloping dipole - commercial quality - stainless hardware - legal power - no-trap, high-efficiency design. Personal check, MO or C.O.D. (\$3)

MPD-5*	80-40-20-15-10M max-performance dipole 87' long	\$105 ppd
MPD-2	80-40M max-performance dipole, 85' long	\$62
HPD-3*	180-80-40M hi-performance dipole 113' long	\$79 ppd
SSD-6*	180-80-40-20-15-10M space saver dipole 71' long	\$125 ppd
SSD-5*	80-40-20-15-10M space-saver dipole-specify L. 42' \$105	\$2' \$108 ppd
SSD-4*	80-40-20-15M space-saver dipole-specify L. 46' \$93	\$0' \$ 96 ppd

\*9-bands with wide-matching-range tuner.  
 SASE for catalogue of 30 dipoles, slopers, and space-saving, unique antennas  
**W9INN ANTENNAS**  
 708-394-3414 BOX 393 MT. PROSPECT, IL 60056

CIRCLE 31 ON READER SERVICE CARD

**The Radio Operator's World Atlas**

- Compact desk-top reference for the active DXer — 5" x 7"
- Hardbound with 185 pages in color on high quality paper
- Educational cultural profiles of 173 political countries
- Excellent detail surpassing Jumbo Atlases (No prefix maps)
- Call-sign allocation table and world time zone map

**\$17.95 postpaid worldwide from:**  
**Walt Stinson, W0CP**  
**4150 East Quincy Avenue**  
**Englewood, CO 80110**  
 (\$25 for foreign airmail)

**CQ Amateur Radio Buyer's Guide**

You can buy with confidence when you have all the facts. The 1991 Equipment Buyer's Guide gives you in-depth coverage of HF/VHF/UHF rigs and accessories. All the information is here in one handy, concise directory with descriptions, technical specifications, model numbers, retail prices and photographs. How do you get a ham license? What's the latest on the code-free license? What equipment do you really need to work the satellites? Should you buy a computer for your shack? How do you add computer control to your rig? You can buy with confidence when you have all the facts. Order the 1991 Equipment Buyer's Guide today!

You'll need the Antenna Buyer's Guide to squeeze every last dB out of your antenna dollars. Make sure you get the best possible antenna system for the best price! HF and VHF/UHF, directional and omnidirectional, vertical and horizontal, mobile and portable—they are all covered in depth. Tuners, cables, wattmeters and more! You'll find detailed charts, specifications, photos and retail prices. Advice on getting the proper tower and antenna permits from a leading authority on PRB-1. Step-by-step guide to putting up your first beam! The bands are hotter than ever right now. You can't afford to wait.

**ORDER YOUR BUYER'S GUIDES TODAY!**

Don't miss the most valuable buying guides in the Amateur Radio field!

YES, please send me \_\_\_\_\_ copies at \$4.95 each:

- EQUIPMENT BUYER'S GUIDE  
 ANTENNA BUYER'S GUIDE

Name \_\_\_\_\_ Call \_\_\_\_\_

Address \_\_\_\_\_

City \_\_\_\_\_ State \_\_\_\_\_ Zip \_\_\_\_\_

Send only \$4.95 each today. Foreign: \$6. U.S. funds.  Check  Money Order

MasterCard  VISA  Amex Card No. \_\_\_\_\_ Expires \_\_\_\_\_

Signature \_\_\_\_\_ (required on all charge orders)

Mail to: CQ Communications, Inc., 76 North Broadway, Hicksville, NY 11801/FAX: 516-681-2926



# Alpha Delta Limited Space High Performance Antennas...

- STAINLESS STEEL HARDWARE
- FULLY ASSEMBLED
- SEVERE WEATHER RATED COMPONENTS

• No-trap design. Unlike trap antennas, there are no capacitors to break down under high RF voltages, and a tuner may be safely used for multi-band operation if desired.

• Direct 50 ohm feed. Tuners usually not required when operating in resonant bands.

• Full power operation.

• Uses "ISO-RES" inductors.

• 12 ga. insulated solid copper wire.

(Smaller 14 ga. wire not used in any Alpha Delta antenna)

**Model DX-A** 160-80-40 Meter Quarter Wave Twin Sloper —

- The premier low frequency DX antenna.
- Combines the tremendous DX firepower of the quarter wave sloper with the wide bandwidth of the half wave dipole.
- One leg is 67', the other 55'. Installs like an inverted-V. Ground return through tower or down-lead . . . . . **\$59.95 each**

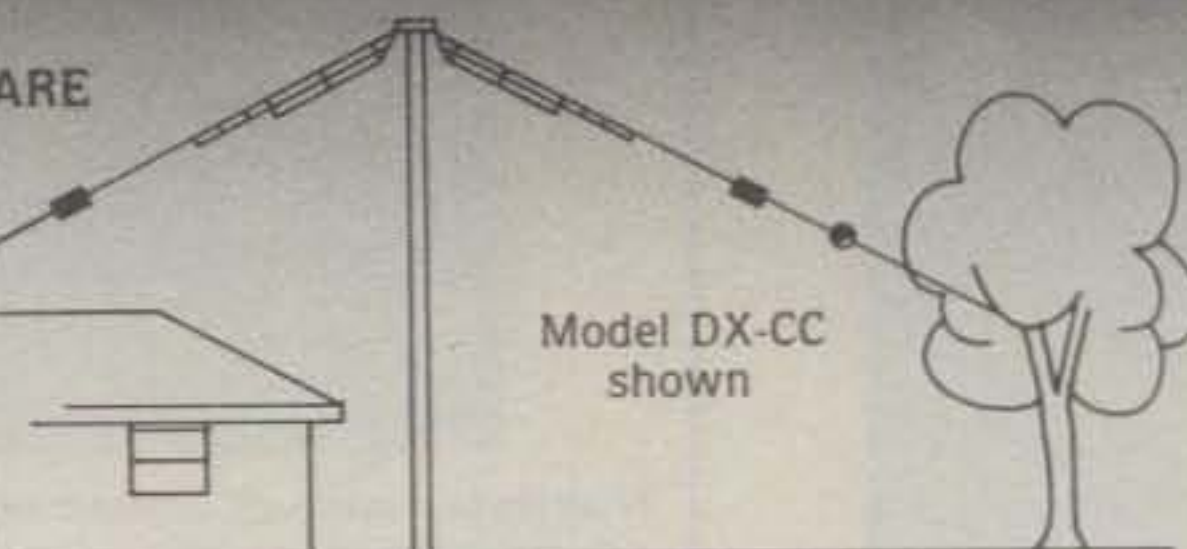

Model DX-CC shown

**Model DX-CC** "No-Trap" 80-40-20-15-10 Meter Dipole —

- Can be used as inverted-V.
- Only 82' overall length . . . . . **\$99.95 each**

**Model DX-DD** "No-Trap" 80-40 Meter Dipole —

- Can be used as inverted-V.
- Only 82' overall length . . . . . **\$79.95 each**

**Model DX-EE** "No-Trap" 40-20-15-10 Meter Dipole (30-17-12 meters with wide-range tuner)

- Can be used as inverted-V.
- Only 40' overall length . . . . . **\$89.95 each**

Available from your local Alpha Delta Dealer or direct. Add \$4.00 shipping and handling (USA only). Exports quoted.

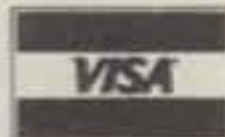

**ALPHA DELTA COMMUNICATIONS, INC.** **AA**

P.O. Box 51117, Phoenix, AZ 85076 • (602) 966-2200

current solutions to current problems

## USA-CA Special Honor Roll

Lloyd B. Glasscock, K0GEN  
USA-CA All Counties #668  
All SSB Mobiles, 7-2-90

Leonard A. Postage, N4UMR  
USA-CA All Counties #669  
All SSB, 7-3-90

Ed Dranchak, NT9V  
USA-CA All Counties #670  
All SSB, 7-5-90

Edgar E. Newman, W2RPZ  
USA-CA All Counties #671  
All CW, 7-20-90

Hiroyuki Kimura, JA3MNY, USA-CA 500 #2428, Mixed, 7-5-90.

Akira Sato, JR8AYI, USA-CA 500 #2429, All SSB, 7-11-90.

Jerold (Jerry) A. Goetsch, KF7RU, USA-CA 500 #2430, All SSB, 7-14-90.

Robert P. Banner, K6PQA, USA-CA 500 #2431, Mixed, 7-23-90.

Oliver S. Johnson, KB4HBH, USA-CA 500 #2432, Mixed, 7-23-90.

Jose Quintana Sintes, EA6MQ, USA-CA 500 #2433, Mixed, 7-23-90.

Jukka Tamminen, OH3OJ, USA-CA 500 #2434, Mixed, 7-24-90.

Ada (Jan) J. McLernon, NV6L, USA-CA 500 #2435, Mixed, 7-26-90.

Roy Coldwell, VE4ROY, USA-CA 500 #2436, Mixed, 7-28-90.

Louis R. Bligh, NW10, USA-CA 500 #2437, All CW, 7-28-90.

## Awards Available

**Golden City Award.** The Golden City Award is offered by the Johannesburg Branch of the South African Radio League. Gold was discovered in Johannesburg in 1886, and today Johannesburg produces almost 30% of the world's gold annually. It is only fitting that the Golden City Award should be so named.

The award is available to any station that can submit a GCR list of confirmed contacts with 15 stations in the Johannesburg area. (Zone 38 stations need 30 confirmed contacts.) Reports must be no less than RST 33(9). The cost of the award is 5 IRCs, except for stations in the USSR, who may obtain the award at no charge. All contacts must be dated after 30 May 1960. Any band and any mode are acceptable.

The address for the award is Johannesburg Amateur Radio Club, P.O. Box 807, Houghton, 2041, Rep. of South Africa.

Note that the Golden City DX Net, which provides an opportunity to work

For Satellite Communications Excitement in the 90's!

**JOIN AMSAT**

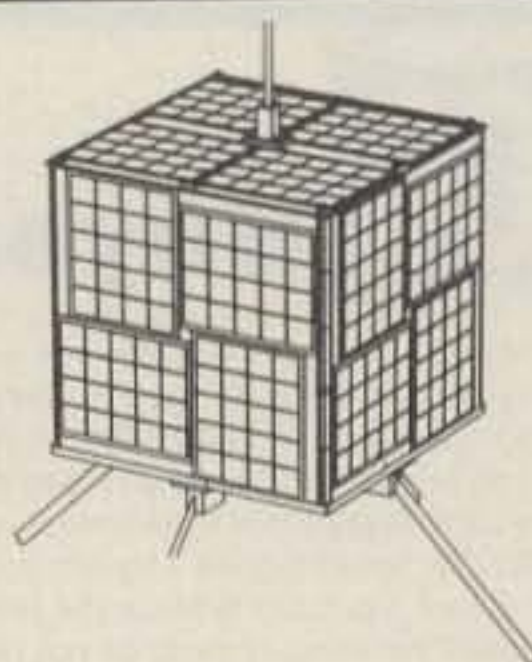

The '90's got off to a great start with the launch of 6 new OSCARS and there's more to come like the Phase IV project. Keep up to date with AMSAT membership which includes AMSAT Journal. It has the latest info on OSCAR operations, the new MICROSATS and UoSATS, SAREX, and AMSAT member benefits such as tracking software, nets, bulletin board, videotape library, QSL bureau and more. Don't be content to watch Amateur Radio history being made by others. Be part of that history. Join AMSAT today!

### MEMBERSHIP APPLICATION

Name \_\_\_\_\_ Call \_\_\_\_\_

Street \_\_\_\_\_

City \_\_\_\_\_ State \_\_\_\_\_ Zip \_\_\_\_\_

YES! Sign me up for membership, Enclosed is \$30 for my annual dues

YES! Renew my membership for 1 year at the \$30 annual rate

YES! Please send me more information on AMSAT

VISA/MC No. \_\_\_\_\_ Expires \_\_\_\_\_

Signature \_\_\_\_\_ AMSAT Member No. (if known) \_\_\_\_\_

For fast service call AMSAT Headquarters at (301) 589-6062 CQ

**AMSAT PO Box 27 WASHINGTON, DC 20044**

CIRCLE 94 ON READER SERVICE CARD

most of the required stations, meets every Sunday from 1900 to 2000 UTC on 14.240 MHz, plus or minus QRM. The net control is Marc, ZS6HZ.

**Promethius Amateur Association Awards.** The Promethius Amateur Association has an awards program for contacts with its members. QSOs with members from their home or DX QTHs are valid for awards. Since SWLs are members, their QSL cards count as working a club member. There are no band, mode, or date limits for awards. Shortwave listeners may apply. There are no fees for invalids.

The different awards and requirements are as follows:

Promethius Award—3 QSOs required, fee \$3.00 US.

Promethius Pennant—4 QSOs required, fee \$5.00 US.

Promethius Plaque—5 QSOs required, fee \$10 US.

Promethius Statuette—10 QSOs required, fee \$20 US.

Promethius T-shirt—3 QSOs from DX list, fee \$15 US.

As a supplement to this program, there are awards for contacts with 4J5FV. A handsome pennant is available for one QSO during the CQ WW WPX CW Contest in 1990. The cost of this award is \$5.00.

The Upper Eshers Award is available for two QSOs with 4J5FV. Repeat contacts on different bands, different modes, or different contests—e.g., CQ WW DX CW and SSB contests in 1989, and CQ WPX DX Contest in 1990—are valid for this award. The award costs \$5.00. A special prize worth \$10.00 is available for three QSOs with 4J5FV.

Promethius members as of May 1, 1990 are as follows: RB5IJ, RB5IUL, UB5IRZ, UB4IYU, UB3IWA, UK507331, UB50733775, UB50733745, RB4ICP, RB4IBQ, RB5FH, RD6DM, UB5JRR, UB4JDM, UB70672, W6HJK, UG7GWH, 3W8AA, K8DHK, UB50733942, XE1EX, IN3BGM, DK5KD, UG6GE, UG6GCC, and NA3O.

Promethius DX stations are: RB5IJ/RI5L, RB5IJ/UB7J, RB5IJ/UF9V, RB5IJ/UG3G, RB5IJ/UG9G, UB3IWA/RF2V, UB4IYU/RB6J, UB4IYU/UB6J, UB4IYU/UG0G, UB4IYU/UG1G, UB4JDM/RG, UB5IRZ/UG8G, 3W3RR, 3W5IJ, and 4J5FV.

QSLs, applications, and fees should go to PAA Inc., Box 195, Donetsk, 340000, USSR. No name or callsign should appear on the envelope.

**Six Counties Award—Northern Ireland.** The operators of Special UK Station GB4SPD offer the Six Counties Award. It is available to radio amateurs and SWLs



The Six Counties Award offered by Northern Ireland, special UK station GB4SPD.



## HPF-1 High Pass Filter

Suppress television interference with AEA's new HPF-1 high pass filter, intended for 75 or 300 ohm TV input impedance.

- Use between TV antenna and VCR or TV
- Reduces signals received from transmitters operating below 30 MHz
- Low loss in the TV passband 52 to 550 MHz
- Unique shield-breaking circuit configuration to prevent antenna cable from acting like an HF antenna
- VSWR less than 1.5:1



## LPF-30 Low Pass Filter

Suppress television interference at the source with AEA's new 1500 watt 30 MHz low pass filter.

- Use between transmitter and antenna or tuner
- Reduces television interference (TVI) radiated by transmitters operating below 30 MHz
- Suppresses harmonics appearing in the TV bands
- Additional attenuation to TV IF frequencies above 40 MHz
- Low loss to 30 MHz, VSWR less than 1.3:1
- Nine-pole inverse Chebyshev design



### Brings You A Better Experience.

Advanced Electronic Applications, Inc.  
2006-196th St. SW/P.O. Box 2160  
Lynnwood, WA 98036  
206-775-7373

AEA provides technical support from the factory or through your personal computer and modem on CompuServe's HamNet. If you are already a CompuServe member, just type GO HAMNET at any CompuServe prompt. For a free introductory CompuServe membership, call 1-800-848-8199 and ask for representative #48.

Specifications subject to change without notice or obligation. Copyright 1990.



Some of the many awards offered by the Irish Radio Transmitters Society for meritorious service to amateur radio and the IRTS.



President Con Hunter, EI9V, presenting the IRTS DX Trophy to Joe Duffin, EI8GT/W2ORA.



The IRTS DX Trophy and Collins Cup awarded to deserving amateurs by the Irish Radio Transmitters Society.

who work/log GI stations. It is on a points system, 12 points being required. Station GB4SPD is worth three points. GI stations are worth one point each. At least one GI station per county is required. Contacts via repeaters do not count.

The cost of the award is 2.00 Pounds Sterling or 8 IRCs. Send log extract and fee to Awards Manager GI4WRI, 175

Staffordstown Road, Randalstown, Co. Antrim - BT41 3LT, Northern Ireland.

**IRTS Awards.** The following information about the Irish Radio Transmitters Society awards is courtesy of Joe Duffin, EI8GT/W2ORA. Joe is very active in IRTS functions. Anyone interested in joining the IRTS and receiving their newsletter, etc., may get in touch with Joe at 4 West

Central Avenue, Moorestown, NJ 08057-2415, USA. He has IRTS applications and information.

The IRTS has many awards, some for contests and some for meritorious service to amateur radio and to the IRTS. Two of the most prestigious are the IRTS DX Trophy and the Collins Cup, both of which have been awarded to EI8GT/W2ORA.

**IRTS DX Trophy.** This cup was purchased by special subscription of the members soon after the founding of the Society in 1932. It is the oldest of the IRTS awards, and is presented to the highest scoring station in either the phone or CW section of the annual ARRL DX contest. At first the winners received replicas, and the cup itself was first presented in 1934.

At present it is awarded to the highest scoring single-operator station. The awards committee members are attempting to devise a system whereby a comparison can be drawn between the relative merits of the scores of multi-operator and single-operator stations.

This trophy is a sterling silver cup, 7 inches in diameter, with the calls and names of all previous winners engraved on the side. The recipient gets to keep the cup for one year.

**Collins Cup.** The solid-silver Collins Cup was donated to the Society by Harry Wilson, EI2W. It commemorates his friend, Michael Collins, EI3N, who was electrocuted while carrying out adjustments to his rig at his home in Rathgar, Dublin in June 1951. The Collins Cup is awarded for exceptional service to the society or to amateur radio.

**Zone 12 Award.** We are informed that the fee for the Zone 12 Award is now \$4.00 US or 8 IRCs. Information about the award appeared in this column in July 1990.

Good Hunting!

73, Dorothy, WB9RCY

### CW? No Problem!

**CW Mental Block BUSTER** explodes mental blocks about CW! Hypnosis, visualization, affirmations. Based on 40 yrs. research. Includes Tape and Workbook. **Results Guaranteed.** Not a CW practice tape. Only \$24.95 postpaid in U.S. (NY residents add \$1.87 sales tax.) Order today!

PASS Publishing, Box 570, Stony Brook, NY 11790

Baraboo, Wisconsin Sauk County <b>KOZZ</b>	Call Today & We Ship			
	NextDay	2nd Day	ASAP	Two-Color Rainbow Assortment
100	\$29.95	\$24.95	\$19.95	
200	\$39.95	\$34.95	\$29.95	
400	\$49.95	\$44.95	\$39.95	
500	\$54.95	\$49.95	\$44.95	
1000	\$99.95	\$89.95	\$79.95	

Info \$1  
**AntennasWest**  
(801) 373-8425

All orders ppd 2nd day air/priority mail.  
For overnight air delivery add \$10.  
Box 50062-C, Provo UT 84605

CIRCLE 11 ON READER SERVICE CARD

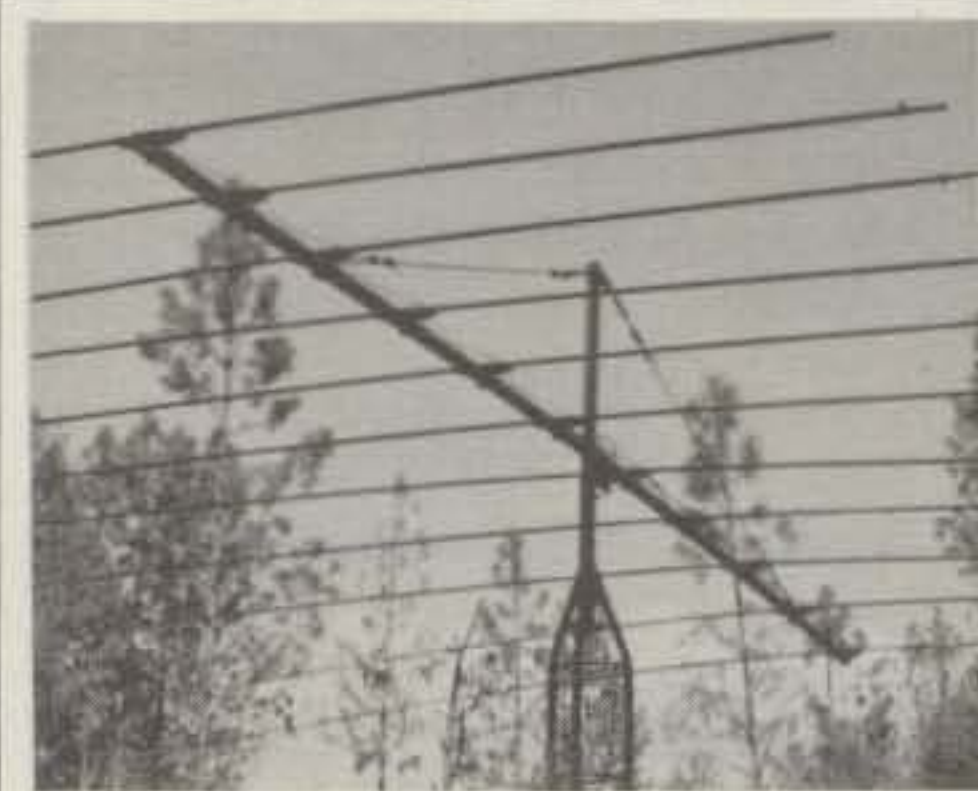

**IF YOU'RE INTERESTED IN ANTENNAS -** We've got a big NEW catalog covering our yagis, remote switchboxes, phasing and stacking boxes and lots more, write or call for our free catalog. Check out our new **17 meter yagle** and hear what you've been missing! 17DX4-LB, 4 el., 32' boom \$375; 17DX4, 4 el., 20' boom \$309.

**INTRODUCING OUR NEW 4-BAND LOG PERIODIC -** We know a lot of you want to have a big 20 meter antenna, plus something to cover the other bands well. This is the answer. Covering 17,15,12 and 10 meters, this 11-element log periodic on a 24 foot boom exhibits high gain and exceptional pattern, typically 20-25 db F/B, outperforming other log antennas with shorter booms and fewer elements. All 6061-T6 and stainless hardware kit standard. \$595.

IF you're thinking about upgrading your station, please consider us. We're owned and operated by active DX'ers and contesters. We know what it takes and WE HAVE what it takes.

WRITE or call for catalog or information.

**DX Engineering, Inc.**  
618 Spaulding Ave.,  
Brownsville, OR 97327  
(503) 466-3138

CIRCLE 39 ON READER SERVICE CARD





**END YOUR SEARCH FOR THE BEST DEAL WITH DEN-TRONICS**

LOOK NO FURTHER DEN-TRONICS IS YOUR AUTHORIZED DEALER FOR . . .

AEA KANTRONICS MFJ  
PK-232 KAM KPC-2 KPC-4 MFJ-1278  
FSTV-430 MFJ-1270B  
PK-88 AND MORE! MFJ-1274

ORDER LINE  
**1-800-PAC-KITT**

**DEN-TRONICS**  
AMATEUR RADIO & COMPUTER

6102 DELAND RD. • FLUSHING, MICHIGAN 48433  
(313) 659-1280



Is Your Azden Not Operating Properly??  
Does It Turn Off When It Should Turn On??  
If You Have Any Problem With Your Azden Transceiver Send It To The Specialists At The Azden Service Center. Quick Turn Around!!

Hourly Rate: \$35.00  
Your Problem Is Our Solution.

Amateur - Wholesale - Electronics  
P.O. Box 224 • 1040 Industrial Drive  
Watkinsville, GA 30677  
Or Call (404) 769-8706

We Accept: VISA, Mastercard,  
Personal Checks And Send C.O.D.

**Model WLA75M**  
**10-1000 MHZ PREAMP-2 OUTPUTS**



For scanners, ICOM R-7000, analysers, counters, scopes, etc. Gain 20 dB, Noise Fig. 2.8 dB, Pout (1 dB) 8 dBm, 12-15 VDC. With input protection, in cast aluminum case. Only \$129 + \$4.

**WILAM TECHNOLOGY**

P.O. Box 5174, MASSENA, N.Y. 13662  
(315) 769-8334

CIRCLE 85 ON READER SERVICE CARD



**Out of State 1-800-882-1343**

(213)390-8003 FAX 213-390-4393

HOURS M-F 9:00 - 5:30 SAT 9:00 - 5:00 SE HABLA ESPANOL  
QUICK SERVICE CENTER FOR REPAIR NEEDS

3919 SEPULVEDA BOULEVARD, CULVER CITY, CALIFORNIA 90230

**ICOM IC-781**



HF Equipment	List	Jun's
IC-781 Super Deluxe HF Rig	\$5995.00	Call \$
IC-765 New, Loaded with Features	3149.00	Call \$
IC-735 Gen. Cvg. Xcvr	1099.00	Call \$
IC-751A Gen. Cvg. Xcvr	1699.00	Call \$
IC-725 New Ultra-Compact Xcvr	949.00	Call \$
IC-726 HF/50 MHz All Mode	1299.00	Call \$
<b>Receivers</b>		
IC-R9000 100 kHz to 1999.8 MHz	5459.00	Call \$
IC-R7000 25-1300 + MHz Rcvr	1199.00	Call \$
IC-R71A 100 kHz - 30 MHz Rcvr	999.00	Call \$
<b>VHF</b>		
IC-228A/H New 25/45w Mobiles	509./539.	Call \$
IC-275A/H 50/100w All Mode Base	1299./1399.	Call \$
IC-28A/H 25/45w, FM Mobiles	469./499.	Call \$
IC-2GAT, New 7w HT	429.95	Call \$
IC-2SAT Micro Sized HT	439.00	Call \$
IC-901 New Remote Mount Mobile	1199.00	Call \$
<b>UHF</b>		
IC-475A/H 25/75w All Modes	1399./1599.	Call \$
IC-48A FM Mobile 25w	509.00	Call \$
IC-4SAT Micro Sized HT	449.00	Call \$
IC-4GAT, New 6w HT	449.95	Call \$
IC-04AT FM HT	449.00	Call \$
IC-32AT Dual Band Handheld	629.95	Call \$
IC-3210 Dual Band Mobile	739.00	Call \$
IC-2500A FM, 440/1.2 GHz Mobile	999.00	Call \$
IC-24AT New 2m/440 mini HT	629.95	Call \$
IC-2400 144/440 FM	899.00	Call \$
<b>220 MHz</b>		
IC-3SAT Micro Sized HT	449.99	Call \$
IC-375A All-Mode, 25w, Base Sta.	1399.00	Call \$
<b>1.2 GHz</b>		
IC-12GAT Super HT	529.95	Call \$

**KENWOOD TS-950SD**



HF Equipment	List	Jun's
TS-950SD New Digital Processor HF	\$4399.95	Call \$
TS-940S/AT Gen. Cvg. Xcvr	2499.95	Call \$
TS-440S/AT Gen. Cvg. Xcvr	1449.95	Call \$
TS-140S Compact, Gen. Cvg. Xcvr	949.95	Call \$
TS-680S HF Plus 6m Xcvr	1149.95	Call \$
TL-922A HF Amp	1982.95	Call \$
<b>Receivers</b>		
R-5000 100 kHz - 30 MHz	1049.95	Call \$
R-2000 150 kHz - 30 MHz	799.95	Call \$
RZ-1 Compact Scanning Recv.	599.95	Call \$
<b>VHF</b>		
TS-711A All Mode Base 25w	1059.95	Call \$
TR-751A All Mode Mobile 25w	669.95	Call \$
TM-231A Mobile 50w FM	459.95	Call \$
TH-225A New 2m HT	399.95	Call \$
TH-26AT Compact 2m HT	369.95	Call \$
TM-731A 2m/70cm, FM, Mobile	749.95	Call \$
TM-701A 25w, 2m/440 Mobile	599.95	Call \$
TH-75A 2m/70cm HT	549.95	Call \$
<b>UHF</b>		
TS-811A All Mode Base 25w	1265.95	Call \$
TR-851A 25w SSB/FM	771.95	Call \$
TM-431A Compact FM 35w Mobile	469.95	Call \$
TH-46AT Compact 440 FM, HT	399.95	Call \$
TH-45AT 5w Pocket HT NEW	389.95	Call \$
TH-55 AT 1.2 GHz HT	524.95	Call \$
TM-531A Compact 1.2 GHz Mobile	569.95	Call \$
<b>220 MHz</b>		
TM-3530A FM 220 MHz 25w	519.95	Call \$
TM-331A Compact Mobile	469.95	Call \$
TH-315A Full Featured 2.5w HT	419.95	Call \$

**YAESU FT-1000D**



HF Equipment	List	Jun's
FT-1000D Top Performer	\$4399.00	Call \$
FT-747 GX Economical Performer	889.00	Call \$
FT-757 GX II Gen. Cvg. Xcvr	1280.00	Call \$
FT-767 4 Band New	2299.00	Call \$
FL-7000 15m-160m Solid State Amp	2279.00	Call \$
<b>Receivers</b>		
FRG-8800 150 kHz - 30 MHz	784.00	Call \$
FRG-9600 60-905 MHz	808.00	Call \$
<b>VHF</b>		
FT-411 New 2m "Loaded" HT	406.00	Call \$
FT-212RH New 2m, 45w Mobile	499.00	Call \$
FT-290R All Mode Portable	610.00	Call \$
FT-23 R/TT Mini HT	351.00	Call \$
<b>UHF</b>		
FT-712RH, 70cm, 35w Mobile	536.00	Call \$
FT-811 70cm built-in DTMF HT	410.00	Call \$
FT-790 R/II 70cm/25w Mobile	681.00	Call \$
<b>VHF/UHF Full Duplex</b>		
FT-736R, New All Mode, 2m/70cm	2025.00	Call \$
FEX-736-50 6m, 10w Module	294.00	Call \$
FEX-736-220 220 MHz, 25w Module	322.00	Call \$
FEX-736-1.2 1.2 GHz, 10w Module	589.00	Call \$
FT-690R MKII, 6m, All Mode, port.	752.00	Call \$
<b>Dual Bander</b>		
FT-4700RH, 2m/440 Mobile	996.00	Call \$
FT-470 Compact 2m/70cm HT	576.00	Call \$
<b>Repeaters</b>		
FTR-2410 2m Repeaters	1154.00	Call \$
FTR-5410 70cm Repeaters	1154.00	Call \$
<b>Rotators</b>		
G-400RC light/med. duty 11 sq. ft.	242.00	Call \$
G-800SDX med./hvy. duty 20 sq. ft.	390.00	Call \$
G-800S same/G-800SDX w/o presets	322.00	Call \$

**ALINCO**

DR-590



DR-590T, New Twin Band Mobile  
DR-570T, 2 Meter/70 cm Mobile  
DR-110T, Value Loaded, 2M Mobile  
DJ-160T, Feature Packed 2M Handy  
DJ-120T, Mini Size, Maxi Feature, 2M, HT

DJ-160T



**JUN'S BARGAIN BOX OVERSTOCK SALE**

ICOM	
IC-02AT w/BP-7, 5 watt, 2M, HT	\$289.95
IC-03AT, 220 MHz, HT	\$289.95
IC-28H, 45 watt, 2M, mobile	\$369.95
IC-3SAT/2SAT, FREE BP-82	\$349.95 ea.
IC-725 w/FM unit, All band HF	\$779.95
KENWOOD	
TH-75A, Dual-Band Handheld	CALL
YAESU	
FT-23R, Compact, 2M Handheld	\$249.95

**DON'T DELAY—CALL**

## REGULATORY HAPPENINGS FROM THE WORLD OF AMATEUR RADIO

### *From 15 BPS To 50 Million—Processing Digital Data*

**R**ule No. 1 in the United States is you must be proficient in the international Morse code if you want to be an amateur radio operator. It's a long story as to exactly why! In a sentence, the reason has always been that's the way the amateur community wants it. It looks like this is about to change.

You can trace binary signaling almost to the beginning of civilization! Smoke signals, jungle drums, and reflected sunlight are all forms of binary code. Simply stated, binary numbering is a two-bit code system. The two bits can be anything—presence/absence, start/stop, on/off, yes/no, voltage/no voltage, etc. In CW (continuous wave Morse Code signaling) it is a series of spaced short and long tones.

The ones and zeros that are so basic to modern computers are actually clusters of binary signals of equal duration. Each series of binary bits processed together is called a byte. A CW character is a series, or byte, of one to five dots and dashes averaging 10 bits. A series of bytes becomes a word.

When you come right down to it, the only difference between Morse code and today's 32-bit bytes is speed. Human brain "computers" simply don't have the capacity to process 5-bit Baudot codes very fast, much less today's 32-bit. It takes a machine, a teletypewriter, to interpret Baudot signals being sent at 60 words per minute. Remember that back in the 1950s radioteletype was state-of-the-art. We knew about computers, but they were beyond the expertise and pocketbook of the average ham.

Actually the first electronic computer, the ENIAC (for Electronic Numerical Integrator and Computer), was developed only in the mid-1940s. It was a giant and contained 18,000 vacuum tubes, weighed 30 tons, and occupied a room 30 by 50 feet. The term "debugging" originated when ENIAC's operators had to sweep out the moths that accumulated from its heat.

Developed at the University of Pennsylvania, in 1946 ENIAC was shipped to the Aberdeen Proving Ground in Maryland. It was primarily used to compute the

trajectory of shells during WW II. During 1952 approximately 19,000 tubes had to be replaced—more than 100% of the tube complement! ENIAC was operational until 1955, and today you can see portions of it at the Smithsonian Institution's new Information Age exhibit. It's worth the trip!

Thanks to the invention of transistors (1948) and integrated logic circuits (1965), microprocessors that have blinding speed have been developed. You might think 20 words per minute (about 15 bits/second) Morse code human processing is fast, but microchips today operate in the millions of instructions (baud) a second. Clock rates of 500 times faster than ENIAC's 100 kilobits/second are now possible at a very tiny fraction of its cost and size.

Computer processing that cost tens of thousands of dollars and took up an entire room now is available as a low-cost desktop consumer appliance. The majority of this progress has taken place in just the last decade! Unfortunately, amateur radio has not kept up, and we still require antiquated technology as a prerequisite. I say "we" because it is the amateur community and not the FCC that has always emphasized the need for telegraphy proficiency. The average age of our amateur operators has now increased to about 50, as relatively few newcomers appear interested in Morse communication. They would rather play with their computers.

#### History of International Radio Regulations

Why then is Morse code a requirement? Is it the international law? Well, yes and no! Article 32 of the International Radio

Regulations states, "Any person seeking a license to operate the apparatus of an amateur station shall prove that he is able to send correctly by hand and to receive correctly by ear texts in Morse code signals. The administrations may, however, waive this requirement in the case of stations making use exclusively of frequencies above 30 MHz." In actual practice, however, applicants are no longer required to be tested on hand sending code since our FCC has taken the position that receiving Morse code is evidence that an applicant also can send it.

An equivalent international regulation has existed from at least 1938. Article 8, Section 197 (Cairo WARC 1938) required "... any person operating amateur and private experimental station apparatus, either on his own account or for another, must have proved his ability to transmit passages in the Morse Code and to read in telegraphy reception by ear, passages thus transmitted. He may be replaced only by authorized persons possessing the same qualifications."

In 1947 (Atlantic City WARC) the regulation (Article 42, Section 1003.3) included for the first time a frequency limit above which a test in Morse code may be waived and set this limit at 1000 mc/s. In 1959 (Geneva WARC) this frequency limit was lowered to 144 MHz, and in 1979 (another Geneva WARC) it was lowered to its current 30 MHz.

The text of this international regulation has been amended at each general WARC since 1947, and it is wondered what will happen at the next general WARC. The next WARC will be held in 1992, but appears to be limited in scope to reviewing frequency allocations in certain parts of the spectrum. The next

	Fiscal Year 1988	Fiscal Year 1989	1989
<b>Novice System Subtotal</b>	<b>18,550</b>	<b>20,047</b>	<b>40.5%</b>
Technician	15,157	16,047	33.4%
General	5,404	5,479	11.1%
Advanced	4,902	4,397	8.9%
Amateur Extra	3,399	3,013	6.1%
<b>VEC System Subtotal</b>	<b>28,872</b>	<b>29,411</b>	
<b>New and Upgraded</b>	<b>47,422</b>	<b>49,458</b>	<b>100%</b>

Table 1—Amateur service processing demand. Note that 73.9% of all amateur licenses issued by the FCC are for the Novice and Technician class. (Source: FCC, Gettysburg, Pennsylvania.)

National Volunteer Examiner Coordinator,  
P.O. Box 565101, Dallas, TX 75356-5101

VEC	Test Elements Administered	Rank	Share	Cumulative
ARRL-VEC	25,525	1	45.35%	45.35%
W5YI-VEC	18,719	2	33.26%	78.61%
C. Alabama	3,528	3	6.27%	84.88%
Sunnyvale	1,751	4	3.11%	87.99%
DeVry	1,628	5	2.89%	90.88%
13 Others	5,130		9.12%	100.00%
<b>Totals</b>	<b>56,281</b>		<b>100.00%</b>	<b>100.00%</b>

Table II- Amateur service testing by VEC, January to June 1990. A record 56,000 amateur radio operator test elements were coordinated by Volunteer Examiner Coordinators at 3046 test sessions between January and June 1990. This is an 8.4% increase over the prior year. Although there are 18 VECs, the ARRL and W5YI-VEC testing programs account for nearly 80% of all amateur radio operator testing above the Novice level. (Source: FCC, Private Radio Bureau, Washington, DC.)

WARC that could review Article 32 is not known at this time.

### Modern Amateur Radio

Amateur radio is a great many things in the 1990s. There are so many technical and operational challenges that it is totally impossible to participate in all of them. Solid-state technology, the widespread availability of commercial equipment, and associated applications with computers have greatly expanded the potential of amateur radio operations.

Is it really essential for Morse code to be a compulsory component laid down by

international regulation? There are several efforts underway right now in other countries looking toward eventually eliminating the Morse proficiency requirement from the international law. This would allow the various ITU nations to decide for themselves how the telegraphy requirement should be handled in their countries.

Does passing a test in Morse code necessarily make an amateur a better operator on any frequency? Some amateurs feel the effort it takes one to learn the code is an indication of motivation and quality. Others point out there are no international regulations that specify li-

censing requirements for speaking into a microphone for SSB voice transmission or for feeding computer-derived data into a packet radio link.

### Why Morse Code Above 30 MHz?

Our system of government is one of public participation—government of the people, for the people, by the people. We elect our legislators to represent us and procedures exist allowing the public to advise our government's administrative agencies.

In the past there has been widespread public outcry every time our Federal Communications Commission has attempted to relax the U.S. amateur licensing requirements as provided by international law. Amateurs, represented by the American Radio Relay League, relentlessly have gone to great pains during past campaigns to express their reservation about reducing any Morse code requirement.

They point out Morse code is the common bond that ties all amateur operators together, an internationally understood language requiring less spectrum. They say code-only transmitters are easier and cheaper to build and get through when other modes fail. Amateurs have always been concerned about congestion



P.O. Box 6522  
220 N. Fulton Ave.  
Evansville, IN 47719-0522

#### Store Hours

MON-FRI: 8 AM-5 PM  
SAT: 9 AM - 3 PM  
CENTRAL TIME

SEND A SELF ADDRESSED STAMPED (50¢) ENVELOPE (SASE) FOR NEW AND USED EQUIPMENT SHEETS.

WARRANTY SERVICE CENTER FOR:  
ICOM, YAESU, TEN-TEC

FOR SERVICE INFORMATION CALL  
(812) 422-0252  
FAX 812-422-4253  
MONDAY - FRIDAY

#### TERMS:

Prices Do Not Include Shipping.  
Price and Availability Subject to  
Change Without Notice  
Most Orders Shipped The Same Day  
COD's Welcome (\$4.00 + shipping)

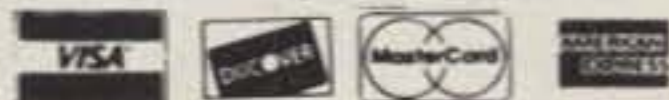

ORDERS &  
PRICE CHECKS

**800-729-4373**  
NATIONWIDE & CANADA

LOCAL  
INFORMATION **812-422-0231**



# YAESU



**FT-736R**  
2 Meter, 70cm, Optional 50,  
220, 1.2 GHz Work Satellites,  
Moonbounce, Aurora,  
Meteor Scatter.



**FT-757 GX Mark II**  
HF Portability And Performance



**FT-1000**  
Get The Competitive Edge  
This Contest Season  
All Band HF Performer



**FT-212RH**  
Power... And More!  
45 Watt, 2 Meter Mobile



**FT-411**  
2 Meter HT  
Leads The Pack  
With Industry  
"FIRSTS"  
2 VFO's, Built-in  
CTCSS Paging And  
PL Encode/Decode  
... Plus More



**FT-470**  
Dual-Band  
Performance  
Perfect  
2 Meter/70 cm  
With All The  
Features You Want

Large Selection Call For Prices All Your Favorite Accessories

on the amateur bands and quality of operation. They saw what happened when the 11 meter amateur band was reallocated to CB. While most other nations have successful code-free amateur classes, the United States does not.

Today's newcomer, especially youngsters, does not seem to be interested in learning the code when he or she can tinker with newer technology. Computers do not require a license when data is exchanged over the telephone. They could, however, be linked by free radio waves instead of tying up an expensive phone line. And there are all sorts of other new electronic gadgets that those so inclined can operate without being licensed. Sadly, at a time when interest in home computers

and satellites is mushrooming, growth in the amateur radio service is stagnating. To make matters worse, the commercial need for our incredibly valuable spectrum is sky-rocketing.

Amateurs began rethinking their position when the FCC began reallocating amateur spectrum to commercial interests a couple of years ago. The reallocation of 220-222 MHz really should not have come as a surprise. The Commission made it crystal clear in 1983 that since the amateur community didn't wish to expand use of its frequencies, amateur spectrum would necessarily become a prime candidate for reallocation. Amateur radio frequencies are, by far, our most valuable resource and will even be

more precious as technology in the microwave area continues to develop.

The FCC agreed to look once more into the issue of relaxing the Morse code requirement when a dozen petitioners, surprisingly including the reserved American Radio Relay League, requested provision for the code-free amateur operation allowed by international law.

On February 8, 1990 the FCC formally proposed a Communicator amateur license which would not require any test of Morse code proficiency. They pretty much followed the suggestions of the ARRL; that is, privileges would include all amateur frequencies 222 MHz and above. There was a major difference, however. The Commission's version of code-free amateur operation was designed so as not to exceed their present application processing capacity. The FCC proposed to eliminate the Novice and Technician classes and replace them with a code-free Communicator class.

The Commission presently processes about 50,000 amateur licenses a year. Notice that 75% are at the Novice and Technician class level (see Table I). Note too that there are two distinctly separate testing programs: the Novice and the VEC Systems.

Novices are tested by two volunteer examiners who need not be accredited by a VEC. Applicants for the Technician through the Extra class level are administered examinations by three VEs in a more structured atmosphere (see Table II). There are currently 18 Volunteer Examiner Coordinator organizations. A VEC acts as the liaison between the volunteer examiner team and the FCC.

There is a growing feeling in amateur circles that there should only be one examination program administered through the VEC system since all test questions (including those of the Novice program) are developed by the VEC's Question Pool Committee (QPC). The VEC testing system is also perceived to be a more trustworthy program.

In this day of Gramm-Rudman and controlled budget deficits, the FCC knew they had no hope of obtaining additional resources to process amateur applications. They did the only thing they could and still not increase costs. They merely traded the Novice/Technician processing costs for the code-free Communicator class processing. This would allow 40,000 new code-free Communicator class licenses to be issued by their Gettysburg, Pennsylvania facility. This assumed, of course, there would be no increased amateur license demand caused by a code-free class. We believe this to be an incorrect assumption, since there seem to be many individuals who would be amateurs if it were not for the code requirement. The public comment period ended August 6th, replies September 7th.



**Protect Your Investment with The Pouch**

For Every Portable Every Battery

Tough..... resilient..... black neoprene

A sturdy web belt-loop sewn on the back extends over the top and is secured on the front with a velcro tab.

**5 Sizes**

- \***SUPER-SMALL** for IC-25at
- \***SHORT** for other Mini H.T.s
- \***SLIM** (7) - FT4II, IC-24at, etc.
- \***G** - Fits full-size handhelds
- \***LONG** (9) - TH75a & Bricks.

**The Pouch** It's Washable!

**1-800-72-Pouch** (Dealer Information)

CIRCLE 112 ON READER SERVICE CARD

\*\*\*\*\*PRESENTING\*\*\*\*\*

**CABLE TV DESCRAMBLERS**

\*\*\*\*\*STARRING\*\*\*\*\*

**JERROLD, HAMLIN, OAK**

AND OTHER FAMOUS MANUFACTURERS

- FINEST WARRANTY PROGRAM AVAILABLE
- LOWEST RETAIL/WHOLESALE PRICES IN U.S.
- ORDERS SHIPPED FROM STOCK WITHIN 24 HOURS

FOR FREE CATALOG ONLY 1-800-345-8927

FOR ALL INFORMATION 1-818-709-9937

---

**PACIFIC CABLE CO. INC.**  
7325 1/2 RESEDA BLVD., DEPT. 969  
RESEDA, CA 91335



CIRCLE 25 ON READER SERVICE CARD

## Magnificent Alinco Deals!

### ALINCO 45W 2M Xcvr. YOUR CHOICE!

<p><b>DR-110T</b></p> <p><b>\$299.00</b></p> <p>Red LCD Readout</p>	<p><b>DR-112T</b></p> <p><b>\$319.00</b></p> <p>Black LCD w/orange Backlite</p>
---	---



---



**ALINCO DJ-160T 2M \$259.00**

**ALL OTHER ALINCO MODELS**

DR-590T, Remotable, Twin-Bander.....	\$649.00
DJ-560T Twin Band 2/70 H/T.....	(New) CALL!
DR-570T Twin-Bander 2/70.....	\$549.00
DJ-460T 440 MHz H/T.....	\$269.00
DJ-120T Micro 2 Meter.....	\$209.00

FREE SHIPPING! (Pays for your Phone Call) N.C. Residents add 5% Sales Tax. SEND CHECK OR MONEY ORDER for Quoted Price, or Phone for CODs ONLY. Add \$3.50 for Phone CODs. NO CREDIT CARDS. Prices and availability subject to change without notice or obligation.

**WILLIAMS RADIO SALES**

600 LAKEDALE ROAD  
COLFAX, N.C. 27235

Orders Only Noon-5 pm

**(919) 993-5881**

Orders and Technical 7-10 pm

This time the comments from the amateur community are vastly different. As a general rule, amateurs are in favor of a codeless amateur class. While the ARRL still insisted that code-free operation should only be above 222 MHz, most other large amateur groups felt that any codeless class adopted should extend down to the 30 MHz level authorized by the ITU and adopted by most countries that have a code-free amateur class. Among others, these groups include the Quarter Century Wireless Association (QCWA), the Radio Amateur Satellite Corp. (AMSAT), Tucson Amateur Packet Radio (TAPR), the Volunteer Examiner Coordinators (VECs), the Amateur Industry Group (AIG), and the National Amateur Radio Association (NARA).

They also argued that it was important for newcomers to be exposed to routine amateur operation which is lacking in most areas of the nation at the 220 MHz and higher frequency level. They believe a 5 words-per-minute code test is not a fair prerequisite for obtaining 6 and 2 meter operating privileges when telegraphy is basically non-existent at the VHF and higher amateur band level.

It will probably be year end or early spring 1991 before we find out how the Federal Communications Commission will rule on no-code. But the handwriting is on the wall. We predict you will see code-free amateur radio operating in the United States in view of the overwhelming change of heart on the part of the amateur community. Best guess is that it will be implemented in mid-1991. It appears the question is not "if" but "how" it will be achieved. We'll keep you posted.

## Amateur Radio Exams

We keep getting questions about the mechanics of amateur radio license testing. Here are the basics!

All of the multiple-choice questions that make up the "Question Pools" are developed by a group of VECs (Volunteer Examiner Coordinators) called the Question Pool Committee, or QPC for short. Approximately ten times as many questions as will be asked on any one examination make up each of the five question sets.

There are five different sets of questions—one each for the Novice, Technician, General, Advanced, and Amateur Extra classes. Novice applicants study the questions, and then a team of two VEs administers 30 questions chosen from the pool according to a formula.

Novice-level VEs must hold at least a General class license, have clean radio enforcement records, be 18 years old or more, and not be related to examinees to administer the Novice 5 words-per-minute code (Element 1A) and 30-question written "theory" (Element 2) examina-

tions. Applicants failing any examination may, at the option of the testing team, be retested immediately.

We have Novice testing kits available (\$4.95 postpaid) containing everything needed to conduct a Novice testing session. Included are pre-made written and telegraphy examinations, FCC Form 610 applications, and an instruction booklet. We even have software available (another \$4.95) which will permit a VE team to (1) examine a Novice applicant directly at a computer keyboard or (2) generate a properly constructed printed Novice examination and answer sheet. The computer automatically produces a scored answer sheet if the test is taken at the keyboard. (Examiners ordering Novice testing material must include a copy of their General or higher class operator license.)

All question pools are available and widely published along with the multiple choices and correct answer identified. These question-and-answer sets are available to anyone and may be obtained from many amateur radio publishers or by mail from The W5YI Group (P.O. Box 565101, Dallas, TX 75356). *The Licensing Handbook* (\$11.95 postpaid) contains all 1931 questions appearing in the Novice, Technician, General, Advanced, and Extra class examinations.

As mentioned above, three Advanced or higher class volunteer examiners are required to administer the higher license classes (Technician through Extra class) VE/VEC System examinations. In addition, the VEs must be approved (or "accredited") by Volunteer Examiner Coordinators (VECs). Your author heads up the second largest VEC organization in existence. More than 7000 Extra class VEs are accredited worldwide under the W5YI-VEC testing program. The W5YI-VEC does not accredit Advanced class VEs.

Send a self-addressed stamped envelope for a VE application if you are an Extra class level amateur and wish to be accredited under the W5YI-VEC banner. Request a copy of our VE Manual if you are serious about starting a testing team or give us a call at 817-461-6443. There is no charge to become accredited. Volunteer examiners in the VE/VEC System follow the testing instructions supplied by the Volunteer Examiner Coordinator. VECs in turn follow the testing guidelines issued by the FCC in §Part 97 of the Commission's rules.

Every VEC organization uses exactly the same word-for-word test questions, multiple choices and answers, for every license class, Novice through Extra class. Thus, all license preparation material available from any publisher applies to all upcoming examinations.

One word of caution, however. The VEC Question Pool Committee periodically revises each of the various question

**NOW  
FACTORY  
DIRECT!!!**

# STEP UP TO TELREX ANTENNAS ANTENNA SYSTEMS

**"INVEST" in a Telrex antenna!**

Why gamble with shoddy antenna construction when Telrex makes available a professionally designed quality product.



Antennas that last "Decades"  
(not months)



Some of the WORLD'S finest.

TB4EC 10, 15, 20 Mtr.  
TB5ES 10, 15, 20 Mtr.  
TB5EM 10, 15, 20 Mtr.  
TB6EM 10, 15, 20 Mtr.

20M326 3 elem. 20 Mtr.  
20M536 5 elem. 20 Mtr.  
20M646 6 elem. 20 Mtr.

15M532 5 elem. 15 Mtr.  
15M845 8 elem. 15 Mtr.

10M523 5 elem. 10 Mtr.  
10M636 6 elem. 10 Mtr.

2MVS814, 2 Mtr. phased

Prices Subject to Change.  
All Prices FOB New Jersey

C  
A  
L  
L  
F  
O  
R  
P  
R  
I  
C  
E  
S



For data on the complete line of Telrex antennas phone (anytime) and leave your call sign, or write.

Phone: 201-775-7252

Write: **Telrex** P.O. Box 879  
Asbury Park, N.J. 07712

# 1991 CALLBOOKS



## THE QSL BOOK!

Extending a 70 year tradition, we bring you three new Callbooks for 1991 with more features than ever before.

The 1991 North American Callbook lists the calls, names, and address information for over 500,000 licensed radio amateurs in all countries of North America, from Panama to Canada including Greenland, Bermuda, and the Caribbean Islands plus Hawaii and the U.S. possessions.

The new 1991 International Callbook lists 500,000 licensed radio amateurs in the countries outside North America. It covers South America, Europe, Africa, Asia, and the Pacific area (exclusive of Hawaii and the U.S. possessions).

The 1991 Callbook Supplement will be published June 1, 1991, with thousands of new licenses, address changes, and call sign changes received over the preceding six months. This single Supplement will update both the North American and International Callbooks.

Every active amateur needs the Callbook! Fully updated and loaded with extra features, the new 1991 Callbooks will be published December 1, 1990. Order now from your dealer or directly from the publisher.

- RC0191 North American Callbook  
incl. shipping within USA \$33.00  
incl. shipping to foreign countries 39.00
- RC0291 International Callbook  
incl. shipping within USA \$33.00  
incl. shipping to foreign countries 39.00
- RC0391 Supplement, published June 1st  
incl. shipping within USA \$13.00  
incl. shipping to foreign countries 14.00

### SPECIAL OFFER

- RC01912 Both N.A. & International  
Callbooks incl. shipping in USA \$63.00  
incl. shipping to foreign countries 73.00

Illinois residents please add 6½% tax.  
All payments must be in U.S. funds.

RADIO AMATEUR  
**callbook** INC.



Dept RACM0005  
925 Sherwood Dr., Box 247  
Lake Bluff, IL 60044, USA

Tel: (708) 234-6600

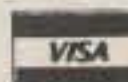

sets to make certain that the questions properly reflect the changes in amateur radio rules, operation, and technology. Be certain you obtain the current versions. All General, Advanced, and Extra class examinations will change on November 1, 1990. (The Novice and Technician written tests were last revised on July 1, 1990.)

Novice examinations usually take place at the homes of the amateur examiners, while VE/VEC System test sessions are more formal. They are usually held at public places such as schools or other meeting rooms. There is never a charge to take a Novice examination. The test fee for VE/VEC System examinations, however, is currently a maximum of \$4.95. This fee is adjusted every January by the FCC based on changes in inflation.

Completed Form 610 applications for the Novice license are sent by the VE team directly to the FCC in Gettysburg, Pennsylvania. VE/VEC System applications, however, must be sent to the VEC by the VE team for initial processing. The VEC checks the paperwork for proper handling, approves the application, and then forwards to Gettysburg for license issuance. Novice-level examinees can also take their examinations at regularly scheduled VE/VEC sessions at no charge. It usually takes about a month to receive a Novice license from the FCC after testing, and a little longer for Technician and

higher upgrades since the application must go through the VEC System.

The Novice, General, and Extra class levels require testing in Morse code proficiency at 5, 13, and 20 words per minute. The 5 words-per-minute code test is usually made up by the VE, while the 13 and 20 words-per-minute code test is most often supplied by the VEC to the volunteer examiner. The 5 words-per-minute code test is frequently sent by hand, while the faster speed code exams are almost always transmitted on a cassette tape.

The actual code test may be designed by either the volunteer examiner and/or the VEC and usually consists of a transmission typically heard on the amateur airwaves. Each examination must contain all alphabet letters, numerals one to zero, and certain punctuation and operating procedure signs.

## Do You Have A Computer?

We've just developed an exciting new product which helps applicants prepare for their written amateur radio exams! It's software written for an IBM-PC compatible computer which lets you take any number of instantly-scored practice exams at the keyboard or print out any number of unique practice exams (complete with an answer key) for yourself, your friends, your students, etc. All exams are made up of the proper mixture of questions from the question pool and each is different! It can also be set up to let you practice all the questions in one sub-element if you feel the need for heavy-duty study of a difficult section.

You won't believe how easy it is to use! Just enter the name of the license class you want to study, press the ENTER key two more times, and presto! You're studying! You can review and/or change your answers at any time, skip over questions and come back to them later, and keep constant track of your progress. You can also customize a variety of features to your personal taste. We've needed this kind of study method for a long time in amateur radio.

The best part is the price! We'll send you four 360-K, 5¼ inch floppy disks which cover all 1931 questions appearing in all license classes, Novice through Extra, postage paid for \$19.95. These disks can be copied to a hard disk for extra speed or can be used directly by any 256K (or greater) IBM compatible computer. Practicing at the keyboard does not require a printer, but if one is connected to LPT1: it can be used to make serial-numbered, printed practice exams for personal or classroom use.

Want to order? Money-back guarantee from: The W5YI Group, P.O. Box 565101, Dallas, TX 75356. VISA/MasterCard call (toll-free) 1-800-669-W5YI (9594).

Until next month . . .

73 de W5YI

## G4ZPY PADDLE KEYS

BRITAIN'S LEADING MANUFACTURER OF  
HAND BUILT MORSE KEYS  
LARGEST SELECTION OF KEYS IN THE WORLD

For Details send Business size S.A.S.E. to  
**Charles Tryor, N4LMY**  
7809 10th Avenue South  
Birmingham, Alabama 35206

## R-4C Enhancements

### MIX-4 Solid State R-4C 3rd Mixer

The Solution to the One Remaining Problem  
with the Drake / Sherwood R-4C

Noisy 6EJ7 third-mixer tubes have plagued R-4C owners for years. Eliminate frying, crackling, microphonics, and power-line buzz with our newest of four (AMP-4, MIX-4, PD-4, & PS-4) modules. \$59.00, plus \$5.00 shipping per order, UPS ground.

## County Hunters Software

### "CHERRIES"

Designed by a top county hunter for county hunters. Works on all IBM-type computers. Hard disk recommended. Now shipping version 1.206. \$69.00, plus \$5.00 shipping per order, UPS ground.

## Sherwood Engineering, Inc.

1268 South Ogden Street, Denver, CO 80210  
(303) 722-2257 Monday - Friday 9 A.M. - 5 P.M.

# For Brands You Can Count On

## AT PRICES YOU CAN LIVE WITH

### CALL TOLL FREE: 1-800-238-6168

Find out why thousands of customers have switched to us.

KENWOOD, ICOM, TEN-TEC, Astron, Cushcraft, Larsen, MFJ, Butternut, B&W, Hustler, Antenna Specialists, AEA, Ameritron, Van Gorden, ARRL, RF Concepts, Diamond, Kantronics, CallBook, Alpha Delta, Heil, Grundig, Uniden, Bearcat, Mirage, Ameco, Alliance, Daiwa, Hy-Gain, Valor & others

### TRADE?

Yes, if you have clean, saleable gear!

**CALL FOR FREE APPRAISAL**

In Tennessee, Call 901-683-9125

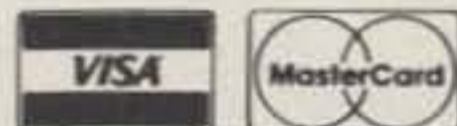

## Memphis Amateur Electronics, Inc.

(In Business Almost a Quarter Century)

1465 Wells Station Road, Memphis, TN 38108



CIRCLE 23 ON READER SERVICE CARD

### STORE HOURS:

Mon.-Fri., 9 to 5  
Sat., 9 to noon  
(Central Time)



Quorum introduces the first totally integrated system for the reception of weather satellite images directly on your personal computer. Selection of HF NAFAX, GOES WEFAX, GOESTAP, METEOSAT, NOAA and METEOR APT (including satellite downlink frequency selection) are made under complete program control from your PC keyboard.

The easy to learn and use Menu driven program allows you to capture, store, retrieve, view and print images with a few simple keystrokes. Images can be colorized from a palette of up to 262,000 colors when using a VGA display.

System configurations capable of NAFAX reception start at \$399.00 while fully capable systems can be configured for \$1500 to \$2000.00, providing professional quality at low prices.

For complete information and a Demo Disk, call or write:

Quorum Communications, Inc., 1020 S. Main St. Suite A, Grapevine, TX 76051 (817) 488-4861. Or, download a demo from our Bulletin Board by calling (817) 421-0228 using 2400 baud, 8 data bits and No parity.

QUORUM COMMUNICATIONS

Receive Weather Satellite Images and Charts on your PC with Quorum's Totally Integrated and Affordable Weather Facsimile System

Computer Controlled Ham Shack for personal or club system  
New Simplex option, operate patch & remotes via repeaters!

**Ultra Comshack 64 Duplex/Simplex Controller**  
HF & VHF Remote Base\*Autopatch\*CW Practice\*Rotor Control  
\*Voice Meters\*Paging\*Logging\*Polite ID's\*Packet Voice B.B.S.



Model CS64S  
REV 8...\$379.95

Includes: C64 Interface, disk, cables, Manual  
Add \$5.00 S/H USA  
CA. address add 6.25%  
Ask for free catalog!

Here are a few of the Ultra's Features:

\*Operate duplex or Simplex\* Load, save, change all from T.tones, Packet, or modem\* Unlimited voice vocabulary \*Voice clock executes events Daily & Weekly \*"Super Macros" user programming language! \*300-4 digit user access codes \*Disk & Printer logging of all telephone numbers dialed, usage time, functions \*18 Rotating Polite ID's\* 16 External relay controls\* 2, 5, & CTCSS Tone Paging\* CW Practice with voice \*Security mode, T.tone mute\* Voice announced user call sign when logging on\* Voltage proportional courtesy beeps gives indication of signal strength \* 18 rotating Polite ID tails\* Safety timers & overrides \*"Ultra Link" provides T. tone control from remote audio monitored \*User defined multi-tone courtesy beeps each mode\* Modem or Packet control\* 9 T.Tone Macros store 28 digit command strings \*2 Talking Meter inputs \* Packet or Modem data\* Autopatch & Reverse Store 1000 (18 digit) tel. #'s \*Quick dial & quick answer \* Directed & general page\*50 tel #'s restricted patch \*Telephone control input\* Regenerated touchtones \*Autopatch auto off, detects calling party hangup\*Pulse or touchtone dial \*Call waiting & auto redial\* H.F. & VHF Remotes\* Dual H.F. & VHF SQ. det \*Scan up/down; 100Hz step + variable scan rate \*Monitor mode defeats PTT\*Lock mode allows T. tones to TX through remote \*Auto mode & split select \*9 Scan memories store Mode, splits, VFO A & B \*Talking Meters; Voltmeter \* Voice & CW Beacon \*Voice Rotor control\* User selectable courtesy beep

**AUDIO BLASTER™** Works in all H.T.'s

ABTS ←Miniature Audio Amp/ Used by police  
Module installs inside all H.T.'s; 1 watt audio amp! When it needs to be loud! Universal installation diagrams ABTS... \$ 24.95

**TSDQ QUAD** TSDQ 4 DIGIT Touchtone Decoder  
QUAD Relay Expansion plug-in option  
TSDQ use as Repeater On/Off, C64 reset, 8/20 VDC, audio in; Field Program 50,000 Codes; Mem. & Latching; Inc. DPDT Relay; LED digit valid & latch. 24 Pin connector. QUAD option adds: four 2 Amp. relays + 5 diode on & off code for each relay. 2"X3" Expandable TSDQ...\$ 89.95 Optional QUAD...\$ 99.95

Touchtone to RS232 300 Baud Interface "Decode-A-Pad"  
Use with all computers Decodes 16 touchtones Includes Basic program  
T.tones Input  
Use with any terminal program or write Your own, easy to use!  
IBM Mac C64  
DAP2 \$99.95

Ultra Com Shack 64 Options

\*Mount All modules including C64, Pre-drilled & painted incl mounts & cable clamps ALBX...\$ 159.95

\*Digital Voice Recorder 32 or 64 sec. voice Mailbox & ID tail. Inc. 1 Meg Ram, control with CS8 or PK8, Incl. cable for REV8 Ultra board, 5 or 12VDC DVM...\$ 179.95

\*Operate C64 & 1541 from 12Vdc with this crystal controlled Switching supply, runs cool & efficient draws <1 amp. Plugs into C64, fused, protected Model DCPS...\$ 129.95

\*Add duplex: Control of Remotes & patch with Telephone amplified hybrid, null & gain pots. Plugs into CS64S board, TLCN... \$159.95

Autoboot EPROM card plugs into C64 or PK8, disk or System version CART... \$ 109.95

8 relay On/Off; Inc. 3 -DPDT 2 A. relays +5 Sw. outputs. Use with HM1 to rotate beam...CS 8...\$ 99.95

2 Voice Meters + 2 Alarm Inputs + 8 Relay On/Off Sw. PK8...\$159.95  
\*PK1 adds Program & Control of Ultra via Packet or Tel line + Packet to Voice BBS, Req. 2nd C64 & PK8, Inc. 4 ft. data cable to PK8 PK1...\$99.95

\*Rotor control Analog to digital converter; use with CS8; voice bearing +/- 5 deg. for all rotors HM1...\$ 69.95

Ultra Com Shack 64 Manual all schematics, diagrams, how to operate & set up remote base. Refund with purchase of CS64S MN.\$25.00

\*Mastercard\*Visa\*Amex\*Disc  
**ENGINEERING CONSULTING**  
583 CANDLEWOOD ST.  
BREA, CA. 92621  
Tel: 714-671-2009 Fax: 714-255-9984

"HOW TO" FOR THE NEWCOMER TO AMATEUR RADIO

## Printed Material—Part I of IV

This article is intended to provide new amateurs with information about a few of the current sources of useful printed data. No attempt has been made to list all such sources. I have simply written a brief introduction to each item I have on hand. Obviously, each amateur radio publication contains data about many more sources of printed material. This article is just an introduction to such items. Excellent material is available to anyone who requests it.

Catalogs and other printed material of the major equipment manufacturers are not detailed in this article. Such items can be requested directly from AEA, Azden, ICOM, Kenwood, Ten-Tec, Yaesu, etc., using information printed in the major amateur radio magazines.

Prices may change by the time this article is printed and distributed. Prices are only shown to indicate approximate costs. If one resides in the same state as the seller of a desired item, a state sales tax probably exists, in addition to the stated price. If one is not a resident of the USA, additional cost is associated with all items.

**Amateur Electronic Supply Catalog.** Amateur Electronic Supply publishes an 80-page catalog which is particularly useful to newer amateurs. AES has outlets in Florida, Illinois, Nevada, Ohio, and Wisconsin. If you want one of their catalogs, you can request it by writing to AES at 5710 West Good Hope Road, Milwaukee, WI 53223. The toll-free telephone number at their Milwaukee outlet is 1-800-558-0411.

**Amateur Radio DX Blue Book.** An updated and improved version of Jim Creevey, W4UYZ's DX operation guide is available at \$6.95 prepaid, shipped to USA addresses. It contains 28 pages of information that is vitally important to new amateurs who want to contact DX (foreign) amateur radio stations. It includes a B-size (17 by 11 inches) foldout world grid map that is keyed to the associated DX data lists printed in the book. It is bound in a plastic comb binder, which allows you to leave it open without having to hold it open. It is shipped in a protective cardboard carton. It includes amateur ra-



*Nine-year-old Andy Robinson, KA3WDW, of Downingtown, Pennsylvania is a third-grade student who also enjoys playing baseball. Andy shares this radio shack with his father (George, WA3LVR).*

dio frequency allocations, callsign sequence list of DX data, central Pacific islands data, commonly used Q-signals, a country name-to-common callsign prefix conversion list, DX bearings, Fahrenheit/Celsius temperature conversions, miles/kilometers conversions, Pacific islands economic zones, Pacific islands grid map, QSL receiving and sending tips, and other data. The address is J/C Enterprises, 4920 Mayflower Street, Cocoa, FL 32927.

Jim offers a list of 330 beam headings, relative to your specific location, at \$2.50. Naturally, you must supply your exact geographic location.

**Amateur Television Quarterly Magazine.** If you are interested in amateur TV, or if you think you might get interested in this facet of our hobby, *ATVQ* is a good investment. The annual subscription rate is \$15 (domestic) and a sample issue cost \$4. The address is *ATVQ Magazine*, 1545 Lee Street, Suite 73, Des Plaines, IL 60018.

**The AM Press/Exchange.** Donald Chester, K4KYV, is the editor of this monthly newsletter, which is dedicated to advancing amplitude-modulation usage in our amateur radio service. The annual subscription rate is \$10 and the address is 2116 Old Dover Road, Woodlawn, TN 37191.

**Antenna and Tower Mount Catalog.** This catalog lists dual mounts, ginpole kits, ladder masts, mast adapters, pulleys, quadpods, rotator mounts, standoff brackets, and other related items. The address is IIX Equipment, Ltd., P.O. Box 9, Oak Lawn, IL 60454.

**Antennas West Data Packet.** Jim Stevens, KK7C, offers a bunch of specification sheets which cover the assortment of good (HF (3-30 MHz) antennas being sold by Antennas West. His indoor antennas are popular. His QRV (I am ready) Quick Launch system is excellent for use in erecting wire antennas. I use one and I recommend it highly. Jim's full-size HF antenna are excellent. An assortment of data sheets can be obtained at no charge by writing to Antennas West, Box 50062, Provo, UT 84605. Their toll-free order line is 800-926-7373 and the number to use to get technical support is 801-373-8425. Their FAX number is 801-375-4664.

**Antique Radio Classified.** This monthly magazine is written for people who buy, sell, recondition, collect, and display old radios. A six-month subscription costs \$11. A one-year subscription costs \$20, or \$30 for first-class mailing. Their address is P.O. Box 802, Carlisle, MA 01741. A free sample copy is available.

**ARRL Letter.** "The ARRL Letter" is published every two weeks to keep League members up to date on what is happening in amateur radio. A one-year subscription costs \$19.50, and subscription rates are restricted to ARRL members. The address to use is "The ARRL Letter," 225 Main Street, Newington, CT 06111.

**Apartment Operating.** Paul Gerhardt, KB3HH, offers a set of tips to help people who want to achieve good results while operating from restricted space locations such as apartments and townhouses. The address is 1255 Stonewood Court, Annapolis, MD 21401.

**ARRL Publications.** The American Radio Relay League has a superb assortment of printed materials. A free copy of their current list of publications can be requested by writing to ARRL, 225 Main Street, Newington, CT 06111. You do not have to be a League member to purchase ARRL publications.

**Auto-Call Magazine.** The Foundation for Amateur Radio is a federation of more than 50 clubs in the area of our nation's capital. I have found their publication to be an excellent source of up-to-the-minute amateur radio news. If you would like to receive a sample copy of *Auto-Call Magazine*, send your request (with an

\*45527 Third Street East, Lancaster, CA 93535-1802



SASE) to the Foundation for Amateur Radio, P.O. Box 7612, Falls Church, VA 22046-1452.

**Awards Directory.** There are several sources of information about available operating awards, including the monthly awards column that appears in this magazine. One of the best sources of such information is the "K1BV Directory of DX Awards." The 1990 edition of this directory features 1380 awards from 113 countries that have DXCC credit. Copies can be ordered from Ted Melinosky, K1BV, 525 Foster Street, South Windsor, CT 06074-2936. Each directory sells for \$16 (priority mail) to Canadian and USA addresses; \$15 DX surface mail; \$20 airmail to Central America, Europe, or South America; and \$23 airmail to all other DX addresses. Connecticut purchasers must also include the 8% sales tax. International Reply Coupons (IRCs) are accepted at 50 cents each.

The format is 8.5 by 11 inch 3-hole punched (looseleaf) for maximum flexibility. Awards available to shortwave listeners (SWLs) are identified. Lists of club/group members are included where they are known. The 210 pages of awards details are supplemented by hints that can help amateurs collect operating awards. A few of the subjects Ted covers are effective QSL techniques, QSL bureau usage, sample applications form, term definitions (GCR is General Certification Rule, etc.), and using contests to earn awards.

**BCD Electro Catalog.** Electronic parts and computer accessories are advertised in the 40-page catalog of BCD Electro. A one-year subscription to this catalog, plus supplements, costs \$1.00. The address is P.O. Box 45207, Garland, TX 75045. Their telephone number is 214-343-1770.

**Bird Power Measurement Instruments Catalog.** The current Bird catalog is 60 pages long. It describes Bird's extensive line of attenuators, calorimeters, coax filters, coax switches, directional couplers, load resistors, and RF wattmeters, plus many related accessories and products. It includes good descriptions of the manner in which many of these instruments function. If you have a sincere interest in RF power measurement, you should get a copy of the Bird catalog. I am one of the thousands of amateurs who have used Bird products successfully for several decades. Their address is Bird Electronic Corporation, 30303 Aurora Road, Cleveland, OH 44139.

**Buckmaster Publishing.** 1990 United States callsign directory data is available in three formats from Buckmaster Publishing, Route 3, Box 56, Mineral, VA 23117. These versions are (1) by call-sign, (2) by last name, and (3) by state/city. Each version sells separately for \$10, and all three cost \$25. Include a \$3 shipping fee with each order.

**Burghardt.** Burghardt Amateur Center sells and trades new and reconditioned amateur radio equipment. They service what they sell. Their telephone number is 605-886-7314. You can request a copy of their latest used-equipment list. Their address is 182 North Maple, P.O. Box 73, Watertown, SD 57201.

**Canadian International DX Club.** The May through October 1982 issues of CQ contain my introduction to shortwave listening. A class handout reprint of the same article is available at no cost to anyone who requests one and sends a large (9 by 12 inches, minimum) self-addressed envelope with triple first-class postage (65 cents) attached.

Rob Gerardi is the Ham DX Editor of the "Messenger," which is a good newsletter that is published by the Canadian International DX Club. Each issue of the "Messenger" is about 50 pages long. In addition to detailed listings of listening opportunities, it includes information about radio stamps, computers, and technical topics. Arctic DX is covered very completely. A sample copy of the "Messenger" costs \$2 airmailed to the U.S.A. or Canada, and \$3 airmailed elsewhere. International Reply Coupons may be used to make payments, at the rate of 50 cents each. The address of the Canadian International DX Club is #61-52152 Range Road 210, Sherwood Park, Alberta, Canada T8G 1A5. Remember that mail to Canada now costs a little more than domestic postage.

The November and December 1988 issues of CQ contain my article about amateur radio stamps. A free copy of that article is available to anyone who requests it and furnishes the usual SASE (#10 business envelope).

The February 1986 issue of CQ contains my article about International Reply Coupons, which amateurs often use to prepay postage of DX cards they want to receive. As usual, a free copy of that article is available to anyone who requests it and furnishes an SASE (#10).

**Catalog of Catalogs.** "The World's Best Catalogs" is 30 pages long and it describes the contents of 202 catalogs advertising an extremely wide range of products. A few of these catalogs cover electronic devices, tools, and specialty items which could be of interest to amateurs. The cover price is \$6, but I received one at no charge. The address to use to request this catalog is "The World's Best Catalogs," 144 South First Street, P.O. Box 4035, Burbank, CA 91503.

**Clandestine Confidential Newsletter.** This is a list of secret transmissions data. A six-issue subscription costs \$10 (U.S.A.) or \$13 (DX). The address is RR-4, Box 110, Lake Geneva, WI 53147.

**CQ Buyer's Guides.** The CQ Amateur Radio 1990 Equipment Buyer's Guide is available at \$4.95 each prepaid. The



DAN KB0—KIRBY KA0ZTS—LOUIS KA0IPN  
RON N0KMR—DENISE YL—MALINE XYL—MIKE S00N

1-800-426-2891

**YAESU**



FT-767 GX Gen. Cvr	Call \$
FT-757 GX II Gen. C	Call \$
FT-7000 15m-160m	Call \$
FT-212RH NEW 2m 45w	Call \$
FT-712RH 70cm 35w	Call \$
FT-290R All Mode P	Call \$
FT-23 R/TT Mini P	Call \$
FT-736R, All Mo	Call \$
FT-470 2m/70c	Call \$
FT-747 Gen'l C	Call \$
FRG 8800 HF R	Call \$
FRG 9600 UHF R	Call \$
FT 690 R/H	Call \$
FT 790 R/H	Call \$
FT 4700 Dual B	99.00
FT 411 2 Meter	406.00
FT 811 440 HT	410.00

Yaesu FT-747  
Holiday  
Special

**ICOM**



IC-781 New	LIST	6149.00	Call \$
IC-765 G		3149.95	Call \$
IC-735 C		1149.00	Call \$
IC-751A		999.00	Call \$
IC-R7		100.00	Call \$
IC-F7		100.00	Call \$
IC-2SAT FM		100.00	Call \$
IC-28A/H FM		100.00	Call \$
IC-2GAT 2m 7		100.00	Call \$
IC-900 Six Bal		100.00	Call \$
IC-3S AT 220 M		100.00	Call \$
IC-2S AT 2M		100.00	Call \$
IC-4S AT		100.00	Call \$
IC-48A FM Mobile 2		100.00	Call \$
IC-4GAT New 6w HT		99.95	Call \$
IC-38A 25w FM Xcvr		489.00	Call \$
IC-22AT 2m/70cm HT		629.95	Call \$

ICOM IC-2SAT  
W/BP-82  
Special

NOW

**Cushcraft**  
CORPORATION

Alinco	Larsen
Astron	Hustler
Butternut	Lakeview
ARRL	AEA
Kantronics	MFJ
Sony	Cushcraft
Bencher	Vibroplex

Plus more . . . Thanks for your support.

NOW  
CANADA

1-800-426-2891  
METRO: (612) 786-4475  
2663 County Rd. I  
Mounds View, MN 55112

Super Minnesota Watts 1-800-279-1503

CIRCLE 121 ON READER SERVICE CARD

November 1990 • CQ • 105

price is the same for the *CQ Amateur Radio 1990 Antenna Buyer's Guide*. Each sells at \$6 prepaid to DX/foreign addresses. The address is CQ Communications, Inc., 76 North Broadway, Hicksville, NY 11801 (FAX 516-681-2926).

The CQ Book Shop, included in each issue of *CQ*, includes several useful publications about amateur radio.

**CRB Research Books.** CRB offers a 26-page catalog describing a variety of publications about stations and frequencies other than those of our amateur radio service. The cover price is \$1 and the address is P.O. Box 56, Commack, NY 11725. This information is not limited to the 3-30 MHz range, and it includes several "confidential" lists.

**Crystals.** International Crystal Manufacturing Company, Inc. offers a comprehensive assortment of crystals and holders. Their address is P.O. Box 26330, Oklahoma City, OK 73126-0330. They met all my requirements during the past 40 years.

**Disaster Preparedness Brochure.** The Federal Emergency Management Agency (FEMA) is offering a free 18-page guide to proper emergency prepared-

ness. Its title is "Millions of Americans Have Experienced Disaster—Are You Prepared?" You can send your request for a copy to FEMA, P.O. Box 70274, Washington, DC 20024.

**Doyle Communications.** Doyle Communications offers a free catalog that shows their wide range of amateur radio books, many of which they sell at discount prices. Their address is Route 8, Box 18, Lake Pleasant, NY 12108 (telephone 518-548-5515).

**The DX Bulletin and The DX Magazine.** "The DX Bulletin" is issued every week to keep amateurs informed about current DX news. A free sample issue can be requested from "The DX Bulletin," Box 50, Fulton, CA 95439. Send an SASE with your request. The annual subscription costs to domestic (USA) addresses are \$29 for second-class mailing and \$38 for first-class mailing. Foreign airmail subscription cost is \$50 (U.S.A.) annually.

*The DX Magazine* is issued every week to provide in-depth coverage of DX material. The annual subscription rate is \$15. The address is the same for both publications. The telephone number is

707-523-1001.

**DX Around The World.** The ninth edition of Dieter Konrad, OE2DYL's *DX Nets Around the World* is available. The price is \$3, or 9 International Reply Coupons. IRCs can be purchased at post offices. Do not use checks. Include a business size (#10) self-addressed envelope with your request. The mailing address is Dieter Konrad, Rosengasse 1, 5020 Salzburg, Austria.

**DX Operator's World Atlas.** If your atlas is as large as mine, this item should be of interest to you. Walt Stinson, W0CP, sells a world atlas which is small enough to be used as an aid at an operating position. It is 185 hardbound 5 by 7 inch pages printed in color on high-quality paper. Cultural profiles of 173 countries are included. Map details exceed those of most atlases. A callsign allocation table and a world time zone map further increase the usefulness of this DX operating aid. The worldwide postpaid price is \$17.95, and the foreign airmail ppd price is \$25 each. The address is 4150 East Quincy Avenue, Englewood, CO 80110.

A 60-page index makes it easy to quickly locate places on the Atlas maps. Each location's grid coordinates are stated, plus the number of the page on which the required map is printed.

## Summary

This completes the first segment of this four-part article. The subsequent segments will provide additional useful information.

## Printed Aids

My previous columns contain information that is useful to new and aspiring amateurs. Many of these items have been reprinted for distribution to students of licensing courses I instruct. For ease of use, these printed aids have been separated into six categories. These categories are introduction, code, theory, station, operating, and miscellaneous. Outdated items are continually replaced with newer material. Fifteen dollars brings a complete set of current printed aids, including shipping costs. A list of these printed aids will be sent to anyone who requests it and sends a business-size (#10) SASE to my California address. Any single item is available at no charge to anyone who supplies a self-addressed and stamped envelope. When a single item is being requested, it is advisable to supply a large (at least 9 by 12 inch) envelope and to include a couple of extra stamps (loose in your envelope) in case extra postage is required. Some items are long. Licensing-course instructors are welcome to revise and/or duplicate these items to suit their requirements.

## "NEW" DUAL & TRI BAND SUPER "LINEAR" ANTENNAS

MODEL	FREQUENCY	GAIN	POWER	LENGTH	USE
CA-2X4Z	146 MHz 446 MHz	8.2dB 11.5dB	200W	15' 4"	BASE/REPEATER
CA-2X4FX	146 MHz 446 MHz	4.5dB 7.2dB	200W	5' 11"	BASE/REPEATER
CA-2X4M	140-155 MHz 440-460 MHz	4.5dB 7.0dB	150W	5'	MOBILE
CA-2X4SR	146 MHz 446 MHz	3.8dB 6.2dB	150W	3' 4"	MOBILE
CX-901	146 MHz 446 MHz 1.2 GHz	3.0dB 6.0dB 8.4dB	150W	3' 6"	BASE/REPEATER
CX-801	146 MHz 446 MHz 1.2 GHz	3.0dB 6.8dB 9.6dB	100W	3' 3"	MOBILE
CA-630TN	146 MHz 446 MHz 1.2 GHz	2.15dB 2.15dB 5.5dB	150W 50W	1' 5"	MOBILE

## NEW! ULTRA COMPACT SWR/POWER METERS



CM-200 144-150 MHz  
CM-300 200-250 MHz  
CM-400 420-460 MHz  
CM-420 140-460 MHz  
CM-900 850-950 MHz  
CM-1200 1250-1350 MHz

DEALERS INQUIRIES WELCOME

CALL YOUR DEALER



1275 N. Grove St  
Anaheim, CA 92806  
(714) 630-4541  
FAX (714) 630-7024

CIRCLE 91 ON READER SERVICE CARD

**COMET**  
ANTENNAS FOR THE PROFESSIONAL AMATEUR

# BATTERIES "R" US...

You've bought our replacement batteries before...  
NOW YOU CAN BUY DIRECT FROM US, THE MANUFACTURER!

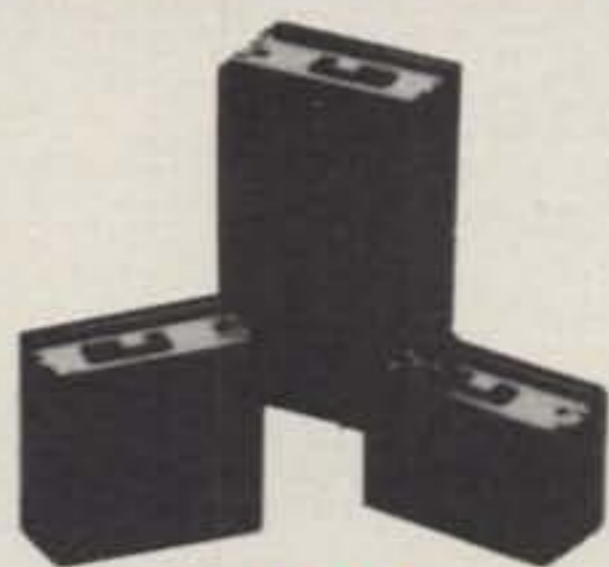

### ICOM

CM2, BP2 7.2v @ 500 MAH  
CM5, BP5 10.8v @ 500 MAH

### SUPER

7S 13.2v @ 1200 MAH—\$63.95  
8S 9.6v @ 1200 MAH—\$59.95

(base charge only 1" longer)  
ICOM Chargers Available!

### NEW ICOM CONVERTIBLE BATTERY



8 Cells—Alkaline  
or NICAD Holder  
Complete with (8)  
Alkaline Batteries

**\$26.00**

### BP-7

13.2v @ 500 MAH

**\$61.95**

13.2v @ 600 MAH

**\$64.95**

### BP-8

8.4v @ 800 MAH

**\$61.95**

8.4v @ 1000 MAH

**\$64.95**



**10% OFF  
ALL  
Kenwood  
Replacement  
Battery Packs  
Call Now!  
NOVEMBER ONLY**



### CUSTOM MADE BATTERY PACKS & INSERTS

Made to your specifications  
Introductory Offer!

### KENWOOD INSERTS

PB-25—\$20.00; PB-21—\$13.75

PB-26—\$20.00

### ICOM INSERTS

BP-5—\$23.00; BP3—\$17.45

BP-7; BP-8



MasterCard and Visa  
cards accepted. NYS  
residents add 8 1/4 %  
sales tax. Add \$3.50  
for postage and  
handling.



FOR ALL YOUR COMMUNICATION  
BATTERY REPLACEMENT NEEDS.

## W & W ASSOCIATES

29-11 Parsons Boulevard, Flushing, N.Y. 11354

WORLD WIDE DISTRIBUTORSHIPS AVAILABLE. PLEASE INQUIRE.

**MADE IN  
THE U.S.A.  
SEND FOR  
FREE CATALOG  
AND PRICE LIST**

Prices subject to change without notice.

In U.S. & Canada Call Toll Free (800) 221-0732 • IN NYS (718) 961-2103 • Telex: 51060 16795 • FAX: (718) 461-1978

CIRCLE 155 ON READER SERVICE CARD

## THE SMILEY ANTENNA CO.

THE HAND TUNED PERFORMANCE SYSTEM

FEATURING PORTABLE RADIO SIMULATION TUNING



"Quality through Technology"

### Electrical

Maximum Power..... 50 Watts.  
Frequency Range..... 118-932 MHz.  
Impedance..... Matched to the Portable  
Specialized Tuning  
Available.

### Mechanical

Coating Material..... A Dipped in Synthetic  
Rubber to Seal and Webb  
Coll, Preventing  
Distortion.  
B 1. PVC Covering  
2. Mil-Spec MPQ-2000, A  
Solvent and Acid  
Resistant Covering.

Radiating Element..... A Helical Wound Hardened  
Steel Wire, Copper Plated-  
for Lower Resistance and  
Higher Velocity.  
B .125 dia High Carbon  
Steel, Bias Wound  
Flexible Shaft Core-  
Plated.

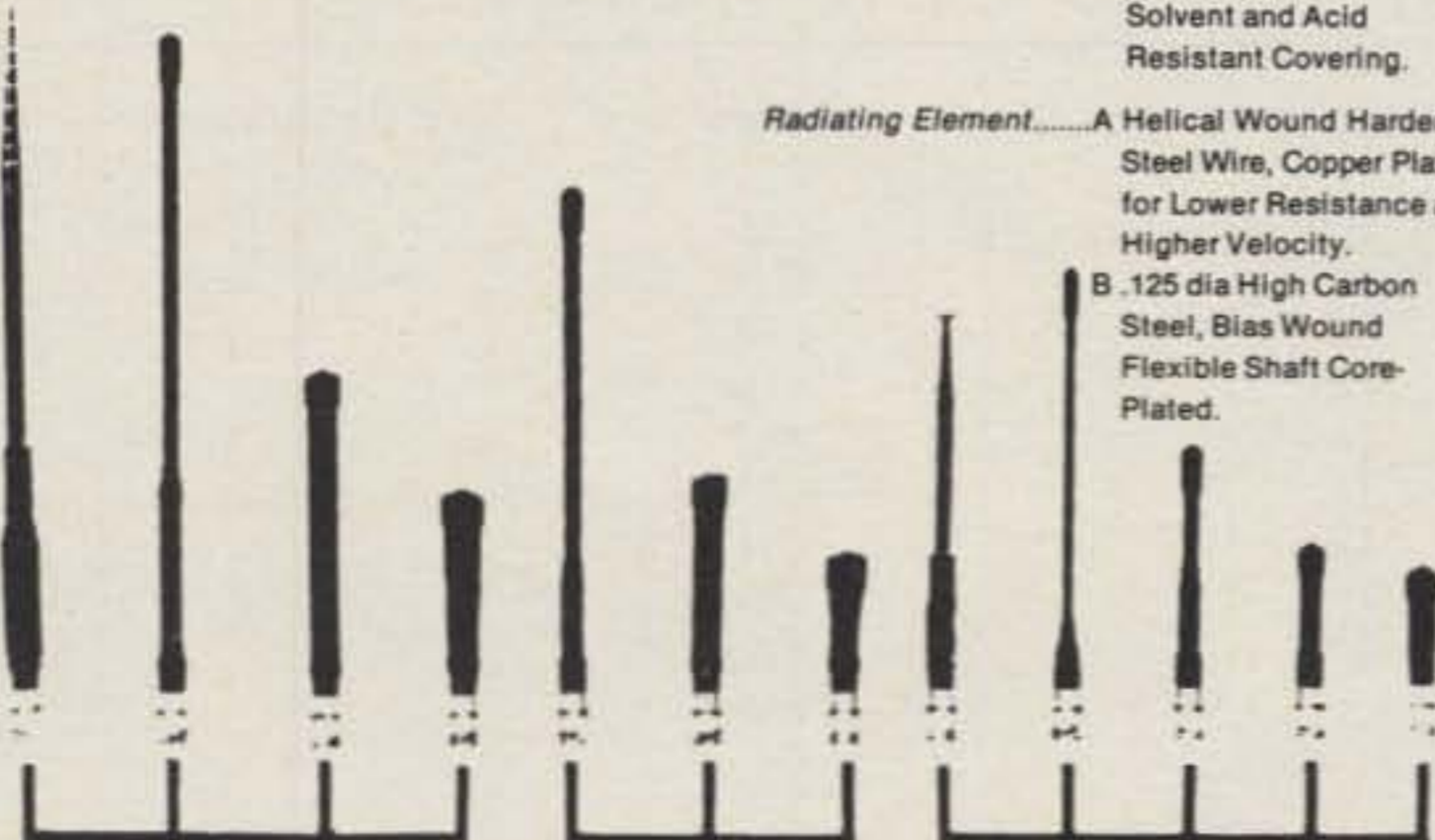

Available from  
136-174 MHZ

Available from  
210-250 MHZ

Available from  
440-470 MHZ

FOR DEALER  
LOCATION

**CALL 619-579-8916**

SMILEY ANTENNA CO., INC.

408 LA CRESTA HEIGHTS ROAD, EL CAJON, CA 92021

CIRCLE 80 ON READER SERVICE CARD

Say You Saw It In CQ

## MADISON ★ ★ ★ SHOPPER

CALL FOR ORDERS: 1 (800) 231-3057

1 (713) 729-7300 or 729-8800

FAX 1 (713) 358-0051



**ALL ITEMS ARE  
GUARANTEED OR  
SALE PRICE  
REFUNDED.**

New Kenwood TM-941A Tri-Band FM..... Trades Wanted  
Kenwood 731A Dual Band Mobile..... Call  
ICOM IC-24AT..... Call  
Penta 6146B..... \$12.00  
Penta 3-500Z..... 99.00  
831SP-PL259 Silver Plate (Amphenol)..... 1.50  
ALLGON 2M, 5/8 Mag. Mount, Complete..... 25.00  
Receiving Tubes..... \$1.00-5.00  
UG-201 A/U Adapter N Male/BNC Female..... 4.00  
3 Amp RF Meter 2.5" New Boxed  
Other Sizes Available..... Each 30.00  
.0015  $\mu$ F 10 KV Axial..... 1.95  
Ameco Books, Hi-Pass Filters..... Call  
1000's Of Meters, Transformers, etc..... Call  
Copper Clad Epoxy Boards, 17" x 12"..... 4.00

### POLICIES

Minimum order \$10.00. Mastercard, VISA, or C.O.D. All prices FOB  
Houston, except as noted. Prices subject to change without notice.  
Items subject to prior sale. Call anytime to check the status of your  
order. Texas residents add sales tax. All items full factory warranty plus  
Madison warranty.

Bird and Belden products in stock. Call today.



## MADISON



12310 ZAVALLA STREET • HOUSTON, TEXAS 77085

CIRCLE 159 ON READER SERVICE CARD

## NEWS/VIEWS OF ON-THE-AIR COMPETITION

### Are Contesters Real Hams—The Final Results

One of my biggest fears when conducting a survey is the chance that no one will respond. In light of the topic this month, I've added another question to my thinking that asks, "Do contesters answer surveys?" Fortunately, the answer is a resounding YES! Obviously, the theme of this survey is based on several subjective assumptions. After all, what exactly is a real ham? For that matter, what does one have to do to qualify as a "true tester"? As Randy Thompson, K5ZD, concluded in his response, "am I a real ham or really a tester?"

There is no lack of opinions among active amateurs about contest operators. To some non-testers, we contribute more than our share of bad influence in amateur radio. For example, many feel we are nothing more than a group of ego-centric operators who obliterate the amateur bands weekend after weekend. We are a crowd that only takes from the hobby and rarely gives anything back. Subscribers to this line of thinking feel that if weren't for contests, the majority of these operators probably wouldn't even be in the hobby!

The goal of the survey was to straightforwardly measure the level of commitment contest operators have to non-contest amateur activities. Are testers involved in many of the projects that have so dramatically improved the public's impression of our hobby? Do we contribute toward technical advancement and facilitating our peers' growth in the hobby? Maybe we're just QSO machines that sit on the edge of 20 meters shouting numbers and symbols at each other. If you are a tester (or even a casual operator), I think you'll be as pleased as I was to learn the survey's results. If you are a cynical non-tester, you just may be a little surprised.

Before I begin the analysis, let me give you some background about the responses. The intent of the survey was to identify areas where testers are most often criticized (e.g., QSL policies, contributions to the hobby, etc.). Second, I attempted to identify testing participation in the more general-purpose aspects of the hobby (e.g., being an Elmer to a new amateur, awards, etc.). In total I re-

#### Calendar of Events

Oct. 20-21	Worked All Germany Contest
Oct. 27-28	<b>CQ WW SSB DX Contest</b>
Oct. 31 - Nov. 1	YLRL SSB Anniversary Party
Nov. 3-4	Int'l Police Assn. Contest
Nov. 3-5	ARRL CW Sweepstakes
Nov. 9-11	Japan Int'l SSB DX Contest
Nov. 10	ALARA YL/OM Contest
Nov. 10-11	OK-DX Contest
Nov. 10-11	WAEDC RTTY DX Contest
Nov. 10-11	North Carolina QSO Party
Nov. 17-19	ARRL SSB Sweepstakes
Nov. 24-25	<b>CQ WW CW DX Contest</b>
Nov. 30 - Dec. 2	ARRL 160M Contest
Dec. 1-2	Telephone Pioneers QSO Pty
Dec. 8-9	ARRL 10M Contest
Dec. 9	ARCI QRP CW Sprint
Jan. 25-27	<b>CQ WW 160M CW Contest</b>
Feb. 16-17	ARRL DX CW Contest
Feb. 22-24	<b>CQ WW 160M SSB Contest</b>
Mar. 2-3	ARRL DX SSB Contest

ceived 228 replies. From this pool, 195 were from the U.S. and the remaining 33 came from 16 DXCC countries. The testing experience levels varied from 6 months to 53 years (W3BY claims this prize!) with an average of 16.9 years. As you might expect, the responses also varied from W5FO's 11-page handwritten masterpiece (including play-by-play action from Wimbledon) to several giving the appearance of being completed while commuting to work on the New Jersey Turnpike with a coffee in one hand and

the 2 meter rig in the other. In each case, I appreciate your participation and the supplementary comments you included.

#### Survey Results

**Question 1.** Do you regularly answer your bureau/direct QSL cards?

YES—206 (90.7%)  
NO—21 (9.3%)

This is a real sore point for many amateurs working contest stations. The perception is that "those testers NEVER QSL!" Based on this survey, it seems that this perception is a myth. While testers perhaps process QSLs slower than some would like, the fact remains that the vast majority of us eventually get to the task. Many respondents commented that computers are substantially helping with QSL chores. I know that my call sign receives 5 to 8K QSL requests per year, and I can't even begin to imagine the requests for the large multi-multi stations. Nevertheless, 9% is still a high number and reflects the need for some concern in fulfilling what some consider to be the final obligation to a QSO.

**Question 2.** How many unsolicited outgoing QSLs have you sent in the past 12 months?

a) zero—22 (10.0%)

Area	# of Responses	Area	# of Responses
W1	21	DL	2
W2	26	DU	1
W3	21	G	6
W4	29	HB9	1
W5	22	KH6	3
W6	21	KL7	6
W7	13	LA	1
W8	12	OH	1
W9	19	OE	1
W0	11	PY	1
		SM	1
		SV	1
		TI	1
		VE	5
		ZS	1
		9M2	1

Table 1—Geographical breakdown for survey responses.

2 Baldwin Street, Windham, NH 03087

- b) 1-5—22 (10.0%)
- c) 5-25—21 (9.7%)
- d) greater than 25—154 (70.3%)

This question was intended to measure a good old-fashioned aspect of our hobby—exchanging QSLs. Given the sometimes overwhelming burden of answering incoming cards, I was surprised to discover that 70% of us also send a substantial number on an unsolicited basis.

**Question 3.** Do you actively track your DXCC country totals?

- YES—185 (81.1%)
- NO—43 (18.9%)

I certainly wasn't shocked by this response. Anyone who devotes the time to working as many stations as the active contester probably will dedicate some time to keeping track of basic information such as DXCC totals.

**Question 4.** Are you currently involved in a local radio club (non-contest)?

- YES—163 (71.8%)
- NO—64 (28.2%)

This question really hits home on the subject of a contester's involvement in non-contesting circles. The question's purpose was to specifically identify our interest in supporting local amateur organizations beyond the traditional contest club (e.g., YCCC, FRC, NCCC, etc.). Many respondents indicated they are active club officers responsible for a myriad of public-service activities and other contributions.

**Question 5.** Have you administered an amateur radio exam in the last 12 months?

- YES—84 (37.2%)
- NO—142 (62.8%)

The numbers associated with this question are somewhat skewed by the fact that many countries have not established self-administration for amateur licensing. In any case, only one third of the responses indicated their active involvement in the upgrading/introduction of amateurs through the established US Volunteer Examiner process. In my opinion, this is an area where experienced amateurs such as contesters can offer more support and expertise.

**Question 6.** How many QSOs with a non-contester have you made in the past 12 months that were longer than 10 minutes in duration?

- a) zero—8 (3.6%)
- b) 1-5—29 (12.9%)
- c) 5-25—60 (26.8%)
- d) greater than 25—127 (56.7%)

For years contesters have been accused

of participating in a clique that is only penetrated when your contest scores achieve a certain level. The clique has been described in terms of our attitudes on and off the air. I'm sure you have already pictured that "typical" amateur QSO in your mind. It begins by firing up your rig on 20 meters SSB and calling CQ with the beam pointing west (from an East Coast perspective). WD1XXX calls you and you think to yourself, "Do I really want to talk to this guy about his rig and weather?" Fortunately for amateur radio, there is much more to a QSO than that, and I was pleased to see others feel the same way as over one half of us conduct

QSOs with amateurs outside of our contesting circle. Some of the respondents indicating choice (a) mentioned that they do not single out non-contesters as much as they don't work anyone in between contests (e.g., no available station).

**Question 7.** Do you operate special modes from your station (e.g., RTTY, SSTV, AMTOR)?

- YES—99 (44.2%)
- NO—125 (55.8%)

While special modes of operation don't necessarily qualify you to be a "real ham," they are one small measure of

# RENO RADIO



1-800-345-5686



AEA — ALINCO — AMERITRON — ASTRON — B & W — BENCHER — BUTTERNUT



**IC-765**  
HF All Band Transceiver  
Call Now!



**IC-725**  
Compact Easy To Operate HF  
Call Now!



**IC-2400**  
Dual Band FM Transceiver  
Call Now!



**MFJ-1278T Turbo**  
Multi-Mode Data Controller With New 2400 Baud Packet  
Call For Details!  
Order Your Antenna Tuner, Switches, Keyers, And All Your MFJ Accessories

**YAESU**



**FT-757 GX Mark II**  
Portability And Performance  
100 Watt HF  
Call Now!



**FT-4700RH**  
Dual-Band Mobile  
With Remote Control Head  
Call Now!

**TEN-TEC**



**Paragon**  
Superior USA Made  
HF Winner  
Call Now!

**DIAMOND ANTENNA**

**Dual Band Base/ Repeater Antennas**  
X-500A 2 Meter/70 cm  
200 Watts, 205 in. Length  
X-200A 2 Meter/70 cm  
200 Watts, 88 in. Length  
Call Today For Details  
On Antennas, Duplexers  
And Power Meters

**YAESU**



**FT-1000**  
World Class HF  
Performance Rig  
Call Now!



**FT-747**  
Economical HF Fun  
Call Now!



**SALE! FT-212RH**  
2 Meter, 45 Watt Mobile  
Call Now!



**SALE! FT-470**  
2M/70 cm FM  
Handheld  
• Up To 5 Watts Output  
• Simultaneous Receive On Both Bands  
• 42 Memories  
• Built-in CTCSS  
Call Today!

CUSHCRAFT — DIAMOND — HUSTLER — ICOM — KENWOOD — LARSEN — MFJ — YAESU

12 Glen Carran Circle • Sparks, NV 89431  
(702) 331-7373

Why Lose Money In Vegas, Try Reno!

your interest in some of our hobby's leading technologies and advancements. At the risk of being accused of soliciting QSOs in the next RTTY contest, even my station has made the plunge into RTTY and AMTOR!

**Question 8.** Have you ever been an "Elmer" for another amateur?

YES—180 (80.7%)  
NO—43 (19.3%)

The response to this question should be extremely encouraging to any contester. I personally had the luxury of being taught by two "Elmers" in my formative amateur years who provided infectious enthusiasm and advice that remains with me to this day. And for the contesters answering this survey, 80% have given that gift to many others in the hobby. One respondent indicated that he had personally "Elmered" over 25 new amateurs over the years and has remained a close friend with many of them to this day.

**Question 9.** How many hamfests did you attend in the past 12 months?

a) zero—39 (17.0%)  
b) 1—46 (20.0%)  
c) 2—59 (25.7%)  
d) 3 or greater—86 (37.3%)

The responses to this question were partially influenced by the fact that not every-

one has easy access to regularly held hamfest events. The boys in KL7 and KH6 were quick to point that one out! Nevertheless, contesters seem to like to participate in hamfest activities with the majority attending three or more in the past 12 months. My interpretation of this is that the contester is basically a social animal who uses hamfest gatherings to meet his peers and search out bargains for his construction projects (see Question 12).

**Question 10.** Have you participated in a public-service activity (e.g., 2 meter communications in parades, road races, concerts) in the past 12 months?

YES—91 (42.3%)  
NO—124 (57.7%)

I was pleased to see the large number of positive answers to this question. In addition to the examples I raised in the query, many pointed out their involvement in disaster communications, emergency communication drills, Boy Scout events, etc. Although the majority of responses indicated no participation in public-service events, I'd be willing to bet that the numbers reflect a higher percentage of "contester" participation when compared against the overall amateur population. In other words, would four out of ten hands show active public-service participation at your local ham club meeting? If you have some hard data on this subject, please send it along.

**Question 11.** Circle the following awards you have obtained:

a) 5BDXCC—58 (25.2%)  
b) 5BWAZ—19 (8.3%)  
c) 5BWAS—28 (12.2%)  
d) DXCC Honor Roll—42 (18.3%)  
e) Worked All Counties—13 (5.7%)

Not surprisingly, contesters have achieved many prestigious awards. While working DXCC is a significant accomplishment for many, contest operators have the advantage of working large numbers of stations over short periods of time, resulting in impressive award tallies. I must say I was as surprised as you probably are to see the noticeable number of stations claiming Worked All Counties.

**Question 12.** Have you "homebrewed" a piece of amateur equipment in the past 12 months?

YES—125 (55.6%)  
NO—100 (44.4%)

There was one response that stood out accusing contesters of being appliance operators who lack the technical expertise of the general amateur population. While it's fair to admit that contesters rarely build their own transceivers in today's modern age of technology, over half of the respondents have made a serious attempt to improve their stations while operating at the workbench.

**Question 13.** Have you ever held an



Rob, WA3QLS



Gail, KA3ITN

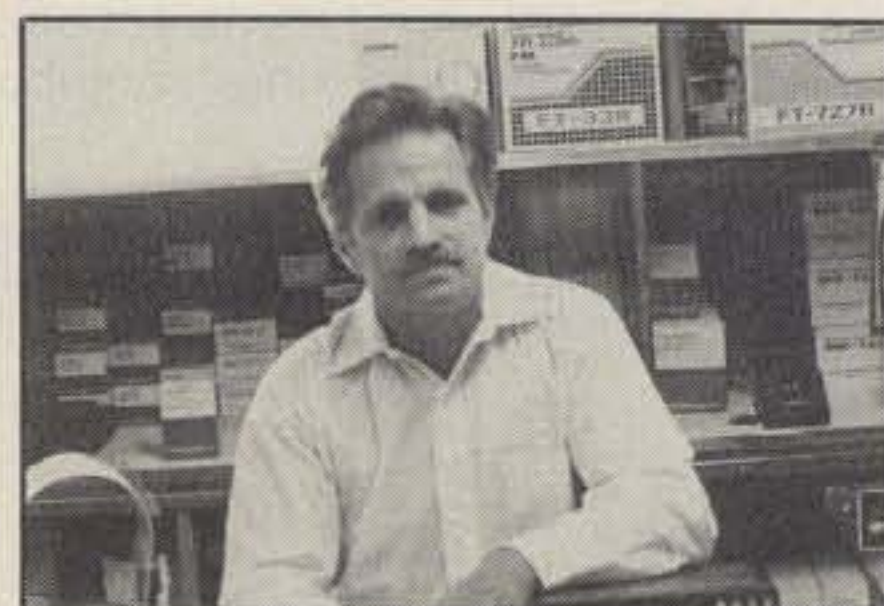

Paul, WA3QPX

## YAESU

### HF

FT-1000D  
FT-1000  
FT-767GX  
FT-757GXII  
FT-747GX



### Base Stations

FT-650 6m, 10m, 12m  
FT-736R V/UHF



### Mobiles

FT-212RH, 2m  
FT-712RH, 70cm  
FT-912RH, 1.2 GHz  
FT-4700RHT, 2m/70cm



### Receiver

FRG-8800

### HF Amplifier

FL-7000

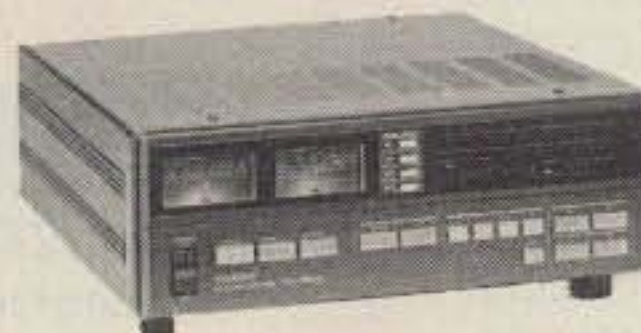

### Hand Helds

FT-23R, 2m  
FT-33R, 220 MHz  
FT-73R, 70cm  
FT-411, 2m  
FT-811, 70cm  
FT-911, 1.2 GHz  
FT-470 2m/70cm



Celebrating  
Our 15th Year

# Delaware Amateur Supply

71 Meadow Road, New Castle, Del. 19720

9-5 Monday-Friday, 9-3 Saturday

**800-441-7008**

New Equipment Order and Pricing

302-328-7728

Service, Used Gear Information

No Sales Tax in Delaware! One mile off I-95

Nov. 3 and 4  
MANUFACTURERS  
OPEN HOUSE

amateur service position (e.g., Section Manager, VEC, OO, etc.)?

YES—115 (51.1%)

NO—110 (48.9%)

This question was attempting to measure the average contester's contribution to the hobby from another broad-based perspective. Positions such as Section Manager, Volunteer Examiner, Official Observer, and other amateur service opportunities offer an extraordinary opportunity to transfer the tremendous knowledge contesters have gained about amateur radio. They can also require significant time demands that truly separate the committed amateur from a casual visitor. Based on the survey's response, over 50% of the respondents have made that commitment in one form or another during their amateur career.

### Final Comments

Depending on your perspective, contest operators have had the adulation and disdain of our fellow amateurs over the years. Based on the results of this survey, I'm proud to say that the contesting community as a whole offers much more to our hobby than is perceived by those complaining about the QRM on 15 meter CW during late November. Our contributions to youth recruitment, technical advancement, improved operating standards, and public service have been substantial and should be viewed with pride.

Next month's column should prove to be exciting as I reminisce (based on the input from over 25 contesters) on some of contesting's Great Moments in Sport. I've gathered some impressive statistics as well as a few good old-fashioned war stories that may remind you of one or two personal experiences.

The "contester's roster" I have proposed is coming along but still needs your help. In order to provide the best coverage, I would like to include club rosters along with the individual input you submit-

ted on the survey. Please submit your contest club's roster to me (on a 5 1/4 inch MS-DOS formatted disk if possible) as soon as possible.

Finally, the ARRL is announcing a new incentive program for the Sweepstakes Contest. Any entry exceeding 100 QSOs will be eligible to receive a commemorative SS Pin that is specially engraved with the year and mode of operation. To receive your pin, include \$2.00 with your entry. As always, the deadline for the February issue is December 1, 1990.

73, John, K1AR

### ARRL Sweepstakes

CW: Nov. 3-5 Phone: Nov. 17-19  
Starts: 2100Z Sat. Ends: 0300Z Mon.

This is the 57th running of the Sweepstakes, making it the oldest domestic competition going, and it really stirs up a lot of activity.

Operation is limited to stations in ARRL sections. Operating periods are restricted to a maximum of 24 out of the 30 hour contest period. Times off may not be less than 30 minutes and must be clearly indicated in your log.

In order to minimize QRM to non-contesters it is recommended that operation be confined to certain portions of the bands. It is recommended that you check QST for details.

There are several other regulations, including a cross-check sheet if you make 200 or more contacts. A large SASE (45¢ in postage) will get you the "SS Package" and Operating Aid #6 with enough log and summary sheets for an average outing.

**Exchange:** QSO no., power class, call, last two digits of year first licensed, and your ARRL section.

Stations using 150 watts or less are classed "A," over 150 watts "B," and QRP "Q." The same station may be worked only once regardless of the band.

**Scoring:** Each completed QSO is worth 2 points. The multiplier is derived from the number of ARRL sections.

**Awards:** The usual certificates in each

class and mode for single operator stations in each section and multi-operator stations in each division.

Logs must be received no later than December 31st and go to: ARRL Communications Dept., 225 Main Street, Newington, CT 06111.

### Japan International DX Contest

2300Z Fri. to 2300Z Sun., Nov. 9-11

This is the third year for the Japan International DX Contest organized by the Japanese *Five Nine Magazine*. It's the JAs working the world on SSB only, all five bands, 10-80 meters (no WARC bands).

**Classes:** Single operator, single and all band, multi-operator all band only. Single operators are limited to 30 hours out of the 48-hour contest period. Off periods of at least 60 minutes must be clearly indicated in the log. Multi-operators can operate the full 48 hours. Stations must remain on the same band for at least 10 minutes before changing bands.

**Exchange:** RS plus a Prefecture number (1-50) for JAs, RS plus a progressive 3-digit QSO number for non-JAs.

**Points:** Two points for 80 meter QSOs, 1 point for 40-15 meters, 2 points for 10 meters.

**Multiplier:** Total number of JA Prefectures, plus #48 JD1 Ogasawara Is., #49

### Quotable Contest Survey Quotes

- "I currently don't QSL, but plan to soon . . . REALLY!"
- "I've coordinated five VE sessions and only been licensed two years."
- "Contesters are the cream . . . they rise to the top."
- "What IS the definition of a real ham?"
- "If it weren't for guys like me working the big guns, there would be no contests."
- "I contest for the fun of it."
- "During contests I hold up until 11 PM, then I hit the sack."
- "I've only been licensed for six months, but I love contesting."
- "I have none of the awards listed above, but did get my RCC (Rag Chewer's Club) in 1939!"
- "I have over 100 contest certificates and cherish them all."
- "Recently I started physical conditioning to endure contest operating longer."
- "I have never used a linear in 32 years of contesting."
- "Contesters tend to push the state-of-the-art."

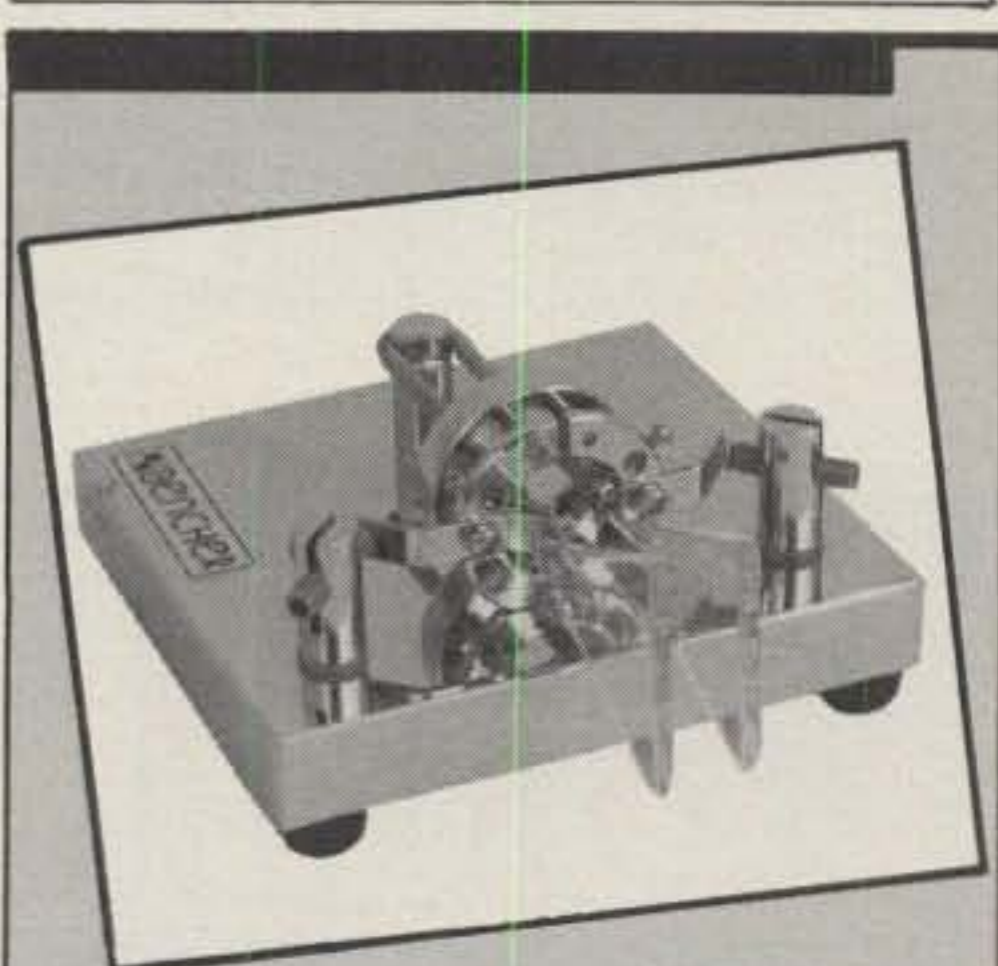

## WE MAKE CW FUN AGAIN

- Stainless Steel Adjustable Spring for Different Fists
- Non-Skid Feet
- Nylon & Stainless Self Adjusting Needle Bearings
- Stainless Fasteners
- Gold Plated Solid Silver Contact Points
- Large Clear Plastic Handles
- Unmatched Responsiveness

**BENCHNER, INC.**

333 W. Lake St., Chicago, IL 60606  
312/263-1808 FAX 312/263-3750

### 1989 CQ WW SSB Errata

W0ZV should be listed as a Single Operator, All Band entry, #1 in W0, #11 United States.

VE7NKI was incorrectly listed as VE7KNI in the Operator's List for the Multi-Single World Trophy.

JD1 Okino-Torishima Is., and #50 JD1 Minami-Torishima Is. (maximum of 50 per band).

**Final Score:** Total QSO points from all bands times the sum of the multiplier from each band.

**Awards:** Certificates to the top scorers in each class in proportion to the number of entries from each country and each call area in the U.S. and Japan. Plaques to the continental winners in each class, single and multi-operators, and to the three U.S. CQ zones. And a special award to the U.S. single operator, all band winner of a round-trip ticket to Japan (LA or SF to Tokyo). Stations working all JA Prefectures (1-47) during the contest can request a special award with their entry.

**Logs:** Use a separate sheet for each band. Indicate the multiplier in a separate column only the first time it is worked on each band. Entries with more than 500 contacts must include a cross-check dupe sheet. There are the usual penalties for taking credit for duplicate contacts; more than 2% means disqualification.

Mailing deadline is December 31st to *Five Nine Magazine*, Japan International DX Contest, P.O. Box 8, Kamata, Tokyo

144, Japan. Entrants may receive the final results by enclosing one IRC and an SAE.

### ALARA YL/OM Contest

0001Z to 2359Z Sat., Nov. 10

Organized by the Australian Ladies Amateur Assn., this activity is open to all YLs, OMs, and SWLs worldwide. YLs work everyone, OMs work YLs only, and SWLs log YLs only.

Use all five bands, 3.5 through 28 MHz (no WARC bands). Each station may be worked once on each band and each mode for point credit.

**Exchange:** RS(T), QSO number starting with 001, and name. ALARA members will identify.

**Scoring:** Phone—Contacts with ALARA members 5 points, with non-member YLs 4 points, with OMs 3 points. Double above points for CW contacts. SWL—5 points for ALARA YLs logged, 4 points for non-member YLs logged. Total QSO points from all bands for final score. There is no multiplier. QSOs with Novice operators count for double points.

**Frequencies:** Use the following frequencies: 3560-3590, 7070-7100, 14250-14280, 21190-21200, 21380-21410, and 28380-28410.

**Awards:** A wide selection of certificates to YL, OM, and SWL winners, both CW and phone, in each VK call area, each country, and each continent. And the Florence McKenzie CW Trophy to the top-scoring VK YL Novice operator.

Only original signed logs are accept-

able, and they must be received by December 31st. They go to: Mrs. Marilyn Syme, VK3DMS, P.O. Box 91, Irymple, 3498 Vic. Australia.

### European RTTY Contest

1200Z Sat. to 2400Z Sun., Nov. 10-11

Rules for the WAEDC RTTY contest are the same as for the CW and Phone sections held in August and September.

There is one main difference, however. To generate more activity in Europe and increase the QSO points, contacts between European stations are also permitted. QTC traffic, however, is not permitted within your own continent.

Check the August Calendar for all the detailed rules and regulations.

**Exchange:** RST plus a progressive QSO number.

**Points:** Each QSO and each QTC exchanged are worth one point. QTCs may be sent/received worldwide between continents (limit of 10).

**Multiplier:** Multipliers are determined from the DXCC list.

**Bonus Multiplier:** Multiply your multiplier on 80 meters by 4, on 40 meters by 3, and on 10/15/20 meters by 2.

**Awards:** Certificates will be awarded to the highest scorers in each class in each country with a reasonable score. Continental leaders will receive a plaque. Certificates will also be awarded to stations with at least half the score of the continental leader.

It is suggested that you use the official DARC log forms. A large SASE (IRCs) to the address below will get you a supply.

Mailing deadline for all entries is December 15th to: WAEDC Contest Committee, Postbox 1328, D-8950 Kaufbeuren, West Germany.

### Czechoslovakian Contest

1200Z Sat. to 1200Z Sun., Nov. 10-11

The Czechoslovakian Radio Club invites amateurs worldwide to participate in the annual OK-DX contest.

Use all six bands, 1.8 to 28 MHz. The same station may be worked once per band, either phone or CW, for QSO and multiplier credit.

**Classes:** Single operator, both single and all band, multi-single, multi-multi, and SWL.

Only one transmitter and one band permitted during the same 10-minute period for multi-single entries.

**Exchange:** RS(T) and your ITU zone.

**Scoring:** One point per QSO; 4 points if it's with a Czech, 2 points for different continent, and 1 point within same continent. Own country may be worked, but for multiplier credit only.

**Multiplier:** Sum of different ITU zones worked on each band.



# JOIN ARRL

## BENEFITS FOR YOU

QST, QSL Bureau Awards, Low Cost Insurance Operating Aids, Government Liaison and More—Much More!

### MEMBERSHIP APPLICATION

Name \_\_\_\_\_ Call \_\_\_\_\_

Street \_\_\_\_\_

City \_\_\_\_\_ Prov./State \_\_\_\_\_ PC/ZIP \_\_\_\_\_

\$30 in U.S. \$42 elsewhere (U.S. funds) Licensed amateurs or age 65 or over, upon submitting proof of age, may request special dues rate of \$24 in the U.S. \$36 elsewhere in U.S. funds. Persons age 17 and younger may qualify for special rates, write for application.

For postal purposes, fifty percent of dues is allocated to QST, the balance for membership.

VISA, MC, AMEX, Discover # \_\_\_\_\_

Signature \_\_\_\_\_ Expires \_\_\_\_\_

The American Radio Relay League  
225 Main St. Newington, CT. 06111 USA

CQ

CIRCLE 43 ON READER SERVICE CARD



A penalty of three additional contacts of the same point value will be deducted for each duplicate QSO or multiplier removed by the committee. Taking credit for excessive duplicates and other violations (regulations, unsportsmanlike conduct, etc.) will be deemed cause for disqualification.

**Awards:** Certificates in each class to the top-scoring station in each country. Additional awards will be made if returns justify. The "100 OK," "OK SSB," "Slovensko," and other Czech awards will be issued for contacts in the contest if a written application is submitted with your log.

Use a separate log for each band, indicate the zone multiplier only the first time it is worked on each band, and include a cross-check list for each band with 200 or more QSOs.

A summary sheet showing the scoring and the usual signed declaration that all rules have been observed is also requested.

All entries must be postmarked no later than December 15th and go to: Czechoslovakian Radio Club, P.O. Box 69, 11327 Praha 1, Czechoslovakia, or directly to the Contest Manager, Karel Karmasin, OK2FD, Gen. Svobody 636, 67401, Trebic, Czechoslovakia.

### North Carolina QSO Party

0000Z Sat. to 2400Z Sun., Nov. 10-11

This year the Alamance Amateur Radio Club (K4EG) is the official sponsor of the North Carolina QSO Party. Non-North Carolina stations work other NC operators. North Carolina stations may work anyone. Stations may be worked once per band/mode and mobiles/portables that change counties may be worked again for QSO credit.

**Exchange:** RS(T) and QTH (county for NC stations, state/province/DXCC country for others).

**Frequencies:** SSB—3860, 7260, 14260, 21360, 28360 kHz. CW—3540, 3740, 7040, 7140, 14040, 21140, 28040, 28140 kHz.

**Scoring:** Each NC county is a multiplier (100 total). In addition, North Carolina stations count NC counties, states, VE provinces, and DXCC countries for multiplier credit. Score 2 points for a CW QSO, 1 point for SSB, and 5 points for any Novice/Technician contact regardless of mode (Novices/Technicians should sign /N or /T after their callsigns). Final score is total QSO points times multiplier.

**Awards:** Certificates will be awarded to the high scorers. Logs must be kept in chronological order, numbering each new multiplier and including a separate multiplier check list. The mailing deadline for entries is December 15th, 1990, and they should be sent to: NC QSO Party, c/o K4EG, Box 3064, Burlington, NC 27215. If

you want the final results, include an SASE with your entry.

### CQ WW DX CW Contest

0000Z Sat. to 2400Z Sun., Nov. 24-25

Just a reminder, as if you needed one, that the CW section of our WW DX Contest is coming up the last weekend of this month. The phone section of course is past history. Complete rules were published in the September issue. Be sure to take special note of the new Single Operator Assisted Category. The contest trophies list has been updated and well covered in the rules.

All logs, both Phone and CW, must be sent to the CQ office: CQ World-Wide DX Contest, 76 North Broadway, Hicksville, NY 11801 USA.

Deadline for logs for the Phone section is December 1st, and January 15th for the CW section coming up. Be sure to indicate Phone or CW on your envelope. This will avoid your log from being entered in the wrong section.

### ARRL 160 Meter CW Contest

2200Z Fri. to 1600Z Sun., Nov. 30-Dec. 2

This is the 21st year for this "Top Band" activity. Exchange is between US stateside, VE, and DX stations. DX to DX not permitted for contest credit.

**Classes:** Single operator, and multi-operator single transmitter.

**Exchange:** RST and ARRL section for W/VE. RST only for DX stations; ITU Region for maritime and aeronautical mobiles.

**Scoring:** Contacts between stations in ARRL sections count 2 points, with DX stations 5 points.

**Multiplier:** Determined by number of ARRL sections and DX countries worked (for W/VE). (DX use ARRL sections only.)

**Final Score:** Total QSO points times the ARRL section and DX country multiplier.

**Awards:** Certificates to the top-scoring single operator station in each ARRL section and DXCC country. And to the top-scoring multi-operator station in each ARRL Division and continent.

Indicate the multiplier in a separate column only the first time it is worked. Entries with 200 or more QSOs are required to include a dupe sheet. Official log forms are recommended and are available from the ARRL. A large SASE and 45¢ postage or 2 IRCs will get you a supply for more than 300 contacts.

The usual grounds for disqualification (violation of established rules, excessive duplicate contacts, etc.) will prevail.

Mailing deadline for logs is January 6th to: ARRL Communications Dept., 160 Contest, 225 Main Street, Newington, CT 06111.

## TELEX *hy-gain*

Call The Nation's  
Newest Authorized  
Telex/Hy-Gain Dealer For  
Full Line Sales

1-800-331-5308  
(201) 775-0121

Tri Banders The Famous TH7DX  
Thunderbird, Explorer 14, TH3JRS,  
TH5MK2 Monobanders—  
Discoverer and Long Johns, HF  
Verticals—New DX-88, 8-Band 80-10  
Meters, VHF Beams And Verticals,  
Oscar Antennas, Towers And  
Rotators

CALL TODAY!



MC, VISA, AMX  
K2EDQ



M - F (8 - 5)  
SAT (8 - NOON)

*Pilot*

ELECTRIC COMPANY, INC.

1300 Hwy. 35 • Neptune, NJ 07753  
(201) 775-0121 • FAX 201-775-3635

CIRCLE 58 ON READER SERVICE CARD

Mac  
IBM

PC Study Aid for the  
Amateur Radio Exams

#### Highlights:

- Runs on IBM PC's and compatibles (CGA or Hercules Graphics recommended) or Macintosh computers.
- Contains latest question pools, (July 1990), associated graphics and explanations on appropriate questions.
- Logs multiple study sessions and allows resuming at a later time. Returns to review missed questions if desired.
- Creates randomly generated sample tests on-line or written on Epson/IBM or Macintosh graphics printers.
- Analyzes performance showing areas for additional study then provides concentrated emphasis in these areas.
- Programs are available for Novice, Technician, General, Advanced and Extra Amateur class exams as well as Commercial Radio Telephone and Commercial Radar Endorsement. Each program sold separately.

#### Reviewers Comment:

"The most advanced program I've tried ... Graphics are extraordinary ... This program should be your first consideration."  
Gordon West WB6NOA, Worldradio Nov. '89

"Do I recommend the QSO Tutor? Heartily, yes! It really motivated me and it's a great way to test my progress. The learning is a natural by-product of the fun I am having."  
Jim Bail KAITGA, 73 Magazine Review Jan '90

Now Available - Similar  
Commercial Radiotelephone license  
Tutor. \$39.95. Commercial Radar  
endorsement \$29.95.

Public Domain disk also  
available. Contains excellent  
morse code tutor as well as  
other Ham Radio programs.  
Cost is \$3 to cover materials  
and handling, \$2 if shipped  
with QSO TUTOR.

Call or write to order:  
QSO Software  
208 Partridge Way  
Kennett Square, PA  
19348  
215-347-2109  
Voice or FAX

\$29.95\* per Class

Visa and MC accepted  
\* PA residents add 6% Add \$2 each for IBM 3 1/2 disks

Ver 3.7

QSO Tutor

Copyright © 1988-1990 by WB3B

CIRCLE 93 ON READER SERVICE CARD 113

## NEWS OF COMMUNICATION AROUND THE WORLD

*Is Packet Ruining DX?*

**"B**ong, bong." The distinctive double tone of an incoming DX announcement cuts through the bustle of *The DX Bulletin's* office. A glance at the computer screen of the PacketCluster node tucked in one corner of the office shows the line "28494.0 FR5DX 28-Aug-1990 1950Z Erick [N6EE]." Hum, I need Reunion Island on 10 meters. I punch in the frequency on the keypad input of the ICOM IC-765 with my right hand while turning the knobs of the Ameritron AL-1200 amplifier to the premarked 10 meter positions with my left hand. I reach for the Heil BM-10 boomset while typing "SH/HFR" on the keyboard of the PacketCluster computer. "FR—Reunion: 6 degs." The Cushcraft A-4 swings to the north as I punch on the VOX and fine-tune the Reunion station on the 765.

FR5DX says, "QSL. QRZ?"

"WB2CHO/6," I reply.

"The Hotel Oscar portable Six, you're five nine." Bingo, another band-country in the log. Total elapsed time from bong to log—about 90 seconds. Total time lost from work to snag FR5DX—less than two minutes. PacketCluster has changed the face of DX. Has it ruined it?

My secretary thinks so. Donica has been known to shout "that's cheating" when I work a packet spot without moving from my position in front of the main computer. Gone are the hours of carefully tuning the bands, aiming the beam in various directions to seek out openings, and listening to a pile-up for 20 minutes or more to determine the callsign of the DX station. Now someone else is doing all the work, and I need only push a few buttons and turn a few knobs in this well-equipped station to snag a new one.

Gone is the thrill of the chase. It has been replaced with a sense of frustration if the DX station doesn't come back to the first call. Am I on the wrong split? Is the antenna aimed in the right direction? Should I try the long path? Depending on PacketCluster for DXing is a far cry from what was required to DX even a few short years ago. Is this good or bad for DX?

First, there is no question that PacketCluster is a boon for individual DXers, especially those DXers whose other activities severely limit the amount of listening



*UB5JRR (left) and RB5IJ at their CQ WW SSB contest operation in 1989. Romeo, UB5JRR, was active as 3W3RR from Vietnam earlier this year, and was part of the 1S1RR Spratly DXpedition.*

time. Instead of spending a half hour a day listening to the bands, and maybe working a handful of stations, the DXer can simply sit in the shack working on non-DX business and wait for the DX announcements to scroll across the screen. Or, just home for work, the DXer no longer needs to spend time determining what band is open to what part of the world, and which DX stations are under which pile-ups. A quick "SH/DX" provides that information in seconds.

The benefits of PacketCluster to the individual DXer have been described in many other places. With the addition of specialized databases and programs that sort and organize PacketCluster data, the packet setup has become one of the single most useful DX tools. PacketCluster is great for the DXer, but is it good for DX?

Over-dependence on PacketCluster is a potential problem. One of the benefits of DX is that it hones operating skills. Only the most experienced amateurs can pull the weak DX signal out from under local QRM, determine the DX station's operating style, locate the correct split frequency, and time the call correctly. These valuable skills can disappear if the DXer comes to depend on PacketCluster to find the DX and the split. But this problem is not unique to PacketCluster. It has been a part of DX for many years, as DXers would call fellow hams on the phone to alert them to rare DX. Two-meter DX spotting nets can create a similar dependency. When the Peter I DXpedition was active, the NCDXC VHF spotting network was filled with exact listening fre-

quencies, which made contact possible by even unskilled DXers. PacketCluster simply makes this sharing of information more efficient. Also, because packet networks are not instantaneous, the practice of calling out exact listening frequencies doesn't work as well with PacketCluster as it does with voice networks. PacketCluster has returned the skill of spotting listening frequencies to DX.

Another obvious problem with the widespread use of PacketCluster is an increase in the size of the pile-ups. When more than 100 DXers receive the same DX spot at about the same time, the pile-up on that DX station will explode. DX stations can easily tell when they have been "spotted" on the network; the number of stations calling for a given area increases dramatically. The increase in the number of stations calling makes DXing more difficult for the less well-equipped station. Unless the average DXer can make a contact before the horde descends on the frequency, he or she may have to wait until all the Big Guns have worked the station before getting another chance.

PacketCluster also provides additional opportunities for the DX freeloader. You have all met this character: the one who never buys a *Callbook*, subscribes to a DX newsletter, or holds office in the local DX club. Instead, this character continuously asks for someone to share news from the DX bulletins, asks for addresses from the *Callbook*, and is first to criticize club officers. With the advent of PacketCluster, the freeloader can work DX as it is spotted, never take the time to tune the bands, and share spots with other DXers.

While PacketCluster provides a new outlet for the freeloader, it also reduces the burden on fellow DXers. The freeloader no longer needs to tie up the voice repeater asking for DX news or repeats of the last spot, or what station is under what pile-up, or if the 5H has been on today. A couple of keystrokes, and the freeloader has all that information and more without interrupting anyone else. While PacketCluster has not eliminated the freeloader, it has made the freeloader less obnoxious to fellow DXers.

PacketCluster has led to some improvements in DXing. Gone are the "What's your call?" and "Has the 70 been on today?" questions that plagued the airways. Most routine DX information is now available 24 hours a day, without

# Ameritron gives you . . .

a full kilowatt OUTPUT from a quiet desktop linear . . . for \$1095

Ameritron gives you a full kilowatt output (nearly the input of some linears) of peak envelope power for only \$1095 -- from a whisper quiet linear that's perfect for your operating desk because it measures just 8 1/4" H x 14" D x 14 1/4" W. You also get 850 watts output CW and 500 watts RTTY.

The AL-80A covers 160-15 meters (10 meters with license), including MARS and WARC. You could spend over twice the money for a legal limit amplifier twice the size -- and all you'll get is an additional 1/3 S-unit -- a difference you won't ever notice.

**Tuned Input lets your rig deliver full output**

The Ameritron AL-80A uses a direct switched, 100% shielded pi-network tuned input circuit so even the fussiest solid state transmitter works flawlessly with it.

### Pi-L Output Network

A carefully designed Pi-L output network using the optimum Q for each band gives you exceptionally smooth tuning, extremely wide range load impedance matching and full band coverage. Ball bearing vernier reduction drives on both the plate and load control makes tuning precise and easy.

**3-500Z in shielded RF tank gives you nearly 70% efficiency**

You get the time proven 3-500Z transmitting tube with an estimated life of 20,000 hours ICAS. The AL-80A is built on a rugged steel chassis. It has a separate RF compartment that's fully shielded to keep RF from leaking out. This keeps RFI and TVI to a minimum.

A superb RF design and layout, a Hi-Q tank circuit and commercially rated power components gives you nearly 70% plate efficiency over the entire operating range. This puts the power into your antenna instead of heating up your amplifier.



Ameritron AL-80A **\$1095** Suggested Retail

result is a clean signal without flat-topping.

### Gutsy Heavy-Duty Power Supply

The guts of the AL-80A is its heavy heavy duty power supply. A 22 pound transformer using a high silicone steel core, computer grade capacitors, heavy duty bleeders and ten 3 amp, 1000 V power rectifiers give you a stiff 2700 volts fully loaded. Some amplifiers using two 3-500Zs use a light power supply so they can't give much more power output than the AL-80A.

### Step-Start Inrush Protection™

The AL-80A special Step-Start Inrush Protection stops damaging inrush current with a start up sequence that's easy on your tube and power supply components.

### Multi-Voltage Primary

Too high line voltage stresses components and causes them to wear out. Too low line voltage causes a "soft-tube" effect -- low output and signal distortion.

The Multi-Voltage Primary in the AL-80A lets you compensate for too high or too low line voltage so you get the longest component life and peak operating efficiency -- regardless of line voltage.

### Dual Illuminated Meters

Grid current of the 3-500Z is monitored continuously by one meter. Grid current gives the best indication of overall performance.

Multi-meter measures plate voltage, plate current, peak RF output power and drive power/ALC detector voltage.

## 600 WATTS OUT . . . \$599

A tough low cost linear with REAL transmitting tubes!

Shades of the legendary Collins 30L1 . . . this new Ameritron AL-811 brings back this rugged tube -- the 811A. It's given thousands of satisfied hams years of "treat it any old way" powerhouse use. And even if you fry these hearty 811As you can replace them for the cost of a few cheap pizzas.



AL-811  
**\$599**  
Suggested Retail



Plus you get dual illuminated meters, 3 second warm up, standby switch, tuned input, pressurized ventilation, multi-voltage primary and heavy duty power supply. 70 watts in gives you 600 watts PEP or 500 watts CW out. It covers all HF amateur frequencies including WARC and MARS. (10 meter modification with license).

A whisper quiet internal fan draws in cool air over the power supply components and the 3-500Z tube to remove heat for longer tube life.

Built-in adjustable ALC circuit makes sure your exciter never overdrives your AL-80A. The

Call your dealer for your best price today!

Bust through QRM with a full kilowatt -- right out of the box. Call your dealer for your best price and order today. Two year limited warranty.

## AMERITRON offers the best selection of legal limit linears!

These 3 rugged linears all use a super heavy duty hipersil® power supply capable of 2500 watts!

Ameritron's most powerful amplifier

AL-1500  
**\$2625**  
Suggested Retail



Ameritron super power amplifier uses the herculean 8877 ceramic tube.

It's so powerful that 65 watts drive gives you full legal output -- and it's just loafing because the power supply is capable of 2500 watts PEP.

Ameritron's Dual 3-500Z linear

AL-82  
**\$1995**  
Suggested Retail



This linear gives you full legal output using a pair of 3-500Zs. Some competing linears using dual 3-500Zs don't give you 1500 watts because their lightweight power supplies can't use the tubes to their full potential.

Ameritron's 3CX1200A7 linear

AL-1200  
**\$2045**  
Suggested Retail



Get ham radio's toughest tube with the Ameritron AL-1200 -- the Eimac 3CX1200A7. It has a 50 watt control grid dissipation -- 12 times tougher than the 4 watt rating of the 3CX800A7 -- yet you get the same full legal output as you get from a pair of 3CX800A7s.

## AMERITRON brings you the finest high power accessories!

Legal limit antenna tuner

ATR-15  
**\$399**  
Suggested Retail



Ameritron -- the high power specialist -- brings you the ATR-15 antenna tuner that's designed for legal limit amplifiers. Heavy duty silver plated bandswitch virtually eliminates switch failure. High power transmitting capacitors. 1.8-30 MHz. Peak reading SWR/wattmeter. 6 position antenna switch. Selectable 1:1 or 4:1 balun. 5 1/4 x 13 1/4 x 13 1/2 inches. Meter lamps uses 12 VDC.

**Ameritron Dummy Load** ADL-1500  
ADL-1500 Legal Limit Dummy Load, \$59.95. Oil included. Run 1500 watts for 5 minutes. 0-400 MHz. **\$59.95** Suggested Retail



Remote Coax Switches

RCS-8V  
**\$149**  
Suggested Retail

RCS-8V, DC-UHF 5 KW Coax Switch.

Replace 5 coax feedlines with one with this Ameritron Coax switch. Weatherproof box mounts outdoors on your tower or mast. Attractive control unit sits on your operating desk. Low SWR to 450 MHz. Low loss. Rated at 5 KW to 30 MHz, 1 KW at 150 MHz.

RCS-4, \$134.50. 4 position HF switch. Similar to RCS-8V. Requires no control cable. Handles 2500 watts PEP.



Compact Portable Linear

AL-84  
**\$549**  
Suggested Retail



Ham radio's most compact and most inexpensive self contained amplifier. 5x10x11 inch "tote it under your arm" powerhouse gives you 600 watts PEP, 400 watts CW. Four 6MJ6/ 6LQ6. Low SWR input. Great portable amplifier.

**AMERITRON**

. . . the high power specialist

921 Louisville Rd. • Starkville, MS 39759  
Phone: (601) 323-8211 • FAX: (601) 323-6551

Call for a catalog or your nearest dealer!

© 1990 Ameritron

## The WPX Program

### Mixed

1466 WB2YQH 1468 W1FYI  
1467 KD3QP

### SSB

2168 JF1TEU 2175 WB5TED  
2169 WB4OMM 2176 KD3QP  
2170 VE3BTQ 2177 JA6BMR  
2171 G0FWG 2178 HL9HP  
2172 EA6MQ 2179 KM4FC  
2173 EA7DXR 2180 WE2T  
2174 I6XGZ 2181 IK8HVH

### CW

2640 WB3LOP 2643 FD1MNV  
2641 EA6AAK 2644 W4TYU  
2642 KA3KWH 2645 KP4R

### WPX

260 KC4ODE

### VPX

264 I1-21171 265 HA5-303

### Endorsements

Mixed: 450 WB2YQH, W19Z, 500 WB2YQH, W19Z, 550 WB2YQH, 600 WB2YQH, VE1HA, G3DCC, 650 WB2YQH, G3DCC, 700 WB2YQH, 750 WB2YQH, JA4BAP, N6CW, 800 WB2YQH, DE0DAQ, W4USW, N6CW, 850 WB2YQH, K70A, PA0ASD, N6CW, 900 WB2YQH, KU0A, W3FDU, PA0ASD, 950 WB2YQH, I6DQK, PA0ASD, 1000 WB2YQH, I6DQE, W9IAL, K9BQL, PA0ASD, 1050 WB2YQH, I6DQE, 1100 WB2YQH, I6DQE, 1150 WB2YQH, I6DQE, KA3DBN, 1200 WB2YQH, KA3DBN, 1250 WB2YQH, KA3DBN, 1300 KA3DBN, 1550 KS3F, W5AWT, 1600 W5AWT, 1700 W5AWT, 1750 W4UW, W5AWT, 1800 N6JM, 2000 I8RFD, 2050 I8RFD, 2150 I1EEW, 2900 W4BQY, 2950 W4BQY.

SSB: 350 VE3BTQ, G0FWG, EA6MQ, WB5TED, W1FYI, WE2T, OE6CLD, IK8HVH, 400 VE3BTQ, G0FWG, EA6MQ, WB5TED, IE6CLD, IK8HVH, 450 VE3BTQ, G0FWG, EA6MQ, WB5TED, IK8HVH, 500 VE3KQS, VE3BTQ, N4HID, G0FWG, EA6MQ, WB5TED, IK8HVH, 550 VE3BTQ, G0FWG, EA6MQ, IK8HVH, 600 VE3BTQ, G0FWG, EA6MQ, K2EEK, IK8HVH, 650 G0FWG, EA6MQ, IK8HVH, 700 KF7RU, EA6MQ, IK8HVH, 750 EA6MQ, IK2AEQ, IK8HVH, 800 KU0A, EA6MQ, W3FDU, IK8HVH, 850 KU0A, EA6MQ, LU8DY, K8ZZU, IK8HVH, 900 EA6MQ, LU8DY, K9BQL, K8ZZU, IK8HVH, 1050 WK4F, 1100 WK4F, W0ULU, 1900 W4UW, I1EEW, 2100 W4BQY, 2150 W4BQY, 3100 ZL3NS.

CW: 350 EA6AAK, FD1MNV, W4TYU, 400 EA6AAK, FD1MNV, 450 EA6AAK, OK3TAY, 500 DE0DAQ, 550 DE0DAQ, G3DCC, 600 DE0DAQ, G3DCC, 650 W4UW, KL7UR, 700 KL7UR, 750 JG2LGM, 850 VS6UW, 900 PA3DBG, I1EEW, 950 PA3DBG, 1000 JA7FFN, PA3DBG, 1250 G4SSH, W8IQ, 1300 W8IQ, 2300 W4BQY.

10 Meters: WB4OMM, IK8CNT, I6XGZ, JA6BMR

15 Meters: KF7RU, IK8CNT

20 Meters: KF7RU, W1FYI

40 Meters: DE0DAQ

Asia: W9GCH, W3FDU, W8IQ

Africa: I6DQE, W3FDU

No. Amer.: DE0DAQ, IK2ILH, W3FDU, W4TYU, PA3DBG

So. Amer.: I6DQE

Europe: W3FDU, W1FYI, OE6CLD

Oceania: I6DQE, W3FDU, W8IQ

Award of Excellence: WB4RUA with 160M Bar Endorsement

Award of Excellence Plaque Holders: DK5AD, WDIIC, W3ARK, LA7JO, VK4SS, K6JG, N4MM, I8YRK, W4CRW, SM0AJU, K5UR, K6XP, N5TV, K2VV, VE3XN, W6OUL, DL1MD, DJ7CX, DL3RK, WB4SIJ, SM6DHU, N4KE, I2UIY, DL7AA, ON4QX, WA8YTM, YU2DX, OK3EA, I4EAT, OK1MP, N4NO, ZL3GQ, VK9NS, DE0DXM, DK4SY, UR2\*\*, AB9O, FM5WD, I2DMK, W4BQY, I0JX, SM6CST, VE1NG, I1JQJ, WA1JMP, PY2DBU, H18LC, KA5W, K0JN, W4VQ, KF2O, K3UA, HA8XX, HA8UB, W8CNL, K7LJ, W1JR, F9RM, W5UR, WB8ZRL, SM3EVR, CT1FL, K2SHZ, UP1BZZ, W8RSW, WA4QMO, EA7OH, K2POF, DJ4XA, I79TQH, W8ILC, K2POA, N6JV, W2HG, ONL-4003, VE7DP, K9BG, W5AWT, KB00G, HB9CSA, F6BVB, W1BWS, YU7SF, G4BUE, N3ED, DF1SD, K7CU, I1POR, LU3YLW4, NN4Q, KA3A, VED7WJ, YB0TK, VE7WJ, VE7IG, K9QFR, YU2NA, N2AC, W4UW, NX0I, W9NUF, N4NX, SM0DJZ, DK5AD, WB4RUA.

Award of Excellence Plaque Holders with 160 Meter Endorsement: W9NUF, N4NX, VK9NS, DE0DXM, VE7IG, K9BG, AB9O, FM5WD, SM0DJZ, DK5AD, SM6CST, I1JQJ, PY2DBU, W3ARK, H18LC, KA5W, UR2\*\*, VE3XN, K6XP, LA7JO, W4VQ, K6JG, K3UA, HA8UB, W4CRW, N4MM, K7LJ, SM0AJU, KF2O, SM3EVR, K5UR, UP1BZZ, OK1MP, N5TV, K2POF, W8CNL, DJ4XA, I79TQH, DL9RK, N6JV, ONL-4003, W1JR, W6OUL, W5AWT, KB00G, F6BVB, W4BQY, YU7SF, W5UR, N4NO, DF1SD, K7CU, I1POR, W8RSW, N4KE, I2UIY, YB0TK, W8ILC, W1BWS, VE7WJ, K9QFR, NN4Q, W4UW, K9QFR, NN4Q, W4UW, NX0I, G4BUE, LU3YLW4, I4EAT, WB4RUA, VE7WJ.

Complete rules and application forms may be obtained by sending a business-size, self-addressed, stamped envelope (foreign stations send extra postage if air-mail desired) to CQ WPX Awards, P.O. Box 1351, Torrance, CA 90505-0351 U.S.A.



Joe Hypnarowski, WA6VNR, was part of the PJ2U multi-multi CQ WW SSB contest DXpedition in 1989. He operated with his own callsign outside the test, concentrating on the new bands.

Fulton, California office) simply don't know enough about IRCs to handle them. They not only don't sell them, but they won't exchange them for stamps. In fact, very few post office employees know how to correctly handle IRCs. Fortunately, this can work to the advantage of the DXer, as well as causing problems. If you do succeed in finding a post office willing to sell you IRCs, make sure that the postal worker stamps the IRCs with the round cancellation stamp on the left-hand side of the IRC. To be acceptable, an IRC must be stamped on the left by the issuing post office, and *not* be stamped on the right until cashed in.

Again theoretically, a valid IRC can be exchanged for one unit of *surface* postage from one country to another. In the US the cost of sending one ounce to another country by surface mail is \$0.40. Thus, the post office should give you \$0.40 worth of stamps in exchange for a valid IRC. Don't be surprised if your local post office gives you more or less than this amount; again, few USPS employees know as much about IRCs as the average DXer. If the post office offers you *less* than \$0.40, take your business elsewhere. (An even less known regulation is that IRCs issued in the US should be exchanged for the face value on the IRC, minus a one cent service fee. Only a handful of USPS employees know this rule.)

Actually, relatively few individual IRCs are actually cashed in by US DXers. Most DXers need IRCs to send for DX QSLs, and US amateurs (other than some QSL managers) usually receive few IRCs. Those relatively few US amateurs who receive more IRCs than they use themselves can often get a better price on them from fellow DXers than the \$0.40 the USPS offers.

This secondary market in IRCs is technically against international postal regulations, but these regulations are not enforced. The secondary market price for IRCs varies with supply and demand. With the increased interest in DX in the past couple of years, combined with the

bothering other DXers. PacketCluster has improved accuracy in logging, as the DXer can determine the correct call off the computer screen. The "missing dot" problem that turns H73T into S73T and 5H3TW into HH3TW disappears with PacketCluster. The system has even reduced QRM by telling DXers which stations are operating split.

In short, PacketCluster is a useful DX tool similar to many others: the amplifier, and rotatable beam, "dual VFO" radios, VHF repeaters. As with many other DX tools, PacketCluster can be abused, and over-dependence on this multi-faceted DX tool can be harmful. But overall, PacketCluster is an important and valuable DX tool, one that has changed the face of DX, but for the better.

(PacketCluster is a registered trademark of Pavillion Software, P.O. Box 803, Hudson, MA 01749.)

## Beginner's Corner: The IRC

"4 QSL SAE ES IRCS PSE." One of the first DX tools the newcomer to DX meets is the International Reply Coupon (IRC). For almost any contact with stations outside the US, the DXer should supply the DX stations with both a self-addressed envelope (SAE) and some means of paying for the direct postage back to the US. There are three ways of paying for this postage: US \$1.00 bills (often called "green stamps"), actual postage stamps for the DX country (available from a handful of dealers), or IRCs. Of these options, the easiest and safest alternative is the IRC.

IRC's are theoretically available at any full-service post office. The cost is presently \$0.95, and will increase to \$1.05 early next year. However, many of the smaller post offices (including my own

## The WAZ Program

### Single Band WAZ

#### 10 Meter SSB

362 JE1GWO 363 K0HQW

#### 15 Meter SSB

353 TI2HP 356 JI3FYI  
354 JA9AVP 357 WL7E  
355 JH9PUW

#### 20 Meter SSB

810 TI2HP 814 OE7KWT  
811 K0HQW 815 K5AOL  
812 KP4P 816 AA4ZK  
813 IK6GZM 817 K16GI

#### 40 Meter SSB

63 TI2HP

#### 10 Meter CW

89 JA8KSD 91 WB4TDH  
90 JH1LBR 92 NF5Z

#### 15 Meter CW

188 AA4DO

#### 20 Meter CW

378 KG1V

#### WNZ Award

32 10 M SSB KA1TNK

#### RTTY Awards

48 RTTY W1EW 50 RTTY WD5DBV  
49 RTTY W5VT

#### 160 Meters

67 Y33VL

#### All Band WAZ SSB

3600	WD0HPW	3610	UB5JOO
3601	KE8MK	3611	KE0RR
3602	JH9PUW	3612	UH8EA
3603	JA9AVP	3613	G0FOX
3604	IK7FFX	3614	HK3BED
3605	EA1MO	3615	K2QIL
3606	EA7CWA	3616	PA0BYL
3607	K2VIV	3617	HP6AYV
3608	JE1OUF	3618	N6PYN
3609	W8KZM		

#### CW/Phone

6841	NK4Q	6848	WB3LQP (CW)
6842	EA6NB	6849	KE8MK
6843	KK4YA	6850	N4JHP (CW)
6844	RA9YD	6851	WB4FLB (CW)
6845	KQ2K (CW)	6852	IK1JTQ
6846	DK7PE	6853	JA9CXA
6847	VE4ACY	6854	VK2CWS (CW)

Applications and reprints of the latest rules may be obtained by sending a self-addressed stamped envelope (65 cents) size 4 1/2 x 9 1/2 to the WAZ Manager, Jim Dionne, K1MEM, 31 DeMarco Rd., Sudbury, MA 01776. Applicants forwarding QSL cards either direct to the WAZ manager or to a check point should include sufficient postage for safe return of their QSL cards. The processing fee for all CQ awards is \$4.00 for subscribers and \$10 for non-subscribers. Please make all checks payable to the Awards Manager. In order to qualify for the subscriber rate, please enclose your latest CQ mailing label with your application. Send any questions to K1MEM by mail and include an SASE (please do not telephone).

large number of major DXpeditions to rare countries, the price has risen from \$0.45-50 to \$0.55-65. Look for this price to rise to about \$0.75 next year. Even at this price, these "used" IRCs are a better deal than new ones from the post office. If you do purchase "used" IRCs, be sure to insist on valid IRCs only. Typically about 10% or more of all IRCs in circulation are not properly stamped on the left.

Another thing to watch for in the secondary IRC market is forged IRCs. While it is



*WB2P recently finished 5-Band Worked All Zones from this well-equipped shack. Zones 23 and 26 on 40 and 80 meters were the hold-outs, but RV0YF, 3W8CW, and XU8CW provided the necessary QSOs. Note the PacketCluster screen in the corner.*

hard to imagine anyone going to the trouble of forging something worth only a few pennies, there are a small number of fake IRCs floating around the DX community. (In the more than 10,000 IRCs that have passed through my office in the past two years, I have seen exactly one.) The forged IRCs are readily distinguishable from real ones. The paper is thicker and not as translucent, the printing job is poor, almost smudged, and there is no UPU watermark when the IRC is held up to the light. (Should you come across a forged IRC, hang on to it. It will probably be a collector's item. Don't try to cash it in at your local post office. There are US federal laws prohibiting such activity.)

There is a lot more to the story of IRCs, but this should keep the new DXer on the right track, and avoid wasting money on invalid IRCs.

## November DX Activity

**Steve Muster, G4UOL**, will be active from the Isle of Man as GD4UOL the last two weeks of the month on CW only. This is Steve's third trip to island, and he hopes to better his total of 5400 contacts that he logged in 1989. Steve will accept schedules. Contact him at his new address: Flat 4, 60 Genesta Road, Westcliff on Sea, Essex, UK SS0 8DB. QSL his GD4UOL to this address or via the RSGB bureau. Steve will also be active in the CQ WW CW test November 24-25.

Other single-operator CQ WW CW operations will include John Crovelli, W2GD, returning to Aruba as **P40GD**. John will be in Aruba November 20-27 and will concentrate on 17 and 12 meters outside the contest. He is usually on 160 meters on the hour at night. QSL to N2MM. Jacky, F2CW, expects to return to Morocco and operate with the contest call of **CN5A**. QSL to Jacky's home call. K4BAI also plans a return to Barbados as **8P9HT**. John plans to be there November

22-27 and favors 25 kHz up from the bottom of the band on CW and 21375 and 28490 kHz on SSB. On the new bands look for John on 10,118, 18,070, and 24,898 kHz. QSL his home call.

In the multi-single category K1XM, KQ1F, K1KP, and KN3T will operate from the Cayman Islands ZF. And another Finnish team returns to the Canary islands as **EA8AGD** for a multi-single operation. QSL via OH6DK. Finally, the RadioTeam Finland will be on as **PJ9A** in the multi-multi category, as mentioned last month. The Finns should be active outside the test on SSB and CW as well.

The CQ WW contests provide an excellent opportunity for the DXer to work new band-countries and even pick up a new country. But before you call a station in the test, read the rules in the September issue of CQ, and know your correct contest exchange so that the DX operator doesn't have to ask for it.

## QSL Notes

**OD5EH** can't receive QSLs in war-torn Lebanon, so his contacts should be confirmed via Vasil M. Kasyanenko, P.O. Box 20, Geprgievsk, 357800 USSR.

Serge Sadakov, RA1OA, is QSL manager for: **4K3ODX**, **UZ1PWE**, **UA1PAZ**, **UA1POL**, and **UA1POL/1**. Serge's address is P.O. Box 48, Arkhangelsk, 163040 USSR.

## 5 Band WAZ

**As of July 31, 1990, 285 stations have attained the 200 zone level.**

**New recipients of 5 Band WAZ Award with all 200 zones confirmed:**

HA0MM	EA1OD
I4EWH	DJ7RD

**The top contenders for 5 Band WAZ are:**

- |                 |                  |
|-----------------|------------------|
| 1. N4WW, 199    | 13. HA8XX, 199   |
| 2. UQ1GXX, 199  | 14. SV1JA, 199   |
| 3. W7OM, 199    | 15. K7UR, 198    |
| 4. SP9PT, 199   | 16. I8IGS, 198   |
| 5. K6YRA, 199   | 17. VE7DX, 198   |
| 6. K5UC, 199    | 18. W0PGI, 198   |
| 7. LA4HW, 199   | 19. VE7AHA, 198  |
| 8. PY7ZZ, 199   | 20. SM6AHS, 198  |
| 9. DL9WW, 199   | 21. K1ST, 198    |
| 10. K0CS, 199   | 22. KB8DB, 198   |
| 11. KB0G, 199   | 23. ZS6BCR, 198  |
| 12. ZS6BCR, 199 | 24. VE6OU/6, 198 |

**670 Stations have attained the 150 zone level as of July 31, 1990.**

Applications and reprints of the latest rules may be obtained by sending a self-addressed stamped envelope (65 cents) size 4 1/2 x 9 1/2 to the WAZ Manager, Jim Dionne, K1MEM, 31 De Marco Rd., Sudbury, MA 01776. Applicants should include sufficient postage for safe return of their QSL cards. The processing fee for all CQ awards is \$4.00 for subscribers and \$10 for non-subscribers. Please make all checks payable to the Awards Manager. In order to qualify for the subscriber rate, please enclose your latest CQ mailing label with your application. Send any questions to K1MEM by mail and include an SASE (please do not telephone).

## CQ DX Honor Roll

The CQ DX Honor Roll recognizes those DXers who have submitted proof of confirmation with 275 or more ACTIVE countries for the mode indicated. The ARRL DXCC Countries List is used as the country standard. Honor Roll listing is automatic when submitting application or endorsement for 275 or more countries. Deleted countries do not count and are dropped from listing as they occur. Total countries are now 324. To remain on the CQ DX Honor Roll, annual updates are required. Honor Roll updates may be made at any time, in any number. Updates indicating "no change" will be accepted to meet the annual requirement. All updates must be accompanied by an SASE for confirmation. The fee for endorsement involving the issuance of a sticker is \$1.00.

### CW

W9DWQ	324	OK1MP	317	W0SR	311	W1WAI	302	N5FW	294	DJ2PJ	286
K2FL	324	W6PT	316	IT9ZGY	311	YU2TW	301	IT9TOH	294	JH1VRQ	282
K2TQC	324	K4XO	316	K8PYD	310	I3OBO	301	W6YQ	294	W3BBL	282
N4JF	324	K3UA	316	W7CNL	310	W0JLC	301	IT9VDQ	294	I2QMU	281
K4CEB	324	N4PN	315	AA6AA	309	WB4RUA	300	K4CXY	292	K7ZR	280
DL1PM	323	DL7AA	315	K9IW	309	DL6QW	300	N5DX	291	I5XIM	280
K9MM	323	W1NG	315	K9BWO	309	NN4Q	300	KB0G	291	W2LZX	280
K6JG	323	N4KG	315	W9RY	308	I8WY	300	IT9QDS	290	KB9XG	280
ON4QX	322	N2KW	315	W0HZ	308	KZ4V	300	N4AH	290	W9NUF	280
YU1HA	322	W8KPL	314	K2OWE	308	F3TH	300	WA4IUM	290	K9TI	280
SM6CST	321	DL8CM	314	W4OEL	307	W6DN	299	W1WLW	289	KB8DB	280
N6AV	321	EA4IA	314	W6SN	307	K3FN	298	W4BV	289	HB9AFI	279
SM3EVR	320	N6CW	313	K09W	307	DJ7CX	297	K1VHS	289	KA2DIV	279
K6LEB	319	WA2HZR	313	SM6CTQ	306	K8LJG	297	G2GM	289	KA3R	278
K1MEM	319	W2DXA	312	W9WAQ	305	N8MC	297	K2JF	289	DL1QT	277
N4MM	319	K6EC	312	W2UE	305	WA4DAN	297	K8NA	288	K4JLD	277
DL3RK	319	W0IZ	312	WA4JTI	305	WA8YTM	297	G2FFO	287	K9DDO	277
W4BQY	318	DJ1XP	311	AB4H	304	WD9HX	296	W9SC	287	KU0S	277
K9AB	318	W6ID	311	WD9IC	303	KD8V	296	VE7DX	287	NS7Z	276
N6AR	317	K9QVB	311	WA8DXA	302	NY5L	295	G3KMQ	287	K4SE	275

### SSB

K2FL	324	W8ILC	318	I8KCI	313	CX4HS	306	I6PLN	299	PA0XPO	287
W6EUF	324	N6AR	318	F2MO	312	KE4HX	306	KA8T	299	I2EOW	287
VE1YX	324	KM2P	318	W0SD	312	KA3HXO	306	KB2FC	299	N8BJO	286
F9RM	324	K9AB	318	K9RF	312	WA6DTG	306	DJ7CX	299	N3ARK	286
N4JF	324	KB8DB	318	K9HDZ	312	W5LLU	306	K9SM	298	N9CPW	286
VE3MR	324	VE7WJ	318	LA7JO	312	WA6DTG	306	JH4PRU	298	K9MNT	286
DJ9ZB	324	WA4DAN	318	LU3YL	312	KZ8Y	305	EA9IE	298	IK7DBB	286
4Z4DX	324	YV5GWO	318	N6OC	312	K8VFX	305	XE1HI	298	KB5RF	285
W4EEE	324	N2KW	318	NA5W	312	EA1QF	305	KF5DX	298	KF5AR	285
W9DWQ	324	DJ1XP	317	W8ILC/QRPP	312	K4RIG	305	K5DUT	298	IK8BMW	285
W4DPS	324	KD8VM	317	I2MQP	312	K8ZZU	305	HP1JC	297	G4SZD	285
W0YDB	324	N4WF	317	NN4Q	312	I4WZK	305	YU7KV	297	VE2GHZ	285
EA4DO	324	K4POV	317	KS0Z	312	SM6CST	305	XE1OW	297	KC7EM	284
DL9OH	324	WD8MGO	317	IK2GNW	312	WA4IUM	305	WD9GQV	297	KR9F	284
VE3XN	324	SV1ADG	317	KA6V	312	KD8V	304	F6BFI	297	WB3HAZ	283
K6WR	323	W9OKL	317	AA6BB	312	KC8YM	304	WB3GPR	296	VE3MV	283
ZL1AGO	323	NY5L	317	W4SSU	311	W6MFC	304	KB3KV	296	ZP5JCY	283
YU1HA	323	KR9O	317	K6EC	311	K4LR	304	I0SGF	296	I8DVJ	283
I0ZV	323	I8LEL	317	K8NA	311	KB0SY	304	K8NWD	296	YB3CEV	283
VE3GMT	323	KC8EU	317	NJ0C	311	WE2L	304	KB0G	296	K3NEE	283
EA2IA	323	WA4JTI	317	I8XTX	311	KA9TNZ	304	EA4KK	296	W3SOH	283
I8YRK	323	I8ACB	316	AG9S	311	WA2FKF	304	W0IYR	295	WA9BXB	283
VE2WY	323	K8PYD	316	KB4HU	311	WA8YTM	303	KK0C	295	AE2B	282
ZL3NS	323	K4XO	316	G4ADD	311	XE1KS	303	G3XTT	295	A19R	282
W9OKL	323	N4KG	316	WD8PUG	311	W2LZX	303	VE3XO	295	TG9EP	282
K6JG	323	A18S	316	XE1OX	311	KB0U	303	KI3L	295	VE3NUP	282
K6YRA	323	W0SR	316	IK8BQE	311	W0ULU	303	I7UNX	295	N1ALR	282
K8LJG	322	WB1DQC	316	DK2BL	310	W4BOY	303	K4JLD	295	EA8TE	282
N4MM	322	VK4LC	316	AA6AA	310	XE1XM	303	WD0BNC	294	PY2DBU	281
W2SUA	322	T12CC	316	AB90	310	K7EH	303	I5BDE	294	NP4CC	281
OA4OS	322	W2CC	316	KU9I	310	K1MEM	302	WB3CON	294	NX0I	281
I0AMU	322	9H4G	316	N6AHV	310	N5FG	302	KB80	294	G4FAM	280
K9MM	322	W7FP	316	KB9OC	310	I3OBO	302	VE5FX	294	KU9Z	280
I8ALB	322	K2JLA	316	K1MIZ	310	K9UAA	302	IT9VDQ	294	W9VA	280
W9SS	322	WA4WTG	319	I2QMU	310	KP4EQF	302	K4SE	293	WB8TLI	280
N7RO	322	XE1AE	315	IV3YRN	310	N5FW	302	KC8JH	293	W5XO	280
T12HP	322	I8KDB	315	I5EFO	310	VE2PJ	302	AI5I	293	KB5DN	279
I8AA	321	K9LKA	315	I1POR	310	IK8GCS	302	W9NUF	293	EA6DE	279
OZ3SK	321	OH5KL	315	W6BCO	310	K0HOW	302	KD5ZM	293	JH8NYK	279
VE3MRS	321	OZ8BZ	315	G4GED	310	KZ4V	302	VE6PW	293	KX5V	279
K5OVC	321	YV5DFI	315	KB3OQ	310	KB1JU	302	T12LA	293	WN5K	279
DL6KG	321	W9RY	315	IK8CNT	310	VE3DLR	302	WA4LOF	292	K4BYK	278
I4LCK	320	I4EAT	315	KP4P	310	N6CGB	302	AC0A	292	VE3IUE	278
OK1MP	320	NJ2C	315	N4PN	309	WA3HUP	301	VE3FEA	292	DF6EX	278
KS2I	320	W4UNP	315	WD9HX	309	VE3FJE	301	VP9CP	292	KG9N	278
YU1AB	320	YS1RRD	314	K9QVB	309	WB4NDX	301	WB4LKG	292	I8WYD	278
PY1APS	320	K3UA	314	K4CXY	309	YU2TW	301	SV1JG	292	WB0UFL	277
W3GG	320	I2LLD	314	WB6PSY	309	N4CRU	301	T12JP	292	W4PTT	277
I4ZSQ	320	W1NG	314	VK4VC	308	KZ0C	301	KE7UL	292	WD0DMN	277
YV1KZ	320	W1LQQ	314	YV5AIP	308	N8BKF	301	N4KELM	292	K8YVI	277
W2FXA	320	SM4CTT	314	N6AV	308	WT4T	301	VE3IPR	291	HK6BER	277
W4NKI	320	W6SN	314	A18M	308	KB2HK	301	W4JFE	291	NC9T	277
YS1GMV	320	WB4UBD	314	NS7Z	308	K7LAY	301	DU9RG	291	I8IYW	277
K9BWO	320	K9IW	314	YV1AJ	308	KB9KD	301	XE1CI	291	N0AMI	276
N6AHU	320	K2JF	314	K8CMO	308	KC2FC	301	KB7VD	291	N7ASL	276
W7OM	320	KE4VU	314	K4MQG	308	KB2MY	301	K9TI	291	WA4OPW	276
IT9ZGY	320	K9HQM	314	I0MBX	307	IN3ANE	301	K1HDO	291	KC2RS	276
K1UO	320	W6NLG	314	KV2S	307	KF7SH	301	VE3CKP	290	WA9IVU	276
K2TQC	320	EA4LH	313	VK3JF	307	VE4AT	300	I4UFH	290	I2WZX	276
KZ2P	320	W8PCA	313	VE4SK	307	SV8CS	300	W9TA	289	NO4J	276
VE7DX	320	N2SS	313	KA9ABC	307	I2ZGC	300	JA5PUL	289	KC4MJ	276
ZS6LW	319	OE2EGL	313	WA2MID	307	NW5K	300	A19U	289	KA5YCM	276
W3AZD	319	ZL1BIL	313	WA4ECA	307	WB6GFJ	300	WD9IC	289	KI4FW	276
W0SFU	319	WZ4I	313	WB4PUD	307	JH1VRQ	300	YV2EJU	289	WB1EAZ	275
OZ5EV	319	IT9TGO	313	WB6OKK	307	IT9TQH	300	I4CSP	289	NX4Y	275
IT9XGY	319	K0GT	313	XE1MDX	307	K1VHS	300	OK1AWZ	288	VE7BSM	275
CT1FL	319	W2FGY	313	WB5TED	307	WA9RCO	300	EA3KW	287	W0FF	275
W6DN	319	G3VOF	313	N4KE	306	I8IGS	300	AB9E	287	I8INW	275
G4CHP	319	WB3DNA	313	KB5FU	306	PY4OY	300	W9SC	287	WA5SUE	275
W9JT	318	K09W	313	KE3A	306	ZL1BOQ	300				
OE3WVB	318	W4UW	313	K3LUE	306	WA0TKJ	299				

The Soviet amateurs who operated from Spratly Island in April made contacts from Vietnam after their DXpedition. QSL **3W6PY**, **3W1PZ**, and **3W9CZ** with SAE and postage to P.O. Box 43, Temirtau, Kazakh Republic 472310 USSR.

Carlos Bufanio, LU8DY (ex-LU8DWN), says to QSL his special contest call **LR8DY** to his home address: Lavallo 280, 1876 Bernal, Buenos Aires, Argentina.

Stu Honeysett, **H44SH/H44R**, has left the Solomons for the Ivory Coast, West Africa. QSL his Solomon contacts via his new address: c/o Serebou Seed Project, Commonwealth Development Corp., 04 B.P. 161, Abidjan 04, Cote D'Ivoire, West Africa.

**V85BJ** is Robert Reyes, now at 30 Mohawk Road West, Apt. 214, Hamilton Ontario Canada L9C 1V8.

QSL the Latvian station **YL1WW**, and their contest call **RQ9W**, as well as previous call **UQ1GWW** to Igor Kuzhelev, P.O. Box 418, Riga 226001, Latvia.

Izmir, Turkey amateurs **TA3B**, **TA3C**, **TA3D**, and **TA3F** say not all their mail is being delivered. They suggest using registered mail, or sending cards via DL5YCC if you don't get a timely response.

Peter Casier, ON4AAQ, will confirm his August **C30EMA** Andorra operation and the **OQ7AR** WPX operation via the ON bureau, or direct to P.O. Box 1, B-9230 Melle, Belgium.

Barry Stewart, ZL2RR, is the new manager of the New Zealand Association of

### CQ DX Awards Program

#### SSB

1790	AA6BB	1795	EC3CPT
1791	KA6V	1796	GW0GDI
1792	WE2T	1797	KP4P
1793	KF7SH	1798	WA9BXB
1794	W1FYI		

#### CW

802	ZL1BSG		
799	IT9VDQ	801	JH2TPI

#### SSB Endorsements

320	W4DPS/324	310	W6NLG/314
320	EA4DO/324	310	KE4VU/314
320	W9DWQ/324	310	K2JF/314
320	W4EEE/324	310	KA6V/312
320	W0YDB/324	310	AA6BB/312
320	W9OKL/323	310	WD8PUG/311
320	K6JG/323	310	KP4P/310
320	VE2WY/323	300	WA6DTG/306
320	I8ACB/322	300	KF7SH/303
320	W9SS/322	300	KB2MY/301
320	T12HP/322	275	IT9VDQ/294
320	DL6KG/321	200	T12SAH/218
310	WA4WTG/316	200	N4HID/200

#### CW Endorsements

320	K6JG/323	275	K2JF/289
320	ON4QX/322	150	ZL1BSG/150

Total number of active countries is 323. The basic award fee for subscribers to CQ is \$4. For non-subscribers, it is \$10. In order to qualify for the reduced subscriber rate, please enclose your latest CQ mailing label with your application. Endorsement stickers are \$1.00. Updates not involving the issuance of a sticker are made free when an SASE is enclosed for confirmation of total. Rules and application forms for the CQ DX Awards Program may be obtained by sending a business size, No. 10 envelope, self-addressed and stamped, to CQ DX Awards Manager, Billy Williams, N4UF, Box 9673, Jacksonville, FL 32208 U.S.A. DX stations must include extra postage for air-mail reply. Please make all checks payable to the awards manager.

# SGC

# SG-230

# SMARTUNER

**HF ANTENNA COUPLER  
SSB, AM, CW & DATA  
FAST-INTELLIGENT-ACCURATE  
OPERATES WITH ANY HF TRANSCEIVER**

The *Smartuner* high technology coupler intelligently tunes any length antenna (8 to 80 ft) in the HF band. The unit will operate with any HF transceiver within its' specifications. The *Smartuner* switches 64 input and 32 output capacitance combinations plus 256 inductance combinations in a "pi" network resulting in over a half-million different ways to ensure a perfect match for the transceiver. And, *it remembers the frequency and the tuning values* and will re-select these values in less than 10 ms next time you transmit on that frequency.

**SGC****WARRANTY REGISTRATION CARD**

Card must be mailed within 10 days of purchase to validate warranty\*  
NAME: J. MARTINO VESSEL NAME: AFRICAL ROVER

ADDRESS: SEE BELOW

TELEPHONE: \_\_\_\_\_

MODEL: SG-230 SERIAL NBR: QA90484 VOLTAGE: 12V

DATE PURCHASED: 1 MAY 89 DATE INSTALLED: 1 DEC 89

INSTALLED BY: J. MARTINO (OPERATOR)

CAPE TOWN DEPT OF STATE WASH DC 20521

20521

(provide full name, address & telephone of installer)

\*refer to owners manual for full warranty terms

**PERFORMANCE INFORMATION**

LENGTH OF TIME TO INSTALL: 5 hrs (WITH COPPER STRIP & GROUND PLANE)

WAS SATISFACTORY TEST CALL MADE? YES

DISTANCE COMMUNICATED: USSR/JAPAN/N.Z. AMATEUR BAND USING SAIL BOAT BACKSTAY

Circle One  
 INSTALLATION:  Simple  Difficult  
 TUNING:  Simple  Difficult  
 TEST CALL:  Good +  Fair  Poor  
 VOICE QUALITY:  Good +  Fair  Poor

YOUR COMMENTS: WHAT CAN I SAY!  
FIRST CONTACT NEAR  
MOSCOW 5-5



**SPECIAL  
HAM PRICE:  
\$555.00**

- MICROPROCESSOR CONTROLLED
- NON-VOLATILE MEMORY
- WATERPROOF
- B.I.T.E. INDICATOR
- 1.8 TO 30 MHZ RANGE
- 10 TO 150 WATTS INPUT POWER
- 10 mS RETUNING TIME
- 8 TO 80 FT. ANTENNA (All Types)
- FOR MARINE, AVIATION, HAM AND PARA-MILITARY APPLICATIONS

The SG-230 Smartuner is available from:

Eli's Amateur Radio, FL - 305-525-0103  
Gordon West Radio, CA - 714-549-5000

Henry Radio, CA - 213-820-1234  
Surplus Sales, NE - 402-346-4750

SGC Inc. SGC Building, 13737 S.E. 26th St. Bellevue, WA 98005 USA  
P.O. Box 3526, 98009. Telex: 328834. Fax: 206-746-6384 Tel: (206) 746-6310

# IMPROVE YOUR HEARING



**SOUND PURIFIER**  
REDUCE BACKGROUND NOISE!  
REMOVE INTERFERENCE  
FROM RECEIVED AUDIO!

Quality "armchair copy" even with weak stations is now a reality thanks to the SOUND PURIFIER. Annoying garbage is removed by two multi-stage tunable filters. Easy to use! Sharp skirts! Connects between rig and external speaker. Loud 6 watt audio output! 115 VAC powered. Special \$79.95 (reg \$89.95)

**SHORTWAVE SUPERCHARGERS!**

Make your SWL'ing much more enjoyable. Complete line of accessories! Send for details!

**SCANNER BOOSTERS!**

Hear ALL the action in your area with our scanner products! Send for details!



**VAK-TENNA**

Ultimate antenna for apartments! Great for 2mtr, 220 or SCANNER. Mounts to window with suction cups! \$24.95

**ELECTRON PROCESSING, INC.**  
P.O. BOX 88  
CEDAR, MI 49621  
(616) 228-7000

US \$4 Shipping/Handling  
Canada, AK, HI, PR \$7  
NY & MI add Sales Tax

SATISFACTION GUARANTEED! MANY PRODUCTS, SEND FOR DETAILS!

CIRCLE 89 ON READER SERVICE CARD



**HamCall / CD-ROM**

500,000 HAMS plus  
1,000's of Public Domain  
Amateur Radio Programs and Data

CD-ROM Disc.....\$50.00  
Questar Retrieval Software.....\$50.00  
Shipping (per order).....\$5.00  
Sony CDU-6100 player.....\$549.00

**SUCKMASTER Publishing**

Rt. 3, Box 56 - Mineral, Virginia 23117  
703-894-5777 - 800-252-5628



Rudy, DK7PE (standing), recently operated as 7Q7CW from Malawi, a country that has seen a burst of activity this year. Rudy frequently operates from rare countries. Here he visits with Ahmed, SU1AH, in Cairo.

Radio Transmitters (NZART) QSL bureau. Send your ZL cards to P.O. Box 857, Wanganui, New Zealand.

Anita Keighley, KN2N, has the 3B8FP logs for only the period September 6, 1987 to May 31, 1989. She has not been

## G5RV All-Band QuickKits™

created by Antennas West Box 50062, Provo, UT 84605

- Fast & Easy to Build
- Fail-Safe visual instructions
- No measuring or cutting
- Everything included
- Finish antenna in minutes

**Quality Components**

- Presoldered Silver Fittings
- Kinkproof QuietFlex wire
- Fully insulated, wax sealed, no-corrode, low noise design

**Tune All Bands Incl WARC**  
Build your own from scratch. Order TechNote #124-C \$5.95 ppd USA  
Call 801-373-8425 for Tech advice.

- Double Size G5RV 204 ft 160-10 Dipole \$59.95
- Full Size G5RV 102 ft 80-10 Dipole \$35.95
- Half Size G5RV 51 ft 40-10 Dipole \$25.95
- Quarter Size G5RV 26 ft 20-10 Dipole \$19.95
- Marconi Adapter kit \$ 7.95 converts any dipole to Marconi
- 200' Dacron 250# line \$11.95

Order Hot-Line: Add \$5 P&H  
1-800-926-7373

CIRCLE 11 ON READER SERVICE CARD

## Electronic Repair Center

Service

Amateur Commercial Radio

The most complete repair facility on the East Coast.

Large parts inventory and factory authorized warranty service for Kenwood, Icom and Yaesu.

**SEND US YOUR PROBLEMS**

Service "Hams" for 30 years, no rig too old or new for us.

**HAMTRONICS, INC.**

4033 Brownsville Road

Treose, Pa. 19047

215-357-1400

CIRCLE 52 ON READER SERVICE CARD

able to obtain the more recent logs. While she'll continue to answer QSL requests for this period, direct or via the bureau, more recent contacts should be confirmed direct: Rachid Karroo, Box 164, Curepipe, Mauritius Island, Indian Ocean.

**7Q7RM** is J. Bill Musoke, P.O. Box 30135, Lilongwe-3, Malawi.

**A41KY** is Yaqoob al Jarby, Box 981, Muscat, Oman.

For **YI1BGD**, QSL via the individual operators:

Majid, Box 5864, Baghdad  
Diya, Box 7361, Baghdad  
Saad, Box 6100, Baghdad  
Emad, Box 7488, Baghdad  
Raed and Faris, Box 7147, Baghdad.  
QSL Operator Samy via ON7LX.

**KA1NCN** reports that **GB8SI** will QSL all contacts via the bureau. For a direct response, try Box 599, Glasgol G1, Scotland.

And **1S5IJ** and **JX3AG** are both reported as pirate stations.

## QSL Managers

- |                      |  |
|----------------------|--|
| 1Z9B to KA6V         | TK5EL to F6FNU   |
| 3B8DB to NA5U        | TR8BY to FF6KGU  |
| 3G6MBQ to CE60S      | TR8CJ to G3ORC   |
| 4K1A to RA3ST        | TR8GL to F6IXI   |
| 4S7CF to BV1JY       | U9Z/UA9YDF to UA9YAB   |
| 5H3TW to K3ZO        | UA9YDF/U9Z to UA9YAB   |
| 5T5SA to IK2GES      | UB6P/UB5UT to UB5UT  |
| 5V7RC to OZ1LLC      | UC5A/UA6EO to UC2AHZ   |
| 5W1KY to WA3HUP      | UD6DKW to W3HMK  |
| 5Z4BI to W4FRU       | V31TU to IQ1A  |
| 708AA to F6EXV       | V44KJ to WB2TSL  |
| 7Q7JA to JH8BKL      | VE2DWU/C10GI to VE2DWU   |
| 7Q7RM to K6KII       | VE2EDK/C10GI to VE2EDK   |
| 7X2CR to IS0LYN      | VP2EY to HB9SL   |
| 8P6AL to KU9C        | VP5GH to WN5K  |
| 9L1US to WA8JOC      | VP5P to WN5A   |
| 9M2ZZ to N4RMF       | VP5VPX to W4NPX  |
| A61AD to WB2DND      | VP8CEA to G4JOV  |
| AA6LF/KH5 to AA6LF   | VU2ZAP to W3HMK  |
| AH9AC to I8YCP       | WZ6C/ST4 to W4FRU  |
| C30CAG to F6BKP      | XU8DX to JA1NUT  |
| C53GB to FD1MXH      | Y90ANT to Y21RO  |
| C10GI to VE2EDK      | Y90SOP to Y42DA  |
| C160R to VE6KC       | YC8OAT to YB0HZL   |
| CT3BX to CT3EE       | YI2LVB to I8YCP  |
| DL8CM/ZS1 to DL8CM   | YJ2BKS to SP5DYO   |
| EAB/G8KPW to G4BAH   | YJ8MB to SP5DYO  |
| EA8BF to EA8UR       | YL75ID to UQ1GWW   |
| EA9TL to EA9IB       | ZC4CZ to G4SSH   |
| EK1NWB to UA1NEJ     | ZD8CUE to G4ZVJ  |
| FK8FI/M to F6GZA     | ZD9CN to W4FRU   |
| FK8GJ to F6CXJ       | ZK1XP to AA6LF   |
| FP/W5WU to W5WU      | ZK3EY to WA3HUP  |
| FT4XG to F1AAS       | ZS9AAA/ZS1 to DK9KX  |
| FT5XH to F6GYV       | 9J2AL to P.O. Box 32481, Lu-saka, Zambia                       |
| FY/KD3FK to KD3FK    | BY5RY to Box 5816, Fuqing                                      |
| H44RW to ZL1AMO      | BZ4RDF to Box 1827, Nanjing                                    |
| HB9IQB/58A to HB9IQB | HP1XBH to Box 912, APO Mi-ami 34002                            |
| HSBAC to WA4BCQ      | 0D5OX to Box 597, Tripoli                                      |
| HZ1AB to K8PYD       | RA1QCA/RA1N to Box 19, Sor-tavaia                              |
| J20X to F2VX         | RZ10A/A to RA1OA, Box 48, Archangelsk 163040                   |
| J28NU to F6FNU       | TF3EJ to Jakob Helgason, Haedarbyggd 25, 210 Gardabae, Iceland |
| J5CVF to CT1DI2      | UA9JXX to Box 34, Surgut 026400 USSR                           |
| JD1/JA9IAX to JJ1TBB | UC2WJ to Box 24, Vitebsk 210038 USSR                           |
| KA2IJ to WB3EXR      | UD70GF to Box 169, Baku 370000                                 |
| KE9A/DU3 to WB9YXY   | UI4L/UA4AD to Miro, Volco-grad 400066                          |
| KH3/KA3HMS to KA3HMS | ZD8LIJ to Steve Hodgson, Box 2, Ascension                      |
| OH8BDA to OH2BDA     | ZK1BY to P.O. Box 3, Tokai-mura 31911 Japan                    |
| OJ8/N78G to KF7PO    |  |
| OM2BTI to OK2BTI     |  |
| P29PL to VK9NS       |  |
| PP5IW/PP8 to PP5AS   |  |
| RB6P/RT4UF to RT4UF  |  |
| RC90/RB5MP to RB5MP  |  |
| RY1B/UW9SG to UW9SG  |  |
| S79MX to HB9MX       |  |
| SV9/KN6M to K8CW     |  |
| TA3F to DL5YCC       |  |
| T19CF to T12CF       |  |
| T19US to T12US       |  |
| TK/DL7HZ to DL7HZ    |  |

## VHF UHF OSCAR GOES

(the easy way)

### TRANSVERTERS

6 Meter 2M IF \$365.00

### RECEIVE CONVERTERS

6 Meter 10 M IF \$ 80.00  
2 Meter 10 M IF 80.00  
2 M (HP) 10 M IF 99.00  
220 MHz 10 M IF 99.00  
435 MHz 10 M IF 115.00  
1691 MHz 137.5 MHz 330.00

### GaAs FET PRE-AMPS

6 Meter T/R Switch \$ 80.00  
2 Meter T/R Switch 80.00  
220 MHz T/R Switch 85.00  
137 MHz (weather sat) 80.00  
1691 MHz (weather sat) 250.00

### ANTENNAS

137 MHz 2XY-137-C \$ 85.00  
137 MHz 5XY-137-C 115.00  
435 MHz 70-MBM28 60.00  
70-MBM48 110.00  
70-MBM88 150.00  
900 MHz DY20-900 95.00  
1268 MHz 1268-LY 70.00  
1296 MHz 1296-LY 70.00  
1691 MHz 1691-LY 75.00

Prices Subject to Change Without Prior Notice

ALL ANTENNAS INCLUDE 50 ohms Balun  
Send 75¢ (3 stamps) for detailed specs on all VHF & UHF Products



Spectrum International, Inc.  
Post Office Box 1084Q  
Concord, MA 01742 USA  
(508) 263-2145

CIRCLE 77 ON READER SERVICE CARD





HF Equipment Regular SALE  
IC-765 Xcvr/ps/keyer/auto tuner..... 3149.00 2699



IC-781 Xcvr/Rcvr/ps/tuner/scope .... 6149 5199



IC-751A 9-band xcvr/.1-30 MHz rcvr 1699.00 1469  
PS-35 Internal power supply..... 219.00 199<sup>95</sup>  
FL-63A 250 Hz CW filter (1st IF).... 59.00  
FL-52A 500 Hz CW filter (2nd IF).... 115.00 109<sup>95</sup>  
FL-53A 250 Hz CW filter (2nd IF).... 115.00 109<sup>95</sup>  
FL-70 2.8 kHz wide SSB filter..... 59.00



IC-735 HF xcvr/SW rcvr/mic..... 1149.00 989<sup>95</sup>  
PS-55 External power supply ..... 219.00 199<sup>95</sup>  
AT-150 Automatic antenna tuner .... 445.00 389<sup>95</sup>  
FL-32A 500 Hz CW filter..... 69.00  
EX-243 Electronic keyer unit..... 64.50  
UT-30 Tone encoder ..... 18.50

IC-725 HF xcvr/SW rcvr..... (Special) 949.00 799<sup>95</sup>  
AH-3 Automatic ant tuner .. (Special) 489.00 379<sup>95</sup>

IC-726 10-band xcvr/6m/.5-30MHz rx 1299.00 1129

Accessories Regular SALE

- IC-2KL HF solid state amp w/ps..... 1999.00 1699
- IC-4KL HF 1KW out s/s amp w/ps..... 6995.00 5995
- EX-627 HF auto. ant. selector (Special) 315.00 269<sup>95</sup>
- PS-15 20A external power supply ..... 175.00 159<sup>95</sup>
- PS-30 Systems p/s w/cord, 6-pin plug 349.00 319<sup>95</sup>
- SP-3 External speaker ..... 65.00
- SP-7 Small external speaker ..... 51.99
- CR-64 High stab. ref. xtal; 751A, etc ... 79.00
- SM-6 Desk microphone..... 47.95
- SM-8 Desk mic - two cables, scan ..... 89.00
- AT-100 100W 8-band auto. ant. tuner ... 445.00 389<sup>95</sup>
- AT-500 500W 9-band auto. ant. tuner ... 589.00 519<sup>95</sup>
- AH-2 8-band tuner w/mount & whip .... 758.00 689<sup>95</sup>
- AH-2A Ant tuner system, only .. (Special) 559.00 469<sup>95</sup>
- GC-5 World clock..... (Special) 91.95 69<sup>95</sup>

Accessories for IC-765, 781, 725 • CALL for Prices



★ Large Stocks  
★ Fast Service  
★ Top Trades  
at AES®

VHF/UHF Base Transceivers	Regular	SALE
IC-275A 25w 2m FM/SSB/CW w/ps...	1299.00	1129
IC-275H 100w 2m FM/SSB/CW.....	1399.00	1199
IC-475A 25w 440 FM/SSB/CW w/ps	1399.00	1199
IC-475H 100w 440 FM/SSB/CW (Spec)	1599.00	1269
IC-575A 25w 6/10m xcvr/ps (Special)	1399.00	1099
IC-575H 25w 100w 6/10m xcvr.....	1699.00	1469



VHF/UHF Mobile Transceivers	Regular	SALE
IC-228H 45w 2m FM/TTP scan (Special)	539.00	419 <sup>95</sup>
IC-229A 25w 2m FM/TTP mic.....	449.00	389 <sup>95</sup>
IC-229H 50w 2m FM/TTP mic.....	479.00	419 <sup>95</sup>
IC-448A 25w 440 FM/TTP ... (Closeout)	599.00	499 <sup>95</sup>

Dual-band FM Transceivers	Regular	SALE
IC-3210A 25w 2m/440 FM... (Closeout)	739.00	499 <sup>95</sup>
IC-3220A 25w 2m/440 FM/TTP mic...	659.00	569 <sup>95</sup>
IC-3220H 45w 2m/35w 440 FM/TTP	699.00	599 <sup>95</sup>
IC-1200A 10w 1.2GHz FM... (Closeout)	699.00	549 <sup>95</sup>
IC-2400A 2m/440 FM/TTP ... (Special)	899.00	699 <sup>95</sup>
IC-2500A 35w 440/1.2GHz FM.....	999.00	869 <sup>95</sup>



Multi-band FM Transceiver	Regular	SALE
IC-901 2m/440 Fiber opt. xcvr (Special)	1199.00	929 <sup>95</sup>
UX-R91A Broadband receiver unit...	389.00	349 <sup>95</sup>
UX-19A 10w 10m unit.....	299.00	269 <sup>95</sup>
UX-59A 10w 6m unit.....	349.00	319 <sup>95</sup>
UX-S92A 2m SSB/CW module.....	599.00	529 <sup>95</sup>
UX-39A 25w 220MHz unit (Special)	349.00	279 <sup>95</sup>
UX-129A 10w 1.2GHz unit.....	549.00	499 <sup>95</sup>

VHF/UHF Mobile Transceivers	Regular	SALE
IC-970A 25w 2m/430 MHz transceiver	2895.00	2499
IC-970H 45w 2m/430 MHz transceiver	3149.00	2699
UX-R96 50-905 Mhz receive unit....	389.00	349 <sup>95</sup>

Mobile Antenna	Regular	SALE
AH-32 2m/440 Dual Band mobile ant	39.00	
AHB-32 Trunk-lip mount.....	35.00	
Larsen PO-K Roof mount.....	23.00	
Larsen PO-TLM Trunk-lip mount.....	24.70	
Larsen PO-MM Magnetic mount.....	28.75	

Repeaters	Regular	SALE
RP-1510 2m 25w repeater.....	1849.00	1649
RP-2210 220MHz 25w repeater.....	1649.00	1399
RP-4020 440MHz 25w repeater.....	2299.00	1999
RP-1220 1.2GHz 10w repeater.....	2599.00	2249



Use your CREDIT CARD



Hand-helds	Regular	SALE
IC-02AT/High Power	409.00	349 <sup>95</sup>
IC-04AT 440 (Closeout)	449.00	329 <sup>95</sup>
IC-2SA 2m .. (Special)	419.00	299 <sup>95</sup>
IC-2SAT 2m/TP (Spec)	439.00	359 <sup>95</sup>
IC-3SAT 220 (Special)	449.00	369 <sup>95</sup>
IC-4SAT 440 HT/TTP	449.00	399 <sup>95</sup>
IC-2GAT 2m HT/TTP	429.00	379 <sup>95</sup>
IC-4GAT 440MHz, TTP	449.00	389 <sup>95</sup>
IC-32AT 2m/440 HT	629.00	549 <sup>95</sup>
IC-24AT 2m/440 HT	629.00	549 <sup>95</sup>

Limited Offer! .. FREE BP-82 external 7.2V @ 300ma. battery w/ IC-2SAT or IC-3SAT purchase.

IC-12AT 1.2GHz FM HT/TTP... (Closeout)	473.00	349 <sup>95</sup>
IC-12GAT 1w 1.2GHz HT/batt/cgr/TTP	529.00	469 <sup>95</sup>

Aircraft band handhelds	Regular	SALE
A-2 5W PEP synth. aircraft HT.....	525.00	479 <sup>95</sup>
A-20 Synth. aircraft HT w/VOR.....	625.00	549 <sup>95</sup>

For HT Accessories • CALL for Prices

Receivers	Regular	SALE
R-71A 100kHz to 30MHz receiver.....	\$999.00	869 <sup>95</sup>
RC-11 Infrared remote controller....	70.99	
FL-32A 500 Hz CW filter.....	69.00	
FL-63A 250 Hz CW filter (1st IF)....	59.00	
FL-44A SSB filter (2nd IF).....	178.00	159 <sup>95</sup>
EX-257 FM unit.....	49.00	
EX-310 Voice synthesizer.....	59.00	
CR-64 High stability oscillator xtal	79.00	
SP-3 External speaker.....	65.00	
CK-70 (EX-299) 12V DC option.....	12.99	



R-7000 25MHz-2GHz receiver.....	1199.00	1029
RC-12 Infrared remote controller....	70.99	
EX-310 Voice synthesizer.....	59.00	
TV-R7000 ATV unit.....	139.00	129 <sup>95</sup>



R-9000 100KHz-2GHz all-mode rcvr ... 5459.00 4699

Due to the size of the ICOM product line, some accessory items are not listed. If you have a question, please call. Prices subject to change without notice.

Top Trades! • We'll take your Clean Late Model gear in trade towards New ICOM Equipment. Write or Call for our Quote Today!

AES® ★ Over 33 Years in Amateur Radio  
HOURS: Mon. thru Fri. 9-5:30; Sat. 9-3

Order Toll Free: 1-800-558-0411 Toll Free in Wisconsin: 1-800-242-5195  
FAX: 1-414-358-3337

# AMATEUR ELECTRONIC SUPPLY® Inc.

5710 W. Good Hope Road; Milwaukee, WI 53223 • Phone (414) 358-0333

## AES® BRANCH STORES

Wickliffe, Ohio 44092	Orlando, Fla. 32803	Clearwater, Fla. 34625	Las Vegas, Nev. 89106	Chicago, Illinois 60630
28940 Euclid Avenue Phone (216) 585-7388	621 Commonwealth Ave. Phone (407) 894-3238	1898 Drew Street Phone (813) 461-4267	1072 N. Rancho Drive Phone (702) 647-3114	ERICKSON COMMUNICATIONS 5456 N. Milwaukee Avenue Phone (312) 631-5181
Ohio WATS 1-800-362-0290	Fla. WATS 1-800-432-9424	No In-State WATS	No In-State WATS	Phone (312) 631-5181
Outside Ohio 1-800-321-3594	Outside Florida 1-800-327-1917	No Nationwide WATS	Outside Nevada 1-800-634-6227	Outside Illinois 1-800-621-5802

## COMING SOON

1991 EDITIONS

1991 RADIO AMATEUR CALLBOOKS  
CALLBOOKS AVAILABLE EARLY DECEMBER

### NORTH AMERICAN EDITION

Fully updated and edited to include all the latest FCC and foreign government call signs and address to Hams in North America. Includes plenty of handy operating aids such as time charts, QSL bureau addresses, census information and much more. Calls from snowy Canada to tropical Panama. Now is the time to buy a new Callbook when you'll get the most use out of your investment. © 1990.

CB-NA91 Softbound \$29.95

### INTERNATIONAL EDITION

QSLs are a very important part of our hobby. All sorts of awards, including the coveted DXCC, require confirmation of contact before the award can be issued. Of special interest, addresses are being added daily for Hams in the USSR and other countries. While by no means complete, it's a start and will be of tremendous help in getting QSLs. Handy operating aids round out this super book value. © 1990.

CB-191 Softbound \$29.95

### BUY 'EM BOTH SPECIAL

CB-NA191 REG. \$59.90 ONLY \$54.95 SAVE \$5.00

### THE 1991 ARRL HANDBOOK

Revised and updated with the latest in Amateur technology, now is the time to order your very own copy of the world famous ARRL HANDBOOK. In addition to being the definitive reference value for your Ham shack, there are plenty of projects for every interest in Amateur Radio -- from antennas for every application to the latest state-of-the-art projects -- you'll find it all in the 1991 HANDBOOK. Over 1100 pages. ©1990.

AR-HB91 Hardbound \$24.95

AVAILABLE MID-OCTOBER

## NEW BOOKS

### WEATHER SATELLITE HANDBOOK

ARRL 4th Edition

by Ralph Taggart, WB8DQT



Taggart has long been recognized as one of the foremost experts on weather satellite picture reception. This new edition of his famous book has been updated and expanded to include all the latest information on satellite picture reception. Subjects covered include a complete section on what satellites are in orbit, everything you'd want to know on what kind of antenna, receiver, video formats and displays to use, plus much more! You get all the information you need to get your satellite system up and running. © 1990 4th Edition

AR-WSH Softbound \$19.95

### PRACTICAL ANTENNA HANDBOOK

BY Joe Carr, K4IPV

A comprehensive blend of theory and practical antenna applications make this new book by noted author Carr, a valuable book to have on hand. Features detailed analysis and construction information for all kinds of antennas, an explanation of the secrets of radio propagation, theory and use of transmission lines, a comprehensive overview of the radio spectrum as well as 22 BASIC programs for designing antennas. Learn from an expert -- get this book today. © 1990 1st edition 448 pages

T-3270 Softbound \$21.95

### QRP CLASSICS The Best QRP Projects from QST and ARRL Handbook 1975 to 1990

Put together with the QRP enthusiast in mind. Find out how to build receivers, transmitters, antennas, accessories, power supplies and just about everything you need to get on and operate a QRP station. Includes a section on design hints for amplifiers, matching networks, electronic switching and direct conversion receivers. © 1990 1st edition 228 pages

AR-QRPC Softbound \$11.95

### PASSPORT TO WORLDBAND RADIO 1991 Edition

Brand new, fully revised and expanded. Now includes a bigger and better SWL'S buyer's guide. Also includes all the latest broadcast schedules from countries around the world. Great reference text for Hams as well as the serious SWL and casual listener. ©1990

IBS-RDI91 Softbound \$16.95

# CALL TOLL FREE

(800) 457-7373 8AM-5PM EST

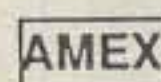

### ARRL UHF/MICROWAVE EXPERIMENTER'S MANUAL

MS-DOS Program disk available with 25 microwave applications. Long awaited by the above 30MHZ crowd, this book has quickly become one of our best sellers. Hams, technicians and professional engineers will find this manual to be extremely useful in understanding microwave technology. Twelve chapters include a brief history, safety, propagation, microwave devices, transmission media, design and fabrication techniques, system design, antennas and feedlines, EME operation, microwave measurements and how to use the computer to simplify microwave operation. © 1990 448 pages 1st edition.

AR-MEH Softbound \$19.95  
 FAR-FMEH (MS-DOS Program disk) \$9.95  
 AR-UHF Book and disk. Save \$2.00 \$27.90

### REFLECTIONS- Transmission Lines and Antennas by Walt Maxwell, W2DU

Over the years, many myths and half truths have become "fact." Noted antenna expert Maxwell debunks them with clear, concise and accurate explanations. The first seven chapters are taken from his QST column "Another Look At Reflections." Seventeen additional chapters contain new and unpublished material covering matching networks, antennas and how to use Smith charts. Also available is a MS-DOS disk with programs taken from the book. © 1990 1st Edition 384 pages

AR-RTLA Hardbound \$19.95  
 FAR-RTLADOS (MS-DOS Disk) \$9.95  
 AR-RTLADOS Program and disk \$2 off \$27.90

### DESIGN NOTEBOOK

by Doug DeMaw, W1FB

Written for the Amateur Radio builder. Projects can be put together using hand tools and easy-to-find parts. Building block approach to construction takes a simple idea and expands into a more useful piece of gear. Several interesting and useful projects. Great for the beginner. © 1990 194 page 1st edition

AR-DN Softbound \$9.95

### The DXCC COMPANION

How To Work Your First 100 Countries

by Jim Kearman KR1S

Complete explanation of all the secrets to being a big gun and getting DXCC with as little pain as possible. How and when to operate, the tricks the big guys use to work rare DX and get a card in return. Great reading for the beginner. © 1990 1st edition 120 pages

AR-DXCC Softbound \$5.95

### FREQUENCY MASTER FILE Vol. 1

Federal Assignments

by The Communications Research Council

Contains all the latest information on frequencies in use by the US Government. Over 200 pages of listings arranged by Government agency, location, call sign and other available information. © 1990 1st edition 215 pages

ATSI-FA1 Softbound \$24.95

### 1991 AMATEUR RADIO CALENDAR

by John David, KB1T

The only way to stay up-to-date on what's going on in Amateur Radio is to have a copy of this calendar on your operation shack wall. Includes contests, hamfests, holidays, W1AW events plus much more. Great holiday gift for a friend or for yourself. Get your's now! © 1990

KB1T91 \$11.95

### 40 YEARS OF HF MOBILING

by Don Johnson, W6AAQ

In addition to being a good source book for the HF mobiler, you get a fascinating history of the past 40 years of HF mobile operation. Fully covers what antennas to use, how to install radios, power supplies and antennas, tuners and a wealth of other information. Written in a friendly manner by a ham who has spent many years on the road with Amateur Radio. © 1989 3rd Edition 100 pages

AAQ-HFM Softbound \$14.95

## ANTENNAS

### BEVERAGE ANTENNA HANDBOOK by Victor M. W1WCR

Misek delves deep into the secrets of the single wire Beverage antenna. SWA (Steerable Wave Antenna) with helpful hints and tips on how to maximize performance based upon wire size, height above ground, overall length and impedance matching. Transformer design information for both termination and freeline matching is completely revised. ©1987. 80 pages, 2nd Edition.

VM-BAH Softbound \$

### THE AMATEUR RADIO VERTICAL HANDBOOK

Captain Paul H. Lee, USN (ret.), N6PL

Based upon the author's years of work with a number of different vertical antenna designs, you'll get plenty of theory and design information along with a number of practical construction ideas. Included are designs for simple 1/4 and 5/8-wave antennas, as well as broadband and multi-element directional antennas. ©1984, 2nd edition.

CQ-VAH Softbound \$

### W1FB's ANTENNA NOTEBOOK by Doug DeMaw, W1FB

Antennas have been one of DeMaw's passions in Amateur Radio. He has worked with countless designs of all shapes and configurations. This fully illustrated book gives you how-to instructions on a number of different wire and vertical antennas. Also includes information on radial systems, tuners, balun and impedance transformers. ©1987 120 pages.

AR-AN Softbound \$

### LOW BAND DX'ING by John Devoldere ON4UN

Based upon years of practical on-the-air experience, learn the secrets of how ON4UN has been so successful on the low bands. Extensive coverage is given to transmit and receive antennas. Dipoles, inverted V's, slopers, phased arrays and Beverages. Also covered: propagation, transmitters, receivers, operating, software and an extensive Low Band bibliography. ©1987

AR-UN Softbound \$

### ARRL ANTENNA BOOK by Jerry Hall, K1TD, 11th Edition

The 15th edition of this antenna classic represents over two years of hard work by editor K1TD. It's doubled in size too -- from over 300 over 800 pages big! 950 figures and charts cover just about every subject imaginable. Some of the highlights are: Chapters on Low band antennas, multi-band antennas, low frequency antennas, portable antennas, VHF and UHF systems, coupling the antenna to the transmitter and the antenna, plus p-l-e-n-t-y more. 15th edition. 150 pages. ©1988.

AR-AM Softbound \$

### ANTENNA IMPEDANCE MATCHING by ARRL

One of the most comprehensive books ever written on the use of Smith charts in solving impedance matching problems. 224 pages full of helpful information and solutions to tricky matching problems. ©1989.

AR-IMP Hardbound \$

### ANTENNA COMPENDIUM Vol 2

Includes MS-DOS program listings

Antennas are the #1 topic of interest among amateurs. ARRL annually receives far more articles than it can use in QST. So, it decided to publish them in THE ANTENNA COMPENDIUM. These have never been published articles run the range from simple, easy-to-construct antennas to sophisticated designs. Six program listings included. You can also get the programs on a MS-DOS disk for an additional charge. ©1989, 1st edition 208 pages.

AR-AC2 Softbound Book Only \$

FAR-AC2 (MS-DOS) Disk Only \$

AR-FAC2 BUY 'EM BOTH SAVE \$3.95 Book & Disk \$

### 1990-91 ARRL REPEATER DIRECTORY

Bigger and better! Over 14,000 listings including 1400 digipeater every Ham should have a copy of this book in their car or shack. Handy resource book has listings by frequency and location. Invaluable aid while traveling. ©1990.

AR-RD90 Softbound \$

AR-2RD90 (Buy 2 & Save)

# HAM RADIO MAGAZINE INVENTORY CLOSEOUT

This is it folks! Come January, we're going to have to start getting rid of old issues of Ham Radio Magazine. Order now to complete your collection. Here's what we have left in stock.

1968	March	1980	All Months
1969	Aug, Sept*, Nov	1981	All but January
1972	Jun, Aug, Sept*, Oct*	1982	All Months
1973	Feb, Mar, Jun, Jul, Sept*	1983	All but March
1974	Apr, May*, Jul*, Aug, Dec*	1984	All Months
1975	Feb, Mar, Apr, Jun, Jul, Aug, Oct, Nov, Dec*	1985	All Months, Sept*
1976	Jan, Oct	1986	All Months, May*
1977	Feb, Mar, May, Jun, Jul, Aug, Sept, Oct, Nov, Dec	1987	All Months, Oct*
1978	All Months	1988	All Months, Jan*, May*, Dec*
1979	All Months	1989	All but April
		1990	Jan through June

\* Less than 100 copies in stock

Prices  1 copy \$5.00  5 copies \$15.00  10 copies \$25.00  20 copies or more \$2.00 each issue

## OTHER GIFT IDEAS

### TOMMY ROCKFORD BOOKS by Walter Tompkins, K6ATX

These thrilling stories introduced a whole generation of Hams to the wonderful world of Amateur Radio. Great reading, and gift ideas for all levels of Amateur Radio Interest. Each story is full of action packed excitement.

<input type="checkbox"/> AR-DV	Death Valley QTH	Softbound \$4.95
<input type="checkbox"/> AR-SO	SOS At Midnight	Softbound \$4.95
<input type="checkbox"/> AR-CQ	CQ Ghost Ship	Softbound \$4.95
<input type="checkbox"/> AR-DX	DX Brings Danger	Softbound \$4.95
<input type="checkbox"/> AR-GC	Grand Canyon QSO	Softbound \$4.95
<input type="checkbox"/> AR-MO	Murder by QRM	Softbound \$4.95
<input type="checkbox"/> AR-TR	All 6 books, Reg. \$29.70 Save \$4.75	\$24.95

### PACKET USER'S NOTEBOOK by Buck Rogers, K4ABT

This new book has been put together by CQ's Packet editor and packet pioneer, Buck Rogers, K4ABT. Written with the beginner in mind, the Packet Notebook is full of handy tips, hints and suggestions on how to get the most out of your packet system. Includes a brief history, a how to get started section, standards, flow control and information on radio to TNC to computer interconnections for just about every radio. Good book to have on every packeteer's desk. ©1989 1st Edition, 132 pages.

CQ-PKT Softbound \$9.95



### 1990 ANTENNA BUYER'S GUIDE

Looking for the latest in antennas? It's all here in the CQ Antenna Buyer's Guide. Crammed full of articles, product information and a who's who section listing all of the manufacturers and importers. Get your's now and start planning for Spring 1991 antenna projects. ©1990

CQ-ANT90

Softbound \$4.95



### 1991 EQUIPMENT BUYER'S GUIDE

Brand new and fully up-to-date. Complete listing of equipment available from the various equipment and accessory manufacturers. Includes radios and accessories plus helpful hints and tips and a complete listing of addresses and telephone numbers. ©1990

CQ-EQP91 Softbound \$4.95

# HOLIDAY BOOK SHOPPER

## SOFTWARE

### 8086 ELECTRONIC SECOND OP

Improved Version 3.0  
Jim Rafferty, N6RJ (for MS-DOS computers)  
Jim's world famous Electronic Second Op has been extensively revised to meet the needs of today's active Radio Amateur. Must program for contesters, DX'ers and casual operators alike. Lighting entry and data retrieval gives you an unbelievable wealth of information in the blink of an eye. Now takes and stores data from the CT Contest program so you do not have to manually enter contest contacts. DXCC, prefix and oblast records are automatically updated and are available in an instant. Will not run on floppies -- you must have a hard drive. There's much more to this program than can be listed here. ©1990 MS-DOS computers. 5 1/4 and 3 1/2 disks available, please specify.

8086-RJ (MS-DOS Computers) \$59.95

### 9600 COMMUNICATIONS ENGINEERING

Version 3.1 by Lynn Gerig, WA9GFR  
A program that will allow you to predict communications based upon your stations operational capabilities. Useful from 1.8 MHz to 3.5 GHz. Also includes helpful Smith chart program for type of matching network. Provides impedance results in both polar and high resolution Smith chart graphics. Great value at a low price.

9600-DOS (MS-DOS) \$19.95

9600-C64 (Commodore C-64) \$19.95

### ROSMITH Smith Chart Utility Program (MS-DOS)

Les Hayward, W7ZO1  
Smith is a working Smith chart that has been optimized for impedance matching applications. The user can modify all variables to meet specific matching goals. Includes a clear and concise tutorial and all levels of interest will find useful. Complete text explanations and graphs aid full comprehension of the material.

ROSMITH (MS-DOS) \$29.00

### RAD ELECTRONICS DESIGN PROGRAM

Version 3.7 Includes Intermodulation and Distortion Program  
John Reiser, W1JR and Gary Field, WA1GRC  
3M PC and compatible computers

This software package has been written by electronic engineers and includes nearly 40 tested and proven programs. Emphasis has been placed upon ease of use. Programs include: Filters, LC, active-P, BP; Inductor design, toroid, solenoid, straight wire; Matching networks; Crystal oscillators; Microstrip; Transmission lines; Antennas; Yagi-Uda, helix, dish, horn, element scaling; Pi and T networks. Also included: Radio Path calculations; FM modulation systems; Miscellaneous conversions; Geostationary satellite pointing; Tracking aids; Receiver noise figure calculations and Spurious response prediction. Requires IBM-PC with at least one hard disk and 128k of RAM. ©1985.

RAD-CAD (MS-DOS) \$39.95

### 73 BEVERAGES THROUGH OSCAR

Available in MS-DOS Format  
A comprehensive electronics bibliography 1909 to 1988 with references in 92 chapters!

The only complete reference guide to Amateur articles in the world! Revised and up-dated from the softbound edition, this microfiche and CD-ROM data base reference lists 80 years worth of information from different sources that include QST/Gold (since 1945), the magazine RADCOM/Gold (since 1979) and all issues of QST, RADIO, CQ, and 73. Includes 5,000 key-word index and author cross-references. Unbelievable value. Worth much more than is being charged!

73-Microfiche \$49.95

73-MS-DOS \$79.95

### 100 PRACTICAL YAGI DESIGN (MS-DOS)

John Devoldere, ON4UN  
A comprehensive Yagi design program is based upon tested designs, not theoretical un-proven models. Contains 100 different antennas, designed, tested and optimized by ON4UN. Also includes a number of classic designs by noted antenna experts, including W6SAI and others. Includes mechanical design of elements and the rotating mast. Fully detailed "Read.me" file is designed to help the user get maximum results from the program. ©1989.

100-YAGI (MS-DOS) 5 1/4" & 3 1/2" Disk Avail. \$59.95



### BASEBALL CAPS

Personalized with your name and callsign. Super gift idea for any occasion. Hats come in the following colors: Blue, Gold, Red and Kelly Green. Please include your name and callsign. (Maximum of 6 letters per line)

UFBC (Specify color, name and call) \$7.95

### WA2SRF

### ID BADGES

No ham should be without an ID badge. Just the ticket for club meetings, hamfests and get-togethers. Wide choice of colors. Your name can be engraved either in script or standard type. Available in the following colors: (badge/lettering) white/red, woodgrain/white, blue/white, white/black, yellow/blue, red/white, green/white, metallic gold/black, metallic silver/black

UID (mark colors) \$3.50

## SPECIAL LOW PRICES

### DX-EDGE (MS-DOS, C-64) software and slide rule

Super fast speed and dazzling graphics make this program a treat to use. The MS-DOS version also includes a close up (zoom) feature for detailed examination, a MUF-calculator and a great circle bearing routine. All call sign prefixes and country names are built into the data base for easy pinpointing of locations. Requires 2 drives, 348k memory, Hercules, CGA or EGA graphics and DOS 2.1 or later.

<input type="checkbox"/> FXN-DOS (MS-DOS)	SAVE \$15.00	\$19.95
<input type="checkbox"/> FXN-C64 (C-64 computer)	SAVE \$25.00	\$9.95
<input type="checkbox"/> XN-DX (slide rule version)		\$22.95

## ORDER INFORMATION

Call (800) 457-7373 8AM-5PM EST

ORDERS ONLY

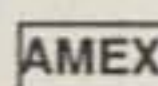
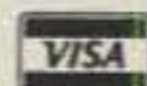

### INFORMATION

For More information about an order call (603) 878-1441

24 hour FAX Line (603) 878-1951

### SHIPPING AND HANDLING

\$3.75 to US and Canadian addresses. All other addresses FOB Greenville, NH USA plus \$3.75 handling. COD orders add an additional \$5.00. UPS Blue or Red cost plus \$3.75 handling.



**CQ's HAM RADIO BOOKSTORE**  
Your Amateur Radio Book Source

CATALOG Nov-CQ90  
GREENVILLE, NH 03048

# HAM SHOP

FREE TO CQ SUBSCRIBERS

**Advertising Rates:** Non-commercial ads are 20 cents per word including abbreviations and addresses. Commercial and organization ads are 60 cents per word. Boldface words are \$1.20 each (specify which words). Minimum charge \$2.00. No ad (non-subscriber) will be printed unless accompanied by full remittance. Non-commercial ads free to CQ subscribers, as space permits, maximum 3 lines each. All ads must be typewritten double spaced. Recent CQ mailing label must accompany ad.

**Closing Date:** The 10th day in the third month preceding date of publication. Because the advertisers and equipment contained in Ham Shop have not been investigated, the Publisher of CQ cannot vouch for the merchandise listed therein. Direct all correspondence and ad copy to: CQ Ham Shop, 76 N. Broadway, Hicksville, NY 11801.

**QSLs & RUBBER STAMPS**—Top Quality! Card Samples and Stamp Information \$1.00 (refundable with order). Ebbert Graphics D-2, Box 70, Westerville, OH 43081.

MRA-International Mission Radio Assn. helps missionaries—equipment loaned; weekday net, 14.280 MHz, 1:00–3:00 PM Eastern. Rev. Thomas Sable, S.J., University of Scranton, Scranton, PA 18510.

**KNOW FIRST!** Ham radio fanatics—you need THE W5YI REPORT, a twice-monthly award-winning Hot Insider Newsletter. Acclaimed best! Confidential facts, ideas, insights, nationwide news, technology, predictions, alerts. Quoted coast-to-coast! We print what you don't get elsewhere! \$21.00 annually w/money-back guarantee! FREE SAMPLE for S.A.S.E. (two stamps). W5YI, Box 10101-C, Dallas, Texas 75207.

FOR SALE. CQ/Ham Radio/QST/73 magazines @ 75¢ (thru 1975) and \$1.00 (1976-up) each, including shipping. \$3.00 minimum order. W6LS, 45527 Third Street East, Lancaster, CA 93535-1802.

CERTIFICATE for proven contacts with all ten American districts. SASE to W6LS, 45527 Third Street East, Lancaster, CA 93535-1802.

**CB-TO-10M CONVERSIONS:** FM kits, frequency modification hardware, books, plans, high-performance CB accessories. Catalog \$2. CBCI, Box 31500CQ, Phoenix, AZ 85046.

**CLANDESTINE CONFIDENTIAL NEWSLETTER:** Latest info on secret broadcasters. Six issues \$10 US, \$13 foreign, US funds. RR4 Box 110, Lake Geneva, WI 53147.

**HALLICRAFTERS Service Manuals.** Amateur and SWL. Write for prices. Specify Model Numbers desired. Ardco Electronics, P.O. Box 95, Dept. C, Berwyn, IL 60402.

**WANTED:** Older model bugs, unusual bugs, and miniature hand keys. State price, condition. Dave Ingram, K4TJW, 4941 Scenic View Drive, Birmingham, AL 35210.

**HAM RADIO REPAIR!** Tube through solid state. Robert Hall Electronics, Box 8363, San Francisco, CA 94128 (408-729-8200).

**HAM TRADER YELLOW SHEETS.** In our 29th year. Buy, Swap, Sell ham radio gear. Published twice a month. Ads quickly circulate—no long wait for results. Send business-size SASE for sample copy. \$15 for one year (24 issues). P.O. B. 2057C, Glen Ellyn, IL 60138-2057; or P.O. Box 15142C, Seattle, WA 98115.

**QSL CARDS:** Look good with top quality printing. Choose standard designs or fully customized cards. Better cards mean more returns to you. Free brochure, samples. Stamps appreciated. Chester QSLs, Dept. C, 310 Commercial, Emporia, KS 66801.

**CHASSIS, CABINET KITS:** SASE. K3IWK, 5120 Harmony Grove Road, Dover, PA 17315.

ANOTHER DAY with an empty mailbox? Improve your QSL returns with *Secrets of Successful QSL'ing* by Gerry L. Dexter. This complete guide to reception reporting and QSLing SWBC, Utility, ham, and medium-wave stations covers everything from basics to advanced techniques. Just \$9.95 plus \$2 s/h, \$3 s/h foreign orders, U.S. funds only. Order now from Tiare Publications, P.O. Box 493, Lake Geneva, WI 53147. Book catalog \$1.00, free with order.

**HAMS: USE AIRMAIL POSTAGE** not IRCs. Many countries, monthly bargains. List: #10 SASE. William Plum, 12 Glenn Road, Flemington, NJ 08822.

**SCANNER OWNERS:** *The Scanner Listener's Handbook* tells you how to hear more on your scanner radio. Lists band assignments from 25 MHz to over 2000 MHz, plus receivers, scanners, antennas, accessories, systems, and much more. \$14.95 plus \$2 s/h, \$3 foreign, US funds. Catalog \$1, free with order. Tiare Publications, P.O. Box 493, Lake Geneva, WI 53147.

**CW Lite** is the **easiest** Morse code training method in the world, bar none! And it is the **fastest**, too. Just close your eyes and relax. This powerful **hypnosis cassette tape** does the rest. **Subliminals** speed you along! Only \$14.95 ppd in US (NY residents add \$1.12 tax). (Attention instructors: Quantity discounts available for classes.) Order today! **PASS Publishing**, Box 570, Stony Brook, NY 11790.

**POST CARD QSL KIT.** Converts Post Cards, Photos, to QSLs! Stamp brings circular. K-K Labels, P.O. Box 412, Troy, NY 12181-0412.

**EMBROIDERED EMBLEMS, Enameled Pins,** your design, excellent quality. Free booklet. Box 682, Dept. 67, Littleton, NH 03561 (603-444-3423).

**WANTED:** Ham equipment and other property. The Radio Club of Junior High School 22, NYC, Inc. is a nonprofit organization granted 501(C)(3) status by the IRS, incorporated with the goal of using the theme of Ham Radio to further and enhance the education of young people nationwide. Your property donation or financial support would be greatly appreciated and acknowledged with a receipt for your tax deductible contribution. Meet WB2JKJ and the "22 Crew" on the Classroom Net daily, 1100–1230 UTC, 7.238 MHz. Then from 1230 to 1900 on 21.395. We look forward to meeting Radio Club of America members and friends at the NY Athletic Club during the RCA banquet on November 16. Write to us at: RC of JHS 22, P.O. Box 1052, New York, NY 10002. Round-the-clock hotlines: Voice (516) 674-4072, FAX (516) 674-9600.



Factory Authorized Dealer

• ICOM  
• TEN-TEC

CALL TOLL FREE 1-800-70K-HAMS

1-800-765-4267

• BENCHER, INC.

• HUSTLER

• NCG/COMET

• Kantronics

• Astron

• DIAMOND ANTENNA

• HEIL

• MFJ



• International Wire and Cable

• YAESU

• TELEX hy-gain

• Nye Viking

• Palomar

• CUSHCRAFT CORPORATION

• Larsen Antennas

FREE SHIPPING  
UPS SURFACE  
(except towers/antennas)



9500 Cedar Lake Ave., Suite 100  
Oklahoma City, Oklahoma 73114

Local & Info (405) 478-2866

FAX (405) 478-4202



C.O.D.

Hours of Operation  
M - F 9-6  
Sat. 9-3

THE DX MAGAZINE is your monthly DX reference: DXpedition reports, equipment and software reviews, six meters, awards, QSL information, and more. Sample only \$1.00. Box 50-C, Fulton, CA 95439 (707-523-1001).

**25-420 MHz MILITARY AVIATION FREQUENCY DIRECTORIES** for NORTH AMERICA—over 20,000 newly researched listings. Send SASE for info to: HAP1, Box 754, Flemington, NJ 08822-0754 (201-806-7134).

**QUALITY QSLs.** NEW Full Color Satellite!! ARRL, Cartoon, Patriotic, Mike & Key, Telegraph Keys, Historic, State Outlines. Quantities start at 100. Economy cards (State Outlines & Plain). **Plastic Cardholders.** Display 20 cards. Three—\$4.50. Four up \$1.30 each. More information? Business SASE with 45¢ postage. **Rusprint**, Rt. 3, Box 192CQ, Spring Hill, Kansas 66083.

**WANTED:** Pre-1980 microcomputers and magazines for Museum KK4WW. Dave Larsen, Blacksburg Group, P.O. Box 1, Blacksburg, VA 24063 (703-763-3311).

**WANTED:** Your help donating IBM-PC clone, technical and call books for IARN Soviet emergency radio service. I will personally deliver equipment to UB5WE. David Larsen, KK4WW, 703-763-3311.

**MORSE TERMINAL** kits allow sending and receiving Morse Code with your computer. For Tandy Color (\$39.95), Tandy 1000, and IBM compatible (\$49.95) computers plus \$3.00 shipping. Free Catalog. Dynamic Electronics, Box 896, Hartsville, AL 35640 (205-773-2758).

**PITCAIRN ISLAND:** Home of the Bounty VR6 Land-VHS Tape, filmed and narrated on the island by Kari & Brian Young, VR6KY, 72 minutes. The Hams, The People, The Island. \$29.95 includes shipping. Tibi Productions, P.O. Box 129, Medinah, Illinois 60157.

**FREE CATALOG:** IBM Shareware (800) 842-6819. Offshore Software Inc., 2941 Pretty Branch Dr., Mobile, AL 36618.

**RTTY JOURNAL.** Published ten times per year. Covering the digital modes of RTTY, AMTOR, FAX, PACKET, plus technical and other interesting articles about this fascinating phase of Ham radio. \$12.50 per year USA, foreign slightly higher. RTTY JOURNAL, 9085 La Casita Ave., Fountain Valley, CA 92708.

**FREE Ham Gospel Tracts.** SASE. Steve Forst, N3FTT, 5133 Gramercy, Clifton Heights, PA 19018.

**PACKET PICTURES FOR PC and Clones:** These disks are full of color pictures already converted to the MFJXFER format for passing via packet. Three disks containing pictures of cars, planes, schematics, and miscellaneous drawings are \$10.00; PSE specify CGA or EGA pictures. Six disks containing both CGA and EGA pictures are \$20.00. Each disk contains a "USER EASY" viewing program that allows pictures to be displayed and viewed in either CGA or EGA format (VGA will display also). If you have the new MFJXFER.EXE program, and the PC or clone, these pictures will display to your screen and save to disk as they are being received. Order from: Buck4ABT, 506 Pheasant Ridge Drive, Warner Robins, Georgia 31088. Sorry, no COD, or charge cards.

The *World Ham Net Directory* lists special interest ham nets for DXers, missionaries, weather watchers, retired persons, and many other interests. \$9.95 plus \$2 shipping (\$3 foreign) US funds from Tiare Publications, P.O. Box 493, Lake Geneva, WI 53147. Catalog \$1.00, free with order.

Ready to explore VHF/UHF operating? Get Ed Noll's *Basic Guide to VHF/UHF Ham Radio*. Covers equipment, antennas, propagation, repeaters, contesting, band plans, and more. All the basics you need! Just \$6.95 plus \$2 shipping (\$3 foreign) US funds from Tiare Publications, P.O. Box 493, Lake Geneva, WI 53147. Catalog \$1.00, free with order.

**HAVE AM CAPABILITY?** Join SPAM (Society for the Promotion of AM). For information and membership, send \$1 and SASE to SPAM, WB6TRQ, Box 62, Potrero, CA 92063.

**MUSEUM SEEKING** vintage radio/television broadcasting equipment, literature, microphones, transcriptions, Radios, TV's. Van Dyke, Squires Ave., E. Quogue, NY 11942 (516-728-9835).

**QSL SALE!** 100 QSL cards \$8, 200/\$11, 300/\$14, 500/\$20, 1000/\$33. Free shipping. Guaranteed correct. Free AM radio with 1000 card order! Phone or write today for samples or ordering. Shell Printing, KD9KW, Box 50, Rockton, IL 61072 (815-629-2193).

**DON C. WALLACE, W6AM:** This book describes the history of amateur radio, as experienced by Don Wallace. By Jan D. Perkins, N6AW. Hardbound, 350 pages. Prepublication price \$19.95 plus \$2.00 shipping and handling. California residents add \$1.35 sales tax. Available from Wallace & Wallace, 11823 Slauson Avenue, Suite 38, Santa Fe Springs, CA 90670.

**SURVEILLANCE/COUNTERSURVEILLANCE** devices catalog. Cameras, bug detectors, video camera detectors, transmitters, communications, and much more. Catalog \$3.00. DSP, P.O. Box 1275-CQ, Redondo Beach, CA 90278.

## ATV CONVERTERS • HF LINEAR AMPLIFIERS

DISCOVER THE WORLD OF FAST SCAN TELEVISION

70 CM  
33 CM

**AMATEUR TELEVISION CONVERTERS**

ATV2 420-450	\$44.95 Kit
ATV3 420-450 (GaAs-FET)	\$49.95 Kit
ATV4 902-928 (GaAs-FET)	\$59.95 Kit

**AUDIO SQUELCH CONTROL** for ATV  
SIL ..... \$39.95 Kit

**2 METER VHF AMPLIFIERS**

35 Watt Model 335A	\$79.95 Kit
75 Watt Model 875A	\$119.95 Kit

Available in kit or wired/tested

### HF AMPLIFIERS per MOTOROLA BULLETINS

Complete Parts List for HF Amplifiers Described in the MOTOROLA Bulletins.

AN758 300W \$160.70	EB63 140W \$88.65
AN762 140W \$93.25	EB27A 300W \$139.20
AN770L 20W \$83.79	EB104 600W \$448.15
AN779H 20W \$93.19	AR305 300W \$383.52
AR313 300W \$403.00	

### NEW!! 1K WATT 2-50 MHz Amplifier

**POWER SPLITTERS and COMBINERS**

600 Watt PEP 2-Port	\$69.95
1000 Watt PEP 2-Port	\$79.95
1200 Watt PEP 4-Port	\$89.95

**100 WATT 420-450 MHz PUSH-PULL LINEAR AMPLIFIER — SSB-FM-ATV**

KEB67-PK (Kit)	\$159.95
KEB67-PCB (PC Board)	\$18.00
KEB67-1 (Manual)	\$5.00

For detailed information and prices, call or write for our free catalog.

We ship worldwide.



**CCI Communication Concepts Inc.**

508 Millstone Drive • Xenia, Ohio 45385 • (513) 426-8600  
FAX (513) 429-3811



WE SHIP WORLDWIDE

### UNIVERSAL DIGITAL FREQUENCY READOUT

TK-1 (Wired/tested) ..... \$149.95

### HEAT SINK MATERIAL

Model 99 Heat Sink (6.5x12x1.6)	\$22.00
CHS-6 Copper Spreader (6x6x1/4)	\$18.00

We also stock Hard-to-Find parts

**CHIP CAPS—Kemet/ATC**  
**METALCLAD MICA CAPS—Unelco/Semco**  
**RF POWER TRANSISTORS**  
**MINI-CIRCUIT MIXERS**

SBL-1 (1-500MHz)	\$6.50
SBL-1X (10-1000MHz)	\$7.95

**ARCO TRIMMER CAPACITORS**

VK200-20/4B RF Choke	\$1.20
56-590-65-3B Ferrite Bead	\$ .20

Broadband HF Transformers

Add \$ 3.50 for shipping and handling.

CIRCLE 28 ON READER SERVICE CARD

# ELENCO & HITACHI PRODUCTS AT DISCOUNT PRICES

**NEW! RSOs (Real-Time & Storage Oscilloscopes) From HITACHI**  
The RSO - Its the new solution  
View, Acquire, Test, Transfer and Document Your Waveform Data

4-Channel, 100MS/s Model	Introductory Price
100MS/s (25MS/s on 4 channels simultaneously), 100MHz, 4kw x 1ch., 2kw x 2ch., 1kw x 4ch.	VC-6145 \$4,695.00

**Compact, Full Feature Models**

40MS/s, 100MHz, 4kw x 1ch., 2kw x 2ch.	VC-6045 \$3,049.00
20MS/s, 50MHz, 2kw x 2ch.	VC-6025 \$2,295.00

**Low Cost/High Value Models**

20MS/s, 50MHz, 2kw x 2ch.	VC-6024 \$2,049.00
20MS/s, 20MHz, 2kw x 2ch.	VC-6023 \$1,749.00

RSOs from Hitachi feature such functions as roll mode, averaging, save memory, smoothing, interpolation, pretriggering, cursor measurements, plotter interface, and RS-232C interface. With the comfort of analog and the power of digital.

**V-212 Hitachi Portable Scopes**  
DC to 50MHz, 2-Channel, DC offset function, Alternate magnifier function

V-525 CRT Readout, Cursor Meas.	\$1,025
V-523 Delayed Sweep	\$995
V-522 Basic Model	\$895

**V-422 40MHz Dual Trace \$795**

**20MHz Elenco Oscilloscope \$375**  
MO-1251

- Dual Trace
- Component Tester
- 6" CRT
- X-Y Operation
- TV Sync
- 2 p-1 Probes

**FREE DMM with purchase of ANY SCOPE**

**SCOPE PROBES**

P-1 65MHz, 1x, 10x	\$19.95
P-2 100MHz, 1x, 10x	\$23.95

**Elenco 35MHz Dual Trace \$495**  
MO-1252

- High luminance 6" CRT
- 1mV Sensitivity
- 6KV Acceleration Voltage
- 10ns Rise Time
- X-Y Operation + Z Axis
- Delayed Triggering Sweep
- Includes 2 P-1 Probes

All scopes include probes, schematics, operators manual, and 3 year (2 yrs for Elenco scopes) world wide warranty on parts & labor. Many accessories available for all Hitachi scopes. Call or write for complete specifications on these and many other fine oscilloscopes.

**WE NOW CARRY COMPLETE LINE OF FLUKE MULTIMETERS Models**

21F 83	
23F 85	
25F 87	
27F 8050A	
73 8060A	
75 8062A	
77F + More	

CALL FOR SPECIAL PRICING

**True RMS 4 1/2 Digit Multimeter M-7000 \$135**  
.05% DC Accuracy  
.1% Resistance with Freq. Counter and deluxe case

**10 Function Multimeter CM-365 \$65**  
AC + DC Voltage & Amps  
Resistance to 2000MΩ  
Diode, Logic, & Trans test  
Capacitance to 200μF

**Digital Capacitance Meter CM-1550 \$58.95**  
9 Ranges  
1p1-20,000uf  
.5% basic accy  
Zero control with case

**Digital LCR Meter LC-1801 \$125**  
Measures:  
Coils 1uH-200H  
Caps 1p1-200uf  
Res. 01-20M

**Function Generator Blox \$9600 \$28.95**  
Provides sine, triangle, square wave from 1Hz to 1MHz  
AM or FM capability

**Triple Power Supply XP-620 Assembled \$65 Kit \$45**  
2 to 15V at 1A,  
-2 to -15V at 1A  
(or 4 to 30V at 1A)  
and 5V at 3A

**Wide Band Signal Generators SG-9000 \$129**  
RF Freq 100K-450MHz  
AM Modulation of 10Hz  
Variable RF output

**SG-9500 w Digital Display and 150MHz built-in Counter \$249**

**Soldering Station Temperature Controlled SL-30 \$99**  
Digital display  
Temp range: 300F-300F  
Grounded tip  
Overheat protect

**Color Convergence Generator SG-200 \$69.95**  
Finest in the industry  
10 rock steady patterns

**10MHz Oscilloscope S-3000 \$275**  
10MHz DC or AC  
Triggered Sweep  
Calibrated Volt & Hor  
Reads Volts & Freq

**Temperature Probe M-110CF \$29.95**  
Semiconductor type  
Range  
-56F-302F  
Fits most digital multimeters

**Autorangeing DMM M-5000 \$45**  
9 Functions  
Memory and Data hold  
1% basic acc  
3 1/2 digit LCD

**AC Current Meter ST-1010 \$69.95**  
1000 Amps  
Data & Peak hold  
8 Functions  
Deluxe Case

**Decode Blox \$9610 or \$9620 \$18.95**  
#9610 Resistor Blox  
47 ohm to 1M & 100K pot  
#9620 Capacitor Blox  
47pf to 10MFD

**Quad Power Supply XP-580 \$59.95**  
2-20V at 2A  
12V at 1A  
5V at 3A  
-5V at .5A

Fully regulated and short circuit protected  
XP-575 without meters \$38.95

**Digital Triple Power Supply XP-765 \$249**  
0-20V at 1A  
0-20V at 1A  
5V at 5A

Fully regulated, Short circuit protected with 2 limit control, 3 separate supplies  
XP-680 with Analog Meters \$175

**GF-8016 Function Generator with Freq. Counter \$249**  
Sine, Square, Triangle  
Pulse, Ramp, .2 to 2MHz  
Freq Counter .1 - 10MHz

GF-8015 without Freq. Meter \$179

**LEARN TO BUILD AND PROGRAM COMPUTERS WITH THIS KIT!**  
INCLUDES: All Parts, Assembly and Lesson Manual

**Model MM-8000 \$129.00**

Starting from scratch you build a complete system. Our Micro-Master trainer teaches you to write in RAM, ROM and run a 8085 microprocessor, which uses similar machine language as IBM PC. You will write the initial instructions to tell the 8085 processor to get started and store these instructions in permanent memory in a 2816 EPROM. Teaches you all about input and output ports, computer timers. Build your own keyboard and learn how to scan keyboard and display. No previous computer knowledge required. Simple easy to understand instruction teaches you to write in machine language.

**ROBOTICS KIT FOR ABOVE (MM-8010) \$71.95**

**WE WILL NOT BE UNDERSOLD!**  
UPS Shipping: 48 States 5%  
(\$10 Max) IL Res., 7% Tax

**C & S SALES INC.**  
1245 Rosewood, Deerfield, IL 60015  
(800) 292-7711 (708) 541-0710

**15 Day Money Back Guarantee**  
**2 Year Warranty** Prices subject to change

**WRITE FOR FREE CATALOG**

CIRCLE 163 ON READER SERVICE CARD

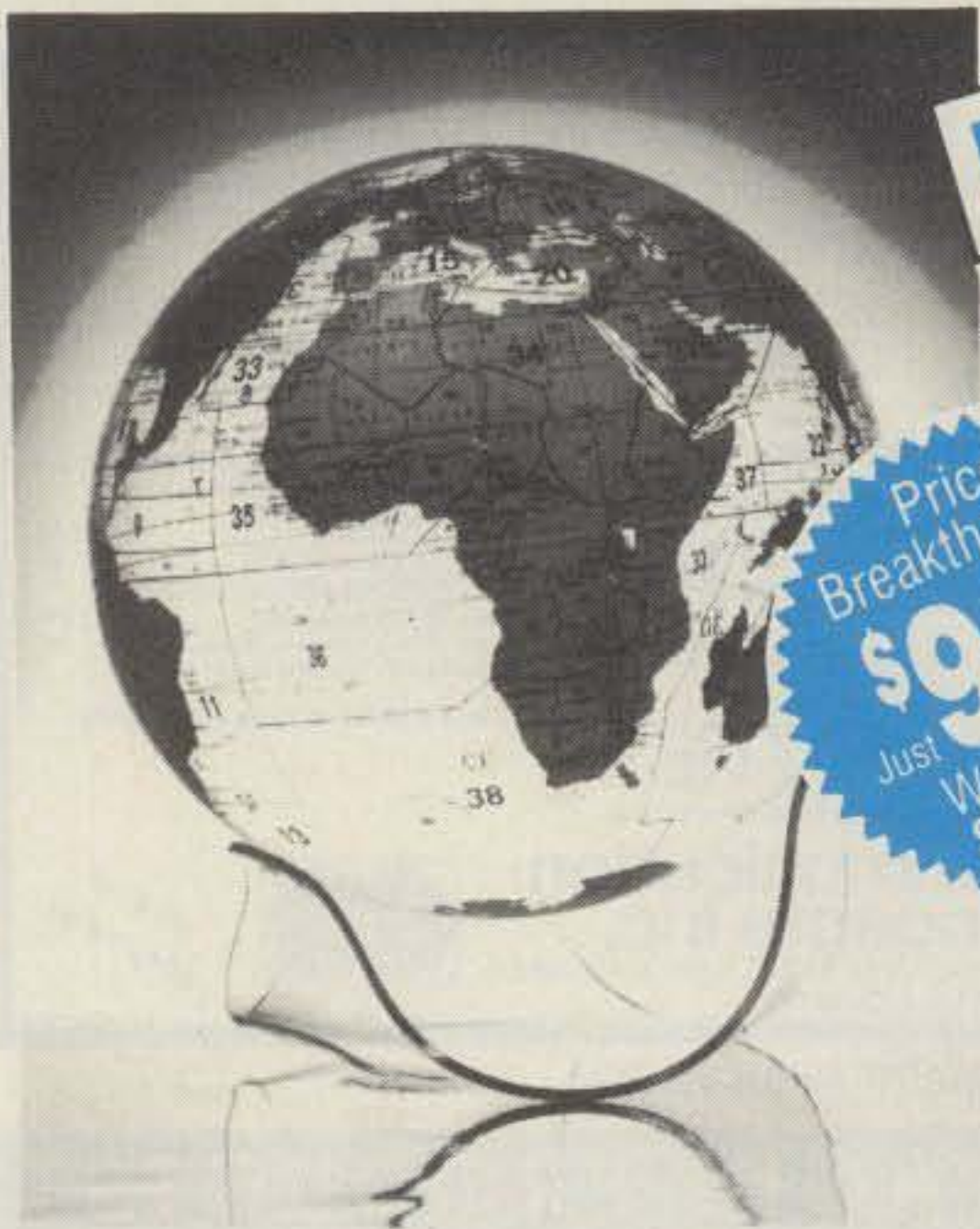

**NEW!** FOR THE FIRST TIME EVER...  
THE AZIMUTH  
World RadioSphere<sup>SM</sup>

Price Breakthrough!  
**\$99.95** PLUS S&H  
Just Was \$199.95!  
Save \$200!

Model ARS-1  
A Crystal Acrylic World Globe With All Zones & Radio Prefixes Shown By Country!

**NOW—YOU CAN SEE THE WORLD OF AMATEUR RADIO. VISUALIZE HOW YOUR SIGNALS SKIP AROUND THE EARTH!** A practical and decorative addition to your shack! This superb, hand-blown 12" clear acrylic world globe shows—DX radio prefixes, world radio zones, latitude & longitude, the International Date Line, cities, countries & much, much more. The first of its kind. An accurate working globe. And it's American made with over 40 hand-crafted steps. Hi-tech & hi-quality!

**A "SEE-THRU" GLOBE WITH BEAUTIFUL COLORS.** Gray land masses, clear oceans, bright red radio prefixes (325+) & 40 zones, with black nomenclature for countries & cities. Incredible quality. It's almost art! Sure to fascinate for years to come.

**A GREAT GIFT, NEVER AVAILABLE BEFORE!** Perfect for every shack. And Discerning DXers & radio enthusiasts alike will love it. The handsome acrylic base shows off your RadioSphere<sup>SM</sup> and it appears to virtually float over your desk. Your XYL will love it too!

**MARK YOUR SIGNAL PATH RIGHT ON THE RadioSphere!** Unlike opaque globes, you can use the white wax pencil (provided) to track the distances from your QTH to the DX. Then rub it off and start fresh. All graphics sealed & protected inside.

**HURRY! WE ONLY HAVE A LIMITED QUANTITY AVAILABLE FOR THE SEASON!** Don't be disappointed. **ACT NOW & Order TODAY. SATISFACTION GUARANTEED.** (Model ARS1) AZIMUTH World RadioSphere<sup>SM</sup> Just \$99.95 (\$6.95 S&H) Also

Available at HENRY RADIO, ALL HAM RADIO OUTLETS (Foreign orders please inquire for Shipping & Handling) And A. E. S. STORES

Call or Send For Your Azimuth World RadioSphere Today!

**Credit Card Orders Call Today Toll Free**  
Nationwide **1-800-882-7388** HR2  
(9AM to 6PM PST) Made in USA  
Allow 4 to 6 Weeks Delivery  
© MCMLXXXIX Azimuth Communications Corporation

SEND TO: Azimuth Communications Corp. Dept. 9C  
3612 Alta Vista, Santa Rosa, CA 95409 USA  
1-707-577-8007 for information or FAX 1-707-573-1482

CIRCLE 113 ON READER SERVICE CARD

**CABLE TV CONVERTERS**  
Why Pay A High Monthly Fee? Save \$100's A Year

- All Jerrold, Oak, Hamlin, Zenith, Scientific Atlanta, and more.
- 60 Day Money Back Guarantee
- Shipment within 24 hours
- Visa/MC and C.O.D.

**WE WILL BEAT ANYONE'S PRICE**  
No Illinois Orders Accepted

**Electronic Engineering**  
P.O. Box 337, Barrington, IL 60011  
Free catalog 1-800-542-9425 Information 1-708-540-1106

**Quality Microwave TV Antennas**

**WIRELESS CABLE - IFTS - MMDS - Amateur TV**  
Ultra High Gain 50db(+) • Tuneable 1.9 to 2.7 Ghz.

- 36-Channel System Complete \$149.95
- 12-Channel System Complete \$114.95
- Call or write (SASE) for "FREE" Catalog

**PHILLIPS-TECH ELECTRONICS**  
P.O. Box 8533 • Scottsdale, AZ 85252  
(602) 947-7700 (\$3.00 Credit all phone orders)  
MasterCard • Visa • COD's • Quantity Pricing

LIFETIME WARRANTY

CIRCLE 165 ON READER SERVICE CARD

**SMILE... YOU'RE NOT ON TV...**  
CALL 1-800-KILL-TV!  
TO ORDER  
**RFI FILTERS THAT REALLY WORK**  
BX-2S Screws On to tv/vcr input  
Now used by FCC during investigations

TP-12      KW-1      BX-2P

The World Famous BX cable-TV filter... \$24.95  
TP-12 Effective standard telephone filter. 18.95  
KW-1 Pure AC output line filter... 42.95

30 DAY RETURN—FOR—REFUND GUARANTEE

Replace Unfilterable Electronic Telephones With Our NEW TP-XL Filtered Touch-Tone Telephone \$42.95.  
TP-XL + 12 For Full Quieting With Linear Amp \$59.95.

800 number for orders only...  
For engineering help, (512) 656-3635  
Tom Coffee, W4PSC (R & D Eng.)

**TCE LABORATORIES**  
5818 Sun Ridge  
San Antonio, Texas 78247  
DEALER INQUIRIES ARE NOW INVITED

CIRCLE 134 ON READER SERVICE CARD

**Aries-2**  
Amateur Radio Integrated Entry System

FOR IBM & COMPATIBLES - \$89.95 (+ Shipping)

- Logging / Terminal / RC / Contest program (simultaneously)
- Fully supports KAM, PK-232 and interfaces with other TUs
- Reads and controls Icom, Kenwood, Ten-Tec, Yaesu Xcvrs\*
- Automatically inserts Freq. / Mode / Date / Time into Log
- Allows mouse / keyboard control of Xcvr and KAM / PK-232
- Search Log by any field including Remarks
- Log entries per file limited only by storage (Hard disk recm.)
- Scrollable QSO buffer > Selectable disk capture
- Sort and Print logs by Date, Prefix, Country > QSL labels
- Run other programs or DOS from within Aries-2
- User definable colors for all foreground / background
- Dupe checking, logging, Radio Control during digital QSOs
- Scan Radio based on Log search. Change freq, mode, VFO, TU mode, etc. with mouse or keypress. (MPG's interface required)\*

Note: Aries-1 available for \$64.95 + Shipping

MasterCard      Submit Call Sign with order      VISA

**ash-ton**  
PO Box 830 - Dandridge, TN 37725 - (615-397-0742)

CIRCLE 24 ON READER SERVICE CARD

**QUALITY QSL'S AT A QUALITY PRICE:** For Samples send \$1.00 (refundable with order) to S & S Printing, P.O. Box 843, Cabot, Arkansas 72023.

**\$2.50 WORLD BEAM HEADINGS** 150 U.S. city selection with \$6.95 DX ATLAS purchase. 630 Countries and Islands listings; prefixes, zones, times, DXCC, QTH/QSL info. Free Cities list. **AMATEUR DX BLUE BOOK**, 4920 Mayflower St., Cocoa, FL 32927.

**Contest Code** is your ticket to CW Contesting and DXing! This powerful series of **hypnosis cassette tapes** teaches you to copy the essentials for working DX and contests. Code recognition is conditioned at 30/40 WPM on the **High Speed** cassette and at 50/60 WPM on the **Ultra High Speed** cassette. In no time at all, you will be slugging it out with the best of them! **Subliminals** boost your speed. Only \$14.95 each ppd. in US (specify which program you want) or \$27.95 for both. (NY residents add 7.5% sales tax.) **PASS Publishing**, Box 570, Stony Brook, NY 11790.

**WANTED:** IBM-PC or clone and packet equipment for the Russian amateur emergency radio service. Tax-deductible donation to The International Amateur Radio Network. Dave Larsen, P.O. Box 341, Floyd, VA 24091 (703-763-3311/382-4458).

**HOME BREW PROJECTS LISTS:** SASE to WB2EUF, P.O. Box 708, East Hampton, NY 11937.

**TELEGRAPH BUGS,** keys, keyers sought by private collector. Most military examples, modern paddles, paddle/key sets, non-Vibroplex bugs needed. Vintage amateur station (1930-1965) sought for collection. John Hensley, WJ5J, 5054 Holloway Avenue, Baton Rouge, Louisiana 70808 (504-928-2559).

**HAM RADIO KITS & ASSEMBLIES** for various QST & 73 Construction Articles. For catalog, send legal-size SASE w/45 cents postage to A&A Engineering, 2521 W. LaPalma #K, Anaheim, CA 92801.

**COLLECT KEYS?** You'll enjoy W1IMQ's illustrated references. "Introduction to Key Collecting," 64 pages, \$9.95. "Vibroplex Collector's Guide," 87 pages, \$14.95. Add \$2.00 s/h to total. Artifax Books, Box 88-C, Maynard, MA 01754.

**DESCRAMBLERS:** OAK M35B, \$39.95. Also JERROLD, ZENITH, SCIENTIFIC ATLANTA, etc. Guaranteed. Cable Plus, 14417 Chase #481, Panorama City, CA 91402 (1-800-822-9955).

**CW? No Problem.** You can increase your speed, no matter how many times you've failed before. **Results guaranteed** when you follow the instructions. PASS Publishing's **CW Mental-Block Buster** program helps you **explode mental blocks** that hold you back. Based on 40 years of research, the **CW Mental-Block Buster** uses guided meditation, dynamic visualizations, and powerful affirmations to blast through mental blocks. **You can do code!** That means new bands, more contacts, more fun! (This is not a CW practice tape.) The **CW Mental-Block Buster** audio cassette and practice booklet are only \$24.95 ppd. in the US (NY residents add \$1.87 sales tax). (Quantity discounts available for classes.) PASS Publishing, P.O. Box 570, Stony Brook, NY 11790.

**BATTERY PACK REBUILDING:** Send Your Pack/48HR Service. ICOM: BP2/BP3/BP22 \$19.95, BP5 \$25.95, BP7/BP8 \$32.95, BP70 \$29.95. KENWOOD: PB21 \$15.95, PB21H \$21.95, PB25/26 \$24.95. YAESU: FNB9 \$19.95, FNB10 \$23.95, FNB11 \$27.95, FNB4/4A \$36.95. "U-DO-IT INSERTS" ICOM: BP2 \$17.50, BP3 \$16.95, BP5 \$22.95, BP7/8 \$27.50, BP22 \$17.95, BP70 \$25.95. KENWOOD: PB21 \$12.95, PB21H \$18.95, PB24/25/26 \$19.95. TEMPO: S1/2/4/15 \$22.95. YAESU: FNB9 \$16.95, FNB10 \$18.95, FNB4/4A \$32.95. AZDEN: \$19.95. "NEW PACKS W/CASE" ICOM: BP5 or BP8B (Base Chg Only) \$39.95. YAESU: FNB2 \$19.95, FNB12 \$44.50. SANTEC: 142/1200 \$22.95. FREE CATALOG. \$3.00 shipping/order, PA plus 6%, VISA-M/C add \$2.00. CUNARD, R.D. 6 Box 104, Bedford, PA 15522 (814-623-7000).

**THE DX BULLETIN** is your premier weekly source of all DX information: DXpeditions, propagation, QSL routes, and much more. SASE or call for samples. Box 50-C, Fulton, CA 95439 (707-523-1001).

**YOUR CALL ON A COFFEE MUG.** Black imprint on a white mug. \$9.50 plus \$2.50 S&H. Shipped UPS. THE BUTTON MAN CO., 130 Shrewsbury Ave., Red Bank, NJ 07701 (201-530-9191).

**AUTOMATIC TRANSMITTER SWITCHING:** Receives on both, transmits on either. A must for the radio enthusiast. Schematic and parts list (Radio Shack part numbers). Send \$5.00 to Jack Fisher, P.O. Box 612-A, Oceano, CA 93445.

**GROUND RADIAL MOUNTING PLATE:** HF vertical antennas need radials! The GP-1 system makes the installation quick and easy at only \$27.95 postpaid. Lance Johnson Engineering, P.O. Box 1047, Elizabeth, CO 80107.

**PRINTED CIRCUIT BOARDS:** Production and prototypes, engineering artwork. Over 20 years experience. Single sided, Plated thru holes. Supplies also available. K&K Electronics, 170 E. Market St., Alliance, OH 44601 (216-821-6478, Fax 216-821-6380).

**KANSAS CITY KEYS:** Our fall production run will be completed very shortly. Send us a postcard and we will send you our latest literature. Complete systems start at \$249.95 plus shipping. Lance Johnson Engineering, P.O. Box 1047, Elizabeth, CO 80107.

**"HAMLOG" COMPUTER PROGRAM:** Full features. 18 modules. Auto-logs, 7-band WAS/DXCC. Apple, IBM, CP/M, Kaypro, C128, \$24.95. CQ-KA1AWH, PB 2015, Peabody, MA 01960.

**SUPER QTH FOR DX-CONTESTING-FISHING.** Former WM5G Contest Station near Athens, Texas, 28 acres, mostly wooded with large 12 acre lake stocked with Florida Bass and Catfish. Beautiful 4 BR, 4 bath house rebuilt in 1986. Separate large radio rooms with special air-conditioning/venting system. Large workshop area, boathouse, many improvements. Includes 128 foot rotating "Big Bertha" Pole plus 110 foot 25G tower plus bases and anchors for 7 more towers up to 180 feet tall. Large amount of buried coaxial cable, rotor, and control cable in ground. Eight beverage antennas for receiving. Priced to sell at \$275,000. Call for brochure. Jim Tucker, WM5G, at 800-527-4642 or 214-348-8800.

**CABLE T.V. CONVERTERS:** Jerrold™, Oak, Scientific Atlantic, Zenith and many others. "New" MTS stereo add-on, mute & volume. Ideal for 400 & 450 owners! Call 1-800-826-7623. B & B INC., 4030 Beau-D-Rue Drive, Eagan, MN 55122.

**COMMODORE-128 PROGRAM** Amateur Satellite tracking program uses Keplerian data supplied by NASA free. Tracks up to 8 satellites simultaneously. Program supports printing schedules, modes, and predictions for satellites. SATRAK128 V1.1, \$26.50 includes shipping. Other information on this or other programs for the C128 requires a business-size SASE. Reid Bristol, WA4UPD, P.O. Box 0773, Dept. CQ, Melbourne, FL 32936-0773.

**COMMODORE 64 HAM PROGRAMS:** 8 disk sides, over 200 Ham programs, \$16.95. 25¢ stamp gets unusual software catalog of Utilities, Games, Adult and British Disks. Home-Spun Software, Box 1064-AR, Estero, FL 33928.

**Morse code got you down?** Why let a mental block stand between you and upgrading? Use PASS Publishing's **CW Mental-Block Buster** to blast through those barriers. Just follow the instructions for 30 days—**Results Guaranteed!** Based on 40 years of research, the **CW Mental-Block Buster** uses guided meditation, dynamic visualizations, and powerful affirmations to blast through mental blocks. **You can do code!** That means new bands, more contacts, more fun! (This is not a CW practice tape.) The **CW Mental-Block Buster** audio cassette and practice booklet are only \$24.95 ppd. in the US (NY residents add \$1.87 sales tax). (Quantity discounts available for classes.) PASS Publishing, P.O. Box 570, Stony Brook, NY 11790.

**FREE CATALOG:** Save hundreds on sought-after electronic, electro mechanical, and computer related hardware and components—including hard-to-find items. Call toll free: 1-800-776-3700. American Design Components/Dept. 110-110, 815 Fairview Avenue, Fairview, NJ 07022.

**HR 2510 MODIFICATIONS:** Frequency, RF Power, SSB Overdrive Cures, Roger Beep, Modulation, Power Mic Wiring. Send \$10 to Jack Fisher, P.O. Box 612-A, Oceano, CA 93445.

**1380 DX CERTIFICATES** from 113 countries described in K1BV's comprehensive Directory. \$16.10. Ted Melinosky, 525 Foster Street, South Windsor, CT 06074-2936.

**SPECTRUM ANALYZER, STS-07, 25-900 MHz, USED.** Will display on most scopes. New \$1,200 (CDN). OFFERS? B. Maguire, 7689 Drolet St., Montreal, Que. H2R 2C6, Canada (514-276-8467).

**AFRAID OF FCC TESTS?** Let your C64/128 drill you. All questions on 5 1/4 inch disk. With instructions. Full screen diagrams if used. Your call on screen and on optional printed summary. Tech or General \$19.95. Advanced or Extra \$24.95. Ppd. Ralph Parlette, WB6JOY, 27 Morning Sun, Mill Valley, CA 94941 (415-383-0507).

**SCARA INDOOR Flea Market, Sunday Nov. 11,** place North Haven Park and Recreation Center, 7 Linsley St., North Haven, Connecticut. Sellers 7 AM, Buyers 9 AM. Tables \$15 advance, \$20 door. Admission \$3. Talk-in 146.01/61. Reservations no later than Nov. 1. None by phone. Info or reservations SASE: SCARA, Box 81, North Haven, CT 06473. Info call Brad 7-10 PM, 203-265-6478.

**WANTED:** Digital freq. readout for Tempo-One Xceiver. J. Spink, W0PLX, 301-250-5791.

**YOU CAN BE AN AUTHOR** for The Blacksburg Group. Chapter or whole book on Amateur radio topics. David Larsen, KK4WW, Blacksburg, VA 24063-0001 (703-763-3311).

Authorized **AMEGA & COMMODORE** Service Center. Send SASE for price list. CALLENDER ELECTRONICS, P.O. Box 363, Bakerstown, PA 15007.

**TOWER FOR SALE:** 65 feet, \$450. Contact 1032 Rahway Ave., Westfield, NJ, phone 201-233-7358.

## AZIMUTH WEATHER STAR

Reads Wind Speed (MPH/KPH) • Hi Gusts • Wind Direction • Rainfall Temperature (Present-Hi-Low) • Wind Chill • Scans All!

Only 2 Payments of **\$94.98** with our NEW Plan for Credit Card Buyers. Plus **FREE BONUS** CALL TODAY! Our Azimuth DualZone 24 Hr Station Clock Retail Value \$29.95. **ACT NOW! SEND TODAY!**

Plus S&H & Accessories on Payment 1

OPTIONAL Rain Gauge just \$24.95

Your **SPECIAL FREE BONUS** Order TODAY!

## A Power-Packed Micro Weather Computer for Your Station... by DIGITAR

**THOUSANDS IN SERVICE WORLD WIDE!** Protect your antenna & home. Our WX computer is loaded. All the facts at your finger tips. Model TWR3—HANDY & COMPACT 2 1/2" x 2 1/2" x 1 1/2"—LARGE, EASY TO READ LCD READOUT Shows Wind Direction (2/10 deg) • Wind Speed • Records Hi Gusts • Outside Temp (F/C) • Hi/Lo Temp Record • Wind Chill • Time/Date • Scans all! Operates on DC/AC (Nicads & AC Adaptor Optional) • Tracks Rainfall (Daily/Annual) w/ Self-Dumping Rain Collector (Optional).

**SYSTEM COMES COMPLETE WITH** WeatherStar Computer (TWR3), Anemometer & Wind Vane, 40 ft. cable & connectors, Outside Temp Sensor (25') & Mounting Hardware. Just \$189.96

**OPTIONS INCLUDE—**Stainless **Desk Stand** (DSK22) \$9.95, Recharge **NiCad Pack** (BP3) \$7.95, **Extension Cable** (40 Ft) (EC40) \$14.95, **AG Power Adaptor** (PS12) \$9.95 • Shipping/Hdng Add \$7.50. TWR3 & \$1.95 per Option. Foreign orders—please ask for shipping costs.

## THE NEW AZIMUTH AWARDS QSL LIBRARY

New Handsome **AZIMUTH** Custom Albums To Collect, Protect & Organize Your Hard-Earned QSL Cards... Plus Special Albums for DXCC, WAS/WAC, & WAZ Radio Awards

Organize your QSL cards by award! Easy browsing. Great protection. Albums of tough, dark blue vinyl with 20 crystal-clear pocket pages. Pages hold 6, 4"x6" cards. Add extra pages—250+ cards/album. Specify **DXCC • WAZ • WAS/WAC • Standard QSL Album**. Each just \$19.95 plus \$2.50 S&H. Extra 20 **Page Packs** (EP20) just \$12.95 (\$2.50 S&H). (Foreign S&H—PPost 2X S&H, AirPP 6.1 S&H)

**BUY 2 ALBUMS & GET 20 PAGES FREE!** (SAVE \$12.95)

Special Introductory Offer Just **\$19.95** Per Library

Made in USA

**AZIMUTH World RadioSphere** Model ARS-1 First Ever!

A Crystal Clear Acrylic World Globe With All Zones & Radio Prefixes Shown By Country! Own the world of ham radio! Superb, 12" hand-blown clear acrylic world globe shows—DX radio prefixes (325+), 40 zones, lat & long, Intl Date Line, cities, countries & more. Beautiful—Gray land, clear oceans, red radio info & black nomenclature. Floats above your desk on stand. Mark your radio path around the world & wipe clean (pencil incl). Graphics sealed inside. Incredible American quality. A great gift! World RadioSphere (ARS1) Just \$99.95 (\$6.95 S&H). SAVE Order 2—Just \$189.90 (\$13.90 S&H)

**Credit Card Orders Call Today Toll Free Nationwide 1-800-882-7388** (9AM to 6PM PST) FAX 707-573-1482 Other Info 707-577-8007 Satisfaction Guaranteed! 14-Days or Your Money-Back-If Not Delighted! Allow 2 to 6 Weeks Delivery • **ACT NOW! CALL or SEND TODAY!**

Check, Money-Order, VISA or MASTERCARD Accepted (Cal. Res add 6.75% sales tax)

Azimuth Communications Corp. Dept. 9C 3612 Alta Vista, Santa Rosa 95409 USA © MCMLXXX Foreign orders quoted.

**Azimuth Products Available at Henry Radio, AES & All Ham Radio Outlets!**

CIRCLE 169 ON READER SERVICE CARD

**THE PSOTRON** COMPACT ANTENNAS FROM 160-10 METERS

NO TUNERS!  
NO RADIALS!  
NO RESISTORS!  
NO COMPROMISE!

FOUR EXCELLENT REVIEWS JUST DON'T HAPPEN BY CHANCE CALL US FOR A FREE CATALOGUE.

\*See review in Oct. 73, 1984 \*Sept. 73, 1985 March 73, 1986 CQ, Dec. 1988

**BILAL COMPANY**  
137 Manchester Drive  
Florissant, Colorado 80816  
(719) 687-0650

CIRCLE 132 ON READER SERVICE CARD

**CQ WW DX CONTEST PROGRAM**

Log-type format. Easy and quick. You type the call, program does the rest. Inserts time. Keeps checklist. Shows new prefixes, score matrix, rate. Fast machine language. MS-DOS\*. Prints log including disk to submit, dupe sheet, QSL labels. Also CQ WPX and ARRL DX. \$39.95 each incl. postage.

MS DOS is a registered trademark of Micro Soft Corp.

**Jack L. Schultz, W2GGE**  
2 Huxley Drive, Huntington, NY 11743

**FREE SAMPLE COPY!**

**ANTIQUE RADIO CLASSIFIED**

Antique Radio's Largest-Circulation Monthly Magazine

Articles - Classifieds - Ads for Parts & Services Also: Early TV, Ham Equip., Books, Telegraph, 40's & 50's Radios & more...

Free 20-word ad each month. Don't miss out! Free Sample. 6-Month Trial - \$13. 1-Year: \$24 (\$36 by 1st Class). Foreign - Write. A.R.C., P.O. Box 802-C9, Carlisle, MA 01741

CIRCLE 21 ON READER SERVICE CARD

**Digital Voice Message Recorder/Announcer**

**ONLY 159.95**  
4.00 S/H

Instantly Xmit Your Natural Voice Messages With A Push Of A Button • Contesting • Call CQ • Off Air Recording • Working DX • Identifying • Speaker • Auto PTT Keying • AUX In/Out Jacks • DC Adaptor Included

**CALL TOLL FREE 1-800-736-3960**

**DIGITECH CONCEPTS**  
200 W. Main • Roberts, WI 54023  
(715) 749-3960

CIRCLE 119 ON READER SERVICE CARD

## Introducing OPTO Iambic Deluxe Keyer With Exclusive Switchable Dual Rig Capability!



**Suggested  
Retail  
Price  
\$84.95**

This full function Iambic Keyer has a defeatable sidetone and the exclusive Ace Systems dual rig switching feature built-in. All outputs are MOV protected.

Seven CMOS devices afford the low power consumption and noise immunity. RFI suppression, reverse polarity protection and a front panel TUNE switch round out the needs of today's amateurs.

Measuring only 6.1"W x 6.3"D x 2.5"H the OPTO Iambic Deluxe keyer is a welcome addition to any shack.

**Exclusive 1 Year Zero Customer  
Cost Warranty**

Contact Your Dealer Or Call Direct

*Ace Systems*

RD 1 • Box 83 • Wilcox, PA 15870 (814) 965-5937

CIRCLE 20 ON READER SERVICE CARD

## Where's the Beam?

There's a 20 meter DX HalfSquare slung between this tree and the peak of the roof. Ten and 15 meter HalfSquares hang under the eaves of the house. The neighbors haven't noticed. But the DX hears me anyway. That's nice. My HalfSquares are heard, not seen. They work DX without a tower, without an amplifier, and without telling the neighbors. When you order add \$5 P&H.

10 M	15 M	20 M	40 M
\$39.95	\$44.95	\$49.95	\$69.95

**Antennas West** Order Hot Lines  
Box 50062-B, Provo, UT 84605 800-926-7373  
Build your own from scratch with TechNote #122A \$5.95 ppd USA.

CIRCLE 11 ON READER SERVICE CARD

THIS MONTH'S GOODIE FROM THE CANDY STORE

**RDC** **KENWOOD TS-440S**  
**UNDER \$1090.00**

Similar Savings On Kenwood, Astron, Yaesu, Hy-Gain, Alinco, Etc. All L.T.O.  
MFJ 949D \$134.90

Over 9034 Ham Items in Stock, all Prices Cash FOB Preston. More Specials in HAM-ADS. Looking for Something not Listed? Call or Write  
**ROSS DISTRIBUTING COMPANY**  
78 S. State Street, Preston, Id. 83263 - Telephone (208) 852-0830  
Hours Tue-Fri. 9-5 - 9-2 Mondays. Closed Sat. & Sun.

## BLACK DACRON® POLYESTER ANTENNA ROPE

- UV-PROTECTED
- HIGH ABRASION RESISTANCE
- REQUIRES NO EXPENSIVE POTTING HEADS
- EASY TO TIE & UNTIE KNOTS
- EASY TO CUT WITH OUR HOT KNIFE
- SIZES: 3/32" 3/16" 5/16"
- SATISFIED CUSTOMERS DECLARE EXCELLENCE THROUGHOUT U.S.A.

LET US INTRODUCE OUR DACRON® ROPE TO YOU • SEND YOUR NAME AND ADDRESS AND WE'LL SEND YOU FREE SAMPLES OF EACH SIZE AND COMPLETE ORDERING INFORMATION.

Dealer Inquiries Invited

MANUFACTURED BY **synthetic textiles, inc.** 2472 EASTMAN AVE., BUILDING 21 VENTURA, CALIFORNIA 93003 (805) 658-7903

CIRCLE 153 ON READER SERVICE CARD

130 • CQ • November 1990

## C.A.T.S.

Rotors, Parts and Repair Service  
Reconditioning Large or Small  
American Made Rotors



Repairs-\$15.00\*  
Rebuilds-\$35.00\*

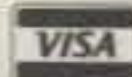

All parts in stock for immediate delivery.  
New units for sale. Trade-ins welcome.

## C.A.T.S.

7368 S.R. 105 Pemberville, OH 43450  
Call N8DJB at (419) 352-4465 10:00-5:00

\*LABOR ONLY-PARTS & SHIPPING ADDITIONAL

## HI-VOLTAGE RECTIFIERS SUPER FOR HIGH POWER LINEARS REPLACES 866-872-3B28 ETC.

8,000 VOLTS  
1 AMPERE

4-\$30.00  
POSTPAID U.S.-CAN.



14,000 VOLTS  
1 AMPERE

4-\$40.00  
POSTPAID U.S.-CAN.

## K2AW's "SILICON ALLEY"

175 FRIENDS LANE, WESTBURY, NY 11590 516-334-7024

## YAGI OPTIMIZER \$65

YOjr has everything you need to design and optimize HF or VHF Yagis with up to 10 elements. YOjr automatically maximizes forward gain and F/B, and minimizes SWR. You may choose the tradeoff among these 3 factors. YOjr models tapered elements, optimizes simultaneously at 3 frequencies across a band for broadband designs, and can scale any design to a new band. Polar patterns are displayed and printed. YOjr is extremely fast, and can compute several trial designs per second. YOjr is intuitive, graphical, and interactive. 8087 and extra-fast no-8087 versions both included. YOjr 1.0, \$65. Full credit toward YO 3.0, with much more, \$130. Add 6.25% CA, \$5 overseas. U.S. check, cash, or money order. For IBM PC, 5.25" or 3.5" disk.  
Brian Beezley, K6STI, 507-1/2 Taylor, Vista, CA 92084

## Omar Electronics Inc.

Rt. 1 Hwy. 81 South  
Loganville, GA 30249

(404) 466-3241

Omar  
W8FON

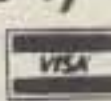

Marc  
N4YHM

AEA  
Alinco  
Ameritron  
Pro-Am

MFJ  
Kenwood  
Yaesu  
Uniden

ARRL  
Bencher  
ICOM  
Van Gorden

## CB-TO-10 METERS

We specialize in CB radio modification plans and hardware. Frequency and FM conversion kits, repair books, plans, high-performance accessories. Thousands of satisfied customers since 1976! Catalog \$2.

**CBC INTERNATIONAL**

LOU FRANKLIN/K6NH - Owner

P.O. BOX 31500CQ, PHOENIX, AZ 85046

## SOMMER

### TRAPLESS BEAMS

SOMMER-ANTENNAS

P.O. Box 847

Cowpens, SC 29330

(803) 463-9514

**HAM RADIO REPAIR CENTER**, quality workmanship. Solid state or tube, all makes and models. Also repair HF amplifiers. A-Z Electronic Repair, 3638 E. Indian School Rd., Phoenix, AZ 85018 (602-956-3024).

**ROTOR BRAKE DELAY**: Delay your HAM-II, HAM-III, HAM-IV, and Tailtwister rotor braking by five seconds automatically with the easy-to-install D-Lay-5, \$26.95 postpaid. Lance Johnson Engineering, P.O. Box 1047, Elizabeth, CO 80107.

**Ten-Tec**: New boxed latest 1990 production models. USA made, 562 Omni V, 585 Paragon, 535 Argonaut, 536 Delta Transceivers; Titan 425, Hercules 420, Centurion 422 Linear Amplifiers; Antenna tuners 238, 253, 254; Dry Dummy Loads 239, 240; Mobile HF Antennas; Keyers; Cabinets; Filters and Accessories. VISA/MC or check. For best mail-order deal, write/phone Bill Slep, 704-524-7519, Slep Electronics Company, Highway 441, Otto, NC 28763.

YAESU FR101 digital receiver, FM and 2 meter converters and external speaker, FL101 transmitter with microphone and two extra sets of tubes. Complete with manuals. Excellent condition \$625. Mosley TA33 beam, good condition \$75. Pick up only. K0USC, days 316-662-9301, after 4 PM 316-663-2998.

ROSS' \$\$\$\$ USED November (ONLY) SPECIALS: KENWOOD TS-120S \$439.90, TS-130S \$539.90, TV-602 \$229.90, TH-25AT \$229.90, TH-45AT \$219.90, SM-220 w/BS8 \$459.90, TH-2500 (as is) \$109.90, ICOM IC-781 \$4,559.90, IC-761 \$1,699.90, IC-730 \$539.90, PS-15 \$122.90, AT-100 \$249.90, YAESU FT-727R \$279.90, FT-225RD \$589.90, PA-3 \$25.90, COLLINS 30L-1 (round) \$999.90, 75A-4 w/FF455J-08, FF455J-31 (like new with original box) \$999.90. Looking for something not listed? Call or send SASE. Have over 190 used items in stock. MENTION AD. Prices cash, FOB Preston. Hours Tuesday-Friday 9:00 to 6:00, 9:00 to 2:00 PM Mondays. Closed Saturday & Sunday. ROSS DISTRIBUTING COMPANY, 78 South State, Preston, Idaho 83263 (208-852-0830).

SALE! Collins RT-671/PRC-47, R-148/ARC, .19-55 MHz, T-20/ARC-5, 4-5.3 MHz. Call after 5 PM Central (915-387-2644).

DELTA LOOP TYPE ANTENNA 10-15-20 meters, \$235.00. Lightning Bolt Antennas, RD 2 Rt. 19, Volant, PA 16156 (412-530-7396).

**AMIGA, MACINTOSH, ATARI XL/XE/ST** Amateur Radio PD software \$4.00 disk. Two-stamp SASE brings catalog. Specify computer! Kinetic Designs Hamware, Box 1646, Orange Park, FL 32067-1646.

**STRONGER SIGNAL! CLEARER, NOISE-FREE RECEPTION! INTERFERENCE PROBLEMS SOLVED!** Proven Methods! Illustrated Manual \$5.00 ppd. KB4UGW, POB 581-c, Leeds, AL 35094-0581.

TOWER FOR SALE: 54 foot Telescoping Steel, \$750 complete. Currently dismantled; you pick up. W1GYD, 6 Ox Pasture, Winchester, MA 01890, call 617-729-6052.

ICOM AT100 FOR SALE. Excellent condition, \$175 plus shipping. Call 817-592-5315 after 6 PM. Ask for Bert (KA5NUI).

**WANTED: AIRPAX #K81352-P3-52** tuning motor for Cushcraft R3 vertical antenna, or information on a usable substitute motor. Karl Thurber, W8FX, 317 Poplar Drive, Millbrook, AL 36054 (phone 205-285-7576).

**CASIO World Time/Thermometer Watch**, Men's, Black, Digital, 12/24 hour, 5 Alarms, Stopwatch, Timer, 100M, 3-Year Battery. Send \$49 to: Ricky N. Gomez, Dept. CQ11, P.O. Box 286, Bronx, NY 10463-0286.

ROSS' \$\$\$\$ New November (ONLY) SPECIALS: J.S.C. RG-213 500 ft. \$150.00, KENWOOD TM-631A \$629.90, TS-711A \$889.90, TM-241A \$394.90, TS-790A \$1659.90, TS-811A \$1039.90, TS-440S \$1049.90, TS-440S/WAT \$1209.90, TM-731A \$625.90, TM-411A \$339.99, TM-701A \$464.90, ICOM IC-765 \$2439.90 (open box), IC-781 \$5119.90, IC-24AT \$534.90, IC-735 \$934.90, IC-2SA \$289.90, IC-490A \$590.90, IC-701 \$589.90, YAESU FT-747GX \$709.90, FT-757GXII \$1019.90, FT-703RTT \$264.90, FT-709R \$289.99, FT-33R \$259.90, FT-470 \$394.90, FT-411E \$329.90, TEN-TEC 562 \$1819.90, 961 \$224.90, 222 \$29.90, 425 \$2,699.90. All L.T.O. (Limited Time Offer). Looking for something not listed? Call or write. Over 9004 ham-related items in stock for immediate shipment. Mention ad. Prices cash, FOB Preston. Hours Tuesday-Friday 9:00 to 6:00, 9:00 to 2:00 PM Mondays. Closed Saturday and Sunday. ROSS DISTRIBUTING COMPANY, 78 South State, Preston, Idaho 83263 (208-852-0830).

FM TRANSMITTER RADIO: Easy to build, complete plans and instructions on circuits components and antenna, output power 5 watts, maximum current 1A. This type must be licensed. Price \$50. Order: Claude Val, VE2VAL, 11920 Rodolphe Forget, 8 Montreal, Canada H1E 4Y1.

SELL: Rare, complete 74 years QST collection from issue one. Minimum offer \$3,000. K6IR, 16904 George Washington, Rockville, Maryland 20853-1128 (301-774-7709).

COLLINS NEW TUBE SETS: KWM2 \$95 less finals, 75S3 \$65, 32S3 \$60 less finals, 75A4 \$85. Bob, WE2T, 716-334-1103.

Say You Saw It In CQ



HELP ME COMPLETE MY COLLECTION. XMTRS WANTED: Viking Navigator, Knightkit T-400, Lafayette Voyager, Starflite, WRL CW-7, Philmore NT200, Globe Chief 90, Int. Xtal Co. AOT-50, ET-1 CW, ERL Excello, Matric QRP 50 (Has anyone ever seen one?), Kantronics Rockhound, Walter Ashe Wat25, and Heath HA-14 Amp, Ameco PS3 AC supply, Philmore CR5A RX. Gary, K3OMI, 11124 Oak Hollow Rd., Knoxville, TN 37932 (615-690-4217 days).

**QRP FUN!** BP-80DX Transceiver Kit. Details: LECTROKIT, 405 W. Bogart, Sandusky, OH 44870.

FOR SALE: R-28/ARC, 5CW Receiver Long Wave AR8503-RCA 15-600 kHz Transmitter type T, 50M 1500-12,000 kHz. Call 201-772-3428.

WANTED: Manual for Lafayette KT-340 receiver. Will pay costs. John, WD1G, 85 North St., No. Reading, MA 01864 (evenings 508-664-3362).

CUNNINGHAM MODEL 50: AM 10-50 watt Radio Transmitter with super modulation! Set to your frequency. \$500.00. Ask for James Cunningham (405-265-4496), P.O. Box 8, Stonewall, OK 74871.

**HIGH PERFORMANCE 2M BEAM:** Dramatically improve your Cushcraft 11-element beam's DIRECTIVITY & GAIN. EASY conversion plans needing no extra parts. Or homebrew 8-element beam from included dimensions. \$10, check or money order: WB9QZB, Dept. CQ, P.O. Box 357, Mount Prospect, IL 60056.

FIVE WATTS! Only nine parts! 30/40 meter transmitter! All parts from Radio Shack! Complete plans \$2.00 plus stamp! Bill Lauterbach, 1709 North West #103, Jackson, MI 49202.

ANTIQUE RADIOS, tubes, wiring diagrams, and literature. For large list send 2 stamps to VRS (CQ), P.O. Box 541, Goffstown, NH 03045.

BE A WRITER AND PUBLISHER: Instructions \$19.95 post paid. Willard Moody Ph.D., 11620 Kemp Mill Road, Silver Spring, MD 20902.

QSLs HIGH QUALITY, low prices. \$1.00 brochure and samples. Don Ellis, K3LOQ, 84C Chapel Drive, Zephyrhills, FL 33544.

**SWISSLOG:** The most popular logging program in Europe is now available in the United States. It features on-line DXCC, WAZ, ITU, and WPX checking. Beam heading, all zones, local time, and distance to QSO partner. Print Logs, QSL cards, and labels. Contest duping, fast input, and report mask. Grid square support. Graphic full-color MUF map presentation shows grayline and path. DXCC statistics, conversion from K1EA, DXLOG, and DBase. Much more. IBM PC, 640K, Hard disk. \$75. KD2LL, Frank, 10 Robbins Ave., Amityville, NY 11701 (516-598-0011).

FOR SALE: TANDY 1000 w/5.25, keyboard, 128K, \$195. RS VM-2 Monitor \$75. George Griebel, WQ4Z, 650 Chestnut Grove, Parksville, KY 40464-9624 (606-236-6510).

HEATH HW101, AC power supply, PS-23, HS1661 speaker, HPD-121A microphone. Complete set of spare tubes. Very clean, \$150. Autek QF1A audio filter mint, \$40. Heath SW717 shortwave receiver, mint, \$25. Above all with manuals plus shipping. WA6HYB, 4660-125 N. River Road, Oceanside, CA 92056, (619-433-4445).

10 YEAR GIANT CLEAROUT SALE: Shack overloaded. Tons of test equipment, microwave, radios, parts, antiques, variacs, more. Big list SASE please. Joseph Cohen, 200 Woodside, Winthrop, MA 02152 (617-846-6312).

COLLINS NEW TUBE SET: KWM2 \$95 less finals, 75S3 \$65, 32S3 \$60 less finals, 75A4 \$85. Bob, WE2T, 716-334-1103.

WANTED: Pen Pals. Hams who are into bluegrass music to swap ideas on music, ham radio. Jim Queen, KB3Y, Box 274, Oxon Hill, MD 20750.

WANTED: Telex headphones TM2 16 ohms like on the cover of June 1990 CQ. WD4NBX, Rt. 1, Box 180M, Lebanon, TN 37087.

SWAN 508 VFO w/internal PS and xtal osc., excellent, \$175 plus UPS. Hal, W8MCH, Five Forks, WV 26145.

WANTED: Yaesu FV-400S Remote VFO for FTdx560/570/400. State price and condition. David, WA5PBZ, 3924 Runge Ct., Irving, TX 75038 (214-252-5030).

SELL: Heathkit HW101, PS, Mike \$200. HO-10 Heath Monitor scope \$40. Drake TR22C 2 meter \$60. Hustler MO-1 40 meter mobile antenna, new, \$35. All with manuals. W4GBG, 5121 N. Carlin Spring Road, Arlington, VA 22203 (703-527-4169).

WOULD LIKE TO correspond and exchange cassette tapes with AM and FM DXers in the state of Texas, in other locations along the Mexican border, and in the Philippines. I'm interested in AM and FM DXing. Please contact David Shapiro, 484 Hammond Dr., Griffin, GA 30223.

SELL: Eimac SK2210 socket, SK2216 chimney for 8877 tube. W3CJI, 2705 Andrea Dr., Allentown, PA 18103 (215-433-4485)

## KENWOOD



**TS-950SD**

TOP SHELF HF TRANSCEIVER

- 150 Watts Output • 100 Memories
- Digital Signal Processing
- Dual Frequency Receive

CALL TODAY!

## KENWOOD

**TH-27A**

COMPACT 2 METER HT

- Receive 118-165 MHz
- 41 Memories
- Large Capacity Standard NiCd
- CTCSS Encode/Decode Built-in
- TH-47A for 70 cm

CALL TODAY!

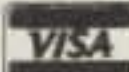

# HAMTRONICS, INC.

4033 Brownsville Road, Trevose, PA 19047

For Service & Info (215) 357-1400 For Orders (800) HAM-2820 FAX 215-355-8958

## KENWOOD



**TM-941A**  
TRI-BAND FM  
TRANSCEIVER

- 5 Watts on 144 MHz
- 35 Watts on 450 MHz
- 10 Watts on 1200 MHz
- Wide Band Receive Coverage
- CTCSS Encode/Decode Built-in
- Detachable Front Panel

CALL TODAY!



**IC-781**

WORLD'S MOST ADVANCED HF

- Multi-Function CRT Display
- Spectrum Scope
- 99 Memories • Built-in Antenna Tuner

CALL TODAY!

M, T, W (9-6)  
Th, F (9-8)  
Sat (9-3)

CIRCLE 12 ON READER SERVICE CARD

## WE BUY HAM GEAR • TOP PRICE

SINGLE PIECE OR  
ENTIRE ESTATES

45 YEARS IN AMATEUR RADIO

IF YOU'RE LOOKING TO SELL OR BUY • SEND \$3 FOR CATALOG AND WHOLESALE LIST

ASSOCIATED RADIO • 913-381-5900

8012 CONSER BOX 4326

OVERLAND PARK, KANSAS 66204

### CW? It's Soooo Easy!

CW Lite is the easiest Morse code training method in the world, bar none! And it is the fastest, too. Just close your eyes and relax. This powerful hypnosis cassette tape does the rest. Subliminals speed you along! Only \$14.95 ppd in US (NY residents add \$1.12 tax). Order today!

PASS Publishing, Box 570, Stony Brook, NY 11790

### U.S. AMATEUR RADIO MAIL LISTS

Labels, floppy disks, CD-ROM, mag tape.

- Newly licensed hams
- All upgrades
- Updated each week

#### BUCKMASTER PUBLISHING

Route 3, Box 56

Mineral, Virginia 23117

703/894-5777 visa/mc 800/282-5628

## DIGITAL METERS



**DMM 2360**

\$129.95

DMM + LCR Meter  
Most Versatile DMM

- Inductance: 1µH - 40H
- Capacitance: 1pF - 40µF
- Temperature: -40 - 302°F
- Frequency: 1Hz - 4MHz
- Logic test: 20MHz
- Diode test
- Continuity beeper
- Volt, current, ohm
- 3999 count display
- Peak hold
- Auto power off



**DMM 175A**

\$79.95

20MHz  
Frequency  
Counter

- Frequency 1 Hz - 20 MHz
- Logic test 20 MHz
- C: 1pF - 20µF
- .1Ω - 2000 MΩ
- Volt, current, continuity
- LED, diode, hFE tests

## ALFA ELECTRONICS

P.O. BOX 8089, PRINCETON, NJ 08543

(800) 526-ALFA / FAX: (609) 275-9536

QUALITY DMM, GOOD RELIABILITY

15 DAY MONEY BACK GUARANTEE

1 YEAR REPLACEMENT WARRANTY

Visa, MasterCard, C.O.D., Purchase Order Welcome

CIRCLE 56 ON READER SERVICE CARD

WD4BUM'S  
**CAROLINA BUG  
KATCHER**

**MOBILE ANTENNA**  
40 to 10 meters  
CAT #CBK - 40

- Combines our famous HAM STICK technology with a very High "Q" air wound coil for unsurpassed efficiency
- Only 7 1/2 ft. long
- Simple band switching
- 1000 watts
- Moderate wind load
- Complete instructions
- Disassembles to 4' sections
- IM-1 INDUCTI-MATCH included
- 09I ID Quick Disconnect included

**ONLY \$79.50**

Add \$4.<sup>00</sup> per order  
for shipping & handling

MANY MOBILE MOUNTS AVAILABLE  
UHF & VHF antennas available  
at bargain prices

Send or call for FREE catalog

**LAKEVIEW CO., INC.**

Route 7 Box 258  
Anderson, SC 29624  
(803) 226-6990

8:00 am to 4:30 pm EST  
Monday - Friday



CIRCLE 29 ON READER SERVICE CARD

**New AOR  
Scanner**

**1000 Channels.**  
8-600MHz,  
805-1300  
MHz



• Continuous coverage (except UHF TV 600-805)

• AM, FM and wide band FM tuning modes

- 10 Scan Banks, 10 Search Banks.
- Selectable Priority Channel
- Selectable Search Increments, 5-965KHz
- Permanent memory backup.
- 25 Day Satisfaction Guarantee. Full refund if not Satisfied.
- No Frequencies cut out.
- All normal accessories included.
- Size: 6 7/8" H x 1 3/4" D x 2 1/2" Wt. 12 oz.

**AR1000**

Total Price, Freight Prepaid (Express Shipping Optional)

**\$499**

**ACE**  
COMMUNICATIONS

10701 E. 106th St. Indpls., IN 46256  
Toll Free 800-445-7717



Visa and Mastercard  
(COD slightly higher)

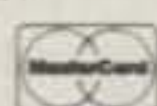

FAX (317) 849-8794

CIRCLE 164 ON READER SERVICE CARD

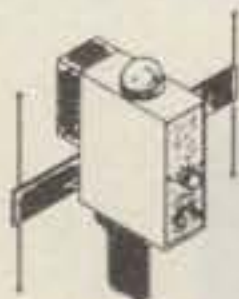

**VECTOR FINDER**

Handheld 2-mtr/220 MHz phase sense direction finder. Used with any FM xcvr. Oil compass.

Type VF-142, \$129.95, \$3.50 S&H. Call/write for info. CA add tax.

**RADIO ENGINEERS, 3941 MT. BRUNDAGE  
SAN DIEGO, CA 92111 619-565-1319**

**WRIGHTAPES:** (Since 1976) Unconditionally guaranteed Morse Code Practice on 60 min. cassette tapes. Beginners 2-tape set 5 WPM \$7.90. Also 3, 4, 5, 6-8, 10, 9-11, 12-14, 14, 16-20, 22, 24-28 WPM. Specify Plain Language or Code Groups. Also plain lang. only 30-35, 35-40, 45-60. FCC type tests: 5-6, 11-12, 11-17, 13-14, 20-24. Call signs: 12-15, 20-24. Nos.: 5-22, 13-18, 18-24. Check, M/C, Visa \$3.95 ea. PPD 1st class USA, Can. Printed texts add \$5.00 per tape. **Call anytime.**

Instant Service

PH: 517-484-9794 **WRIGHTAPES**  
235 E. Jackson C-3 • Lansing, MI 48906

**Macintosh**

Largest collection in the world! Free information **Software**

ZCo Corporation

P. O. Box 3720, Nashua, NH 03061  
(603) 888-7200 Fax: (603) 888-8452

**QSLs by W4MPY**

- Quality printing
- Reasonable prices
- Fast personal service
- FREE Samples

**Wayne & Lola Carroll**  
682 Mt. Pleasant Road  
Monetta, SC 29105

**1990 U.S. CALL DIRECTORY**  
(on microfiche)

Call Directory - by callsign .....\$10  
Name Index - by last name .....\$10  
Geographic Index - by state/city .....\$10

All three - \$25

\$3 shipping per order

**BUCKMASTER PUBLISHING**

Route 3, Box 56

Mineral, Virginia 23117

703/894-5777 visa/mc 800/282-5628

**YOUR BIG FREE CATALOG!**

Serving DX'ers since 1967 with the largest selection of hard-to-find & popular communications, SWL/scanner books and frequency registries: SWBC, BCB, Utes, Spy, Press, Weather, Military, Federal, Police, Aero, etc. **Ask for our latest BIG catalog!** (Sent to US/Canada/APO/FPO only.)

**CRB Research**  
P. O. Box 56-CQ  
Commack, NY 11725

CIRCLE 26 ON READER SERVICE CARD

4X150A TUBES, two new, eight pulls plus four sockets, \$50 for lot plus 9 lbs UPS. Hal MacArgle, W8MCH, Five Forks, WV 26145.

HY-GAIN TH2MK3 20/15/10M Yagi \$100; Ten-Tec 227 Antenna Tuner \$50; Drake AA-10 2 meter amplifier \$33. Charles Bright, WE0R, 4115 Buckley Ridge Court, St. Louis, MO 63125 (314-544-5584). (Prices include shipping.)

SELL 2.5KW linear amplifiers, three 4-500A finals in parallel, 4.2KV supply, fully metered. Also, various vacuum and air variable capacitors. Steve, KF6AJ, 7 Rod Line Road, Danbury, CT 06811 (203-746-1459).

EXTRA EXAM: For C-64/128 Theory Tests and tutor on 5.25 disk plus the newest ARRL license manual. Used and passed! \$10 p.p. KC3GO, (412) 881-9170.

NEED COPY of disc program for Microlog ART-1 interface to work on Commodore 64 computer. Will pay for disk and copy. Henry L. Ankeny, 420 S. 16 Street, Clarinda, IA 51632.

FOR SALE: 6 Bearcat crystals \$2.00 ea. Freq's are: 154.725, 39.82, 159.19, 46.24, 39.42, 45.22. Send order to: Matt Orr, P.O. Box 106, Midland, MD 21542.

WANTED: Reading copy of "The Wireless Man on Land and Sea." WB2VAT, Dick Duane, 390 Naughtright Rd., Long Valley, NJ 07853 (201-852-7165).

WANTED: Disabled veteran needs a ham receiver of any brand. It can be base or mobile, from 180m to 2m. I will even accept an SSB CB radio. I am disabled from the military and can't work. I can pay postage. I need it for therapy. Can't someone help? John Eary, 2315 Beach St. Lot -6, Ashland, KY 41101.

FOR SALE: Kenwood VOX-3 \$40, B-W 851 Tank Coil Assy. \$25, Kantronics Field Day 2 Code Readers \$95, Microlog CW Keyboard AKB-1 \$95, Microcraft Morse-A-Keyer \$95, 833A Tubes \$40, MFJ 525 RF Speech Processor \$65, Vibroplex Bug \$75, Kenwood VFO 180 \$75. Telephone N6DBH, 209-255-8967 (best time 10-11 AM PST), or Callbook address.

WANTED: Digital display Yaesu Model YC801, monitor scope Yaesu Model YO-100, external VFO Yaesu FV101. Bob Tibbits, WB6VOW, 619-378-3146.

I WOULD LIKE to get in touch with an Atari ST 1040 user who wants to exchange and talk about radio amateur oriented programs. If you're interested, please write to Jaime, P.O. Box 252, Laval, Quebec, Canada H7M 3N9. (Thank You, Merci, Gracias.)

SHORTWAVE LISTENERS: Need help finding Sri Lanka Broadcasting Corporation. For a complete transmission schedule, please send \$1 (to cover printing) and SASE to: Charles Clendenin II, 797 Greenmound Rd., New Richmond, OH 45157.

HEATHKIT model H-89A computer, 5 1/4 inch drives, RAM, 12 inch amber monitor, disks, many CPM and HDOS programs. W0KJV, P.O. Box 7349, Huntington Beach, CA 92615.

BEST OFFER: 42 inch cabinet rack, Astatic D-104 Mike with G-stand, Hammarlund rack-mounted SP-600 Rcvr. W4PB, 5731 Cannon Lane, Alexandria, VA 22303 (703-960-1887).

FOR SALE: New FM-430 board for FM operation of TS-430S, \$50. Used 7094 tubes, \$20 each shipped. K0HQW, Rt. 1 Box 98, Mt. Grove, MO 65711.

COMPLETE STATION SALE (everything mint): Alinco 110T (2M), Alinco ALR 72T (440), Kantronics KPC-4 dual-port TNC with 2400 card, Daiwa CN-460M cross-needle SWR/wattmeter, Astron 20A power supply, AEA Hot Rods, 9913 coax, books, antennas, service manuals, and other goodies; \$725 (you pay shipping). Richard, W7FA (in Callbook).

FOR SALE: Kenwood TS-830S rcvr, excel. condx. Includes manual, orig. box, \$675 plus UPS. Tony Musero, 215-271-8898, 73.

FOR SALE: Yaesu FT980 (CAT) good condition, one owner—SP980 speaker, DVK-100 digital voice keyer wired for Yaesu Operator and service manuals. W3CJL, 215-433-4485.

FOR SALE: Clegg Labs 99'er 6 meter transceiver, needs S-meter, \$30. Eric May, N1ELO, Box 428, West Swanzey, NH 03469 (603-352-1501).

FOR SALE: Lafayette Model HA-350 Transceiver, transmitter needs tuning but receiver works excellent, \$25. Eric May, N1ELO, Box 428, West Swanzey, NH 03469 (603-352-1501).

NEEDED: Technical manual or any other description of Hallcrafters type HLA-KA amplifier. OZ8RO, Rag Otterstad, Vejdammen 5, DK-2840 Holte, Denmark.

BUY: Collins 75A4, 8875, 7094, amateur equipment. For list SASE and \$1. Joe Bedlovics, 241 Dover St., Bridgeport, CT 06610.

HAMMARLUND STATION: HX-50 Transmitter, HQ-170A Receiver, and HXL-1 Amplifier. All in very good condition with manuals. Package only, pickup only, \$550. Charlie, KD4AJ, 404-396-0276, or write to 1968 Huntington Hall Court, Atlanta, GA 30338.

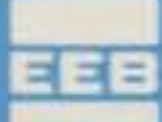

# EEB The Professional Amateur Store

Minutes From  
Washington, D.C.



NOVEX HAND SET

- DTMF dial pad
- Back lit dial
- Speaker vol. control
- Cellular look
- Wired for current 8-pin mic.

ICOM, Kenwood, Yaesu  
Others Call  
**\$89.95 + UPS.**

## NOVEX SPEAKER MIC.

DMC537I  
DMC537K  
DMC537Y



ICOM, Kenwood,  
Yaesu

- Hi quality audio
- Hi-lo audio switch
- 3.5 mm earjack
- Rotating clip
- Split plugs allows use as mic. or speaker
- Why pay more? \$24.95

## CUSHCRAFT

AR270 VHF/UHF	\$74.95
AR/2AR220/AR450	29.95
ARX2 R. Ranger	36.95
ARX2B/ARX220B +	
ARX450B R.R.IIs	43.95
AR6/AR10 Ringos	43.95
124WB Boomer 4 el.	43.95
215WB Boomer 15 el.	95.95
A147-4 FM yagi	36.95
A449-6 FM yagi	35.95
AOP-1 Oscar pkg	183.95
TEN3 10M 3 el.	99.95
A3S TriBand 3 el.	299.95
A4S TriBand 4 el.	373.95
AP8 HF Vert.	172.95
R5 HF Vert.	246.95

AND MUCH, MUCH MORE!

## LARSEN

NMO150 2M, Mobile	\$28.95
NMO220 + NMO450	28.95
NLA150 2M, Mobile	28.95
NLA220 + NLA450	28.95
LM150 2M, Mobile	25.95
LM220 + LM450	25.95
NMO2/70 Dual	39.95
NLA2/70 Dual	38.95
NMOMM Mag. Mt.	20.95
NLAMM Mag. Mt.	19.95
LMMM Mag. Mt.	17.95
NMOK Perm. Kit	12.95
NLAK Perm. Kit	9.95
KD4270 Dual Duck	24.95

AND MUCH, MUCH MORE!

## HUSTLER

68TV 6 band trap vert.	\$147.95
58TV 5 band trap vert.	125.95
G7-144 Fix stat. 2mt colinear	125.95
MO-1/MO-2 mobile masts	22.95
RM10/RM15 10m/15m resonator	12.95
RM10S/RM15S super resonator	17.95
RM20/RM20S std. & super resonator	16.95/22.95
RM30 20mt. std. resonator	17.95
RM40/RM40S std. and super resonator	18.95/26.95
RM75/RM80 75 or 80 std. resonator	19.95
RM75S/RM80S 75 or 80 super resonator	37.95
BM-1 bumper mt.	16.95
SSM-2 stainless ball mt.	18.95
SSM-3 spring	17.95
QQ2 quick disconnect	15.95
FX2 2mt 5/8 mag. mt.	24.95
HOT trunk mt. w/swivel ball	17.95
MO3 mobile mast	17.95
MO4 mobile mast	19.95
RM12 12m standard	12.95
RM17 17m standard	16.95

AND MORE!

## BUTTERNUT

HF6VX 80-10 vertical kit	\$149.95
HF2V 80-40 vertical	139.95
RMKII roof mtng. kit	52.95
TBR160S 160m add on	54.95
MPS mtng post sleeve	7.95
HF5B HF mini beam	232.95

## VAN GORDEN

PD8010 Dipole	\$35.95
PD8040 Dipole	33.95
PD4010 Dipole	31.95
D10 10M Dipole	23.95
D40 40M Dipole	26.95
D80 80M Dipole	27.95
Allbander	28.95
G5RV 3.5-30 MHz	49.95
Balun 1:1/4:1	14.95

Call for VG accessories and for more antennas.

## AEA

ISOLOOP *New*	\$299.95
Isopole 144 2M	55.95
Isopole 440 UHF	83.95

## PRO-AM

605 Ball mount	\$18.00
PHF10 10m resonator	18.95
PHF15 15m resonator	18.95
PHF20 20m resonator	18.95
PHF40 40m resonator	18.95
PHF75 75m resonator	19.95
PHF160 160m resonator	69.95
AB5 5 band kit	89.95
PAQM mini mag 2m	21.95

## UNTESSA

CR2AM 2M mag. mt.	\$44.95
CR2AP 2M perm. mt.	42.95
CR2/4AM dual band mag. mt.	59.95
CR2/4AP dual band perm. mt.	57.95

## ROHN

20G 10' sect.	\$52.95
20AG top sect. 9'	74.50
25G 10' sect.	68.00
25AG2 top sect. 9'	85.50
45G 10' sect.	161.00
45G2 top sect. 9'	176.25
AS25G access shelf	28.00
AS45G access shelf	70.00
TB-3 thrust bearing	71.00
M200 10' mast	18.00
SB25G short base	32.70
SB45G short base	70.20
EF2545G gin pole	396.00

AND MORE!

## CABLE & CONNECTORS

Belden 9913 Low Loss	per/ft.	.69 cts.
RG213 (4063)		.39 cts.
RG8/U (9095) Extra Flex		.45 cts.
RG8X (9091) Mini		.22 cts.
RG59/U 72 OHM		.14 cts.
PL259/Silver		.99/1.49
N-Male for 8/U 8261		4.79
BNC(M)UHF(F) 2900		5.55
Low Loss eqv 9913		.69 cts.

## HY-GAIN ROTORS

Model	Sq. Ft.	Relating TQ	Brake TQ	Sale
72X	20	83	750	\$419.95
HAM IV	15	66	417	349.95
CD45 II	8.5	50	66	249.95

TQ-Torque in ft. lbs.



## CREATE DESIGN

CreateRoof Towers Constructed Of High Grade Aluminum With Galvanized Steel Bracing For Added Stability And Strength. Will Easily Accommodate Your Antenna Requirements. Three Sizes Of Roof Towers Will Support VHF Antennas. HF Tri-Banders. And Oscar Systems. Rotators Easily Mount Inside The Tower. An Optional Thrust Bearing (CK46) is Recommended. Specifications Are Subject To Change Without Notice Or Obligation.  
\*Subject To Availability

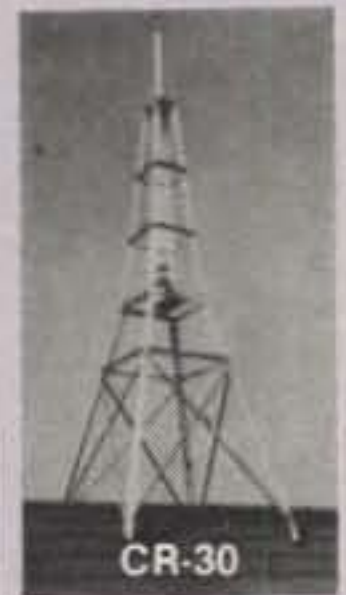

CR-30

Model	Height	Maximum Antenna Wind Load in FT 2	Base Width	Max. Vert. Load Lbs.	Tower Weight Lbs.	CAPLIFESOR
CR-18	5'10"	21 @ 90 MPH	31 1/2"	440	28	L I C F E S O R
CR-30	9'10"	27 @ 90 MPH	39"	1,322	39	
CR-45	14'9"	23 @ 90 MPH	39"	881	55	
CK-46	Thrust Bearing For CR-18, CR-30, and CR-45 Maximum Acceptable Mast Diameter 2 1/2"					

For Safety's Sake All Towers Should Be Guyed. \*U.P.S. Not Included

- CLP 5-130-1
- 50-1300 MHz
  - 23 Elements
  - Longest 9'10"
  - Boom 5'9" \$239.95 + UPS
- CLP 5-130-2
- 108-1300 MHz
  - 19 Elements
  - Longest 4'6"
  - Boom 4'6" \$139.95 + UPS

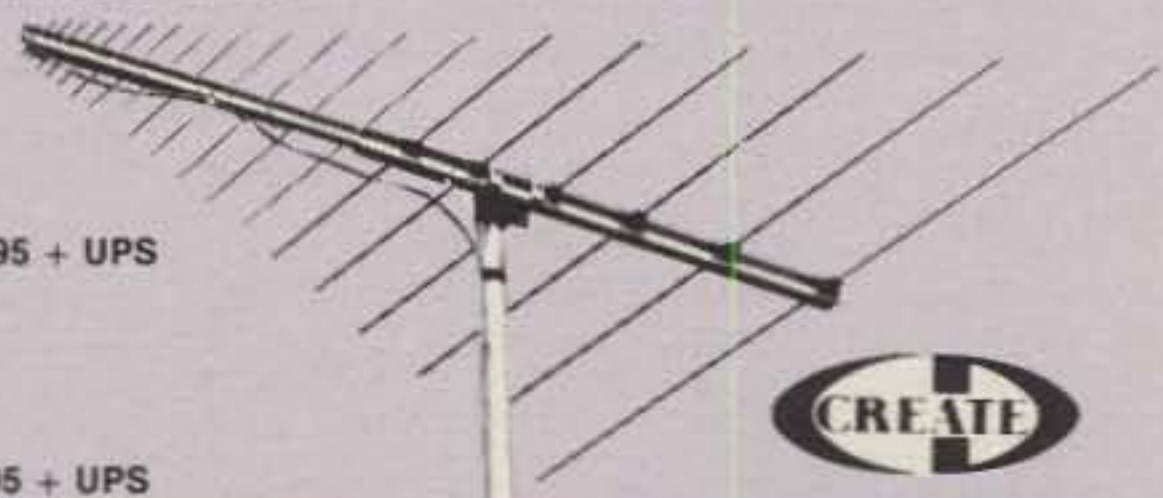

## NEW EMOTO ROTATORS NOW IN U.S.

- World's Finest Rotators Are Here
- 80% Of All Hams In Japan Use Emoto
- Highest Quality—Special Features—Compare

Model	Sq. Ft.	Roto TQ	Brake TQ	Note	Sale
105TSX	10.9	37 ft.#	215 ft.#		\$193
747SRX	21.8	50	502	H.S.	416
1105MSX	27.3	57	717		534
1105MSAX	27.3	57	717	P.S.	599
1200FXX	27.3	143	1290	H.S.	618
1300MSAX	32.7	215	1792	P.S.	1,061
1800FSX	38.2	287	2150	P.S.	3,055

H.S. HiSpeed P.S. Pre-Set #10 SASE Full Line Details

## DATONG

- FL3 Multi Mode Audio Filter w/Audio Notch
- FL2 Multi Mode Audio Filter
- ANF Automatic Notch Filter
- AD270 Indoor Receiving Antenna 200 kHz-30 MHz
- AD370 Outdoor Receiving Antenna 200 kHz-30 MHz

CALL FOR PRICES

## ICOM

IC735 HF Xcvr	IC781 HF Xcvr
IC751A HF Xcvr	IC228H VHF Mobile
IC765 HF Xcvr	IC2SAT 2m HT

AND MUCH MORE!

## KENWOOD

TS140S HF Xcvr	TM231 VHF Mobile
TS440S HF Xcvr	TM731 VHF/UHF Mob.
TS950S/D HF Xcvr	TH25AT 2m HT

AND MUCH MORE!

## YAESU

FT747GX HF Xcvr	FT212RH VHF Mobile
FT757GXII HF Xcvr	FT411E 2m HT
FT767GX HF Xcvr	FT470 VHF/UHF HT
FT1000/D HF Xcvr	

AND MUCH MORE!  
CALL FOR PRICES

**YAESU**  
**ICOM MFJ**  
**BIRO**  
**ASTRON**  
**ARRL**  
**DAIWA**  
**ALINCO**  
**KENWOOD**



ELECTRONIC EQUIPMENT BANK  
323 MILL STREET N.E.  
VIENNA, VA 22180

ORDERS: 800-368-3270  
LOCAL TECH: 703-938-3350  
FAX: 703-938-6911

- PRICES SUBJECT TO CHANGE
- PRICES DO NOT INCLUDE FREIGHT
- SORRY NO CODS
- RETURNS SUBJECT TO 20% RESTOCK FEE

SALE: New Kenwood SM220, BS-8. List \$560.90, sell \$500. Wanted: YAESU Y-101 Station monitor. W3CJL, 215-433-4485.

KNIGHT STAR ROAMER Receiver, new condition, manual, \$50 plus UPS. Dynamotors. Old Tubes. K4UJZ, 608 W. Thompson Ln., Murfreesboro, TN 37129 (615-893-5344).

HAVE: ICOM 3AT (220), Kenwood TH41AT (440), AVCOM PS35A GHz Spectrum analyzer. WANT: Oscilloscope, 2 mtr xcvr. Ken, N2KS, 21 W. 58 St., NYC, NY 10019 (212-371-2344).

FOR SALE: Vibroplex Lightning Bug semi-automatic key with original box, \$125. Gerry Skloot, KE2N, 2923 Mandalay Beach Rd., Wantagh, NY 11793.

WANTED: Manual, power cord, microphone for KDK model #FM-2015R. Kevin, P.O. Box 5032, Springfield, VA 22150.

ATTENTION HEATHKIT COLLECTORS: SB-401, SB-303, SB-610 all cables and manuals included. Exel. cond., \$375 for all. George, WA3LVR, 215-873-0979, FAX 215-269-9098.

NEED schematic and comb info for Whamo-10 Regency scanner, model ACT-10. Will pay for copy. J. Settle, 630 Walnut, Columbia, PA 17512.

FOR SALE: 1954 Gonset five-element tri-beam with Gordon rotor. Make offer. Pick-up only. I.D. Byars, W4KKO, 1-615-668-8451.

TS-950SD OWNERS: Adding an OUTBOARD analog "S" meter without getting inside. Please send SASE and quarter. Ralph Cabanillas, Jr., W6IL, 2359 Creston Dr., Hollywood, CA 90068.

TEACHER WANTS TANDY CoCo junk. Also Apple. Selling BO vintage clean RCA 1-BT-58 Globetrotter. Via KA1UVE.

NEC, color monitor model, JA-1215MA, Vic-20 computer and AEA CP-1 computer interface, \$150. Johnson T/R switch, \$59. Drake DL-1 Dummy Load, \$49. Noise Bridge, \$45. Tony Musero, K3UKW, 215-271-8898, CB QTH, add UPS pls.

WANTED: Manual for Hallicrafters S-38. Will pay for copying and mailing costs. WA7WOC, POB 1411, Carefree, AZ 85377 (602-488-3427.)

WANTED: (1) Yaesu Digital Display Model YC601, (2) Yaesu Monitor Scope Model YO100, (3) Yaesu External VFO Model FV101B. WB6VOW, Bob Tibbits, 11023 Marcia St., Weldon, CA 93283.

WANTED: Maidenhead grid-based beam heading program. Given: your latitude and longitude and desired grid. Program provides beam heading and path length. T.N. Colbert, Burton, Ohio 44021.

MOBILE RECEIVER 30-50 MHz 8 ch \$10. VHF Mobile Repeater w/manual \$75. Tek scope plug-ins 500 series \$25-\$50 ea. K6KZT, 805-528-3181.

FOR SALE: Yaesu FT-901DM mint with FV-901DM remote VFO, all excellent in boxes, \$675. WA8CAJ, Jim, 702-827-3074.

R/S PROGRAMMABLE SCANNER, 10 channel, \$90. Xerox 16/8 CPM computer, \$425. R/S DX-300 receiver, \$125. More info send SASE to P.O. Box 518, Whitehouse, FL 32220.

CLEANING OUT SHACK. Hammarlund HQ-170AC mint \$175, HQ-215 Rcv'r \$195, Heathkit DX-60 \$30, HD-15 phone patch \$25, SB-10 SSB adapter \$90. Call Charlie, KD4AJ, 404-396-0276.

BUY: Amateur Radio Equipment, good/bad. For large list/\$1.00 and SASE. Joe Bedlovies, 241 Dover Street, Bridgeport, CT 06610.

HELP: Junior high school radio program needs unwanted radio equipment, parts, books, etc. Help us put more kids on the air. G. Skloot, C/O JHS 180, 320 B. 104 Street, Rockaway Park, NY 11694.

WANTED: ICOM FM unit EX-106 for an ICOM 6 meter transmitter Model IC-551D. Contact Piero A. Sassu, N3FVG, 714 W. Marshall St., Norristown, PA 19401.

STAMP SWAP: For 100 different non-European stamps I will send 100 from Europe. I prefer railways and horses. Indicate country you look for. Gerhard Elsig, Oberer Markt 7, A-3361 Aschbach, Austria (OE3GEA).

IBM XT COMPATIBLE: 512K, Mono monitor, 2 FDD, RS232 Para, like new, 6 mo warranty, FOB \$495. Call 408-739-1833 Mike Bae, Box 4808, Santa Clara, CA 95954.

WILL SWAP: My M/U Commonwealth stamps for clean, working 2 mtr all-mode, Hallicrafters S-38 C/D/E, etc. Details from KA1EAP, Callbook address.

10-YEAR GIANT CLEANOUT SALE. Shack overloaded. Tons of test equipment, microwave, radios, parts, antiques, variacs, more. Big list, SASE please. J. Cohen, 200 Woodside, Winthrop, MA 02152 (617-846-6312).

WANTED: Hal CT2200 or CT2100 with KB2100. N1DPG, 203-584-1600.

COMPONENTS, SCHEMATICS, Test Equipment at low, low asking prices. \$1.00 (stamps OK) for list. George Whitmore, 305 Nickel St., Truth or Consq., NM 87901.

WANTED: Atlas Model 10XB Crystal oscillator accessory. KC6GAF, 4030 A Road, Garberville, CA 95440.

HEATHKIT: Courses—AC \$20; DC \$20; Semiconductors \$20; Analog Trainer \$80. Postage \$2 ea. or all \$120 PP. W2RUK, 4554 West Lake Rd., Canandaigua, NY 14424.

COLLINS New Tube Sets: KWM2 \$95 less finals, 75S3 \$65, 32S3 \$60 less finals, 75A4 \$85 plus UPS. Bob, WE2T, 716-334-1103.

COMMODORE C-64 computer, 1541 drive, 1525 printer, 1200 baud modem, DR. QSO, Flight Simulator, Jet Load, much other software, books, lid, fan, monochrome monitor, stand, RUN Magazine—60 issues, \$390 FOB. Stuart Oserman, WA9ZPL, 7729 Church, Morton Grove, IL 60053-1623 (708-965-0963).

DONATE PLEASE! Your old QSTs, CQs, ARRL Handbooks for Korean Ham Club, KARL. Mike Bae (415-964-7257), U.S. Coordinator, 1340 Miravalle Ave., Los Altos, CA 94022.

HEATH CW filter \$30. Yaesu 8-pole CW filter \$40. FT101Z cascading SSB filter \$40. 10-el 200 MHz heavy-duty beam \$25. new Kenpro KT-SM1 SP mic for Santecl/ICOM \$20. Tektronix 524 scope \$100. Simpson 303 VTVM \$35. Tektronix CA plug-in \$25. Varouj, N6DBH, Callbook address (209-255-8967).

BUY: Amateur Radio Equipment, good/bad. For large list/\$1 and SASE. Joe Bedlovies, 239 Dover Street, Bridgeport, CT 06610.

WANTED: YAESU SP-101PB Speaker, FR-101 Receiver, and Hallicrafters HA-7 Calibrator. Charles T. Huth, 229 Melmore St., Tiffin, OH 44883 (419-448-0007).

WANT: 10 GHz GunnPlexer horn, screw-base flashbulb, Kalart screw-base flash holder. T.N. Colbert, WA8MLV, Burton, OH 44021.

HEATH EV-800 Lab test unit \$50. H.P. 521A Counter \$20. Heath AM-1 Impedance Meter \$20, old Hallicrafter receivers. K6KZT, 805-528-3181.

## GAP Airwaves expands its Service to Include 2m and 6m with the CHALLENGER DX-V & DX-VI

Unique Multiband Antennas that Utilize the Patented GAP Elevated Launch Technology

The Revolution in Antenna Design

That...

- Launches RF from an elevated GAP
- Eliminates earth loss
- Comes pre-tuned, No adjustments necessary
- Uses 3 short radials @ 25 feet
- Assembles in less than 30 minutes
- Is self supporting w/drop in ground mount and is 31 feet high



but has NO!!!

- Traps
- Coils
- Transformers
- Baluns
- Resistors
- or Base Insulators

Challenger DX-V \$199\*

Total bandwidth on 40, 20, 15, 10, 6, 2 meters 80 KHz on 80 meters

Challenger DX-VI \$219\*

Total bandwidth on 40, 20, 15, 12, 10, 6, 2 meters 130 KHz on 80 meters

Best of all the ENTIRE antenna is always active!!

To Order Call—(407) 778-3728

\* Plus shipping and handling Florida residents add 6% tax



**GAP**  
ANTENNA PRODUCTS  
6010—Bldg J  
N. Old Dixie Highway  
Vero Beach FL 32967

## Introducing Two new C64 Cartridge programs: #1 For ATV.. HI RES NTSC Video Page Gen.

Sample VIDG screen:



Video Page Generator (Model VIDG) Features:

- \*Up to 1000 pages can save to disk
- \*DIN to BNC cable 75Ω NTSC video output
- \*User friendly sample demo display screens
- \*VIDG Cart Can be used without a disk drive
- \*User defined page & folder sequence
- \*Vary character, background & screen colors
- \*Display and edit any page, auto loads disk
- \*Use with the C64 / C64C / or 128 computers
- \*High Resolution NTSC video Pixel Image
- \*Full screen professional color display
- \*Low cost, easy to program, user friendly
- \*Two 240 character crawl lines per page
- \*3 Size letters, flash, crawl, scroll, 16 colors
- \*Update & Display new pages via modem
- \*Displays time, date & day when set



## #2 "Repeater Manager" Automatic Control Operator

"Touchtone Programmable Sequence Generator" Model "TPSG"

- \*Use as Repeater Manager to program your controller with automatic touchtone strings
- \*Connect directly to tone decoder input, or send the audio via your FM Transceiver
- \*Will Key transmitter PTT and send your CW ID after execution of Touchtone string
- \*RS232C input allows modem or Packet control remotely from any computer
- \*Generates 28 digit long "macro" touchtone alarm sequences at programmed time and date
- \*Daily, weekly, or instant events generated with Keyboard, RS232 Modem, or TNC Input
- \*Alarm touchtones generate even while programming new events!
- \*Video output from the C64 can be used to display current event status in real time
- \*Hundreds of alarm clock events activate each programmed touchtone sequence
- \*Outputs (600Ω) touchtone audio from C64, C64C or C128 Computer
- \*Change, update, delete or generate touchtone sequence via keyboard, TNC, or Modem
- \*Program any device that accepts touchtone commands from any location
- \*Alarm sequences may be saved to disk as files containing weeks or months of events
- \*Print and display all events to printer, to local monitor, or remotely via TNC or modem
- \*Adjustable touchtone speed & tone digit length (nominal 40 Mill sec/ digit)
- \*Optional battery back up with the 12V. DCPS Power Supply; Inc. 60hz crystal time base
- \*Ask about our C64 user port, Hayes compatible, 1200 & 2400 baud modems from \$79.95

Engineering Consulting  
583 Candlewood St.  
Brea, Ca. 92621  
Tel:714-671-2009 FAX:714-255-9984

Model TPSG...\$189.95  
+\$5.00 S/H, CA. ADD 6.25%  
Inc. Cart, disk & audio din plug

MASTERCARD VISA AMEX DISC

CIRCLE 55 ON READER SERVICE CARD

FOR SALE: Hy-Gain 13-30 log periodic. ARRL Handbooks 1943-44-46-47-51-52-56-57-59-60-61-68. Brownie, W3CJL, 215-433-4485.

10 YEAR GIANT CLEANOUT SALE. Shack overloaded. Tons of test equipment, microwave, radios, parts, antiques, variacs, more. Big list, SASE please. Joseph Cohen, 200 Woodside, Winthrop, MA 02152 (617-846-6312).

R/S PROGRAMMABLE 10 channel scanner \$85, Xerox 16/8 (CPM) computer 10 meg HD \$425, R/S DX300 SW Receiver \$125. More info send SASE to: P.O. Box 518, Whitehouse, FL 32220.

LIST OF OLD RADIO, ham, and telegraph publications available for SASE. Dick Randall, K6ARE, 1263 Lakehurst Rd., Livermore, CA 94550-1851.

WANTED: Old AM broadcast receivers. Particularly Bakelites, plastics, and cathedrals. G. Skloot, KE2N, 2923 Mandalay Beach Road, Wantagh, NY 11793.

FOR SALE OR TRADE: CQ/HR/QST/73 Magazines. SASE or call 508-947-4444. KA1VY, E. Guimares, 401 Bedford St., Lakeville, MA 02347.

PLEASE HELP: Junior high school radio program needs your old equipment, magazines, and books. G. Skloot, c/o JHS 180Q, 320 Beach 104 Street, Rockaway Park, NY 11694. Thank you!

FOR SALE: ICOM 730 xceiver very good condition, MFJ 1278 interface with prog for Commodore 64, good condition. Phone 712-542-4715. Henry L. Ankeny, Clarinda, LA 51632.

SUPER DEAL: 50 foot tower, 4-element "Tribander" by Hy-Gain, Ham "M" rotor, buyer must take down, \$200 complete. Tony Musero, K3UKW, 215-271-8898.

FOR SALE: Collins F455J21, J08, J31, \$75; Collins 248 kHz Filter, \$50; Collins F-250A-67, \$50; Fox Tango 33 H 1.8 Filter \$35; Yaesu YF-31H 500 8-pole CW filter, \$40; Yaesu XF-30C CW filter \$35; Yaesu FT101ZD cascaded filter, \$40; Yaesu XF-9 SSB Filter, \$25; Heathkit 400 Cycle CW filter, \$25; (100) FT243 Crystals 6 MHz to 9 MHz, \$100. Telephone: 209-255-8967 (best time 10-11 AM PST) or Callbook.

FOR SALE: MFJ 1278 interface for Commodore computer. Complete, runs well. Phone 712-542-4715, W0FSY.

COLLINS NEW TUBE SETS. KWM2 \$95 less finals, 75S3 \$65, 32S3 \$60 less finals, 75A4 \$85. Bob WE2T, 716-334-1103.

FOR SALE: Kenwood TS520SE with CW filter, AT-200 Ant tuner, SP-520 Speaker, DG-5 digital display, MC-50 disk mike, all in package deal. Uniden HR-2600, Pyramid 20A 12V power supply, Shure 526T desk mike, all in package deal. KD9TY, Ken Wolfe, P.O. Box 134, Buffalo, IN 47925 (1-219-278-7808).

COLLINS 75A3 receiver good condx, \$185. Swan 14-X 12 VDC power supply, \$33.50. KA2MCU, Box 4753, Schenectady, NY 12304-4753.

IBM XT COMPATIBLE: 512K, mono monitor, 2 FDD, RS232, Para, like new, 6 mo. warranty, FOB \$495. Call 408-739-1833. Mike Bea, Box 4808, Santa Clara, CA 95054.

SWAP: Universal Aluminum Tower Section. Have unused 26 inch tapered; need 26 inch straight. J. Runinger, WB2LCP, 7135 Stearns Rd., Rome, NY 13440 (315-865-5927).

Wanted: Wilson WR-1000 rotator, any condition. Bob Eshleman, W4DR, Box 566, MCV Station, Richmond, VA 23298-0566 (804-794-7143).

LOOKING FOR SCHEMATIC and hopefully service booklet for Realistic DX-300. Also Hammartund HQ150 with a good power transformer. Need manuals for above. Service booklet preferred. John McMillan, 7726 S.W. 53rd Place, Gainesville, FL 32608.

SEND STAMP for free list of very low cost Ham radio equipment. Jim Braddy, WA4DSO, 3037 Audrey Dr., Gastonia, NC 28054.

SELL: H-P 608D VHF Signal Generator, BC-221, Boonton 190A Q-Meter. Ken, WB9OZR, 362 Echo Valley Lane, Kinneon, NJ 07405 (201-492-9319).

SALE: Swan 350 P.S. Spkr., clean, \$150. Swap for 6 meter rig. Robert E. Tollison, K4JIA, 1000 Co. Rd. 18, Mt. Hope, AL 35851.

FOR SALE OR TRADE: ATV station equipment. SASE for list. Ben, KA4LBE, 1324 Sunset Park, Seymour, TN 37865.

WANTED: Collins gear, any condition. FOR SALE: Heathkit SB-401, SB-500 2 meter transverter. K9ALD, 33 Rayburn Ct., Mahomet, IL 61853.

WANTED: Yaesu FRG-7000 in good cond. No modifications. Reasonable. N0KWK in 90 Callbook.

EMBROIDERED PATCH of a telegraph key wanted. Dick Randall, K6ARE, 1263 Lakehurst Rd., Livermore, CA 94550-1851.

## MAXCOM<sup>®</sup>



AUTOMATIC ANTENNA MATCHER

The ultimate advanced technology —  
when you need it most.

P.O. Box 502  
Ft. Lauderdale, FL 33302 Call Sonny  
(305) 523-6369

THE BOTTOM LINE: "MAXCOM"WORKS!

## ELECTRON TUBES OVER 3000 TYPES IN STOCK!

Also capacitors, transformers  
and parts for tube type equipment.  
Send \$2.00 for 28 page catalog.

## ANTIQUE ELECTRONIC SUPPLY

6221 S. MAPLE AVE., TEMPE, AZ 85283  
PHONE: 602/820-5411 FAX: 602/820-4643

## Work Rare CW DX!

**CONTEST CODE.** This powerful hypnosis cassette tape teaches you to copy the essentials for DX and contests. **High Speed** (30/40 wpm) or **Ultra High Speed** (50/60 wpm). **Subliminals** speed you along! Only 20 min./day for 30 consecutive days. Each tape \$14.95 (Specify which program you want) or both for \$27.95 ppd in US (NY add \$1.12 or \$2.10 tax).

PASS Publishing, Box 570, Stony Brook, NY 11790

## CABLE-TV BOXES Descramblers • Converters FREE CATALOG

TRANS-WORLD CABLE CO.  
12062 Southwest 117th Ct., Suite 126  
Miami, Florida 33186  
800-442-9333

## "Specialist in RF Connectors and Coax"

Part No.	Description	Price
PL-259/USA	UHF Male Phenolic, USA made	\$ .70
PL-259/ST	UHF Male Silver Teflon USA	1.50
UG-21D/U	N Male RG-8, 213, 214 Delta	3.25
UG-21B/U	N Male RG-8, 213, 214, Kings	5.00
9913/PIN	N Male Pin for 9913, 9086, 8214 Fits UG-21 D/U & UG-21 B/UN's	1.50
UG-21D/9913	N Male for RG-8 with 9913 Pin	3.95
UG-21B/9913	N Male for RG-8 with 9913 Pin	5.75
UG-146A/U	N Male to SO-239, Teflon USA	6.00
UG-83B/U	N Female to PL-259, Teflon USA	6.00

## The R.F. Connection

213 North Frederick Ave., #11 CQ  
Gaithersburg, MD 20877 • (301) 840-5477  
800-783-2666

Prices do not include shipping and are subject to change.  
VISA/MC, add 4%; UPS, COD add \$3.50/order

## "ONLINE" U.S. CALL DIRECTORY

Hamcall service gives you all hams via your computer & modem. Updated each month! Only \$29.95 per year. Unlimited use - you pay for phone call.

## BUCKMASTER PUBLISHING

Route 3, Box 56  
Mineral, Virginia 23117  
703/894-5777 visa/mc 800/282-5628

## RADIO REPAIR

ALL Makes and Brands  
\$25.00/Hour + Parts

Send UPS Insured, Include Manuals  
We Add Trust and Satisfaction to Each Repair

Ed Kuhnley, KI4RF  
4484 Tumbleweed Trail  
Port Orange, FL 32127  
(904) 788-6701

## MorseManPlus

The premier Morse Code  
trainer for the IBM-PC

The reviews are out and Morseman Plus has scored the highest marks yet! *CQ Magazine* says, "a slick commercial program that clearly ranks among the top". *Monitoring Times* proclaims, "The slickest program to come along in a long time". *Morseman Plus* will teach code to a newcomer or train the experienced ham from 5 to 99 wpm, using a variety of tried and true methods, including random characters, random words, true random QSO's, QSO tests and much more. Even lets you send text files!

*Morseman Plus* requires 256k RAM (512 recommended) on an IBM-PC or compatible.

Order your copy of *Morseman Plus* for \$24.95 (plus \$3.00 s/h) today!

## TOP RATED IBM shareware & software

## ALL DISKS

\$3.50 ea. (for 1-9)  
\$3.00 ea. (for 10 or more)  
for 3.5" disks add \$1.00 for  
each disk. - include \$4.00 s/h -  
outside US add \$6.00

1082 - Ham Radio 2 - packet related, YAPP 2.0 & Packtalk term programs.

1085 - Ham Radio 5 - antenna analysis & engineering

1086 - Ham Radio 6 - sunrise/sunset predi., circuit analysis, tropo path pred.

1087 - Ham Radio 7 - QSL card maker, RF engineering, grid square calcs & more.

1089 - Mapper - top selling world map system. Gives MUF, sunrise/set, beam heading, more. (EGA req'd).

1090 Miniprop 2 - the king of propagation forecasting.

1091 TrakSat - nice satellite tracking program. Good graphics. Easy to use

1094 Icom Rig Control - two programs to control the 735 & 761 HF rigs.

1096 Radio Mods - a nice collection of modifications for HF rigs, HT's, scanners.

1097 RD-SSTV - an easy way to view SSTV on your PC. (CGA and game port)

1099 Kenwood Rig Control - control the TS440 & TS940 rigs with the PC

1101 CW Decoders - a collection of programs to decode CW on the air.

1102 FCC Exams - prepares novice thru general exams. Includes question pools

1110 K1EA Contest Logger - ver 4.25 of the best DX contest logger around

1119 - 1120 Total Ham (2 disks) - top selling multipurpose station utility.

1122 - LOG-EQF - Top notch logging (and more) incl. Kenwood rig control.

1143 - KAM RTTY - top notch RTTY/CW program for the Kantronics KAM

1145 - PK232 Terminal Program - great terminal program for the AEA PK232

1149 - GeoClock - top notch world map system. Shows greylines and moves real time (Herc/CGA) (order 1150 EGA/VGA)

call 1-800-525-7235 (orders)



renaissance software  
& development  
box 640 - killen - alabama  
35645 (205) 757-5928  
visa/mastercard accepted

# If you plan to buy an amplifier this year...

# do yourself a favor!

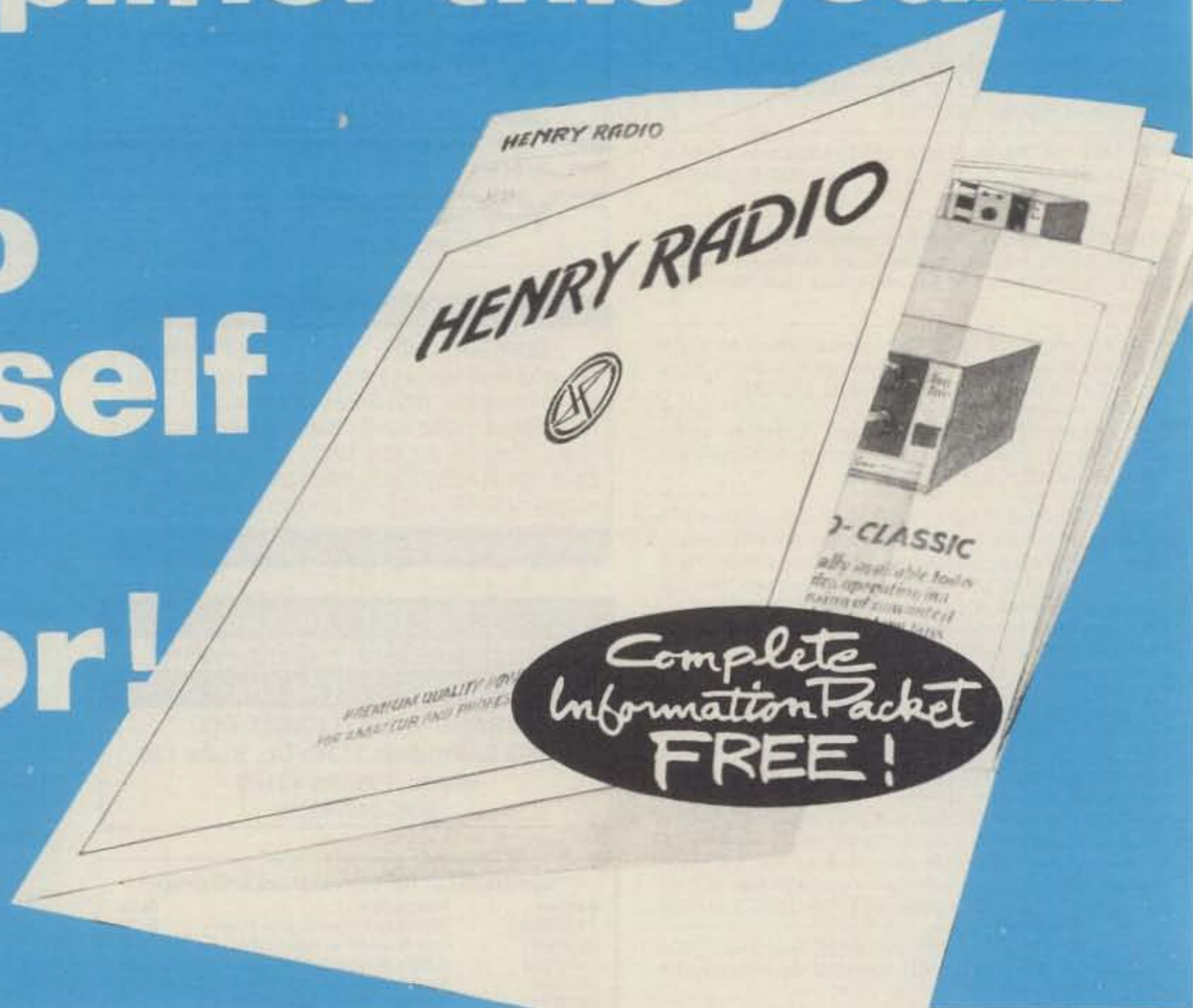

You wouldn't buy a car from a dealer who offers only one model. . .so why buy an amplifier that way?

Henry Radio offers the widest choice of amplifiers in the world. We design and produce amplifiers to fit different needs and different budgets. We feel we offer the best equipment and there are a lot of amateurs who obviously agree. That's why we've sold over 40,000 amplifiers during the last 25 years. If you plan to buy an amplifier, do yourself a big favor. . .call, write, FAX, or come in. But make sure you have our new information packet in your hands before you make a decision. You owe it to yourself. Read it through, compare the specs, compare prices, compare VALUE.

And, of course, when you buy from Henry Radio you're buying factory direct.



Henry Radio. . .  
the amplifier specialists

Our present HF amplifier line includes the following models:

<b>2KD STANDARD</b> .....	Single 3-500Z Desk SSB Amp	<b>3K CLASSIC MKII</b> .....	Domestic Console
<b>2KD CLASSIC</b> .....	Desk Model Linear Amplifier	<b>3K CLASSIC MKII</b> .....	Export Console
<b>2K CLASSIC</b> .....	Console Amplifier	<b>3K CLASSIC RF</b> .....	RF Deck only
<b>2K CLASSIC X</b> .....	Domestic Console	<b>5K CLASSIC</b> .....	Export Console
<b>2K CLASSIC X</b> .....	Export Console	<b>5K CLASSIC RF</b> .....	RF Deck only
<b>2K CLASSIC X RF</b> .....	RF Deck only	<b>3K PREMIER</b> .....	Console Amp. with 160 meters
<b>3KD CLASSIC</b> .....	Single 3CX1200A7 Desk Amp	<b>3KD PREMIER</b> .....	Desk Amp. with 160 meters



## Henry Radio

2050 S. BUNDY DR. LOS ANGELES, CA 90025 (213) 820-1234  
Toll free order number: (800) 877-7979 TELEX: 67-3625(Henradio) FAX(213) 826-7790

CIRCLE 152 ON READER SERVICE CARD

# 10 METER DX IS HOT!

AND YOU CAN WORK IT WITH THE NEW RANGER AR 3500



- Compact Mobile Transceiver
- Microprocessor Controlled Design
- All Mode SSB/CW/AM/FM
- Effective Noise Blanker
- Five Selectable Memory Channels
- Programmable Band Scan
- Large Six Digit Frequency Readout
- Split Frequency Repeater Operation
- Dynamic Mic & Power Cable
- Mic with Frequency Scanning Buttons (optional)
- Limited 1 Year Factory Warranty by Clear Channel Inc. Issaquah, WA

### SPECIFICATIONS

**Frequency:** Range 28.0000-29.9999 MHz. in 100 Hz steps.  
**Sens.:** SSB/CW 0.3  $\mu$ V, FM 0.5  $\mu$ V.  
**Power:** SSB 25W PEP, 30W, CW, 8W FM  
**Input:** 12.5 V, 6A DC  
**Dimensions:** 2.4" x 7.7" x 11" Wt: 3 Lbs.

We made a special purchase of these fine transceivers and thus able to offer them at a very attractive price

**Special!**  
**\$319.95**

### AVAILABLE OPTIONS

- 100 Watt model ..... \$399.95
- Mic w/Freq. Scan. Buttons ..... 45.00
- SP-1 Speech Processor\* ..... 45.00
- CW Auto break-in & pwr control\* ..... 45.00
- Service Manual AR3300/AR3500 ..... 20.00
- 3 Element Beam, 26-30 MHz ..... 99.95
- Penetrator Mobile Ant. .... 47.95
- Antron A-99 Vertical Base Ant. .... 49.95
- RS7A Pwr Supply for 30W Ranger. . . . 49.95
- RS35A Pwr Supply for 100W Ranger. . 134.95

\*sale price with radio purchase only  
 Offer limited to available stock  
 Send a SASE for detailed brochure

Quantity Pricing Available Foreign Orders Accepted  
 Orders received by 1 PM PST shipped UPS same day.  
 COD / VISA / MC Next day UPS delivery available  
 No extra charge for C.O.D. or VISA Mastercard Orders

ORDER DESK ONLY — NO TECHNICAL  
 (800) 854-1927

ORDER LINE and/or TECH HELP  
 (619) 744-0728

FAX (619) 744-1943

## Advertiser's Index

AEA/Adv. Elec. Applications.....	5, 44, 45, 95
AMC Sales.....	32
AMSAT.....	94
ARRL.....	112
AVC Innovations.....	90
AXM Inc.....	90
Ace Communications.....	132
Ace Systems.....	130
Advanced Computer Control.....	17
Alexander Manufacturing.....	69
Alfa Electronics.....	131
Alinco Electronics.....	6, 7
Alpha Delta.....	94
Amateur Electronic Supply.....	135
Amateur Wholesale Electronics.....	97
Ameritron.....	117
Antenna Service.....	85
Antennas West.....	96, 122, 130
Antique Electronic Supply.....	123
Antique Radio Classified.....	129
Ashton Inc.....	128
Associated Radio.....	48, 131
Astron Corp.....	91
Austin Amateur Radio Supply.....	78
Austin Custom Antennas.....	82
Azimuth Weather Star Comm.....	128, 129
Barker & Williamson.....	55
Barry Electronics.....	57
Beezley, Brian, K6STI.....	59, 130
Bencher, Inc.....	111
Bilal Co./Isotron Ants.....	129
Buckmaster Publishing.....	89, 122, 131, 132, 135
Burghardt Amateur Center.....	16
Butternut Electronics.....	81
CATS.....	130
CB City International.....	130
CQ Bookshop.....	124, 125
CRB Research.....	132
C & S Sales.....	127
Cleveland Institute of Electronics.....	83
Colorado Comm. Center.....	38
CommPute, Inc.....	61
Communications Concepts Inc.....	127
Communications Electronics Inc.....	53
Contest Radio.....	91
Cushcraft Antennas.....	8
DX Edge.....	23
DX Engineering.....	96
Dahl Co., Peter.....	48
Datacom International.....	37
Delaware Amateur Supply.....	110
Delta Loop Antennas.....	38
Dentronics.....	97
Digitech Concepts.....	129
Doc's Communications.....	41
EDCO/DAIWA.....	74
ETO.....	64, 65
Electronic Engineering.....	128
Electronic Equipment Bank.....	133
Electron Processing.....	122
Engineering Consulting.....	103, 134
G4ZPY Paddle Keys.....	102
G.A.P. Antenna Products.....	134
GRE America.....	59
Gem Quad Products.....	91
Genwest Engineering.....	56
Geochron Enterprises.....	73
Grapevine Group.....	82
H & M Jewelry.....	85
Ham Radio Outlet.....	12, 13
Ham Station.....	99
Hamtronics, Inc.....	122, 131
Henry Radio.....	136
ICOM America, Inc.....	70, 71, Cov. IV
International Radio & Computers.....	90
International Radio Exchange.....	85
Jan Crystals.....	81
Jun's Electronics.....	97
K2AW's "Silicon Alley".....	130
Kantronics.....	138
Kenwood, USA.....	Cov. II, 1, 2

(Continued on page 139)

# RF POWER TRANSISTORS

We stock a full line of Transistors & Tubes for amateur, marine, and business radio servicing



Partial Listing of Popular Transistors in Stock

P/N	Net/Ea	P/N	Net/Ea	P/N	Net/Ea
BFR96	\$ 2.75	MRF1946A	\$17.00	MGF1402	\$17.95
CD2664A	24.00	PT6619	19.75	MRF901	1.50
Set: 4 Matched	110.00	PT9847	22.75	MRF911 & 966	2.50
ECG340	3.40	RF120	21.00	NE25137/25K205	3.25
MRF134	16.00	SD1229	12.00	NE41137/35K124	3.25
MRF136	21.00	SD1272	12.00	U309 & U310	1.75
MRF136Y	47.00	SD1278-1	13.75	2N4416 & J310	1.50
MRF137	24.00	SD1405	16.00	3N204 & 3N211	2.50
MRF138	35.00	SD1407	25.00	<b>OUTPUT MODULES</b>	
MRF141G	190.00	SD1428	29.50	(Partial listing only - call for numbers not listed)	
MRF148	34.00	SD1429-3	16.00	SAU4 440 LIN	49.50
MRF150	79.50	SRF2072	12.75	SAV5 158	42.50
MRF151G	179.50	SRF3662	29.50	SAV7 144	42.50
MRF153	395.00	SRF3775	13.00	SAV12 144 HT	23.50
MRF156	537.00	SRF3800	17.50	SAV15 222	58.75
MRF171	34.50	2N1522	11.95	SAV17 144 50W	66.50
MRF172	58.75	2N3553	3.00	M57713 144 LIN	49.50
MRF174	80.00	2N3771	3.50	M57726 144	59.95
MRF208	16.50	2N3866	1.25	M47727 144	69.50
MRF212	19.50	2N4048	11.95	M57729 440	69.95
MRF221	12.00	2N4427	1.25	M57732L	33.00
MRF224	16.00	2N5109	1.75	M57737 144	48.50
MRF237	2.00	2N5179	1.00	M57741L M/H	57.00
MRF238	16.00	2N5589	13.00	M57745 430	89.95
MRF239	17.00	2N5591	14.50	M57755 806	78.75
MRF240, A	16.50	2N5641	16.00	M57762 1296	59.75
MRF245	32.00	2N5642	16.50	M57764 806	74.00
MRF247	24.75	2N5643	19.00	M57712, M57733 use	
MRF248	35.00	2N5944	11.00	M57737, SC1019 SAV7	
MRF260	10.00	2N5945	10.00	SC1027 use SAU4	
MRF261	10.50	2N5946	12.50	MHW591	42.00
MRF262	10.50	2N6080	9.00	MHW710-1, 2, 3	61.00
MRF264	12.50	2N6081	11.00	MHW820-1	76.00
MRF309	60.00	2N6082, 3, 4	14.75	MHW820-2	82.00
MRF314A	33.00	2N6097	20.00	<b>SPECIAL TUBES</b>	
MRF315A	32.50	2N6255	2.50	6CA7/EL34	13.95
MRF316	64.50	2SB754	2.50	6CL6	11.75
MRF317	63.00	2SC730	4.50	6GK6	9.95
MRF327	62.00	2SC1307	4.75	6HF5 GE	14.95
MRF406	13.50	2SC1729	16.25	6JB6 GE	15.95
MRF412	22.00	2SC1945	5.75	6J56C GE	16.95
MRF421	26.50	2SC1946	18.75	6KD6 GE	18.95
MRF422	36.00	2SC1946A	16.75	6L6GC	11.95
MRF427	17.00	2SC1947	9.75	6LF6 GE	16.95
MRF428	50.00	2SC1955	9.00	6LQ6/6MJ6	16.95
MRF429	39.00	2SC1957	1.00	12BY7A	11.75
MRF433	11.00	2SC1969	2.50	572B/T160L	69.95
MRF448	73.50	2SC1971	4.50	Match Set/2	149.75
MRF449A	18.25	2SC2028	1.95	Match Set/4	299.50
MRF450	13.50	2SC2029	2.50	7581A/KT66	16.95
MRF450A	14.25	2SC2075	1.75	811A	15.95
MRF453	17.00	2SC2094	18.50	Match Set/2	37.90
MRF454	14.00	2SC2097	28.00	Match Set/4	75.80
MRF454A	17.00	2SC2097MP	62.00	813	44.75
MRF455	11.25	2SC2099	29.50	833A	89.75
MRF455A	12.75	2SC2166C	2.00	833C	99.75
MRF458	20.00	2SC2221	8.25	845	58.90
MRF475	6.75	2SC2237	7.00	M2057 GE	24.75
MRF476	4.00	2SC2284A	24.75	5894	44.95
MRF477	13.75	2SC2289	13.75	6146B	14.95
MRF479	13.75	2SC2290	14.75	6550A	16.95
MRF485MP	19.75	2SC2290MP	39.50	8950	20.75
MRF492	14.75	2SC2783	28.50	3-500Z	114.75
MRF497	18.75	2SC3101	12.25	4CX250B	79.95
MRF515	2.50	2SC2312C	4.75	4CX300A	142.25
MRF555	3.00	2SC2379	31.25	4CX1000A	459.95
MRF557	5.25	2SC2509	9.00	8877	599.50
MRF559	2.25	2SC2539	19.75	<b>EIMAC TUBES</b>	
MRF607	2.50	2SC2559	28.25	8874	359.50
MRF629	3.25	2SC2630	23.00	8875	399.95
MRF630	3.75	2SC2640	15.00	3CX800A7	339.95
MRF641	20.50	2SC2641	16.00	3CX1200A7	469.00
MRF644	23.00	2SC2642	28.25	3CX1500A7	699.50
MRF646	26.00	2SC2694	46.75	3CX3000A7	719.95
MRF648	31.00	2SC2695	31.75	4CX250B	99.95
MRF660	13.25	2SC2782	32.75	4CX350A	199.50
MRF843, F	21.00	2SC2879	21.00	3-500Z	134.75
MRF846	37.75	2SC2904	32.50	4-400C	159.95
MRF873	29.75	2SC2905	34.50		
MRF1946	15.00	40582	9.50		

Prices Subject To Change Without Notice  
 MATCHED & SELECTED TUBE AND TRANSISTOR FINALS  
 IN STOCK FOR AMATEUR AND COMMERCIAL EQUIPMENT  
 Orders received by 1 PM PST shipped UPS same day.  
 Next day UPS delivery available • We Export  
 No extra charge for C.O.D. (cash) or VISA/MC Orders  
 Ship/Hand. 1 lb. U.S. or Foreign Sm Pkt Air 8 oz. \$5.00  
 Minimum Order \$20 Quantity Pricing Available

ORDERS ONLY - (800) 854-1927 - NO TECHNICAL

ORDER LINE • INFORMATION • TECH HELP  
 (619) 744-0728

FAX 619-744-1943



**RF PARTS COMPANY**  
 1320 Grand San Marcos  
 California 92069



**RF PARTS**  
 1320 Grand Avenue  
 San Marcos, CA 92069

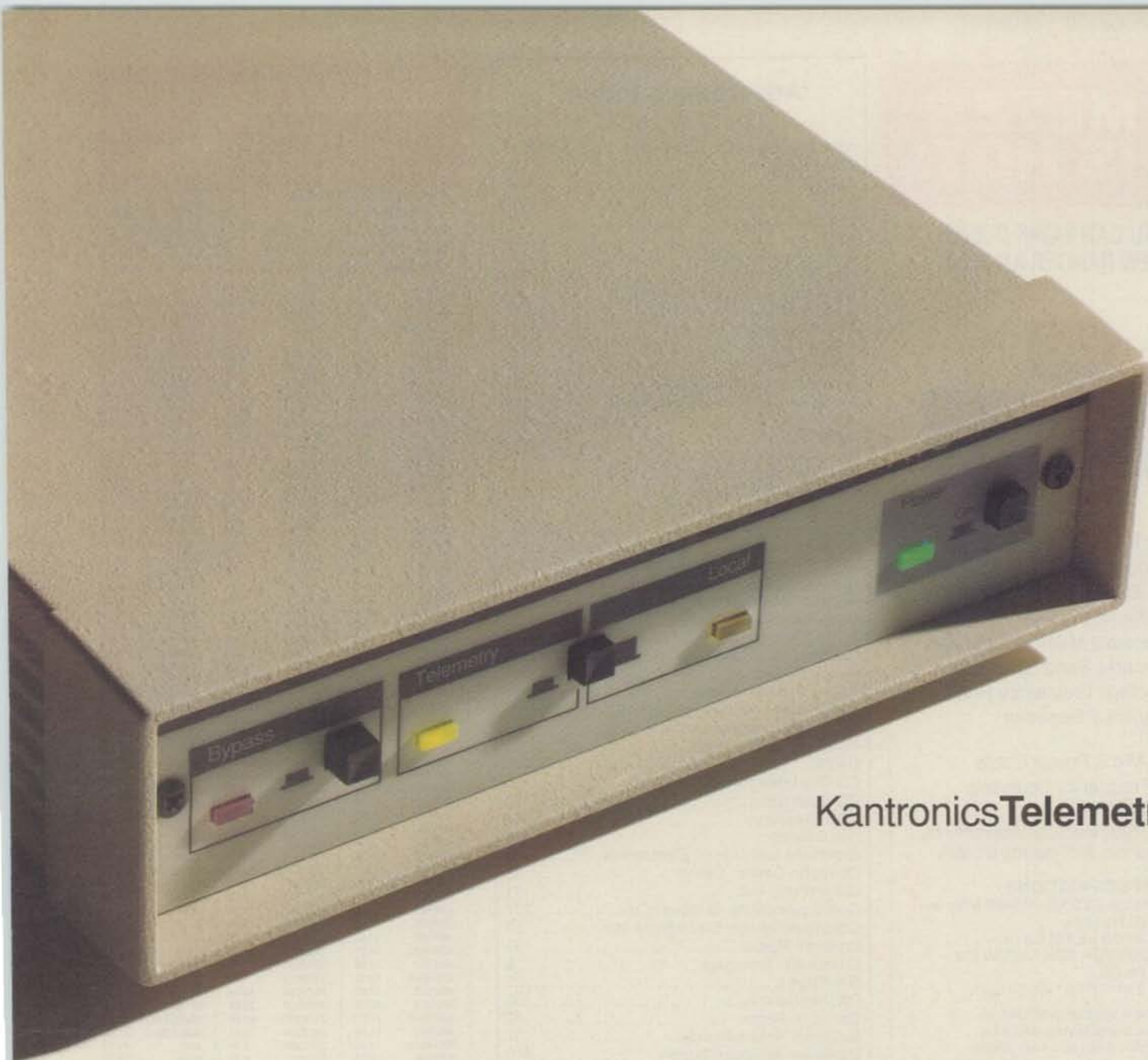

## Kantronics Telemetry Unit

### KTU remote sensor

Designed for the growing number of new communication applications, the Kantronics Telemetry Unit (KTU), for the first time, brings remote data gathering and distribution within reach.

Accepting input from up to 7 sensors and working with special purpose EPROMS, the KTU can collect a range of environmental data and distribute it, through an external TNC, to users in a Local Packet Network.

Included with the KTU is the Weathernode EPROM (the first in a series) which provides temperature sensing and, with the optional weathervane, can supply wind speed and wind direction data.

The KTU connects to the serial port of any TNC or may be connected directly to a computer's serial port. It is easily adapted to multi-site installations and may be remotely accessed, with password protection, and programmed for specific requirements.

The Kantronics KTU, the first to provide remote data sensing to a Packet LAN.

Kantronics 1202 E. 23rd St., Lawrence, KS 66046, 913.842.7745 TELCO BBS 913.842.4678





## R-X NOISE BRIDGE



- Learn the truth about your antenna.
- Find its resonant frequency.
- Adjust it to your operating frequency quickly and easily.

If there is one place in your station where you cannot risk uncertain results it is in your antenna.

The Palomar Engineers R-X Noise Bridge tells you if your antenna is resonant or not and, if it is not, whether it is too long or too short. All this in one measurement reading. And it works just as well with ham-band-only receivers as with general coverage equipment because it gives perfect null readings even when the antenna is not resonant. It gives resistance and reactance readings on dipoles, inverted Vees, quads, beams, multiband trap dipoles and verticals. No station is complete without this up-to-date instrument.

Why work in the dark? Your SWR meter or your resistance noise bridge tells only half the story. Get the instrument that really works, the Palomar Engineers R-X Noise Bridge. Use it to check your antennas from 1 to 100 Mhz. And use it in your shack to adjust resonant frequencies of both series and parallel tuned circuits. Works better than a dip meter and costs a lot less.

Order yours today! Model RX-100 \$69.95 + \$4.00 shipping/handling in U.S. and Canada. California residents add sales tax.

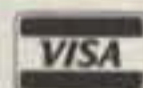

Send for FREE catalog that shows our complete line of noise bridges, SWR meters, preamplifiers, loop antennas, VLF converters, baluns, toroids and more.

# PALOMAR ENGINEERS

BOX 455, ESCONDIDO, CA 92033  
Phone: (619) 747-3343

## Advertiser's Index

Lakeview Co.....	132
LaRue Electronics.....	47
MFJ Enterprises.....	31, 33
Madison Electronics.....	107
Martin Engineering, Glen.....	32
Maxcom Inc.....	135
Memphis Amateur Electronics.....	103
Missouri Radio Center.....	140
Motron Electronics.....	59
Multifax.....	87
N4EDQ Amateur Radio Sales.....	56
NCG Company (Comet Antennas).....	106
Navy Special Co.....	51
Nemal Electronics.....	35
Oklahoma Comm. Center.....	126
Omar Electronics.....	130
OPTOelectronics Inc.....	21
PASS Publishing.....	96, 131, 135
PC Electronics.....	41
Pacific Cable Co.....	100
Palomar Engineers.....	38, 139
Payl Software.....	59
Periphex Inc.....	76
Phillips-Tech Electronics.....	128
Pilot Electronic Co. Inc.....	113
Pouch, The.....	100
QSLs by W4MPY.....	132
QSO Software.....	113
Quantum Instruments.....	67
Quorum Communications.....	103
RF Concepts.....	77
RF Connection.....	135
RF Enterprises.....	43
RF Parts.....	137
Radio Amateur Callbook.....	102
Radio Engineers.....	132
Radio Repair by Ed Kuhnley.....	135
Radio Shack.....	49
Radio Works.....	81
RadioKit.....	93
Renaissance Development.....	135
Reno Radio.....	109
Ross Distributing.....	130
SGG, Inc.....	19, 121
Satellite City.....	105
Schultz, Jack, L.....	129
Sherwood Engineering.....	102
Sierra Technologies Group.....	9
Sinclabs, Inc.....	85
Smiley Antenna Co.....	107
Sommer Antenna Systems.....	130
Spectrum International.....	122
Spider Antennas.....	87
Stinson, Walt, Radio Op's World Atlas.....	93
Surplus Sales of Nebraska.....	86, 87
Synthetic Textiles.....	130
TCE Laboratories.....	128
TNR Technical, Inc.....	85
TX RX Systems Inc.....	85
Telex-HyGain.....	66
Telrex.....	101
Ten-Tec.....	63
Texas Towers.....	27
Trans World Cable Co.....	135
Traxit.....	41
Tropical Hamboree.....	36
Tucker Surplus Store.....	39
UNR-Rohn.....	87
Universal Amateur Radio.....	91
Universal Manufacturing.....	93
VHF Communications.....	59
W5YI Marketing.....	81
W9INN Antennas.....	93
W & W Associates, Batteries "R" Us.....	107
West Radio School, Gordon.....	29
Wilam Technology.....	97
Williams Radio Sales.....	100
Wrightapes.....	132
Yaesu Electronics.....	75, Cov. III
ZCo Corporation.....	132

We'd like to see your company listed here too. Contact Arnie Sposato, N2IQO, at 516-681-2922 or FAX 516-681-2926 to work out an advertising program tailored to suit your needs.

## TUNER-TUNER™



- Tune your tuner without transmitting.
- Save those finals!
- Operate easier, faster.

**Do you use an antenna tuner?** Then you need the new Palomar Tuner-Tuner to tune up your tuner without turning on your transmitter. The Tuner-Tuner connects between your tuner and your rig.

### Here's how it works:

1. Turn on the Tuner-Tuner. You'll hear a loud S9+ noise.
2. Tune your tuner until the noise drops out completely.
3. Turn off the Tuner-Tuner.
4. Start transmitting. SWR will be 1:1.

**What could be simpler?** You can tune up while listening to the other station call CQ. No need to move off frequency to tune up. No need to cause interference while tuning. No need to operate your rig into anything but 1:1 SWR.

### Users say:

"My new PT-340 Tuner-Tuner is fabulous!"—W9DXP (Illinois)

"The Tuner-Tuner is really a nice piece of equipment. It does everything you said it would do. FB OM."—K5JDF (Texas)

"This is a record as far as speed in deliveries go, and I have been extremely happy with the Tuner-Tuner's performance."—9V1XH (Singapore)

"I have to make a comment on your Tuner-Tuner - one word only - FANTASTIC."—W3IOT (Pennsylvania)

**Order yours today!** If you use a tuner you need a Tuner-Tuner.



Model PT-340 Tuner-Tuner only \$99.95 + \$4 shipping in U.S. & Canada. Calif. residents add sales tax. FREE catalog on request.

# PALOMAR ENGINEERS

BOX 455, ESCONDIDO, CA 92033  
Phone: (619) 747-3343

**ORDER  
TOLL-FREE  
1-800-821-7323**

MasterCard—VISA—Discover—COD

# RADIO CENTER

USA

AEA • ALINCO • ASTRON • ALPHA-DELTA • AMERITRON • ANTENNA SPEC • B & W • BENCHER • BUTTERNUT •

## KENWOOD



### TS-950SD

TRANSMIT THE ULTIMATE SIGNAL

- Digital Signal Processing
- Dual Frequency Receive
- Digital AF Filter • 100 Memories

**CALL FOR DETAILS AND ORDER TODAY!**

## YAESU



### FT-1000

THE BEST OF THE BEST

- 200 Watts Output
- All Amateur Bands
- Dual Receive
- DDS-Direct Digital Synthesis

**CALL FOR ALL THE DETAILS!**

## ICOM IC-765



### ADVANCED PERFORMANCE HF TRANSCEIVER

- DDS (Direct Digital Synthesizer)
- Auto. Antenna Tuner
- 100 Watts Output
- 99 Memories

**CALL TODAY!**

## ALINCO



### DR-590

2 METER/440 MOBILE

- 45 W/2 Meter 35 W/UHF
- Cross Band Repeater Function
- Receiving and Scanning on Both Bands
- Detachable Front Control Panel

**CALL FOR DETAILS!**

## KENWOOD



### TM-231A

COMPACT 2 METER FM

- 50 Watts, 20 Memories
- Multiple Scanning Modes
- Selectable, Built-in CTCSS Tone

**DON'T DELAY—CALL TODAY!**

## YAESU



### FT-470

COMPACT DUAL BAND  
FM HANDHELD  
(2M/70CM)

21 Memories for Each Band  
Dual VFO's for Each Band  
Up to 5 Watts Power  
Built-in CTCSS  
Built-in 10-Memory DTMF  
Autodialer

**CALL FOR ALL THE DETAILS!**

## ICOM IC-229H



### ULTRA COMPACT 2 METER

- Transmit 140-150 MHz
- Receive 136-174 MHz
- 50 Watts Output
- 20 Memories
- Simple Operation

**CALL TODAY!**

## ALINCO



### DR-570T

VHF/UHF TWIN BANDER

- 45W on 2M/35W on 70cm
- Receive on both Bands at Same Time
- Extended Receiver Range
- More Features for the Money Than Anyone Else

**ALL ALINCO SALE PRICED!**

## KENWOOD

### TH-27A

2 METER SUPER  
COMPACT HT

- Receive 118-165 MHz
- Up to 5 Watts Output
- CTCSS Encode/Decode Built-in
- Multi-Function Scanning
- TH-47A, 70 cm Model

**CALL TODAY!**

## Kantronics



### DataEngine

- High Speed Packet
- Internal 1200 Baud Modem
- Off The Shelf 9600 Baud Packet With The DVR 2-2
- Internal 9600 Baud, G3RUH Type Modem Available

**CALL TODAY!**

## ICOM

### IC-24AT

DUAL BAND  
FM TRANSCEIVER

- 140-150 MHz
- 440-450 MHz
- Compact and Lightweight
- Up to 5 Watts Output
- Versatile Scan Functions

**CALL TODAY!**

## ALINCO

### DJ-160T

DELUX 2 METER  
HANDHELD

- Receive 137-173.995 MHz
- 20 Memories
- 3 Watts Standard
- 3 Scan Modes
- Store Duplex/Simplex Pairs, Call Channel, 38 Encoding Subtones

**CALL TODAY!**

## MFJ SALE MFJ

LARGEST STOCK OF ALL  
YOUR MFJ FAVORITE  
ACCESSORIES  
CALL TODAY FOR  
BEST PRICE



### MFJ-1278

Multi-Mode Data Controller  
**CALL FOR EXTRA SAVINGS**

## HUSTLER

### G-10 10 METER COLINEAR VERTICAL

Fiberglass Construction  
1/2 Wave Gain Antenna

### SPECIAL SALE

**\$39.95**

(BELOW DEALER COST)

**LIMITED SUPPLY—CALL TODAY**

## CAROL CABLE

(Columbia Cable)

4080 Rotor Cable . . .22¢/foot  
4090 H.D. Rotor Cable . .34¢  
1108 RG8, Mini . . . . .21¢  
1198 RG8, Super Flex . .30¢  
1180 9913 Type . . . . .41¢  
1176 RG213, Mil Spec . .36¢

**10% DISCOUNT ON FULL ROLLS**

## ASTRON



• RS7A . . . . \$49	• RS35M . . \$159
• RS12A . . . \$70	• VS35M . . \$174
• RS20A . . . \$89	• RS50A . . \$199
• RS20M . . \$109	• RS 50M . . \$219
• VS20M . . \$124	• RM50M . . \$259
• RS35A . . \$139	• VS50M . . \$232

102 N.W. Business Park Lane Kansas City, MO 64150  
Send SASE For Used List

Call Toll Free - 8 AM - 5 PM Mon.-Fri. 9 AM - 2 PM Sat.  
In Missouri Call—816-741-8118

**WANTED: QUALITY USED GEAR. CASH OR TRADE**

CUSHCRAFT • DIAMOND • DRSI

HEIL • HUSTLER • HYGAIN

*The Best  
of the  
Best*

To be a star in international competition, you have to play your cards right. Stack the deck in your favor with Yaesu's FT-1000. It has all the features world-class winners demand.

Our Direct Digital Synthesis (DDS), for example, utilizes two 10-bit and three 8-bit DDS for fast lock-up and lower noise than traditional PLL systems. And continuously adjustable RF Power Output of up to 200 watts gives you excellent "Barefoot" output for pileups, plus generous drive for your linear. While the Stereo Dual Receive gives you two tuning knobs for easy spotting and



simultaneous reception of two different frequencies—for cross-band dual receive or diversity reception using two antennas, add the optional BPF-1 module.

The FT-1000 also has the optional Digital Voice Storage (DVS-2) to let you play back 16-seconds of receive memory and two 8-second (or four 4-second) messages in transmit. A fast-action Automatic Antenna Tuner offers 39 memories for quick band changes. The QRM Rejection Systems include cascaded filter selections, IF width control, IF shift, IF notch filter, all-mode squelch, dual-mode noise blanker and CW



Auto-Antenna  
Circuitry

audio peaking filter. Additional features include:

- 100 Memories.
- High Dynamic Range — 108dB.
- Multimode Selection on Packet/RTTY.
- CW Spot.
- Independent mode and filter selection on SSB/CW.
- Mode/Frequency/Filter Information Stored Independently in each VFO.
- Built-in Electronic Keyer Module.
- Twin Frequency Displays.
- Standard (FT-1000) and Deluxe (FT-1000D) Versions.

Be a Star Performer. For more information on the FT-1000 and other Yaesu amateur radio products call the Yaesu Dealer nearest you.

**YAESU**  
*Performance without compromise.™*

Yaesu Announces  
**One Year  
Limited Warranty**  
on all Amateur Radio Products

# STAR PERFORMER



CIRCLE 73 ON READER SERVICE CARD

# EXAMINE THE IC-725 PIECE BY PIECE



PA UNIT  
provides 100%  
duty cycle



CPU UNIT  
contains  
band  
stacking  
registers



DDS UNIT  
provides excellent  
signal-to-noise ratio

From the CPU to the DDS System to the final output board, the ICOM IC-725 is designed for you... the amateur who demands relentless performance.

Whether its fixed, mobile or portable operation you desire, the IC-725 will open your eyes to what amateur radio should be. World renowned for excellence in circuit design, versatility and dependability, the IC-725 is backed by a full one-year factory warranty.

But don't take our word for it. Examine the IC-725 yourself, it's waiting at an ICOM dealer near you.

## ICOM

CORPORATE HEADQUARTERS: ICOM America, Inc., 2380-116th Ave. N.E., Bellevue, WA 98004 (206)454-8155  
CUSTOMER SERVICE HOTLINE (206) 454-7619

CUSTOMER SERVICE CENTERS: 3150 Premier Drive, Suite 126, Irving, TX 75063, 1777 Phoenix Parkway, Suite 201, Atlanta, GA 30349  
3071 - #5 Road, Unit 9, Richmond, B.C. V6X 2T4 Canada, 2380-116th Ave. N.E., Bellevue, WA 98004

All stated specifications are subject to change without notice or obligation. All ICOM radios significantly exceed FCC regulations limiting spurious emissions. 725990

For a brochure on this or any other ICOM product, call our Toll-Free Literature Request Hotline 1-800-999-9877.

CIRCLE 70 ON READER SERVICE CARD