

Contents

CQ-TV 177

Contents ..... 1

Committee Contacts ..... 2

Editorial ..... 4

3cm Signal Strength Meter ..... 6

3cms Tips 2..... 7

A Video Inverting Amplifier ..... 12

24 cms ATV Transmitter Review..... 14

The TV History Man ..... 17

Two Satellite Receivers from One Dish..... 25

Satellite TV News..... 26

Report from G3VZV on Outcome of IARU Region 1 Conference. 39

A Tale of Alexandra Palace..... 43

BATC Accounts for 1995..... 46

Beyond TTL # 12..... 48

SPLASH - a Review ..... 54

SSTV or FAX?..... 63

TV on the Air ..... 66

Second Welsh Microwave Fast Scan ATV Tests ..... 73

BATC Rally 97..... 75

Signal Calculations..... 76

An Introduction to One Group's 24GHz Experiences..... 80

Post and News..... 88

For Sale..... 92

Wanted..... 96

Index of Advertisers..... 96

CQ-TV is produced on a P6 Gateway 2000 PC computer system, using the Word for Windows word processing package. The camera ready artwork is produced on an Hewlet Packard LaserJet 4 printer.

Edited by Ian Pawson with help from Trevor Brown, proof read by Peter Delaney. All rights reserved, all wrongs denied.

© 1997 by the BATC.

Printed by *Cramphorn Printers Ltd.*, 15c Paynes Lane, Rugby, England

## **Committee Contacts**

### **BATC Chairman Trevor Brown G8CJS**

Club affairs, Video tape library, Technical queries, especially relating to handbook projects. 14 Stairfoot Close, Adel, Leeds, LS16 8JR. Tel: 01132 670115. E-mail: batc@compuserve.com

### **BATC General Secretary Paul Marshall G8MJW**

General club correspondence and business. Library queries relating to the borrowing or donation of written material. Fern House, Church Road, Harby, Notts., NG23 7ED. Tel: 01522 703348. Email 101573.2170@compuserve.com

### **BATC Hon. Treasurer Brian Summers G8CQS**

Enquiries regarding club finances, Donations, and constitutional enquiries. 11 Harefield Road, Uxbridge, Middx, UB8 1PH. Tel: 01895 810144, Mobile 0850 014892

### **CQTV Magazine Editor Ian Pawson**

Anything for publication in CQ-TV, Articles, Review items, Letters to the editor, and other material except as below. 14 Lilac Avenue, Leicester, LE5 1FN, England. Email: ian@ipawson.cix.co.uk

**Photographs for the CQ-TV covers:-** Patrick White, Swyncombe, 8 Kingswood Court, Maidenhead, Berkshire, SL6 1DD, England

**TV on the Air:-** Graham Hankins G8EMX, 11 Cottesbrook Road, Acocks Green, Birmingham, B27 6LE. Tel: 0121 707 4337

**Satellite TV News:-** Paul Holland G3TZO, Chatterton, Chapel Lane, Threapwood, Nr. Malpas, Cheshire, SY14 7AX. Tel: 01948 770429, Email: 101705.1371@compuserve.com

**CQ-TV Advertising Manager:** Dave Hemingway, Ivanhoe, Glen Road, Hindhead, Surrey, GU26 6QE. Tel: 01428 604645

**CQTV Awards:-** Bob Webb G8VBA, 78 Station Road, Rolleston on Dove, Burton on Trent, Staffs., DE13 9AB. Tel: 01283 814582

## Exhibitions

**Rally 96:-** Mike Wooding G6IQM, 5 Ware Orchard, Barby, Nr. Rugby, CV33 8UF. Tel: 01788 890365, Fax: 01788 891883, Mobile: 0860 857434 Email: vhf-comm@g6iqm.demon.co.uk

**CAT 96:-** General arrangements and information about talks to clubs, demonstrations, lectures, etc. Paul Marshall G8MJW - Details above.

## Club Sales

**Members Services:-** PCB's, components, camera tubes, accessories, etc. (NOT PUBLICATIONS). Peter Delaney G8KZG, 6 East View Close, Wargrave, Berkshire, RG10 8BJ. Tel: 0118 940 3121

**Publications:-** Handbooks, Back copies CQTV, and anything related to the supply of BATC publications. **PLEASE NOTE NEW ADDRESS:-**

Paul Marshall, Fern House, Church Road, Harby, Notts., NG23 7ED, England. E-mail: 101573.2170@compuserve.com

## Membership

Anything to do with membership, including new applications, queries about new and existing membership, non-receipt of CQ-TV, subscriptions, membership records, data protection act. Dave Lawton G0ANO, 'Grenehurst', Pinewood Road, High Wycombe, Bucks., HP12 4DD. Tel: 01494 528899. E-mail: 100046.1056@compuserve.com

**Club Liaison:-** And anything of a political nature, co-ordination of ATV repeater licences. Graham Shirville G3VZV, The Hill Farm, Potsgrove, Milton Keynes, Bucks., MK17 9HF. Tel: 01525 290343. Email g3vzv@amsat.org

**Contests:-** Richard Guttridge G4YTV, Ivy House, Rise Road, Skirlaugh, Hull, HU11 5BH. Tel: 01964 562498

**BATC BBS Sysop:-** Brian Kelly GW6BWX, 12 Cotswold Way, Risca, Gwent, NP1 6QT. Tel: 01633 614376, BBS: 01633 614765. Email:brian.kelly@betwixt.dircon.co.uk

**Repeater Liaison:-** General enquiries and repeater affiliation. Graham Hankins G8EMX, 11 Cottesbrook Road, Acocks Green, Birmingham, B27 6LE. Tel: 0121 707 4337

## Editorial

The front cover shows a picture of the LT75 laptop VT edit controller from Panasonic. The tape format is called DVCPRO and is digital component. The format utilises video compression to reduce the video signals to one fifth of their original size. The compression is on a frame by frame basis and as such allows frame accurate editing. Powerful error correcting coding ensures minimal dropout. DVCPRO is a format aimed at broadcasters and reflects a broadcast price. Panasonic are also launching a domestic version called Mini DVC. This will use a smaller cassette but feature the same digital encoded signal. Mechanical adapters are also planned rather like the VHS C format used to enable the domestic tapes to be replayed in dual standard professional machines. Digital domestic equipment had to come and should enable production work and the inevitable multi generations to take place with acceptable end results unlike the present VHS standard. Watch this space.



CQTV 177 is my last offering as CQTV editor and CQTV 178 starts with Ian Pawson in the chair. Ian has held my hand and done all the back room work throughout my editorship and has now taken on the full mantel. I hope you will all show him the support and help you have shown me on what is a difficult and time consuming task. The down side, or upside of this change however you view it has enabled me to return to my column Beyond TTL which starts again in this issue with a new CPU the PIC 16C84. The rest of the editorial team remains unchanged with Patrick White designing front covers, Dave Hemingway as advertising manager and Dave Aston as draughtsman. I am still BATC Chairman and I am sure Ian will find me one or two corners to fill. The new format of colour pages and wider blend of articles ranging from Dickey Howett regular features on characters and events from TV history will I hope continue along with constructional projects such as the 24 GHz article that starts in this issue. Good luck Ian I am sure CQTV is in safe hands.

TREVOR BROWN, BATC Chairman.

# GB3XT Kits & Bits.

**GUNNMOD2 3cms  
ATV. TX. kit.** Very popular full feature Gunn diode TX. Complete with pre-tuned oscillator head. £30.00. PCB. kit less oscillator **£20.00**

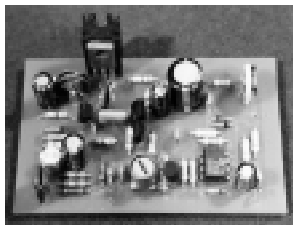

**TVRO3 ATV Tuneable  
IF/RX. kit.** Fully featured 750-1700MHz input. 12vDC operation. No setting up or alignment required. **£50.00**

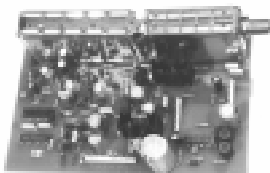

**24cms HIGH GAIN  
LOW NOISE  
GASFET PRE-AMP  
kit.** 40db gain 1db NF. with band pass helical filtering. 12-18vDC via coax. **£60.00**

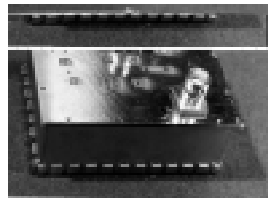

**24cms ATV TX. kit.** Full spec 5ch max. 2W o/p. Filters for video & audio. 12vDC. **£125.00**

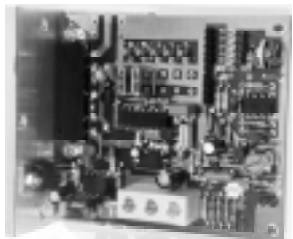

**3cms LNB's.** Brand new circular input. Fit 38-40mm mounting. will mount directly on most offset satellite dishes. 0.8db NF. 9.0GHz LO. **£40.00**



**DTMF DECODER  
kit.** Very high quality decoder IC. All o/p's buffered. Will directly drive TTL/CMOS or relays directly. Can be used to control whatever your imagination thinks of. **£12.00**

All kits contain all board mounted components and full comprehensive instructions.

Prices are all inclusive of P&P etc. PCB's are available assembled and tested at extra charge. SAE. (to take A4 paper) for further details.

Orders etc. to

**Bob Platts G8OZP, 220 Rolleston Road, Burton Upon Trent, Staffs, DE13 0AY.  
Phone 01283 531443, 7-9pm on weekdays only please.**

## 3cm Signal Strength Meter

By Barry Keedy G6LIC

A cheap, simple but effective signal strength meter for 3 centimetres can be constructed and cased in less than one hour.

On the rally and surplus market, at the moment, can be found Gunn oscillator modules fitted with tiny horns, for a few pounds each.

These are supplied in either transmit or transceive form.

The transceive version has a mixer diode as well as the Gunn diode in the same cavity. The connection of a 100 micro-amp meter across the mixer results in a field strength meter, which is capable of full scale deflection several feet from the transmitter.

The Gunn diode can be removed or left unconnected and the module, horn and meter fitted into a small plastic or metal case.

There are sometimes available "high power" X band Gunn diodes and the R.F. output of these devices can be measured and compared with the standard 12mW versions using the meter. The actual DC voltage across the Gunn diode also has a significant bearing on the R.F. produced.

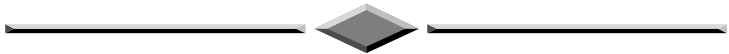

As the next issue of CQ-TV has to be with members *before* the Rally on April 27<sup>th</sup> ( see page 75 for full Rally details ), the deadline for articles is the last week in Feb. Please send your contributions in as soon as possible.

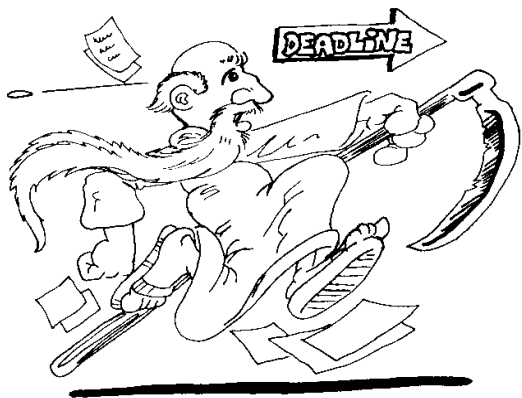

## 3cms Tips 2

### Bob Platts G8OZP

I regularly receive requests for basic information on 3cms ATV. For those of you who are inquisitive, I have put much of the basic information together here.

3cms ATV. is basically very simple to get started on. 3cms is one of the bands that has only recently become active. This is partly due to the availability of equipment and also the general increase in ATV activity. Much pioneering work has been done by myself and a few others, however there is still much to be learnt and discovered. Here in the UK simplex contacts up to 20 - 40 miles are fairly common place. Contacts over 100 miles are often achieved and under the right conditions far greater distances are possible. (I worked a two way over 366Km into Holland last August with just 10mW TX power).

#### **Transmitters.**

Low power Gunn diode oscillator transmitters are very popular. They are basically very simple, cost effective and capable of very good performance. The oscillator module can be mounted up a mast and fed via coax from the modulator PCB. Most Gunn diodes oscillator modules are low power devices.

8 - 10mW being typical, which does not sound much. However small ex satellite dishes have a gain of at least 24db giving an ERP. of about 4 Watts. I am often asked, "how to increase the output of a Gunn oscillator", to which I generally reply, "go for a bigger dish". 25mW and 300mw diodes sometimes become available on the surplus market but they are generally expensive. An alternative is to feed the Gunn oscillator into a wave guide transition, possibly via an attenuator, then into a GASFET amplifier. When using RF amplifiers for FM. ATV. one must be very conscious of the fact that the amp will be running at 100% duty and possible for long periods unlike SSB which is about 25% duty and for relatively short periods. Gunn diodes drift with temperature about a meg or so. However due to the fact that ATV bandwidth is about 20MHz this is generally of little consequence. Also changes in load impedance will also shift the frequency slightly.

Several designs have been published in CQTV. for Gunn diode modulators or alternatively there is my very popular kit. Do not try to use or adapt modulators designed for phone use. They often are unable to

## 3cms Tips 2

handle the complex video signal nor do they generate the audio sub-carrier signal.

I have designed and operate a GASFET TX based on a DRO. (Dielectric Resonant Oscillator) oscillator which produces 50mW. This feeds a pair of RSGB. microwave committee WDG amplifiers to produce 900mW. I hope to publish the design of the 50mW TX soon in CQTV. I have also developed a synthesised 3cms ATV transmitter which I hope to release as a kit in the future. A low power DRO based TX, based on a Marconi LNB was published in CQTV recently.

### **Receivers.**

This is now almost exclusively by means of an 3cms LNB's (low noise block converters) and a TVRO (television receive only (satellite receiver). The LNB. converts the frequency range 10 - 10.5GHz to

1 - 1.5GHz which is then fed to a TVRO (TeleVision Receive Only) for demodulation. The demodulated signal is then fed into the AV (SCART) input of a monitor (television). Domestic satellite receivers can also be used but may require modifications. Due to the lower deviation level used on ATV, the demodulated output from domestic satellite receivers will need to be further amplified by a video amp of about 2-4 times gain. Also some satellite receivers will not decode the 6MHz (5.5MHz) intercarrier sound channel without internal modification.

There are a couple of purpose designed ATV. RX's. One was produced by the BATC a couple of years ago and may still be available. The TVRO3 kit from myself has also proved popular.

Older, less sensitive mixer diode systems are now considered obsolete due to their high 12db+ noise figure. They use basically the same technique as older FM phone designs but with an IF of between 35 - 70MHz instead of 10.7MHz. The BATC members services use to provide a demodulator PCB. (less audio demodulator) for this frequency range. (may still be available). Several other designs have been published in past issues of CQTV. For serious operating such systems are not recommended. However it can be interesting to construct one so as discover just how poor their performance generally was.

### **Antennas.**

Horns antennas are by far the most common type of microwave antenna used. They can perform very well, are compact, easy to set up and point in the required direction. They can be home made with just a few basic



skills. The dimensions for many designs have been published in various publications.

(UHF VHF handbook. RSGB. Microwave hand book, UHF compendium, ARRL Micro wave experimenters hand book etc.). Some articles stress the importance of accurate construction. This in my experience is often over stated. Dimensionally horns can be very forgiving. Even the most crudest of construction can yeald good results. I have constructed many from a wide range of materials. Plain PCB material (foil to the inside), brass sheet, tin plate recovered from old oil cans and even aluminium foil glued on stiff cardboard, or coated with glass fibre.

Basically the larger and longer a horn the higher the gain and consequently the narrower the beam pattern. Small horns with lower gain and wider beam patterns are very commonly used to feed dishes. Small horns can sometimes be found on surplus radar intruder alarm units.

The maximum practical size for a horn antenna is 23db. Above this they tend to become a little to large and cumbersome and a small horn feeding a dish may prove better.

Dishes are generally favourite.(technically a dish is not an antenna but simply a reflector that focuses the signal onto the antenna). Prime focus dishes, often ex commercial types, can sometimes be found at rallies or advertised for sale. With this type, the antenna, often termed the feed, (a small horn) is mounted on an arm or tripod at the focal point, looking into the centre of the dish. The gain and performance of prime focus dishes can be very good, providing gains of around 20db for small ones up to 36db+ or so for 3 footers (1 meter). Three feet is about the largest practical size, unless you wish to get really serious, above that the narrow beam width (less than 2°) and sheer size makes them difficult. One possible drawback to prime focus dishes is mounting them. Often a bit of ingenuity and engineering is required.

By far the most common are satellite TV dishes of the offset type. As it's name implies the antenna (feed) is offset from the centre. An offset dish is actually a segment of a prime focus dish. If you were to take a prime focus dish, cut a petal shaped segment from the rim into the centre and angle the feed horn up to look into it, you would have an offset dish. This type of design is easier (cheaper) to manufacture and install. Offset dishes are usually supplied with either a wall or pole mounting bracket. I find the pole mount best as it can be rotated easier. Again the larger the dish the higher the gain. small ex. BSB dishes (12 -14") are about 20-24db up to about 34db to 36db for the large 1.2 meter size. Due to their smaller

## 3cms Tips 2

surface area, offset dishes have slightly less gain than an equivalent size prime focus dish.

Aiming an offset dish is not as easy as a prime focus one. The approach I use is to mount the dish upside down (this also reduces the possibility of water getting into the feed horn) and angle it backwards so that it looks at the horizon. The exact angle depends on the dish design, but is generally with the rim of the dish at around about 30° ish.

The focal point of a dish is not a specific spot but an area. Depending on the accuracy of the dish it is typically an area of about 1" - 3" cube. The feed horn should be mounted such that the focal area is just inside the aperture of the feed horn. (Technically the point is known as the feed phase centre). This point can be found by studying the mounting position of the old satellite LNB. or by experimentation. In the case of prime focus dishes it can be calculated. (see handbooks mentioned earlier).

On smaller dishes two feed horns can be mounted along side each other in the same dish. A small amount of squint (max radiation in slightly different directions) is produced but with the wider beam width of small dishes this is often of little consequences. With larger dishes, due to the narrower beam width this squint is more noticeable and can be problematic. (24")dishes are about the largest that can be used with twin feeds.

Alignment of dishes, due to there high gain is more critical than most other antenna types. If pole mounted and rotatable, simply align at the horizon by using a remote transmission, ensure the mount is vertical otherwise the dish will not follow horizon as it is turned. A mechanism to tilt the dish up and down a bit is of great benefit, particularly on larger dishes which may only have beam widths of a few degrees. This is because there are situations when the signal may not come from the natural horizon. (Cloud scatter).

If the dish is mounted on a tripod for portable use, I find it best to use a bore sight or small (child's) telescope. I do not use compass bearing as I find they can be to inaccurate. Read my article. 3cms operating tips, from CQTV.166 P31.

### **Propagation.**

The low noise figure provided by modern LNBs now means that propagation is no longer restricted to line of sight paths. 3cms signals tend to be scattered by trees and buildings. This can be used to advantage sometimes. 3cms signals will pass through many materials but are often reduced in strength by scattering or absorption. Best 3cms performance is

over clear paths and with just 10mW TX power line of sight paths well in excess of 100Km can readily be worked. Obstructed paths will be much less though. 3cms signals can sometimes be refracted over hill tops (knife edge refraction) or even scattered off clouds to give increased range. Lift conditions on 3cms are more common than 24cms and a certain lift condition called tropospheric ducting can enable communication over many hundreds of Kms. Sea surface propagation a mode which I have done much research on offers exciting possibilities. Cloud scatter could also provide interesting results.

Weather proofing permanent installations is essential. Self amalgamating tape is best for connectors. Gunn oscillators etc. may be fitted in plastic or metal enclosures. For metal ones drill and file out a hole the same internal size of the wave guide. Then drill the mounting holes and clamp the box between the oscillator flange and the wave guide or horn flange. The same technique can be used on thin plastic boxes. To prevent water entering thin clear plastic (do not use black, it may contain conductive carbon) may be clamped in the flange with some Vaseline or gasket sealant. Alternatively plastic film can be glued across the horn aperture. Do not use silicon sealants as they often produce acetic acid during their curing process which will cause corrosion.

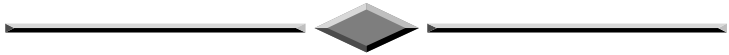

# World Wide Web

The BATC web pages have now moved to a new and permanent address. They can be found at:-

<http://ourworld.compuserve.com/homepages/batc>

A new feature is a software download area. This page contains programs, data and articles from CQ-TV as well as other programs related to amateur television.

## **A Video Inverting Amplifier**

**By Pete Carliell**

This project was inspired by photography. My mother had a large collection of old negatives and wanted to see if any were worth printing. In a negative it is nearly impossible to recognise a person, and so this device was made to provide a positive television image - it even works in colour.

The negative must be scanned by a television camera (a close-up lens may be necessary) which will provide a base-band video output. I used a video 8 camcorder, cardboard negative carriers for 35mm, 127, 120 etc films, a lamp and a white card reflector. The type of light source is only important for colour pictures. Daylight is ideal - tungsten light needs a different colour balance but it does contain all colours.

Having derived a television waveform you might think that a simple common-emitter inverter is then all we need. This, however, would give whiter than white syncs and not be of any use at all. The syncs, and in fact all of the blanking intervals, have to be gated out so that the original non-inverted syncs and blanking can be put back. Re-creating blanking is not that easy since it starts before the syncs that can be used to detect it. In this design an SAA1043 SPG chip IC4, genlocks to syncs separated from incoming video by IC3, and provides mixed blanking. To make equal amplitude normal and inverted video an NE592 (IC1) is used, and switching between them is done with the fast video switching IC TEA 5114 (IC2), - actually three switches in one chip.

IC2 expects positive-going video and DC restores sync tips of its inputs to an internal reference, which of course will not work with an inverted input. This input on pin 7 is therefore clamped to a suitable higher potential. To set up the device a sawtooth input is best. Adjust RV1 for 0.7V picture and set RV2 for correct blanking level, as observed on a 'scope.

The prototype Inverting Amplifier, which is made from a collection of BATC circuits, was built as an add-on to the "Fade To Black with A-B Mixer" that I described in CQ-TV 160. There was already a '592 with normal and inverted videos, a '1881 sync sep, and a spare section of a '5114. The '1881 input is buffered by a simple emitter follower. This was only necessary to avoid a chroma/burst phase error caused by a loading effect of the '1881's input filter. All I had to add was the pulse generator chip (plus components), which can also double as a station s.p.g.

## A Video Inverting Amplifier

The device works on PAL - coded colour because the burst is not changed (being in Line Blanking it is gated through uninverted) but colour vectors are given a 180° phase reversal whilst keeping amplitude correct. This creates a very interesting effect on colour bars and normal pictures, and a reasonable picture can be produced from a colour photographic negative.

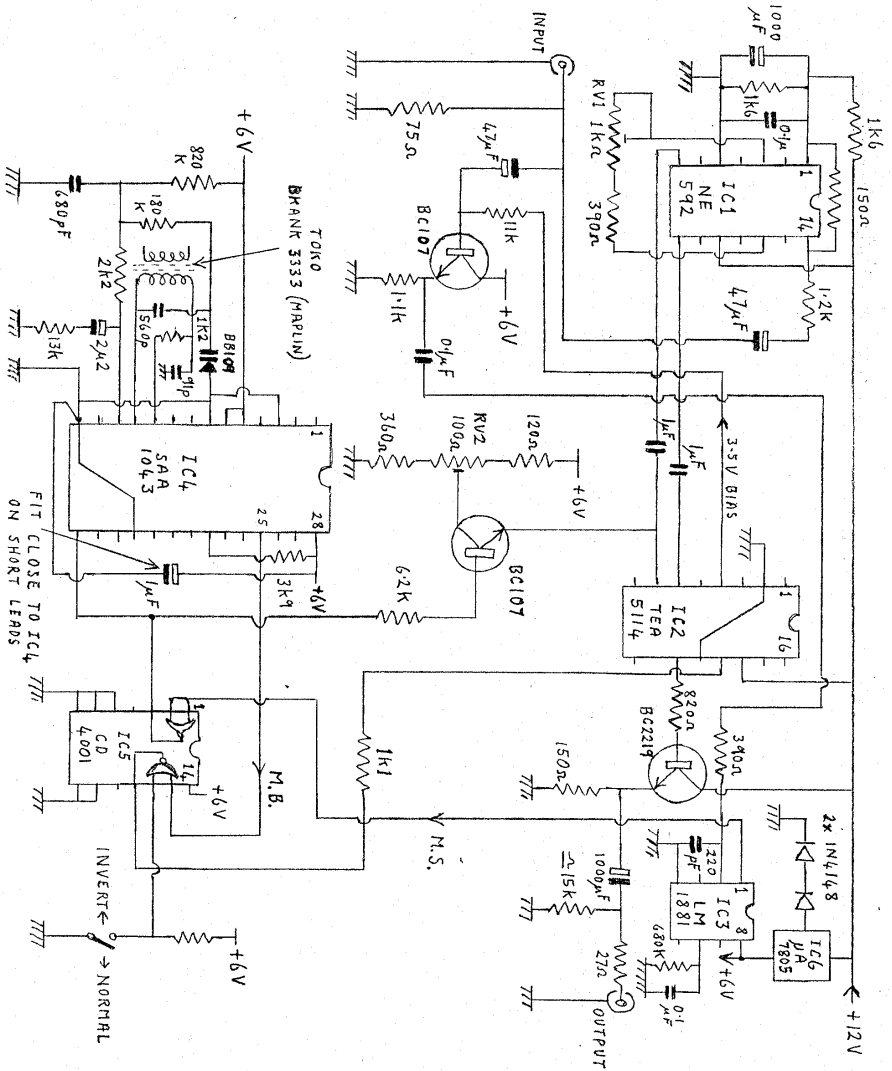

## 24 cms ATV Transmitter Review

### Bob Robson GW8AGI

Needing a second transmitter for when I go out portable ATV working I scanned the mag and my attention was drawn to a kit that might just be what I was looking for.

I phoned Bob Platts who designed and supplies the kit who provided further information.

He explained that the kit produced a high quality FM. ATV. TX. providing about 2Watts output. The output is synthesised to Xtals for each channel, up to a maximum of five. The kit was supplied with two Xtals for 1260mhz (simplex) and either 1248 or 1249MHz (RMT1-2 or RMT1-3) depending on requirements. The video modulator incorporates standard pre-emphasis and a 5.5mhz low pass filter which prevents transmission of excessive high frequencies. The 6mhz audio subcarrier (5.5MHz or 6.5mhz to special order) modulator incorporates a limiting amplifier, and an output filter to prevent excessive deviation and transmission of harmonics. Selectable audio pre-emphasis is also provided. All this is on a single 3" square PCB. which includes an angle bracket for mounting to a heat sink. Bob explained that a few surface mount devices were used but only where necessary in the carrier oscillator. Bob assured me that construction was strait forward and fully documented also that alignment was very simple. I parted with my money and eagerly awaited the kit which duly arrived a few days latter.

When the package arrived I found a very well made PCB with plated through holes and various small plastic bags with the components marked where necessary - i.e. surface mount devices, 3v3 Zener etc. on the bags, and six pages of diagrams, assembly instructions and a sheet containing advice and handling instructions for surface mounted components, (very useful for people who have not used these devices before).

Before switching on the soldering iron I sat down and read all the sheets from beginning to the end, and checked the parts list, board and components to make sure I knew what each item was and where it fitted on the board.

Now was the time to switch on that soldering iron, but first I fitted it with the smallest bit I had got (3-4 mm diameter approximately) for the surface mounted components which had to be soldered on first. At this point Bob & I differed slightly on technique. Bob advised tinning the

board pad where the component was to be placed, then placing the component, heating the connecting pad and so melting the solder to hold it in place, soldering the second pad, then resoldering the first one again. My method is to tin one end of the component, place it on its pads, heat the tinned end again to hold it in place, solder the second end, then finally solder the first end again. My theory is that the connecting pads on the device have been exposed to the air for a lot longer, probably, than the PCB pads and therefore have a greater chance of being oxidised. By tinning the connecting pad first there is more flux available to cut through any oxide present, and the residue on the tinned pad is sufficient to break down any oxide on the PCB pads. That's my theory & I'm stuck with it!

First I soldered all the surface mounted components then all the others in increasing height, fitting the crystals last. I temporarily mounted the heatsink which is a right angle bracket to which is fitted the RF. PA brick and a voltage regulator. Then set the regulator to the correct height to bolt it on then 'tacked' one pin, removed the heatsink then soldered all the pins, cutting off the surplus length. I again temporarily mounted the heat and checked that there were no component leads going to short out to the heatsink.

All was well so I applied the thermal jointing compound to the RF brick and the regulator and fixed the heatsink in place. (As I was going to mount the TX. in a die-cast box I had drilled the box & the heatsink prior to adding the jointing compound - the job is a lot less messy then! ).

Connections for Video, Audio & power, plus the channel select switch are made by connectors. I mounted the completed TX. in the diecast box which doubled up as heat sink, made up the connecting wires to the power switch, video and audio inputs. Finally a short length of coax was soldered from the PCB to a BNC connector for RF output.

The moment of truth was now at hand. First I connected a dummy load to the RF connector and a test signal to the Video in. Applying power followed by a quick check for any smell of burning and no dip in the meter on the 12 volt supply boded well! Tuning the shack video receiver found a picture, but not at the selected frequency, but at least it was working. Getting out my trimming tool and following the setting up instructions soon had it on frequency. I then set the deviation control to mid point which provided a good stable picture on my RX. Finally I set the frequency of the sound carrier.

When I connected up a microphone I didn't get any modulation. Checking through the diagrams revealed why. Yours truly had misread

## *24 cms ATV Transmitter Review*

the connecting diagram for the audio connector and had got signal & ground reversed. Reversing the leads cured the problem. Now for the acid test. ON AIR !!

A contact with a local station gave me a report that my deviation was low. Turning up the deviation cured the problem, but also showed that with the control at maximum the modulation goes rather non-linear. I contacted Bob about this problem. He informed me that he knew of this, however with the control at max. the deviation is about 4.5 - 5MHz which is well beyond the 2.5 - 3MHz recommended for ATV. (Due to the use of satellite receivers I suspect that some people are using greater deviation than should be to give acceptable output on ex satellite RX's instead of caring out the normal mods). Why had my shack receiver shown a correct signal level on initial tests? Well I have a video gain control on my RX and as is common it has no calibration marking and is simply set for 'best results.!!

So what do I think about the kit? The on air tests gave good results after adjusting the deviation, and the audio is clean and pleasant (allowing for my voice). Whilst perhaps it is not for the very beginner due to the use of a few surface mounted components and a reasonably good level of competence with the soldering iron is called for. The kit is very good value for money. It is easy to assemble and set up, compact and works well BUT you MUST read the instructions through before commencing construction. At the time of writing the unit has not been thoroughly lab tested against the supplied spec. but I have no reason to suspect it is inaccurate. The output has been checked on a spectrum analyser and proved clean.

The kit I received, Bob explained, was one of the very first and I did find one or two minor problems, mainly with the paperwork, which Bob & I resolved over the telephone and Bob has now updated all the data sheets now supplied in the kit. But these problems apart I found the kit very easy to assemble and set up. All in all a good buy. Thanks Bob.

**Please mention that you saw it in CQ-TV  
when responding to advertisers**



## The TV History Man

*Dicky Howett visits the National Museum of Photography, Film and Television and talks to the Head of Television Development, John Trenouth.*

John Trenouth is a man in his own TV Heaven. Specifically, his job description covers all aspects of television at Bradford's famous National Museum of Photography, Film and Television (henceforth referred for brevity as the NMPFT). John also functions in a humbler capacity as part of the team, taking his turn manning the Museum's Information Desk. This task involves keeping a steely eye on parties of sticky-fingered Continental school kids (one was caught walking out with one of the exhibits under his arm—a dummy head of Arthur Askey complete with wig and specs) as well as re-uniting mislaid snotty kids with parents. John's 'Duty Officer' work means really mixing with the masses (on some days twelve thousand of them). It doesn't end there. If a projectionist is ill, then sometimes John takes over, perhaps running part of the NMPFT's latest installation, the three-projector Cinerama theatre. Never a dull moment at the NMPFT.

If John Trenouth seems to be seriously overworked, he is definitely understaffed. It's a question of numbers. The Museum has twelve curators for film and photography but only one curator for television, namely John Trenouth. Apparently, the reason for this arbitrary imbalance is that 'Television' is considered but an infant 'art' clocking in at a mere 71 years of age. This is in contrast to 'Film' at 109 years of age and 'Photography' at 158 years of age. A total figure of 267 years against 71. Ageism notwithstanding, John has also the task of overseeing the other television collection, albeit smaller, at the Science Museum in London. Combined on both sites, his job is to acquire, organise and arrange material for South Kensington's and the NMPFT's ever expanding television exhibitions and teaching courses.

As an example of John's valuable work, on display a few summers ago (in the NMPFT's forecourt) was the museum owned ex-BBC TV type 2 o.b. colour scanner complete with a roof-mounted EMI 2001. Both relics were state-of-the-art TV monsters from the early 1970's. The van was featured as a 'walk through' display with banks of monitors, control units, waveform monitors, U-link racks and mixing desks described by helpful video commentaries on the van's monitors. Sensibly, all vital switches and valuable bits were protected from fidgety fingers by thick perspex!



**The Museum entrance**



**Spot the dummy! Dicky Howett mans the replica Emitron cameras in the Museum's 'Alexandra Palace' studio re-creation.**

Within the Museum proper there are always significant exhibitions and displays, themed as appropriate. As an example, in 1993 the NMPFT mounted a fascinating 40th anniversary display of Coronation Year entitled 'The 1953 Show'. Artefacts displayed included photographs, newsreels, and news movie cameras. On the television front, two glass cabinets held respectively a Pye Mk III image orthicon camera (ex-ABC TV) and a Marconi Mk II image orthicon camera. Both these camera types were used by BBC Television for the Coronation outside broadcast. In this instance the NMPFT had cheated slightly because the Pye camera was an ITV interloper with an added 'BBC' badge but the ex-BBC TV Marconi Mk II camera was actually there!



**An ex-BBC early 1970's 'Type 2' colour control van, part of the Museum's large television collection.**

Although the NMPFT is primarily photography and film, television is gradually taking centre stage. Installed recently is an innovation called 'TV Heaven'. This is a free facility where anyone can access a favourite programme from the 'video library' (currently over 1,000 pre-selected items) and watch it, wearing headphones in a booth. (This is similar to the system run by the New York Museum of Radio and Television. The New York museum charges 5 dollars. The NMPFT's facility is free!) Elsewhere, the NMPFT continues to display some of its unthemed or uncategorised 'treasures' - for example, an original Le Prince movie

## *The TV History Man*

camera of 1889, and an oversized Sony HDTV colour set of 1989. (Rather too big for the average living room, indeed the Sony TV set was as BIG as the average living room!) Also on show is a Baird 'Telechrome' electronic colour TV tube from 1946. A very rare item indeed. It was the last thing Baird was researching before he died.

Very much alive, John Trenouth's interest in television was sparked at the age of nine when his father (a wartime radar technician) built his own 9 inch 'green screen' TV set out of redundant airborne radar parts. John watched the Coronation on this. Later, John built his very own TV camera out of a cardboard box and proceeded to 'film' the outside world around his Yorkshire Dales home.

Always fascinated by television, John eventually acquired his first operational television camera. This was a surplus surveillance vidicon begged from Rediffusion (cable-company division, not the broadcast dept). John found that if the camera's beam current was turned up and the camera pointed it at a white card, the street was still visible, imprinted for eternity on the photo-cathode.

So the video bug had bitten, and thereafter John sought out unwanted video equipment. This led him initially to a Marconi Mk III (ex-BBC Leeds), but John balked at the size of the kit (a truly heavy-weight outfit consisting of a control unit, power supply, vision and waveform monitor, cabling etc) plus the even heavier weight of a £400 BBC price tag. John was only a poor student in those days (1960's) and the enormous sum of £400 was something he didn't have. Reluctantly he had to let the Mk III slip through his fingers.

Eventually, John secured his first ex-broadcast camera which was a Pye Mk III. John tinkered with this, firing up the 3 inch image orthicon (a bold move indeed considering the dodgy nature of aged capacitors) and generally restoring the tatty blue bodywork. Much later John sold the camera to Thames TV engineer Bob Warren for his classic 'Thames Collection' of ancient TV equipment. (For those unfamiliar with Bob Warren's collection: whilst at Thames, Bob gathered and indeed rescued from oblivion many classic cameras and restored them with the help of trainee technicians. An example of serendipitous technological husbandry. What better way to train than by 'hands on' and useful restoration?) Ultimately, the Collection was loaned to and now resides in storage at the NMPFT. By that coincidental route, John Trenouth's very own Pye camera was returned to him. He knew it was his old camera because he recognised the Trenouth paint job.

In 1970 John became a teacher and he set up a black and white video studio to make 'teaching videos'. These short but academically valuable programmes were 'crash-edited' in between fades onto a half-inch Sony reel to reel machine. By all accounts these primitive tapes were very successful.

Later, to demonstrate a theory for a graduate thesis, John asked his class to watch, for half an hour, a recording of a monochrome BBC test card with music. This, the class did with admirable patience. And the theory? Well, perhaps John was stretching a point when he maintained (at the time) that kids would watch anything on TV.

Officially, John Trenouth is no longer an independent collector of television equipment. When he became Head of Television Development at the Museum he had to declare his interest and itemise his personal camera collection. Currently, this includes two fairly rare Marconi Mk III's, a Marconi Mk VII colour camera (which displays a red, a green and a blue picture but not all at the same time) and two EMI 2001 colour cameras, plus various mounts. John has also an immaculate Watson 5 to 1 zoom lens which was used by the BBC at the 1953 Coronation. (The interior casing is actually annotated to this effect). Occasionally, John augments Museum displays with his own camera gear.

The NMPFT's camera collection is reasonably large and it includes examples of cameras manufactured by Marconi, EMI, Pye, Philips, Link, Sony and RCA. However, due to restrictions of space, it's never possible to exhibit more than a small fraction of the camera collection. Usually only about four or five examples are displayed at any one time, spread around the various galleries. On permanent display however, perched on an iron man pedestal is an Emitron camera. This is part of a complete standard Emitron camera channel from 1937. (It's the only known surviving full channel. There are two further complete heads and three partly complete heads in existence, not all in the Museum's care. Of about 30 Emitron/Super Emitrons made, those six examples are just about all that remains of pre-war British electronic television hardware).

Expansion plans are now in hand for the NMPFT. Due to a recent award of European and National Lottery cash it will now be possible to increase the Museum's gallery space by at least 30 per cent. Land adjacent to the Museum will furnish the room to exhibit many more items of television interest. New methods of display will be incorporated including high definition interactive 'virtual studios'. (Sit back and take a digital trip round Lime Grove!) Alternatively, for the less adventurous perhaps a cosy 1950's studio re-creation featuring artefacts from programmes?

## *The TV History Man*

For the present, equipment acquired for the Museum's television collection is never subsequently 'tarted up'. (The ABC TV Pye camera in the '1953' exhibition was ex-o.b. and was quite chipped and scratched). However, all equipment is checked and cleaned efficiently, but any dents or marks are left in situ. John Trenouth emphasises that it is not the Museum's policy to recondition or cosmetically improve their stock.



### **An Emitron camera on display at the NMPFT.**

Ultimately, only the better examples are exhibited. It's an entirely different matter if equipment is sympathetically reconditioned before it is donated to the Museum. But as soon as it passes the Museum's portals it is frozen in time.

Also the Museum is now extremely wary about hiring its vintage camera equipment for use as props in movies; pop videos etc. Recently, some valuable gear was heedlessly damaged and parts were stolen. John Trenouth despairs of trying to make film makers understand that the Museum is not primarily (and now not at all!) a theatrical props hire company. It's TV collection is there in trust for future generations. Any dent or scratch carelessly added in the cause of 'art' depreciates the preservation. Even with insurance running at, in some cases several thousands of pounds, the simple fact is that the Museum hasn't the resources nor can afford the time to release personnel to guard the irreplaceable gear.

Although the NMPFT has many classic TV cameras, there are a few vital missing links. Recently the NMPFT acquired its own Marconi Mk II 3" image orthicon camera (1952) from a collector in Canada. (Only four complete examples of this camera are known to exist). This particular Marconi Mk II camera was run previously by the Canadian network, CBC. However, John Trenouth would like very much to hear of the whereabouts of any of the following, (in any condition and at any location): The EMI Super Emitron, Pye Photicon, Pye Pesticon, Pye Mk 4, and the Marconi Mk 8 Portable. Also any information about the reputed balsa wood mock-up of the EMI 3001 colour camera design. But sensible enquiries only please. Recently, a dealer offered the Museum a modest collection of television sets and video recorders. The asking price? A mere £300,000!



**Gallery exhibitions.**

John Trenouth can be contacted at The National Museum of Photography, Film and Television. Pictureville, Bradford BD1 1NQ. Phone: 01274 727488.

**Footnote:**

I would urge any reader of CQTV who has not yet visited this wonderful museum to do so without delay. There is no entrance charge (rare beast) only the IMAX super cinema show is charged for at £3.50 or so. If you live south of Northampton or north of Darlington, allow at least two days travel and viewing time. There's a lot to take in. You won't be disappointed. The museum is closed Mondays. Incidentally, the NMPFT has the country's highest museum **re-visit** rate. Can't be bad.

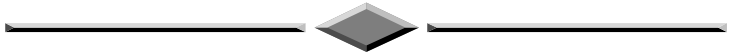

For members who are able to access the World Wide Web, the following sites may be of interest.

**Fujitsu** has a Web page at: <http://www.fujitsu.co.jp/index-e.html> with product descriptions and press releases, including a page at: <http://www.fmi.fujitsu.com/products/fpd/> that provides more information about plasma display panel televisions.

**Mitsubishi** has a Web page at: <http://www.mitsubishi.co.jp/> that provides more information about new television technology.

**Texas Instruments** has a Web page at: <http://www.ti.com> with information about the company's newest developments.

**Toshiba** also has a page at: <http://www.toshiba.com:80/tacp/SD/> that provides information about its DVD products

**Gateway** and **Zenith** have Web pages at: <http://www.gw2k.com/DESTINATION/> and <http://www.zenith.com/netvision.htm> that provide more information on their PC/TV products.

A monitor testing program, MONITEST.EXE (1.2MB), can be obtained from:

[http://www.nokia.com/products/monitors/monitor\\_test.html](http://www.nokia.com/products/monitors/monitor_test.html)

The following Web sites may also be of interest:

**IBM Corporation:** <http://ibm.com/>

Information about the satellite broadcasting services:  
<http://www.dbsdish.com/>

**Federal Trade Commission:** <http://www.ftc.gov/>



## Two Satellite Receivers from One Dish

By Dave Hemingway, G8EGG.

It is possible to use two satellite receivers from one dish with this simple adapter.

Take a short (300 mm) length of air-spaced coax, cut off about 50mm of the outer insulation at the centre and push away the braid.

Take a second length of solid core coax, trim back 50 mm of the outer cover and push back the braid. Cut and trim the inner insulation to expose about 25 mm of the centre conductor and carefully push the inner into one of the air spaces of the first cable, seal with a small piece of tape and join the outer braiding of both cables together.

Check with a test meter that there are no shorts between the centre conductors and the braid and that the two centre conductors are isolated. Finish off with a piece of heat-shrink or tape over the join and suitable connectors to the coax.

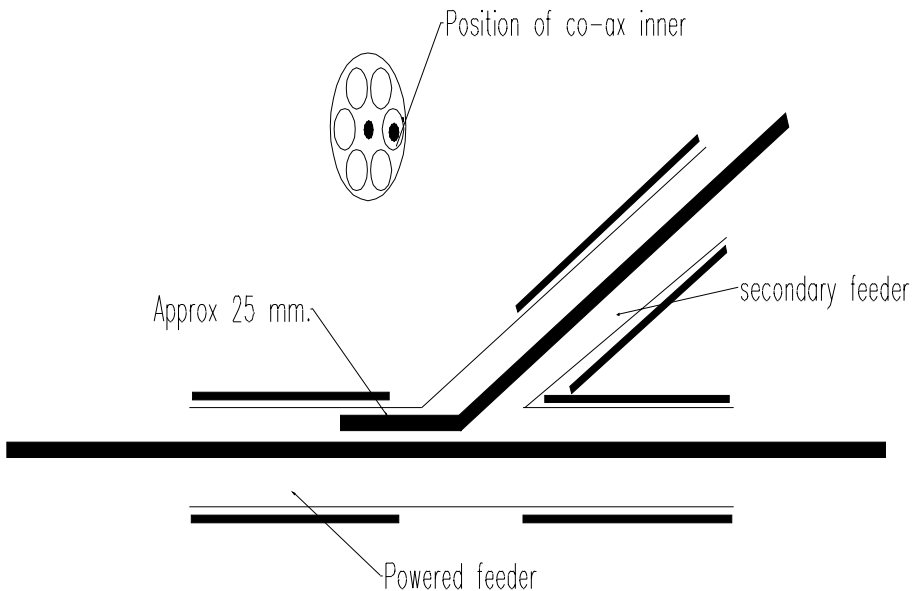

The only problem is of course that there will be no choice of polarity to the second receiver, the main receiver ('er indoors) changes polarity (usually at the exciting bit).

## Satellite TV News

By Paul Holland G3TZO

The new year before us brings the long forecast promise of digital Satellite TV services in the UK. This issue of Satellite TV News carries details of digital Satellite TV services available now over Europe as well as the usual mix of news essential to the serious browser of the Clark Belt!

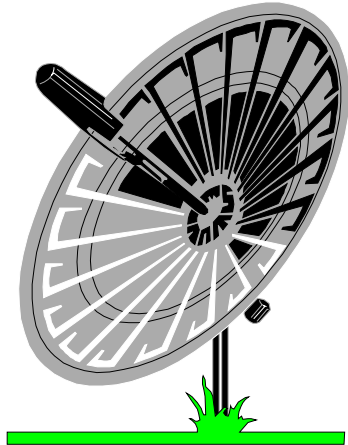

### LAUNCH NEWS

This year will see a significant increase in satellite TV capacity over Europe with launches from all the major operators plus a few new entrants. Extra capacity aimed at the Scandinavian region may have an advantageous spin off with footprints for the replacement Sirius satellite perhaps favouring the UK a little more than its predecessor.

### Launch Schedule

Satellite	Date	Position	Launcher
Panamsat 6	Dec 96	43.0 Deg W	Ariane
Thor 2A	Feb 97 (provisional)	1.0 Deg W	Delta II
Hot Bird 3	Feb 97	13.0 Deg E	TBA
Astra 1G	Jun 97	19.0 Deg E	Proton
Sirius 2	Jul 97	5.0 Deg E	Ariane
Nilesat 1	TBA '97	7.0 Deg W	Ariane
Astra 2A	4th Qtr '97	28.2 Deg E	Ariane
Intelsat 804	Sep 97	21.5 Deg W	Ariane
Hot Bird 4	Oct 97	13.0 Deg E	Ariane

## Arabsat 2B

Launched back in November Arabsat 2B is located at 30.5 Deg E and will carry regional telephony, TV and radio as well as digital SNG and VSAT services. All DTH TV traffic is being concentrated at the Arabic Hot Bird Location of 26.0 Deg E on Arabsat 2A. Eventually a third satellite, Arabsat 2C, will co-locate at 26.0 Deg E to provide additional capacity.

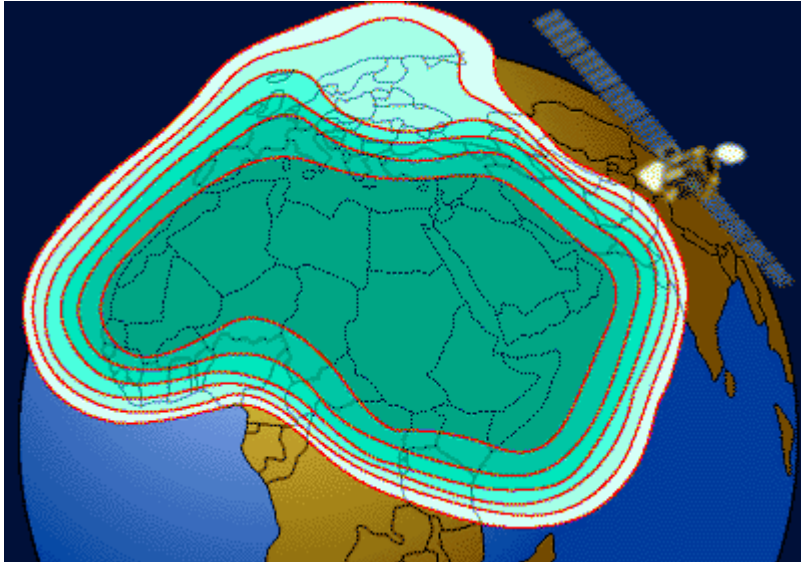

**Fig 1**

**Arabsat 2 series C band high power footprint (41.0 dBw at beam centre, contours 38.0 dBw & 37.0 dBw)**

## Thor 2

Based on the Hughes HS376HP platform Thor 2 will have 15 x 40 watt KU Band transponders. The Nordic spot beam is 52 dBW at beam centre. The mid European beam is 48 dBW at beam centre. Additional spot beams are targeted at the Faroe Islands, Iceland and Greenland. The earliest launch date is February however this could slip to the Autumn. No published footprint map is yet available for Thor although draft engineering plans show fairly tight spot beams on the target areas - with apparently little “spill over” into the UK. The transponder plan for **Thor 2** is given below;

TP 1	11.215625	H	TP 9	11.340625	H
TP 2	11.228625	V	TP 10	11.357125	V
TP 3	11.246875	H	TP 11	11.381875	H
TP 4	11.260750	V	TP 12	11.389250	V
TP 5	11.278125	H	TP 13	11.403125	H
TP 6	11.292875	V	TP 14	11.421375	V
TP 7	11.309375	H	TP 15	11.434375	H
TP 8	11.325000	V			

### Sirius 2

Sirius 2 is being manufactured by Aerospatiale for GE Capital Satellites - Europe and is the replacement for the aged Tele X satellite. The pan-European satellite service via Sirius 2 will feature two available transmission beams with a Europe wide beam and a European North/Central beam, both delivering 50 dBW of power at the edge of the primary service area. Located at the 5 degree E orbital slot, the Sirius 2 Ku-Band satellite will carry pan-European service on 16 of its 32 transponders supporting analogue, digital, compressed and SCPC transmission. Both spot beams cover the UK with Scotland falling into the 48 dBW contour. Launch is scheduled for midsummer.

### DIGITAL NEWS

#### Receivers

Although digital TV intended for the UK is still a few months away there is already a huge amount of programming already being carried using digital MPEG 2 technology for the rest of Europe. Although extreme caution should be urged before splashing out on equipment not intended for use in the UK the following receivers are amongst those currently available; PACE DVR500, ECHOSTAR DBS- 9600, PANASAT IRD524D and the NOKIA DVB 9500S

The Nokia 9500S is sold under the name D BOX ( see photo below) in Germany for reception of the German DF1 digital package. Many receivers have “leaked” out of Germany and are being used to receive both multiplexed and Single Channel Per Carrier (SCPC) digital signals from other than the intended broadcaster.

The main details of the D Box Specification are given in the table below.

<b>Demodulator</b>	
Modulation	QPSK
Symbol Rate	1-45 MS/s
Bandwidth	2-52 Mhz
<b>System</b>	
Processor	Motorola 68430, 16 Mhz
RAM	1.5 Mbyte
Flash Memory	1.5 Mbyte
Picture resolution	720 x 576 pixcels
Conditional Access	IRTDETO
Video decoder	MPEG2
Audio	MPEG 2 I,II (musicam)
<b>Video &amp; Audio</b>	
Display aspect ratio	4:3 & 16:9
TV SCART	RGB, Video & Audio
<b>Misc</b>	
RF connector	1 F type
IF input	950 - 2150 Mhz
Switch output	0/12 V
Modem	V32bis 14.4kbit/s

## Services

The three current digital mutliplexes on ASTRA use different types of conditional access system or variants within the same system. ie., the DF1 and Multi-choice packages both use IRDETO but a channel using IRDETO in the DF1 package will not necessarily be receivable by a receiver intended for the Multichoice package. The schemes in use are as follows;

Service	Parameters	CA
Canal Satellite	MPEG2/ Symbol rate 27.5/ FEC 3/4	Mediaguard
DF1	“	Irdeto
Multichoice	“	Irdeto

In addition to the packages above there are a number of channels broadcast in clear MPEG 2 on Astra and Eutelsat satellites either as a multiplex (several channels together) or single channels using SCPC. The ability of the receivers above to receive clear MPEG 2 signals is mixed and can change daily. DF1 recently downloaded new software which enabled the D Box to receive SCPC transmissions. They could just as easily reverse this !

To add to what is already a fairly confusing situation the Deutsche Telecom are proposing to launch a simple MPEG 2 receiver capable of receiving only free to air signals. On this basis the receiver would not have a conditional access module slot, however the specification emerging for a receiver to be available in Autumn 1997 is far from clear on this point.

### Hacking & the future

At the time of writing this there are already signs that the pirates are hacking the new services. In addition to this there are signs that software control for these receivers from a PC is being developed, aimed at re-creating the feel of the analogue multi-satellite receiver (Sat-Soft Schneider in Germany (+49-8158-99460) offers universal software for a number of receivers). The view at the moment however is that digital receivers will be sold on a geographical basis limiting reception to only those services targeted at that area. The concept of “open skies” promised at the dawn of satellite broadcasting looks like being sacrificed to the strategy of broadcasters seeking to maximise revenues in the areas they control. Time will tell.....

For those interested a Dutch company Bakker-Company/NL is selling all the receivers mentioned above. They currently claim to sell a converted d-box able to receive the DF1-package *and* also the MultiChoice-package. contact :

Bakker Electronics BV,  
P.O.Box 114  
NL-8320 Urk/The Netherlands  
Fax: +31-527-683-679

## What's up there now ??

In the interests of space I have not included comprehensive lists of digital channels against frequencies and individual satellites. To illustrate the extent to which digital channels have populated existing satellites the plan for Eutelsat II F3 is shown below. For those interested in further information please drop me an SAE and I will provide the latest listing for any satellite you are interested in.

Service	Programming	Freq/Pol	Tp	FE C	Mo de	Symbol Rate
TV10	Gen Ent.	11.015 H	20B	3/4	TV	5630
TMF	Pop Music	11.023 H	20B	3/4	TV	5630
TMC	Test	11.023 H	20B	3/4	TV	5630
	Tests	11.060 H	21A	3/4	TV	5926
	Tests	12.567 V	41	3/4	TV	5632

Service	Programming	Freq/Pol	Tp	FE C	Mo de	Symbol Rate
	Feeds	12.528 V	45	3/4	TV	5632
	Feeds	12.538 V	45	3/4	TV	5632
	Feeds	12.546 V	45	3/4	TV	5632
	Feeds	12.556 V	45	3/4	TV	5632

## New Programmers

The French AB Sat programmer has announced the subscription prices for its service on Eutelsat IIF3.

The "X-Sat" decoder will be available for sale only at 1990 FF. The programme packages (including adult services) are as follows;

- Basic (AB Numerique, 7 channels): 45 FF/month
- Basic and Movies (Cinema Numerique, 12 chan. 129 FF/month
- Basic and Passion (Passions Numerique, 13 chan. 129 FF/month
- Full package (all 18 channels) 199 FF/month

The AB SAT decoder will receive all *clear* channels without a smartcard and it is possible to enter manually the frequency, symbol rate, and forward error correction parameters. It is not clear that the "X-SAT" will recover SCPC channels or receive signals from the other French Bouquet called Television Par Satellite (TPS) which also uses the Viaccess conditional access (even with a TPS card in it !)

### FROM THE POST BAG

A bumper post bag this time with some nice comments about "Satellite TV News" - thank you. A reader from the UAE wrote " I receive scrambled TV signal from a satellite, Stationar-12 at 12.4 Deg E at Freq 3.875 Ghz from 00.00 to 04.00 GMT. Can you provide details..." I was intrigued at the interest in this more obscure spot in the sky until I checked to find this is the Asia & Middle East feed of Rendezvous TV!!. David Mann, G8ADM, wrote to ask for more information on the digital satellite services increasingly available at the moment (see Digital News above). David works for Standard Communications Corporation who manufacture professional satellite receivers. David provides details of satellite control software capable of controlling receiver and antenna positioning functions developed currently for Standard Communications and NTL digital receivers. Doug Wheele, G3AKJ, writes to ask for information "in plain language" regarding the use of D2Mac, Eurocrypt and the plethora of so called Smart Cards being advertised in the UK Satellite Press. Doug asks - "is the output of a D2MAC decoder in the form of a standard video (e.g. PAL), or is a special monitor needed. I understand that the D2MAC signal is further scrambled in Eurocrypt (I think!) Is this a scrambling of the normal PAL video or is it a scrambling of the digital D2MAC signal BEFORE converting to PAL (if indeed it is?)". Most D2Mac decoders have a standard PAL composite video output, the better ones also have RGB and "S" Video connections. They usually have a modulated RF output in the range +/- Chan 37. D2Mac is a technique of multiplexing the luminance & chrominance components in a compressed format to avoid the typical cross modulation problems occurring with PAL. The signal is carried within the normal 64 microsecond baseband timeslot for a 625 line transmission. Eurocrypt is a cut and rotate encryption system similar to Videocrypt but designed specifically for D & D2Mac services. The confusing variety of smart cards is mostly dealer "hype". The single chip PIC cards have less memory to enable them to hold all the codes necessary to defeat electronic counter measures. The twin PIC and COP cards have more memory/processing capability and may survive perhaps one or two of the numerous attempts by broadcasters to knock the Pirate cards out. The level of sophistication increases with cards being capable of upgrading



either via your own PC or in some cases via your D2Mac Receiver/Decoder remote control. This latter method is quite useful so long as you can get access (via a dealer or the Internet) to the new codes - you simply reset the card using the password facility available which is to be found on the better D2Mac decoders. The converted BSB DMac receivers do not fall in this category unfortunately! There are very few unencrypted D2Mac signals around but check Intelsat 707 at 1.0 Deg W or Telecom 2A at 8.0 Deg W.

## **HOT BIRD 2**

Hot Bird 2, EUTELSAT's third television satellite for 13 degrees East, was successfully launched on November 21 at 20.47 GMT by a Lockheed Martin Atlas IIA rocket from Cape Canaveral. The satellite was scheduled to enter into service in December with initial tests carried out at 29.0 deg E.

Hot Bird 2 is equipped with 20 transponders of which more than half are expected to be used for digital television broadcasts to small receive antennas. Two coverage zones are available on the satellite: the Widebeam (49.0 dBW) which reaches the entire European continent, North Africa and the Middle East as far as the Gulf States, and the Superbeam (53.0 dBW), which reaches throughout western and central Europe. Transponders can be switched one by one from the Superbeam to Widebeam according to client requirements.

Hot Bird 2 is the first of four television satellites supplied to EUTELSAT by Matra Marconi Space. Following on close behind are Hot Birds 3 and 4 which will both be launched in 1997 and Hot Bird 5, which will be launched in 1998.

EUTELSAT has also ordered four new telecommunications satellites for other orbital positions, the first of which will be launched next year. Three of the satellites, currently called the "W24" satellites are being built by Aerospatiale together with Dasa, Alenia and Loral, while the fourth, SESAT, is being built by the Russian manufacturer NPO-PM together with Alcatel Espace.

The only new channel in analogue to appear here will be Phoenix from ARD/ZDF, due to launch on April 1st this year. All digital services will be encrypted with the exception of those from the Italian broadcaster RAI.

**Hot Bird 2 Frequency Plan**

Tp	Freq	Pol	Beam	Service	Mode
50	11.727	V	Widebeam	RTP International	Analog
51	11.747	H	Widebeam	EDTV Dubai	Analog
52	11.766	V	Superbeam	RAI (Italy)	Digital
53	11.785	H	Superbeam	WDR	Analog
54	11.804	V	Superbeam	RAI (Italy)	Digital
55	11.823	H	Superbeam	Nethold	Digital
56	11.843	V	Superbeam	STET (Italy)	Digital
57	11.862	H	Superbeam	Nethold	Digital
58	11.881	V	Superbeam	STET (Italy)	Digital
59	11.900	H	Superbeam	Nethold	Digital
60	11.919	V	Superbeam	RTI (Mediaset)	Digital
61	11.938	H	Superbeam	TPS (French)	Digital
62	11.958	V	Superbeam	Telepiu (Italy)	Digital
63	11.977	H	Superbeam	Swedish Cable	Digital
64	11.966	V	Superbeam	Telepiu (Italy)	Digital
65	12.015	H	Superbeam	ART Europe	Analog
66	12.034	V	Superbeam	Telepiu (Italy)	Digital
67	12.053	H	Superbeam	Swedish Cable	Digital
68	12.072	V	Superbeam	Telepiu (Italy)	Digital
69	12.092	H	Superbeam	NBC	Analog

**TRANSPONDER WATCH**

**Turksat 1C 42.0 Deg E**

TRT 1 and TRT 2 have both left the Turksat 1C Western beam. TRT International has started on Turksat 1C, Western beam on 11.469 Ghz. Kanal D (Turkey) has moved from 11.182 Ghz (V) to 11.498 Ghz (V), the former TRT 2 transponder. Euro D has moved from 11.509 Ghz (V) to 11.569 Ghz (V).

**Arabsat 1C 31.0 Deg E**

Following successful post launch testing Arabsat 2B will replace Arabsat 1C at 31.0 degrees East. Arabsat 2B is an identical satellite to Arabsat 2A, with 22 C-band and 12 Ku-band transponders. Arabsat 1C will be relocated to 20 degrees East, the former location of Arabsat 1DR.

## **Astra's 1A,1B, 1C, 1D, 1E 19.2 Deg E**

The home-shopping-programme TV SHOP Europe now shares TP 31, 11.671 Ghz H, with Sky Sports 3. Transmission in Pal with Videocrypt starts at about 1.15 CET. Following rumours that Galavision may leave ASTRA there is now speculation that the news-channel TeleNoticias (from Spain) may replace Galavision on 11.126 Ghz (V). It is likely that Galavision will soon be carried only from PANAMASAT at 45.0 Deg West. By the time you read this it should be clear who will take up the vacant capacity on Tp 24 left by JST/CMT.

## **Eutelsat II F3 16.0 Deg E**

TV Plus from the Netherlands was scheduled to close on 31st December.

## **Eutelsat's II F1 & II F6 (Hot Bird 1) 13.0 Deg E**

RTL 7, a brand-new entertainment-channel for Poland, has started on 11.492 Ghz V replacing Polonia 1. Polonia 1 is due to re-appear following successful in orbit testing of Hot Bird 2 although no Tp details were known as we closed for press. German channel TM 3 on transponder 11.638 Ghz h was scheduled to close during late December and will only now be available from ASTRA.

## **Eutelsat II F2 10.0 Deg E**

ATV has left this position and is now on Turksat 1C. NTV has moved from 11.018 to 10.987 Ghz. The French version of Bloomberg TV comes now occupies transponder 11.576 Ghz v (ex BHT). The signal is clear PAL with audio at 6.60 Mhz. Bloomberg TV is also carried as an encrypted digital service on ASTRA. BHT Bosnia-Herzegovina TV has moved from 11.576 Ghz (V) to 11.080 Ghz (H).

## **Sirius 5.2 Deg E**

Z-TV Denmark ceased service at 11.977 Ghz (LHC) on 30 November with Nickelodeon Denmark/Norge as the expected replacement.

## **TVSat 2 0.6 Deg W**

Z-TV Denmark is no longer available on 11.977 Ghz (LHC).The programme time (weekdays 16.00 to 19.00 CET) is now use by 3 + Denmark.

### Intelsat 707 1.0 Deg W

The Cartoon Channel/TNT service is now to be found in unencrypted D2Mac on 11.003 Ghz (V). MTV is now on 11.679 Ghz with BBC Prime now occupying 11.133 Ghz (V).

### Amos 1 4.0 Deg W

The latest transponder plan for the Israeli AMOS satellite is shown below;

Tp	Freq	Pol	Service	Video	Audio	Beam
1L	10.968	V	IBA Chan 1	PAL	6.6	Israel
1U	11.005	V	Israel Chan 2	Pal	6.6	Israel
9L	11.308	H	TV 3 Budapest	MPEG-2 Clear	Digital	Central Europe
9U	11.344	H	Test Card	PAL		Central Europe
10L	11.388	H	A TV Poland	MPEG - 2 *	Digital	Central Europe
5U	11.596	V	IBA Chan 3	PAL	6.6	Israel

\* From December A-TV Poland was scheduled to be changing from PAL to MPEG2 and splitting into two separate channels. The first one will be named A-TV 1 with the second called Super ATV broadcasting for younger viewers.

### Telecom 2B & 2D 5.0 Deg W

Telecom 2D has now moved from 3 degrees East to co-locate at this position. The frequency plan for Telecom 2D means that it is effectively an "in orbit" reserve for Telecom 2B and provides no effective increase in transponder capacity. France 3 started its analogue service in clear Secam in mid December. on 12.732 Ghz (V).

### Orion F1 37.5 Deg W

APNA TV has launched a general entertainment service at 12.666 Ghz V every night in PAL in the clear (also at 11.625 Ghz V in MPEG2 in the

clear). The analogue service will close in favour of a digital feed in due course.

## **SATELLITE TV ON THE WEB**

The following sites may be of interest...

Aerospatiale :<http://www.aerospatiale.fr>

MCM Euromusique :<http://www.netbeat.com/mcm>

RTS SAT :<http://www.fon.bg.ac.yu/webbeograd/rts/>

## **CONCLUSION**

That's it again for another edition of "Satellite TV News". With the same old exhortations to write in with news and views I leave you till next time when once again there will be a round up of all that's new in the world of Satellite TV. My E Mail address is [paul.holland@btinternet.com](mailto:paul.holland@btinternet.com).

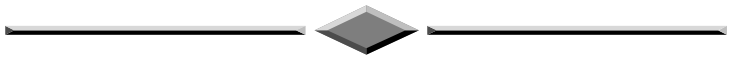

**The Old and the New**

# IMPROVE YOUR TV RECEPTION

## SPECIAL DX GRID

### Wideband UHF Grid with Directors

For receiving extra ITV programmes, or even Continental TV, the wideband UHF JJB/4 BILBOARD GRID provides the answer. Its wideband response means that a single grid can be used to cover the entire UHF spectrum,

The JJB/4 GRID is a special type of aerial consisting of FOUR STACKED DIPOLE assemblies which can provide improved results over a conventional 'Yagi' TV aerial. In some difficult reception areas where local signals are scattered and arrive at slightly different heights (with ghosting, signal imbalance, etc) the use of a grid can improve results,

For even better results we can now supply this array with our own unique add-on director assembly which provides further signal enhancement. A single grid is ideal even for Continental reception in the UK during a tropospheric lift but two grids can be positioned side-by-side for even higher gain; this also makes the system more directional,

The JJB/4 is ruggedly constructed and features a 16-element reflector (not a mesh as found on other makes) providing excellent front-to-back ratio characteristics,

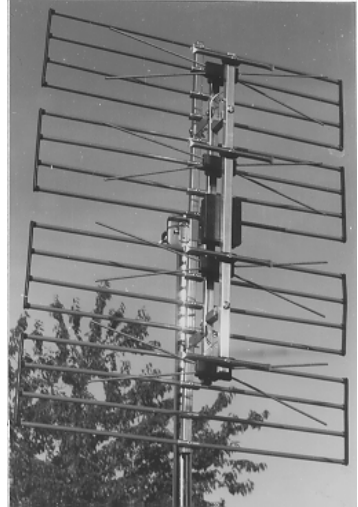

JJB/4 WIDEBAND GRID + NS ADD-ON DIRECTORS (13.5db approx.).....	£34-95
TWIN GRID (with add-on directors, stacking kit and combiner).....	£69-95
SUPREME HI-GAIN LO-NGISE WIDEBAND UHF AMP (2SdB gain, 1,9dB noise) .....	£23-95
P1290 HI-CURRENT PSU FOR ABOVE.....	£15-95

UK POSTAGE & PACKING £5-00 PER AERIAL ORDER., OTHER ITEMS UK P&P INCLUDED. EXPORT PRICES UPOW REQUEST.

**Illustrated Catalogue of equipment & Publications only £0.75  
(refundable with the first order)**

*We can also manufacture aerials to your own design (one-off or multiples),*

## HS PUBLICATIONS

**7 Epping Close, Derby DE22 4HR, England**

**Tel: 01332 38 16 99**

## **Report from G3VZV on Outcome of IARU Region 1 Conference**

**September 1996**

### **Introduction**

As usual the work of the Conference was split between HF and VHF (& Microwave) Committees. The VHF papers were discussed by Committee C5 which was chaired by Arie PA0EZ. This met for a total of twenty two hours and there were, additionally, a large number of small sub groups working after dinner each evening!

### **Particular items relating to ATV**

**A: 2metres** - There has been a MAJOR change to the 2 metre bandplan of the section 144-145 MHz. The new plan is attached but it will be seen that although almost everything else has been changed, the existing ATV talk back frequency has been retained at 144.750. The Conference also added an additional SSB talkback centre of activity of 144.525MHz.

All 2 metre users should note that the beacons will be moving to 144.4-144.49, the "all modes" section is 144.50 - 144.80, digital modes move to 144.80 -144.99, and there is a provision for the SAREX Shuttle uplink at 144.49. These moves are intended to be completed by the 1st July 1997

**B: 70cms** - As usual there was much discussion concerning the pressures from other users. We heard of the forthcoming extra demands for, amongst other things, remote reading of domestic water/gas/electricity meters, short range business voice links and wind profiling radars.

My personal view is that it is most unlikely that the amateur service will be able to retain access to all of it's present allocations for very much longer as sharing with other secondary services is extremely difficult. I believe we should therefore enter into constructive discussions with the authorities on this point. Only in this way might it be possible for some flexibility to be beneficial.

Report from G3VZV on Outcome of IARU Region 1 Conference

Revision of the 145 MHz Bandplan

IARU Region 1 bandplan	Usage
144.000	
E.M.E. SSB & Telegraphy	
144.035	
144.035	
TELEGRAPHY (a)	
144.150	144.050 Telegraphy calling
144.150	144.100 Random MS Telegraphy reference frequency (m)
SSB	144.140 - 144.150 FAI activity telegraphy
	144.150 - 144.160 FAI activity SSB
	144.195 - 144.205 Random MS SSB (m)
	144.300 SSB Calling
144.400	144.390 - 144.400 Random MS SSB (m)
144.400	
BEACONS	
144.440	
BEACONS(j)	144.490 SAREX uplink (q)
144.490	
GUARD BAND	
144.500	
144.500	144.500 SSTV calling
	144.525 ATV SSB talkback centre of activity
ALL MODE (f)	144.600 RTTY calling (n)
	144.700 FAX calling
	144.750 ATV calling/talk-back
144.800	
144.800	
DIGITAL COMMUNICATIONS (g,h)	
144.850	
DIGITAL COMMUNICATIONS (g,h,k)	
144.990	
144.990	
NBFM REPEATER INPUT, 12.5 kHz spacing, (channel freqs 145.000 -- 145.175 MHz) (c)	
145.1875	
145.1875	145.200 see note p
NBFM SIMPLEX CHANNELS 12.5kHz spacing, (channel freqs 145.200-- 145.575 MHz) (c)	145.300 RTTY local
145.5875	145.500 (Mobile) calling
145.5875	
NBFM REPEATER OUTPUT, 12.5kHz spacing, (channel freqs 145.600--145.775 MHz) (c) (d)	
145.800	
145.800	145.800 see note p
SATELLITE SERVICE (e)	
146.000	

There were two papers (from Germany and Austria) concerning the use of a part of 70cms for high speed (wideband) digital data transmissions. This proposal was the subject to much discussion but there was a positive



### *Report from G3VZV on Outcome of IARU Region 1 Conference*

outcome. The exact agreed wording is "Experiments by manned stations using wideband digital modes not occupying more than 2 MHz bandwidth may take place in the 430 MHz band in those countries which have the full 10MHz allocation. These experiments should be centred in the all modes section centred on a frequency of 434MHz, use horizontal polarisation and the minimum power required." This means that future experiments of MPEG 1 & 2 and similar DATV systems has been approved in advance!

**C: 23cms** - There was a paper from Germany suggesting that the existing FMATV specification needs some technical corrections. This was debated for some time but no clear conclusion was reached. It was agreed that a working group should consider this and make a proposal to the next VHF Managers Conference in eighteen months time.

**D: 3cms** - It was announced during the Conference by the RSGB that they had now been officially advised by the RA that the section 10150 - 10300 would be withdrawn from amateurs for use by Wireless local loops on April 1st 1997. This means that our FMATV repeaters in this band will have to arrange to QSY before this date.

**E: Finale** - In terms of the impact that the decisions made at IARU conferences and the average amateur, this one has been a biggy! If any members would like further information on ATV matters ( or indeed on any other IARU matter) please contact me.

## **1997 SUBSCRIPTION RENEWALS**

Have you paid your Subscription yet for 1997?

If not, this will be last magazine you will receive!

The subscription rates for 1997 are:-

1997 only **£12.00**, 1997 + 1998 **£22.00**, 97 + 98 + 99 **£32.00**, 97 + 98 + 99 + 2000 **£40.00**. Cheques should be made payable to **BATC**

Overseas Members outside the EEC and Europe who wish their magazines sent by Airmail please add an additional **£6.00** for each year of renewing. Extra for Airmail is not required within the EEC and Europe.

# Sevenside Television Group

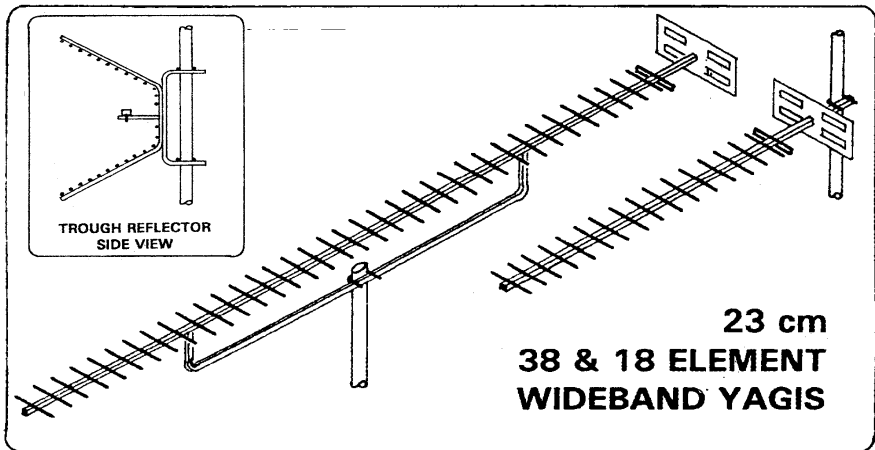

All of our 23 cm Aerials are specifically designed for ATV use - although they can be used for other modes as well. Wideband characteristics mean that you need only one aerial to cover the repeater input and output channels. Our famous wideband yagis come fully assembled in two versions :

**38 ELEMENT HIGH GAIN :** 14 dB gain, 1.8 m long, **£26.00** plus postage.

**18 ELEMENT STANDARD :** 10 dB gain, 0.9 m long, **£15.00** plus postage

Don't forget our **20 ELEMENT CONVERSION KIT**, which converts your existing 18 element aerial to the full **38** element high gain specification : **£13.00** plus postage. Our 23 cm **TROUGH REFLECTOR** is quite unique, combining 11dB gain with wide bandwidth *and* wide beamwidth. It's also compact, just 0.55 m high, 0.35 m wide and 0.3 m deep. Supplied as a kit of predrilled and preformed parts. for easy "Screwdriver" assembly : **£19.00** plus postage. All aerials feature an SWR of less than 1.5:1 and are supplied with mast clamps suitable for masts up to 55 mm diameter. Mast poles shown are not supplied.

**POSTAGE:** **£3.75** for one aerial, **£5.00** for two or more. Telephone orders with cash on delivery: **£2.75** supplement per order, Orders from outside of the UK - please write for carriage quotation.

**CHEQUES** payable to "SEVERNSIDE TELEVISION GROUP" and send to 18, Linnet Close, Patchway, Bristol BS12 5RN. Telephone ( evenings & weekends only please ) 0117 969 8136. Please allow 28 days for delivery.

## **A Tale of Alexandra Palace**

**By Dicky Howett**

*As a follow-up to his CAT 96 lecture, Dicky Howett visits the BBC's original television studios and finds that the past is under threat.*

High above North London, Alexandra Palace has been an imposing landmark since it was built in 1873. In its heyday, the Palace was a typical Victorian venue for entertainment and leisure, with many attractions, novelties and innovations.

By the 1930's the old Palace was run down and neglected. However, rescue was at hand because the BBC was then looking for somewhere to house their new television service. Although Ally Pally (as Gracie Fields named it) was not the BBC's first choice, it had three things going for it. Firstly, it was high up, secondly it was available and thirdly it was cheap.

In 1935, construction began on the South East Wing of Alexandra Palace. Soon a large transmitting mast was positioned on top of the South East Tower. This structure heralded the world's first regularly scheduled high definition television service.

On November 2nd 1936, the BBC inaugurated live daily television programmes using studios converted from two adjoining banqueting rooms. By modern standards these studios were tiny, each measuring barely 70ft x 30 ft x 23ft high. From these cramped and primitive premises, memorable and pioneering programmes emerged. These included Picture Page, Cafe Continental, Muffin the Mule and in 1953, The Quatermass Experiment.

In 1954, the BBC closed the studios when they moved their main productions to Lime Grove. Shortly after however, BBC Television News took over the studios and started live news bulletins. At first, these bulletins were broadcast only with the voice of the news reader, illustrated with captions and photographs. It was thought that actually seeing a news reader would be a distraction. Richard Baker was one of the first voices on television news. The News finally left Ally Pally in 1969. The Open University moved in for a few years and then they too left in 1981 for the wide green fields of Milton Keynes.

For the last 15 years the two pioneer studios, the birth place of Britain television have lain idle and unused, except for storage. Unfortunately, the fabric of the old studios is now under increasing attack. This is due to

## *A Tale of Alexandra Palace*

a combination of management interference, neglect and that old bugbear, lack of money.

The owner of Alexandra Palace is the London Borough of Haringey who operate the Palace through a nominated board of Trustees. Over the years the Trustees have had to cope with many problems, the worst of which was a fire in 1980 causing extensive damage to the Palace's Great Hall. Fortunately, the television studios were unaffected, apart from a little singeing.

However, the insured cost of restoring the Great Hall ran



### **External view**

way over budget. When it came to looking at the television studios, there was no cash available for any sort of major restoration or preservation. There were a lot of fine words but no action.

Lately, in order to rustle up some public interest, conducted tours of the Palace are being held, organised by the Palace management. For a modest sum (£3.50.) small groups can accompany a guide, with visits to the Palace theatre and Great Hall. Currently, the two studios in the South East wing are 'out of bounds', which rather reduces the benefits of the tour. It is hoped that the two studios will soon be opened again for visits and the mysterious 'dry rot' problem in the concrete cured.

Ten years ago a special group, the Alexandra Palace Television Trust was formed. This Television Trust, a registered charity, is separate from the main Trust, which is run by Councillors. The APTV Trust has twelve volunteer members (including the present writer) comprising people from the local area, journalism and broadcasting. The APTV Trust is currently steering a course through a minefield of conflicting interests, one of which would gladly see the whole building razed to the ground and the land hived off for luxury housing. Apathy and antipathy to Alexandra Palace is not soothed to any degree by the accumulated debt of the building, currently around £50 million. A drain on rate payers and no vote winner for the politicians.

Lately, a consortium of developers have been in negotiation with Haringey Council and have agreed in principle to preserve the two tv studios in any future



**Door to studio A. Although the wall may be crumbling, the original brass 'port hole' survives.**

developments, but unfortunately this is not in any way guaranteed.

The APTV Trust is at present holding the fort and would like to see the studio area converted into a modern education resource and museum dedicated to the pioneers. For this at least £3 million would be needed. A feasibility study is soon to be commissioned to ascertain requirements. It would be a great pity if this 'heritage site', (for that is what these studios undoubtedly are), is allowed to vanish.

For more about The Alexandra Palace Television Trust and tax efficient donations to the Trust contact Dicky Howett, 23 Micawber Way, Chelmsford, Essex CM1 4UG.

**BATC Accounts for 1995**

**Income and expenditure account Year ended 31 December 1995**

	<b>1995</b>	<b>1994</b>	<b>1993</b>
<b>Income</b>			
Subscriptions	16,405	16,577	17,470
Members services	320	840	925
Publications	393	355	1,055
Advertising	358	558	621
Building society interest	233	241	494
Bank interest	1,525	1,085	655
Exhibitions	3,682	4,934	3,018
Donations	17	310	342
Postages	231	103	359
Donated equipment sales	-	39	7
Miscellaneous	<u>106</u>	<u>-</u>	<u>-</u>
	<b>23,270</b>	<b>25,042</b>	<b>24,946</b>
less-			
<b>Expenditure</b>			
CQ TV printing	8,962	9,055	9,401
CQ TV postage	3,881	3,813	4,377
CQ TV production	395	1,216	1,757
General office expenditure	203	1,408	664
General postages	527	689	858
RSGB affiliation fee	16	15	15
Committee members expenses	303	178	28
Exhibitions	2,639	4,403	2,478
Insurance and legal	146	71	60
Miscellaneous expenses	109	27	-
Members benefits	1,093	236	1,144
Accountancy	311	311	255
Rally attendance	276	180	322
Recruitment	-	533	207
Advertising and publicity	125	520	-
Project development	27	6	56
Bank charges	114	94	128
Conference	-	3,109	-
	<u>19,127</u>	<u>25,864</u>	<u>21,750</u>
<b>Surplus of income over expenditure</b>			
<b>/(Deficit of expenditure over income)</b>	<b><u>£ 4,143</u></b>	<b><u>£ (822)</u></b>	<b><u>£ 3,196</u></b>

*BATC Accounts for 1995*

<b>Balance sheet at 31 December 1995.</b>	<b>1995</b>	<b>1994</b>	<b>1993</b>
<b>Fixed assets</b>			
Office equipment			
Additions	257	1,320	1,130
less - Depreciation	<u>(257)</u>	<u>(1,320)</u>	<u>(1,130)</u>
<b>Current assets</b>			
Stocks			
members services	4,959	5,562	7,817
publications	4,192	5,972	7,014
back issues - CQTV	1,404	-	-
Debtors	300	-	500
Nationwide Building Society	11,024	10,791	11,550
Girobank account	119	119	119
Royal Bank of Scotland-			
current account	9,004	4,121	5,527
investment account	<u>25,040</u>	<u>25,040</u>	<u>25,010</u>
	<b>56,042</b>	<b>51,605</b>	<b>57,537</b>
less-			
<b>Current liabilities</b>			
Creditors and accruals	1,015	1,015	959
Subscriptions received in advance	<u>13,876</u>	<u>13,582</u>	<u>18,748</u>
	<u>14,891</u>	<u>14,597</u>	<u>19,707</u>
	<b><u>£ 41,151</u></b>	<b><u>£ 37,008</u></b>	<b><u>£ 37,830</u></b>
<b>Represented by- Accumulated fund</b>			
Balance brought forward	37,008	37,830	34,634
Surplus of income over expenditure			
/(Deficit of expenditure over income)	<u>4,143</u>	<u>(822)</u>	<u>3,196</u>
	<b><u>£ 41,151</u></b>	<b><u>£ 37,008</u></b>	<b><u>£ 37,830</u></b>

In accordance with instructions given to us, we have prepared these accounts from the accounting records of The British Amateur Television Club, and from information and explanations supplied to us.

***RN Store & Co.***

Chartered Accountants

Gainsborough

28 August 1996

## Beyond TTL # 12

**By Trevor Brown G8CJS**

This time its a look at the PIC 16C84 and how to programme it using a PC and software that runs under MS DOS

I want to start by looking at a new micro chip, the PIC 16C84. The PIC family of chips are relatively new micro chips from a company called Microchip Technology Inc. The 16C84 is particularly interesting because it stores the programme inside the chip in flash memory. The memory is non volatile and so the programme is retained when the power is removed. No UV erase is thus required the - new programme is loaded in place of the old and the chip can be programmed over and over again. The ports and clock oscillator are also integral to the chip so no external PIO and minimum external components for the CPU clock are required. i.e. an xtal or even just a single resistor and capacitor.

Lets first look at the programmer hardware (fig 1) which was designed by Derren Crome and first appeared in Everyday Practical Electronics (February 1996) and is reproduced with their kind permission. The programmer connects to a PC via a three wire interface to the printer port and requires only +12v, which can come from either an external PSU or from one of the spare disc drive connectors within the PC. D1, D2, D3, D4 are not essential to the programming process, They are connected to Port B and are controlled by the example programme (fig 2) to demonstrate counting in binary. This hardware is very simple but has the limitation that the code can not be verified to show that it has downloaded to the chip without corruption. We will be looking at more complex hardware in the next CQ-TV, but this simple programmer is well worth putting together and trying.

As always the software side of things is a little more complex than the hardware. In fig 2 I have written a programme that demonstrates binary counting by illuminating three of the binary LED's connected as per fig 1. The software is written using a simple text editor (I used Xtree Gold). This file is normally given the extension .ASM. and is then processed by an assembler. Different assemblers require different syntax in the .ASM file, so it is important to write the correct syntax for the assembler being used. Fig 2 shows a source code text file presented in the correct syntax for the TASM assembler. TASM is a popular assembler and is available for evaluation on the club BBS. The original version does not support the PIC 16C84, but it is possible to add this chip to the TASM assembler by a



1684 TAB file. This is part of TASM30.ZIP if you get your copy from the club BBS. It run's under DOS and will run on the humblest of PC's.

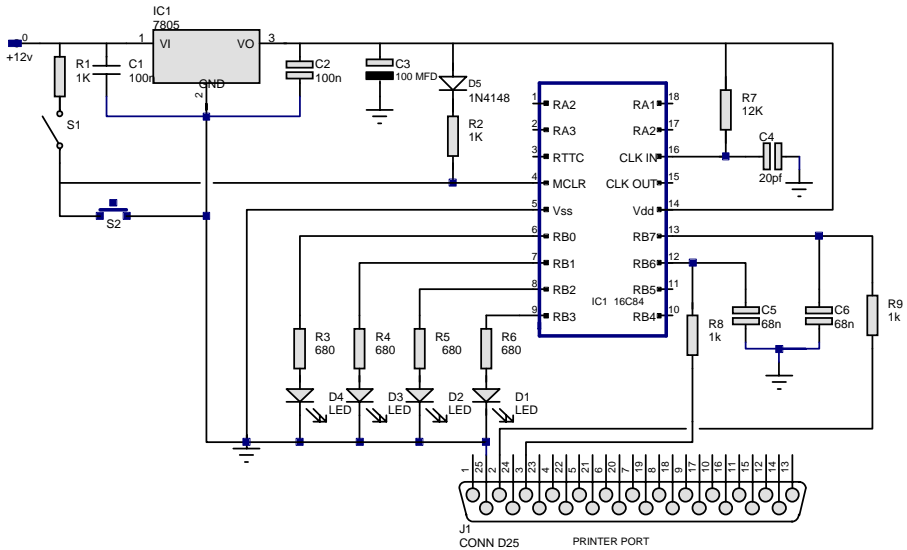

**Fig 1. 16C84 PIC Programmer**

The way to invoke the TASM assembler is to unzip the TASM30.ZIP package into a directory called PIC and put the source code file in the same directory giving it an .ASM extension. Then using DOS, log to that directory and enter `TASM -1684 -B TEST.ASM` where TEST is the source file written with a text editor. Enter and you will be presented with error messages about your syntax and line numbers so you can investigate, or if you are successful three other files will be created, TEST.LST, TEST.OBJ, TEST.SYM. The .LST file shows the .ASM file with hex numbers added next to the instructions. The .OBJ file shows just the HEX numbers. These can then be downloaded to the PIC as follows.

## Beyond TTL # 12

;Example program for PIC16C84, by Trevor Brown  
;Will increment LED's connected to bits 0-3 of port B (pins 6 to 9)

```
#DEFINE PAGE0 BCF $03,5
#DEFINE PAGE1 BSF $03,5

.AVSYM
STATUS: .EQU $03 ;Located in page 0 & 1
PCL: .EQU $02 ;0 & 1
TMR0: .EQU $01 ;0
PORTA: .EQU $05 ;0
PORTB: .EQU $06 ;0
TRISA: .EQU $05 ;1
TRISB: .EQU $06 ;1
OPTION: .EQU $01 ;1
INTCON: .EQU $0B ;0 & 1
EEDATA: .EQU $08 ;0
EEADR: .EQU $09 ;0
EECON: .EQU $08 ;1
PCLATH: .EQU $0A ;0 & 1

COUNT1: .EQU $0C ;Register C
COUNT2: .EQU $0D ;Register D

W: .EQU 0 ;Result to go into working register (accumulator)
F: .EQU 1 ;Result to go into a file register.

C: .EQU 0 ;Carry flag (located in STATUS register)
DC: .EQU 1 ;Digit carry "
Z: .EQU 2 ;Zero flag "
PD: .EQU 3 ;Power Down bit "
TO: .EQU 4 ;Time-out bit "

.ORG $0004 ;Interrupt vector address
GOTO START ;Jump to interrupt service routine on interrupt
.ORG $0005 ;Start of program memory
;Above lines must always be present.

PAGE1
MOVLW $00 ;Load working register (accumulator) with
literal 0.
MOVWF TRISB ;Configure all port B lines as output

PAGE0

START MOVLW $00
CALL WAIT
MOVLW $01 ;load working register (accumulator) with 1
CALL WAIT ;Delay routine
MOVLW $02 ;Next led array
CALL WAIT
MOVLW $03 ;Next led array
CALL WAIT
MOVLW $04 ;Next led array
CALL WAIT
MOVLW $05 ;Next led array
CALL WAIT
MOVLW $06 ;Next led array
CALL WAIT
MOVLW $06 ;Next led array
```

```

CALL WAIT
MOVLW $07          ;Last led array
CALL WAIT
CALL DLY
CALL DLY
CALL DLY
GOTO  START       ;Start again

WAIT
MOVWF PORTB       ;Send w reg to leds
DLY
MOVLW 255
MOVWF COUNT1      ;Put 255 in Count1
MOVWF COUNT2      ;Put 255 in Count2

LOOP
DECFSZ COUNT1,F   ;DECREMENT AND SKIP NEXT LINE IF ZERO
GOTO LOOP         ;GOTO LOOP IF NOT ZERO

DECFSZ COUNT2,F   ;DECREMENT COUNT1 IF COUNT2 IS ZERO
GOTO LOOP         ;DO INSIDE LOOP AGAIN IF COUNT2 NZ
RETURN

.END              ;This command MUST be placed at end of program.

```

## FIG 2

The programme called SEND. EXE is now required, this programme controls the fig 1 hardware and again runs under MS DOS. When executed it will prompt as follows:-

- 1 PIC16C84 configuration set-up
- 2 Load object code and send to PIC
- 3 Quit programme

Option 1 allows the PIC to be configured. This needs to be done first when using a new PIC 16C84 or if a PIC previous configuration is inappropriate. When option 1 is chosen another menu is displayed:-

Programme to set configuration fuses WARNING: Any programme presently in the PIC 16C84 will be erased.

Please enter which type of oscillator you wish the PIC16C84 to use

- 1 Low power crystal oscillator (32kHz to 200kHz)
- 2 XT crystal oscillator 100kHz to 4MHz
- 3 High speed crystal oscillator 4MHz to 10mHz
- 4 RC resistor capacitor oscillator

Enter 4 for fig 1 hardware.

Next you will be asked Enable watchdog timer? Y or N

## Beyond TTL # 12

enter N for our binary count programme

Enter power up timer Y or N

for our programme example enter Y

Then you are asked ,

Do you wish the configuration data to be sent to the PIC

enter Y

You are then prompted to close S1 to put +12 on pin 4. Close S1 on fig 1 and press reset S2 and release and then press Enter on the PC keyboard

The following message will be displayed

Configuration data sent

To reset the PIC press SW2 momentarily leave S1 closed. Then as instructed press any key, this will take you back to the original three option memory. Select Option 2, and enter the name of the programme file. The .OBJ does not need to be entered. Press enter. The file will be loaded to the screen displaying the hex values of the bytes involved, the total number received and the amount of PIC memory which will be used to store the programme bytes, both as a word count and as a percentage of available space.

The procedure is now the same as for the configuration programming. Confirm that you want to send the programme ensure S1 is closed, press S2 briefly, then press any key. The programme will be down loaded and confirmation displayed, followed by the instruction Return pin 4 to +5 (i.e. open S1), then press reset (S2) to run the programme. Press any key to return to menu then select option 3 (Quit programme). The PIC should now be running the test programme and binary incrementing the 4 LED's.

The PIC instruction set uses only 32 instructions and will be part of the next Beyond TTL. Meanwhile you can extend the programme in fig2 to cover all four LEDs and count to F in hex using only the instructions present in the programme. If you are interested, it is worth investing in one of the many PIC books that are around where space is available to cover things in more detail than I have here. If you have a Modem on your PC then help is available from the Microchip BBS.

### **The Microchip BBS.**

To access this set your modem to 8N1 and dial CompuServe (no you don't need to be a member). Press enter and a garbage string will appear.

Type + and enter and HOST NAME will appear. Type MCHIPBBS enter and you will be through. Just follow the prompts and you will be able to download data and software for all the PIC chips. The files on the MCHIPBBS that end in .pdf require the Acrobat viewer software to read them. This is available on the BBS, so be sure to download it if you wish to read these files. Please leave me a note on the MCHIPBBS if you are successful.

Alternatively there is a news group that will email you information and help with problems at piclist@mitvma.mit.edu.

If you do not have a modem you could try RS for a data sheet 846-654 Prelim 1993 PIC16C84.

The original Everyday Electronics article by Derren Crome which appeared in Feb 96 is available via their premium rate fax line on 0897 124 125

Last but not least, I am hoping to put together a help disc, so drop me a disc and a return SAE.

### **Webmasters note**

A file, BEYOND.ZIP, to accompany this article, is available for download from our web site (<http://ourworld.compuserve.com/homepages/batc/>). As well as the source code, it contains other examples as well as all the other files required. The TASM assembler which is part of the BEYOND.ZIP is shareware and although fully functioning is provided for evaluation only.

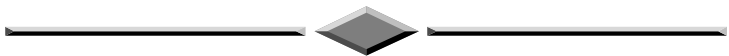

**<http://drn.zippo.com/news-bin/wwwnews?alt.tvdx.early-tv>**

...is the WWW address for the HTML version of the new newsgroup alt.tvdx.early-tv. It is devoted to early TV gear, early programming, reception and mechanically scanned TV- as well as "TV-Dxing".

## **SPLASH - a Review**

**By Mike Wooding G6IQM**

The radio spectrum is a precious resource, with everybody after a slice. Consequently, rigid spectrum management is required by both legislator and designer alike. One method for the designer of accomplishing this task is to produce expensive prototypes and test, redesign and test, and so on. This method is time consuming and can be very costly. One of the many tools now available to the designer to help with this problem is SPLASH.

SPLASH by Phasor Design is the name of their Spectral Occupancy Prediction Software package. The program performs mathematical simulations of radio transmission systems, which makes it an excellent aid for design engineers working in this field.

Using Fast Fourier Transform (FFT) techniques the parameters of a transmitter which determine the spectrum generated are modelled and a spectrum analyser type display produced on the screen. The FFT procedures convert from time domain to frequency domain and back again as required to model the modulation.

The key aspects of SPLASH are:

Simulates modulation of radio transmitters, displaying spectrum in detail

AM or FM, analogue or digital signals

Works with standard B32 format files, with an in-built text editor for producing/modifying such files

16 MHz sweep in 1 kHz resolution in 3 seconds on a 486/66 system

Waveform display both before and after baseband processing

Spectra graphed in a form comparable with that produced by a spectrum analyser

Simulates the ideal Double Sideband spectrum

Simulates the FM spectrum

Simulates the compressed spectrum resulting from 3rd and 5th order intermod.

SPLASH is file compatible with WaveWorks Pro (Pragmatic Instruments). Waveforms created by WaveWorks Pro may be imported

into SPLASH and the spectral density predicted, compared with actual measurements of a transmitter driven by an arbitrary waveform generator.

## **1. How Splash Works**

Note: rather than re-invent the wheel, I have reproduced this section from the SPLASH user manual and documentation supplied by Phasor Design.

### **1.1 Wave Base Band Data**

Wave Base Band (WBB) files describe a section of time of a waveform. The section repeats indefinitely, setting the period and frequency resolution as the reciprocal of the period. WBB files are in binary form and are stored as floating-point values, with four bytes per sample. SPLASH displays the file length as the original data size.

SPLASH loads the WBB file and internally expands it to a textual form for editing. Editing is performed as with any other text editor, but note that on conversion back to binary form any non-numeric characters are lost. Conversion also adds marker numbers to assist editing.

When generating a WBB file, first decide the period/resolution needed. Then decide how many samples are needed, based on the criteria that the sample frequency must exceed twice the highest modulation frequency. Use FIX/ADD/SCALE/SINEWAVE to describe the new waveform. Note that it is not necessary to carefully shape the waveform to model restricted frequency response (shaping) as these effects are applied by SPLASH during DSB calculation.

### **1.2 Double Side Band (DSB) Calculation**

The FFT transforms the WBB data to the frequency domain where shaping is applied. As the final range of frequencies after modulation will be much greater than for the original signal, the data is expanded nominally by a factor of 10. This expansion is by interpolation and can be set to optimise performance between speed and dynamic range.

Interpolation has two effects:

A frequency response loss occurs due to the aperture error; this is automatically corrected.

Aliasing spuri appear in the -90dBc area. These spurious signals can be reduced by increasing the expansion factor.

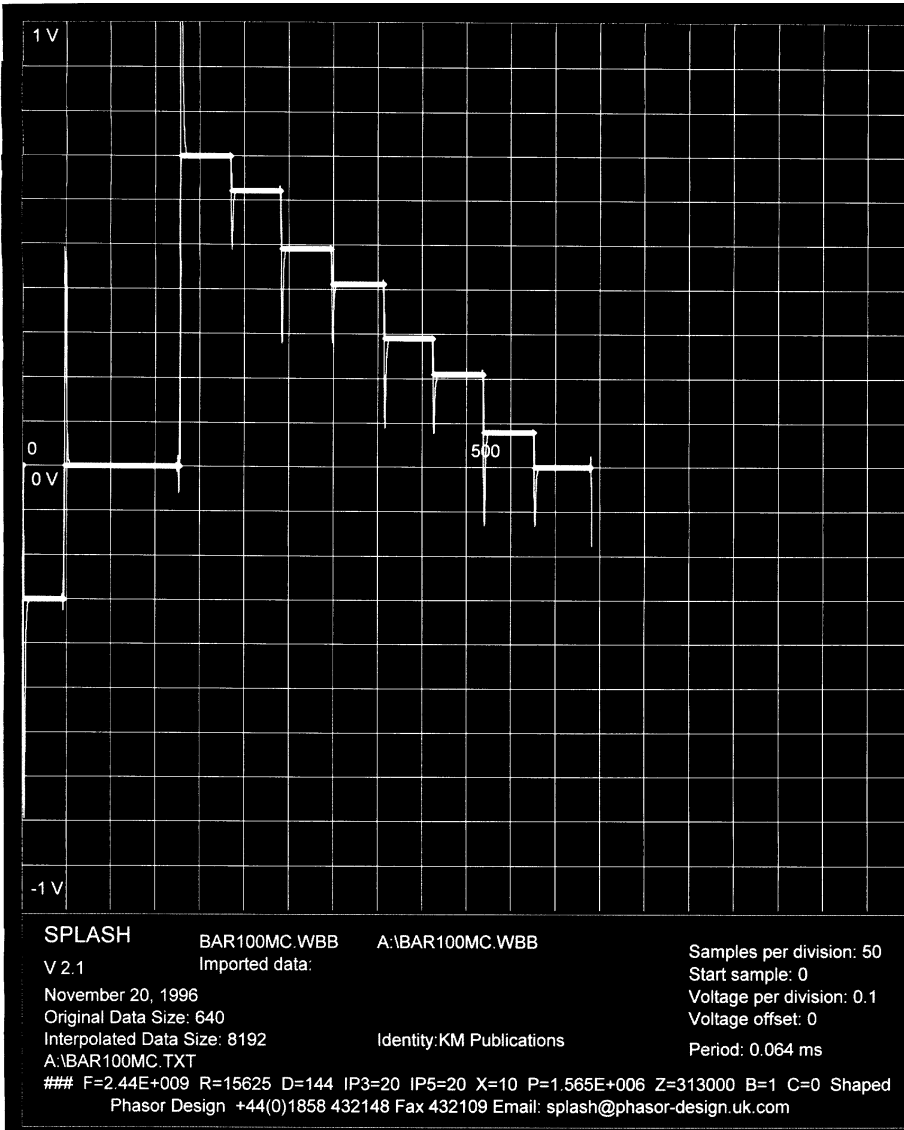

**Figure 1a**

Frequency domain processing is applied to:

- a) correct the aperture error of interpolation.
- b) add emphasis by including the effect of a pole/zero network.
- c) restrict the range accepted, either in a low-pass or band-pass way.
- d) add shaping by applying an ideal roll-off characteristic affecting amplitude only. Note that this is applied to the range selected.



### **1.3 Frequency Modulation**

To model FM the calculated DSB data is:

- a) frequency phase modified; this also removes the DC component
- b) transformed to the time domain by the FFT.
- c) interpreted as wide-angle phase modulation with constant amplitude.
- d) transformed back to the frequency domain by the FFT.

### **1.4 Compression**

To model compression the calculated DSB is:

- a) translated to a frequency offset.
- b) transformed to the time domain by the FFT.
- c) compressed according to the third and fifth order power laws.
- d) transformed back to the frequency domain by the FFT.
- e) artificial spurious frequency components are removed.

## **2. Using Splash**

The hardware requirements for running SPLASH are:

IBM or compatible PC, 486 or better

MS Windows 3.1 or 95

Printer Port (for the program key)

SPLASH comes with an A5 ring-bound manual, the software on a single 3.5 inch disc and a dongle. The dongle is for software security and must be attached to the 1st printer port (LPT1) at all times for complete program functionality.

Installing the software was simple - just copy the files into a new directory. Copy the SPLASH.exe file to the desktop for an iconised click-to-go facility, attach the dongle to LPT1 and that's it. Double click on the icon and SPLASH runs.

The fact that SPLASH is written as a Windows package (rather than a DOS package that will run under Windows) helps a great deal. It has the immediate feel of a user-friendly system, with all the usual GUI features, drop down menus, iconised tool bar, multi-window presentation, context sensitive help files, etc. (OK, I apologise now to all the non-Windows users or Windows haters out there, obviously I am neither of them!).

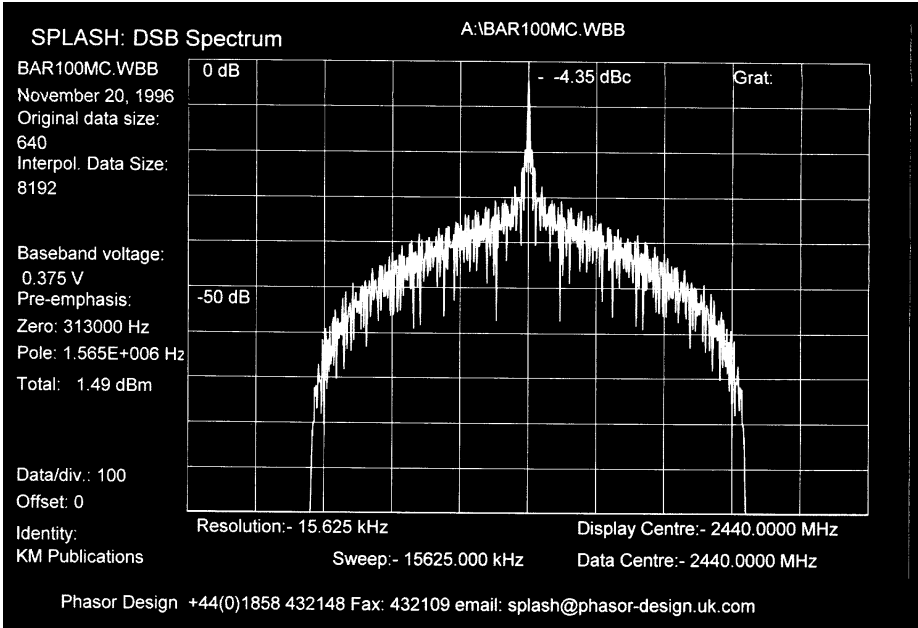

**Figure 1b**

The user-manual is basic and assumes to some extent that you know what you are doing. I suppose that if you buy the package then you probably do - however, to some degree in relation to this sort of work, I don't! That aside, the manual gives basic guidelines on how to install and run the software and has a section detailing some of the examples included with the package, but that is about it. The main user guide is the Help file.

As with all good Windows packages the help file is dual-fold:

Firstly, there is the main Help menu, which allows you to search through an index for specific subjects, or gives an overview of general subjects.

Secondly, there is the all important context sensitive Help. This, to the uninitiated, is a system whereby one selects context-sensitive help by clicking on the toolbar icon and then just by clicking on the point on the screen which needs clarification or help, opens up a dialogue box with the answer.

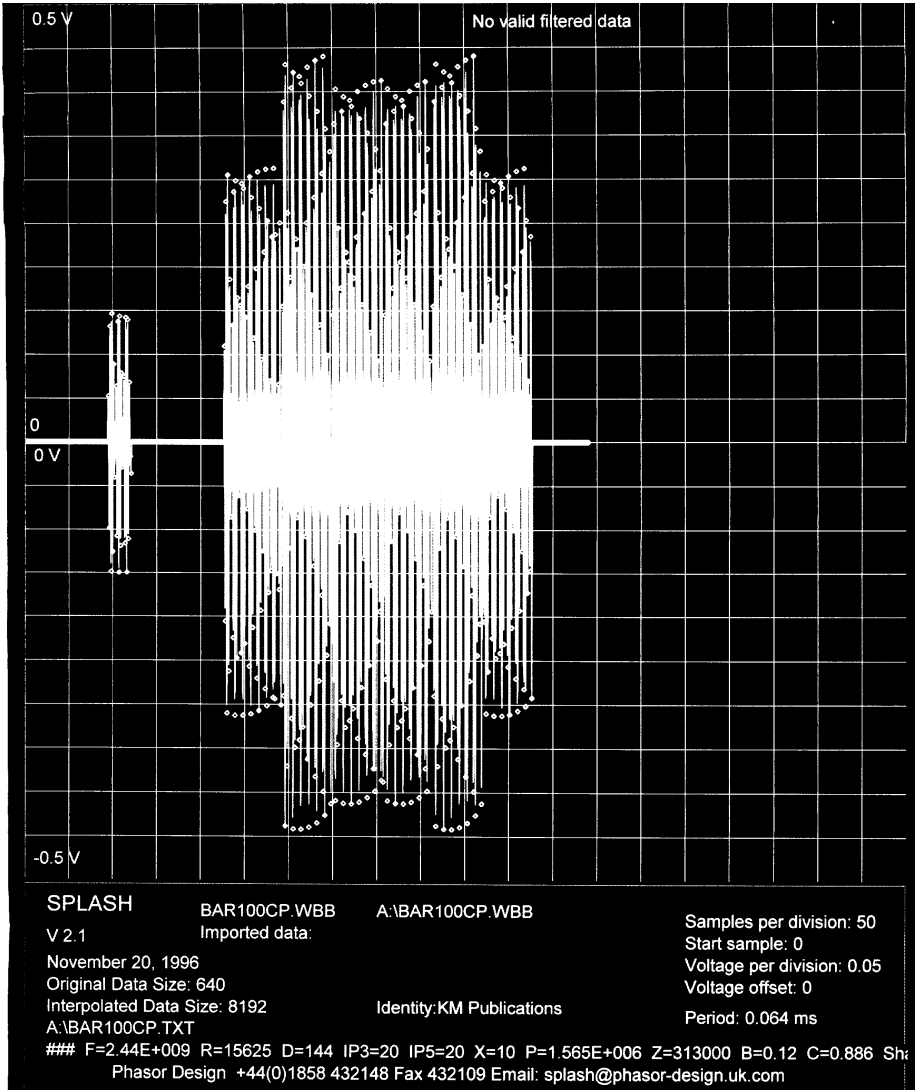

**Figure 2b**

The user manual I found to be of little value to me, essentially a novice, the Help file got me going in quite a short time.

Experimenting with the on-board specimen data files, I was soon negotiating the package and producing oscillograms and spectra with ease.

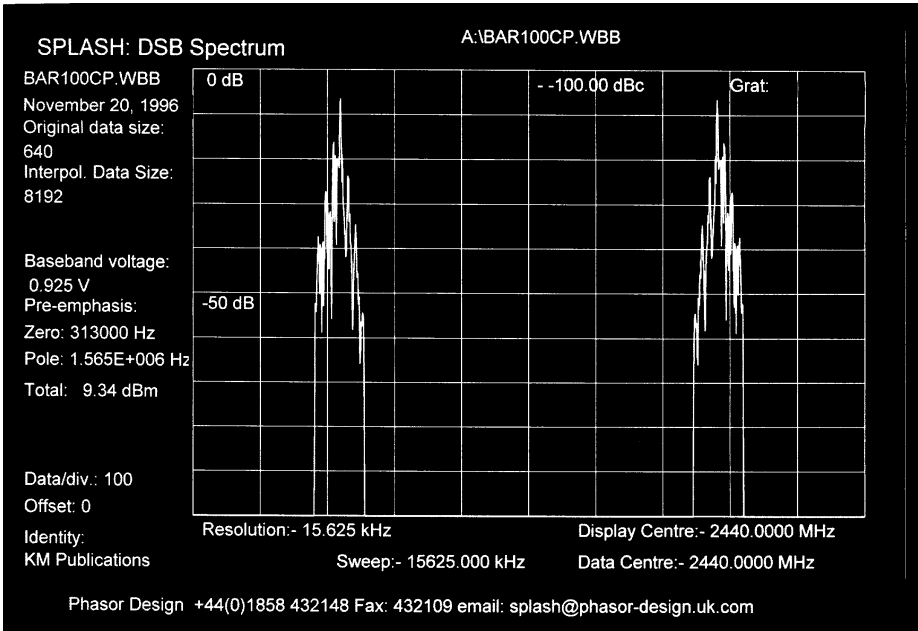

**Figure 2a**

Dealing with a subject I am quite familiar with, i.e. a video waveform, and because I am not 'quite' up to generating my own data files yet (!), I have reproduced here plots made on my system from example WBB data files included with the package.

Video is a complex waveform, which these days contains monochrome (luminance) and colour (chrominance) information. To model this complex waveform separate shaping is necessary. Consequently 2 WBB files are used, one for each component. Firstly the monochrome information is shaped and processed, the resultant waveform and spectrum shown in Fig.1. Then in Fig.2 is the same for the chrominance information. Fig.3 shows the FM spectrum of the combined processed parts, the chrominance processed file having been imported into the luminance file, and then the combined file processed.

Note: These figures reproduced here are unfortunately in monochrome, the actual print output from SPLASH is available in colour, thus simulating the plots one would obtain from a pen-plotter.

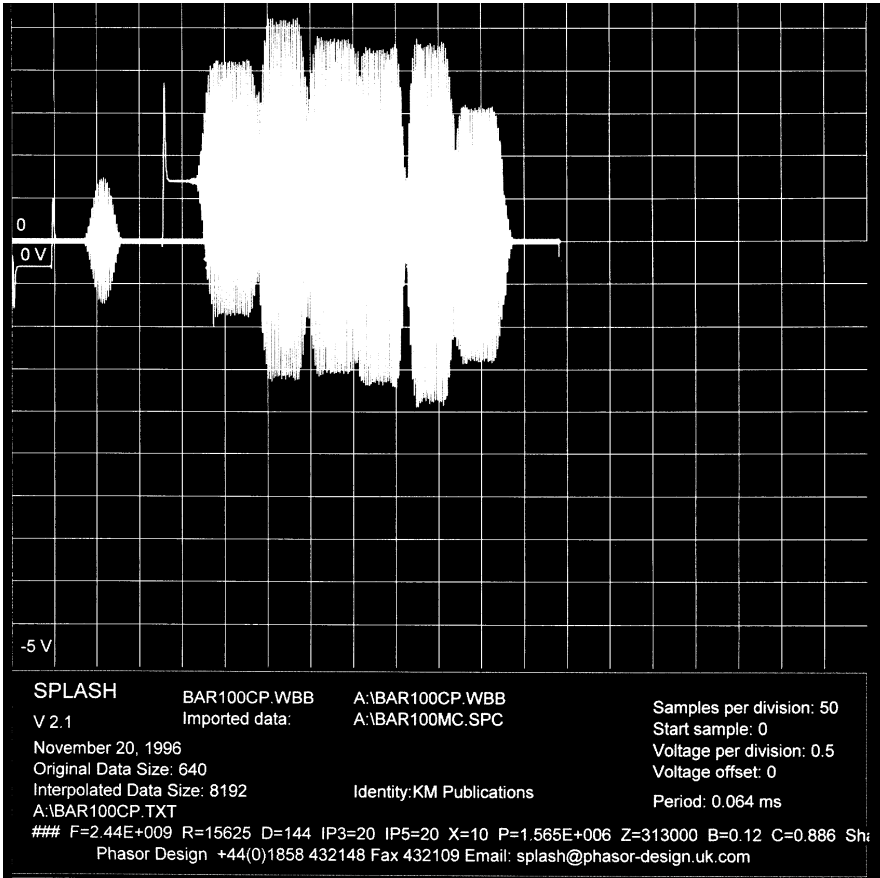

Figure 3a

### 3. Conclusions

As I said earlier, I am no expert in the field of spectrum management or transmitter design. However, I imagine that if I were, then SPLASH could be a good aid to the design process. The package is simple to use, being Windows based, and with a minimum of effort meaningful results can be obtained. My only complaint, and that is based on the fact that essentially I did not entirely know what I was doing!, is that the user manual could have a lot more information on how to use the software. That aside, the on-board Help files more than compensated for the lack of printed material. The assumption has been made by the software developer(s), and this of course may be somewhat invalid, that any potential user of SPLASH must be Windows and computer literate. I personally know of many engineers who are neither.

## SPLASH - a Review

I wish to thank Phasor Design for the loan of the review package. The system used in the review was a 133MHz Pentium based PC with a GraphixStar 600 video accelerator and an NEC SuperScript 660 GDI Laser printer.

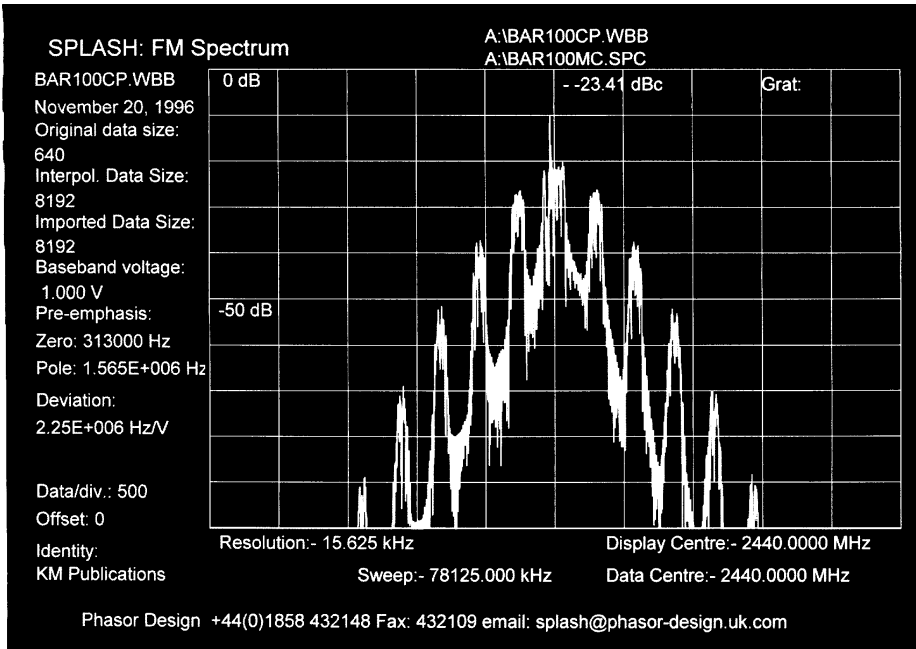

Figure 3b

SPLASH is available from S.J. Technologie, 183 Station Road, Burton Latimer, Kettering, NN15 5NY, UK. Tel: +44(0)1536 420163; Fax: +44(0)1536 420174. The introductory price (valid until 1st April 1997) is £325 (US \$490).

For further technical information contact Phasor Design, 16 Blenheim Way, Market Harborough, LE16 7LQ, UK . +44(0)1858 432148; Fax: +44 (0)1858 432109

## SSTV or FAX?

**By Eric Edwards GWXLJJ alias GW6ANU/T**

I have been qrt for some considerable time due to a complete change of work and a corroded aerial / cable set up plus scrapping of the ancient 2mtr. rig. I had a hand held 2mtr rig so could still listen but it was not man enough to tx especially into my aerial array or what was left of it.

I eventually sorted out the rf side enabling me to tx once more. I began to take a revived interest in sstv, so I frequently monitored 144.500 whilst working in the shack. My 128x128 8secs system was far from well so I was unable to use that as my sstv mode.... just as well it seems as everyone I heard was using MARTIN 1. What was that? I eventually found out when I obtained a 386 PC from my very good friend Mike GW4JKV and a copy of JYFAX7O from another long standing friend Cess GW8MTLJ alias GW3OAJ/T. Ah yes they were the days!

As a result of reading an article of mine in CQTV (where else!) Bob Barnes from Australia sent me a copy of a pcb prog. PROTEL . this is similar to EASY PC etc. but in my opinion a superior system. With the Australian CAD I produced PCBs enabling me to construct a sstv transmit converter. From a standard PAL 625 line video signal I could transmit a sstv pic with a resolution of 256 pixels by 256 lines at a readout of 30seconds. The results were encouraging and I had JVFAX7O installed so I could set up my converter. I was now ready for an off air test. Listening on two, I heard sstv stations a little distance away but strong enough for me to resolve their sstv pics saw pictures of Indian heads, aeroplanes, cars and other such things .I eventually broke into the qso to say that I was receiving their pics and enquired if they would be interested in receiving some of my 30seconds pictures in glorious black and white. On receiving a positive reply I sent my pics. Well that created some confusion! "I can't store your pics" was one reply. "You have one picture leading into another" was another remark. A third comment was "how did you do that! Have you got a camera?" I had to admit to owning a camera, several in fact!

What pictures were they sending then? I have often heard them saying "I have lots more pictures on disk I could send but you may have seen it so many times before". I could have answered that, and I have only just come back into sstv or whatever it's called.

I thought I would try this MARTIN 1 mode thing so in one of my pc progs (pressworks) I drew a test card. A circle with colour bars, grey scale

## SSTV or FAX?

and callsign. I then "pasted" this into WINDOWS PAINTBRUSH to convert it to a BMP file. Once this was done, set up etc it was then transferred to a GRAPHIC prog. GWS to convert the BMP file to a GTF file. It was then a simple operation to load the GIF file from WINDOWS to JVFAX70 using XTREEGOLD.

On the next opportunity to transmit, I sent my test card using JVFAX 70 in MARTIN mode 1. The comments then were, of course, "Where did you get the test card from"? This JVFAX70 is excellent for promoting sstv. I acknowledge the technical expertise of all concerned in producing this and other programs to be installed on home computers, but I think the sstver should do SOMETHING themselves. Sending pictures of cars, ships, boats and planes is fine. But that sort of thing could be sent using the fax mode. After all that's the best resolution mode. Let's face it sending STATIC pictures is fax.

Well, my 30second black and white converter is going mobile. Yes I shall be leaving BARRY in SOUTH GLAMORGAN to travel to BLACKWOOD in GWENT transmitting TELEVISION pictures all the way.... A distance of approx. 25 miles by road. I shall write to let you know the results.

HAPPY SSTVing or FAXing

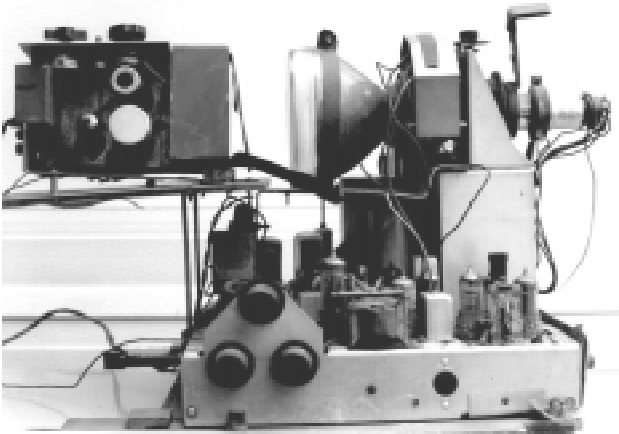
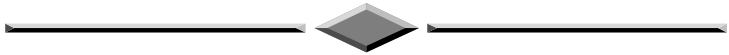

An early flying spot scanner built by Alf Mason G8AIL.

( See page 70 )



# VHF COMMUNICATIONS

**VHF COMMUNICATIONS** magazine is published quarterly and is available from **KM Publications**, 5 Ware Orchard, Barby, Nr. Rugby, CV23 8UF, England.

Telephone: 44 (0) 1788 890365, Fax: 44 (0) 1788 891833

Email: [vhfsubs@g6iqm.demon.co.uk](mailto:vhfsubs@g6iqm.demon.co.uk)



Photograph by Rodney Harrison I.R.F.P.

The 1997 subscription rate is £18.00 for cash or personal cheque (drawn on a UK bank, or bearing the name of a UK banking agent), postal orders or bankers draft made payable to VHF Communications. Payment may also be made by any major credit card at £18.90. The subscription included surface mail charges, airmail is extra at £6.50 per year (£6.85 by credit card). The magazine is a **MUST** for the radio amateur and professional engineer interested in VHF, UHF and Microwave working, containing, as it does, detailed construction articles for equipment operating in these bands.

**Back Issues: special offer - enquire for details**

**Binders to hold 12 issues..... £5.50**

**Complete Index 1970 - 1995..... £2.75**

**URL UK Site**      <http://www.eolas.co.uk/ag/vhfcomm.htm>

**URL USA Site**     <http://clearlight.com/~vhfcomm>

## TV on the Air

By Graham Hankins G8EMX.

During the lazy hazy (crazy?) days of summer, Peter Johnson G4LXC and Trevor Wooding G0VUN set up a microwave station running 3cm and 24cm ATV close to the North Forlands lighthouse at Joss Bay, near Margate.



I'll let Peter, who sent me a three-sheet, handwritten letter (hurray!) give his own account: "After spending most of the Saturday morning trying unsuccessfully to make contact on 144.750MHz, Trevor tried the 70cm Lowestoft repeater (about 75 miles away) and managed to raise Richard PE1OUP and Frank PE1EWR. Frank was able to contact a few more Dutch amateurs, who finally got (another) Peter, PE1DCD, onto 2m in our direction.

By lunchtime and into the afternoon we exchanged pictures and sound on 24cm and 3cm duplex on both frequencies with PE1DCD/P who was at JO21AX. Picture quality varied between P1 - P5, with a total loss when ships interrupted the path. 2 metres was not useable at all."

The Kent team enjoyed over three hours of duplex ATV with PE1DCD/P, 20W on 24cm and 800mW on 3cm at JO21AX and PE1PSJ/P running 300mW on 3cm from the same location.

On the Sunday morning Peter G4LXC set up at the same location, this time with a 25W s.s.b. multimode 2m rig. "By mid-morning we had made contact with PE1DCD/P again and achieved more two-way duplex ATV on 3cm with P1 - P5 pictures. At 1330 GMT we successfully contacted Hans PE1ECO/P on a barely readable 2m s.s.b., in contrast to

the 3cm pictures which were almost immediately up and running at P5". G4LXC was using two dishes so a duplex contact was possible with Hans PE1ECO/P and PA3FXY. Hans was running 300mW on 10.4GHz.

Peter's propagation conclusions? "My 3cm transmitter was running 22mW and seemed to disappear first, when ships passed, but I noted that higher power signals eg. 300-800mW did not completely disappear. Maybe the extra power produces a scattering effect around shipping?"

The other factor is how high is the sea duct? The average ship is about 10 - 20 metres high so if this blocks the low power signals then this would indicate that the duct is no more than 60 feet.

On the next trip I will position two stations. One will be at 10 metres, the other at 20 metres and see if there are any major differences -there might even be more than one duct! "

Equipment at G4LXC comprises:-

28" prime focus dish fed with 22mW lnb via a change-over relay for Tx/Rx.

63cm offset dish with 20mW lnb connected to a vertical/horizontal splitter with 90 degree rotation for Tx/Rx operation.

The transmitter and receiver are all home constructed and fitted with 6.0MHz/6.5MHz selectable sound on sub-carriers. Soon the receivers will be fitted with an agc tone to aid dish alignment - a very useful mod. suggested by Peter PE1DCD.

## **24cm Sound Carriers**

ATV sound carriers on 24cm are accepted as 5.5MHz for Europe and 6.0MHz for the UK. But on 3cm, it's more complicated. 6MHz for UK, 6.5MHz and 7.01/7.02, 7.5MHz seem to be used because of satellite receivers in Europe. So maybe we should all have tunable sound on our home-brew portable transmitters and receivers?

Best 73s

from Peter Johnson G4LXC, Kent.

Hi Graham, Here is the November ATV News from Auckland

Two ATV stations took part in the Scout Jambouree On The Air (JOTA) event in the Auckland area. Also there was a relay of the OPTUS TV satellite JOTA feed from Australia through the ZL1BQ channel 39 ATV repeater. Wally ZL1VWM and Grant ZL1WTT operated from Camp Maynard on the Albany hill along with many other amateur radio

activities provided by members of BR 29 (North Shore) of NZART. Ashly ZL1AG and Bruce ZL1BLB operated from St Judes Scout Den in Avondale alongside the members of BR 03 (Western Suburbs) of NZART. A lot of equipment was loaned from various ATV operators to equip these two stations. Barry Ward ZL1UFD and Rod ZL1ULZ operated the satellite receiver tuned to the OPTUS satellite patched to a 70cm ATV transmitter. Switching transmitters on and off was co-ordinated on 2m simplex (147.400 MHz the FMTAG approved ATV voice frequency). The scouts were very pleased to "see" (and hear) each other across town on television and watch (the somewhat snowy) signals from Australia.

Trevor ZL1BKG is equipped for SSTV using a combination of home built hardware based equipment (LM9000 scanvertor kit set from VK) and software using a PC (JV FAX and HAMCOM). The two items are linked together so that there are facilities to frame grab on the LM9000 video signals from camera, off-air, etc then transfer to the PC.

Once in the PC the images can be stored on disc, edited and manipulated in many exciting ways with artwork and drawing software. Then the images can be sent back to the LM9000 for transmission on radio.

Trevor is making FSTV progress with his own transmitter under construction. The metalwork is done and the circuit boards are built up. Meanwhile a transmitter borrowed from Ray ZL1BDU puts in a good signal into the ZL1BQ ATV repeater. Live camera work and the pick of the SSTV images from the HF bands are the content of his ATV transmissions on the Sunday evening ATV Repeater net. Trevor also takes part in the Tuesday night operating sessions that are happening quite regularly of late.

At the November meeting of the ATV Interest Group (part of the Auckland VHF Group) Michael ZL1ABS had six new tapes from an ATV friend in the USA, Dr John Fox WB2LLB of Huntsville, Alabama. Dr Fox operates SSTV, FSTV, Internet Sound & Video and is an international Amateur Radio Video tape exchange correspondent. A satellite dish in his backyard delivers many hours of fascinating video items from NASA Select, PBS (wonderful documentaries) and others.

Grant ZL1WTT is making progress with a 23cm preamp and is looking at aerial and transmitter designs. Wayne ZL1UJK, whilst not present, had given one of his Teletext Video Generator MK 3 printed circuit boards to be shown at the meeting. The things to note are that the MK 3 p.c.b is smaller than the MK 2 p.c.b and it will fit in the verobin modules used in the ZL1BQ repeater. This will allow the number of pages to double (from

16 to 32) because the MK 3 p.c.b has two EPROM sockets while the BATC p.c.b currently used, only has one. A five volt regulator is on-board.

The Group is using the MC1377 RGB coder pcb from Wayne ZL1UJK at the moment and it is compatible with the MK 3 pcb too. The MK 2 printed circuit board used a TEA2000 coder i.c. which has become an obsolete item, not suitable for new construction.

Meanwhile Wayne ZL1UJK, Quentin ZL1QF, Michael ZL1ABS and other Auckland VHF Group members were away at the Taupo Hamfest weekend. A small ATV equipment demonstration was held in the hall during the later stages of the used equipment sale. There were some bargains to be had! Wayne ZL1UJK did particularly well obtaining many useful audio valves and a MK1 Ferrograph reel to reel audio tape machine.

In Hamilton, Jerry ZL1RN dismantled his home ATV station and took it to a JOTA campsite. He had contacts through the ZL1UX ATV repeater to Bill ZL1BRI. He comments that he needs more equipment so that the home station aerials don't have to come down every time portable operation at special events is required! A fund raising effort has been started in Hamilton to finance improvements to ZL1UX. New aerials with omnidirectional radiation pattern and a more powerful 615 MHz linear power amplifier (as used by ZL1BQ and ZL3AC in Christchurch) are two of the things planned.

73 de Michael ZL1ABS ZL1ABS@ZL1AB.#11.NZL.OC

Now some U.K. Repeater Group news. The Severnside Group in Bristol send their 'P5' newsletter just in time! Mike G7GTN reviews a 'Sima' screenwriter character generator picked up at the Leicester rally, Phil G1HIA reports the Group's ATV International Contest team effort and Ian Bennett G6TVJ considers the 13cm ATV band (2.31GHz to 2.45GHz). Ian begins: "13cm is probably one of the more obscure amateur bands in use in the UK", then demystifies with 'How to get onto 13cm', 'antennas', 'Results' and construction details for a synthesised 13cm exciter. Ian ends with a tantalising glimpse of a microwave IC PA delivering 900mW at 13cm for only 5mW drive! At only £40 for the i.c. Ian says: "Plans for this PA will appear in a future 'P5' and perhaps 'CQ-TV' as well". I hope so.

At the Leicester Show I picked up a copy of 'Lens' from the Leicester Repeater Group. LRG run ATV repeater GB3GV and David G8OBP announces: "GB3GV is Back! In April 1996 a new receiver and switching logic was installed, giving much improved receiver performance. With

the addition of PC- generated graphics (August '96), 'GV is now performing very well, with encouraging signal reports from Warwickshire, Derbyshire, Nottinghamshire and the West Midlands".

Now there are other repeater 'groups' I have spoken to by phone, who may have news or newsletters but have not sent anything. Chesterfield is one, Enfield is another - they even have a packet BBS! Come on folks, "Letsby Avenue!"

The Coventry ATV repeater GB3RT is still on air, having 'weathered' its fair share of past difficulties. I am informed that a new RT Repeater Group has been formed and that firm plans are now developing to move the repeater from its current site at Tile Hill. The new 'home' will be to co-site with voice repeater GB3WK near Leamington Spa. This should give much greater height, hopefully better coverage and, vitally, easier access for maintenance and more frequent technical updating. The new keeper will be Dave Murray G1GPE.

If many of you are thinking "what happened to that Birmingham Repeater mentioned some time ago, when are these tests going to be done?" We were going to test from a high office block, and may still do so. At the time, though, the only day available for access were Saturdays, and commercial aerial work at the site ruled some of these out. Then, with the embargo on new 24cm licences, there seemed little point in arranging access for a test if little could be done at the time to progress a new application. If this situation as eased significantly, fresh arrangements may be made if the site is still available.

### **OBITUARY: SILENT KEY G.A.C.(ALF) MASON G8AIL (ex G6CIK/T)**

Alf Mason G8AIL, 86, passed away in October at his home in Yardley, Birmingham. He had been a radio enthusiast all his life, taking an active interest in broadcast and amateur radio and television.

Alf was a very early member of the BATC - he is included in a Membership List for 1966 and we found CQ-TV No.19 (January 1954) during the tidy-up. There may even be CQ-TV No 1 somewhere in the house!

Alf had been active with ATV in the 405 line era, using the callsign G6CIK/T. In his workshop there was still a home-brew flying - spot scanner, 405 line sync. pulse generator (with 42 user-adjustable pots!!) and enormous 70cm ATV transmitter. Alf never 'converted' up to 625 line ATV, or 24cm, but was active on 2m packet and 70cm phone right up to the night of his death. A phenomenally knowledgeable chap, well-

respected and often consulted by his radio-amateur and many other friends.

### **Repeater Group Affiliations for 1997.**

These should be going out soon to the correspondence addresses given in 1996. PLEASE respond to these promptly - we do like to know current status of the repeater groups. I may also begin to ask each Group for info. tri-ennially (does that mean three times a year?!) to co-incide with each CQ-TV deadline.

The present 'Affiliation Benefits' and associated 'Notes' is presently under review, but under 'h' in the current document is "listing of repeaters in CQ-TV and other BATC publicity". So here is a latest repeater list:

#### **ATV REPEATER LIST (all 1.3GHz fm unless other stated)**

GB3UT Bath (AM)	GB3TG Bletchley (10GHz)
GB3VR Brighton	GB3ZZ Bristol
GB3XG Bristol (10GHz)	GB3PV Cambridge
GB3TT Chesterfield	GB3RT Coventry
GB3CT Crawley	GB3TV Dunstable
GB3EY East Yorkshire	GB3VI Hastings (AM)
GB3HV High Wycombe	GB3GV Leicestershire
GB3LO Lowestoft	GB3TN Norfolk
GB3MV Northampton	GB3TM North Wales
GB3NV Nottingham	GB3UD Stoke on Trent
GB3ET West Yorkshire	GB3VR Worthing

Please keep sending by letter or packet to me,  
G8EMX @ GB7SOL. #29.GBR.EU

# DX-TV RECEIVER SYSTEM

Variable vision IF bandwidth Multi-system sound

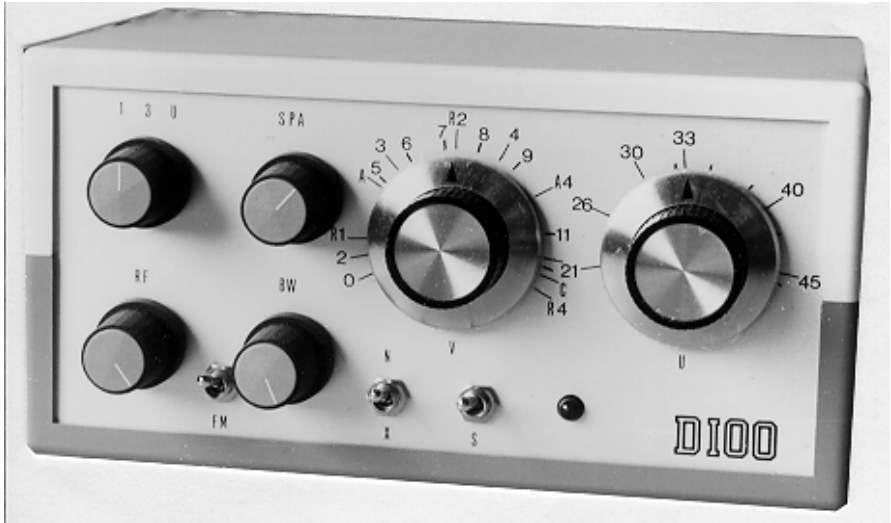

New 'SUPER-X' model now available, send SAE for more technical info now.

The D-100 'Super-X' receiver provides multi-system sound reception plus reduced vision I.F. bandwidth feature to recover signals normally lost in the noise when using a conventional I.F. bandwidth.

There are two outputs, one feeds a TV at channel 65 for vision, while another feeds an FM radio for sound. By simply matching the sound to the picture, multi-system reception is achieved, without the need for a special TV set.

DX-100 'SUPER-X' CONVERTER.....£138-00

**Illustrated Catalogue of Equipment & Publications only £0.75  
(refundable with the first order)**

*We can also manufacture aerials to your own design (one-off or multiples),*

## HS PUBLICATIONS

**7 Epping Close, Derby DE22 4HR, England**

**Tel: 01332 38 16 99**



## **Second Welsh Microwave Fast Scan ATV Tests**

**By John Lawrence GW3JGA**

Sunday 13th October, 1996 saw the continuation of the Microwave ATV tests which were carried out in March this year and reported in CQ-TV 175 and filmed and broadcast (twice) by HTV Wales as part of the 'Bob and Brian Broadcasting' programme.

The tests took place over the 109 km (68 mile) path across Cardigan Bay between a lone Bob Robson - GW8AGI located on the Preseli Mountains in South Wales (NGR SN 074 322) and a positive gaggle of Microwave ATVers located on the Lleyn Peninsular in North Wales. These included Brian Davies - GW4KAZ and David Ellis Jones - GW8PBX located at the Arfon TV transmitter site and home of the Arfon 2m repeater GB3AR (NGR SH 476 493), while 10 miles to the south west, spread out over a small flat location on the side of Mynydd Carnguwch (NGR SH 376 423) were Bob Platts - GW8OZP, Malcolm Cox - GW3GRM, Barry Suddaby - GW8FEY, John Cronk - GW3MEO and John Lawrence - GW3JGA.

In spite of an horrendous weather forecast the night before, promising heavy rain and gusting high winds, it was decided to proceed anyway and, as it turned out, the Manchester Weather Centre was wrong about the rain but absolutely right about the winds. Dishes and tripods were going over like ninepins (tenpins to our younger readers) and had to be weighted or tethered to rocks, stakes or anything heavy and handy. GW8OZP/GW3GRM found an old piece of railway line - ideal!



Initial tests were conducted on 23 cms with P5 pictures being exchanged between GW8AGI and GW4KAZ/GW8PBX at Arfon, also between GW8AGI and GW3JGA/GW8FEY at Mynydd Carnguwch. It was not possible for the two North Wales groups to exchange pictures due to the massive mountain in between them. Voice communication between all stations was easily maintained on the usual ATV talk-back channel of 144.750 MHz.

On 3 cms GW8AGI suffered a burnt out choke in his LNB which caused some head scratching, but once the offending component was bridged performance returned to normal. However, conditions on 3 cms were difficult and it was necessary to use dishes at both ends to achieve P4 - P5 pictures. Replacing a 30 dB dish with a 20 dB horn resulted in signals dropping to P1. This convincingly displayed the threshold effect of FM ATV and the need to maintain an adequate level of received signal.

## *Second Welsh Microwave Fast Scan ATV Tests*

The extended transmissions on 3 cms from GW8AGI were very much appreciated as they enabled the North Wales contingent to test various combinations of dishes, horns and receivers. This meant that several 3 cm receiving systems were able to be brought up to an operational state and gave us lots of ideas for modifications and improvements. As a result, none of us should be short of things to do over the winter months!

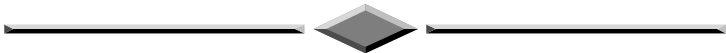
In spite of the high winds, it remained dry and reasonably warm. Everyone agreed that it was a great day out and a technical success, so much so that we hope to do it all again next year, possibly in May. Could this become an annual event, I wonder?

**Publications  
has Moved  
to:-**

**BATC Publications  
Fern House  
Church Road  
Harby  
Notts.  
NG23 7ED**

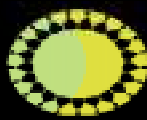

**BATC Rally 97**

**BATC RALLY 97  
SUNDAY APRIL 27th  
SPORTS CONNEXION COVENTRY**

**AT THE SAME VENUE AS THE LAST THREE YEARS THE  
BATC RALLY WILL BE AMONGST**

**THE LARGEST INDOOR RADIO EVENTS OF 1997.**

**OVER 200 TRADING TABLES, OUTDOOR BOOT FAIR,  
OUTDOOR TV DISPLAYS, BRING  
& BUY, SPECIALIST ATV GROUPS, ETC.**

**IF YOU WISH TO TRADE AT WHAT WILL BE ONE OF 1997's  
FOREMOST RADIO**

**RALLIES PLEASE CONTACT MIKE AS SHOWN BELOW.  
TABLES WILL COST £22.50  
EACH (ELECTRICITY £5.00).**

**ALL DETAILS FROM THE RALLY ORGANISER:  
MIKE WOODING G6IQM, 5 WARE ORCHARD, BARBY, Nr.  
RUGBY, CV23 8UF.**

**TELEPHONE RESERVATIONS: 01788 890365**

**FAX RESERVATIONS: 01788 891883**

## Signal Calculations

By John Stockley, G8MNY

With several radio path loss programs now available to amateurs, it becomes possible to predict the P grade for any ATV contact. Data is needed for these five parts of the problem.

<b>TX IERP</b>	TX power. Coax & connector losses. Aerial gain dBi.
<b>PATH LOSS</b>	NGRs for distance, (used with a terrain Aerial height, (database for Frequency (loss calculations.
<b>RX SIGNAL</b>	Aerial gain dBi. Coax & connector losses. ALL THE ABOVE
<b>RX SENSITIVITY</b>	Noise figure (preamp & Rx). Bandwidth.
<b>'P' GRADE</b>	S/N Conversion.

Most people can only make a guess at these or, worse still, use makers figures.

TX IERP is a straight forward calculation, best done in dBW.

$$\text{TX IERP} = \text{TX dBW} - \text{LOSS} + \text{GAIN}$$

PATH LOSS has 2 parts:- the Free space loss and other losses. The free space pathloss can be calculated directly from the distance and frequency, where D is in KM and F is in MHz.

$$\text{FREESPACE LOSS dB} = 20\text{LogD} + 32.4 + 20\text{LogF}$$

However on 23cms it is heavily modified by obstructions like hills, buildings, trees etc. The use of Pathloss program with a UK heights database can take into account hill diffraction loss, reflection loss etc, but this will still be a best path guide. Under lift conditions losses can get close to the free space loss. If you don't have a program you will have to guess at these additional losses.

PATH LOSS = FREESPACE + DIFFRACTION + REFLECTION + OTHERS.

RX SIGNAL level is now just the Rx losses added to the other figures and converted to dBm.

SIGNAL (dBm) = TX IERP +30, -PATHLOSS + AERIAL GAIN - COAX LOSSES.

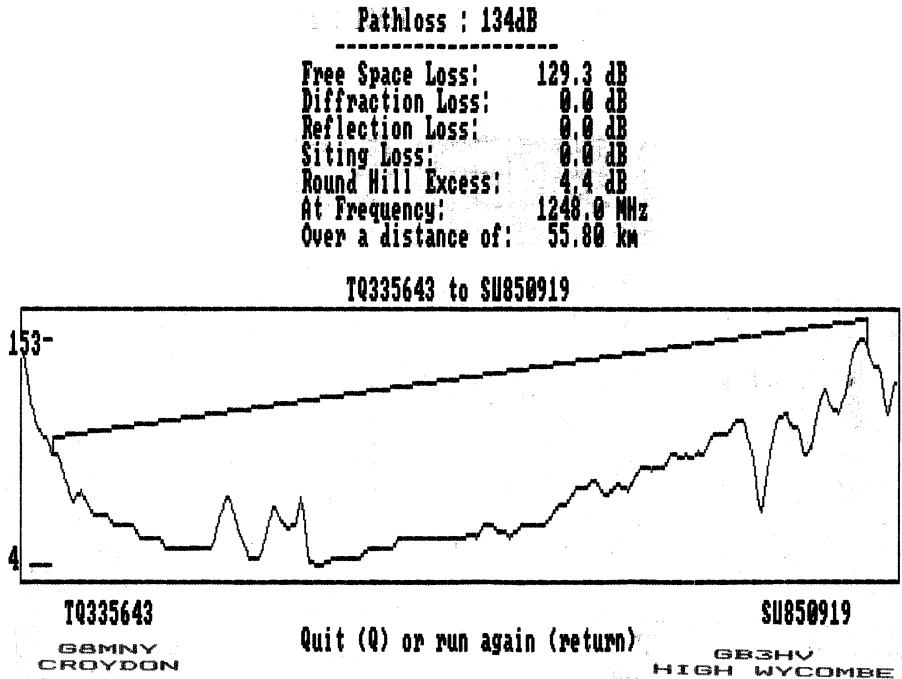

Figure 2 - Example of a Pathloss Program

RX SENSITIVITY calculation is slightly more complex with bandwidth (in Hz) and overall noise figure (dB) needed to get the noise floor with the -174dBm/Hz from Boltzmann's constant (at room temp). The bandwidth figure assumes an ideal square IF response shape, so a Sat Rx with no IF filtering may be 27MHz wide, a dedicated FM ATV RX good on sound and colour Rx may be 13MHz, and a narrow DX RX may be only 6MHz wide! 70cms AM TV will be 5MHz unless narrow IF is used. Noise figures of preamps and Rx are additive, but as long as the Rx noise is drowned by the preamp noise by 10dB or so then take just the preamp noise figure. Noise figures of just the preamp device itself can be

## Signal Calculations

misleading as input tuned circuits and radiated/PCB losses can often add 1 dB to this.

$$\text{NOISE FLOOR (dBm)} = \text{NF} - 174 + 10\text{Log BW}$$

RX S/N is just the difference between the noise floor and the Rx signal. This is what is in the IF before the FM discriminator or AM detector.

$$\text{S/N (dB)} = \text{SIGNAL} - \text{NOISE FLOOR}$$

'P' GRADE calculation is an arbitrary conversion assuming P5 is 35dB S/N (eg good VHS tape) going down to P0 at no signal. With FM there is a capture affect and also the visible noise is quite different, but with narrow FM ATV (not a Sat Rx) the effect is not as far from linear as you might expect. I have found this formula gives quite an acceptable conversion.

$$\text{P grade} = (\text{S/N} + 3) \times 0.13$$

CALCULATED RX SIGNAL FROM G8MNY TO GB3HV

INPUTED PARAMATERS:-

FREQUENCY 1248 MHZ	POWER 20 W = 13 dBW
TX COAX -2 dB	TX AERIAL 17 dBi
RX COAX -1 dB	RX AERIAL 9 dBi
PATHLOSS -134 dB	NOISE FIGURE 1 dB
BANDWIDTH 13 MHZ	

CALCULATED RESULTS:-

TX IERP = 632.4 Watts = 28 dBW
RX SIGNAL = -68 dBm = 89 uV (in 50 ohms)
RX NOISE FLOOR = -101.9 dBm
RF SIGNAL to NOISE = 33.9 dB

'S' METER = S 9
'P' GRADE = P 4.7

Fig 2 Example from a basic program calculation

# Worthing & District Video Repeater Group

## GB3VR & GB7VRB

### 1Watt FM-TV 24cms Transmitter

The 1 watt transmitter generates its signal at the wanted frequency which can be set anywhere in the band, colour or B/W. On board intercarrier sound and fixed pre-emphasis are standard features. The kit includes the PCB all the on board components, pre-drilled heat sink, an Eddystone Di-cast box and full and comprehensive instructions. Building time is three evenings work. The new price for this kit is £80.00, P&P £2.50. Over 650 units sold to the Amateur market alone.

This is probably the biggest selling TX kit in the world!!!

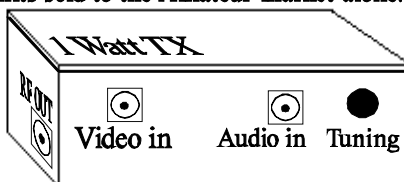

### Two channel phased locked loop kit.

This add-on kit vastly improves the overall stability of the 1 watt transmitter. Two crystal locked channels and a third free running tuning position are available. Kit price £30.00

### Amiga ATV Program-2

The New Amiga ATV program has more features than ever, up to 56 testcards, 20 wipes, superb text control, 30 screens of text messages, QRA calc, Testcard music, selectable displays, and this version has a DTMF tone pad to control your repeater. All testcards are over-scan i.e. the whole screen is used, Load in your own customised testcards, Extra large text, scrolling text, clock, callsign extensions, Hot key operation, Doc reader, ATV Cli, Cross Hatches, Purity and a comprehensive section for genlock users. For any Amiga with 1meg or more, state callsign and QRA (if known) when ordering, this three disk set is now only £10.00 P&P 75p

### Spectrum ATV Program

Still selling after all these years, why, its good, its cheap and it works on all spectrum based machines. The 48k version has over 60 commands which include 7 Testcards, Memo pad, clock, maps, tones, QRA locator, various size printing, plus disk transfer routines and much more. Now only £5.00 P&P 75p

PC ATV is coming.

Orders should be sent to:-

Treasurer of GB3VR, R.Stephens, 21 St. James Ave., Lancing, Sussex, BN15 0NN. Cheques payable to "W&DVRG" Tel (01903) 765760 7 to 8pm.

## An Introduction to One Group's 24GHz Experiences

By Tony Horsfall G4CBW

### Introduction

Over the last three years a group of us in the North West with a strong interest in all mode operation; Martin G7MRF, David G8VZT, Steve G4DVN, Sam GI8GJX and myself Tony G4CBW, have constructed equipment for the 10GHz and 24GHz microwave bands. Over this and the next issue of the CQ-TV magazine we would like to give a resume of the equipment built and results obtained, with particular emphasis on the 24GHz band.

In part two we will give a detailed look at what can be considered to be a 'state of the art' 24GHz multimode system for FM TV, wideband FM, narrow band FM, SSB and CW that transverts from the 23cm Amateur band. The design uses equipment and components that are available to all and can be built with success by the more determined amateur.

In the early days on 10GHz the group completed many expeditions successfully, which gave the group many firsts; GM/G, G/GD, GW/GM and EI/GW. During one of these expeditions a very early 24GHz system was taken to Scotland where the first 24GHz from GM/GI took place over a distance of about 50km. These expeditions gave the group the portable experience and sparked off the desire to move up to 24GHz. After group discussions, the design shown in Figure 1 was the route chosen.

The transceiver design is based on Gunn diode technology for both transmitter and receiver. The transmitter section uses a Gunn diode modulator similar to that shown in the ATV Compendium Handbook. The Gunn diode oscillator was obtained surplus and runs about 8mW. This is followed by the DB6NT 24GHz 5 stage amplifier. Total output, 60/80 mW.

The receiver side starts off with the DB6NT 24GHz 3 stage amplifier feeding into a cross coupler. The local oscillator is also a surplus Gunn diode module running at 22896.0MHz. This injection frequency was chosen to provide a 24cm IF from a 24GHz input. On the unused port of the cross coupler there is a waveguide dummy load. The output port is connected to a 'home-made' mixer diode assembly. This in turn feeds a 24cm GaAs Fet post amplifier, (existing 24cm technology). This then feeds a domestic tuneable satellite receiver



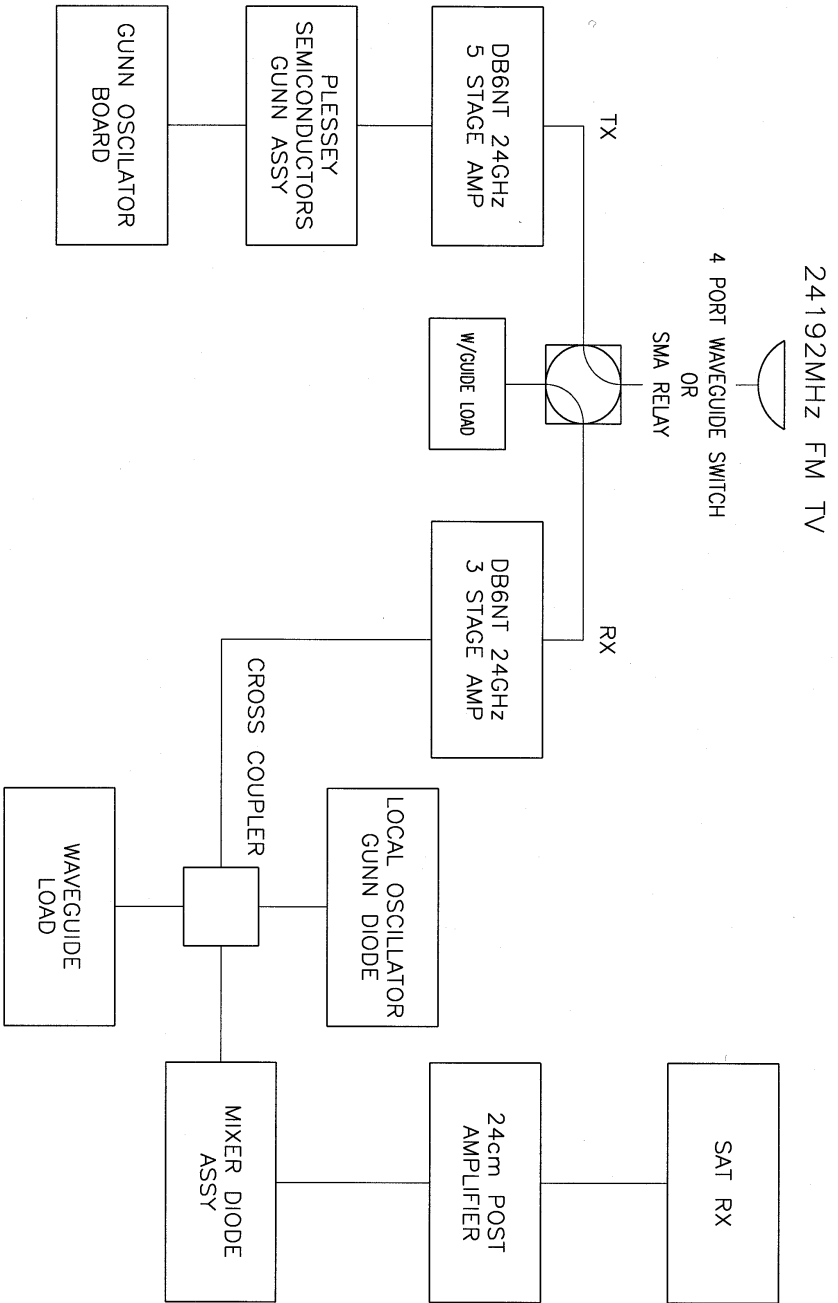

FIGURE 1

24GHz ATV TX/RX SYSTEM

## *An Introduction to One Group's 24GHz Experiences*

The DB6NT amplifiers use surplus MGF1903B GaAs Fet that were obtained from J. Birkett for £1.95 each. The design was published in 'Dubus', (subscriptions available from G4PMK) a long standing publication specialising in VHF, UHF and Microwave techniques. The PCB's are available from the RSGB Microwave Committee Component Services.

Although the diagram shows high-tech amplifiers being used, the design will work without the amplifiers but with reduced power output and receive sensitivity, and therefore reduced range.

For further information on cross coupler techniques, please refer to Microwave Handbook Volume 3 pages 19.10 and 19.19.

Figure 2 illustrates a typical physical layout, also shown is a 4 port rotary waveguide 20 switch.

At the end of July 1995, members of the Telford and District ARS went to GI, whilst there, GI8GJX/P and GI8VZT/P, made possibly the first ever two way 24GHz TV contact over a distance of 12km. With very simple equipment based on Figure 1. At the same time David took advantage of his EI license and a trip over the border to achieve the first EI to G on 10GHz TV with G3FNQ in Southport.

While David and the Telford group went to Ireland, Martin (G7MRF) and Tony (G4CBW) went to the West Coast of Anglesey to form the other end of the microwave test. The weather conditions were absolutely superb for microwave testing. All intended paths went perfectly well on 10GHz but were a total failure on 24GHz. The rest of our holiday was spent evaluating why the 24GHz was a failure. David and Sam in Ireland paired off to test their individual 24GHz systems over a short path.

Meanwhile, back on the west coast of Anglesey, Martin and Tony were evaluating the reasons why their systems were not performing. A series of tests were conducted, firstly, over the length of an adjacent field where P5/P5 was exchanged. Martin moved away 2km for the 2nd test which produced again, P5/P5. The path was then further extended to 10km, the results were now P5/P4. This was the first indication that the systems were not equal. One further test was made at a distance of 39km, the results were P5/P0, confirming our suspicion that there was something wrong with Martins receiver or Tony's transmitter.

On returning home, various tests were carried out on the systems to ascertain the reason for the failure of the 24GHz part of the expedition. Tests shown that the Gunn diode/waveguide flange had been mounted 90

*An Introduction to One Group's 24GHz Experiences*

degrees out onto its mating flange. (Note, unlike waveguide 16 flanges, waveguide 20 flanges can be connected incorrectly by 90 degrees)!

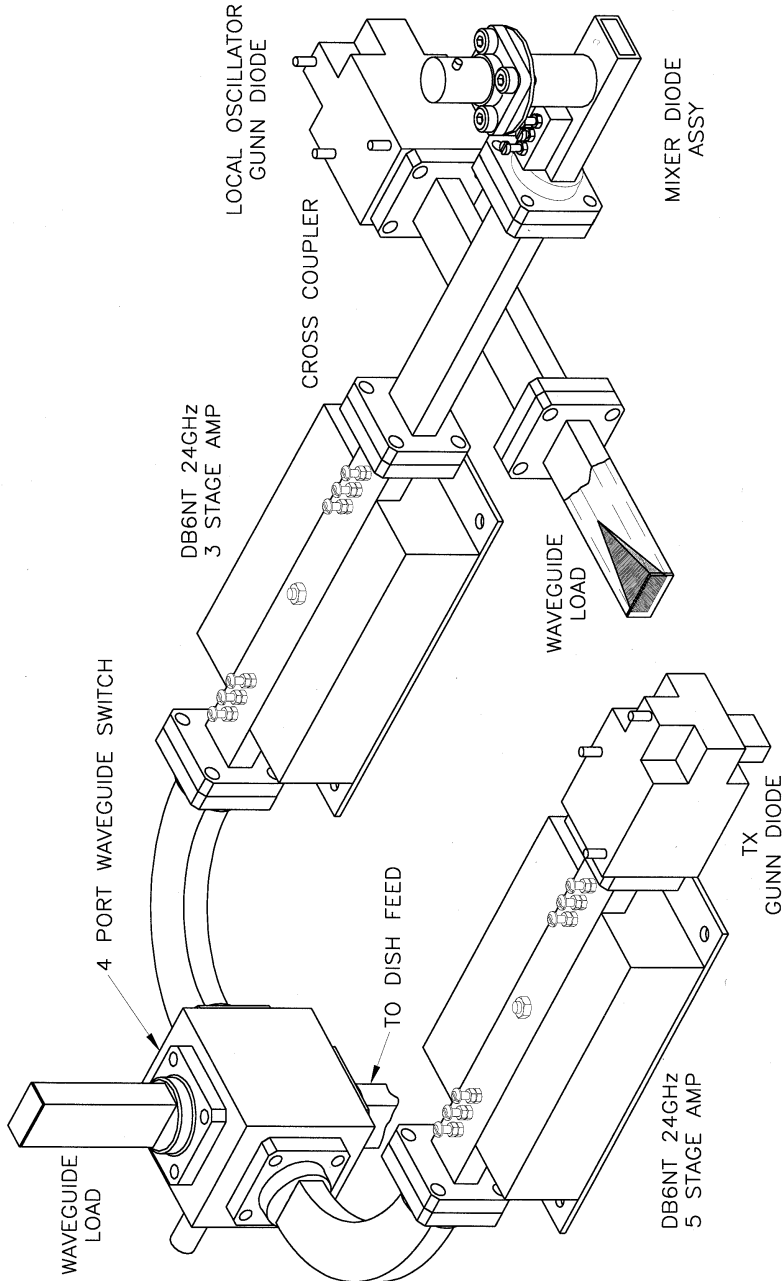

**24GHz ATV TX/RX SYSTEM**

FIGURE 2

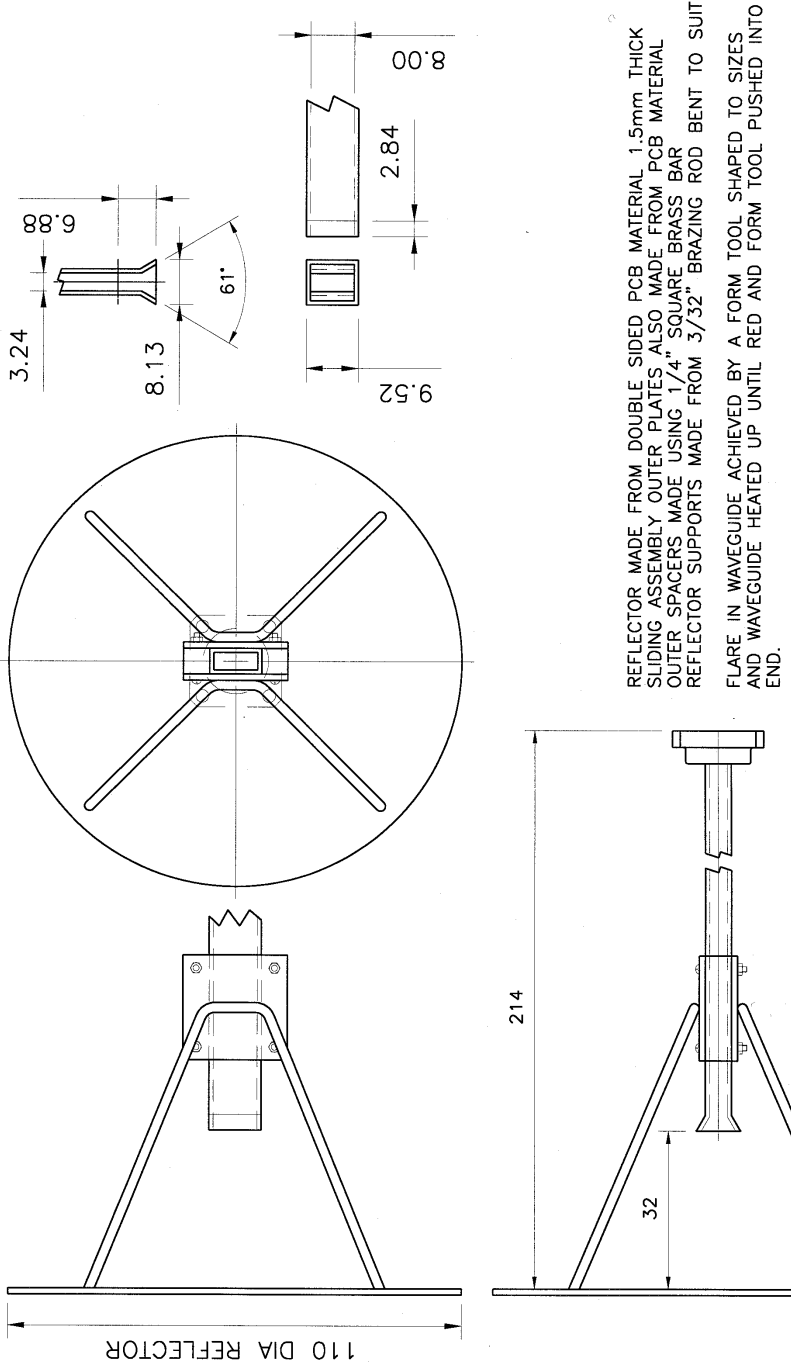

FIGURE 3

## *An Introduction to One Group's 24GHz Experiences*

By this time Steve, G4DVN, had now completed his interim home system for 24GHz, and tests were set up between Steve and Tony (G4CBW) over a 11km path (home to home). Martin brought his system up to Tony's location to compare the two systems back to back and it was found that Martin's system was a few dB's down in performance still. The search was on for the reason why. After exhaustive tests of the 24GHz RF electronics, no fault could be found. The attention now turned to the dish and its penny feed.

We hooked a Spectrum Analyser up to the IF to measure accurately the received 'off air' signal from Steve (G4DVN). It was found that Martin's dish assembly was approximately 8dB's down when compared to Tony's. Both dishes were approximately 58cm, one had a penny feed and the other was a commercial Shepherds Crook type '*back-fire*' feed.

We felt the problem was the penny feed. This was built using the design criteria as contained in the 24GHz section of the microwave handbook. Martin's dish is a 0.4 F/D and the penny feed is unsuitable for efficiently illuminating a dish of this ratio.

Our thoughts now changed to using a Cassegrain feed. Empirical tests using various disc diameters made from PCB material proved successful and we now noticed the differential between Tony's and Martin's gain narrowing. The final Cassegrain feed can be slid along the waveguide and clamped into position (see Figure 3). It was found that the calculated focal distance versus the physical position where the peak signal occurred was found not to be too critical.

The final design, as shown in Figure 3, when tested against Tony's commercial 23GHz dish and feed was found to be very comparable in gain. A further field trial over a 90km path between David and Martin was undertaken, whereby, the new Cassegrain feed was removed and replaced by the old penny feed. David reported about two 'P' points reduction using the penny feed.

Martin and a work colleague have written a basic program to calculate dish data; penny and Cassegrain feed dimensions. Whilst this type of program is not new, it has proven to be a real asset because in order to design a Cassegrain feed you can either lay it out in a drawing, which is particularly difficult, or you can calculate it using trigonometry. This programme does all the difficult calculations for you and gives real dimensions to construct the Cassegrain feed.

24192MHz FM TV  
 24192MHz SSB/CW  
 24192MHz NARROWBAND FM  
 24031MHz WIDEBAND FM

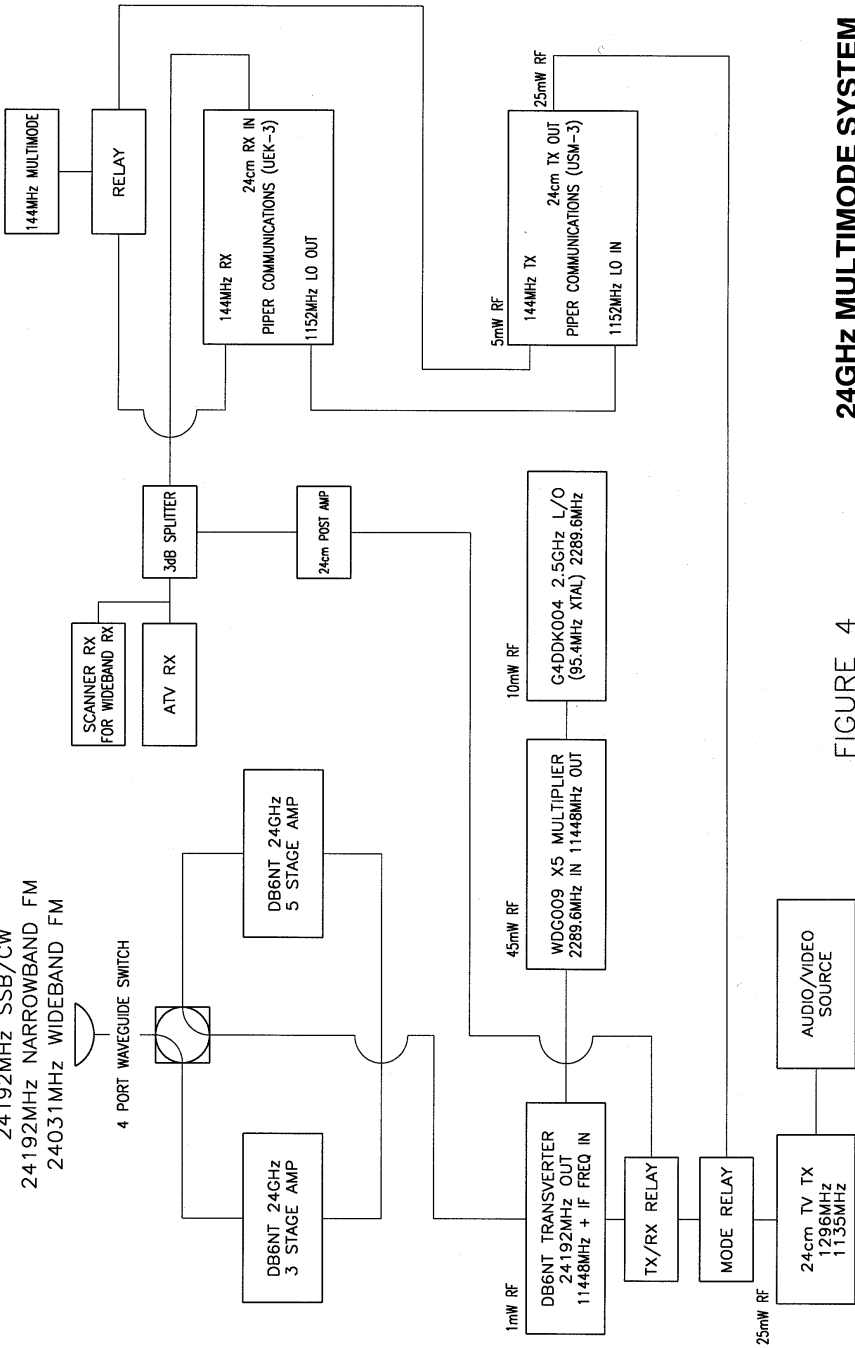

FIGURE 4

24GHz MULTIMODE SYSTEM

## *An Introduction to One Group's 24GHz Experiences*

**DISH FEED** - *Please note* that all dimensions shown are calculated from the program specifically for Martin's dish which is a 0.4 F/D. Please use the Public Domain program that has been uploaded to the *BATC Bulletin Board* (Telephone Number: 01633 614765), to design your own. It's quite simple to use. Some dishes may result in the flare that occurs in the waveguide end being none existent. This is OK. The program works out the flare dimensions for you.

The problems of working long paths on TV are dish alignment (60cm dish on 24GHz has somewhere in the region of 1.5 degrees beam width), and frequency error using Gunn diode technology. Figure 4, shows our final design that negates the use of Gunn diodes and as a multi-mode system allows contact to be made on SSB or NBFM first. This gives an enormous margin of signal because of the reduced bandwidths used. Our next article will describe in detail, the design.

**Note:**The Dish Feed Program is written for the PC using GW Basic. For those who do not have access to the Bulletin Board, the program is available direct from Martin, G7MRF, address:

Mr Martin Farmer  
3 Brackenberry  
St. Michaels Meadow  
Cross Heath  
Newcastle-U-Lyme  
Staffordshire  
ST5 9PS

Please include a Formatted 1.4Mb disk and stamped, self addressed envelope.

*By the time that you read this, it should also be available in the download area on the clubs web site. ED*

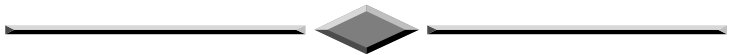

# **BATC on the Internet**

The URL (address) is:-

**<http://ourworld.compuserve.com/homepages/batc>**

## Post and News



Please send all correspondence for **Post and News** to the CQ-TV Editor. Ian Pawson, 14 Lilac Avenue, Leicester, LE5 1FN, England.

Tel: 0116 276 9425.

E-mail [ian@ipawson.cix.co.uk](mailto:ian@ipawson.cix.co.uk)

Members sales and wants, and trade adverts should be sent to the advertising manager,

Dave Hemingway, Ivanhoe, Glen Road, Hindhead, Surrey, GU26 6QE. Tel: 01428 604645

Dear Trevor

Re Bill Atkinson's letter in CQTV 176. I have a Yaesu FT 736 fitted with the 23 cms module, which I am interested in using for amateur TV on 23 cms. There is a problem in that neither of the two 23 cms modules for the FT736 has the frequency coverage to cover the output of the TV repeaters, which transmit above 1300 MHz. Make sure the 23cms unit you have been offered is the version which covers down to 1240 MHz. All is not lost however, because the transmitter is the potentially expensive bit of a 23 cms TV station and the FT 736 will transmit on the repeater input frequency band with the correct modules fitted. Bill already has a broadcast satellite receiver for amateur TV reception which has presumably been converted. If not you could invest in G8OZP's add-on board or his receiver kit which will produce better results, since it is specially designed for the job. As far as I can tell it is the associated TV module for the FT736 which determines that the FT736 uses the NTSC standard. I do not know if it is possible or how easy it would be to convert it to PAL. I believe that it puts out an amplitude modulated signal in my case. I am considering building an interface, if I can find out what signal is required at the transmitter input socket. I presume that it is a sub



carrier which would require to be frequency modulated for UK repeater use. If that is the case it should not be too difficult to produce. Hope these ideas are of interest and some use. I would be interested to share any information on this problem. Regards Alan Strong G3WXI, 50 Willow Park Road, Wilberfoss, York YO4 5PS.

*Thanks Alan. If anyone else has any info please let me have it and I will see it gets circulated ED*

Dear Trevor

Just a short mail to advise you that the Kent Television Group now has a web site at: [ourworld.compuserve.com/homepages/Bjenkins\\_2](http://ourworld.compuserve.com/homepages/Bjenkins_2) with a link to the BATC site and eventually other ATV related venues. I wish it was as easy to get a license for GB3KT!! Thanks for CQTV 176 - an excellent read as always 73 Barrie G4CZJ Secretary, Kent Television Group 100671.2123@compuserve.com

*The BATC web site is now at :-*

*<http://ourworld.compuserve.com/homepages/batc> . By the time you read this it will have links to your site, GB3KT license may take a little longer ED*

Dear Ian

I have found your repeater information quite useful except for one thing, could you please add grid references to them so that their locations can be found on conventional OS maps. I find the locator system rather awkward. Perhaps for security reasons the last co-ordinate figures could be left out. I have access to computer programmes which can plot the terrain between repeaters and possible portable sites, but the use of locators are not recognised by such programs.

*There is a program to do this on our the Web site. Note that is a PC only program. ED*

Dear Trevor

I have been an SWL since 1981 and started with RTTY and SSB. At that time I could not get more than 86 DXCC countries confirmed. In 1985 I heard a new noise (B/W SSTV) using an PAODSH- converter, a stand alone 8-16-32 even M1 parity SSTV , a Robot 400 and a Robot 800. In 1990 I read about the AVT system with colour modes. I found an old Amiga 500, and hooked up the AVT system to it's parallel port and there was colour. The hams all over the USA were sending AVT and Scotty S-1. In 1993 I found a used 386-DX and started with JVFAX 7.0. In 1995 I traded in my 386 for a Pentium-75 and fitted 16 MB of memory. Now in

## Post and News

1996 I still use the AVT master, but on an Amiga 2000 and all sorts of SSTV programs from PASOKON + Board, Multiscan + version 2.11E of MSCAN, PRO-SCAN 3.02, JV FAX 7.1A, FAX480 part of the old PASOKON V1.2, and GSH-PC V1.2. The reason for so many programs is all the modes, I have received 57 countries in SSTV but only had 48 confirmed by QSL KO Versteeg NL9222 Netherlands .

*Thanks for the report SSTV, how about some pictures next time showing the various modes. ED*

Dear Peter,

G4UVZ is offering packs of surface mount components, 10 off each value as follows:-

10nF, 33nF, Diodes, ORO (surface links), 10R, 51R, 100R, 180R, 6k8, 180k, 10 $\mu$ H. (11 x 10 items for £2.00)

He calls it a SMD starter pack. A *prepaid envelope* must be sent with Postal Order to:-

Adrian G4UVZ, Hollybank, Sellicks Green, Taunton, TA3 7ED

Also, he has on offer 3off x 10GHz pucks at £2.50. These are said by him to tune to 10.4GHz for transmitter usage. (MURATA DRO's 10.0GHz)

Judging by the cost of new surface mount components, the pucks are very good value for projects. I've checked the sample DRO puck he sent me and it will go to 10.5GHz or anywhere in band.

Peter Johnson, G4LXC

Dear Editor

I was reading an interesting article by Barry Fox in the New Scientist which prompted me to comment.

The article concerns the problem of sending TV pictures around the house from the living room. As you know, this can create additional wiring or the purchase of an illegal Video Sender, (Glorified Nasty RF Modulator) to which you and I would not contemplate.

Phillips engineers have been looking at this problem for several years in the view to marketing such a device and this is where my ears pricked. There are several non-licence bands in the UK one being 2.4 GHz low power. Phillips tried this band only to find that the Microwave Ovens working on this Band affected the signal. Does this mean we have leaky ovens? and what about our Radio Frequency Allocation. I did read an article about converting a Microwave Oven as a 2.4 GHz TV transmitter

in the BATC Magazine. The other legally approved band which has the capacity to transmit the bandwidth required, is 5.8 GHz. The international agreement on this band limits the power to 25 milliwatt with an expected range of 250 metres across an open path. To produce a transmitter and receiver at this frequency could prove rather expensive to implement. However, Phillips spotted an easy way to keep costs down by modifying existing domestic Satellite equipment. Therefore, producing a system for approx. £100 which could be on the market next year.

My main questions are:

Will we be subject to low power microwave transmissions seeping through from next door? or perhaps from within?

Could we use the band legally for a quality RF video link to an ATV transmitter?

Where have you seen interesting results from modifying LNBs and Satellite equipment?

What components and circuits have been used?

I look forward to seeing this product should it reach the domestic market. It could prove rather interesting !!

73 Paul G8YMM

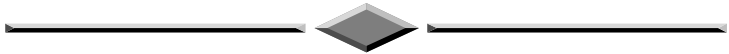

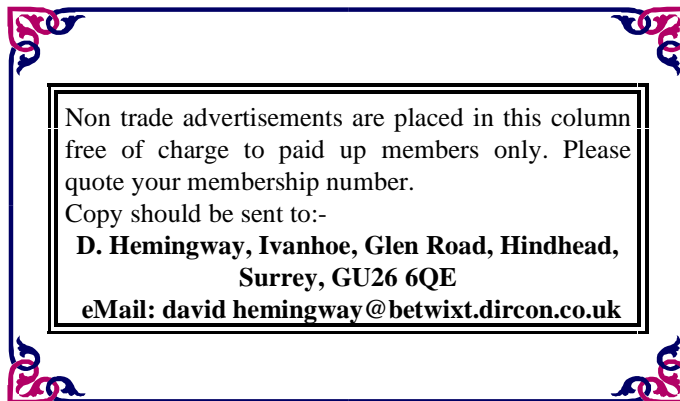

## For Sale

THE HISTORY OF TELEVISION. Rick Marshall. 1986. Large format. Lots of tv pictures / US cameras. British section. £10. (similar format to Rick Marshall's other book, "The Golden Age of TV".)

BBC HANDBOOK 1938. Featuring 'Television Today'. Rare. £ 10. VGC, BBC YEAR BOOK 1948. Jubilee issue. Featuring '25 Years of Broadcast Engineering ' plus ' A Night At Alexandra Palace'. Well illustrated. £1-  
d/w

VGC.TV BOOK "The Ultimate Television Book". Edited by Judy Fireman. 1977. Workman Publishing Co. USA. Workman Publishing Co. USA. Entertaining Compendium of American TV facts and fictions. Well illustrated with a photo history of American TV. £5.

STOP TALKING AND GIVE THE SCORE. Max Robertson. 1987. The Kingswood Press. Illustrated accounts by Max Robertson of his life in outside broadcasting. £3.

THE MEMOIRS OF A BRITISH BROADCASTER . Alasdair Milne. 1988. illustrated pb. £1

SIR HUGE. 'The life of Huw Weldon'. Paul Ferris. 1990. illustrated h/b. £1.

A VARIETY OF LIVES. 'A Biography of Sir Hugh Green'. Michael Tracey. 1983 Illustrated h/b. £5.

All books clean and intact. Postage £1.50 per book. Some are heavy!

**Contact Dicky Howett 01245 441811**

Hitachi camera operations unit type OP-5.

50 Volt Lots of Amps PSU, needs attention, but heavy transformer OK.

Offers **D.J. Long, 697 Halifax Rd., Hartshead Moorside, CLECKHEATON, West Yorks BF19 5QT Tel 01274 877211**

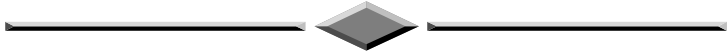

National half-inch Cartridge Editing VTR; Type 5130A £30.

Phillips Video 80 Plumbicon camera, single CCU and Power Supply £100.

Phillips Video 80 Plumbicon cameras x3, triple CCU and Power Supply £200.

Boom Microphone Trolley System, Excellent condition £500.

IVC2002 TBC and spare unit £100

JVC U-matic Edit Suite 8200/6600 £300

JVC GRC3 colour camera and supply £50

Panasonic Mixer/titler and camera £30

Most of above have full service manuals and are fully operational.

All above open to offers **Ronnie Gibb, 20, Douglas Street, Hamilton, ML3 0PB. Tel. 01689 421480 (Evening); 0141 330 4141 (day) eMail r.gibb@udcf.gla.ac.uk**

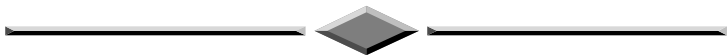

I am upgrading to a printer with more colour so I am selling my HP DJ500c. With this I will be providing a ream of 80g paper, TWO colour ink cartridges( one just opened and the other boxed-sealed untouched), colour kit box, Manuals and Win 3.1 driver d/loaded from CIX. WIN 95 drivers can be download from the same conference HP/desk jet.I am selling all the items together, no splits.Best offer (sale or swap, by mail) secures.

Items I's swap or part-ex for.... RF Power transistors (MRF 646 etc) Clip-on linear to fit FT290r2. Liner-2 2m ssb/cw tx/rx. Yaesu FT790r2 tx/rx part-ex against Icom ic-202 or 210 2m luggable. a portable antenna analyser for 50mhz and above... **Steve Walters 0956-544202**

## For Sale

Sony servicing guide CV-2000B (VTR) CVC-2000B (Camera) CVM-306BP (Monitor) - postage only.

VIDI-PC Frame grabber for IBM PC video capture - mono output in TIFF, GEM or PCX formats - interface card, discs, and book. £30 contact: *D.Hemingway G8EGG, QTHR. Tel 01428 60464*

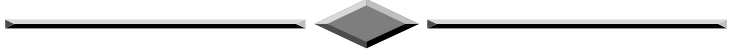

### **Moving House Sale.**

Sony CV2100ACE Video recorder and tapes - £15.00 Ampex VR5103 1"VTR and tapes - £15. 00 or both for £20.00

Box of 10 U-matic tapes 20 and 30 m. size - £15.00

AutoCue computer unit, rackmount with two 3.5" drives - £12.50

Small Sync Pulse Generator, with genlock - £30.00

For@ Title generator TG160 - £25.00

Sound recordist trolley, folds flat for transport, shelves for mixer and VTR - offers.

Systems Video Dif. Phase and Gain test set 1047 for use with vectorscope - offers.

Video projection screen, about 6' diagonal alas no projector - offers.

***Contact Brian Summers G8GQS Who should have moved before publication! Try 01895 810144 or a committee member for possible location or phone number.***

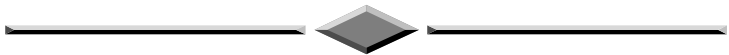

YEASU FT 767GX HF Bands plus 50Mhz, 144 Mhz and 432 Mhz Modules, MH-1B8 Microphone will possibly split modules £1200.

YEASU FT470 Dualband handheld, PA6 DC Adapter, two FBA-10 Battery cases, Softcase. £240.

YEASU FT726R 50 Mhz, 144Mhz, 432Mhz and Satellite Modules, YM-48 DTMF Microphone £725.

YEASU FT530 Dualband handheld, FNB-27, 12V Nicad, SMC-18 Mains Nicad Charger, Two FBA-12 Battery Cases, Softcase. £325.

YEASU Speaker Microphones for FT470/530, MH-12A2B £15., MH-18A2B £10.

YEASU FT 767GX HF Bands plus 144 Mhz Module, SP-767 Speaker with audio filters, MH-1B8 Microphone. £880.

YEASU FT470 Dualband handheld, Two FNB-10 Nicads, two FBA-10 Battery cases, PA6 DC Adapter, MMB-46 Mobile bracket, MH-12A2B Speaker microphone, NC-29 Base charger, Softcase. £260.

AEA AT300 Antenna tuner £110.

All items with original packing, manuals and most with technical manuals. all in very good condition. **Contact Mick Curran, G4ITF Tel 01705 386184**

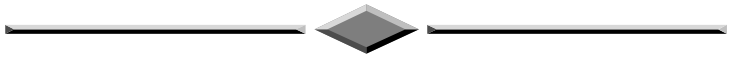

Sony servicing guide CV-2000B (VTR) CVC-2000B (Camera) CVM-306BP (Monitor) - postage only.

VIDI-PC Frame grabber for IBM PC video capture - mono output in TIFF, GEM or PCX formats - interface card, discs, and book. £30 contact: **D. Hemingway, Ivanhoe, Glen Rd., HINDHEAD, GU26 6QE. Tel 01428 60464**

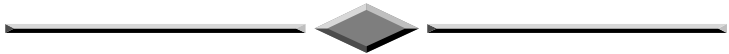

SVHS-C camcorder with accessories, 8:1 zoom, stereo hi-fi sound, long play, in excellent condition; £200. EASY-PC Professional pc board and circuit design software with HC libraries(licence can be transferred); £50. Dana model 4700 DMM (not hand held), working, with manual: £10 Hi-tron 2/3" vidicon CCTV camera, working; £10 Link 130 viewfinder, may be used as a monitor, has chipped tube hence only £8.

Service manuals at £1.50 each:- Bush/Murphy CTV A823 chassis, Panasonic camera WV-3300E/3310E. JVC VCR HR-C3E, Philips camera LDH26. Philips VCR VR2020 CCD colour camera or module with 400 line resolution and 8:1 zoom available to exchange for 2/3 plumbicon or saticon tubes.

***All items plus postage at cost Trevor Lumb Telephone 01284 754318***

Wanted

LARGE LENSES : I mean really, really enormous! Great big long chaps like the Taylor Hobson 12 inch or 17 inch. However would settle for the modest WATSON 8" f/4.5 TURRETT lenses only please (i.e fixed focus). Please search in your cupboards for any optics to offer, even broken items.. **Contact Dicky Howett 01245 441811**

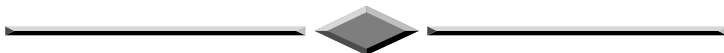

Service manual wanted for Panasonic F15 Colour Video Camera. I would prefer to purchase for a reasonable price, but would also consider borrowing a manual for photocopying, all postal expenses would be reimbursed. **W.H.Hall G3RMX QTHR 01964 542535**

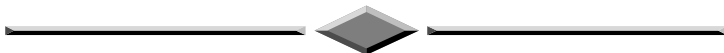

LOAN or sale of service manual for JVC GX-N70E single tube Newvicon colour camera. I would also like to contact anyone else wanting this manual. **Phone Adrian Godwin on 01234 359773, or email agodwin@iee.org**

Ferguson 3V24, JVC HR2200, or similar portable VCR **D. Hemingway. QTHR. 01428 604645**

loan or sale of a service manual for the JVC GX-N70E single tube Newvicon colour camera. I would also like to contact anyone else wanting this manual.

**Phone Adrian Godwin on 01234 359773, or email agodwin@iee.org**

Index of Advertisers

BATC web pages..... 11

GB3XT Kits & Bits - Bob Platts ..... 5

HS Publications - Aerials..... 38

HS Publications - Receiver..... 72

Sevenside Television Group ..... 42

VHF Communications ..... 65

Worthing & Districe Video Repeater Group..... 79