

Contents

Contents ..... 1

Committee Contacts ..... 2

Editorial ..... 4

Name that Old Camera Quiz ..... 6

23cm ATV Transmitter (part 1, the Exciter) ..... 7

Derek the Blindfold Cameraman ..... 11

Subscription Renewals ..... 16

A Common Date/Time Standard for Amateur Radio ..... 17

Book Reviews ..... 19

Beyond TTL # 14 ..... 20

ATV at Reading University ..... 24

The International Space Station would welcome ATV onboard ... 29

Using Damaged Thermistor Power Mounts ..... 31

FM ATV Receiver ..... 32

Solid State Image Iconoscope, part Two ..... 35

MPEG2 Encoder for Home Video Storage ..... 42

International ATV Contest, September 12/13 ..... 44

BATC Publications ..... i

Members' Services ..... iii

Deadline ..... 47

The World's Earliest-Known Recordings of Television ..... 48

More changes to the 10 GHz Band ..... 54

Awards News ..... 55

Circuit Notebook 65 ..... 57

Satellite TV News ..... 60

TV on the Air ..... 70

Off Air Pictures from Adrian Knott, G6KSN ..... 73

In The Workshop ..... 75

In retrospect ..... 77

23cm ATV Transmitter, (part 2, the Amplifier) ..... 78

Name That Old Camera! (answers) ..... 82

Post and News ..... 84

For Sale ..... 87

Wanted ..... 90

Index of Advertisers ..... 92

Edited by Ian Pawson, circuits drawn by Allan Robinson, proof read by Peter Delaney. All rights reserved, all wrongs denied.

© 1998 by the BATC.

Printed by *Cramphorn Colour Printers Ltd.*, 15c Paynes Lane, Rugby, CV21 2UH, England. Telephone: 01788 577781

CQ-TV 184

## Committee Contacts

### **BATC Chairman: Trevor Brown G8CJS**

Club affairs, Video tape library, Technical queries, especially relating to handbook projects. 14 Stairfoot Close, Adel, Leeds, LS16 8JR. Tel: 01132 670115. E-mail: [chairman@batc.org.uk](mailto:chairman@batc.org.uk)

### **BATC General Secretary: Paul Marshall G8MJW**

General club correspondence and business. Library queries relating to the borrowing or donation of written material. Fern House, Church Road, Harby, Notts., NG23 7ED. Tel: 01522 703348.  
Email [secretary@batc.org.uk](mailto:secretary@batc.org.uk)

### **BATC Hon. Treasurer: Brian Summers G8CQS**

Enquiries regarding club finances, Donations, and constitutional enquiries. 9 Prior Croft Close, Camberley, Surrey, GU15 1DE. Tel: 01276 677879, Mobile 0850 014892 Email: [treasurer@batc.org.uk](mailto:treasurer@batc.org.uk)

### **CQ-TV Magazine: Editor Ian Pawson**

Anything for publication in CQ-TV, Articles, Review items, Letters to the editor, and other material except as below. 14 Lilac Avenue, Leicester, LE5 1FN, England. Tel: 0116 276 9425 Email: [editor@batc.org.uk](mailto:editor@batc.org.uk)

**Photographs for the CQ-TV covers:-** Please send any photographs by post, electronic images by email, to the editor at the above addresses.

**TV on the Air:-** Graham Hankins G8EMX, 11 Cottesbrook Road, Acocks Green, Birmingham, B27 6LE. Tel: 0121 707 4337

**Satellite TV News:-** Paul Holland G3TZO, Chatterton, Chapel Lane, Thrapwood, Nr. Malpas, Cheshire, SY14 7AX. Tel: 01948 770429, Email: [satnews@batc.org.uk](mailto:satnews@batc.org.uk)

**CQ-TV Advertising Manager:** Chris Smith (G1FEF) 25 Dando Close, Wollaston, Northants, NN29 7QB. Tel: 01933 666979 Fax: 01933 666972. Email: [adman@batc.org.uk](mailto:adman@batc.org.uk)

**CQ-TV Awards:-** Bob Webb G8VBA, 78 Station Road, Rolleston on Dove, Burton on Trent, Staffs., DE13 9AB. Tel: 01283 814582

## Exhibitions

Mike Wooding G6IQM, 5 Ware Orchard, Barby, Nr. Rugby, CV33 8UF.  
Tel: 01788 890365, Fax: 01788 891883, Mobile: 0860 857434  
Email: [rally98@batc.org.uk](mailto:rally98@batc.org.uk)

## Club Sales

**Members Services:-** PCB's, components, camera tubes, accessories, etc. (NOT PUBLICATIONS). Peter Delaney G8KZG, 6 East View Close, Wargrave, Berkshire, RG10 8BJ. Tel: 0118 940 3121

**Publications:-** Handbooks, Back copies CQTV, and anything related to the supply of BATC publications. Paul Marshall, Fern House, Church Road, Harby, Notts., NG23 7ED, England.

E-mail: [publications@batc.org.uk](mailto:publications@batc.org.uk)

## Membership

Anything to do with membership, including new applications, queries about new and existing membership, non-receipt of CQ-TV, subscriptions, membership records, data protection act. Dave Lawton G0ANO, 'Grenehurst', Pinewood Road, High Wycombe, Bucks., HP12 4DD. Tel: 01494 528899. E-mail: [memsec@batc.org.uk](mailto:memsec@batc.org.uk)

**Club Liaison:-** And anything of a political nature, co-ordination of ATV repeater licences. Graham Shirville G3VZV, The Hill Farm, Potsgrove, Milton Keynes, Bucks., MK17 9HF. Tel: 01525 290343. E-mail [g3vzv@amsat.org](mailto:g3vzv@amsat.org)

**Contests:-** Richard Guttridge G4YTV, Ivy House, Rise Road, Skirlaugh, Hull, HU11 5BH. Tel: 01964 562498

**BATC BBS Sysop:-** Brian Kelly GW6BWX, 12 Cotswold Way, Risca, Gwent, NP1 6QT. Tel: 0410 279606. E-mail: [bbs@batc.org.uk](mailto:bbs@batc.org.uk) *Please note that the BBS is currently 'off the air'.*

**Repeater Liaison:-** General enquiries and repeater affiliation. Graham Hankins G8EMX, 11 Cottesbrook Road, Acocks Green, Birmingham, B27 6LE. Tel: 0121 707 4337.

## BATC web master

Anything to do with the BATCs web site. E-mail: [webmaster@batc.org.uk](mailto:webmaster@batc.org.uk)

First let me apologise for the non-appearance of the Editorial in CQ-TV 182. I did write one, emailed it to the editor and missed his deadline by less than an hour - Ian did a final download for CQ-TV, carried out final adjustments and set off for the printers as I pressed the send button. Ian wrote CQ-TV 183's editorial at my instigation and I am now, by popular request as they say, back in the chair. To make up for my absence, I will break with tradition and write two pages. The logic behind one page is that Ian leaves a gap when preparing CQ-TV and puts the editorial in last so I can make it as topical as the system allows. The lead time from closing CQ-TV to getting it on to your door mat is 4 to 6 weeks. The actual pages are often printed the same week, but the binding, (cutting and stapling to you and me), can take up to two weeks, then there is delivery, Jill Marshall has to put it in envelopes and arrange for the mail van to collect. I hope we can reduce this at a future date. We are aware of the problem and are working on it.

A lot has happened since CQ-TV 183 went to press, not all of it good I am afraid. Let us start with the cuts to 10GHz; the first anyone heard at BATC was via the RSGB news. It affects the ATV repeater channels in use, and I feel that had it affected narrow band operation then it would have received a higher profile approach. It's now water under the bridge and we will have to pick up the pieces and move on, but it still hurts.

This should have been a BGM year, but we have moved the event into 1999 in order to encompass it into something that will celebrate 50 years of BATC. The date and venue of this event is a closely guarded secret, which I am not as yet party to. I hope our Hon. Treasurer will eventually answer his emails and tell me how much we can spend, and then we will either assemble behind the bike sheds or start flying in guest speakers and hiring a lavish venue. The next committee meeting will be soon after you receive this magazine. I hope by then to have a budget, to have selected a venue and appointed an organiser or organising committee. If you have a venue, or speaker or any other ideas please let me have them now the next event on this scale could be in 50 years and at the age of 101, I may not be taking a very active interest in TV. Any thoughts, you all know how to reach me.

Talking of reaching me, the letters flooded in on the A5 A4 debate. When I say letters, I mean only 3 arrived here and all of them in favour of retaining A5. I feel 3 letters is not quite quorum on a club of our size. I think we all acknowledge the problem of circuit diagrams, but one of the letters pointed out that we do not always take advantage of the one A4

page in the centre of CQ-TV. It is usually obscured by a supplement which, although we have reduced it in size, is still an important part of the magazine and will be for the foreseeable future. Whatever future format CQ-TV takes, it will always be our magazine and will be about television from our own unique viewpoint. Before I leave the subject of the magazine, I would like to thank Jan Melis (PAOVHF), for his help in bringing the first translation from the new Dutch Magazine "Repeater" to CQ-TV. This is a new publication and often has some very interesting designs; I hope we can feature other offerings in the future with the kind permission of the Dutch editor Rob Ulrich.

The BATC CD was also launched in CQ-TV 183. This is our first attempt at publishing something on this medium. The disc contains back issues of CQ-TV 173 to 183 the SSTV handbook, the white introductory book, along with an up to date index of past articles. This makes it into a replacement for the Best of CQ-TV and the index that would have been produced on paper. I realise that without a PC this disc is of little use to you but the advantages are immense, starting with a cost saving (most of which has been passed onto you). Colour printing is free to use as much as you want and where you want whilst software is no problem. How about an electronic Index that lets you search all the articles on the disc for a single word? If you do not have a modem, this is your chance to see what you are missing on the BATC web site, as all our web pages are there. If we were able to bring you the software and the snap shot of the web on paper, along with the past magazines and handbooks how much would it cost? A conservative estimate would be over £20. The £5 disc includes a small profit and this will be used to help finance our 50th celebration, so please support this project.

Last September we put on a BATC stand at IBC Amsterdam. We have again been asked to repeat it this year. This is a very professional venue to fly ATV and a lot of thought and effort has gone into what we show. Paul Marshall has been the brains and effort behind this event, and I hope we will be able to include at least one picture in this magazine.

It must be realised that this is the second largest exhibition of broadcast hardware in the world, and the largest in Europe. Trying to attract the attention of people with multi million pound problems and shopping lists is not easy. Having said that, our exhibition was unique last year with the Iconoscope camera - believed to be the only working Iconoscope camera in the world. I am going to close on a sad event the passing of Barry Keedy G6LIC, who was a close friend for many years and without his help and enthusiasm GB3ET would have never made it on air. It was sad to attend his funeral in the shadow of Emley Moor, following a route we had often travelled together to carry out work on that repeater.

**Trevor Brown BATC Chairman**

Name that Old Camera Quiz

By Dicky Howett

Dicky provides an illustrated memory jog through the backwaters of old TV technology. See how many cameras you can spot.

The answers to this intriguing quiz can be found on page 82

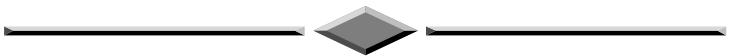
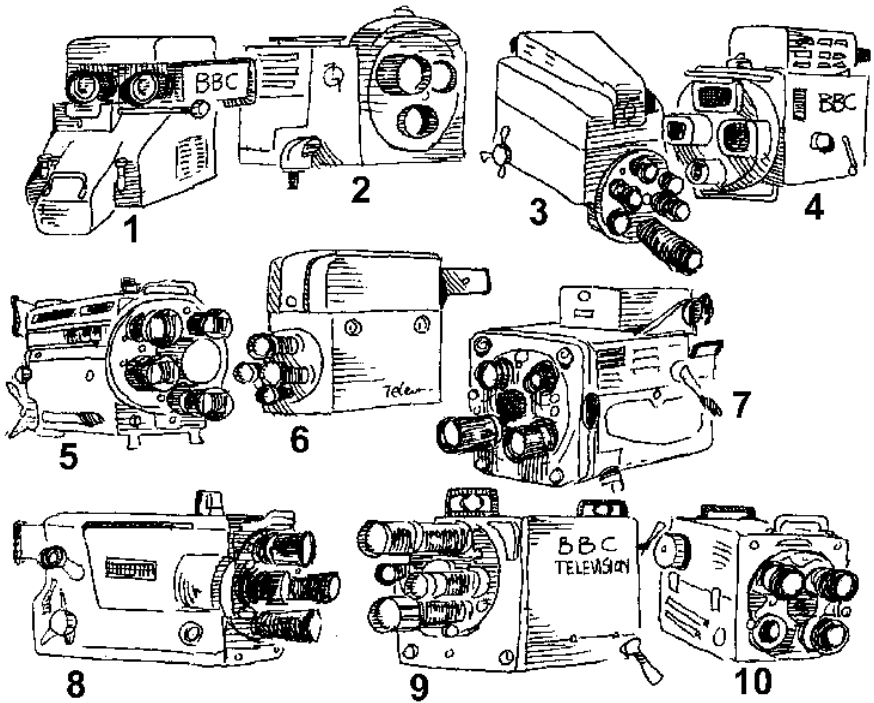

## 23cm ATV Transmitter (part 1, the Exciter)

**By Grant Taylor, ZL1WTT**

Features:

- 1) All components are easy to find.
- 2) Video stages are all DC coupled.
- 3) The modulator is able to provide positive or negative modulation.
- 4) Simple to get on frequency with the aid on the inbuilt pre-scaler chip.
- 5) Frequency agile oscillator- i.e. 1200MHz to 1300MHz.
- 6) No need for UHF / SHF chips - all done with standard 4000 series CMOS

### 23cm exciter circuit description

The incoming video signal goes via a PAL pre-emphasis network that is DC coupled to pin 1 of IC1 (NE592 modulator). Pin 1 is biased to approximately half supply rail voltage, mainly by means of the 2 1.5k resistors connected to it. The sound IF typically of 5.5MHz carrier or with a second carrier of 5.74MHz is AC coupled in after the pre-emphasis network to pin 1 of IC1. The second input, pin 14 is also biased at about 1/2 supply rail. VR1 alters the amount of signal gain / deviation of the FM signal by changing the amount of internal feedback inside the NE592.

VR2 allows a small amount of H.F. boost, and can be left out if not needed. Pins 7 and 8 of the NE592 are the positive and negative going outputs, one of which is connected to the top end of VR3, the bias trimpot.

VR3 sets the bias via an air wound choke to varicap 1 to give the best modulation linearity. The wiper is typically at 5.5 volts plus or minus a volt. Adjustment of this also alters the overall FM deviation, so re-adjustment of VR1 may be required.

The oscillator consisting of TR1 (BFR91) in a common base arrangement, a microstrip, 2 varicaps and several other components, is based on an early BATC design which has been modified for this particular application.

The base is coupled to ground via a SMD capacitor, with positive feedback being provided by the 68ohm emitter resistor and inductance formed from the resistor's pigtail lead. The frequency is set by the combination of the 2 varicaps, the length of the microstrip and to a lesser degree, other reactive elements of the oscillator.

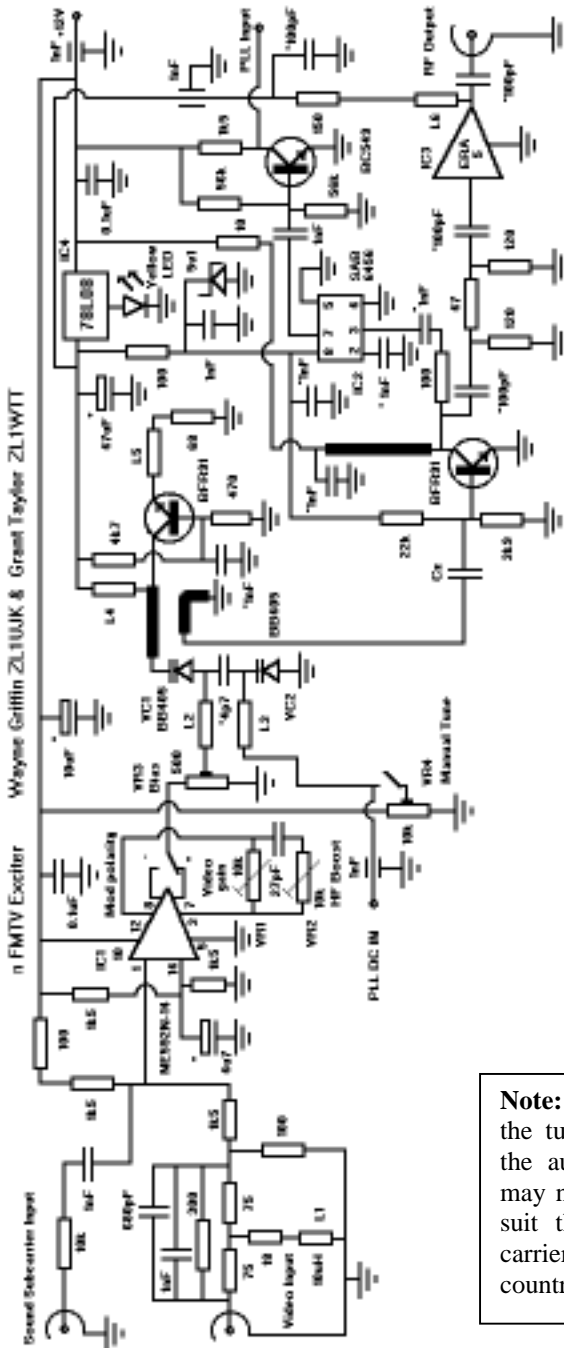

- L2 & L3 = 6 Turns 3mm ID 0.25mm enamel wire
  - L4 = 6 Turns 3mm ID 0.25mm enamel wire
  - L5 = 1 Turn 3mm ID of 6E Ohm resistor lead
  - L6 = 3 Turns 3mm ID 0.25mm enamel wire
  - Cx = 1 Turn wire 0.5mm plastic covered wire
  - A = SMD Capacitor
- DRAWN BY MICHAEL SHEFFIELD ZL1UD3

**Note:** The values of the tuned circuits at the audio frequency may need altering to suit the audio sub-carrier used in other countries – ED.



### *23cm ATV Transmitter (part 1, the Exciter)*

2 varicaps are used so that the deviation is reasonably constant throughout the VCO tuning range. This is done by keeping the average bias voltage constant on varicap 1, and varicap 2 has the DC tuning voltage applied via an air wound choke to adjust the FM carrier's centre frequency. The oscillator can be used without the PLL circuit by adding VR4 to varicap 2 to give the desired tuning volts. Connection between the 2 varicaps is made by a 4.7pf SMD capacitor. If the V.C.O. is working as intended, there should be around 0.5 of a volt for 1200 MHz output, and around 11 volts for 1300 MHz. Moving the connection point of varicap 1's anode up or down the end of the microstrip by a few millimetres will alter the frequency range if the full range cannot be had.

The second microstrip samples a small amount of the oscillator signal and, via Cx, couples it into the base of TR2 (BFR91). Cx is about one "twist" of insulated hook-up wire about 5mm in length giving around 1/2 pf worth of capacitance. If Cx is too great and results in over-coupling, then TR2 can sometimes break into spurious oscillation at around 1.8 GHz. Some typical symptoms are that any attached PLL will not lock and the DC tuning voltage does not have any effect on the output frequency. TR2 is a common-emitter amplifier stage that feeds the IC2 pre-scaler and IC3 pre-driver stage.



## 23cm ATV Transmitter (part 1, the Exciter)

IC2 (SAB6456) is a divide-by-256 pre-scaler that has its output AC coupled into the base of TR3 (BC549). The base and collector resistor values have been chosen to give the greatest output swing, with the collector resistor having the most effect on gain. The output should read between 4.8MHz and 5.08MHz which is suitable for coupling into a hi-z PLL input.



An 8dB pi-pad that helps to give some degree of isolation is connected between TR2 and the input of the IC3 (ERA-5) pre-driver amplifier. A decoupled 9.8volt supply is fed to the output pin via a resistor and 3-turn air-wound choke to supply power to the ERA-5. The output signal is coupled via an SMD capacitor to the next stage.

IC4 (78L08) provides a nominal 9.8 volts increased from its normal 8 volts by means of an LED in series with it's ground pin. A 5volt supply to the pre-scaler IC and for TR2 base biasing is provided by a standard resistor-zener combination and smoothed by a 1nf SMD capacitor.

Other additions that can be used:-

Frequency read out display,

Video processor,

Dual Sound Carrier,

15 watt power amplifier.

Teletext boards for test cards,

FM ATV Receiver,

23 Line Amp and 23cm GaAsFET preamps.

## Derek the Blindfold Cameraman

### By Dicky Howett

It is said around the studios - admittedly in moments of stress - that some TV crews are staffed exclusively by *blind* cameramen and *deaf* sound engineers. Derek Chason would fall into neither category. However, at one point in his career Derek became the nationally famous 'blindfold cameraman'. This disability occurred weekly with Derek in a studio, standing next to Bob Monkhouse and 'Bernie The Bolt'. You guessed it, Derek Chason was the poor unfortunate who actually shot 'The Golden Shot' crossbow. Each week he had to 'line up' his adapted



**Derek Chason outside Studio B,  
Fountain TV at Wembley**

EMI 2001 colour camera under instructions from a studio contestant, pointing his camera whilst blindfold at the famous William Tell type target.

These days, down at Wembley, Derek Chason has burnt his bolts and is now the Client Services Manager for facilities company, Fountain Television.

"I started in TV in April 1958," Derek confesses. "I came from Air Force National Service as a clerk and signed on at ATV Television House in Kingsway as a trainee tracker. My first ATV studio was the Wood Green Empire."

By the time Derek Chason joined Associated TeleVision, ATV had been transmitting for three years. Although ATV's franchise was to serve the

Midlands weekdays and London at weekends, all their studio and technical areas were based firmly in London. The capital was the heart of 'showbusiness' and ATV, managed by the redoubtable Lew Grade, was demonstrably the epitome of 'show' and 'business'. ATV was the acknowledged glamour channel, featuring highly popular fare such as 'Emergency Ward Ten', 'Sunday Night At The London Palladium' and



### **The Golden Shot from ATV.**

'The Adventures of Robin Hood'. ATV was metropolitan and proud of it!

Back in the 1950's and 1960's, ATV had studios at the Hackney Empire, Wood Green Empire, Highbury and Foley Street. Also permanently wired for television was the London Palladium, owned by ATV. Derek Chason, "The camera crews rotated round the ATV studio centres, six weeks at each site with one 'floating crew' filling in. The Wood Green Empire and The Hackney Empire were converted theatres, each having the stalls covered with flooring to the level of the stage so that the entire area could be used for tracking cameras. The circle was used for the audience. At Hackney, the control rooms were actually under the stage at the side."

Derek remembers the shows at Wood Green "'Jewel and Warris', 'Carol Levis Junior Discoveries', 'The Saturday Spectacular'. And then at the Hackney Empire we did 'Oh Boy', 'Dotto', 'The 64 Thousand Question', 'Tell The Truth'. Up at Highbury at the old High Definition Norman Collins studios we did 'Emergency Ward Ten', plus some children's series and lots of drama. At Foley Street, ATV had its Master Control. There was one tiny studio. We did 'The Jack Jackson Show' from there."

Derek Chason was a tracker for five years. “You worked your way up in those days. Learnt the trade. However, I used to moonlight as a cameraman at the Granville Studios (a studio rental outfit part-owned initially by Mole-Richardson and Pye) on Fulham Green where we made commercials. At one point we used a camera system called ‘Gemini’ which had an Auricon 16mm film camera strapped upside-down to a Marconi Mk IV image orthicon tv camera. We also used Pye Mk III and IV cameras. A lot of BBC and ITV camera crews used to work on their rest days at the Granville. Our ‘day job’ wages were quite poor you see.”

Wood Green also was the base for ATV’s Outside Broadcast units. Derek Chason, “O.Bs were a mystery to us studio crews. O.Bs were a closed shop, jealously protected. They considered themselves the cream of tv. O.B. crews hated doing any studio work. They lost out on a lot of expenses that way. They had to protect their little empires. If you ever got out onto O.Bs they kept you out of the way up on a tower with a caption or behind the rhododendron bushes at Sandown Park. You were never given the interesting things to do.”

Throughout the monochrome era, the major supplier of cameras and equipment for ATV was the Cambridge company, Pye. The camera most favoured by ATV was the 3inch image orthicon Pye Mk III. Derek Chason recalls, “The pictures were quite nice but the turret swing took an age to turn. It seemed to take forever to move from one lens to another. The turrets were motorised. You twisted a knob at the back of the camera and the turret crept round in a clunky manner. I don’t know how we ever did drama with those cameras. When I moved to Elstree in 1963 as a cameraman, we had Pye Mk V’s, with a much quicker motorised turret. We did ‘Probation Officer’ at Elstree.”

By the late 1950’s ATV had outgrown its converted theatres. They were never ideal as television studios, plus the acoustics were not suitable for modern productions. Also, those old theatres were usually situated in built-up areas with sometimes awkward access. In 1959, ATV acquired the former Douglas Fairbanks Jnr National Studios at Elstree, which had been used previously for making TV filmed series. The 31-acre studio site, 14 miles from London, offered room for expansion. To quote from the prim ATV publicity of the time;

‘The plans for the creation of the Elstree Studio Centre were made after careful study of the newest television centres in America and Europe. In the result, the Studio Centre incorporates many novel features and advanced technical equipment developed or built by ATV’s own staff. Fully transistorised equipment has for the first time been used for the distribution of video and synchronising signals’.

The Elstree Studio Centre was certainly in the vanguard of 1960's television. Each studio (A, B, C, D, the largest two being 116 x 80ft) was equipped with five Pye Mk V 4 1/2 inch image orthicon camera channels, 34 sound channels and 240 lighting control circuits each of which could be separately dimmed and controlled by pre-set press-buttons. Each studio floor was level to within 1/40 inch. The Studio Centre was opened in 1961 and thereafter ATV closed its five other centres, moving the O.B. base to Elstree. Only Master Control at Foley Street was retained along with Alpha Studios (jointly run with ABC TV), in Birmingham.

Derek Chason, "During the 1960's I worked on all the big light entertainment shows at Elstree. ATV was also gearing up for colour. We did a 'Tom Jones' show with some colour cameras hired from Intertel. We placed them side by side with the monochrome cameras. We were shooting in colour for the American market. The colour cameras always had precedence in the studio, and more light! ATV used to do a lot of shows for America. Liberace for example. We often spent merry afternoons changing everything from 405 to 525 lines and back again!"

When all-channel colour arrived (1969) in Britain, at Elstree ATV installed Philips PC60 3-tube Plumbicon cameras in studios A and B and EMI 2001 4-tube cameras in studio's C and D. Derek Chason, "Cameramen didn't like operating the Philips camera. They didn't like the zoom lens sticking out the front. These days every camera has one, but back then great chunks of glass and metal on the front of cameras were a pain. The centre of gravity went and panning was more problematic. On the other hand, everybody just *loved* the EMI 2001 which had its zoom lens built into the body of the camera. The point of focus was near the centre of the camera, not stuck out a foot in front."

By 1978 Derek Chason was a senior cameraman. He had been with ATV for twenty years and reckoned that he would be unable to further his career. He applied for, and became, Head of Cameras at TVI, a facilities house which had a studio in Whitfield Street, London. "I went straight into O.Bs. We had this big scanner van based on a horse box. We had some Philips LDK 5 cameras and Ikegami HL77 and HL79 portables. LWT used us every week for football."

TVI was bought by Trilion and Derek Chason moved to Limehouse as Studio Manager. He was there only a year when LWT approached him with a proposition. "LWT in the 1980's had assessed correctly the 'de-regulating' of TV and the subsequent emergence of independent producers", says Derek. "They were considering setting up a facilities department to include the hire of their studios and equipment. They called it originally the 'LWT Production Facilities' but changed the name to the familiar 'London Studios'. It was felt that the Independents would feel

more comfortable coming to a broadcaster if it wasn't specifically identified as such. I was the first Client/Liaison manager at LWT. I stayed until 1995 when I moved to my current position at Fountain Television."



**Elstree, 'Probation Officer' and a Pye Mk 5.**

Derek Chason is still within the orbit of 'ITV'. To labour a few metaphors, he has made many tracks since 1958 but has finally braked, this time on site at the famous Associated-Rediffusion 'Studio 5' at Wembley. The current owners of the studio complex, Fountain Television have completely refurbished the place and brought the unique 'double' studio up to date. Derek Chason will help steer the whole rig safely into the next Millennium

Subscription Renewals.

By Dave Lawton, Membership Secretary

Since the Club was founded the subscription has run from 1st January till 31st December. During the latter part of 1996 we introduced a change that meant that for new members subscriptions run for twelve months from the date of joining. This was to simplify the membership administration.

However for the majority of members their subscription will fall due on the 1st of January and hence this subscription reminder. The software that prints the CQ-TV labels has been modified such that if your subscription will fall due before the next magazine



your address label will indicate that fact and state "subs due". This will also apply to our newer members who joined during the year.

In all cases when a label is printed with "Subs due", we will enclose a subscription renewal form with the magazine.

The subscription for 1999 remains the same as last year at £12.00 and as usual, we offer discounts for renewing for more than one year as detailed below.

1999 only <b>£12.00</b>	1999 + 2000 - <b>£22.00</b>
1999 + 2000 + 2001 - <b>£32.00</b>	99 + 2000 + 2001 + 2002 - <b>£40.00</b>

Overseas Members, outside Europe, will receive their magazine by Surface mail. If anyone wishes his or her magazine sent by Airmail the additional cost is £6.00 per year.

This figure reflects the additional cost to the Club to send magazines by air. Please note that there is no additional airmail charge to Members within the EEC and Europe.



## A Common Date/Time Standard for Amateur Radio

### By Ian Galpin, G1SMD

The following information was received too late to be included in CQ-TV 181:

The Acorn RiscPC doesn't use the ISO date format by default. An add-on 'template' file is available from the G3RUH Web Page to convert the machine to use the Year-Month-Day date format. The ZIP file with the template and full instructions is available at: <http://www.jrmiller.demon.co.uk/rpc/>. The file can be used with a range of Acorn machines; especially those using RiscOS 3 onwards.

The G3RUH RiscPC file is also available from the GB7PFT 'CLIVE' server and by 'reqfil' from some other AX.25 Packet BBS stations. The version on Packet Radio is called 'RISC-ISO.ZIP'.

A copy of the Acorn RiscPC file compiled by G3RUH is also held at: <ftp://ftp.funet.fi/pub/ham/misc/risc-iso.zip>.

The instructions for setting up various computers can be found at: <http://www.aegis1.demon.co.uk/y2k/iso-pc.htm> and via: <http://ourworld.compuserve.com/homepages/dstrange/y2k.htm>. The latter site also includes links to some free Year 2000 Test Programs.

The Year 2000 Problem (as affecting IBM-compatible PC Hardware) is fully explained at: <http://www.newscientist.com/ns/971108/letters.html>.

### Latest

The IBM-compatible PC-setup information is in CQ-TV 181 (1997-Nov, Page 76) and in the file that can be found at: <ftp://ftp.funet.fi/pub/ham/misc/g1smd.zip>. Recent back issues of CQ-TV can be ordered from BATC Publications. They can also be downloaded from the BATC Web Page at: <http://www.batc.org.uk/>. The Internet version requires the use of the Adobe Acrobat viewer, version 3 or later. The proposal was introduced in CQ-TV 180 (1998-Feb, Page 9 to 11).

The file 'G1SMD.ZIP' is available on AX.25 Packet Radio from the same places that hold the RiscPC information.

There is a short general discussion of the ISO 8601 Date Format on a Web Page located at: [http://shell.ihug.co.nz/~hermetic/cal\\_stud/formats.htm](http://shell.ihug.co.nz/~hermetic/cal_stud/formats.htm). This site also points to several others with further (more detailed) information on this topic. See also: <http://www.aegis1.demon.co.uk/y2k/y2k.htm> for other links.

The Amateur Radio Proposal document is located at:  
[http://www.kirsta.demon.co.uk/iso\\_8601.htm](http://www.kirsta.demon.co.uk/iso_8601.htm) and can be found via the  
Web Page at:  
<http://ourworld.compuserve.com/homepages/dstrange/y2k.htm>.

More supporters have recently joined the growing list: G8IQU, G0CUZ, G7LFC, 9M2CR, OH5IY, DL5BCU, G3TZO, G3OAF, G0BAF, VK3UM, G3NKS and G3PHO.

The 'Four Metres News' newsletter has now adopted the proposal. The BATC has recently starting using the new format in parts of the CQ-TV magazine, and on their Web Pages. A document about 'Date and Time' can now also be found on the BATC Web Pages at: <http://www.batc.org.uk/> with more background information, and links to many other related information resources, including most of the above.

The RSGB Microwave Newsletter will be adopting the new format within the next few months, at the start of the next volume. A number of computer programs used variously in logging, contests, meteor-scatter, and EME have also recently changed to the new format. Many programs involved with satellite tracking have already used the ISO format for many years; astronomers having been one of the main users of this format in the past.

Information has even filtered down into mainstream computer magazines. The ISO 8601 standard is mentioned in 'Computer Shopper', 1998-Jun, Issue 124, on Page 616. It was also covered in the US magazine 'Byte', in the 1997-Jul issue, on Page 89. 'Byte' is currently in the process of converting their Web Site at: <http://www.byte.com/> from the old American date format to now use the ISO format instead.

The Amateur Radio proposal is also covered in RIG 53 (Issue 53 of the newsletter of the Remote Imaging Group, 1998-Jun); as well as in 'Datacom' magazine (BARTG, UK, in the 1997-Winter and 1998-Summer issues). It will also be mentioned in QST (ARRL, USA) in the 1998-Aug issue, in the 'Digital Dimension' column. This is a follow-on to the piece originally printed in QST in the 1997-Aug issue, on Page 69 and 70. The proposal also gets a mention in a number of other amateur radio magazines around the world over the coming months.

For those people with a modem but without access to Internet, the BATC BBS should have the files 'G1SMD.ZIP', 'RISC-ISO.ZIP' and 'BATC-ISO.ZIP' installed soon. These files duplicate most of the information referred to as already being on Internet or Packet Radio. This (hopefully) will have happened by the time this issue of CQ-TV appears in print.

See page 3 of CQ-TV for the status of the BATC BBS. See also CQ-TV, Issue 182, 1998-May, Page 47 and 48.

## Book Reviews

### Electronic Classics: Collecting, Restoration & Repair.

Written by Andrew Emmerson and published by Newnes at £19.99. ISBN 0-7506-3788-9, paperback, 413 pages, illustrated.

Another entertaining and instructional volume from Andrew Emmerson, the man who brought you the Sound & Vision Year Book, Old Telephones and a recently published novelty item, Old Television.

Electronic Classics is the fulfilment of the above books, written as always, in Andrew's accessible and faintly ironic style. The book is presented in easily digestible chunks and covers a great deal of essential ground. Whole sections - illustrated with photographs, line drawings and period advertisements - are devoted to the restoration of television sets, radios, telephones, boat anchors, (you name it), with tips and advice gleaned from experts. Other sections deal with Dealers (and their secrets!), Fakes (and how to spot them), Buying and Selling plus an exhaustive (and exhausting) chapter on how to package an electronic treasure for safe postal delivery (and everything you ever wanted to know about bubble wrap!). Included also in the book are lists of Fairs, Markets, Auctions, Clubs, Museums, Magazines plus much else of particular interest to the aspiring or established collector. Electronic Classics is a comprehensive and essential addition to the book collection of the discerning enthusiast. (Review by Dicky Howett)

### Old Television

I was certainly glued to the pages from the word go, indicating that interest in this subject never really dies away - it just lies dormant, waiting to be stimulated. I think this book performs the tricky task of appealing to readers both 'in the know' as well as the more casual person, who may be approaching more from the nostalgia angle. It must be the first book to offer practical advice on enjoying old television in the home as opposed to merely peering curiously at dusty museum objects. Nice use of photos too. I hope feedback from the publication is positive and that sales go some way to repaying all the work that went into it. (Review by Steve James)

Old Television by Andrew Emmerson (price £2.95). Publisher: Shire Publications, Cromwell House, Church Street, Princes Risborough, HP17 9AJ.

Available from bookshops and museums or by mail order from On The Air, 42 Bridge Street Row, Chester, CH1 1NN (add 50p for postage).

By Trevor Brown

First of all sorry, for the non-appearance of this column in the last few issues; I did not mean to generate interest in PIC's and then leave you all hanging. The interest generated was considerable; I got phone calls, emails and was even cornered at our rally by one member who not only asked questions about TASM v MPASM, but who also produced a running PIC from his pocket, driving an led display.

When we last visited the subject I reproduced a very simple 16C84 programmer, by Derren Crome (CQ-TV 177). It used a .OBJ file that could only be produced by the TASM assembler, running TASM source code; the resultant file was then linked to a send programme, that ultimately programmed the PIC. In CQ-TV 178 we reproduced a programmer by David Tait that used MPASM software to generate a hex file for programming the PIC. The ideal solution would be a programmer that could work with either code or some way of converting files between the two languages.

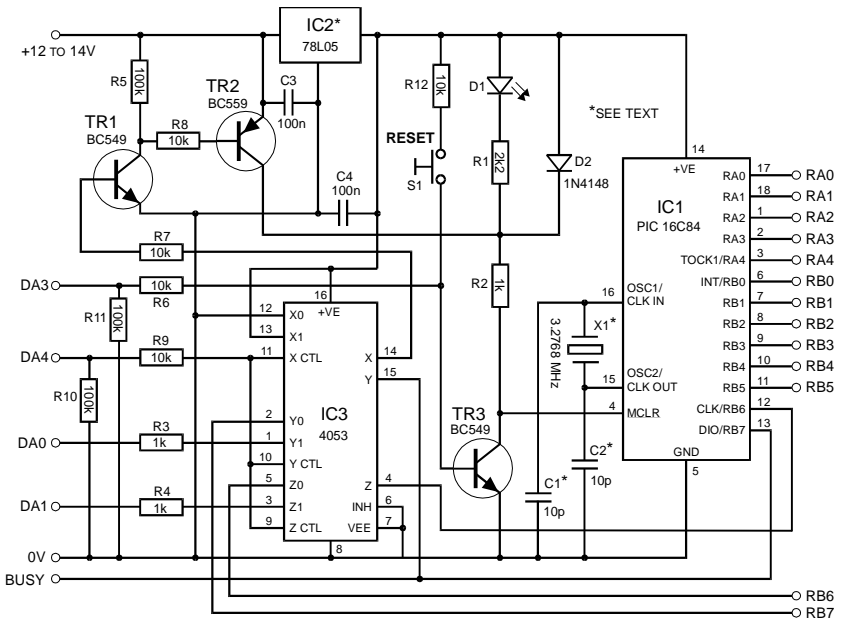

Circuit diagram of the PIC programmer

Like all problems, the solution is out there, because you are not alone - somewhere someone is working on the problem. John Becker, Technical Editor of Everyday Practical Electronics, is just such a person and he published his solution in the July issue of EPE magazine. For those of you that missed it, or if the assistant took it away before you had time to digest it fully, John's solution is a programme in Q basic (remember Q basic - it's part of DOS).

The programme is called Toolkit and available on the EPE web site, <ftp://ftp.epemag.wimborne.co.uk/pub/pics/picoolkit> . I have also put it on our web (<http://www.batc.org.uk/software/beyond14.zip>) and it's part of the club CD for those of you not on the web.

**Requirements:**

IBM-compatible 386 PC or higher, QuickBASIC or QBasic installed, PC parallel port, 12-14V D.C. power source.

Versatility and high speed were the two main objectives for the EPE PIC Toolkit. It can be used in conjunction with both TASM and MPASM source codes, and is THREE tools in one. It can be used as a stand-alone unit or interfaced with the EPE PIC Tutor PCB (EPE Magazine, March - May 1998). Features a fast, DOS based screen display with the options shown below.

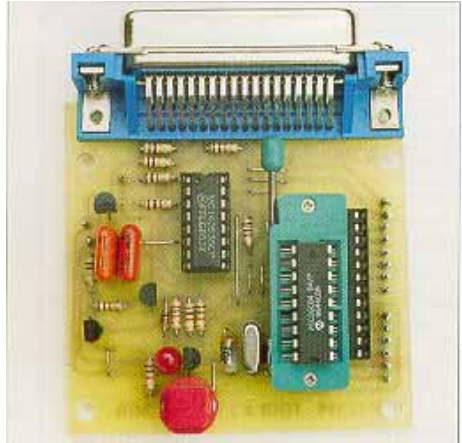

**The completed programmer**

The programme presents you with a multi-option menu.

- 1 Configure PIC16C84 factors
- 2 Programme PIC16C84 with TASM binary code
- 3 Programme PIC 16C84 with MPASM hex code
- 4 Translate MPASM hex code to TASM
- 5 Translate TASM binary code to Mpsasm hex code
- 6 Disassemble PIC16C84 to TASM source code
- 7 Disassemble PIC16C84 to MPASM
- 8 Translate TASM source code to MPASM
- 9 Translate MPASM source code to TASM
- P Show directory paths
- Q Quit from BASIC

Options 1, 2, 3, 6, 7 are specific to John's programmer hardware that also appeared in the July issue of EPE magazine. The other options have universal applications for converting source code between the two programming languages, or generating the binary file required by the Derren Chrome send programme for programming via his hardware reproduced in CQ-TV 177, when using MPASM.

John has also produced his own hardware for PIC programming the most sophisticated yet and it's backed up by a PCB. John's hardware can also support a download to the programmer from the PIC, and the software can then disassemble the file into either TASM or MAPSM using options 6 or 7, providing that the PIC has not had its Code Protection enabled.

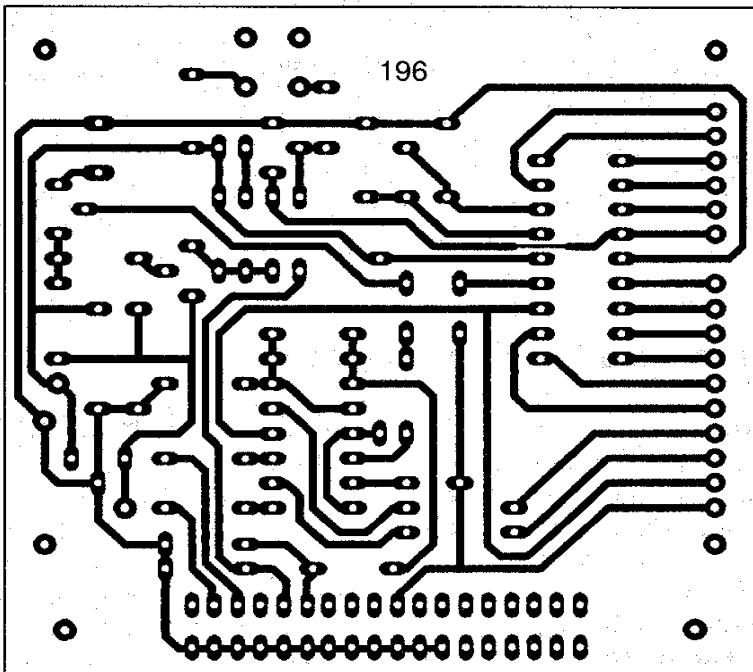

The PCB design. (Not actual size)

I have reproduced John's hardware here, but I suggest you purchase a back copy of July EPE if you are going to use John's hardware. There are lots of helpful hints and tips in the article particularly when converting MAPSM into TASM which is the slightly more complex of the two operations.

# GB3XT KITS & BITS

## NEW DOVE TUNEABLE IF / RX KIT.

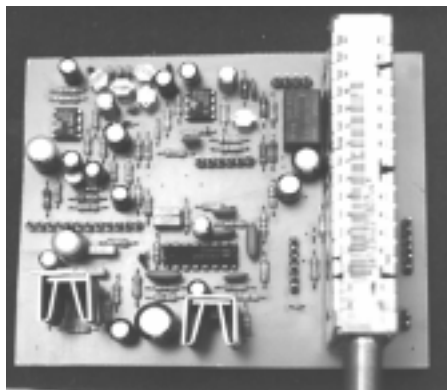

The Dove ATV Tuneable IF./ RX. forms the ideal heart of an ATV receiving system for either 24CMs (pre-amp recommended) or the higher bands when used in conjunction with a suitable Low Noise Block converter.

The flexible design concept allows for expansion to suit your needs for now and the future.

Easy to construct requiring no adjustment, setting up or alignment. The kit contains all board mounted components and full instructions.

Brief spec. Size.105mm wide x 97mm deep x 50mm high. Power. 12vDC @ 400mA. Frequency range. 925MHz - 1800MHz. Audio subcarrier. 6MHz. Video bandwidth. Variable.

Video outputs. 1v PK/PK + Base band. Audio output. 1.5Watts. Controls. (all 10K pots) Main tuning, Volume, Video gain, Video bandwidth. LNB power on/off switch.

**DOVE RECEIVER KIT £42.00 all-inclusive.**

**GUNNMOD2 3CMs ATV. TX. kit.** Very popular full feature Gunn diode TX. Complete with pre-tuned oscillator head. £30.00. PCB. kit less oscillator head £20.00

**3CMs LNB's.** All with 9GHz Local oscillators. New 0.7db nf. with dish feed horn. £43.00. With 22mm circular W/G input £45.00. Others and second hand units available. Please contact.

**WG16 to 22mm Circular transition.** Converts 22mm circular to WG16 and vice versa.

**24CMs LOW NOISE HIGH GAIN GASFET PRE-AMP kit.** 40db gain 1db NF. band pass helical filtering. 12-18vDC feed via co-ax. Designed specifically for ATV. but good for all modes £60.00

**DTMF DECODER kit.** Very high quality decoder IC. All o/p's buffered. Will directly drive TTL/CMOS or relays. Can be used to control whatever your imagination thinks of. £12.00

Prices are all inclusive of P&P etc. (+ 10% abroad) PCB's are available assembled and tested at extra charge. **SAE. (to take A4 paper) for further details or call.**

Orders and enquiries to:- BOB PLATTS G8OZP. 220 ROLLESTON ROAD. BURTON UPON TRENT. STAFFS. DE13 0AY. PHONE 01283 531443 7 - 9PM WEEKDAYS PLEASE.

**By Tony Hornby, G1HBD**

It all started at a radio club meeting one Thursday evening. Tom G0VQR was going to set up an HF radio station at the University of Reading, on the 26/27th of March. This was for the two days in national science week. I suggested it might be nice if an ATV station was also represented. This was readily accepted.

As with most things in my life, my mouth tends to commit me to things before I've considered the full ramifications of what's involved. Those of you that know me may know the size of my shack. For those of you that don't, I can assure you it's really small. All the cables are tucked away, so to remove them takes time, let alone putting the shack back together. I didn't mind as it was all in a good cause. I started by making a list of the things that would be needed. This turned out to be more extensive than first envisaged. I could imagine me getting there and finding that I had left some vital piece of equipment at home as is usually the case.



**An off screen shot (showing the author is on the right)**



After stripping the shack and laying it all out on the garage floor. It was now time to tick each item off against the checklist. This way I wouldn't leave anything to chance, or so I thought! Best laid plans. Now was the time to load up. The equipment filled my car which has a reasonably large carrying capacity. I kept saying to myself, how did I managed to cram so much, equipment in such a small shack, let alone the car.



**An off screen shot at GB3HV**

On the day prior to the science fair the weather was fine. All the better for climbing around roofs connecting antennas, so with the car packed and a detailed map of how to get to the University, I was now on my way. The drive took me about 15 mins from home to the university. I was then directed to the building where the station was to be set-up. It was about 2 o'clock, the time Tom suggested I should arrive as the students will have left, this being the last day of term.

How wrong can you be. When I arrived there were a number of students still in the science lab finishing off their course-work, which had to be handed in by 3 o'clock that afternoon. It wasn't until 2.55 that the last student left, cutting it a little fine I said to myself. It was never like that in

my day, we were always away as soon as possible on the last day of term. Tom and Robert helped me unload the equipment and take it up to the second floor science lab. I had been allocated a long bench against the window overlooking a large grassed area, and the rest of the science and physics buildings. Great I should be able to pass the cables through the window - anything for an easy life.



**Another off screen shot by G8MNY**

My main concern now was would I have a clear view of the repeater GB3HV, and would there be anything to attach my poles and antennas too. So armed with an orienteering compass, I made my way to the roof. The actual roof was covered with a soft grey rubberised material, something I hadn't seen before. Great surface for sunbathing, not that I do a lot of that you realise.

On first inspection it didn't look as if I was going to find a place to attach the antennas, except for a couple of roof access ladders, which turned out to be ideal. Not only were they substantial enough, but they were located so that I could point the antennas between two taller buildings on the campus, giving me an unobstructed view of GB3HV. My luck was still holding out, but unfortunately the antennas had to be located behind each other only 4mtrs apart. I decided that the TX antenna should go in front of the RX.

Hopefully there wouldn't be any conflict on look-through. Again luck was still with me and I had excellent look-through. For those of you who might be unfamiliar with the term look-through, it's when you see your own transmitted picture from the Repeater.

The antennas were fed with Beldon 9913, which I felt was a little better than Wesflex 103 and H 100, and a lot more flexible than Andrews Heliax. I can hear some of you saying, "where can I get some of that?" Unfortunately Beldon 9913 isn't readily available in this country. I was able to purchase mine from a friend in the USA. The station consisted of 2-35 element antennas from Masthead, a Solent transmitter and a 20 watt brick PA. For receive I was using a converted Zeta 1000L analogue satellite receiver, and a 20 dB pre amp. I left the equipment set-up ready for the next day. They closed the Science buildings at 5.30pm. I was assured that nobody could enter the building as it would be locked and there are regular security patrols. On the day of the science fair I was up really early at 6:30am - let me tell you that's early for me. I still had a niggling feeling that a vital piece of equipment was missing - anyway you are not a real radio amateur if you don't leave things behind. I left home at 7:45am for the 15 min drive. I kept telling myself what ever was missing, it would just have to stay missing. I was one of the first to arrive. It was about 8:30am before the other exhibitors started to trickle into the building.

The station was as I had left it the night before. By the time the first visitors arrived I had put a number of test transmissions into GB3HV and was getting a P5 report back. This was a great site for ATV.

We were told that last year they had in excess of 4000 people on the first day and they were expecting the same this year. What I wasn't prepared for were so many small hands grabbing, twiddling and fiddling. Once over the initial shock of that, I managed to move some of the more delicate equipment out of the way of the more inquisitive little fingers. It wasn't long before pictures from Mike G8LES, John G8MNY and Roy G8CKN were being seen by large groups of children and their parents. All this was being seen through GB3HV. I was using my own call sign G1HBD/P also the club call GX6HC. This enabled the visitors to talk freely on camera.

Most of the visitors comments were, “is this something new?” as they didn't realise that this part of amateur radio existed. I also did some local transmission with my walk about camera going round the other exhibits in the building. I couldn't go that far as the picture was breaking due to the amount of metal in the place so my receiver was suffering from multi-path reflections. Well that's what I told myself anyway.

You never know, some of the visitors might go on to consider ATV as a hobby or even a career in television. One of the university lecturers, who had been interviewed on camera earlier in the day, commented that the demonstration of ATV was one of the more interesting exhibits they've had, and would I be prepared to do it all again next year. As usual my mouth takes over my brain, guess what I said, that's right. You guessed it. “Of course”, I said without hesitation.

Well, what do you think! Did I leave anything behind? Of course I did. Remember, I said that there were lots of prying hands, well one of those hands pulled a power plug from a camera that needed re-soldering. Guess what, I forgot to take the soldering iron. “Not a problem”, said a 2nd year student who was assisting at the event. “Had I forgotten where we were”, then promptly went and got a soldering iron from the storeroom. In no time the camera was back in action.

It was a most successful day and everybody enjoyed it. On a personal note, I found it to be a most rewarding experience. Having a good view of GB3HV helped. I would like to thank Tom G0VQR and Robert M1BGT for inviting me, also for helping to shift all that equipment. I would also like to thank Mike, John and Roy, and anybody else who gave up their time to transmit and receive pictures, and talk to the people who visited the exhibit. An extra thank you to John G8MNY for supplying the photographs.

By the way it took two days for me to get my shack back into some sort of order! If you fancy attending next year's science fair at Reading University and want to help set-up the station, you would be most welcome. You can contact me on 01189 787833. Hope to see you there or, if not, on the box. Tony Hornby G1HBD QTHR.

The off screen photos were taken by G8MNY from a recording made at GB3HV.

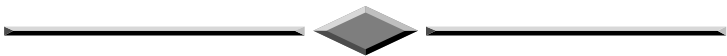

## The International Space Station would welcome ATV onboard

**By Graham Shirville, G3VZV**

Every year the AMSAT- UK organisation arrange a Colloquium for everyone interested in Amateur Radio Satellites, at the University of Surrey in Guildford around the end of July.

This year was no exception, but before the main Colloquium event took place there was a two day meeting of the group responsible for deciding what amateur equipment might be installed in the new International Space Station.

The ISS is expected to be built over the next four/five years from component parts that will be delivered by both Russian launchers and the American Space Shuttle. The construction will require many launches and should commence with the Control Module being launched on Nov 20th this year.

The meeting included representatives from the USA, UK, Italy, Japan, Canada and Germany and, by telephone, also Russia and comprised NASA representatives and potential satellite builders.

The meeting confirmed that the mission of ARISS "Amateur Radio on the International Space Station" should be:



*"Shall have the capability to provide space – to – ground Amateur Radio communication for the I.S.S. crew and educational purposes.*

*Shall have capability also for unattended operation for control, experimental and other purposes within the Amateur Radio Service*

*The equipment must be sufficiently adaptable to accommodate the diverse range of modes and frequencies envisaged in present and future educational and other experiments."*

Long discussions, during the formal meeting and in the bar afterwards, resulted in the following outline plan being developed for the installation of amateur equipment which would be phased over a number of years as the hardware and launch opportunities become available.

The first station may be expected to be a single band 2 metre FM rig with packet facilities and the ability for the licensed astronauts to talk to ground based amateurs. This could be launched on the STS-88 Shuttle flight which is scheduled for December this year.

## *The International Space Station would welcome ATV onboard*

The next phase would be the introduction of a 70cms radio, dual band antenna and digitalker. This could be launched on STS96 in May 1999.

Following on from that would be a transportable station that would comprise a crossband 2/70cms FM rig which would act as a repeater in space and also allow licensed astronauts to “break in” to a qso!

This could be carried aloft on Shuttle flights STS-98 or 99 in late 1999.

And, finally, the permanent amateur station has to be developed. This is specifically intended to satisfy the requirements of the last part of the mission statement highlighted above.

A conventional analogue 23cms up and 13cms down, FM ATV relay is unlikely

to be possible due to the large bandwidth requirements and the link power budget that would be needed without the use of highly directional antennae.

The way forward is therefore expected to be a system using digital signals of some kind. The development of a high data rate relay system for the ISS is not yet beyond the vapourware stage but if Amateur Television operators are able to share their expertise and assist in the development of one, then the time for doing so is right now!

So the purpose of this article is to bring to your attention this possible opportunity and to find out if there are any readers around the world who are enthusiastic enough to become involved in this fairly long-term project. If so I will be happy to put them in touch with the existing teams involved.



## Using Damaged Thermistor Power Mounts

By George Allen, N1BEP

Power mounts for the Hewlett Packard 432 power meter are often damaged by over driving, so that the meter will not zero. These mounts, like the 478A, can usually be obtained at low cost and can sometimes be salvaged to usefulness if not open circuited.

In the diagram, the thermistors are connected from (A) to ground (G) and (B) to ground. Check resistance of the two thermistors with a LOW VOLTAGE ohmmeter (to avoid over powering with d. c.). For balance, the two resistances should be nearly equal, from a few hundred ohms to about one thousand ohms. If they are not, the mount will not balance. Assume that thermistor (B) has the higher resistance, then using a resistor (A') in series with the lower value thermistor leg (A) will allow balancing. Start with a value of resistance that will make the two legs nearly equal in resistance, check for initial balance, and then allow the mount to stabilise in temperature. Some readjusting of the resistor value may be necessary. It has been found that over time (2 years) the thermistors will change a little in resistance. Two mounts have been repaired this way. One required an initial resistance of 25 ohms, which subsequently was reduced to 15 ohms. A second mount required about 1200 ohms, which quickly reduced to about 700 ohms.

It has been found that these repaired mounts are accurate from range to range. The absolute accuracy is not known, but with small resistance corrections, power readings seem to

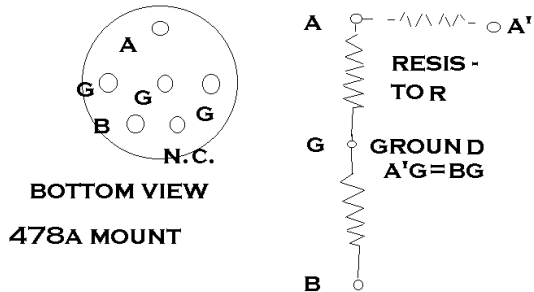

be very close to calibration. Resistors should be precision units, so that temperature changes will not affect calibration. A connector on the cable end was modified so that the resistor (1/4 to 1/8 Watt) would fit directly on the connector terminals.

Long term stability will shift with ageing. Temperature stability of the mounts is not as good as normal but balance can normally be obtained by using the coarse balance adjustment. With Tender Loving Care, the mounts will give long service.

## FM ATV Receiver

### By Grant Taylor, ZL1WTT

This receiver is based around the use of a TVRO tuner head. These are used in many types of analogue satellite receivers. The TVRO tuner has an IF input tuning range of about 800MHz to 1800MHz. The IF input can also be used to give a DC supply to feed a LNB or antenna pre-amp and the output provides a baseband signal. As you can see, the tuning range of 800-1800MHz will easily cover the 23cm band. To pickup FM ATV signals you may need to use one, or possibly two, low noise preamps at the front end with a reasonably high gain aerial.

### Receiver circuit description

The TVRO takes the incoming RF and mixes it down to an IF of 480MHz, with a bandwidth of about 25MHz. This is then coupled into the demodulator half of the TVRO module, which provides the baseband.

Pin 1 is the DC supply for the F-socket (IF in). Pins 2 and 7 are the AGC in and pin 12 is AGC out. The 12volt supply is on pins 3, 6, and 10 and also pin 11 via 82ohm resistor. For tuning, VR1 is a 10-turn pot. The range is 0 to 20 volts on pin 4. Pins 5 and 13 are AFC and 14 is AFC defeat.

The incoming baseband signal is feed into pin 14 of the NE592. VR2 sets up the video gain and VR3 adjusts the HF boost response. Either of the amplifier output pins 7 and 8 can be selected by the positive/negative modulation switch, depending on the polarity of modulation you wish to receive. The output of the NE592 is then split two ways. One feeds the video output transistors, via the video de-emphasis network. The second feed is passed via ceramic filters to the sound demodulators contained in IC2.

The video output stages consist of transistors TR1, TR2 and TR3 and associated components. The emitter of TR1 (BC548) has a tuned circuit, that acts as a sound IF trap. The output from the transistor is then coupled into a CCIR standard video de-emphasis network that is matched for 75ohm impedance in and out. The 75ohm and 300ohm resistors used can be a pair of 150ohm resistors wired in parallel or series as required, or if obtainable, single resistors of the required value may be used. A standard feedback pair is used on the video output stage TR2, TR3 (BC337, BC327). The video is fed into the base of TR2 that then drives TR3. The signal comes off the collector of TR3 providing the video output.



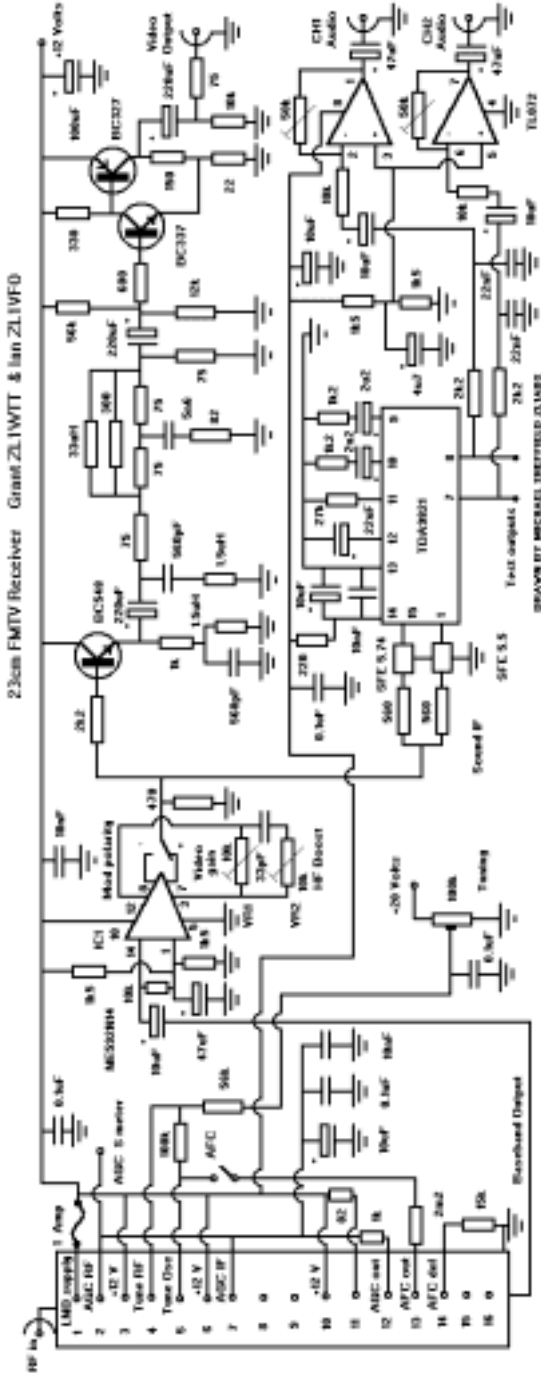

IC2 is the TDA9821 dual PLL sound demodulator. This takes the outgoing signal from the NE592 through the 5.5 and 5.742MHz ceramic filters, which then feeds the two inputs of IC2, pins 1 and 15. The audio gain has been set by the use of the two 1.2k resistors and with the two 2.2µF caps. The audio output pins 7 and 8 are connected to the sound de-emphasis networks. IC3 is a TL072 op-amp used as a dual channel line amp. The pins 2 and 6 are the two inputs. The audio gain is set by VR4 and VR5. The output pins 1 and 7 are coupled to the outputs which then provide the two audio output channels. Optional extras not shown include a buffered baseband output from the TVRO module for use with data or other wideband experiments, and a stabilised voltage booster / regulator section for the tuning voltage, which would be required for portable work, or elsewhere where slowly discharging batteries are used.

Boards based on this article will be available from Wayne Griffin ZL1UJK.

*Note: The values of the tuned circuits at the audio frequency may need altering to suit the audio sub-carrier used in other countries – ED.*

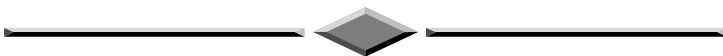

## **Free Internet Dial-Up Accounts for BATC members**

Caladan Communications, a UK based Internet Services Provider are pleased to be able to offer BATC members free dial-up access to internet e-mail and news services.

Contact Chris Smith (G1FEF) for more details:

E-mail: [sales@caladan.co.uk](mailto:sales@caladan.co.uk) Fax: 01933 777577

Web site: <http://www.caladan.co.uk/batc>

Or write to:

‘Free BATC offer’  
Caladan Communications  
25 Dando Close,  
Wollaston,  
Northants, NN29 7QB

## Solid State Image Iconoscope, part Two.

**By Paul Marshall**

Iconoscopes, Iconoscopes everywhere – and not a vacuum in sight!

Well, almost. Since the first part of this article a number of other tubes have come to light. They are all different, supporting the theory that the design of these tubes was always changing. Unfortunately, the majority no longer contain a vacuum – the glass/glass or glass/metal seals have failed somewhere along their life to admit air. This of course is a one way ticket, they cannot be re-activated because the oxygen in the air oxidises the photocathode, the mosaic and possibly the electron gun cathode.

The original tube in the camera plods on despite its arduous duty at IBC '97. As this is written, it faces another stint at IBC '98. Time will tell whether it survives the ferry and the exhibition. A good spare is available, but it has not been fully evaluated because the original one would have to be disturbed in its housing to do this and I'd rather not at this stage.

In this part we will look at the video amplifier, the scanning techniques and how this project might develop further into a more durable vehicle for demonstrating this forgotten technology.

### **The video processing amplifier**

This unit was designed by Bob Robson and developed by the author to handle the Iconoscope video signals. The video pre-amplifier driving this amplifier is a standard broadcast camera unit intended for plumbicons. Apart from tweaking the video response and removing the Percival Coil from the input FET stage, no modifications were necessary other than running it at maximum gain! The Photicon should deliver about 50mV into a 2M $\Omega$  load. In practice, possibly due to tube deterioration, it is about half that.

The tube does not need gamma correction – it has a natural inverse gamma law close to that required for a display CRT, i.e., about 1/2.2. This is a textbook figure – I've never had a clean enough signal to measure it. The video processing stage does need comprehensive shading correction, a wide range black level clamp, variable gain and a sync adder. Books of the period refer to DC restoring the video *after* clamping because the blanking period video is nothing like black, being very scene dependant thanks to all the secondary emission taking place on the mosaic surface. The DC restorer should be so arranged to only operate during the active scan time.

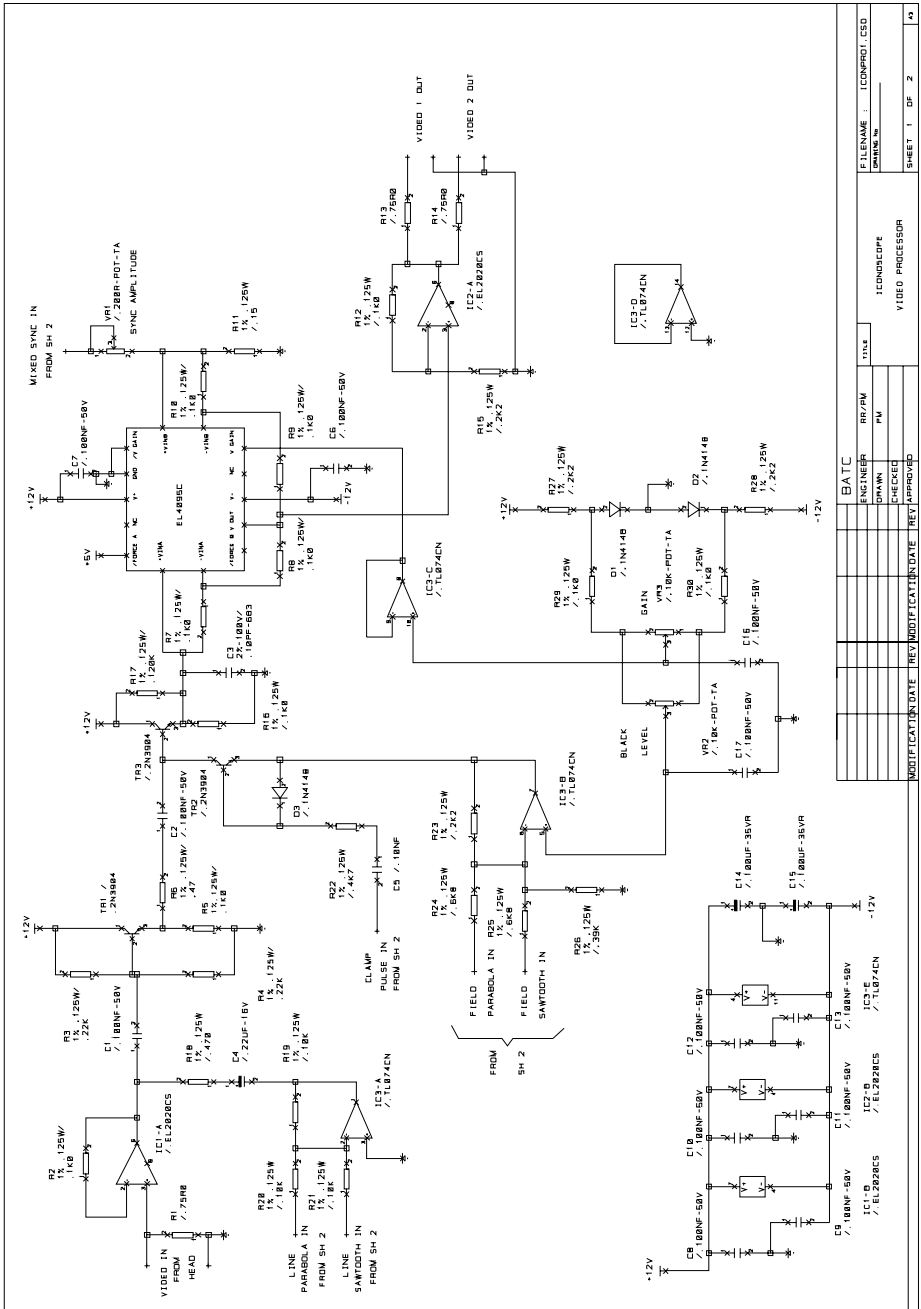

FILE NAME	ICONPRD1.CSD
DRAWN BY	
ENGINEER	BATC
PP/PM	
TITLE	ICONSCOPE
PM	
CHECKED	
REVISION	VIDEO PROCESSOR
DATE	
APPROVED	
SHEET 1	OF 2

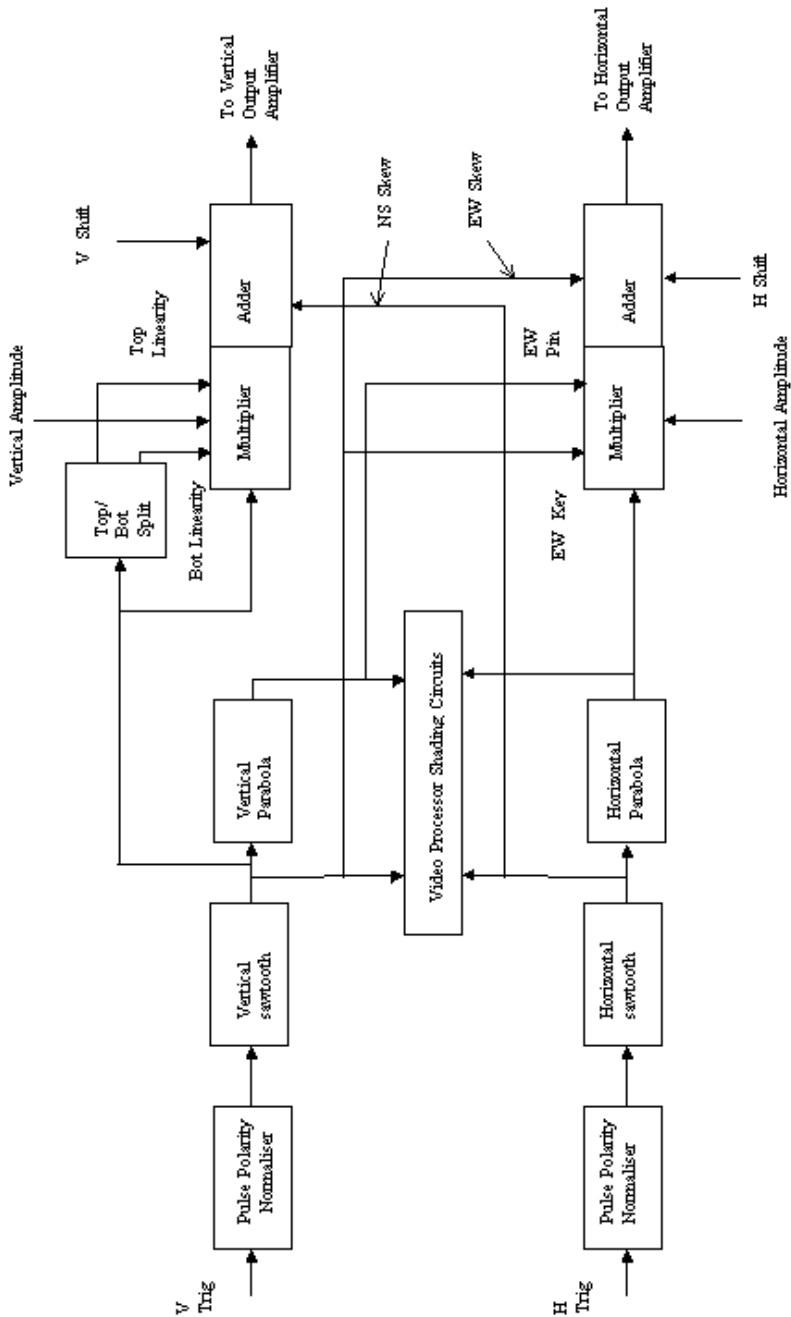

Figure 2 Image iconoscope camera deflection driver block diagram.

Adding a DC restorer along these lines did not seem to improve matters much and was abandoned.

The resulting circuit is shown in figure 1. It can be seen that the video has both polarities of line rate sawtooth and parabola shading added (or, tilt' and 'bend' in the vernacular of the period). The signal is then passed through a measure of differentiation formed by C1 and R3/4 that seems to help break up some of the worst inherent field shading. The addition of this stage is maybe why the downstream DC restorer failed to improve matters.

A simple black level clamp sets a black level up but with field rate tilt and bend added to the reference to remove the vertical shading. As the shading varies with scene content quite dramatically, these line and field rate tilt and bend controls need to be varied skilfully with change in camera scene. This was one of the Iconoscopes failings – perhaps one of the lesser ones compared with its sensitivity!

Finally, a two-channel wideband multiplier IC is used to provide blanking, sync addition, and video gain control.

A great deal of effort went into later versions of the Image Iconoscope to improve the shading defects. Dicky Howett in CQ-TV 178 briefly described some of these techniques.

### **The scanning circuits**

This sub-system was adapted from circuits designed by the author for auto sync flight simulation displays. Consequently full details cannot be published in CQ-TV. Whilst the techniques employed were over-kill of the problems generated by having an offset electron gun producing a large amount of trapezoidal distortion and vertical non-linearity, it did mean more time could be devoted to the difficult areas of resurrecting Image Iconoscope technology.

However, it is possible to re-produce a block diagram of some of the techniques employed. It is worth noting that the original circuits as well as being auto lock up to 64KHz line rate, are also serial data controlled. This held out the possibility of a digitally controlled (from a PC) Image Iconoscope camera. In practice, time was the enemy and this particular oddity never materialised.

The heart of the timebase is the two auto-lock sawtooth generators that in turn drive line and field rate parabola generators. Use of low-noise multipliers then enable large range geometric corrections to be carried out. The original circuits were intended for geometry correction, whereas in this application they are used for the main scan generation. The sawtooths, parabolas and their inverses are also used by the shading circuits. A

pair of linear amplifiers deliver the necessary deflection power to the camera tube. The tube electron gun having only a 1kV accelerating potential and a relatively narrow deflection angle (about 40°), results in very small deflection amplitudes. The problem was actually turning the vertical amplifier down to a low enough level!

## **Developing the design**

Given the modern electronics, this experimental camera is probably exploiting the remaining life left in the tube as well as can be expected. It certainly shows up all the well-documented defects along with a few new ones such as the helium 'blob' described in CQTV 181. It is probably the case that the pictures being seen are not as good as when the tube was new. In addition, it is not being scanned at 405 or 441 (old US standard) as it would have been originally. The reduced bandwidth of these systems would have helped in the apparent resolution and quality. Having said that, Iconoscopes of all types were used on 525 and 625.

The current camera does not have the resolution expected – this was claimed to be one of its benefits. The problem does not seem to be due to the high target to case capacitance as might be expected, but more to do with spot size. The spot size should be excellent, the beam current is only about 10 $\mu$ A and is electromagnetically focussed. This maybe one of the problems with the Photicon/Pesticon types of Image Iconoscope. The original devices by RCA used electrostatic focussing of the beam, as did the EMI variant of these devices (they had patent licensing by virtue of the Marconi rights over RCA patents – a strong reason for the formation of Marconi-EMI, but that's another story). The problem with the electromagnetic focussing of the beam is the inter-action of the image focus electromagnetic field with it, and also the vice versa from the electromagnetic deflection. Pye used a large amount of mu-metal screening to minimise this. Adding mu-metal screening certainly helps, but I would love to try an electrostatic tube for comparison.

If a University Physics department or industry could be interested in the project, it should be quite possible to make some new tubes. This would really give the full story as to how good/bad such devices were. Quite a lot of process data actually survives but tantalisingly no overall performance specifications. If new tubes could be made, it would mean that future generations would be able to see the quality of picture that gave birth to modern electronic television. A lot has been learned from this project, imaginations fired in the young, and memories in the old(er). If anyone has more data or hardware relating to Iconoscopes, I would appreciate communication.

## *Solid State Image Iconoscope, part Two.*

The three photographs accompanying this article show a 1950's test slide and the televising of it, first by un-shading corrected Photicon, and then with correction applied. Unfortunately the ambient light level incident on the monitor screen was rather high when the photographs were taken, and as a consequence the contrast ratio has suffered somewhat.



**Light box slide used for the Iconoscope test**

*As mentioned above, the contrast of the off screen pictures was rather poor. So much so, that they are unsuitable for printing. – ED*

## **The show goes on**

Following the success at last years convention, Paul and helpers took the Iconoscope camera to demonstrate at the International Broadcasting Convention (IBC '98) in Amsterdam from 11-15 September, Europe's largest broadcasting event. The following page has a couple of pictures showing the BATC stand.





**Paul Marshall and Grant Dixon on the BATC stand**



**An engineers work is never done!**

## Philips Semiconductors

The problem of analogue videotape being an unreliable medium for storage of home videos is solved by the new SAA6750H IC enabling storage in digital form on CD or DVD using a home PC.

Until now, expensive professional equipment was needed to transform analogue video into a digital signal and then compress it to fit onto a disk. Philips Semiconductors has shrunk all the complex hardware needed to perform the transformation onto a single silicon chip: the SAA6750H.

Analogue tape is the most common medium for video recording today but is very fragile and irreplaceable shots can be lost forever. Furthermore, duplicating an analogue home video conventionally from tape-to-tape can lead to annoying signal distortions. A digital storage medium, such as a Hard Disk (HD), Recordable CD (CD-R), ReWritable CD (CD-RW) or Digital Versatile Disc (DVD), is a much more robust way of storing and duplicating video.

MPEG2 has become the new main standard for high-quality digital video and provides video quality that is better than S-VHS (Super-VHS) and low-cost MPEG2 decoders can already be found in a large number of products, including set top boxes, PC cards and new generations of Video-CD or DVD players.

Now with the SAA6750H and just a few more components, a manufacturer can create an add-in MPEG2 encoder card for a home PC for a few hundred dollars - far below the cost of similar MPEG2 systems that have been produced so far. The card changes the analogue signal to digital and compresses it to fit on to the hard disk of a PC without taking up the whole disk. It then can be saved on the hard disk, sent as an email attachment, or transferred onto a recordable CD, and it is also very easy to make extra copies of the CD.

The SAA6750H takes either PAL or NTSC format video signals and generates an MPEG2 Elementary Stream (ES) which is fully compliant with the MPEG2 standard (ISO 13818-2) and is compatible to a 16-bit parallel interface with Motorola (68xxx like) or Intel (xxx86 like) protocol style.

It uses motion-estimation algorithms that were specially developed in the Philips Research Laboratories to achieve both a high quality and a high-compression factor at very low cost. By using only I and P frames (B frames are not used), a significant reduction in overall system build cost is

achieved, e.g. only 2 MB of DRAM is needed compared with at least 4 MB for IPB coding, and editability of the compressed streams is improved. High picture quality (much better than S-VHS) can be reached at around 4-8 Mbit/sec.

Another refinement is a sophisticated algorithm that reduces noise in the input video before it is compressed. This is particularly important for home recordings, which are usually noisy, as compression algorithms by nature tend to increase the disturbing effects of noise. The SAA6750H is the first device to use a patented, motion compensated temporal noise filtering technique, which Philips developed for professional equipment to get rid of any noise and deliver a picture quality that can be even better than the original.

The software algorithms all run on a specially developed on-chip, high-performance processor accompanied by over 20 kB of on-chip microcode in ROM. This approach of using programmable microcode software provides considerable flexibility to customise and adapt the functionality of the chip.

Other applications include using the chip to encode broadcast-quality video for storage on disk or encoded transmission.

For this application, the SAA6750H has been optimised to work with two other Philips ICs: the SAA7111 family of ICs that convert analogue TV signals into a digital format and the SAA7146 PCI bridge master IC that transfers the data from the card into the PC.

**Editors note:**

This device would appear to have possible applications in Amateur television, such as to compress a video signal to permit colour transmission on 70cm. If any members have tried this device, then please share your experiences through CQ-TV.

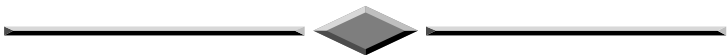

## **By Graham G8EMX**

After a two-year break, the Severnside ATV Group decided to resurrect its portable station G7ATV/P and enter the International ATV Contest over the weekend September 12/13. The Group newsletter 'P5' gave excellent directions to the site on the Mendip Hills and as camping was mentioned I took my caravan down there to see what sort of operation this Group could manage to muster.

It would be very difficult to convince the uninformed onlooker that the final set-up mounted by the Severnside ATV Group was a voluntary effort, using substantially home-brew antennas and hardware, 'manned' by ...I will use the word 'enthusiastic', but 'dedicated' would be nearer the mark...ATV hobbyists. To any passer-by, the operation had all the appearance of a major professional broadcaster or communications giant carrying out tests for a new transmission site!

The Group was to operate on all ATV bands up to 10GHz, so an 'antenna farm' of 2M, 70cm, 24cm, 13cm beams and a 3cm dish became held aloft with a 'Versatower' mobile mast. Two caravans and a petrol generator provided ground support for the transmitters, receivers, and reasonable 'creature comforts' for Viv and Ivor Green (G1IXE and G1IXF), Ross Wilkinson G0WJR, Ian Bennett G6TVJ and his son. Me and my caravan arrived a bit before Saturday mid-day; the tower was not yet elevated but antennas were being fitted and mast-head transmitters and pre-amps clamped into place. However, preparations had been under way for most of the week, as equipment was tested at various homes and caravans towed onto the field site by willing parents!

Shortly after a brief but well-earned lunch break, the Versatower was winched upright and the kit in the caravan powered up for final testing. If anything was wrong now, it was a relatively easy matter to lower the mast for checking. But everything was fine, so the hard part – extending the tower sections – began. The Group decided to wind up to about two-thirds of possible height, with three hefty guy wires giving added stability in the gusty wind.

G7ATV/P would be using quad 21 element beams for 70cm, fed with maximum legal power giving 35kW erp (with some sideband filtering); quad 48 element loop yagis for 24cm, fed by a 75W PA giving 8kW erp; 25 ele yagis on 13cm, fed with 800mW giving up to 60W erp; and a single 60cm dish for 3cm, fed with 1W giving circa 2kW erp. Much of all this was homebrew too, and the only failure they suffered during the contest

was the commercial linear PA used on the 2M talkback channel! Talkback continued, but at only (!) 20W – into another massive beam, of course.

The International ATV Contest began at 1900 hours GMT. After only a few minutes a local station called in, and the Severnside ATV Group Contest station G7ATV/P was in business. Viv was on the 2M-talkback mike, and keeping the four contest log sheets (one per band) while Ivor, Ian and Ross looked after the multitude of switching involved.

And lots of switching there is, too. A contest vision transmission consists of a numerical group of four non-consecutive digits which the receiving station has to resolve, then add together and reply with the sum (there is a tendency here to see 10 as ‘ten’ instead of ‘1’). A different set of four digits is necessary for each band used. If the sum is correct, a valid exchange is logged. Scoring also involves signal strength (picture quality P1 to P5) and distance.

So operators at G7ATV/P had to:- establish initial contact on 2M, note callsign and location, time of establishing contact, establish first band (or only band) for a vision exchange and then note all this in the contest log sheet for the band; select correct four digits for the band to be used; rotate antennas and select appropriate TX and RX; select transmit or receive function according to whatever had meanwhile been agreed as a first direction via the 2M link; then attempt an exchange in vision; send or accept a exchange report; make a note of that report and contest serial number on the log sheet. Then do everything the other way round!

It soon became apparent that this had to be a team effort. So the four log sheets (one per band) were shared out, with Viv maintaining the 2M-talkback microphone and one log. After a few more stations had been ‘worked’, this team became the proverbial ‘well-oiled machine’ (particularly later in the night hi).

### **So, some general observations:**

It proved invaluable to have an ‘elevation’ adjustment when working 10GHz. Some stations that were unresolvable, even when the rotated direction was spot-on, became P5 after just a couple of degrees of elevation or depression adjustment.

There was certainly no ‘hurry’ over each contact. Even when more than one station had been contacted via 2M and was known to be waiting, the team was prepared to take time and effort to achieve contacts, both for their own scoring and for the other station to gather points.

The contest log sheets caused a measure of confusion, with some columns that could, perhaps, benefit from rewording in their heading.

We had some discussion on the contest exchange four-digit number system. This gave no recognition or credit for an accurate colour transmission, or for any camera work. Most stations (including G7ATV/P) used electronics for generating the numbers; the few stations that did have a camera available only used it to 'shoot' numbers written on card. Severnside did bring a camera, but used it to take pictures of the event to put through local repeater GB3ZZ on the Sunday afternoon. We did feel that some measure of camera performance should become a scoring factor.

On Sunday, as the time approached the end of the contest, I counted that G7ATV/P had achieved eleven contacts on 10GHz, five on 2.3GHz, eighteen on 1.3GHz and eight on 70cm. Despite the contest being an 'International', G7ATV/P neither heard nor worked any station outside the UK. The final logged totals may be higher, because I went to the local pub as 'scout' to occupy the table Viv had reserved for Sunday lunches

The Severnside ATV Group used to be regular ATV contesters, but will they mount such an operation again? Well, maybe; they would like to, and many views on contests and ATV were expressed to me during the weekend, which I will not publish here, but will raise to BATC committee members. The Group is waiting to see a set of results for this contest; then, regardless of G7ATV/P's position, they will consider participation in 1999.

My thanks to Viv, Ivor, Ian and Ross for what really was a good Saturday night!

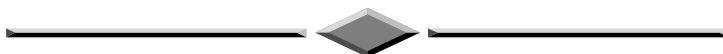

### **Always find out too late...**

Sony's new high-end Handycam video camera includes an infra-red feature which allows shooting in the dark, but enterprising videographers have figured out that using the feature in daylight with a special filter enables the camera to see through light clothing. "When we developed this feature... we were thinking of people filming night views - their children sleeping, or perhaps the nocturnal behaviour of animals," a spokesman said. Sony has modified the camera so that the infrared mode only works in the dark, but more than 870,000 of the cameras with the "see through" features have already been sold. [Reuters]

This-Is-True comments: this makes them the first consumer video product whose value actually went up after purchase.

**BATC Publications**

<b>Publication</b>	<b>Each</b>	<b>Qty</b>	<b>Total</b>
<b>An Introduction To Amateur Television (225gm).....</b>	<b>£5.00</b>	.....	.....
The latest handbook full of detailed information on how to set up your ATV station, plus lots of new video and RF construction projects.			
<b>Slow Scan Television Explained (275gm).....</b>	<b>£5.00</b>	.....	.....
The latest SSTV handbook detailing all the information you need to enter the fascinating world of Slow Scan Television: Basic principles, explanations of all the modes to date, commercial hardware and computer-based SSTV systems. Also various construction projects for SSTV equipment..			
<b>The Amateur TV Compendium (155gm).....</b>	<b>£3.50</b>	.....	.....
The BATC handbook featuring construction articles on video units, 24cm and 3cm ATV, a Digital Frame Store, and much more.			
<b>The Best of CQ-TV (150gm) .....</b>	<b>£3.50</b>	.....	.....
A compilation of the best construction articles from CQ-TV's 133 to 146			
<b>CQ-TV Back Issues: .....</b>	<b>£1.50</b>	.....	.....
The following issues are still available. Please circle those required: 142, 143, 144, 147, 150, 153, 154, 156, 158 159, 160, 161, 162, 163, 164, 166, 167, 168, 169, 170, 171, 173, 174, 175,176, 177,178, 179			
Special Offer: Any four of the above issues .....	<b>£5.00</b>	.....	.....
180, 181, 182, 183 .....	<b>£2.50</b>	.....	.....
<b>Index on a PC format disk (25gm).....</b>	<b>£1.00</b>	.....	.....
All main articles in past issues of CQ-TV and seven handbooks on a PC format HD floppy disk. <b>Note: this index is included on the BATC CD.</b>			
<b>CQ-TV Binders .....</b>	<b>£3.50</b>	.....	.....
<b>The BATC CD (IBM type PCs only).....</b>	<b>£5.00</b>	.....	.....

Total Goods and Postage - Amount Enclosed      £.....

**Publications** orders *ONLY* to: **BATC Publications, Fern House, Church Road, Harby, Notts., NG23 7ED, England.** Tel: 0152 270 3348 (Evenings/Weekends only please). E-mail: [publications@batc.org.uk](mailto:publications@batc.org.uk).

Name:		Mem No:	
Address:			

Items from these lists can **ONLY** be supplied to **CURRENT** members of the BATC. These lists supersede all previous ones.

The indicated prices for **Publications** include postage within the EEC. Will members outside the EEC please either try to estimate the extra postage required, or write for a quotation. All cheques **MUST** be drawn on a UK bank. (Eurocheques, in £ sterling, are acceptable). Items marked thus: \*\* are available only until present stocks are exhausted.

**PLEASE MAKE CHEQUES PAYABLE TO ‘BATC’.**

**MEMBERS’ SERVICES.** A description of the various PCB’s and components can be found in the ‘What’s What’ guide, or on the BATC Internet pages. URL <http://www.batc.org.uk> (A printed copy available on request, if you send a S.A.E.). Components for club projects are not available from Members Services unless contained within these lists. All club crystals are HC18/U (wire ended). To avoid delay and inconvenience, please be careful to include the correct payment with your order – please do **NOT** send stamps or cash. Post and packing costs are for despatch of one item to United Kingdom members.

**Circuit Details can be found as follows:**

**Revised ATV Handbook (vol. 2):** PCB’s 21, 22. **An Introduction to ATV:** PCB’s 10, 25, 36, 40, 41, 47, 85, 86. **TV for Amateurs:** PCB 19. **Slow Scan TV Explained:** PCB’s 59, 60, 61, 62. **Amateur TV Compendium:** PCB’s 12, 27, 54, 55, 56, 57. **CQ-TV (Issue No. in brackets):** PCB’s 7(174), 13(128), 16(134), 20(130), 26(142), 58(139). Item 46 is supplied with circuit details, etc

**CAMERA TUBES** A tube guide appears in CQ-TV 149 and 150. Tubes are now difficult to obtain and members requesting information on availability, prices or other types of tubes or equivalents are asked to send a stamped addressed envelope for their reply.



## Members' Services

Qty	All prices in UK pounds (£)	Each	P&P	Total
<b>Camera Tubes, Scan Coils, Bases &amp; Lens Mounts</b>				
3 .....	One inch Vidicon base	1.20	0.30	.....
4 .....	2/3 inch Vidicon base	0.80	0.30	.....
6 .....	Camera tube (see page ii)	*	1.20	.....
<b>Video and I<sup>2</sup>C Circuit Boards/Components</b>				
7 .....	Sync pulse generator PCB	12.00	0.43	.....
12 .....	Teletext pattern PCB**	3.50	0.43	.....
13 .....	Greyscale/Colour bar generator PCB	3.50	0.43	.....
16 .....	PAL colour Coder PCB**	7.00	0.43	.....
19 .....	Video filter PCB	1.20	0.30	.....
32 .....	UVC3130-09 A-D and D-A IC**	47.00	0.30	.....
20 .....	Video processing amplifier**	4.70	0.43	.....
21 .....	Vision switcher matrix**	4.70	0.43	.....
25 .....	4 input TEA5114 vision select PCB	3.50	0.43	.....
26 .....	Video level indicator PCB	5.90	0.43	.....
40 .....	I <sup>2</sup> C CPU PCB	10.00	0.43	.....
41 .....	I <sup>2</sup> C VDU PCB	10.00	0.43	.....
42 .....	13.875 MHz crystal	4.70	0.30	.....
70 .....	6.0 MHz Teletext crystal	1.75	0.30	.....
43 .....	SAA5231 genlock IC	8.80	0.30	.....
44 .....	SAA5243PE Teletext IC	14.70	0.30	.....
45 .....	PCF8583 Clock IC	7.00	0.30	.....
39 .....	LM1881N Sync separator IC	3.50	0.30	.....
81 .....	I <sup>2</sup> C 27256 EPROM	9.70	0.30	.....
36 .....	I <sup>2</sup> C Video switch PCB	8.80	0.43	.....
37 .....	GX414 Video switch IC	8.80	0.30	.....
38 .....	PCF8574P Input expander IC	4.70	0.30	.....
10 .....	I <sup>2</sup> C Relay PCB	6.50	0.43	.....
9 .....	PCF8574A Input expander IC	4.70	0.43	.....

**RX, TX and SSTV PCB's and General Components**

47 .....	70cm up converter PCB	13.50	0.43	.....
50 .....	108.875 MHz crystal	8.20	0.30	.....
85 .....	24cm ATV transmitter PCB	17.60	0.70	.....
86 .....	24cm solid state amplifier PCB	10.50	0.43	.....
55 .....	Gunn diode modulator PCB	3.00	0.43	.....
56 .....	10Ghz head unit PCB set	3.00	0.43	.....
57 .....	Tuneable IF PCB	3.00	0.43	.....
58 .....	6MHz audio subcarrier generator PCB	3.00	0.43	.....
88 .....	XR215 phase locked loop IC	5.00	0.30	.....
60 .....	G4ENA colour etc. SSTV mod PCB set	5.90	0.43	.....
61 .....	G4ENA SSTV transmit mod PCB	7.00	0.43	.....
62 .....	G4ENA auxiliary PCB	2.35	0.30	.....
68 .....	4.433618MHz crystal	3.25	0.30	.....
69 .....	5.0MHz crystal	3.25	0.30	.....
46 .....	4 Rail power supply PCB	3.50	0.43	.....

**Stationery & Station Accessories**

73 .....	BATC blue diamond clutchpin badge	1.75	0.30	.....
74 .....	BATC cloth badge	4.00	0.30	.....
75 .....	BATC equipment label (6)	0.25	0.30	.....
76 .....	BATC square windscreen sticker	0.10	0.30	.....
78 .....	BATC test card	0.50	0.43	.....
79 .....	BATC reporting chart	0.10	0.43	.....

Total Goods and Postage - Amount Enclosed      £.....

**Members Services orders *ONLY* to: Mr. P. Delaney, 6 East View Close, Wargrave, Berkshire, RG10 8BJ, England.** Tel: 0118 940 3121 (Evenings, Weekends only please).

Name:		Mem No:	
Address:			

**Deadline**

Will all contributors please note that the deadline for articles for CQ-TV 185 is December 18<sup>th</sup> 1998. Please send your contributions in as soon as you can *prior* to this date.

If you would like to contribute an article for publication in CQ-TV, then please send it to the editor, either by post, or preferably by email. If you don't use a word processor, plain ASCII text is fine. Please see page 2 for address details.

The CQ-TV Word 6/7 document template can be downloaded from our web site. Select the CQ-TV magazine link from the home page at <http://www.batc.org.uk>



Visit our Web site at [www.batc.org.uk](http://www.batc.org.uk) to view or download electronic versions of recent issues of CQ-TV



## The World's Earliest-Known Recordings of Television

By Donald F McLean BSc (Hons) CEng FIEE

*All material, photographic or written, is the copyright of the author. Neither photographs nor text may be reproduced in any form unless by written permission of the author.*

Thirty years before videotape recording, between 1927 and 1928, John Logie Baird experimented with recording his television signal onto discs. Five years later, enthusiasts made a few off-air disc recordings of the BBC's 30-line TV broadcasts. Defying previous recovery attempts, the discs now have been restored through use of custom software signal and image processing techniques. The images recovered from the discs give a remarkable insight into those pioneering days of TV. As a bonus, analysing the recorded signal and its distortions unfolds new information on the mechanical TV era.

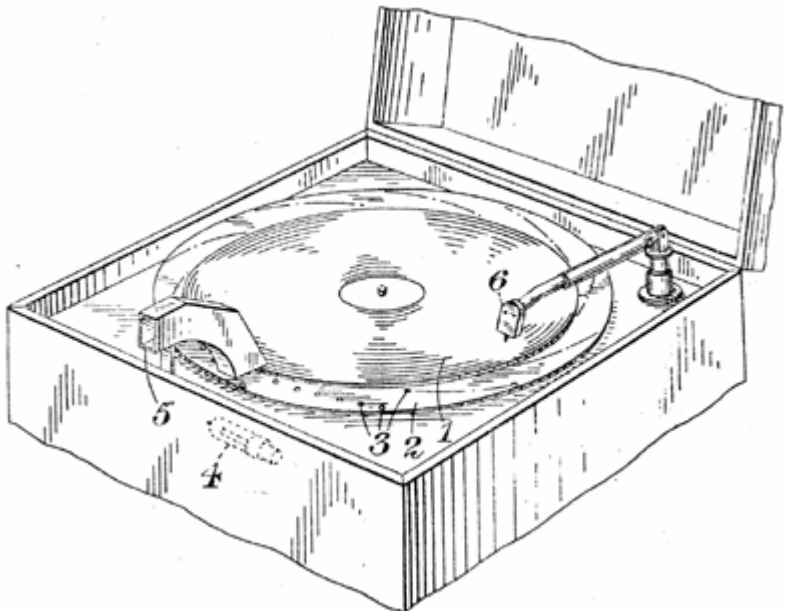

**Fig 1. A schematic from Baird's patent showing an idealised version of his 'Phonovisor' – a simple videodisc player with integrated display.**

## Baird – First in TV

In early 1926, before electronic scanning made today's television possible, John Logie Baird became the first person to demonstrate 'television'. His mechanical scanning system, and the sensitivity and bandwidth of his photocell-amplifiers constrained his picture to mere tens of lines. This low definition, however, offered a distinct advantage: the highest vision frequency was so low that it was in the audio spectrum. This narrow bandwidth allowed Baird to explore advanced concepts of television years before anyone else. One of those explorations was into television recording.



**Fig 2.** One of Baird's Phonovision discs. This one, dated 10<sup>th</sup> January 1928, has 'Wally' Fowlkes as a subject – one of Baird's assistants.

## Baird's Discs

Baird's aim was to make an inexpensive product to replay and display television pictures on a unit not much more complex or expensive than a gramophone, Fig 1.



**Fig 3.** A contemporary photograph of one of Baird's "Stookie Bill" dummies on the left, with the restored image of another "Stookie Bill" from the earliest recording of television – 20<sup>th</sup> September 1927. This disc was used during Baird's successful transatlantic television experiments of late 1927, early 1928.

Neither discs nor the player ever appeared commercially. Unlike Baird's other experiments, the reproduction of *pictures* from his discs was never publicly demonstrated. From his own comments, it would seem that Baird

was never sufficiently satisfied with the picture quality to give such a demonstration.

Baird abandoned this venture and passed a few of the discs, **Fig 2**, to museums and to his friends and employees. Since then, many people have attempted reproduction of images from the discs. Their efforts, using analogue filtering and oscilloscope displays, have yielded only crude distorted images.



**Fig 4. Miss Mabel Pounsford, who 'temp'ed for Baird, features on the Phonovision test disc of 28<sup>th</sup> March 1928.**

What Baird could not have realised is that more than sixty years later the faults during recording could be corrected in a personal computer,

restoring the latent image on his discs to a recognisable form, **Fig 3**. Those images give a remarkable insight into those pioneering days of television, **Fig 4**.

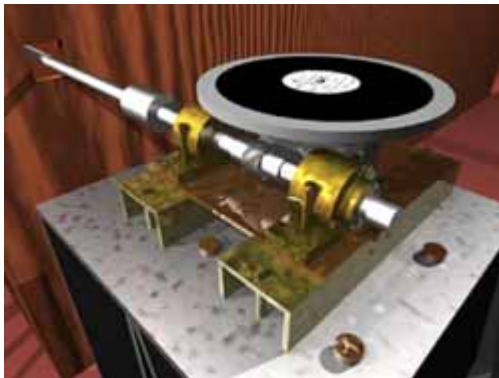

**Fig 5. A computer reconstruction of the synchronisation gear probably used for recording the Phonovision discs.**

But the images are only part of the discoveries made. Studying the details of the video signal tells us the camera type and even how well it was built. In addition, analysing the faults on the recordings gives a unique and in-depth understanding of the difficulties Baird encountered, **Fig 5**. From previously being mere curiosities, the discs have today become one of Baird's most historical

legacies.

## **The earliest-known BBC TV Recording**

In August 1932, after nearly three years of experimental broadcasting by Baird, the BBC Television Service started on the now-mature 30-line system.

It now seems that a few of the television-viewing enthusiasts were moved to use their domestic audio recorders, **Fig 6**, to record the vision signal for subsequent playback. Although the quality of the result would have seriously disappointed them, they very fortunately preserved the discs rather than destroying them.

In 1996, a single privately recorded aluminium disc, with just the cryptic “Television 1933” written in ink on the label, was the first of these to be discovered and restored.

The material on the disc overturns established views on the 30-line BBC programmes. After restoration and analysis, this disc contains the earliest known recording of a television broadcast – in fact, a television special featuring the Paramount Astoria Girls, **Fig 7**. With BBC archives available, I was able to establish from the disc content, the specific programme recorded. As a bonus, this programme was the World’s First Television Revue, broadcast on 21<sup>st</sup> April 1933, just eight months after the start of the BBC 30-line Television Service.

The camera technique, lighting technique and production features are all unusual and unique. The rapid pace of the performance is stunning and provides us today with a true measure of Britain’s heritage of television programme making.

### **‘Madonna’ of the 1930’s**

In early 1998, another discovery was made. A set of unmarked privately recorded aluminium discs has turned out to contain the highest quality original 30-line vision recordings known to exist.



**Fig 6. The ‘Cairnsmor’ domestic audio recording equipment was used for the earliest-known recording of broadcast television. BBC Television Service’s “Looking In” programme of 21<sup>st</sup> April 1933.**

## *The World's Earliest-Known Recordings of Television*

From the video characteristics, they were extracts from BBC transmissions from the latter part of the 30-line service. By that time, the BBC had moved out of Broadcasting House into a new studio in 16 Portland Place. One of the singers on the discs is almost certainly Betty Bolton, **Fig 8**, a well-known contralto, who performed over a dozen times in front of the 30-line cameras.

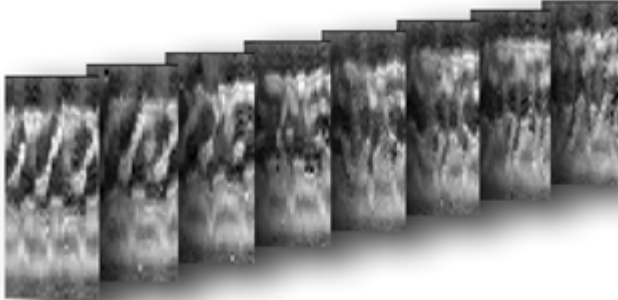

**Fig 7. A sequence from “Looking In” showing the Paramount Astoria Girls doing their chorus line routine.**

In 1935, the first videodisc was sold in the UK. A 78rev/min test disc intended for ‘lining up’ displays, it contains only static lantern slides of cartoon figures, **Fig 9**, and is often confused with Baird’s ‘Phonovision’ disc recordings.



**Fig 8. Betty Bolton is the only person yet identified from the latest recordings. These were more than likely made in the last few years of the BBC’s 30-line service.**



## Summary

The discovery and restoration of the discs falls somewhere between being a computer-age detective story and a practical example of technological archaeology.

Applying the latest technological advances of the eighties and nineties has given us a unique view of the latest technological developments of the twenties and thirties. What makes this so fascinating is that the material comes from such a dynamic and important period in Britain's technological past.

After 1,500 programmes, the BBC 30-line service closed on 11<sup>th</sup> September 1935. In November 1936, the BBC reopened its Television Service with high definition television. The massive technology leap that television had made left recording technology far behind. It would be nearly twenty years before direct video recording could catch up.



## Acknowledgements

I would like to thank the various owners of the discs, private individuals and museums, for loaning the material. I would especially like to thank Ray Herbert for his support on innumerable occasions, and Eliot Levin of Symposium Records for transcribing the heavily corroded and damaged amateur recordings of BBC Television.

<http://www.dfm.dircon.co.uk> contains further information.

**Fig 9. One of the twenty stills from the red-labelled “Major Radiovision” disc sold in 1935 as a test source of 30-line material.**

## More changes to the 10 GHz Band

### **By Graham Shirville G3VZV**

In a press release issued on the 31<sup>st</sup> July 1998 the Radio Communications Agency announced a number of changes to the Amateur 10GHz band in the UK.

Currently the band is 10.00 – 10.15 & 10.30 – 10.50 GHz for the amateur service and 10.40 – 10.50 for the amateur satellite service.

Due to pressure from the Radio Fixed Access service (basically business and domestic telephones without the use of copper wires) the band will, with effect from 1<sup>st</sup> February 1999 become;

10.00 – 10.125 & 10.225 – 10.475 GHz for the amateur service and 10.40 – 10.50 for the amateur satellite service.

As this change actually increases the number of MHz available to amateurs it appears to have elicited a very limited response from the RSGB who simply reported it in the RadCom magazine that came out in mid August.

On the same page, an RA “open forum” held at Birmingham on 24<sup>th</sup> July was also reported upon. Amazingly the report included a quote from Martin Cain of the RA who, in his opening statement, said “...there is no impending danger to any (amateur) frequency allocation...”

What appears to have been overlooked by all those who were in the know is that six of the seven licensed 10GHz ATV repeaters use the 10135MHz output frequency that will no longer be available to us!

The first that the RSGB Repeater Management Committee knew of this was when they heard the GB2RS news broadcast for that weekend! Therefore they send apologies to all the groups involved for not having been able to give them prior warning.

The actual band planning is the responsibility of the Microwave Committee (who have also pleaded ignorance of the change) and urgent discussions are taking place to agree on a replacement channel for the one that is going to be lost.

Hopefully this will be sorted out in the next few weeks and then the groups will be asked to fill in a couple forms for new NOV's to be issued. As this is the second channel change that has been forced upon the groups within the past 36 months they should know the process and, with luck, it can be completed in time for the 1<sup>st</sup> February 1999 deadline.

## Awards News

## By Bob Webb, G8VBA

It is many months since I sent you any info regarding BATC awards. It seems that the majority of activity now takes place on the 23 cms band and in particular on the ever-increasing number of repeaters. Unfortunately repeater contacts do not qualify for points towards awards. Also contest activity seems to have declined. Many awards were gained with points scored during contest QSOs at one time. By now you have probably worked out why awards news has been scarce of late. Gold award no.56 to G6DTW in September 1994 and Silver award no.57 to G8OZP in September 1996 are the two most recent awards to have been gained. Congratulations to both stations.

The BATC Awards were introduced to mark the one hundredth issue of CQ-TV to encourage activity in amateur television by providing an incentive in the form of a certificate. The award is available to both transmitting and receiving stations and SWLs in any part of the world whether they are members of the British Amateur Television Club or not. The award is for fast scan television only.



## **Transmitting Award**

For pictures transmitted which have been successfully identified by another station, claim 2 points per kilometre; if the contact becomes a successful 2-way exchange of pictures, then 10 bonus points may be claimed by each station regardless of distance. For contacts on the 1.3GHz band or above, points are doubled.

## **Receiving Award**

For any picture positively identified - claim for a one way contact. Otherwise rules are as for transmitting.

## **Points**

The award is divided into four grades: for the Bronze - 1,000 points, Silver - 5,000 points, Gold - 10,000 points and the Diamond - 100,000 points. Points already gained for an existing award may be added in when applying for a higher grade.

## **Contacts**

A station may be worked once only per day for the purpose of awards. It is quite possible for the award to be gained by working the same station many times. Contacts through repeaters do not count.

## **The Certificate**

Upon qualification for the Bronze award a certificate will be issued together with Bronze seal; the certificate may be up-graded later with Silver and Gold seals. The Diamond award is in the form of a specially made trophy.

## **Applications**

Applications should include log details consisting of call sign, date of QSO, band, location of station worked and points. Contacts made from other than the home station should be clearly marked. QSL cards are not required, but the application should be checked and signed by either a licensed amateur or a BATC member.

**CERTIFICATE APPLICATIONS SHOULD INCLUDE A LARGE (12 x 8.5 inches) STAMPED ADDRESSED ENVELOPE.**

For upgrades seals an ordinary SAE should be enclosed.

**Applications should be made to Awards Manager: Bob Webb G8VBA, 78 Station Road, Rolleston on Dove, Burton on Trent. Staffs. DE13 9AB. Tel: 01283 814582.**

## Circuit Notebook 65

By John Lawrence GW3JGA

### Video Optocouplers

Recently, the Annual General Meeting of the Arfon Repeater Group was relayed live, to Amateurs in the area, through the North Wales ATV repeater GB3TM.

The 24cms portable transmitting and receiving equipment, for linking to the repeater, was installed in the boot of my car which was parked outside the meeting hall. A camcorder with a local monitor, a separate microphone with preamplifier and a large screen TV were installed in the hall some 75metres away. The TV set signal and camera video were carried on coax cables and the audio on twin screened audio cable.

The equipment in the car was powered from the mains using a mains extension lead which plugged into a nearby mains socket.

### Mains Hum Problems

Mains hum problems on both video and sound appeared immediately due to the ac potential on the earth pin on the mains socket in the car being significantly different to that on the socket in the meeting hall. This caused a heavy 50 Hz current to flow through the screens of the video and audio cables. The TV set was fed with RF to its insulated aerial socket and was not affected.

Fitting an audio isolating transformer in the audio line solved the microphone hum problem and, very fortunately, we were able to borrow an expensive video isolating transformer which when fitted in the video line eliminated the hum on the video signal. An alternative to using an expensive video isolating transformer would have been to use a video optocoupler, which is the topic for this edition of Circuit Notebook.

In an optocoupler, the input signal is fed to a light emitting diode, the emission from which is optically coupled to a photodiode. The resultant output current is related to the applied input signal. The components are assembled to form an integrated circuit that may also contain an output amplifier stage. There is no electrical connection between the input and output circuits.

### A Video Optocoupler Circuit

Hewlett-Packard make a wide-band optocoupler, HCPL-4562, which is very suitable for video isolation purposes, having a bandwidth of 17 MHz.

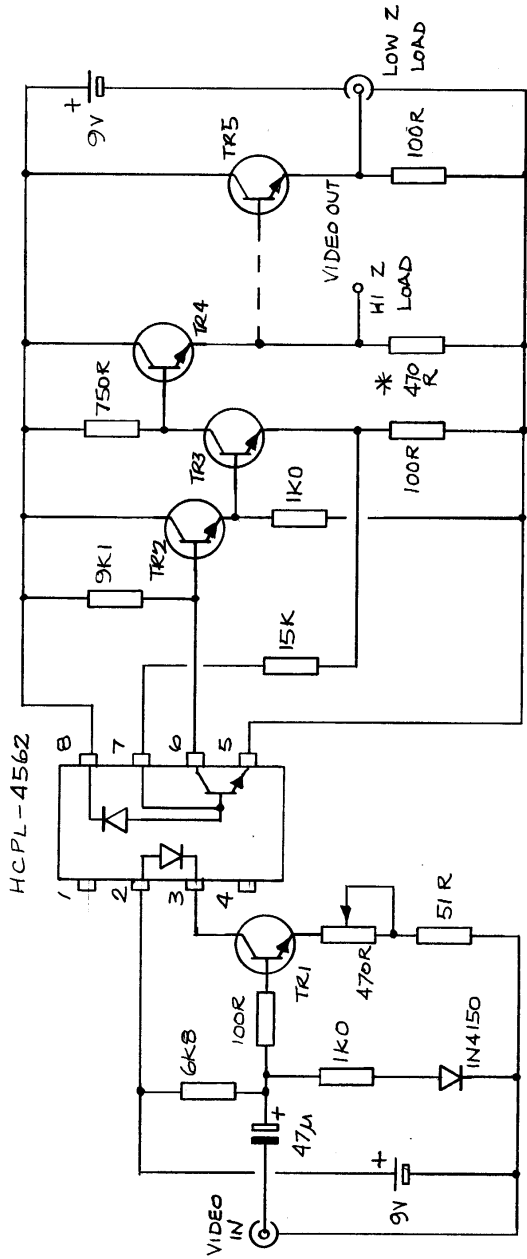

TR1-5 2N3904 \* 2K2 WHEN FEEDING TR5

The H.P. Data Sheet gives a recommended circuit for video isolation purposes and this is shown in Fig. 1. The video output is suitable for feeding into a high impedance, so a further buffer stage is required when feeding into 75 ohms. The Data Sheet recommends a simple emitter follower and this is also shown. The overall frequency response of the complete circuit is substantially flat, falling to -0.5 dB at about 4 MHz and -2 dB at 10 MHz.

The HCPL-4562 is available from Farnell using Order Code 492-024 and a copy of the H.P. Data Sheet may be obtained from Farnell by phoning their Data Service on 0113 231 0160 or FAXing 0113 279 4449 quoting the above Order Code.

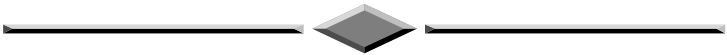

**A must for all  
PC owners.  
Hundreds of  
back Projects,  
many not  
available in  
any other  
Format.**

Send orders  
to the BATC  
Publications  
department.

## By Paul Holland G3TZO

The launch of UK digital TV is now a reality, with B-Sky-B and other UK broadcasters delivering nearly 200 TV and Radio services from 28.2 Deg E. Whilst analogue will still be with us for some time, the growth of digital TV is definitely where the action is. This edition of "Satellite TV News" once again reflects this trend with news of new services, new equipment and the usual crop of new satellite launches.

### Channel News In Brief

**Med TV** - the Kurdish general entertainment broadcaster, has begun transmissions on HotBird 4, 10.853 GHz (H). The service on Eutelsat II-F2 has closed.

**MTV** - is launching M2 its second channel in Europe. M2 will join the BSKyB and Scandinavia digital-packages at 28.2E and 1.0 Deg W respectively

**Denmark's Star TV** - has ceased its transmissions in clear D2-MAC on Thor 2 11.389 GHz, and clear in MPEG-2 on Intelsat 707 11.592 GHz at 1.0 Deg W.

**APT** - news feeds have been seen on Eutelsat I-F5 21.5 Deg E 12.511 GHz v (SR 5632, FEC 3/4)

**MTV Nordic** - has closed on Intelsat 707 at 1 Deg W on 11.434 GHz (V) and is now only on Sirius 2, 12.207 GHz (V). DR 2 has replaced MTV and is also encrypted in D2 MAC/Eurocrypt.

**Animal Planet** - has launched at 19.0 Deg E in analogue as part of Sky's multi-channels package.

**UK Horizons** - currently available soft-encrypted on Astra 1E, has moved from 10.818 GHz (V) to 10.832 GHz (H) and been replaced by UK Style.

**TV3** - the Republic of Ireland's third national television station, may launch in digital on Astra 2A in March of 1999.

**TELE 24** - Swiss entertainment-channel TELE 24 planned to launch on 5 October 1998, on Hot Bird 3, in digital. Due to copyright reasons some parts of TELE 24 will be scrambled.

**Iraq Satellite Channel** - has launched on 11.862 GHz v (PAL) and 11.823 GHz v (MPEG2) on Nilesat at 7.0 Deg W.



**Fashion TV**- has split. "Fashion TV L'Original" can be found in MPEG-2 on Astra 1F on 12.402 GHz, on Hot Bird 3 on 12.322 GHz, and on Intelsat 806 on 3.803 GHz. The channel for men, "Fashion TV Hommes", can be found in PAL on Hot Bird 2 on 11.766 GHz, and in MPEG-2 on Hot Bird 3 on both 12.245 and 12.322 GHz.

**EBU** - The former EBU SIS services at 7.0 E are now carried in MPEG format on the following frequencies;

11.005 GHz h SR 5632, FEC 3/4

11.014 GHz v SR 5632, FEC 3/4

11.014 GHz h SR 5632, FEC 3/4

11.023 GHz v SR 5632, FEC 3/4

11.043 GHz h SR 5632, FEC 3/4

11.052 GHz v SR 5632, FEC 3/4

11.053 GHz h SR 5632, FEC 3/4

11.061 GHz v SR 5632, FEC 3/4

11.066 GHz h SR 13845, FEC 7/8

11.070 GHz v SR 5632, FEC 3/4

11.084 GHz v SR 13845, FEC 7/8

11.102 GHz v SR 13845, FEC 7/8

11.102 GHz h SR 13845, FEC 7/8

**BBC Parliament** - has replaced The Parliamentary Channel and started transmissions on 11.534 GHz (V) (V-PID 516, A-PID 680), MPEG2 clear on ORION 1, 37.5 Deg W

### **THOR III, 0.8 Deg W**

Since its launch Thor 3 is now well established, with excellent reception with dishes of 1.0m and over across the southern half of the UK. Reception appears to drop off, as expected, the further North and West you are. The line-up (encrypted in D2 MAC/Eurocrypt) is as follows;

**11.823 GHz (H)** TV 1000 Cinema, History Channel

**11.727 GHz (V)** Sky News, .TV, National Geographic TV

**11.747 GHz (H)** 3+ Denmark

**12.054 GHz (H)** Sky Entertainment (Granada Breeze, Granada Plus, G Men & Motors, Video Zone)

The following two digital services are also to available here:

**12.322 GHz (H)** TV Buttiken Norge

**12.228 GHz (V)** Sky Entertainment

CANAL+ Finland is also rumoured to be launching on Thor 3 in analogue - no details are yet available.

### Nilesat Transponder Allocation

The published footprint for Nilesat reproduced previously in Satellite TV News offered little prospect of reception in the UK. Since Nilesat's launch however, reception reports show that four of the vertical TP's are receivable at quite good strengths across most of England and Wales. At this QTH I receive all 14 digital educational services on Tp's 2&6 as well as the analogue services on Tp's 8&14. The digital signal is clearly on the receiver threshold as reception is fine during the morning with an increasing bit error rate as the day progresses. Comparison of the digital to analogue signals is interesting with the PAL signals at about P3 all day and of course digital is either P5 or nothing !! Nilesat's transponder plan is as follows:

11,727 H	tp 1			
11,747 V	tp 2	ERTU	MPEG-2 clear	275003/4
11,766 H	tp 3	ERTU	MPEG-2 clear	275003/4
11,785 V	tp 4			
11,804 H	tp 5			
11,823 V	tp 6	ERTU	MPEG-2 clear	275003/4
11,843 H	tp 7	ERTU	MPEG-2 clear	275003/4
11,862 V	tp 8	Iraq Satellite Channel	PAL	6,50 MHz
11,881 H	tp 9	1st Net	MPEG-2 IRDETO	275003/4
11,900 V	tp 10			
11,919 H	tp 11			
11,938 V	tp 12			
11,958 H	tp 13			
11,977 V	tp 14	J S C (Libya)	PAL	6,60 MHz
11,996 H	tp 15	Showtime	MPEG-2 IRDETO	275003/4
12,015 V	tp 16			

12,034 H	tp 17	Showtime	MPEG-2	IRDETO 275003/4
12,054 V	tp 18			
12,073 H	tp 19	1st Net	MPEG-2	IRDETO275003/4

## Orion 2

Loral Space & Communications will build the next Loral Orion Atlantic Ocean region satellite, Orion 2, which be launched in mid-1999. Orion 2, featuring 38 high-powered Ku-band transponders, will cover all of Europe (see footprint below) and large sections of North America and Latin America. In addition, the satellite will deliver spot beam coverage of South Africa. The 10 kilowatt Orion 2 satellite will be based on SS/L's three-axis, body-stabilised FS-1300 bus, and will have a mass of 3,800 kilograms, when it is launched aboard an Ariane 44LP launch vehicle in May 1999. The spacecraft will have an expected lifetime of 16 years.

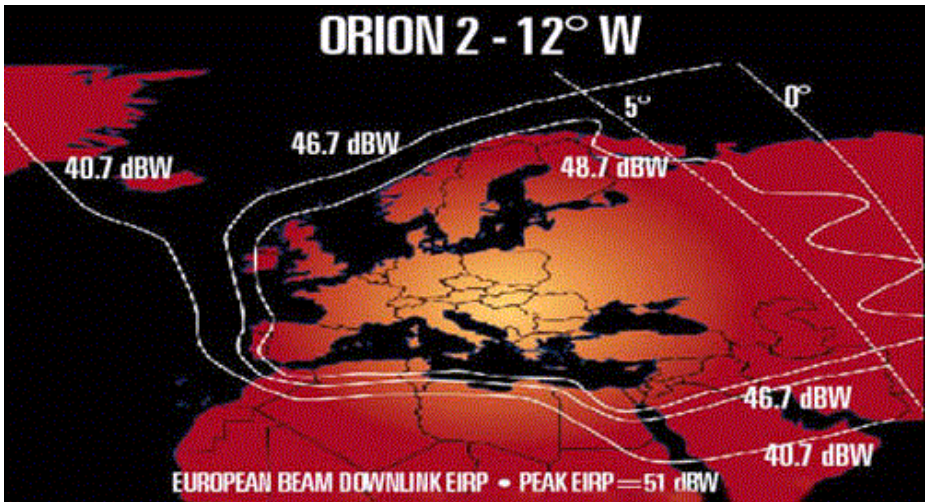

A possible broadcaster from Orion 2 is the PAN European cable operator UPC, who aim to provide 25-50 TV channels plus 50-100 NVOD (near video on demand) services plus up to 100 audio (music) channels. Although not currently planned as a DTH service, initially targeted just as a service to cable head ends, this could provide an interesting service from the 12 Deg W slot.

## Going Digital

Do as I say - not as I do goes the adage ! Well as reported last time I have been exploring the digital ether during the Summer using my newly acquired Nokia 9600S. For those whose interest in Satellite TV was

nurtured by the rapid expansion in analogue programming and broadcast feeds a few years ago, digital now offers a return to those days when there was always something new going on. Nowadays the number of new analogue services is being more than matched by those switched off and converted to digital. By way of contrast the number of entirely new digital broadcasters is a revelation. The following notes summarise my initial experiences.

## Receive Set Up

Like all current digital receivers, the Nokia 9600 is not designed for use in a motorised system. The Nokia does however, like many modern receivers, have DiSEqC switching capability which has been utilised as shown below;

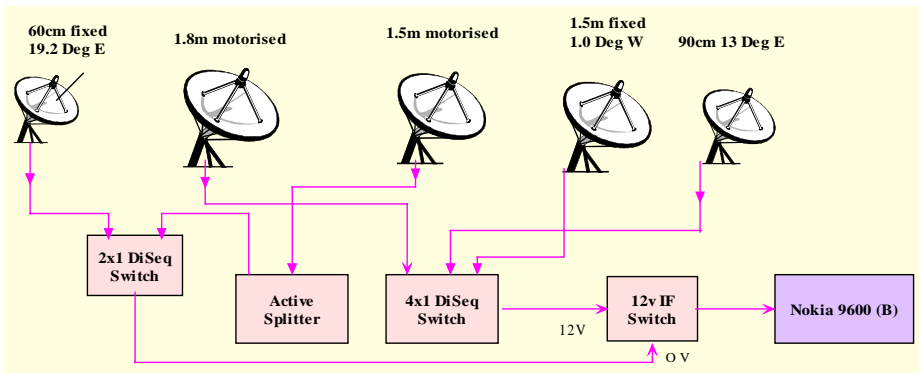

With the set-up shown above (analogue receivers omitted for clarity) I have instant switching between 19.0E, 13.0E and 1.0W plus two additional orbital positions controlled from the shack. In effect this gives me access to nearly 250 FTA TV services plus 100 or more Radio services. Many of the channels are duplicates of those available in analogue but more than half are only available at this QTH in digital.

The simple way to assess if you will receive a service (assuming of course you have sufficient signal) is as follows;

- Is the service fully encrypted ? - if so you will need an appropriate Conditional Access Module and Smart Card
- Is the service Free to Air (FTA)? - if it is then even if the service is part of an encrypted package of channels you need only a DVB MPEG2 compliant receiver.
- Is your receiver capable of being programmed for the appropriate Symbol Rate and PID's being used - if not then you may miss the lower bit rate and SCPC services.

When selecting a receiver the key things to look out for are;

- Symbol rate selection should be 1 - 40 Ms/s or you will miss the Single Channel Per Carrier (SCPC) services.
- The ability to manually input or automatically select Audio and Video Packet Identification numbers (PID's).
- The ability to upgrade software using a PC or "off-air" – I have already upgraded to C1.23 software via NRK International at 1.0 Deg W.
- A Common Interface (CI) PCMCIA slot for inserting your selected CAM.

As with all things - the longer you wait, the more likely new features will emerge - it's a lottery picking the right moment. Features not available on any receiver *yet* are proper motorised control and multi-satellite menu features.

As the ink dried on my cheque for the Nokia 9600, I received details of the Nokia 9800 which offers SatScan (motorised capability) and improved software for managing the large numbers of channels on different satellites - c'est la vie !

## Launch News

October saw one of the busiest months ever for European launches. With the successful launch of Astra 2A and Sirius 3. SES now has sufficient capacity to release Astra 1D from its temporary duties at 28 Deg E. Astra 2A's footprint is show below

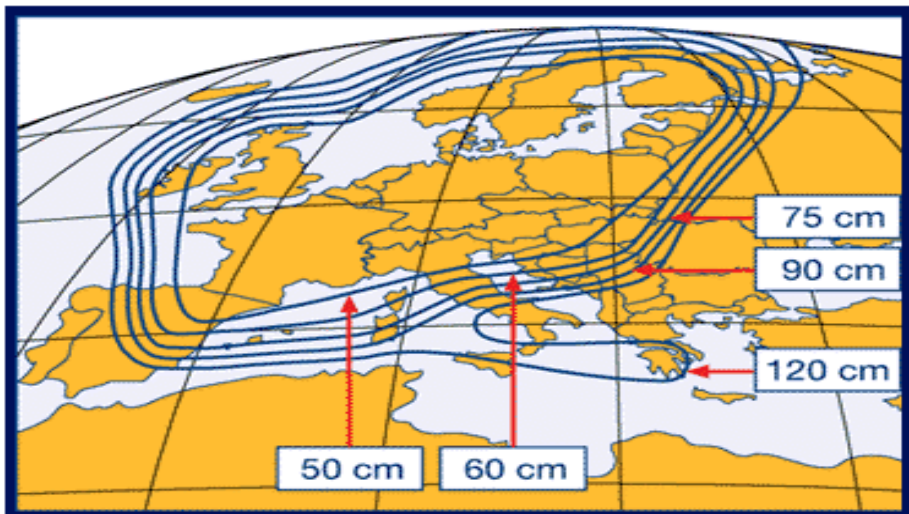

The launch of Hotbird 5 and W2 will enable the transfer of services from Eutelsat IIF1 and IIF3 respectively. This will mean that all services from 13.0 and should be receivable in the UK using a 60cm antenna. Other planned launches are given in the table below.

Date	Satellite	Position	Launcher
Launched	Astra 2A	28.2 E	Proton
1998 Oct 03	Sirius 3	28.2 E	Ariane
1998 Oct 06	Hotbird 5	13.0 E	Atlas
1998 Oct 23	Eutelsat W2	16.0 E	Ariane
1998 Dec 22	PAS 6B	43.0 W	Ariane
1998 Dec 29	Astra 1H	19.0 E	Proton
1999 Feb	Eutelsat SESAT	36.0 E	Proton
1999 Feb	Arabsat 3A	26.0 E	Ariane
1999 Mar	Eutelsat W4	36.0 E	TBA
1999 Mar	Astra 2B	28.2 E	Ariane
1999 Apr	Eutelsat W3	7.0 E	Ariane
1999 Jun	Orion 2	12.0 W	Atlas

### Eutelsat News

Eutelsat has ordered a new satellite called RESSAT, to guarantee service in the event of a launch failure of one of the satellites in the W series, the first of which is to go into orbit in October. Equipped with 28 transponders and based on the Hot Bird platform, the satellite could be slotted in at 7, 10, 16, or 36 degrees East.

### New Equipment

#### The Ganymede Receiver Commander

A number of people using digital receivers use their analogue receiver to control both the satellite position and individual channel polarity. Whilst this provides a basic solution to motorised control, a new product - the Ganymede Commander has been launched aimed at simplifying digital channel changing.

The Ganymede Receiver Commander is a low cost microprocessor based device that enables the Nokia Mediamaster and other digital receivers to be seamlessly integrated into multi-satellite motorised systems. Version 101 is customised for the Echostar LT 8700 receiver/positioner. The Commander utilises the functionality of the LT 8700 to automatically control peripherals that are otherwise inaccessible to the digital receiver.

#### Key features include:

- Automatic control of ferro-magnetic and mechanical polarisers.

- Automatic band switching of conventional triple and quad band LNB's, etc.
- Maintains correct skew settings for all satellites.
- Automatic dish positioning for up to eight satellites.
- Easy installation.
- User programmable.
- Signals to LT8700 by Infra-Red.

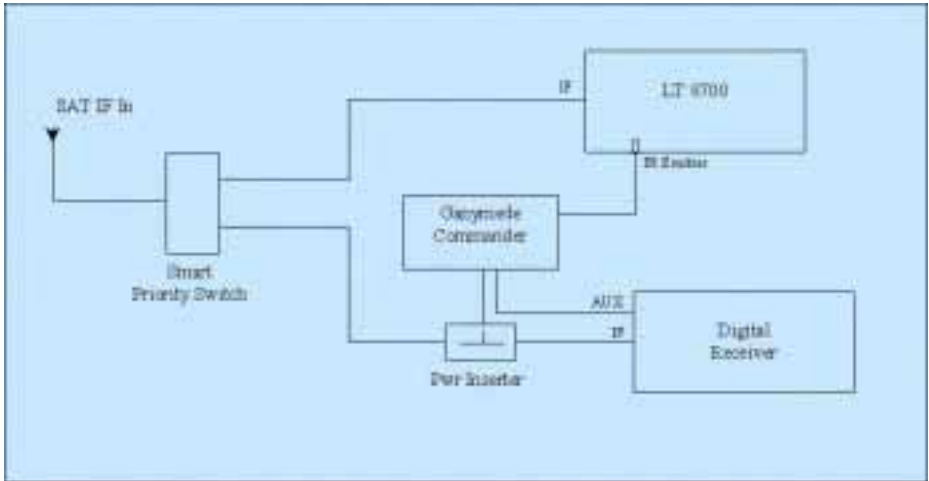

The Commander monitors the 13/18V, 22kHz and 12V Auxiliary signalling states of the digital receiver to determine the polarity and LNB band of the wanted digital channel. Additionally, the Commander monitors the digital receiver's DiSEqC antenna switching messages to determine which satellite is carrying the wanted channel. This information is then relayed to the LT 8700. To signal to the LT 8700, the Commander emulates the Echostar's hand held remote control unit. Band and polarity switching is accomplished by selecting one of four channels that are pre-assigned for the purpose. Dish positioning uses the Echostar's 'Select Satellite' command. To the end user, the action is transparent; selecting a channel on the digital receiver causes an automated sequence of commands to be generated, which carry out all the functions necessary to receive the particular channel.

Installation is simple, requiring no internal modifications to either digital or analogue receiver. Signalling from the digital receiver is acquired via a proprietary Power Inserter such as the Global DCBF. The Commander

also receives its power via this route. A second input from the digital receiver carries the auxiliary 12V signal. To synchronise its dish-positioning operations, the Commander requires a 'Motor Pulse' input from the positioner motor. This is obtained from the rear panel terminal block of the LT 8700. Signalling to the LT 8700 is achieved by means of an Infrared emitter which attaches to the Echostar front panel by means of a self-adhesive pad.

Further details of the Gannymede Commander are available from Gannymede Test & Measurement, 10 Green Park, Prestwood, Great Missenden, Bucks HP16 0PZ Tel/Fax: 01494 863734.

### **Digital Reception Tips**

Those of you now equipped for digital reception will find narrow band/low symbol rate signals like NBC on 13 Deg E are very dependant on the LNB's long term temperature/frequency stability. This isn't anything to do with local oscillator phase noise, as you might think, but more the mechanical expansion and contraction of the LNB case with temperature. If the picture starts to break up or is not there at all, go into the advanced channel search menu and key in a frequency around 3MHz lower than the receiver displays. Then leaving the FEC /SR/PID settings as they were do a further search. If the picture is better, fine - if not go 3MHz up on the original reading. You can store 2 NBC's for instance: LNB hot and LNB cold. The wideband signals with many other services don't suffer from this effect, as the LNB drift relative to overall signal bandwidth isn't so great.

### **Conclusion**

That's it again for another edition. With the increasing shift of emphasis to digital reception I need feedback from you to ensure that the column remains topical and interesting to all those interested in Satellite TV reception. Let me know what you think and please pass on anything that may be of interest to others. The E-mail address as usual is [paul.holland@btinternet.com](mailto:paul.holland@btinternet.com) or telephone 01948 770476.

**Please mention that you saw it  
in CQ-TV when responding to  
advertisers.**



# Worthing & District Video Repeater Group

## GB3VR GB3RV & GB7VRB

### 1Watt FM-TV 24cms Transmitter

The 1 watt transmitter generates its signal at the wanted frequency which can be set anywhere in the band, colour or B/W. On board intercarrier sound and fixed pre-emphasis are standard features. The kit includes the PCB all the on board components, pre-drilled heat sink, an Eddystone Di-cast box and full and comprehensive instructions. Building time is three evenings work. The new price for this kit is £80.00, P&P £2.50. Over 750 units sold to the Amateur market alone.

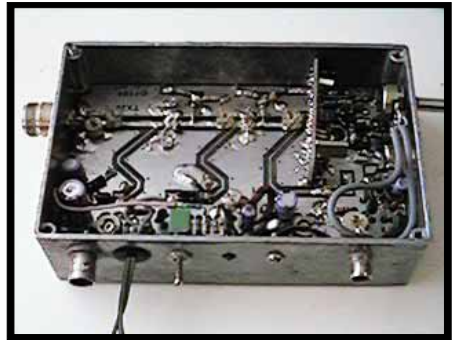

### Two channel phased locked loop kit.

This add-on kit vastly improves the overall stability of the 1-watt transmitter. Two crystal locked channels and a third free running tuning position are available. Kit price £30.00

### Amiga ATV Program-2

The New Amiga ATV program has more features than ever, up to 56 testcards, 20 wipes, superb text control, 30 screens of text messages, QRA calc, Testcard music, selectable displays, and this version has a DTMF tone pad to control your repeater. All testcards are over-scan i.e. the whole screen is used, Load in your own customised testcards, Extra large text, scrolling text, clock, callsign extensions, Hot key operation, Doc reader, ATV Cli, Cross Hatches, Purity and a comprehensive section for genlock users. For any Amiga with 1meg or more, state callsign and QRA (if known) when ordering, this three disk set is now only £10.00 P&P 75p

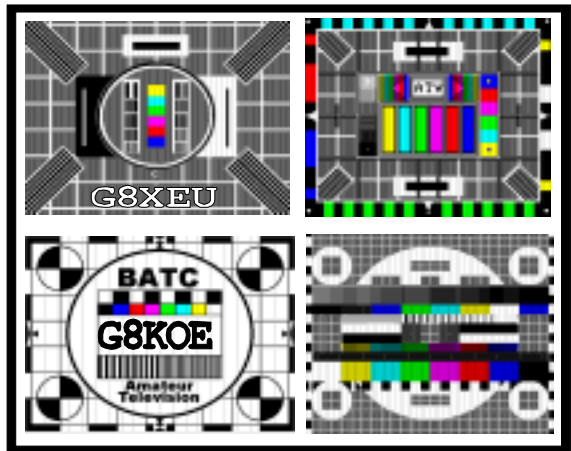

### Spectrum ATV Program

Still selling after all these years, why, its good, its cheap and it works on all spectrum based machines. The 48k version has over 60 commands which include 7 Testcards, Memo pad, clock, maps, tones, QRA locator, various size printing, plus disk transfer routines and much more. Now only £5.00 P&P 8p

Visit the all new GB3VR-RV web site at: - <http://www.g8koe.demon.co.uk/>

**Orders should be sent to: -**

**Treasurer of GB3VR, R. Stephens, 21 St. James Ave., Lancing, Sussex, BN15 0NN. Cheques payable to "W&DVRG" Tel (01903) 765760 7 to 8pm.**

**By Graham Hankins, G8EMX.**

Every year, members of the Ballymena Radio Club visit Rathlin Island, which is off the coast of Northern Ireland, to mark Marconi's first transmission from the island to Ballycastle in 1898. The club usually sets up on the H.F. and some higher bands, under the call sign GB3MRI, but to celebrate the centenary of Marconi's original Rathlin - to - Ballycastle signal (which an insurance company needed to monitor passing shipping) the Ballymena Club decided to add Amateur TV pictures to their normal expedition this year.

Jack Moffitt G18DMX writes: "With my friend Sam G18GJX we tried for ATV using 1.3GHz (24cm), 10GHz (3cm) and 24GHz (1cm). Perfect colour pictures were sent from Rathlin Island to Kinbane Head on 3cm, with a return path on 23cm. RSGB President Ian Kyle (G18AYZ/M10AYZ) was among the islanders on Rathlin, the pictures at Kinbane Head being watched by dignitaries from the local Moyle District Council".

ATV kit used by the BRC consisted of: for 3cm - Gunn oscillator with 20dB horn fed by a 10mW Tx, into a 30" dish. On receive a LNB fed a satellite receiver.

For 24cm - Wood and Douglas Tx and PA giving 3W into a 15/15 beam. A modified satellite RX on receive, fed by a loop Yagi. Homebrew on 24GHz.

Unfortunately, on the day, the 24GHz ATV link didn't work. Jack comments: "The problem was caused by a critical adjustment of the 24GHz local oscillator. We will be trying again when the weather improves. Meanwhile, the local ATV activity is sparse - I have sent pictures on 24cm and 70cm to Fred G13TIJ (near Lough Neagh), which is a 50km line-of-sight path. The expedition to Rathlin Island this year will be featured in the RSGB magazine 'RadCom' so maybe this will boost the interest in ATV".

Chris Gibbs G8GHH is Secretary of the Kent Television Group (KTG) and technical Co-ordinator for 24cm ATV repeater GB3KT (Isle of Sheppey). Posting a copy of their June newsletter to me, Chris adds: "Latest information is that we have added another 3m to the mast at GB3KT and replaced the old Alford-Slot antenna with a new one. This has given improved results for almost all ATV stations who use the repeater".

The KTG newsletter editor is Paul Prior G8IXC and the June issue includes off-screen pictures of recent activity, a report of the BATC's Coventry rally - and an 'outsider's view of amateur television' which made fascinating reading. The KTG plan to publish their newsletter quarterly, so I look forward to seeing the September issue, folks!

The Home Counties ATV Club's repeater GB3HV (High Wycombe) is one of the UK's most advanced machines, and the Club's magazine 'Line Out' shows what is involved in maintaining such a system. Some recent problems have been:

'Unstable when cold' faults on a masthead receive preamplifier.

The mast camera developed a tendency to snag its long 'Pan & Tilt' umbilical cable on the camera housing clips. When this occurred the functions seemed to reverse, as the low power tilt motor readily reversed direction if stalled (to reduce the chance of damage). However, setting the view to near to the horizon and panning to the north was found to free the hooked cable.



The Home Counties ATV Group secretary is John Stockley G8MNY. John adds: "The Teletext system on 'HV is still holding its memory, but it has been months since any fresh pages have ben uploaded. The Teletext reception at

Sandown Model Control Exhibition was surprisingly good for the picture quality received, so the last timing adjustments seem to have worked".

The Beacons Repeater Group in the West Midlands is experiencing less coverage than expected from its 10GHz repeater GB3BG. Trees are the problem, apparently, but plans are under way to raise the antenna, which should improve the situation. The Group will have to replace the antenna anyway, because of the recently announced frequency restrictions on the 3cm band.

# VHF COMMUNICATIONS

VHF COMMUNICATIONS magazine is published quarterly and is available from **KM Publications**, 5 Ware Orchard, Barby, Nr. Rugby, CV23 8UF, England.

Telephone: 44 (0) 1788 890365, Fax: 44 (0) 1788 891883

Email: [vhfsubs@vhfcomm.co.uk](mailto:vhfsubs@vhfcomm.co.uk)



The 1997 subscription rate is £18.00 for cash or personal cheque (drawn on a UK bank, or bearing the name of a UK banking agent), postal orders or bankers draft made payable to VHF Communications. Payment may also be made by any major credit card at £18.90. The subscription included surface mail charges, airmail is extra at £6.50 per year (£6.85 by credit card). The magazine is a **MUST** for the radio amateur and professional engineer interested in VHF, UHF and Microwave working, containing, as it does, detailed construction articles for equipment operating in these bands.

**Back Issues: special offers - enquire for details**

**Binders to hold 12 issues ..... £5.50**

**Complete Index 1970 - 1995..... £2.75**

Email: [vhfsubs@vhfcomm.co.uk](mailto:vhfsubs@vhfcomm.co.uk) Web site: <http://www.vhfcomm.co.uk>

Secure credit card page: <https://www.vhfcomm.co.uk/saleform.htm>

## Off Air Pictures from Adrian Knott, G6KSN

The following pictures were received in the early hours of Monday the 10<sup>th</sup> of August on the 23cm band. The equipment used to receive them consisted of a home brew 27 element loop Yagi feeding a home brew GaAsFET preamplifier. The receiver was a Eurosat MR-1000 fitted with a 12 MHz IF filter at 70 MHz. I am located at SO973939 (139M ASL) my antennas are 30M above ground level.

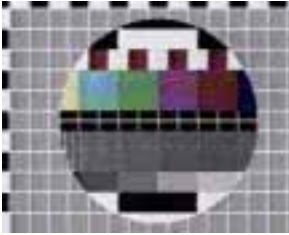

This is a shot of the Lowestoft repeater, JO02VL, displaying its test card in beacon mode



This shows the Hilversum 23 cms repeater in beacon mode, the gra was given as JO22OF.



Mark is also active on 3 and 13cms.



This shot received direct from Mark, PE1RJU on 1249 MHz



Rebroadcast by Mark on 1249 MHz



Rebroadcast by Mark on 1249 MHz



This shows the Aalten 23 cms repeater in beacon mode.



# Sevenside Television Group

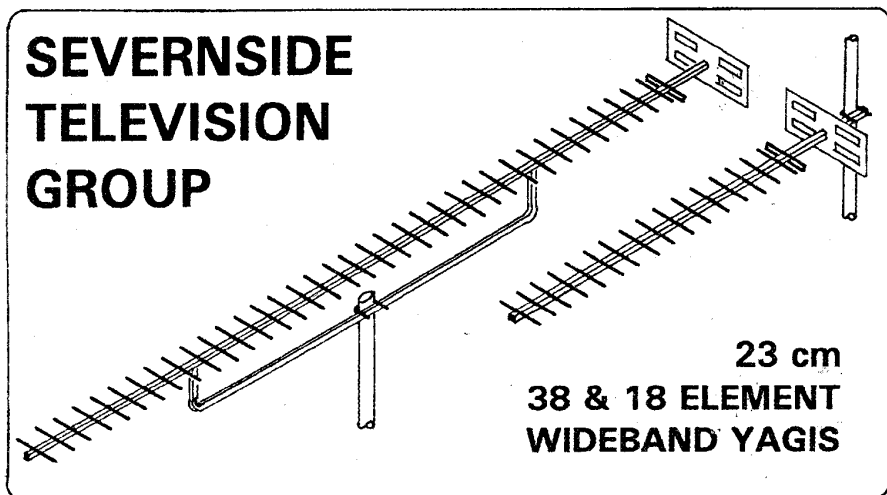

All of our 23 cm Aerials are specifically designed for ATV use - although they can be used for other modes as well. Wideband characteristics mean that you need only one aerial to cover the repeater input and output channels. Our famous wideband yagis come fully assembled in two versions:

**38 ELEMENT HIGH GAIN:** 14 dB gain, 1.8 m long, **£26.00** plus postage.

**18 ELEMENT STANDARD:** 10 dB gain, 0.9 m long, **£15.00** plus postage

Don't forget our **20 ELEMENT CONVERSION KIT**, which converts your existing 18-element aerial to the full **38-element** high gain specification: **£13.00** plus postage. Our 23cm **TROUGH REFLECTOR** is quite unique, combining 11dB gain with wide bandwidth *and* wide beamwidth. It's also compact, just 0.55 m high, 0.35 m wide and 0.3 m deep. Supplied as a kit of predrilled and preformed parts for easy "Screwdriver" assembly: **£19.00** plus postage. All aerials feature an SWR of less than 1.5:1 and are supplied with mast clamps suitable for masts up to 55mm diameter. Mast poles shown are not supplied.

**POSTAGE:** **£3.75** for one aerial, **£5.00** for two or more. Telephone orders with cash on delivery: **£2.75** supplement per order, Orders from outside of the UK - please write for carriage quotation.

**CHEQUES** payable to "SEVERNSIDE TELEVISION GROUP" and send to 18, Linnet Close, Patchway, Bristol BS12 5RN. Telephone (evenings and weekends only please) 0117 969 8136. Please allow 28 days for delivery.

## In The Workshop

Tony Duell maintains his Philips N1500 recorder

Here's the fix for the stock fault in N1500s (a cracked loading pulley, of course). You'll need the Philips N1500 service manual to follow this (and to actually do it!). You can get a photocopy from Mauritron\*. Numbers in brackets refer to parts on the main exploded mechanical diagram in the manual

Ok, on with the fix. The stock mechanical fault on N1500s is that the loading pulley (194A) cracks where the grub screw/nut fits, and the pulley then doesn't clamp onto the motor shaft extension (193). It slips, and the machine won't lace up. And you have little chance of getting a new pulley, or of finding a good one in another old machine.

There's a way round this, though - modify the loading pulley so that it's no longer held on by the grub screw. It's not that difficult, either.

1) Remove the top cover, cabinet and cassette housing as detailed in the service manual. Take out the video head disk and put it somewhere safe - that's another part that's impossible to get...

2) Remove the two micro switches (SK12, SK13) from the loading mechanism plate (176). Note the position of the insulating sheets. Remove the mechanism plate (176) itself.

3) If you have a later machine, with the safety cord running through the loading cord springs (109), then unhook the safety cord springs (182A) under the chassis, and pull the cord through to the top.

4) Remove the loading cord springs (109) from the lower drum, undo the grub screw in the loading pulley, and take off the old pulley. Unwind the loading cords (if they've not come off already), and remove them from the pulley

5) Undo the grub screw (195) in the shaft extension (193) and pull the extension off the motor shaft

6) OK, dismantling over. You now need to drill a 2mm hole through the shaft extension, at approximately the same height as the old grub screw position. The mark left by the grub screw should be visible. The easiest way to drill this hole is with a lathe (and a V-groove drill pad on the tailstock), but an electric drill in a drill stand will do if you don't have a lathe.

7) Put the pulley (194A) on the extension, with the hole in the extension at 90 degrees to the old grub screw position and the bottom of the pulley

level with the bottom of the extension. Shine a light through the pulley (it's translucent plastic) and the new hole, and mark the hole position on the pulley boss. Drill a 2mm hole through the pulley boss, using the hole in the extension to guide the drill through to the other side of the pulley boss.

8) Remove the extension from the pulley, and enlarge the holes in the pulley boss to 2.5mm.

9) Tap the hole in the extension with an M2 thread.

10) Refit the extension to the loading motor (M3) spindle. Fit the loading cords to the pulley - touching the end of the cord with a soldering iron will fuse the strands together, making it a lot easier to thread. Put the pulley over the extension, and fix it in place with two M2 x 6mm screws into the new tapped hole.

11) Following the service manual, refit the loading cord, safety cord, loading mechanism, etc. To get the micro switch timing right, you'll probably have to remove and refit the mechanism plate (176) several times, moving the shaft extension by a couple of teeth each time until it loads up correctly.

12) Refit the head disk, cassette housing and cabinet.

MAURITRON TECHNICAL SERVICES, 8 Cherry Tree Road, Chinnor, OX9 4QY (01844-351694, fax 01844-352554).

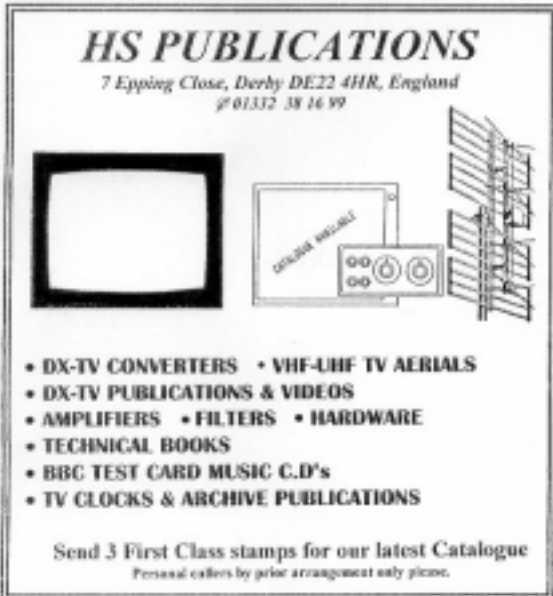

**HS PUBLICATIONS**  
7 Epping Close, Derby DE22 4HR, England  
☎ 01332 38 16 99

*GENUINE SERVICE*

- DX-TV CONVERTERS • VHF-UHF TV AERIALS
- DX-TV PUBLICATIONS & VIDEOS
- AMPLIFIERS • FILTERS • HARDWARE
- TECHNICAL BOOKS
- BBC TEST CARD MUSIC C.D's
- TV CLOCKS & ARCHIVE PUBLICATIONS

Send 3 First Class stamps for our latest Catalogue  
*Personal calls by prior arrangement only please.*



**In retrospect**

A couple of points regarding the 23cms TV transmitter article by Jon Cronk, GW3MEO, in CQ-TV 181.

In order to use the greyscale generator (fig. 4) with a 4MHz crystal instead of the specified 8MHz one, the following changes are required.

- Take the 60k resistor to pin 4 instead of pin 6
- Take the 27k resistor to pin 6 instead of pin 14
- Take the 15k resistor to pin 14 instead of pin 13
- Link pin 13 to pin 12 instead of pin 15 to pin 12

Also, there was an error in the circuit diagram. The 47pF shown across the crystal should be from pin 10 to ground or the crystal will not oscillate.

**Circuit Notebook No.62 Correction.**

**CQ-TV 180, page 74, Fig.1.** The resistor and capacitor values associated with IC2 should be 39k ohms and 1.0nF, not as shown. Apologies to any would be constructors and thanks to Richard, G4VCQ, for bringing this to my attention.

John Lawrence GW3JGA

**In Memoriam: Buster Beesley**

I am sorry to have to report the death, from cancer, of Basil 'Buster' Beesley on 16th August. Buster was a television man of long standing and of course a member of BATC.

Buster was a man of many talents and interests but technology - and electronics in particular - was his chief passion. His professional career took him through a number of companies in the backroom side of television, including Peto-Scott Ltd and KGM Vidiads.

Always willing to share information, he was a true hands-on engineer and a practical, down-to-earth sort of guy. Farewell Buster, you will not be forgotten.

**Andrew Emmerson.**

## 23cm ATV Transmitter, (part 2, the Amplifier)

### By Grant Taylor, ZL1WTT

The exciter stage feeds RF through the bandpass filter to the pin 1 input of the M67715 Hybrid Amplifier module. Pins 2 and 4 are the + 12 volt supply pins, with pin 3 as the gain control pin and pin 5 the final output.

The LM2941 regulator does 2 different jobs.

- 1) The PLL lock detect line is connected to the on/off control pin. When the PLL controlled oscillator drops out of lock, the bias voltage will drop and the TX amplifier will be shut down.
- 2) The bias voltage from the regulator controls the gain of the M67715. This is normally set at around about 4 to 6 volts and is adjusted by the 25k trimpot. The 7808 regulator feeds to the M67715 as well as the LM2914 regulator.

### PLL Section.

The Phase Lock Loop circuit is made up of 3 ICs from the 4000 CMOS series, consisting of a 4060, 4046, and 4059 and one J-Fet op-amp. IC1 is a 4060 which has a crystal reference oscillator formed around pins 10 and 11. The 4MHz signal is divided by 1024, producing a 3.90625kHz signal available at pin 15. This divided reference signal is supplied to IC2. IC2 is a 4046 which is used for its phase comparator section. IC2 feeds out the dc control voltage via an R-C integrator off pin 13. The lock detect signal comes from pin 1 through a second delay circuit to the op-amp (IC 4). The unused parts of this IC are powered down by a control pin to reduce power consumption and to remove any possible interference conditions generated by its own internal VCO circuits. IC3 is a 4059 programmable divider. A small sample of the 23cm oscillator signal is divided by 256 by the on board pre-scaler chip, and is fed to the input pin of this IC. The 4059 is set to the divide by 10 mode which allows programming in standard BCD. It divides its input frequency by the divisor set by the programming pins and outputs it's 3.90625kHz result (when in lock) to the 4046 for comparison against the divided down reference signal. By changing the logic states applied to the programming pins of the 4059, the TX frequency can be set to any frequency in the 1200-1299 range in 1 MHz steps.

Some example 23cm frequencies --

1250 MHz	0001,0010,0101,0000
1281 MHz	0001,0010,1000,0001

23cm ATV Transmitter, (part 2, the Amplifier)

IC4 is a TL071 op-amp that provides a high impedance load for the integrator section and supplies the resultant control voltage back to the VCO. This circuit is based upon the prototype circuit currently in use.

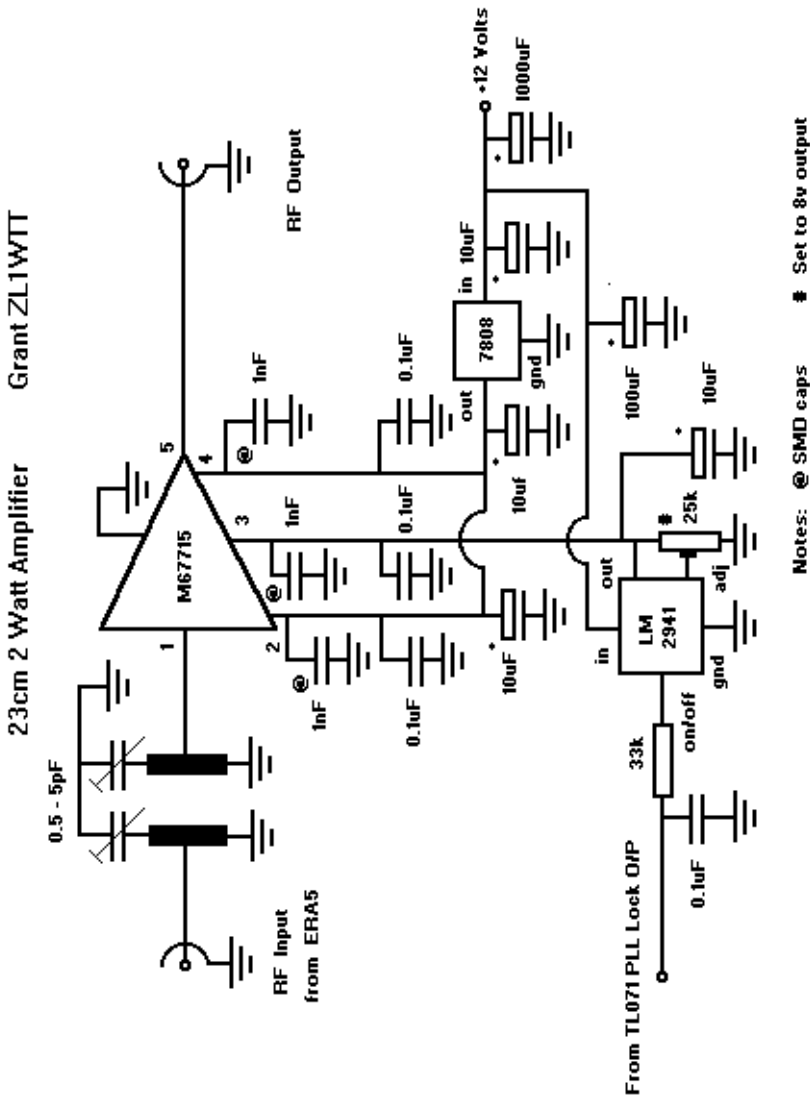

23cm FMTV TX PLL Grant ZL1WTT Ian ZL1VFO

version 1

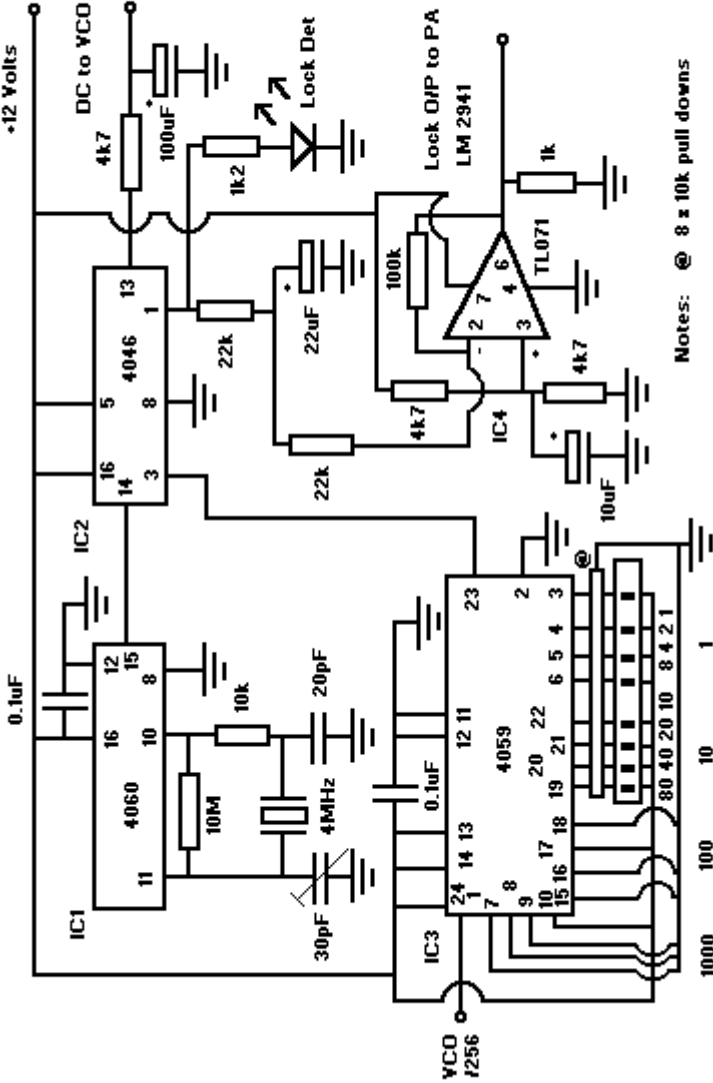

Notes: @ 8 x 10k pull downs

Frequency control DIP switches 1200-1299 MHz

DRAWN BY MICHAEL SHEFFIELD ZL1ABS

# DIGITAL FREQUENCY DISPLAYS

*The DFD series of Digital Frequency Display Kits is a range of microcontroller based units with a whole host of features. From a stand-alone frequency counter up to 3 GHz, to a user programmable package with enough features to blow your socks off.*



**DFD1:** A high-quality microcontroller based unit capable of measuring up to 32 MHz as a basic unit (up to 8 GHz with prescaler), or by setting an offset with a trimpot it can be used as the freq display of a TX or RX by  $\pm$  the offset from the LO. 16 character LCD with 100 Hz resolution - e.g. 14.257 MHz USB - the mode is set by external R's and can be programmed for AM, FM, CW, USB, LSB, FSK, FAX or left blank.

**DFD2A:** This unit has a similar specification to the DFD1 but with an enhanced resolution of 10 Hz. Modes available are also as the DFD1 but without SSB.

**DFD3:** A remarkable unit with an EEPROM at its heart and a flicker free 10 Hz resolution. This device, by simply connecting to the VCO of your radio, can display the exact transmit/receive frequency. Any offset from the selected frequency due to crystal drift can be calibrated into the EEPROM where it is stored for eternity.

The only external components required are one 10k pot, one SPDT biased centre-off toggle switch, three SPST pushbuttons, two 10k resistors and one 1k. These components allow selection of the various display and programming modes of the device.

BUT THE MOST REMARKABLE thing about the DFD3 is that it will program itself for many popular radios. Already stored in the EEPROM is the data for over 75 of the most popular radios on the market, and if your radio is not on the list you can easily program the data in.

**DFD4:** This unit has a built-in prescaler which is good up to 3 GHz. It has 4 modes of operation:

- MODE 1 HF FAST: max input frequency 30 MHz, resolution 10 Hz, gate time 0.1 sec
- MODE 2 HF SLOW: max input frequency 30 MHz, resolution 1 Hz, gate time 1 sec
- MODE 3 UHF FAST: max input frequency 3 GHz, resolution 1000 Hz, gate time 0.128 sec
- MODE 4 UHF SLOW: max input frequency 3 GHz, resolution 100 Hz, gate time 1.28 sec IF offset is programmable from  $\pm 0$  to 2 GHz in 1 kHz steps.

#### Back Lit Versions

DFD1	£42.46 + VAT
DFD2A	£43.50 + VAT
DFD3	£42.46 + VAT
DFD4	£51.17+VAT

DFD1BL	£50.46 + VAT
DFD2ABL	£51.50 + VAT
DFD3BL	£50.46 + VAT
DFD4BL	£66.17 + VAT



**Mainline Electronics, P.O. Box 235,  
Leicester, LE2 9SH**



**Tel: (0)116 277 7648/278 0891 Fax: (0)116 247 7551**

**Email: [sales@mainlinegroup.co.uk](mailto:sales@mainlinegroup.co.uk)**

## Name That Old Camera! (answers)

### By Dicky Howett

- 1.The EMI Emitron of 1937. Iconoscope type pick-up, high velocity picture tube. Needed bags of light. Optical twin lens inverted reflex viewfinder. Lightning reflexes required to operate. Live TV upside down!
- 2.Emitron CPS Mk 1. 1947/48. Orthicon type pick-up tube. First used by the BBC on murky o.b.'s. Camera unsteady on highlights. Quite sensitive to insults.
- 3.Emitron CPS Mk 2. 1951. Oddball six lens turret. 'Export' 625-line hopeful. Shown at the Festival of Britain in the Telekinema. No takers. (Trivia fans: This camera can be seen to advantage in the 1956 British movie 'Simon & Laura')
- 4.Emitron CPS Mk 3. (10764) 1956. Introduced into Lime Grove studio D, this camera was described by Richard Dimbleby as "the bee's knees". A huge camera, it produced a softish 'photographic' picture which didn't transfer well to the home receiver. Tilting viewfinder. Fingers got trapped often. Beer handle focus knob. This camera ended its days as an optical standards converter.
- 5.EMI 203. 4 ½" image orthicon. 1959 .The 'green box'. Mistaken often by amnesiac cameramen for the 201, which was an EMI vidicon and half the size! But does size really matter, or have you forgotten?
- 6.Marconi Mk 1. The first Marconi tv camera, introduced in 1949. A 3" image orthicon camera based entirely on RCA blueprints of the RCA TK30 'field' camera. The slightly later Marconi Mk 1B was used at various boat races and the odd coronation.
- 7.Marconi Mk 3. 1954. Successful heavyweight 4 ½" image orthicon camera with tilting viewfinder and omnipresent beer-handle focus. Camera was the mainstay of monochrome ITV and 'Ready Steady Go!'.
- 8.Marconi Mk 4. 1959. World-beating 4 ½" image orthicon. Over 900 channels sold world-wide, including 44 in one chunk to CBS TV in New York and Hollywood.
- 9.Pye Photicon. 1949. Lunky old machine with a laboriously slow motorised 4-lens turret. Camera boasted a high-velocity miniature super iconoscope. (Photographed 'Quatermass II' in studio G). Later

versions, called 'Pesticons' used pea lamps in the tube to counteract bouncing electron 'shading'. Mostly successful.

10. Pye Mk 3. 1951. Well-regarded compact (but not lightweight) 3" image orthicon camera, used almost exclusively by ATV and STV. A lot of remote controls, taking this camera way ahead of its time. Noisy electrical turret. Big focus wheels on both sides. Boon to left-handed camera chaps.

### **Further invaluable information:**

Only one 1937 EMI standard Emitron camera channel exists. There is a further complete head and a few bits and pieces. These priceless items reside at the BBC and the National Museum of Photography, Film & Television. One 1949 EMI CPS Emitron Mk 1 exists down at the EMI Labs. Nothing remains of the ill-fated 1951 Emitron CPS Mk 2 six-lens turret jobby. A couple of 1956 EMI CPS Emitron Mk 3's remain. The author himself has three green EMI 203's and at least three others are alive and well. Only one 1949 Marconi Mk 1 exists, cared for by a BBC engineer. Three other later Mk 1B versions exist to delight us all. Three Marconi Mk 3's are active, one in full working order. At least five Marconi Mk 4's are present and correct. Two are running well.. Alas, the poor old 1949 Pye Photicon Mk 1 is extinct. Only one small lens survives. Nothing remains also of the Pesticon Mk 2 variants. Happily, the modest Pye Mk 3 is extant and there are at least six examples to amuse and amaze us.



Post and News



Please send all correspondence for **Post and News** to the CQ-TV Editor. Ian Pawson, 14 Lilac Avenue, Leicester, LE5 1FN, England.

Tel: 0116 276 9425.

E-mail [editor@batc.org.uk](mailto:editor@batc.org.uk)

Members sales and wants should be sent to the editor at the above address.

Trade adverts should be sent to the advertising manager,

Chris Smith,

E-mail [adman@batc.org.uk](mailto:adman@batc.org.uk)

Dear Paul,

I'd like to officially inform you about foundation of Polish Amateur Television Club. The PATC was found to co-ordinate activity of local group, concerned in amateur television in Poland. There are two general groups: in Warsaw and in Walbrzych. We have here also a few little local groups, activate in amateur television. We are very interested in all kind of co-operation with British Amateur Television Club.

Yours sincerely

Cezary Maluj SP5XVM

=====

SP5XVM Cezar

e-mail [sp5xvm@friko4.onet.pl](mailto:sp5xvm@friko4.onet.pl)

P.O.Box. 4, 05-555 Tarczyn, Poland

=====



FROM THE INTERNET

Dead medium: The Fisher-Price Pixelvision

From: LangiG@parl.gc.ca (Greg Langille)

Source: "Film and Video Umbrella"

(<http://www.beyond2000.co.uk/umbrella/>) personal experience

A few years ago I purchased a Fisher-Price PXL 2000, a relatively cheap video camera that recorded on standard audio cassettes. I've found it very difficult to find information about it. Fisher-Price just says, "We can tell you that this product was introduced in 1988 and discontinued in 1989. There is no repair service or parts and we do not have any informational pamphlets available to send." So, it definitely is dead.

However, on the web site of "Film and Video Umbrella" (<http://www.beyond2000.co.uk/umbrella/>), a curatorial agency funded by the Arts Council of London, there is a good description of the technology, which is still in use by (primarily experimental) artists today:

"In 1987, U.S toy manufacturer Fisher-Price introduced the latest addition to their range of children's products: a lightweight plastic video camera, called the PXL 2000, which retailed at a cost of just under \$100 and recorded its endearingly rudimentary black-and-white images, at ultra-high speeds, on to a standard audio cassette. Loudly trumpeted as a kind of My First Movie Camera for the younger members of the video generation, it was confidently assumed that the PXL 2000 would go down a storm with legions of junior Spielberg wannabes, but instead, like many an apparently sure-fire success, it sank like the proverbial stone. Raised on the production values of MTV and Hollywood, America's vid-kids were less-than-captivated by what they could muster from the unmistakably low-tech (and none-too-durable) PXL. After only one year in production, Fisher-Price withdrew the camera from the shops and consigned it to the company bin.

"Since then, though, the PXL 2000 has enjoyed a remarkable, and quite unexpected, afterlife on the fringes of the US independent scene; adopted by an increasing number of film-makers and video-artists for its unique visual properties. As the last few years have shown, in the right hands and with surprisingly minimal fuss, this crude and clunky children's toy is capable of yielding some truly astonishing results.

"No matter how poor the light, the camera lends a distinctively hazy, dream-like quality to almost everything it shoots accentuated by a ghostly optical shimmer when anything passes too quickly across the screen.

Contrastingly, the simple fixed-focus lens lets one get uncannily close to people or objects, miraculously registering both detail and depth. Even more strikingly, the images produced reveal an extraordinary sense of intimacy and spontaneity, as well as with a desire to experiment that is no doubt encouraged by the ridiculously small-scale costs.

“This Film and Video Umbrella touring package highlights a number of recent works by most of the leading figures in the still-expanding Pixelvision field (among them Michael Almereyda, Michael O’Reilly, Sadie Benning and Eric Saks) and gives British viewers their first real glimpse of the unabashedly low-definition but increasingly high-profile Pixelvision craze.

“Until now, PXL-generated work has been an almost exclusively American phenomenon, as none of the PXL 2000 cameras ever made it over to the UK. British enthusiasts may be interested to hear, though, that while the Fisher-Price model has been long discontinued, its original inventor is set to retrieve the patent, opening the release for a new, improved version later this year.”

So now it appears that Pixelvision may not be completely dead. I should mention that the camera I bought came with a small black and white monitor (about 3.5” screen) which the camera could be plugged into. This could be battery-powered (a modification done by the previous owner) and carried around - a precursor to the video screen on modern digital video cameras.

Unfortunately it died soon after I bought it. The camera itself is very light and uses six AA batteries and records both sound and audio. The tape is run at a very high speed (I think about six times normal cassette speed), so most of the audio includes a loud “whirr” from the camera itself. Also, mine needs a LOT of light ... basically direct sunlight only. But it works.

I should mention that I paid \$200 Canadian in 1994 to buy it from a guy who said he used it for skateboard videos. It came with instructions from a hacker magazine for modifying the lens to use infrared light! For about \$20 you could actually get it to work as a night vision camera! There must be a whole subtopic of dead media concerning unintended uses.

(Moderator’s remarks: the Pixelvision is perennial collectors’ darling, and if it somehow reappears in the mass market, it might make quite the investment opportunity the second time around.).

## **Contributions**

If you have any snippets of news or information, then please send them in to my the editor either by snail mail or email

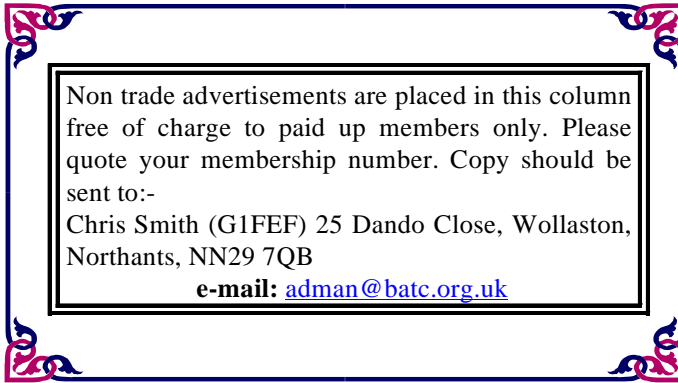

**FREE:** To anyone, a Heathkit O-12-U oscilloscope including build specification and circuits. When last powered up the spot was the size of a golfball! Also an Advance OS2200A storage oscilloscope with instruction manual and circuits. This unit is faulty and will need a bit of work to get going. Could possibly deliver if not too far from Eltham in S.E. London.  
*Stephen McGuigan G8MFI QTHR*

## For Sale

Ex Broadcast Tektronics 521A vectorscope, complete with manual. This is working, but the CRT is a bit low (of course!). However it is still quite useable and will probably do for many years in amateur service. Only £30, but at this price the buyer collects. (Coffee and welcome provided) or arranges carriage. *Contact Tony Jaques, G3PTD. Email: [tjaques@clara.net](mailto:tjaques@clara.net), phone 0181 865 9398*

FOR SALE: Link 109A top quality broadcast-spec b/w caption camera. Genlock and mixed sync inputs, takes C-mount lens (selection available). Clean, working – any offers? Or will swap for stage lighting equipment. *Andy Emmerson G8PTH, tel 01604-844130, fax 01604-821647 or e-mail [midshires@cix.co.uk](mailto:midshires@cix.co.uk)*

Philips LPL 1000 reel to reel video recorder (precursor of Philips N1500).  
Philips N1700 video head, Pye M290 series ex-PMR hi-band vhf rigs.  
Offers invited for the above. *Contact David Smith on 0141 632 5408*

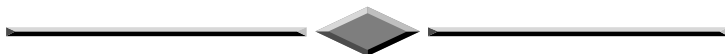

Two Taylor Hobson MRL Varotal zoom lenses in transit cases together with set of lens extender adapters; lenses designed for IVC 7000P camera but probably adaptable to others. Set of saticon tubes for BVP3 camera. JVC KY-2000 camera + CCU + cables. Very clean BVH 500 portable 1" VTR and manual. Loads of other manuals for BV-something machines, also some test gear. All fairly cheap to clear but sensible enquiries only please. *Contact Chris Evans, Macclesfield, on 01625-820000.*

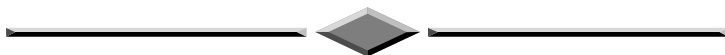

Altron 4 Section Telescopic Tiltover Mast (AT41PM) with Winch & Ground Post, Raised to 54ft.Dismantled. £200-00 (Can arrange delivery if required) *Contact Roger Aston 01733 242105 (Peterborough).*

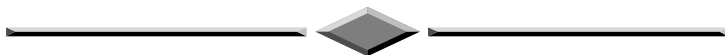

**From members Services:** - Please note that the 'call sign' specific I<sup>2</sup>C EPROM's are no longer available. A standard version will be supplied in future.

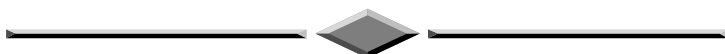

JVC GRS707 S-VHS-C camcorder, auto & manual everything, complete with 4 batteries, discharger, and hard case. £500 Olympus VX-303 camera, with separate VHS recorder (12v), and separate tuner. £115 (ish) Merlin vision mixer, 2 built-in frame-stores, needs attention. £150 Panasonic Character Generator VW-CG1E, designed to mount on a camcorder and connects between the viewfinder and camcorder itself, also has BNC in & outs. £15 Marconi picture/waveform monitor, Big and Old, £1. Buyer collects! *Contact Jeremy Power GIWVK (01442) 384716. E-Mail [jjpower@media68.nildram.co.uk](mailto:jjpower@media68.nildram.co.uk)*

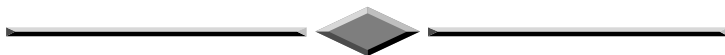

BASIC TELEVISION. Principals & Servicing. Bernard Grob. McGraw-Hill 1949. Technical book with lots of illustrations of US television (cameras, colour) in the 1940's. No d/w. £10 TECHNIQUES OF TELEVISION PRODUCTION. Rudy Bretz. McGraw-Hill. 1953. 1st ed. Swimming in TV production pictures/studios/cameras/ob vans/transmitters/you name it! No d/w. £8. TELEVISION PRODUCTION HANDBOOK. Herbert Zettl. 2nd ed 1968. This American book on tv is absolutely dripping with pictures of cameras, pedestals, lenses, microphones, vt machines. 541 pp. Virtually mint interior. No d/w. £8 INDEPENDENT TELEVISION ENGINEERING FOR COLOUR Pat Hawker 1970. Well illustrated ITA technical publication showing ITV colour tv development. Scarce. £8 SEE IT HAPPEN. Making of ITN. G.COX.. Fascinating account of the start of ITN. Illustrated. d/w. £5 THE TECHNIQUE OF TELEVISION PRODUCTION. Millerson. 1979. Illustrated. £5. All items in VGC. Postage minimum £1. **Contact Dicky Howett. 01245 441811. Email: [Dicky.Howett@btinternet.com](mailto:Dicky.Howett@btinternet.com)**

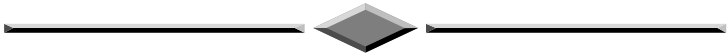

Complete fully operational 70cms ATV system consisting of:- VHF Comm ATV-7010 ten watt Vestigial sideband Vision transmitter with 6.0Mhz fm sound channel. (Uses low level modulation for sound and vision.) Microwave Modules MML 432/100 linear 100 watt amplifier. R.N.Electronics inline masthead GaAs FET Pre-Amplifier. Microwave Modules up converter from 70cms to Channel 37 UHF TV band. Two, twenty one element Tonna 70cms antennas. One thirteen element 70cms antenna. £299.00. Buyer collects. **Contact Derek Whitehead, GW3FDZ on 01 341 247343 after 6.00PM or Email [dgwhite@enterprise.net](mailto:dgwhite@enterprise.net)**

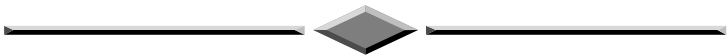

JVC GC-3300E colour camera with zoom lens and Power supply unit. Complete, but faulty (EHT?). No investigation of fault or attempt to repair, since fault developed. Boxed. Free to anyone who would like to pick it up or pay carriage. **Contact Colin Redwood, G6MXL Tel: 01202 665284 or Email [colin.redwood@lineone.net](mailto:colin.redwood@lineone.net)**

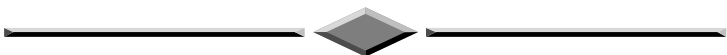

JVC707 Camcorder King of S-VHS c/w accessories and 3 batteries - immaculate. All functions manual or auto (inc. time lapse!). I have 2 on offer with instruction books (one is boxed) £490 or £900 the pair.

## Wanted

Videotech VMX410 video/audio mixer - does virtually everything including chroma key, used 3 times - boxed as new £525. Panasonic VMX50 video/audio mixer (boxed with manual) - brilliant £1600 **Contact Keith Friday Tel: 01203 502500 after 3:30 (Open to sensible offers)**

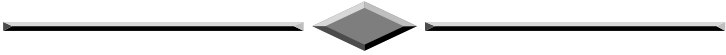

Various 1960 to 1980 colour and mono TV's, VCR's, audio equipment, speakers, tape recorders and radio's. Also several unused (regun) 1970's colour CRT's and many panels, knobs, parts, etc. **Phone for a list or with specific 'wants'. Contact Dave Hazell Tel: 01793 765390**

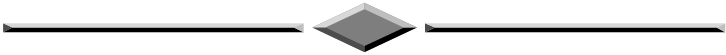

## Wanted

WANTED: 14" Pye picture monitor, either multi-standard or 405-only. **Andy Emmerson G8PTH, tel 01604-844130, fax 01604-821647 or e-mail midshires@cix.co.uk**

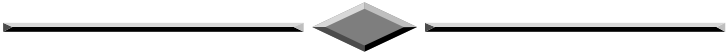

I am attempting to put together an Avitel and Drake distribution rack. I require Avitel Vision D.A.s and Switcher cards. Drake Audio switcher, sound D.A. cards and tone generator module if such a thing exists, also extender board and handbooks on any of these modules.

Cox VTR clock Does anyone have an extender card, handbook and or know how to change the custom logo.

VPR 2 parts. I require suitable waveform monitor, vectorscope and a reasonable SPG and any other spares. **Contact Trevor Brown on 0113 2670115, email: [batc@csi.com](mailto:batc@csi.com)**

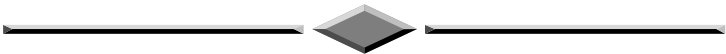

Wanted. Information regarding the replacement of corrupt software on an otherwise functional Rank Cintel Slidefile. Rank Cintel have changed their name to Cintel International and no longer support Slidefiles of '89/91 vintage. The problem I have is that the 8-inch winchester no longer

contains the programme that is required to operate the system. The Slidefile has a tape streamer that can be used refresh corrupt software providing a suitable streamer cartridge with the right software is available and the Winchester programme that controls this operation is functional. If it isn't there is a method whereby a host computer can be connected to an unused serial port. It is on these latter options that I would appreciate any suggestions or advice readers might be able to offer. **Contact Paul Pitts, Media Services (TV), The University of Leeds, LS2 9JT.**

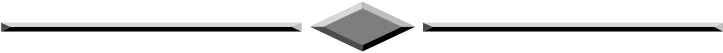

Murphy 'Astra' series mono TV with VHF/FM radio (models V689, V683, V783 and V789 - circa 1961-2). Ferguson 22B5 colour TV (Thorn TX10 mark 3 "TX Professional", with separate speakers). Ferguson 3148 AM/FM transistor radio. Ferguson 3020 record player and the associated SA102 add-on stereo amp/speaker unit. Knobs for Pye FenMan II radio. Original service manual for Sharp VC9300H VHS VCR and Ultra 1984c mono TV. Most 625/UHF convertible early 1960's TV's (or just the conversion kits). Murphy B585 portable AM/FM transistor radio. Murphy "Service News" bulletins. Sinclair "Black Watch". Heathkit MM1U multimeter (or meter movement only). **Contact Dave Hazel Tel: 01793 765390**

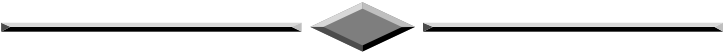

Service manual for Barco receiver/monitor type CRM2032 (3200 series). Also require Camera/CCU connector cable for a Hitachi FP1500 Colour camera (Hirose type connectors). I am also looking for the following tape recorders: Leavers - Rich and EMI (BTR2, 311 series, RE301 (TR52) & RE321 portable). **Contact Terry Martini Tel: 0171 702 8774 / 0171 251 3196 or Email [terrym@globalnet.co.uk](mailto:terrym@globalnet.co.uk)**

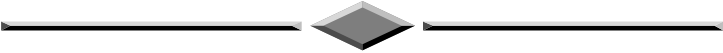

Source of obsolete but useable 5 1/2" floppy disc drives. **Contact Doug Pitt Tel: 0115 9282896**

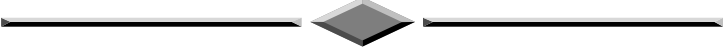

Laser disc to demonstrate Sony video disc player. LDP180P **Contact Peter Smith G4JNU Tel/Fax: 0118 9477573**

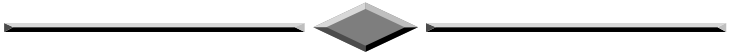

Circuit for EMI scope M101, Advance signal generator E2/SGG2, H/Kit IM22, Monitor Telonic M121. **Contact D. Griggs G01PT Tel: 0181 883 3474**

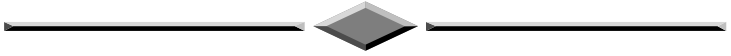

Part Two LINK 110 handbook. Also IKEGAMI 79D camera parts. Especially needed, power leads, batteries. Sync, DTL and coder boards  
**Contact Dicky Howett 01245 441811. Email: [Dicky.Howett@btinternet.com](mailto:Dicky.Howett@btinternet.com)**

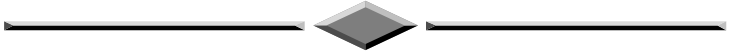

10 GHz transverter suitable for upconverting a 145 MHz FM TV IF to 10 GHz. Exact input frequency not critical but output must be crystal controlled. **Contact Ian Bennett G6TVJ Tel 0117 9793883 E-mail [ian.bennett@cableinet.co.uk](mailto:ian.bennett@cableinet.co.uk)**

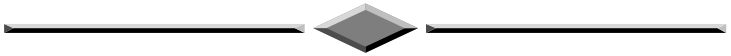

## Index of Advertisers

BATC order our CD.....	59
Caladan Communications .....	34
GB3XT Kits and Bits.....	23
HS Publications.....	77
<b>Mainline Electronics</b> .....	81
Sevenside Television Group .....	74
VHF Communications .....	72
Worthing & District Video Repeater Group .....	69

