

Contents

Contents	1
Committee Contacts.....	2
Chairman’s Column.....	3
Shuttleworth ’99 - The BATC 50 th Anniversary Event.....	4
Dielectric antenna for 3cms.....	7
The Cox 350 VTR Clock	8
A Service to Members	9
The IARU Region 1 Microwave ATV standard.....	10
CQ-TV Commercial advertising rates.....	10
Marconi Centenary Celebrations	11
A Story of Wimereux and South Foreland Lighthouse.....	13
Proposed changes to the BATC Constitution	13
PI6ALK Dutch Amateur Television Repeater On Satellite - Latest!.....	14
A 10GHz ATV Repeater for East Yorkshire	16
The British Amateur Television Club 1997 Accounts	18
Circuit Notebooks Remembered.....	19
Deadline.....	24
NBTV Tape Timebase.....	24
Random Musings	26
TV on the Air - Shuttleworth Edition	28
ATV contests - yes or no?	29
UHF TV Masthead preamp.....	31
BATC Publications	32
Members’ Services	33
Two Filters and a Diplexer for 23cms	36
Low cost on-screen text generator	40
Satellite TV News.....	42
A Power Meter for Microwaves	42
PYE Down Under.....	44
Where have all the G6***/T gone.....	45
The BATC Big Breakfast.....	46
Review of Electronic Designs Videomaker Card.....	47
What a Fine Bunch of Chaps	49
Using a Timebase Corrector.....	50
70cms ATV?	52
Photo Gallery.....	55
On the way to DATV	56
My First BBC Television Experience.	57
Post and News	58
Members adverts.....	62
Index of Advertisers.....	64

Edited by Ian Pawson, circuits drawn by Allan Robinson, proof read by Peter Delaney. All rights reserved, all wrongs denied.

Copyright © 1999 by the BATC and contributors.

Notice to Contributors

Authors are alone responsible for the content of their articles, including factual and legal accuracy, and opinions expressed by them may not reflect the editorial stance of the publication. Material submitted to CQ-TV should not infringe the copyright of other writers or bodies. Articles remain the copyright of their authors and following publication in CQ-TV, they may also appear on the BATC's web site and CD-ROMs, also in other not-for-profit amateur publications. Contributions are accepted for publication on this basis alone.

Printed by *Cramphorn Colour Printers Ltd.*, 15c Paynes Lane, Rugby, CV21 2UH, England. Telephone: 01788 577781.

Committee Contacts

BATC Chairman: Trevor Brown, G8CJS

Club affairs, Video tape library, Technical queries, especially relating to handbook projects. 14 Stairfoot Close, Adel, Leeds, LS16 8JR. Tel: 01132 670115. E-mail: chairman@batc.org.uk

BATC General Secretary: Paul Marshall, G8MJW

General club correspondence and business. Library queries relating to the borrowing or donation of written material. Fern House, Church Road, Harby, Notts., NG23 7ED. Tel: 01522 703348. Email secretary@batc.org.uk

BATC Hon. Treasurer: Brian Summers, G8GQS

Enquiries regarding club finances, Donations, and constitutional enquiries. 9 Prior Croft Close, Camberley, Surrey, GU15 1DE. Tel: 01276 677879, Mobile: 0797 0417875, Email: treasurer@batc.org.uk

CQ-TV Magazine: Editor Ian Pawson

Anything for publication in CQ-TV, Articles, Review items, Letters to the editor, and other material except as below. 14 Lilac Avenue, Leicester, LE5 1FN, England. Tel: 0116 276 9425, Email: editor@batc.org.uk

Photographs for the CQ-TV covers: - Please send any photographs by post, electronic images by email, to the editor at the above addresses.

TV on the Air: - Graham Hankins G8EMX, 11 Cottesbrook Road, Acocks Green, Birmingham, B27 6LE. Tel: 0121 707 4337

Satellite TV News: - Paul Holland G3TZO, Chatterton, Chapel Lane, Thrapwood, Nr. Malpas, Cheshire, SY14 7AX. Tel: 01948 770429, Email: satnews@batc.org.uk

CQ-TV Advertising Manager: - Trevor Brown, 14 Stairfoot Close, Adel, Leeds, LS16 8JR. Tel: 01132 670115. Email: adman@batc.org.uk Members adverts for inclusion in CQ-TV should be sent directly to the editor and the above address, either by post or e-mail.

CQ-TV Awards: - Bob Webb G8VBA, 78 Station Road, Rolleston on Dove, Burton on Trent, Staffs., DE13 9AB. Tel: 01283 814582

Exhibitions

Mike Wooding, G6IQM, 5 Ware Orchard, Barby, Nr. Rugby, CV33 8UF. Tel: 01788 890365, Fax: 01788 891883, Mobile: 0860 857434 Email: rally98@batc.org.uk

Club Sales

Members Services: - PCB's, components, camera tubes, accessories, etc. (NOT PUBLICATIONS). Peter Delaney, G8KZG, 6 East View Close, Wargrave, Berkshire, RG10 8BJ. Tel: 0118 940 3121

Publications: - Handbooks, Back copies CQ-TV, and anything related to the supply of BATC publications. Paul Marshall, Fern House, Church Road, Harby, Notts., NG23 7ED, England. E-mail: publications@batc.org.uk

Membership

Anything to do with membership, including new applications, queries about new and existing membership, non-receipt of CQ-TV, subscriptions, membership records, data protection act. Dave Lawton, G0ANO, 'Grenehurst', Pinewood Road, High Wycombe, Bucks., HP12 4DD. Tel: 01494 528899. E-mail: memsec@batc.org.uk

Club Liaison: - And anything of a political nature, co-ordination of ATV repeater licences. Graham Shirville, G3VZV, The Hill Farm, Potsgrove, Milton Keynes, Bucks., MK17 9HF. Tel: 01525 290343. E-mail g3vzv@amsat.org

Contests:- Richard Guttridge, G4YTV, Ivy House, Rise Road, Skirlaugh, Hull, HU11 5BH. Tel: 01964 562498

Repeater Liaison: - General enquiries and repeater affiliation. Graham Hankins G8EMX, 11 Cottesbrook Road, Acocks Green, Birmingham, B27 6LE. Tel: 0121 707 4337.

BATC web master

Anything to do with the BATCs web site. E-mail: webmaster@batc.org.uk

Chairman's Column

A lot has happened since our last magazine. First the rally - at a time when others are cancelling their rallies for lack of traders, we decided to run ours. Yes, trader numbers were down, and we knew at the outset that we were unlikely to make a profit, but so long as there was enough activity to make it work we decided to go ahead. I am pleased we did. No, we did not make a profit, but the loss was under £10 and the event went well and brought at least two visitors from Holland. I think we all owe Mike a vote of thanks for all his hard work. From my point of view, I got up at 4 am to drive a van full of donated BBC equipment down, along with Paul Marshall having driven to Belfast to collect it some weeks earlier. No sooner had we unloaded the van than Brian had me out on car park duty, which I found very pleasant, talking to members, and got quite a warm feeling from being recognised; sorry if I do not know you all by sight.

Because I drove a van down and back the UKRS did not leave their greeting letter on my windscreen and it was some time later that Graham Shirville sent me his. Yes, there have been requests for further packet allocations within 70cms - CQ-TV had already been printed, but not posted when the RSGB news announced the new allocations. The committee decided not to add a letter to the magazine, and yes, UKRS, asked if we would and offered to share some of the cost. What we were doing was not nothing as has been suggested, Graham had already been experiencing communication problems and I had already written to the RSGB president on his behalf. (See the letter on page 53. I have had a reply from the president on page 58. I don't want to dwell on where the communications went wrong and I do not want to see rocks being thrown at Graham Shirville; he has attended to RSGB matters all the time I have been Chairman, Graham has attended all the IARU conferences in that time, and at his own expense. On June 12th he and I will both attend VHF CC and see if we can resolve this problem. The offer from the RSGB president to write a getting started article has been taken up by Ian Waters and Graham Hankins is going to write the two monthly columns.

The next IARU is at Lillehammer and Graham will again be there. There is a proposal from PA0EZ that all ATV FM operation on 1.3 to 10GHz must not have any sound subcarriers, but must use a new and not defined digital sound in sync 15kb channel instead. Yes we are opposed to it; the current subcarrier sound works well, uses simple circuitry and is compatible with current broadcast receivers. Sound in sync would mean all the repeaters need re-engineering.

Did any of you see the 'Big Breakfast Show' with 6 minutes of the BATC. The request to provide team for the show was made at short notice. I would like to thank Dicky Howett, Roy Powers and Mike Sanders for getting along to the studio and onto a programme that would probably send them up a little. Brian Summers declined and said he would rather run naked in the streets (save it for the cricket, Brian). The programme insert ended with a Big Breakfast web site address and telephone number for



Let's move on to better things from Holland. PA0ALK the Dutch ATV repeater is currently on satellite using MPEG 2. The details are not quite as they were announced on the RSGB news, (see the email section). By the time Rens had corrected the version I received from Norman Ash, it was too late to pass it back to the RSGB. PI6ALK is in Beacon mode during the day and repeat mode each evening. The repeat mode is quite something with a multiplex of 16 pictures at times; I am not sure how many of them are live. Rens also seems to have live email, so you can email him and ask for a wave and get an almost immediate response. I hope we can have pictures from the satellite live at Shuttleworth, Rens does not know how long he has the transponder for, so fingers crossed. I think the icing on the cake would be a two way - has anyone got any friends with transponders we can borrow for the event.

information on the BATC. The programme makers were to screen the response and pass the serious ones along to Paul Marshall, but as yet none have been received.

Last, but not least, Ian has asked all contributors to this issue to lay on some nostalgia to celebrate 50 years of the club. I will resist doing a Beyond TTL on Colossus. I have seen Circuit Notebook, but not Satellite News; will it cover Telstar (I remember it and the 9 minute window it gave into the USA (before stationary satellites). I have indulged a little on the passing of the G6 callsigns, but I will leave the rest to the real old timers.

Looking forward to seeing you all at Shuttleworth on August the 8th, I hope it will be an event we will all remember.

Trevor Brown, BATC Chairman

Shuttleworth '99 - The BATC 50th Anniversary Event

Backdrop to Shuttleworth '99

This year marks the 50th Anniversary of the British Amateur Television Club. We've come a long way in that time, from a club with a handful of members and a magazine typed on an Army typewriter to be an international organisation with nearly 2,000 members. The magazine is now published with DTP (DeskTop Publishing) and a further link to the membership via the World Wide Web. It might have surprised our founders that the club continues to thrive after 50 years and now with all this technology to play with!

Our Constitution allows us to defer the BGM (Biennial General Meeting) for up to three years from the last one. Last year would normally have been the two-year interval BGM, but taking advantage of the three-year ruling means that the 50th Anniversary can coincide with a BGM. This saves money (always in short supply) and concentrates attention!

The BATC Committee is pleased to be able to return to a former venue of ours (for CAT '94), Shuttleworth College in Bedfordshire. This was chosen as being affordable, having the right mix of facilities and being CENTRAL. From past experience of these events a balance has to be struck, and this is near the southern end of both the A1 and the M1 – it shouldn't be too difficult to get to for anybody in England or Wales. Even from Scotland, Ireland or overseas, the proximity to airports and main rail links should make it fairly easy.

Overview of the event

The event is scheduled to begin with the gathering of the faithful on the afternoon of the 7th August – an informal meet to set up for the next day, to chat and to socialise.

The evening of the 7th (Saturday) will see the grand 50th Anniversary Dinner served in the Russell Hall at the College.

A late bar will round out the evening and hopefully not cause too late a start to the next day!

For the 8th August (Sunday) a full programme of talks, videos, presentations and the BGM will take place in the Lecture Theatre.

Meanwhile, in the Russell Hall we hope to see many individuals, Repeater Groups and other organisations represented. Trading is allowed (indeed, encouraged!) but we hope that the event is more than this.

Entrance fee:

On the Sunday, there will be an entrance charge of £2.

This does not include the BGM – members wishing to attend only the BGM can do so by arriving after 3.00pm when no charges will be made.

Outside will be the larger exhibits, the OB units and also live links from nearby repeaters and from the Shuttleworth Collection next door.

Note that for those bringing a family, who might tire of our activities (really?), the Shuttleworth Collection of veteran / vintage aircraft and cars is very close and well worth a visit. In addition the Swiss Gardens are also close by.

Accommodation and catering

There will be no formal catering facilities on the Saturday afternoon, but there will of course be the evening dinner. Time: 7.30 for 8.00. **The dinner will be by advance booking only – see the 'Information' panel.** A late bar will follow, open to non-diners also.

Accommodation will be in the purpose built blocks in the grounds, or in the main Manor House. The accommodation in the grounds has been completely refurbished since CAT '94 and now offers fully en suite facilities. The Manor House accommodation is not en suite but does have a certain attraction of being in the Manor House itself. **Again, accommodation is by advance**

booking only – see the 'Bookings' panel.

On the Sunday, light refreshments and a light lunch will be available on a cash basis.

Subject to numbers involved, camping can probably be arranged – please ask the organisers for details.

Events on Sunday 8th August

- 10 00 Doors Open
- 10.30 Keynote Speech
Hello From the Mid Point
(Bob Platts and Ian Waters)
- 11.00 Links from GB3PV
- 12.00 RSGB (by your IARU member)
- 12.30 PIC Programming (Brian Kelly)
- 1.00 Early Days of Television (Grant Dixon)
- 2.00 The Cambridge Studio (Ian Waters and Andrew Emmerson)
- 2.30 Links from PI6ALK, Bob Robson, OB Trucks
- 3.30 Awards Ceremony
- 4.00 BGM
Chairman's Report
Treasurer's Report, adoption of accounts
Appointment of auditors
Committee Elections
Constitution changes
- Q and A
A chance to talk to your committee

NB. The BGM is the formal part of the day and as such all business conducted must be on the Agenda. The Q and A as such is not part of the BGM but we hope all your questions and suggestions can be received and dealt with.

Shuttleworth '99

Information at a glance

- When:** Informal gathering and evening dinner: Saturday 7th August 1999
Lectures, presentations, exhibition and BGM: Sunday 8th August 1999
- Where:** Shuttleworth Trust, Old Warden Bedfordshire.
- Accommodation:** For the evening of 7th August – any other times please enquire.
- Prices:** In the purpose built accommodation (all en-suite) and including breakfast: Double room: £66.50
Single room: £49.50
- In the Manor House (not en suite) but including breakfast:
Double or single £29.50 per person.

The 50th Anniversary Dinner:

Three course dinner (please enquire for details of menu) in the Russell Hall. Gather at 7.30 pm for 8.00 pm dinner.

Price: £16.50 per person

Bar: On the evening of the 7th, open until 12.00 pm

All enquiries, bookings and information:

Paul or Jill Marshall, Fern House, Church Road, Harby, NEWARK, Notts. NG23 7ED

Telephone/Fax 01522 703348 E-mail: secretary@batc.org.uk

PLEASE NOTE: Regretfully we cannot accept credit card payments for this event.

Yes, there will be a BATC Club Stand!

How to get there: please see the next page!

Want to exhibit, bring something along, sell something?

We would like to cordially invite Repeater Groups, other special interest groups, individuals and organisations associated with the British Amateur Television Club to exhibit or be represented in the Russell Hall as part of the exhibition. In addition, if you have something to sell (as a member or associated group, not a trader) you are welcome to use the tables provided in the Russell Hall – but please contact the organisers first!

Traders are welcome, cost by prior negotiation with the organisers – prices will be VERY attractive!

If you want to contribute to the day by exhibiting, demonstrating, selling or anything else please contact:

Trevor Brown (BATC Chairman) or Paul Marshall (BATC General Secretary)

EUTELSAT W2



GB3PV



PI6ALK



MID POINT
G80ZP
G3KKD



G8AGI

SHUTTLEWORTH
COLLEGE



O.B TRUCKS

HOW ARE YOU GOING TO GET YOU PICTURES
TO SHUTTLEWORTH 99
AUGUST 8 A DAY TO REMEMBER

Below: A road map showing
the Shuttleworth area



Dielectric antenna for 3cms

By Bob Platts G8OZP

Dielectric antennas provide a simple means of achieving reasonable directional gain in a compact unit.

and throwing it across the workshop. I know from experience.

I use 600rpm. Clear the swarf away regularly.

section of 23mm by 10.75mm. Then 50mm from one end shave down to a section of 6mm square.

The wooden former is then swaged (hammered) into the annealed end of

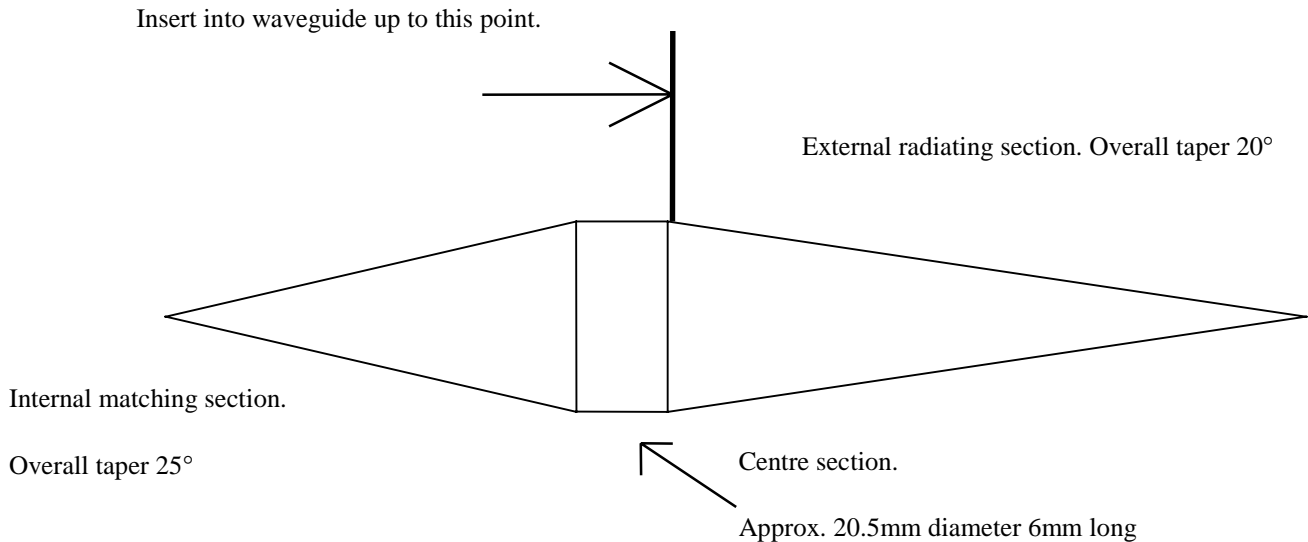

Dielectric antenna of about 20dB gain

They operate on the principle of refraction I shall not bore you with all the theory, its a bit heavy and to be honest my middle aged brain can't get around it as well as I could in my student days.

This design provides a gain of about 20dB with a match of better than 1.2 - 1 over the whole 3cms band.

The wave-guide is 22mm copper pipe which has a transition to WG16. The polarisation is the same as the feeding wave-guide.

The material should be Nylon 66 (PTFE may be used. It is more difficult to machine but provides improved performance). This is available from good engineering suppliers or RS Component and possibly Farnell.

Machine on a lathe very carefully with a sharp tool. Nylon 66 is naturally 'slippy'. This means it does not grip very well in the chuck. Also as it is flexible it can grab, digging the tool into the job, ripping it out of the chuck

The parallel section should be a tight fit into the 22mm pipe. This will keep water out. As there can be a slight variance in the internal diameter of copper pipe, measure first.

There is no point gluing it in, as glues don't stick to Nylon 66.

To convert the 22mm diameter pipe to the standard WG16 waveguide requires a transition. These are relatively simple to construct.

About 120mm of 22mm copper tube should be annealed for about half the length.

Heat it to dull red heat and allow it to cool.

Cut a 75 - 100mm long piece of hard wood to rectangular

the pipe. As this is done gently hammer the outside to form the correct size and shape to fit in a WG16 flange. Clean the pipe well before soldering into the flange. The other end may need trimming back if damaged during swageing.

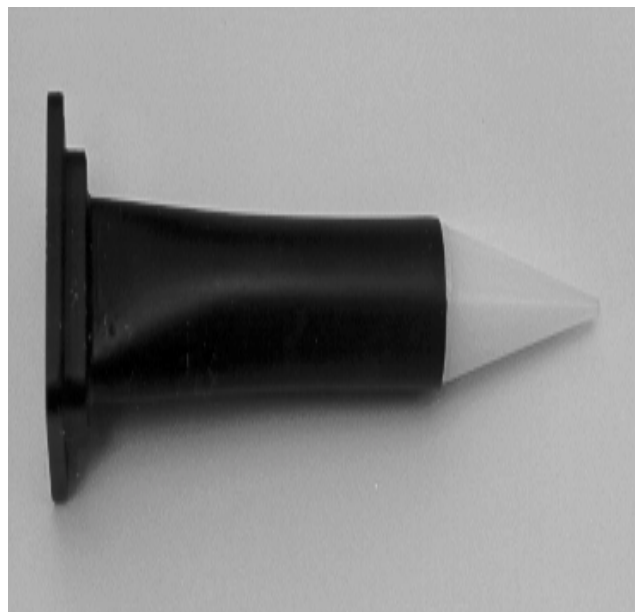

A completed 3cms dielectric antenna.

The Cox 350 VTR Clock

By Trevor Brown

The COX 350 was one of the first Electronic VTR clocks. It appeared in the late 70's and soon replaced mechanical clocks, on which production details were written with a Chinagraph pencil and held up in front of a camera. The design of the clock face is based on the ATV mechanical clock, but the Cox clock is an electronic video source. It is keyboard driven, production details are entered and the clock is started from a single keyboard often located in the production gallery. Because of this fears existed about possible industrial 'who does what' disputes. In an attempt to avoid this problem Cox used a non-standard keyboard that is ABC and not QWERTY. Many of these clocks turn up on the surplus market and can easily be pressed into service. They require a reference feed of mixed sync or colour black. They then produce a video output of the clock display, that can be started and have production details entered into the appropriate part of the screen from the keyboard.

The only downside to these very serviceable units is that they all come with the broadcasters' ident programmed into the bottom right of the screen. This is fine if you are a collector of broadcast antiquity, but if you want to remove this ident then the following may be of help: -

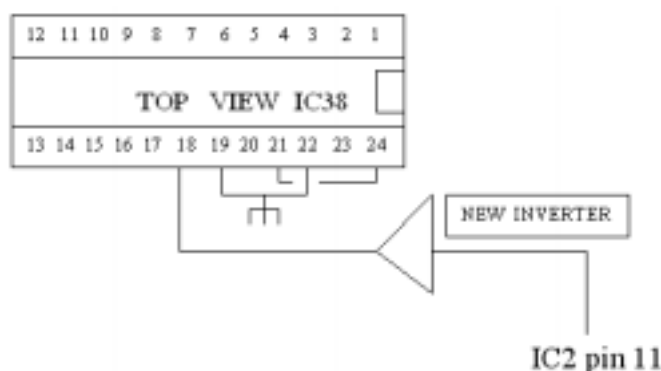

The Ident is programmed into a PROM (IC38) on board two, unfortunately you cannot simply remove this chip or the screen will be full of question marks. The PROM used for IC38 is also not re-programmable and is not pin compatible with a re-programmable EPROM. The 2716 is the nearest chip,

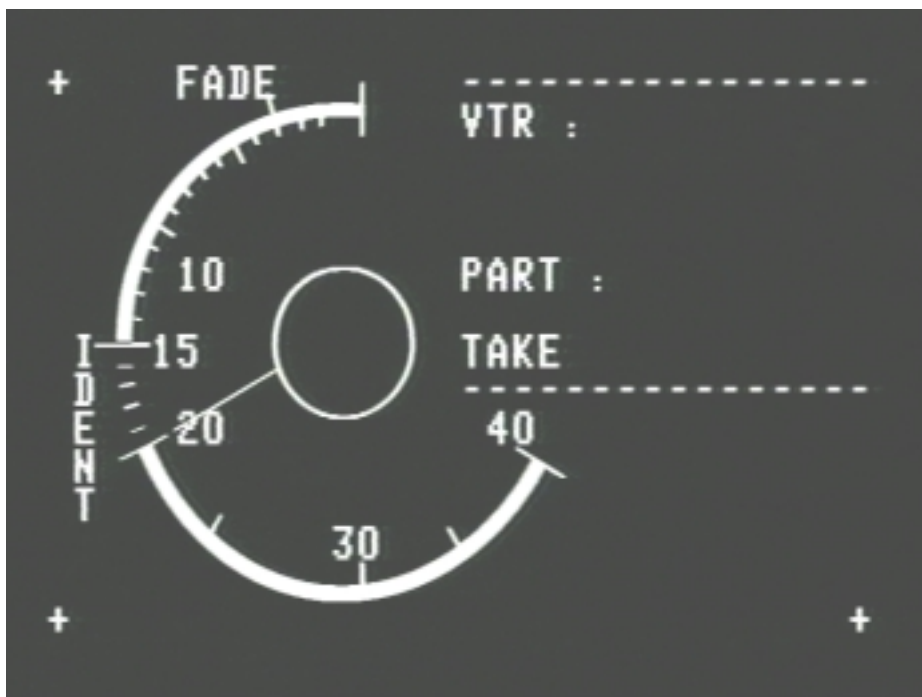

but some hardware modifications are necessary.

Pin 22, which is floating, needs grounding.

Pin 19 needs separating from pin 18 and grounding.

Pin 21 needs separating from pin 20 and routing to the +5V available on Pin 24.

Pin 18 is chip enable and on the old prom its active high and on the 2716 it is active low, so this feed needs an inverter in series with it. Look as I did,

I could not find a spare inverter gate on the PCB or something that would adapt. I solved the problem by the addition of a SN7404, out of the junk box - a SN74LS04 would have done. This additional chip was placed on its back adjacent to IC2 and wired to the +5V and ground. IC38's chip enable which goes to IC2 pin 11 is intercepted and routed via one of the inverters in this new package.

The PCB will now accept a 2716 EPROM. The EPROM needs

programming with all the clock face details and the custom logo can be omitted or changed at this stage. If you go to the clubs Internet site (www.batc.org.uk) you can download a file coxx.dat that has all the details of the clock face, but without a custom ident. If you want to add a custom ident of your own then this can be programmed in at location 01B0h and can be 16 characters or 8 large characters.

The EPROM is laid out so that bits 0 to 5 carry the character code in ASCII. Bit 6 is unused and bit 7 controls the line and field clocks of the character generator, and thus switches in the large character mode. If we programme in 41h a large font 'A' will result or C1h for a normal font 'A'. To understand this we need to change the hex digits to binary.

41 hex = 01000001 C1 hex = 11000001
i.e. the least significant bits are the same but bit 7 changes, when bit 7 is low a large font size is produced and when bit 7 is high a small font size is produced. The other characters follow on i.e. C2 = B and C3 = C and so on. The numbers start at F1 = 1 and F2 = 2 and so on, so yes you can programme in your callsign or telephone number.

My thanks to Andrew Jellyman, G8MKG, for his help on this project.

A Service to Members

By Peter Delaney

The BATC's Members' Services exists to help club members to obtain specialist components for amateur television projects, and grew out of a facility provided by the Hon Secretary of the day.

In the early 1950s, television camera tubes were not generally available. The 5527 iconoscope was made by RCA in the USA, and a 5527 camera chain was described in CQTV8, in March 1951, when the supply situation was also discussed, "but currency restrictions prevent import of these tubes - an extremely limited number of manufacturer's rejects are occasionally made available to BATC members. These are issued on the basis of what results have been obtained with simpler equipment, such as telecine or telestill."

(Most likely a flying spot scanner using a 931A and a CRT, as described elsewhere in CQ-TV by John Lawrence)

At that time these tubes were priced at £30, a licence normally being needed to import them. In July 1952, CQ-TV noted that 'import of 5527s for amateur purposes has stopped for the time being .. the Hon Secretary ... does not think there will be any easing of the situation for some time to come'

Fortunately, the situation was to ease. News of the month in March 1953 (CQ-TV 16) was that "a modern replacement for the ubiquitous 5527 is at last available to all who can afford it. Although the tubes are not perfect, they represent a great advance on the 5527, whilst at the same time they are not so complex as other BBC types of camera tube. It is to be hoped that many BATCs will be able to take advantage of this very kind offer. It will not be possible to sell these reject tubes, a British equivalent to the vidicon, at less than £25. The manufacturers are also prepared to sell reject monoscope pattern generator tubes at £6"

"There appears no limit to the number of tubes available, so anyone with a 5527, say, wanting a more advanced tube is invited to write in."

It was suggested that anyone who thus made a 5527 spare should offer it to other club members. At that time, of course, the only way for members to own a camera was to build it themselves.

By CQ-TV 24, the magazine announces that 'camera tubes are not normally available in this country, but the club has arranged for the supply of a vidicon type tube at £25, and monoscope tubes are similarly available at £7/10/-'

The range of camera tubes was increased in CQ-TV 55, when some 4½in image orthicon tubes 'used but in good order' became available. The Hon Secretary was also able to offer 'transistors, similar to OC180, but with a wide spread of characteristics' at 10/- per dozen, while stocks last.

The items on offer began to widen beyond camera tubes, and headed notepaper, lapel badges (buttonhole or brooch), and plastic equipment stickers could be ordered from the Hon Treasurer. Members requiring special components were 'invited to register their needs with the Hon Secretary - help will be given whenever possible, but this does not cover items which may be purchased in the normal way' in CQ-TV 57 - a principle that we still try to follow.

By CQ-TV 61, separate mesh vidicons had become available, at £10 each, but monoscopes now cost £7/10/-. Scan and focus coils could also be obtained - previously constructors wound their own. Those suitable for transistor circuits were £4/5/-, ex stock, whilst those suitable for valve circuits were to order at £5/5/-. Moulded vidicon bases were 17/6d ex stock - a paxolin version to special order being 5/-. To help camera builders, a C-mount (for the lens) was on offer at 8/6d. The lapel badges were 3/6d, but with callsign 5/-, and 100 sheets of 'Members Correspondence' notepaper with envelopes cost 15/-. A year later, the lists include 35mm filmstrips of 10 editions of CQ-TV, at 15/- (the 1960s equivalent of the CD-ROM!), whilst the EMI scan coils had risen in price to £6/10/-, or £6/15/- (depending on which page of the magazine you read!).

In December 1968, CQ-TV announced that the club had re-organised its officer posts. There was now to be a 'Librarian and Sales Officer', a task taken on by Grant Dixon (who had been Librarian immediately before that). From the following issue a 'Club Sales List', of the items available is given regularly - usually on the inside back cover. The items included widened under Grant's reign, with the Reporting Chart (CQ-TV 71), a choice of 4 different vidicon types from CQ-TV 73 (February 1971), as well as ex studio IO tubes. Windscreen stickers first appear 2 issues later, and an EEV test chart, priced £1.50 in 1973. The BATC's own test card, designed to suit the typical amateur transmission path, was introduced in November 1975.

Earlier that year, in CQ-TV 91, the first printed circuit boards are offered to members. These were for Arthur Critchley's sync pulse generator project, and were priced at £1.75 undrilled, or £2.75 drilled. The idea was to keep the price to members as low as possible, to encourage construction, a policy that is still followed, although all subsequent boards have been only available ready drilled! 2/3in vidicons, and the matching scan coils also appear around this time, at £11 each, whilst for 'moonlight capability' the EMI 9777 Ebitron could be purchased for £28 from November 1976, or an EEV Leddicon priced at £82 could be ordered in CQ-TV 99, in August 1977. The price of the printed circuit boards had risen by 1979 to £3 (drilled !), and the P100 PCBs added at £4 to the lists, for a new SPG. Other members' sundries available at that period included circular badges, key fobs and ties.

Grant continued to run the Club Sales until 1981, when the present occupant of the post took over. The range of PCBs began to expand, with the launch of the 'Amateur Television Handbook'. This added the 3-board colour test card, boards for 7 other projects, ICs and crystals to the stock list. With further club publications, the list grew to over 80 stock lines. Camera tubes became a less significant part of the service - as industrial or domestic type cameras became more widely available fewer

members built their own. With the adoption of CCD type imaging devices, the supply of camera tubes is almost as difficult as in the early days - EMI (our main supplier over the years) stopped production in the 1980s, and so all tubes have to be imported. Other items have also disappeared as stock items - notepaper and envelopes, for example, when the cost of postage and packing was more than the goods were worth! The printed circuit boards have developed to include through-hole plated, silk-screened boards that are very professional, the range varying as

new club projects are written, or components for old ones become obsolete. The name was changed to 'Members' Services' in the mid 1980s, partly to reflect what this aspect of the club tries to do, but also to indicate to HM Inland Revenue that we are not general traders.

The records were computerised in the late 1980s, with custom software written for the task. At that time, and into the early '90s, it was not unusual for 5 or 6 - or more - packets to be parcelled up, receipt and address

written, and taken to the post per day. The busiest months tend to be September, December, February and March, for construction in the winter months. The turnover rose to over £6000 in the early '90s period - made up of mainly relatively inexpensive items. In recent times, turnover has fallen to under £2000, as less construction seems to be taking place. The aims, however remain the same as in those early days - to help BATC members purchase otherwise difficult to obtain specialist components for amateur television.

The IARU Region 1 Microwave ATV standard

By Graham Shirville

All the existing 23cms and 3cms FM ATV repeaters operating in the UK use a specification which is line with the IARU standard which was agreed in Torremolinos at the April 1991 Conference.

This specification is, unfortunately, incomplete and sporadic discussions have taken place between IARU member societies over the past 3 or 4 years to correct this.

A firm proposal was expected to be presented at the forthcoming IARU Region 1 Conference in Lillehammer during September, but none has been prepared.

The Chairman of the responsible Committee, PA0EZ, has instead written a paper for consideration at this meeting. His paper makes a number of claims regarding the bandwidth required by FM ATV signals and states that the bandwidth "problem" is caused by the presence of the normal audio sub-carriers. He also states that most activity uses 144.75 for sound and that, therefore, the need for an additional audio channel is not evident.

His conclusion is that, on all bands below 24GHz, no audio sub-carriers should be permitted. Where required, a 15625 Baud "sound in sync" system using an analogue or a digital signal processing system should instead be used with the detailed parameters being

left to be defined at the next Conference in 2001.

The BATC and, we understand, the RSGB believe that this paper should not be supported as it does not take into account a number of facts concerning the existing system including circuit simplicity and compatibility with current broadcast receivers. Adoption of the proposal would cause major and unnecessary disruption to our existing repeater system.

A full technical paper will be prepared in good time for the meeting so that the delegates are properly briefed.

CQ-TV Commercial advertising rates



Size	Mono	Colour
Quarter page	£20	£25
Half page	£40	£50
Full page	£80	£100

Discounts of 5% for 2-3 insertions and 10% for 4 and above apply to the above prices.

If you would like to advertise in CQ-TV, then please contact our advertising manager, Trevor Brown, 14 Stairfoot Close, Adel, Leeds, LS16 8JR. Tel: 01132 670115. Email: adman@batc.org.uk



Marconi Centenary Celebrations

By Chris Gibbs G8GHH

April 22nd - 25th 1999

Nearly a year ago, to coincide with Marconi's birthday, International Marconi Day, the 100th anniversary of Wimereux's township and the 100th anniversary of Marconi's transmissions between Dover and Wimereux, it was decided to re-enact the historic transmissions. An ATV link-up was required on 10GHz, as it was believed that F to G had not been worked on 10GHz duplex ATV before. (Can anyone out there challenge this?) It also meant that dignitaries including Marconi's daughter, Principessa Ellettra Marconi, could see each other whilst passing their greetings messages.

Radio Club de Wimereux first approached the Dover Radio Club, who very soon realised that a project of this size was way beyond just one small club. Eventually the Hilderstone (Thanet) Radio Club, the East Kent Radio Society (who meet at Herne Bay, which is twinned with Wimereux), and the Kent Television Group were all involved.



Paul, G8IXC, in control during the setting up on the Friday

each other and began to make plans. Later, the French group, headed by their technical and microwave man Jean, F1ESA, came to Dover. From the ATV point of view, one problem was that the events would run for several days, requiring time off work, travelling considerable distances and,

available to lend/operate equipment for display during the exhibition.

Dover town is in a hole in the ground, with hills of over 300ft around it. There is no way 10GHz was going to get out over the sea to Wimereux - even 23cms would be doubtful for good pictures. It was decided that a link would be needed to, say, Dover Castle, then another link from there to Wimereux (where there would have to be another link as Wimereux town centre is also screened!). But where would we get all this 10GHz gear?

The KTG are very fortunate in having Peter Johnson, G4LXC, as a member. He has a very considerable array of 10GHz and other equipment, enough for two full duplex systems - that's six dishes! The manager of Dover Castle was extremely helpful, and we were allowed to use one of the bastions on the south curtain wall with an excellent view down into the town and, more importantly, a perfect take-off to France. Several weeks beforehand the paths were checked on 10GHz and 23cms with excellent results. Mind you, the French were running 10 WATTS to the dish on 10GHz!



In the midpoint control room in Dover Castle, G4LXC looks pleased.

Plans were outlined and the groups undertook specific duties. A group from Dover visited France to introduce

with the BATC rally at Coventry on the last day, many of the people that we might have asked would not be

Wiring diagrams were re-drawn many times but the final system ended up with various cameras and mics in the White Cliffs Experience building in

Dover, connected to audio and video mixers and monitors. Heather, YL of Paul, G8IXC, who was vision and sound mixer controller, operated these. This then went up to the Castle on 10GHz, to be received by a dish aimed through a window in a narrow passageway in the thickness of the wall. In the tower room was another vast array of equipment, which then fed the main 10GHz TX dish on the roof (1

shifts.

It should be noted that the only means of access to this bastion (part of which was used as a prison 200 years ago still with thick, studded wooden doors and barred windows) was by a very narrow spiral staircase. Chris and Peter had to hump 11 sandbags up to the tower roof, in order to stop the dishes being blown away. Finally, the incoming 10GHz or

enjoyed herself, and so did we all. The whole exercise has shown that several groups including "overseas" ones can work together to achieve success and generate the kind of friendship now established (it does help having email facilities though, as there was so much information to disseminate!).

For the technically inclined, the 23cm RX was basically a modified satellite



Panorama of the rooftop installation, with 10GHz and 24cms antennae in profusion. Chris, G8GHH on the right adjusts a parabolic antenna.

Watt, using a linear borrowed from Jean, F1ESA). Also on the roof was the 10GHz RX dish from France, along with the 23cms TX Yagi, which was used as back up. The 23cms RX Yagi was pointed out of the toilet window at the end of the building in order to get sufficient isolation to run duplex! The castle link site was operated by myself, G8GHH and Peter G4LXC, working in

23cms audio and video were converted (for about the sixth time!) back up to 10GHz and sent down to the White Cliffs Experience in Dover town. 2m was used as an engineering channel. With such a vast array of equipment (at the French end too, of course), it was inevitable that there would be a few problems. However, due to the dedication of the few, in other words Peter, building odd little boxes as and when needed, finding yet another RX, sorting the wires out, etc, most of the system worked.

receiver. The TX was homebrew feeding a Mitsubishi 15W PA module. Each 10GHz RX used a converted LNB feeding a satellite RX all modified with tuneable sound, and so on. Four small ex-BSB dishes were used for the local links. The TXs also used very much-modified LNBS, with the Wimereux link one driving Peter's 150mW amplifier, then into a 1W PA. More satellite RXs were used for direct off-air monitoring. There were many switch boxes to route video and audio between the various units and, well, I gave up trying to count the number of monitors! Almost all of this could run from 12V batteries that Peter provided should the mains have failed. 2m communication was from an IC240, running 10W to a dipole fixed to a short boom sticking out of the window, with the window shut on it to keep it in place. This was fine, until some seagulls landed on it. It shot downwards, springing up the end inside the tower room, causing the box used to weigh it down to crash to the floor, dragging a coax and the 23cm RX with it! When the seagulls (and Peter) had got over the shock, normality was soon restored.



Marconi's daughter, Principessa Elettra, with her son, Guglielmo

The UK callsign for the occasion was GB100MAR. The French used TM5CW and F5KBM (Club Branly-Marconi). The texts of the original historic messages of the time were sent in CW by Ian Keyser, G3ROO, who, with others, was in period costume. The French replied with Pierre, F6FLB, on the key. Then dignitaries at both ends, including Principessa Marconi in Dover, sent greetings messages whilst being able to see the assembled groups in Wimereux and Dover. In the afternoon, Principessa Marconi who had hurried back to Wimereux, did it all again from there! She thoroughly

A Story of Wimereux and South Foreland Lighthouse

By Peter Johnson G4LXC

It all started some time in January, when Chris Gibbs G8GHH phoned me to ask if I had any microwave equipment that could be used for a forthcoming event. The event in question was the centenary of Marconi's first CW transmission to and from Wimereux, 21 miles across the English Channel, which took place on 27 March 1899. I said, "Yes", without thinking. I could do it all right, on 10GHz and on 23cms, and it would be possible with the equipment I had in hand. At the time little did I realise what this would grow into.

Our first meeting was with the Herne Bay Radio Club. I attended with my note pad, and started to consider how much it all involved. The White Cliffs Experience was to be included, along with South Foreland Lighthouse. Tests were needed, so a date was set for 13 March 1999 at South Foreland.

I arrived at SFL at 0800 GMT, and had a look around. The others, Chris G8GHH, Jos G3ZZZ, Brian Joiner G8ZYZ, David Harding G0DQI, and the lighthouse keeper from the National Trust, all arrived at 0900 GMT. We all

set to getting the equipment to the top of the lighthouse, to the balcony around the light. I set up the TX and RX dishes at 1000 GMT. David made contact with F1ESA on 2m 144.750, and by 1030 GMT we were ready to receive on 10.425GHz, having set the bearing by use of the Astra Satellite at 19.3 degrees east, our bearing to Wimereux 152.0 degrees south established, 26.0 degrees east was set. We switched on the RX.

The day started with high winds with bright sunshine and many heavy clouds. By 1030 we had thick fog all around. Immediately, to everyone's delight, we got P5 colour pictures. I switched on the TX dish, and without any alignment, got P1, so I did a pan and tilt, until the French gave us a P5 - not bad for 15mW into a 36dB prime focus dish.

This established the first ever recorded ATV contact with France, duplex fast scan 625-line PAL colour, with 6MHz sound each way. Contact was between F1ESA and G4LXC. David G0DQI made it so easy with his fluent French, translating for all of us. Brian G8ZYZ recorded the whole event on his Hi8 camcorder.

The next tests were on 23cms, but my half-watt TX was not enough to get across. Chris got his partly finished PA from the car and, with about 10 watts, a P5 was obtained from France. We also had a P5 report from F1ESA.

At 1200 GMT we finished, and repacked our cars for our next tests from Dover Castle to Wimereux at 1400. Again, the tests were completely successful - this time only on 23cms with F5KBM, P5 pictures and sound both ways. G4LXC, used 10 watts, and 20 watts were used in France. Simple 10dB antennae were used, and duplex was achieved, with some cross modulation by not having an RX filter. In other words, TX on 1300MHz and RX on 1255MHz.

The 36in transmit dish was made by the Marconi Company for a wartime aircraft radar, and is an antique.

If we made history, we ought to have a plaque to celebrate the fact on the South Foreland Lighthouse's wall, alongside Marconi's. Many thanks to all who helped organise the whole event.

Proposed changes to the BATC Constitution

Our constitution has lasted 10 years since it was written in 1989 and since then there have been some changes in the way we run the club.

We have introduced a 12 month rolling subscription period with the option of variable lengths and subscription fees. This has meant re-drafting clause 5.1 and adding some more clauses to cover the new arrangements.

Other changes are financial dealing with inflation and VAT. The change in section 2 allows for the possibility of resigning our affiliation to the RSGB. The new clause 9.0.1: allows for publication of club notices on the net.

Proposed Changes: -

There are a number of small changes to correct grammar and capitalisation errors, which have no effect on the meaning of the paragraphs that contain them.

1.1: Add "and other" after the word magnetic.

2: Add "At the discretion of the committee," to the beginning of the sentence.

5.0: Change the £15 amounts to £30. This deals with inflation.

5.1: Replacement paragraph "The normal subscription period shall be 12 months. Longer or shorter periods with or without discounts or surcharges may be allowed as determined by the membership secretary and/or the committee."

5.2: New paragraph "Subscriptions shall be due on the last day of the appropriate anniversary month of joining and membership shall cease 2 months after that date if the subscriptions due remain unpaid."

5.3: New paragraph "Members whose subscriptions are in arrears shall not be entitled to any of the benefits of membership nor be eligible to vote at meetings of the club."

5.4: New paragraph "The committee may, at its discretion, require a joining fee to be paid by new members or lapsed members who rejoin."

9.0.1: New Paragraph "At the discretion of the committee notices of the GM or EGM may be published on the clubs website or other electronic communication medium."

Appendix A:

Delete the words "and the VAT regulations" (see note 1), and the word "to" before the word "comply".

Appendix B:

Change the date and wording on line one to reflect the new resolution required. Increase £25 amounts to £50 and £150 amounts to £300.

Note 1: Change to "If the club registers for VAT, there will be a duty to issue VAT receipts if requested. Further guidance must be obtained from the Hon. Treasurer before any such receipt is issued."

Brian Summers Hon. Treasurer.

PI6ALK Dutch Amateur Television Repeater On Satellite - Latest!

By Paul Pitts

In mid - January Chairman Trevor forwarded an email to me, that had been received by Editor Ian from Mr. Rens Maas, about a Dutch amateur TV repeater that was now also available, in MPEG-2, via satellite.

pictures from PI6ALK seemed pretty straightforward. Not so!

The original email gave the satellite frequency as 12.701GHz so naturally this is where I looked. My Nokia would search and tantalisingly hesitate in this area but then would search on. A later update, from the Netherlands in early

which, if you have a map to hand, is about 19 miles north of Amsterdam and 5 miles north east of the city of Alkmaar.

The up-link power is about 16 watts into a 2.8 m offset antenna from an SSPA by SSE Telecom from Fremont in California, USA. This power amp is fed by a combined modulator / up-converter by Wegener Communications, Atlanta, Georgia, USA. It is a DVT 2000, (fully broadcast,) MPEG-2 transmitter with a programmable bit rate of between 1.5 Mb/s and more than 40Mb/s. For PI6ALK it is set to 5Mb/s, which in turn determines the symbol rate of 3.012. Contained within this 'techno - speak' is the undeniable fact that PI6ALK is not nearly as powerful as some of the signals on similar frequencies on adjacent satellites. So now I return to the system sensitivity issue. My Nokia was new and thus assumed to be beyond question, (at 350 quid it ought to be!) The cable to the 0.7dB Universal LNB was the lowest loss I could buy and the antenna a 1.6m prime focus, but it had been in the cabbage patch since the satellite channel, Music Box, could only find six hours of material and played it out four times a day.

A couple of hours with the spectrum analyser soon revealed that the polar mount could be peaked a little and the current waveguide needed to be slid forward a few millimetres in its clamp to hit optimum focus. Next the IRTE ferrite polariser came under suspicion and was excised. The Nokia has no provision for skew correction and so the IRTE was fed from a Farnell's PSU that sat behind my telly. Gradually I was able to tease up the signal strength as indicated by the red 'thermometer' on the Nokia when tuned to 12.684GHz and aimed at 16 degrees east. These were the outdoor tweaks.

Indoors, I looked at my rat's nest of cables that probably lurk behind every mature satellite installation, and adopted the same technique. Change something, anything, in the signal chain and look for a rise in 'temperature'. Right next to the Nokia input, I had fitted a relay operated aerial changeover switch. It came with the



I had just purchased a Nokia Mediamaster 9600S MPEG-2 digital satellite receiver and was just getting to know my way around its various menus and configuration possibilities. I have been a satellite buff for many years - indeed my neighbours asked why I wanted 'Radar' when my 1.6m prime focus dish arrived in my back garden. You even needed a licence for the dish in those days.

So Chairman Trev's request for sample

February, explained the frequency had been shifted to 12.684GHz, but still the signal eluded me. Now the Nokia hesitated for a little longer during channel searches, and even labelled the otherwise blank channel as digital SNG - but still no picture.

In frustration I emailed Rens Maas, in English, to ask if the signal was ever-present or only appeared during amateur activity. To my relief he replied in English, and immediately,

with not only with the answer to my questions, but also some well informed guidance on what to do to improve the sensitivity of my system.

PI6ALK is up-linked to Eutelsat W2 at 16 degrees east from a site in Heerhugowaard,





receiver and was made by the same firm. I had used this to direct the antenna feed to an analogue receiver during the satellite search mode. At this frequency it was decidedly lossy. Its removal certainly brought about the most valuable increase on the signal thermometer, but it has to be said that the effect of all the individual avoidable losses were cumulative. Very heavy rain prevented any further tests for more than 24hrs, but as soon as it abated I entered the channel search mode and immediately the PI6ALK Philips style test card appeared. Not in the VHS bandwidth limited version that Trevor has in his article, (serves him right for nicking my picture) but in glorious full spec RGB. (We could only produce bitmaps in time for publication via the VHS route.)

Now that I can receive this elusive channel, I have hardly been able to

ask “Why am I drawn to Dutch amateur television?” For me, the answer lies not just in their technical wizardry, but also in the ingenuity they have applied to acquire the loan or use of facilities way beyond the reach of individual amateurs. The up-link has an occasional commercial use as a test facility but during its rest periods it does a

fine job for the amateurs.

The Wegener DTV 2000 is on test and will be demonstrated in Italy soon, so PI6ALK will cease to be on satellite until it is returned, leaving the internet version to fly the flag. Try <http://www.tss-telecom.nl/Pi6alk> if you haven't seen it yet. Rens has the use of another satellite up-link for this too! The dish is a 1.8m prime focus by Precision Antennas, GB directed towards the same W2 satellite. The SSPA is also by SSE Telecom but the modulator / demodulator is from the Error Free Data company. The bit-rate is 0.5Mb up and 2Mb down. This is how the Real Video / Audio and Webcams get onto the PI6ALK website.

I will try to describe the satellite site, since I seem unable to draw myself



draw myself away from it. With many hundreds of digital free-to-air channels available to a motorised dish you could

away from it. They have so many active hams on the input of their repeater that they have to place them in

a four by four mosaic. Any of the sixteen images can be shown full screen or expanded to any size to suit. Some amateurs can be seen working on their current project, others might simply be enjoying a glass of beer, Amstel of course, or wine and a cigarette. They all wear headphones and are in open conversation with each other. That is they can all speak at once and yet be heard clearly, as if they were all in the same clubroom. The conversational tone is calm and gentle, (in Dutch) and often hilarious. A command of Dutch is not essential, their antics caught on camera, transcend any language barrier. When serious technical matters are discussed, accompanying equipment close ups or felt tipped circuit diagrams seem strangely familiar, because they use the same symbols and electrical units as us. When a new arrival enters the net their signal parameters, audio modulation for instance, are talked in by a communal ‘up-a-bit-down-a-bit’ method. For vision, they put the actual waveform of the new incoming signal on the repeater output so synch and burst amplitude etc can be optimised by the sender. They don't miss a trick. Even after weeks of viewing, I have not fully grasped the overall picture of the enterprise. There are new surprises every day.

On Sunday it was Railcam. Right at the top of a communication tower they had a motorised dish that could pan around the horizon through about 350 degrees. Attached to this was a colour camera so we could all see the view. As the dish motored and settled on a radial that coincided with an incoming ATV signal the onscreen graphics named that source, even the towns and railway stations were named. If that's not nifty enough, they even passed control of the motor mechanism, via the repeater and an ingenious Powermid arrangement, to individual hams. So as well as stereo Nicam, PCM and analogue carriers floating around they have other pulsed carriers devoted to very distant remote control. Today I was surprised to learn the Amsterdam Police have a link to the PI6ALK website. (As soon as I sign off here I will have to investigate this!)

So to all the ATV'ers in Holland and particularly Rens Maas, who has done all he possibly can to get me on message, I say good luck and keep up the amazing work at PI6ALK.

A 10GHz ATV Repeater for East Yorkshire

By Bill Hall G3RMX

The East Yorkshire ATV Repeater Group have been operating the 24cms repeater GB3EY for some time and an article on the I²C logic used by this repeater was published in CQ-TV 176. At the group AGM in November 1997 it was agreed that we would put a second repeater on air on 10GHz. This had been made possible by a new inland site becoming available at Weedley, which would give good coverage at 3cms compared to the coastal site at Aldbrough used by GB3EY.

Four members of the group had acquired Qualcomm amplifiers and we had succeeded in tuning these up to produce around 1.5 watts, which worked very well for simplex operation. Other experimentation resulted in DRO oscillators giving 4mW at 10.315 GHz which was more than enough drive for the Qualcomm. These were found to be very stable compared to Gunn modules and most of them could be modulated very satisfactorily using a modified GUNNMODII module from the G8OZP stable. We then found a suitable antenna in the form of a slotted waveguide array produced by G6NHG and, after some negotiations, managed to get some very good filters from the same source. The final transmitter design was based on these units, with all items tuned to the transmit frequency of 10.065 GHz. The whole transmitter assembly was mounted at the top of the mast and only video, audio, 12 volts power and some control signals (which allowed us to switch the TX on and off and monitor the radiated power) fed up the mast.

The receive system was an easy problem to solve; we used another slotted array antenna and filter by G6NHG and a modified LNB by G8OZP. This was input to a Pace 9200 satellite receiver as the tuneable IF. Modifications were made to increase the video gain so that ATV deviation gave a standard 1-volt output. The power supply logic was changed so that it switched on fully after a power interruption instead of going to standby and finally the after hours sync signal was disabled to prevent this operating

the syncs detector. The antenna, filter and LNB were all tuned to 10.315 GHz and also fitted to the top of the mast with a 1metre vertical separation of TX and RX antennae.

The tricky problem remaining was the Control Logic. Having struggled with the limitations of the Teletext based system used by GB3EY, it was decided to use a logic based on PC hardware. Some initial experiments with an old DX2-66, a home made video encoder using an AD 722 chip and a TSR program culled from the internet proved the feasibility of producing pictures at a resolution of 320 x 200 pixels in 256 colours. The only problem was that the further we progressed with the design the more we began to realise that whilst graphics were fine at this resolution, photographs looked terrible. One of the major reasons for moving to the new logic was to be able to display good quality pictures in the beacon mode and so experiments moved to using 640 x 480 resolution; this really opened a can of worms and I have the grey hairs to prove it.

I will not discuss the software itself in any detail as, in order to get the maximum control over the hardware, this was all written in assembler, with the final version running to 5000 lines of source code. The PC hardware consists of a 133MHz Pentium with 16 MB of memory, a 130 MB hard disc, a Video Excel PRO 2000/2TV PCI display card and a game card. The motherboard has on board disc controllers, parallel port and serial ports. The Video Excel display card was chosen because it already had a TV standard output and did not require the use of a TSR program to modify the display registers to get 15625/50 line/frame rates. It also happened to be very cheap, but unfortunately appears to have disappeared from sale.

A number of external boards were built to provide specialist TV functions etc but these were all interfaced to the PC, via the parallel, serial and game ports. Most of these boards had originally been designed for GB3EY and only required minor changes to the interface arrangements. These boards are: -

- a) A video switcher to select the video source for the transmitter. This is either PC video in beacon mode or RX video in repeat mode. Provision has also been made to allow a second RX input so that in the future we can provide cross band operation. This switcher is controlled by 2 bits of the parallel port.
- b) A Sync detector board to sense incoming video. This has two switched inputs (to allow a second RX input) which are controlled by another bit of the parallel port. The board senses the 15625 Hz sync pulses using a NE567 PLL. The output of this is processed by a PIC 16C84 microcontroller to eliminate false alarms before being fed to the PC as a game port switch input. A second function of the PIC on this board is to act as a watchdog timer for the PC. The watchdog is pulsed by another bit of the parallel port and if these pulses disappear for too long then the PIC pulses the reset line of the PC causing it to reboot.
- c) A modem board that detects signals on the audio from the RX and feeds these to the PC serial port. This allows a remote operator to communicate with the live software and upload new text pages, delete old text pages and perform a limited range of control functions such as reset Time/Date and monitor TX power and RX AGC level.
- d) A voltage to resistance converter board that takes analogue signals from the transmitter power monitor and the receiver AGC output and drives FETs as variable resistances at the game port input. This effectively gives us analogue inputs to the PC.
- e) A DTMF decoder board that decodes sequences on the RX audio and makes logic level signals available to the PC. Currently the only one we are using is for remote TX shutdown. This does not feed into the PC but directly switches the transmitter control circuits.

f) A Morse tone generator which provides either the Morse ident with the ID page or the invitation to transmit "K" with the end of transmission page. These signals are triggered by two bits of the parallel port. The PC originally produced the Morse tones but it was found that very occasionally one of the system interrupts could corrupt the length of a dot or dash resulting in a possible incorrect ID being transmitted. In order therefore to guarantee the Morse ID was always correct it was decided a separate generator was justified. The unit used was very simple using a PIC 16C84 with software by GW6BWX/G6GXX taken from G3PHOs web site and modified specially for the repeater.

The software loads all the graphics and text pages from the hard disk at system start up and moves them into extended memory. The hard drive is then shut down and the program retrieves pages from extended memory, as they are required, when the program runs. In beacon mode a sequence of graphics and text pages are cycled through continuously. Each page has its own display time and the ID page is always the first page in the sequence. A normal sequence is always designed to be shorter than 15 minutes in total display time but, if an error is made, a timer will force a new sequence every 15 minutes. The graphics pages are semi-permanent in that only visiting the site and loading the new pages from floppy disk can change them. The text pages, however, can be loaded, deleted or edited 'on air' via the audio channel. The text pages are intended to display information on local club programmes

or events that obviously change very frequently. They also can be used to provide information on the operation of the repeater, such as programmed maintenance shut downs.

When the repeater is accessed by a valid video signal the incoming signal is repeated to the output. If the access period exceeds 15 minutes, the incoming signal will be shut off and the ID page transmitted together with the Morse ID. After about 15 seconds the repeated signal will be restored until the next ident period. When the incoming video disappears, the "K" page is transmitted for 30 seconds together with the Morse letter "K" as an invitation to transmit. The "K" page displays rolling time and date information from the PC clock plus two horizontal bars, the length of which indicate the maximum and minimum received signal strength of the last over. At the end of the 30 seconds the system will transmit the ID page and revert to beacon mode operation. If the repeater is accessed during the transmission of the "K" page, it will go straight back to repeating the incoming video.

The graphics pages are produced using Windows 95 Paint, either as a pure graphics page or by adding text to an imported picture from a digital camera or scanned image. This works very well and pages can be produced very quickly compared to the absolute torture of constructing a Teletext page. Each page is stored as a separate bitmap file and the repeater is told which pages to display, and for how long by a configuration file which is in text format and can be changed very quickly with a text editor.

The text pages are 24 lines of 40 characters and can be edited live 'on air' by system operators or a page can be prepared off line and then uploaded to the repeater using HyperTerminal. Each text page has its own display time that can be set appropriate to the information content. A simple page may only show for 20 seconds but one with a great deal of information might be shown for 60 seconds.

In its present form the software can handle 40 graphics pages and 36 text pages but this is usually kept down to about 15 graphics pages and 15 text pages so as not to get cut short by the 15 minute ID slot.

The repeater will go operational on the 6th June 1999 and initially, until a pattern of use is established, it will operate in beacon mode between 1800 hrs and 2200 hrs GMT. At all other times it will send its ID page for 30 seconds at 05, 20, 35 and 50 minutes past each hour. It will at all times respond to an incoming signal and go into repeat mode. GB3XY will be the most northerly 10GHz ATV repeater in the country and if you are in the service area, please use the repeater; the ATVers to the east of The Yorkshire Wolds are looking forward to being able to communicate with anyone outside our present simplex area.

Bill can be contacted via e-mail at bill@g3rmx.karoo.co.uk

Several colour photographs to accompany this article can be found on the inside rear cover. - ED.



There's just no escape these days from CCTV.

Picture from Dicky Howett

The British Amateur Television Club 1997 Accounts

Balance sheet at 31 December 1997	1997	1996	1995
Fixed assets			
Office equipment			
Additions	142	1,118	257
Less - Depreciation	(142)	(1,118)	(257)
	-----	-----	-----
Current assets			
Stocks - Members services	3,636	4,699	4,959
Publications	2,051	3,679	4,192
Back issues- CQ-TV	1,588	1,552	1,404
Debtors	250	-	300
Nationwide Building Society	11,424	11,195	11,024
Girobank account	119	119	119
Royal Bank of Scotland- Current account	7,230	8,283	9,004
Investment account	30,040	30,040	25,040
	-----	-----	-----
	56,338	59,567	56,042
Less-			
Current liabilities			
Creditors and accruals	1,350	1,027	1,015
Subscriptions received in advance	19,021	19,139	13,876
	-----	-----	-----
	20,371	20,166	14,891
	-----	-----	-----
	£ 35,967	£ 39,401	£ 41,151
	=====	=====	=====
Represented by-			
Accumulated fund			
Balance brought forward	39,401	41,151	37,008
(Excess of expenditure over income)	(3,434)	(1,750)	4,143
/Surplus of income over expenditure	-----	-----	-----
	£ 35,967	£ 39,401	£ 41,151
	=====	=====	=====

In accordance with instructions given to us, we have prepared these accounts from the accounting records of The British Amateur Television Club, and from information and explanations supplied to us.

Chartered Accountants, Gainsborough, 5 November 1998

Income and expenditure account. Two years ended 31 December 1997

	1997	1996	1995
Income			
Subscriptions	17,131	15,589	16,405
Members services	288	140	320
Publications	-	-	393
Advertising	300	289	358
Building society interest	230	170	233
Bank interest	1,497	1,304	1,525
Exhibitions	3,698	3,807	3,682
Donations	417	402	17
Postage	176	291	231
Miscellaneous	27	51	106
	-----	-----	-----
	23,764	22,043	23,270
Less-			
Expenditure			
CQ TV printing	17,338	13,010	8,962
CQ TV postage	4,000	3,915	3,881
CQ TV production	299	557	395
General office expenditure	115	1,035	203
General postages	582	593	527
RSGB affiliation fee	20	17	16
Committee members expenses	5	242	303
Exhibitions	2,508	2,878	2,639
Insurance and legal	72	72	146
Miscellaneous expenses	416	21	109
Members benefits	-	95	1,093
Accountancy	323	323	311
Rally attendance	166	190	276
Recruitment	101	237	-
Advertising and publicity	315	6	125
Project development	29	8	27
Bank charges	132	156	114
Publications	777	438	-
	-----	-----	-----
	27,198	23,793	19,127
(Excess of expenditure over income)	-----	-----	-----
/ Surplus of income over expenditure	£ (3,434)	£ (1,750)	£ 4,143
	=====	=====	=====

Circuit Notebooks Remembered

By John Lawrence GW3JGA

As this is the 50th Anniversary of the BATC it seemed appropriate to look back at some milestones in CQ-TV and Circuit Notebook and recount some memorable personal achievements and disasters.

The Beginning

It all started in 1948 when Mike Barlow G3CVO put a notice in some of the radio magazines inviting people to write to him if they were interested in amateur television transmission. The interest was sufficiently great that, shortly after this, G3CVO commenced circulation of a duplicated newsletter. This was the forerunner to CQ-TV which came into being when the BATC was formed in 1949.

The method was to start with an oscillator running at twice line frequency, 20250 Hz, then using multivibrator circuits to divide by 2 for line frequency and by 405 for field frequency. This meant dividing by 9, by 9, and by 5 to give a total of 405. Dividing by 9 was not very reliable. Signals from the dividing stages could be mixed in with the synchronising signals to produce a suitable pattern. My faded shack notebook gives the date as June 1950 and the PG used 5-6SN7 double triodes, 5 miscellaneous diodes and 1-EF50 pentode.

I recall the late Gordon Sharpley G3LEE saying that, at his interview for his engineering position at Granada TV, he was asked what frequency would be required to generate an interlaced 405 line raster, without hesitation he said '20250 cycles' and got the job.

Our family TV set was completed in time for the opening of Holme Moss on 12th October 1951. The picture was excellent but there was no sound. I discovered that I had set the local oscillator frequency on the wrong side of the vision carrier. Next day I rewound the local oscillator coil, set it on frequency and everything was fine.

engineers, designing television equipment, working in the BBC, or had a science or engineering qualification. An excellent booklet 'An Introduction to Amateur Television' was produced by Mike Barlow G3CVO/T and published by the BATC in 1956, price 3/6d (17.5p). It gave circuits and very practical information on building a complete ATV station. The picture source was a flying spot scanner and the transmission side included receivers, transmitters, modulators and an aerial design for 70cms.

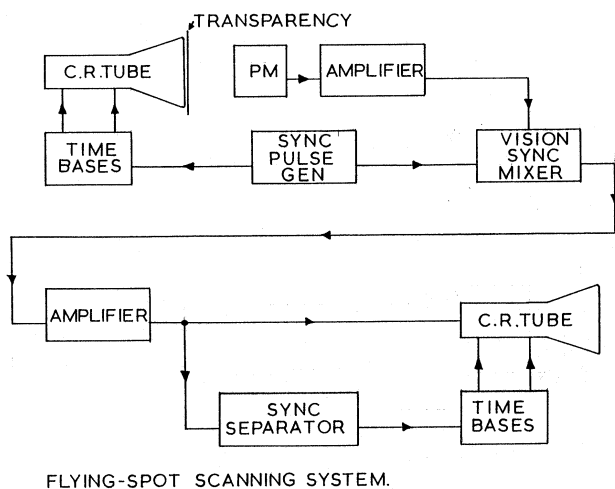

Fig 1. Block Diagram, Flying Spot Scanner

My interest in television began in the late 1940s when I purchased an ex-WD Type 6A Indicator Unit, with its VCR97 tube, and converted it into an oscilloscope. Other enthusiasts, living in the London area, were converting these and similar units into TV receivers.

Television had not yet arrived in the North but I persuaded my father to finance me in the building of a 12inch TV receiver in time for the opening of BBC TV transmitter at Holme Moss. But first, as there was no TV signal, I had to build a 405 line pattern generator.

Sources of Information

At that time the best book for circuits was 'Time Bases' by O.S. Puckle, first published in 1943. It had everything from an Eccles-Jordan Trigger Circuit to a Screen Coupled Phantastron and of course included Puckle's time base that was used in most of the early oscilloscopes. Wireless World and Electronic Engineering were also useful sources of information.

Circuits specifically for amateur television were published in CQ-TV. Most were written by members who were themselves professional



Fig 2. 931A Photomultiplier and Video Amplifier (1957)

I obtained my sound licence GW3JGA in 1955, joined the BATC in the Summer of 1957 and obtained my ATV licence GW3JGA/T in 1958. On joining the BATC, I received my first copy of CQ-TV, No.33. It had 12 pages packed with circuits and information including details of the ex-WD APQ2 Radar Jammer Unit. This contained an RF power oscillator operating on '250 - 550 Megacycles', but the most useful item was the 931A photomultiplier tube. This tube was used in the jammer unit as a wide-band noise generator but was the basis of all the ATV flying spot scanners being built at that time.



Fig 3. Flying Spot Scanner in Operation

A Flying Spot Scanner

I obtained an APQ2 with its 931A PM tube from Messrs Proops for £5 and set to work on my first flying spot scanner. The general arrangement is shown in Fig.1. I used the video circuits from Mike Barlow's book and fitted a 5FP7 CRT to a Murphy TV chassis to provide the scanner. I remember taking great care as the 5kV EHT for the CRT came from a 50Hz mains transformer, if there is a degree of lethal, this was extremely. My 931A and video amplifier, from 1957, is shown in Figs.2 & 3 and a typical picture from a flying spot scanner is shown in Fig. 4.



Fig 4. Picture from Flying Spot Scanner (1957)

1953 saw the publication of the BBC Training Manuals 'Television Engineering' by S.W. Amos and D.C. Birkinshaw. Volume 1 covered Fundamentals, Camera Tubes etc., Volume 2 (1956) - Video Frequency Amplification, Volume 3 (1956) - Waveform Generation and Volume 4 (1958) - General Circuit techniques.

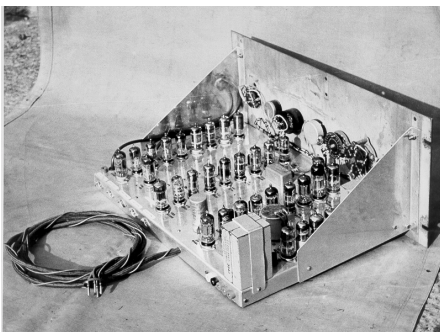

Fig 5. 33 Valve Sync Generator and Vision Processor (1960)

A 405 line Interlaced Sync Pulse Generator

Armed with Vols. 3 & 4, I started work on a new fully interlaced SPG; this proved to be a monumental task. I built it on a 19inch rack chassis; it contained 33 valves, (imagine cutting all those holes) and the valve filaments

consumed 10Amps at 6.3V, in addition to 250 mA of 250V HT. One cannot help comparing this with today's single chip SPG. However, my valve SPG did include a vision processor and output amplifiers. It is shown here in Fig. 5.

The BATC had arranged for a supply of 1 inch Vidicon camera tubes to be made available for members at a cost of £25. Initially, scan coils were not readily available, but full constructional information on winding your own coils was published in CQ-TV Nos. 23 and 33. A new two valve 70cms down converter by Brian Partridge G3KOK/T was published in CQ-TV No. 31. It worked extremely well on local signals but required a pre-amp for DX use. One built from copper sheet is shown in Fig.6.

ATV Transmissions

The operational side of ATV continued apace. In April 1958 Derek GW3FDZ and I had our first two-way TV QSO between Prestatyn and Llandudno, a distance of 18 miles; both of us used G3KOK converters feeding into TV sets. Each transmitter used an 832A valve as a power tripler giving an output power of about 1 watt. Our pictures came from flying spot scanners. The aerial system at GW3JGA is shown in Fig.7.

Other Picture Sources

CQ-TV No. 44 showed a picture source using a fixed pattern Monoscope tube, built by Graham Hill. Several valve camera designs appeared in CQ-TV - a good example was 'A Seven Valve Camera' by D. Goodyear in CQ-TV No.47.

BATC Conventions

Attending a BATC Convention was a must. Each one was like 'a shot in the arm' and I would return home bursting with enthusiasm to get on with the next project. Convention 1960 was brilliant, camera sources included several Vidicons, two Image Orthicons, an Iconoscope and the Monoscope mentioned previously. Grant Dixon, Pluff Plowman and Gordon Sharpley all showed Slow Scan equipment. But, for me, Bob Tebbutt's flying spot telecine using a 9.5 mm cine projector back-to-front and showing Micky



Fig 6. G3KOK Down Converter

Mouse cartoons stole the show. It was featured on the cover of CQ-TV No.44.

1960 was a watershed for ATV. The development of valve circuitry had reached a plateau and on the horizon was colour TV and the increasing use of transistors and ultimately integrated circuits in video and pulse circuits.



Fig 7. GW3JGA Aerial System (1958)

Field Sequential Colour

Grant Dixon had already demonstrated Field Sequential Colour TV and this spurred me on to my next project. I built a FS Colour Bar Generator and then started on an experimental FS monitor. I decided to use a small MW6-

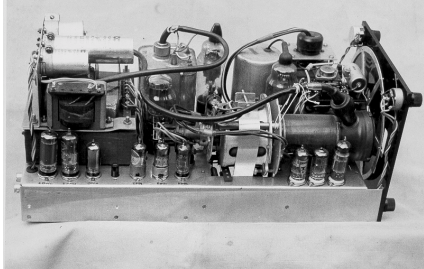

Fig 8. Field Sequential Colour Monitor, MW6-2 Tube

2 CRT, the type used in projection TVs, because the rotating disc could be smaller. The monitor used valves throughout except for the transistor control of the colour disc motor. It was a beast. The CRT was extremely bright, there were some hum problems but at least the rotating disc synchronised correctly and it did give me my first impression of colour TV. The main problem was that of excessive X-ray radiation from the CRT, which operated at 25kV, and gave me concern about my future manhood. The beast is shown in Fig.8.

Colour Field Sequential Colour 'Drum' Monitor

With the experience of knowing what not to do, I started work on a 14 inch Field Sequential Colour Monitor. The FS colour monitor was based on a



Fig 9. GW3JGA Shack (1962)

Mullard 14 inch monochrome CRT which was carefully supported within an open ended drum. This was fitted with a double sequence of red, green and blue gelatine filters spaced around the circumference of the drum. The drum was supported, horizontally, on a bicycle hub bearing and was belt driven by a speed controlled spin-dryer motor. The drum rotation was synchronised to the incoming video signal by means of optical chopper blades mounted on the drum. It rotated at 500 r.p.m. and, apart from sounding like a helicopter hovering overhead, it produced very acceptable colour pictures, (photographs are held in the BATC archives). The drum monitor can be seen in a view of my shack, dated 1962, Fig.9.

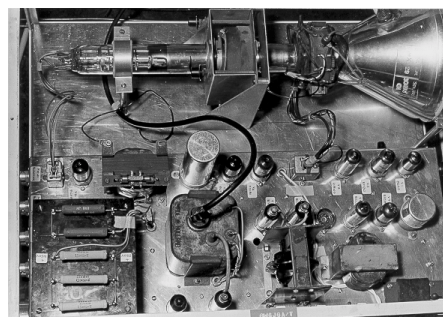

Fig 10. Scanning Section, Colour Flying Spot Scanner (1966)

A Colour Flying Spot Scanner

The next move was to build a colour flying spot scanner which would generate red, green & blue signals, then to view these on the new 'Drum' FS Colour Monitor. I spent some time gathering information, from John Tanner G3NDT/T and others, negotiating (scrounging) the various essential components required and then started work.

The scanner consisted of an 'equal energy' scanning CRT which ran at 25kV. The scanning circuits were conventional and used normal valve TV practice. The scanner section is shown in Fig.10. The scanning raster was focussed onto a 35mm transparency and the transmitted light was filtered out into red and blue by two dichroic mirrors, leaving the green component unaffected. The three colours of light were collected by three separate photomultiplier tubes each sensitive to the particular colour. Three head amplifiers were used and each had adjustable after-glow compensation to correct for the decaying of the scanning

tube phosphor. The three signals were then processed in an FS encoder to produced the required FS signal.

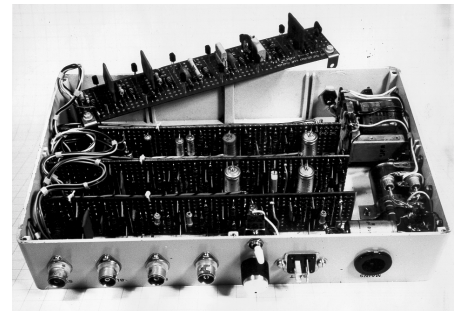

Fig 11. All-Transistor Sync Pulse Generator

The 1966 BATC Convention, held in the Conference Suite at 70 Brompton Road, WC1, was memorable in that Mike Cox demonstrated his three tube Vidicon colour camera by showing live colour pictures of the street outside, the first live colour pictures I had ever seen. Ian Waters described his Aerial Combining Unit and I displayed my colour FSS together with the drum sequential colour monitor. One over-enthusiastic viewer nearly lost a finger when he tried to touch the screen.

In 1965 my /T call sign was changed to GW6JGA due to the issue of separate G6XXX ATV licences - only to return to GW3JGA in 1984 when the present style of Amateur Licence came into force.

My library of useful books now included 'Pulse, Digital and Switching waveforms' by Millman & Taub, published by McGraw-Hill. Circuit Notebook No.1 appeared in CQTV No



Fig 12. Transistorised Vidicon Camera

68 and surprise, surprise, covered the use of transistors in pulse circuits. Continuing with transistors, I completed my all-transistor Sync Pulse Generator which incorporated genlock facilities, shown in Fig.11. and associated with it came my transistorised vidicon camera shown in Fig .12. Various parts of the camera circuitry were described in subsequent editions of Circuit Notebook

Integrated Circuits

Arthur Critchley published a series of 14 excellent articles (CQ-TV No.71 to CQ-TV No.84) on Integrated Circuits and their applications in ATV. He also published a further series on CMOS devices commencing in CQ-TV No.100. This issue also saw the introduction of Project 100, by Eric Putt and Tom Mitchell G3LMX. This was a complete PAL Colour Pattern and Sync Pulse Generator using TTL devices. CQ-TV No.103 saw John Goode's Gen-lock SPG, again using ICs, and the first of many articles by John covering much of the equipment used in a TV studio.

The 1970s and 1980s

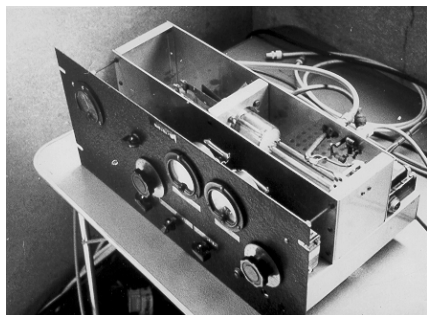

Fig 13. QV06-40 Transmitter (1970)

GW - GD ATV Tests on 70cms

In September 1970, Derek Whitehead GW6FDZ travelled to the Isle of Man taking with him a complete 70 cms ATV station and we established the first GW - GD two way ATV QSO. My transmitter, running a QV06-40 in the final is shown in Fig.13. and the general set-up for the tests is shown in Fig.14. The arrangement at (GW) GD6FDZ is shown in Fig.15.

PAL Colour

Domestic colour TV arrived in 1969 and colour receivers became available which could be converted to work as

colour monitors. Project 100 provided a PAL colour source and spawned a range of colour peripherals, colour bar generators and colour caption generators, including the Golf Whisky Colour Fiddle Box (Circuit Notebook No.32), which was demonstrated at the 1981 BATC Exhibition.



Fig 14. Set-up for the GW - GD Tests (September 1970)

NBTV and SSTV

The NBTV Association demonstrated moving pictures at the 1981 Exhibition.

SSTV received a major boost when in CQ-TV No.111 Grant Dixon described a method of using his Triton computer to generate captions and pictures. CQ-TV No.121 contained a tribute to Grant as he left the Committee after 30 years in office.

24 cms ATV

In CQ-TV No.117, the Editor, John Wood G3YQC, wrote and brought together several articles on 24 cms ATV which included an overview, by Andy Emmerson G8PTH, covering most aspects of setting up an ATV station for this band. The following issues of CQ-TV saw more 24 cms designs and discussions on FM v. AM. The 16th February 1984 saw the opening of five ATV repeaters operating in the 24 cms band, GB3GV,



Fig 15. Equipment at GD6FDZ/P, SnaeFell, Isle of Man (September 1970)

GB3UT, GB3TV, GB3UD & GB3VR; full details were given in CQ-TV No.126.

The 1990s

In 1990 our local ATV Group GW4KAZ, GW8PBX, GW8FEY, GW3MEO and I decided to build a 24 cms ATV repeater. The location was to be Nebo on the North East coast of the Isle of Anglesey a location which would cover G, GW, GD, GI and EI. Work commenced in September 1990 but it was not until July 1994 that our repeater GB3TM came on air. It used the BATC I²C boards, with input from Trevor Brown, G8CJS and ran software by G1FEF and G8VAT. The repeater is shown in Fig.16 and the dual Alford slot on the tower is shown in Fig.17. Circuit Notebook carried various repeater circuits as they were developed. All members of our ATV Group have built and continuously upgraded their stations and now GB3TM carries a regular Tuesday night ATV net. During the summer months, when there is a lift in conditions, EI stations from the Dublin area romp in at P5, - Great Stuff!



Fig 16. Repeater GB3TM, Nebo, Isle of Anglesey (1994)

The Millennium

We are at another watershed. Less equipment is home built, we tend to use commercial cameras or camcorders and view the pictures on colour TVs or commercial monitors. We still build circuits for video processing and switching using specialist ICs, (Circuit Notebook No.67) but in the future the PIC is likely to replace most logic control circuits. Slow Scan TV has seen a dramatic change. SSTV on your PC is now so good that it is no longer worth building specialist equipment. One remaining area for interesting experimentation is Low Definition TV, where you may still design nitty gritty

circuits, write clever software or build interesting mechanics.

On the RF side, it is unfortunate that 70cms ATV operation is at a low ebb, waiting patiently for video compression techniques and associated ICs to filter through to the amateur market. It is vital that we are up and running with

stations operating portable. Use it or lose it applies here also. 3 cms has become a good band for local ATV links, thanks to Bob Platts G8OZP 'Kits & Bits' and good fun for portable ATV, see Fig.19. The remaining bands have their enthusiasts and should be supported wherever possible.

the Licence) "for the purpose of self training in communication by wireless telegraphy, *which use includes technical investigations*". (My Italics).

The BATC Web Site is now firmly established and is getting around 100,000 visits a month. CQ-TV, under the editorship of Ian Pawson, has



Fig 18. Portable ATV Operation on 3 cms (1996)



Fig 17. 24cms Dual Alford Slot (in tube) at GB3TM (1994)

compressed video very soon or we may lose our place in the band. However, 24 cms ATV is healthy with new designs appearing in CQ-TV. QSOs may be local, through repeaters and DX with

As Television Amateurs, we must continue to be innovative, to try out new ideas, techniques and circuits, to make best use of the technology around us and to use our station (as it states in

blossomed into a full A4 glossy magazine, a world leader for ATV, which bodes well for the future of the BATC.

Please mention that you saw it in CQ-TV when replying to advertisers.

Deadline

Will all contributors please note that the deadline for articles for CQ-TV 188 is September 17th 1999. Please send your contributions in as soon as you can *prior* to this date.

Will all prospective contributors please be sure to read the 'Notice to Contributors' on page 1 so that you

understand the implications of submitting an article for publication.

The CQ-TV A4 size Word 97 document template can be downloaded from our web site. Select the CQ-TV magazine link from the home page at <http://www.batc.org.uk>

Commercial adverts should be sent to Trevor Brown, the advertising manager, at 14 Stairfoot Close, Adel, Leeds, LS16 8JR. Tel: 01132 670115. Email: adman@batc.org.uk

Members' sales and wants should be sent to the Editor. Email: editor@batc.org.uk

NBTV Tape Timebase

By G. Lewis

The circuit was developed to work with the cassette tape replay described in NBTV Magazine Issue 23/3 but is of merit in its own right.

Signals from tape are of variable quality and one of the problems is the indifferent syncs that are recovered. This circuit works on the principle of "fly-wheeling" across any missing pulses, without the difficulties of jitter encountered in phase lock loops.

It might also prove of use in NBTV radio work where the received signal is also degraded.

Syncs are stripped from the incoming video using a classic saturating PNP transistor circuit. To function efficiently the level needs to be around 4v pk-pk and the waveform mildly differentiated to improve line recovery times. In addition the DC bias may be adjusted to handle difficult signals.

The NBTV standard defines field sync as an absence of line syncs once per field. If no measures are taken to regenerate this missing pulse then the displayed line following field sync will be late and appear "ragged".

The stripped syncs are fed to the field detect retriggerable mono. The period is so chosen that in the presence of line sync pulses the mono never actually times out. During the field sync period the absence of a line pulse is detected by the mono timing out, producing a pulse sometime late during line 32 and terminating at the start of the next line sync.

This pulse is used to reset a divide by 32 down counter 40103. This counter

outputs a carry pulse at the end of 31 counts and this in turn fires a one-line mono whose trailing edge is adjustable to match the missing line pulse.

A mix of this pulse edge and the other 31 pulses is used to soft lock a free running 7555 astable with a 317 used as constant current source and low Z output stage. Fast flyback of 25µs is achieved and in most display applications blanking is not necessary.

The field reset pulse from the 40103 also resets the field scan and produces a very fast flyback of 40µs of the 80mS scan. Such a fast flyback is desirable since in NBTV no additional time is specified to accommodate field retrace, other than that defined for line. If the display device has an appreciable flyback period, then part of the first line is lost and smeared across the display during retrace, unless it is blanked out.

An optional linearity control is provided for if the scan is to be fed to an ac coupled display with reduced LF response.

Because of the coarse nature of the NBTV raster, with only 32 lines, spot wobble is desirable to blur the lines in the horizontal direction, (NBTV scans are at 90 degrees to those of a normal TV raster).

A free running unijunction oscillator mixed into the field waveform produces this, with a polarity switch allowing for a choice of field scan direction.

The X-Y display I use has a poor HF response in the X direction and so the level of spot wobble has to be increased accordingly.

In operation the sync stripper should be set on the "weak" side as the circuit can only cope with missing pulses, not additional pulses.

Set the line oscillator to run slightly slow. Then advance the line trigger control to mix in pulses and achieve a loose lock. With a healthy signal this has a broad locking range. With indifferent signals the two controls need to be tweaked to achieve lock.

The 40103 will carry on counting by 32 in the absence of any detected field pulses, since the carry out is fed back to the sync preset enable.

When a field pulse is presented to the counter it re-establishes field phase (if necessary) by asynchronously pre-loading the counter to 31. Changing the jam load to 29 should allow the circuit to function with the 30-line standard.

A mixed output of field and line pulses allows a scope to be easily triggered from the same triggering signal.

I have experimented with 2:1 interlace, but the 6.25Hz frame rate is too low for the eye to perceive it as such on a direct display. The net effect is of a raster hopping sideways. However using a PC to act as both frame store and display device has yielded some very impressive results and has also allowed the pictures to be recorded onto disc, but that is another story (article)!

This article is reprinted from Vol. 24 No 3 of the NBTVA newsletter, March 1999. For more information on the NBTVA, visit their web site mirror at www.batc.org.uk/nbtva.htm – ED.

Random Musings

By Grant Dixon

I have been asked to write a few words about the early days of BATC and I can only do this from a personal viewpoint, so where shall I begin. In 1948 I had started teaching Physics at the Bacup & Rawtenstall Grammar School after taking a Diploma in Education at Sheffield.

I was keeping in touch with a Sheffield amateur and he told me that he had built up a television receiver out of old radar gear and he was getting good pictures from Alexandra Palace. As the Sutton Coldfield transmitter was due to open soon, I started to build a TV receiver using 5 stages of RF amplification and a diode detector. Just before the Sutton Coldfield transmitter opened I changed my job and moved down to Ross-on-Wye where reception was thankfully much easier. The display device was a VCR97 6" CRT with a green screen. After an evening looking at a green screen I took the dog for a walk and was surprised to see a magenta coloured moon !

The move to Ross took place just before Jan 1st 1950 and it was at about this time that I saw a note in "Wireless World", signed by Mike Barlow, asking anyone interested in the transmission side of TV to get in touch with him. Of course this fired my enthusiasm and I wrote to Mike immediately and received a duplicated news-sheet entitled CQ-TV.

Evidently it all started off with a single letter which was to be passed on from member to member with added comments and details of projects. Of course the passing on bit was never done and it soon became apparent that a duplicated sheet was needed so that one could be sent to every member, so CQ-TV was born.

I went along to the first BATC Convention and took along a sync pulse generator which I had made. This was on two aluminium chassis mounted one above the other; the lower one was for the power supply and the upper one

carried two multivibrators, for line and frame sync, and a diode mixing circuit. It was at this Convention that Mike slapped me on the back and said "A good start, but at the next Convention I want something in colour."

That set me thinking and by Christmas 1954 I had built up a complete field-sequential colour TV system. This would not have been possible were it not for the fact that we had built up a good relationship with E.M.I. and they kindly presented us with a few Emitron Camera tubes which were not quite up to broadcasting standard. I had one of these tubes and had to construct my own scan and focus coils, the latter being wound on a lathe in the school workshop. I used a Mullard 5" magnetic viewfinder tube for the monitor, and both the camera and monitor were run with rotating discs of colour filters which had to be synchronised and phased correctly.

Two years later, in 1956, I took as much of the gear as would cram into my car over to Essex and we transmitted colour TV signals over a 13 mile path just two weeks before the BBC started their experimental colour transmissions. The actual public colour TV service did not start until 196812 years further on.

In the 1950s the newsletter, CQ-TV, contained all sorts of scraps of useful information some of which Mike Barlow obtained through his work at Marconi's. He did not like to publish it under his own name so he sometimes quoted me as a source. "I was speaking to Grant Dixon the other day and he said that....." and here followed a piece of technical stuff which was completely new to me until I read it in CQ-TV !

At this time television was a very new thing and various groups got together and gave demonstrations to the general public. The Dagenham Town Show was mentioned a number of times in CQ-TV and I think the leading light there was Doug Wheele. It was Doug's good fortune to be walking down Lisle

St, London when he saw something interesting in a shop window. The owner of the shop thought that it was a photocell and was asking 30/- for it, but when Doug offered 25/- he accepted it. In fact it was an RCA5527 Iconoscope camera tube and these were like gold dust at that time.

It was only much later with the arrival of the vidicon that the supply of camera tubes became easier. E.M.I. were very good to us and, over a period, sold us at reduced prices a lot of vidicons which had minor defects but were quite acceptable for amateur use.

My personal interests have changed from colour TV to Slow-Scan TV and now to the very early days of TV. My interest in TV was first stimulated in 1928, and in 1933/34 I made a disc Televisor using a neon lamp. I have now returned to this mode and am interested in applying modern technology to Baird's original system.

Times have changed, in the early days of BATC if you wanted a TV camera then you had to build one, and that involved valves and high voltages. Now you can buy a small, light, TV camera fairly cheaply. It probably is a better camera than a home built one but I think that a lot of fun has gone out of the hobby if you haven't got the satisfaction of saying "I built that myself".

It may be that building a decent homepage on the web is the modern challenge, so have a look at the NBTv section of the BATC site, or better still, go to my homepage at...

<http://homepages.wyenet.co.uk/gdixon>where you will see a lot more. These have been written in HTML with a simple editing program. HTML is not difficult, I started learning it at the age of 80.

Now what other challenges are there?

GB3XT Kits and Bits has MOVED

The new address and phone number for Bob Platts is:

Bob Platts
43 Ironwalls Lane
Tutbury
Staffordshire
England

 01283 813392



**3cms LNB. 0.7db noise figure, 9.0GHz local oscillator.
New price now only £35**

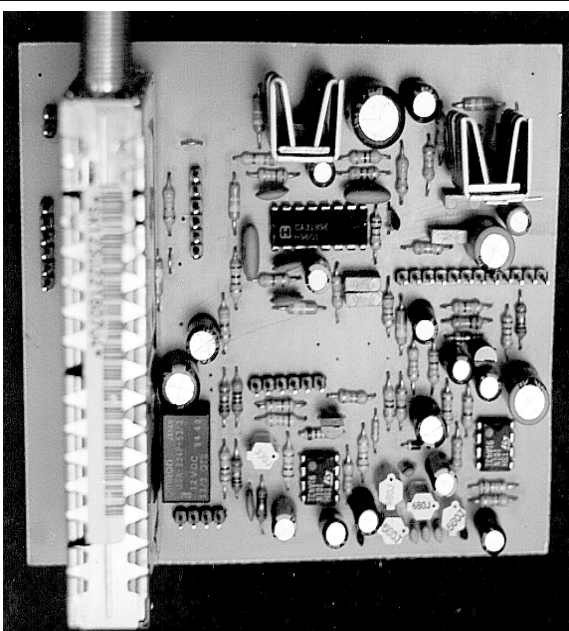

- The very popular Dove RX / IF kit.
- FM ATV Receiver or IF unit.
- 12vDC operation.
- Covers 925 – 1700MHz
- 6MHz (5.5, 6.5 available) intercarrier sound.
- Composite video output plus audio output to drive a loudspeaker.
- Baseband output. Pre-scalar output.
- Very simple to construct. No setting up or alignment required.

Only £42

Note: For 24cms a preamp is recommended.

Look out in a future issue of CQ-TV for the synthesiser article for this kit.

Gunmod2. The best selling Gunn diode or DRO Modulator.

- 5.5, 6.0 or 6.5MHz sound (state). Fully adjustable for video & audio deviation, output voltage & subcarrier.
- 12v DC supply.
- Easy to assemble and set up.

Only £20

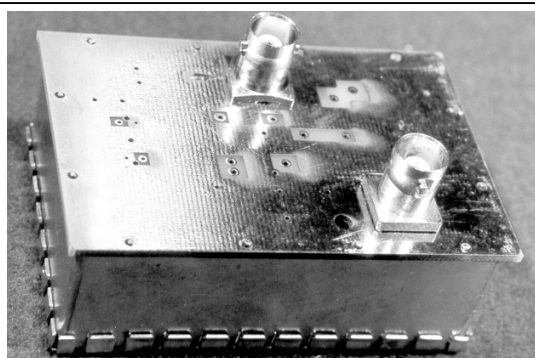
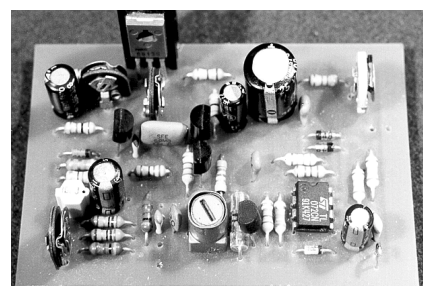

24cms pre amp.

- 40db gain 1db noise figure.
- Strong tin-plate enclosure.
- Quality BNC connectors.
- 12 – 20vDC supply via co-ax.
- Idea for use with satellite RX's or Dove kit.

£60 kit, £70 assembled and tested.

All prices include postage and packing. Cheque with order please.

TV on the Air - Shuttleworth Edition

By Graham Hankins G8EMX.

Our editor has asked his contributors to give a "looking back over 50 years" flavour to their pieces this time, so here goes with '50 years of TVOA'.

I can certainly go back 45 years for you, Ian (not me, personally, but from a set of CQ-TVs from a 'Silent Key' collection. 'CQ-TV' No 22 – October 1954 has a page headed 'What the other chap is doing...' which opens with: "A long letter from Ian Waters (Ely)..." Ian is, of course, still around. Sixteen other names are included on the page, and they were building cameras, pulse generators, and trying to keep a 16mm projector and camera in step with mains and frame sync. There were reports from Sweden and Australia. No compiler of the page is given, but in CQTV 24 the page is more casually called 'What the other bloke is doing' by one Vladimir Pffoudlesnitch (???)

The very first 'TV On The Air' appeared in CQ-TV no 91 (August 1975) Compiled by John Wood

G6AHT/T G3YQC. Within John's opening remarks are some telling words: "It is hoped through this column to show people just how much real activity there is in amateur television". John continues: "The purpose of this column is to report on the non-technical side of ATV so, if you are active, doing anything special, achieving any outstanding contacts, in fact anything concerned with activity please let me know." As relevant today as then!

John put a TVOA column into the magazine until Andy Emmerson G8PTH took over in November 1980, with issue 112. Andy went on to produce 60, yes sixty TVOA columns with a 'swan song' in November 1995 (fifteen years later!) which began: "Just one report this time, but what a report...." which went on to describe Bob Platts contacts between UK and Netherlands across water on 10GHz. Andy concluded his final TVOA like this: "This last column of mine has depended entirely on the efforts of just one BATC member - and a kindly TV-Dxer friend - without Bobs contribution



you would have had no on-air news at all this time. Think about it".

So I have been with the TVOA 'brief' for four years, which makes sixteen issues so far! It has been, and continues to be a bit hard-going – not to write the words, but to find news to write about! I would like to thank the following ATV groups who do send me their newsletters – Severnside, 'Line Out' from the High Wycombe Group, the Kent Television Group, the Southampton Club for Amateur Radio and Television (SCART), the Leicester Repeater Group. And for the very occasional individual contributions.

Fixed station ATV is reasonably commonplace and so too is ATV/P from various hilltops, but what about ATV/M? The Kent Television Group (KTG) runs the 24cm ATV repeater GB3KT and their latest newsletter shows KTG member Andrew White G6OLV fully walkabout mobile, using a camcorder and Solent 1W 24cm transmitter attached to the camcorder's tripod socket. Andrew is using a home-brew quarter-wave antenna, with a ground plane of unetched p.c.b. The antenna is weather-protected with a radome made from an inverted ice-cream tub!

The West Devon ATV Group put on a larger ATV/M exercise on Saturday June 5, when they provided vision coverage of the second annual 34 mile Ultramarathon Road Race, near Princetown on Dartmoor. Around 100 runners took part, with the WD Group following on a motorcycle equipped with a 24cm ATV radio camera. With a control room set up in Princetown School and 10GHz links within the town, lengths of coaxial cable were

used to feed race pictures to pubs and cafes in the town. My thanks to Tony Reynolds G8CEQ for this news.

Now some repeater news and P T E Fuller G0PVQ writes (yes, *writes*, a letter was received early May): "The Crawley ARC are hoping to soon have their 24cm ATV repeater back up and running, once we have received the licence from the R.S.G.B". Many thanks for that, but can correspondents please include their first names - it's so formal and impersonal otherwise!

The move of Coventry repeater GB3RT to Leamington Spa is still 'in hand' and only a couple of months away, according to an information sheet at the BATC rally in April. No further confirmation news at the moment, I'm afraid.

The Beacons Repeater Group will be pressing ahead with their 24cm ATV project north of Birmingham, but it seems that a replacement length of transmitter feeder is needed. There is a very high s.w.r. and the surplus Andrew Heliax presently installed has

become badly bent, so a fresh run of new coax is probably called for. A new member to the BRG is available as a Closedown Operator.

A quick reminder now about protocol when using the 2m band for ATV talkback. The 2m frequency of 144.750 is an ATV CALLING channel. When a QSO has been established, stations should find a clear frequency and move off the calling channel. I experienced this problem in Birmingham recently; 144.750MHz was in continuous one-way use by an ATV station working cross-band to 24cm. His speech path was 2m - the other station was able to use the 6MHz audio sub-carrier on 24cm.

The 'Ultramarathon' DID happen and the Group achieved their ATV coverage, just about. Weather was absolutely appalling, heavy rain, various breakdowns; motorcycle flat battery, pub TV that did not respond to the cable signal on the day (but worked ok the night before) reserve motorcyclist who got lost, lack of some manpower on the day etc.

ATV contests - yes or no?

By Guenter, DJ4LB

(translation: Klaus, DL4KCK)

Phrases like "studying the contest results it appears to me that the German participation is falling year after year. There seems to be no reason to come on air at least once a year - although they are qrv..." has not been edited in 1999, but already 20 years ago, after IATV contest 1979 by Volkmar Junge, DF2SS, in TV-AMATEUR #37. On another page in there Diethelm E. Wunderlich, DB1QZ, is citing another frustrated competitor: "You cannot run a contest on your own!" Exactly this realised Georg, DH8YAL, at the (AGAF) winter contest 1998.

It were predicted in TV-AMATEUR 101: "...there is nothing done about until the last contestants cannot find any partners and are giving up - that will be the natural death of ATV contests." Although being the editorial theme it did not evolve as running gag of the year. Even after requests by AGAF not a single comment came in, neither from contesters nor from repeater hosts, also not from Georg, DH8YAL. So there was no answer on the question in the headline: "ATV contest - what to do now?"

Meanwhile Georg has proposed cancelling of all contests, his reasons.

1. (Suffering participation) is reality. But why - this can only answer the absent ATVers. Sometimes you can hear "I did not know that it was contest time" or "It's more fun at the repeater". Reason nr.
2. (Less logs) is also true, the times of 50 logsheets in a pack from AGA Fare over. Today you have to assemble one from issue 106 and 108 of TV-AMATEUR - but that is not the real reason, isn't it?
3. The repeaters, is ATV specific, as in other modes repeater

frequencies are separated from simplex or contest frequencies. But there are solutions possible: 2 ATV repeater sysops in the Rhein-Main area switch it off and participate in the contest - really! Another repeater output on 10 GHz can be passed by. Very fierce collisions seem to appear in the Ruhr area, but in "CQ DL" 2/99 one can read: "(FM-) Repeater shutdown in the Ruhr area because of misuse, offence..." It would be embarrassing if the OM responsible for ATV repeaters in this region who did not switch off their relay for at least one international ATV contest per year were forced to shut down because of much more inconvenient occurrences.

4. The ATV calling frequency, is overloaded at contests by too many participants or by individuals who take much time for difficult contacts. This shows: the better equipment and proficiency are the shorter time the 144,750 MHz is blocked. At the end we should mention the (AGAF) contest cup - not really supposed to belong to a high-tech hobby. It is not easy to say if it works incentive for contesting or rather deters ATVers because of displacing room for construction materials...Getting serious: should we abandon contests or try to adapt to the new situation?

IATV contest: because of lacking results of IATV contest 1998 until now (in Germany even of 1997 until recently) there is no international contest in fact any more! No participant is aware of his rank in international terms. We in DL cannot abolish the international contest on our own, but this is not necessary, as it does not exist for us in reality. This leads to proposal:

1. Ignore the IATV contest (if you think it is alive after all try to

participate). The advantage is there are no different contest rules any more.

2. AGAF contests: abandon the AGAF winter contest in December, as portable sites are without reach and participation is very low.
3. As March can bring critical whether conditions too AGAF should arrange contests in April, July and October, of course open to all countries. Advantages: September, one of the mostly used holiday months, is left contest free - no collision with UKW-Tagung Weinheim - and last not least: TV-AMATEUR comes out in the month before and can remember us on the contest in time.

Contest alternatives?

There is a possibility to maintain and promote sporting competition in the ATV mode, independently from contests being a reality or not. What about installing an "AGAF DX list" after the example of DUBUS top list? These are frequency band tables with self-reported facts like QTH locator, number of contacts and top DX. ATV activities like long distance contacts, exploiting new bands and the like would be presented in tables. Organising efforts seem to be little instead of publishing contest results. All readers would know which stations are active on what bands and what distances they spanned. Additional advantage: ATV activists would not need to strive hard on a few contest days, but could test new distances at certain times with favourable conditions - amateur radio pure without infrastructure. I want to close with the last sentence from my editorial in issue 101: "...hoping that more than one thousand members are more imaginative than one single."

VHF COMMUNICATIONS

VHF COMMUNICATIONS magazine is published quarterly and is available from **KM Publications**, 5 Ware Orchard, Barby, Nr. Rugby, CV23 8UF, England.

Telephone: 44 (0) 1788 890365, Fax: 44 (0) 1788 891883

Email: vhfsubs@vhfcomm.co.uk

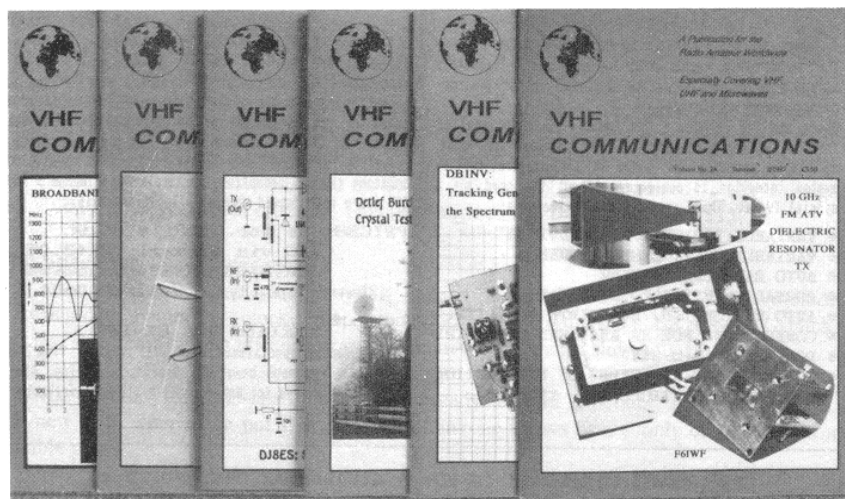

The 1997 subscription rate is £18.00 for cash or personal cheque (drawn on a UK bank, or bearing the name of a UK banking agent), postal orders or bankers draft made payable to KM Publications. Payment may also be made by any major credit card at £18.90. The subscription included surface mail charges, airmail is extra at £6.50 per year (£6.85 by credit card). The magazine is a MUST for the radio amateur and professional engineer interested in VHF, UHF and Microwave working, containing, as it does, detailed construction articles for equipment operating in these bands.

Back Issues: special offers -

enquire for details

Binders to hold 12 issues £5.50
Complete Index 1970 - 1995..... £2.75

Email: vhfsubs@vhfcomm.co.uk Web site: <http://www.vhfcomm.co.uk>

Secure credit card page: <https://www.vhfcomm.co.uk/saleform.htm>

Sevenside Television Group

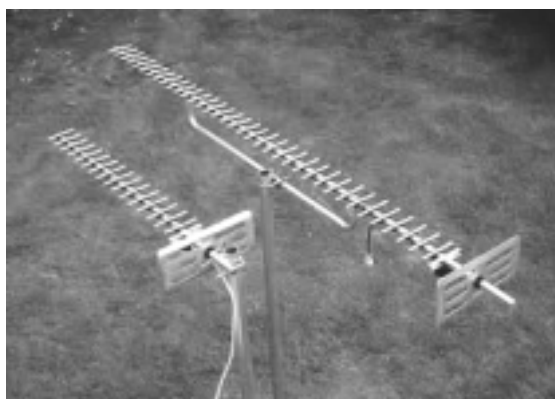

All of our 23cm aerials are specifically designed for ATV use – although they can be used for other modes as well. Wideband characteristics mean that you need only one aerial to cover the repeater input and output channels. Our famous wideband yagi's come fully-assembled in two versions:

38-ELEMENT HIGH-GAIN: 14dB gain, 1.8 m long, **£26.00** plus p&p.

18-ELEMENT STANDARD: 10dB gain, 0.9 m long, **£15.00** plus p&p.

Don't forget our **20-ELEMENT CONVERSION KIT**, which converts your existing 18-element aerial to the full 38-element high-gain specification: **£13.00** plus p&p.

All our aerials feature an SWR of less than 1.5:1 and are supplied with mast clamps suitable for masts up to 55mm diameter (mast poles not supplied).

Postage: £3.75 for one aerial, **£5.00** for two or more. Orders from outside of the U.K please write first for a carriage quotation.

Cheques should be made payable to "SEVERNSIDE TELEVISION GROUP" and sent to (*new address*):

13 Downs Road, Westbury-On-Trym, Bristol BS9 3TX

Available soon from Sevenside Television Group:

A long-overdue update of G8VPG's "Guide to ATV", now available on **CD-ROM**, viewable with your current Internet Browser. This CD includes copious amounts of colour pictures and diagrams for the ATV enthusiast both new and old.

As demonstrated at the BATC Rally. Enquiries to the above address.

UHF TV Masthead preamp

By **Graham Baker, ZL1TOF**

As narrow band aerials and amplifiers, normally used for amateur television, are not suitable for broadcast reception I put up a commercial UHF TV aerial and diplexer. The next step was to get a decent preamp near the aerial to deliver adequate signal to run a number of TV outlets. The SPECTRUM low noise preamp has too little gain to deliver the goods and adding another stage like the Wellington VHF premium performance preamp just increases the intermodulation distortion.

put out 107 dBuV (-2 dBm) for -60 dB intermodulation on the three-tone test.

The amplifier could be laid on a sheet of copper or brass with the ground connections bent into an "L" shape and soldered to the sheet. The other connections could be made self-supporting or supported on small pieces of PCB glued to the ground sheet. I made a double-sided PCB for the OM2064 with 75 ohm striplines and BNC connectors at each end. All the capacitors are 3.2 x 1.6 mm surface mount types. The amplifier is powered through the coax and mounted in a die-

the receivers. John Wood² uses a high pass filter in front of his amplifier so I did the same and that cured the ghosting.

The shunt regulator was added after my first amplifier was damaged when lent to another amateur for assessment.

Coil details: L1 and L2 are made together, 3 turns of 0.35 mm wire on a ferrite bead (DSE R-5400) and 3 turns close wound on a 3 mm mandrel. L3 and L4 are 1.75 turns of 0.5 mm wire on a 3 mm mandrel spaced 1.5 mm above the PCB conductor. The coils, L3 and L4 must not couple.

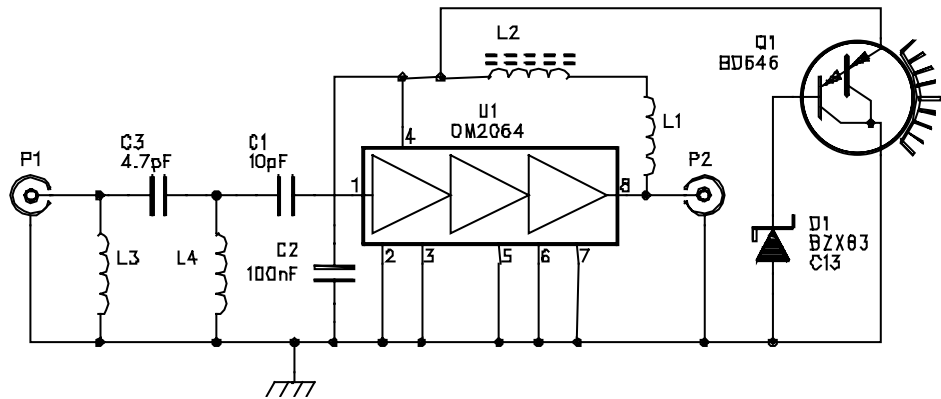

Figure 1. Masthead Preamp Schematic.

Commercial amplifiers used the OM350 and OM361 since the early 80's. These have noise figures of about 7 dB. Newer types are available and cost no more than the old types. The OM2064¹ (RS Components 284-589) has a gain of about 28 dB and a noise figure of about 4.4 dB. Best of all it can

cast box (Farnell 301-528 or DSE H-2221) like previous models.

I noticed ghosting on the VHF channels after I put it into service. Because the amplifier was broadband (40 to 860 MHz) it amplified the distorted VHF signals picked up on the UHF aerial and fed them through the diplexer into

I built a second amplifier using the same design but with "F" connectors. Using a spectrum analyser I aligned the high pass filter to roll off as high as possible with minimum attenuation at 440 MHz. This amplifier is in use at the Auckland VHF Group club rooms and exhibits good performance on both 443 MHz and 615 MHz.

References

1. "Hybrid integrated VHF/UHF wideband amplifier OM2064", *Philips Data Handbook SC16*, 1995.
2. John Wood, G3YQC, "TV Distribution Amplifier", *The Best of CQ-TV, Volume 2*, 1989.
3. Peter Phillips, "The 'Miracle' Active TV Antenna", *Electronics AUSTRALIA*, May 1992.

Free Internet Dial-Up Accounts for BATC members

Caladan Communications, a UK based Internet Services Provider are pleased to be able to offer BATC members free dial-up access to internet e-mail and news services. Contact Chris Smith (G1FEF) for more details:

E-mail: sales@caladan.co.uk Fax: 01933 666972, Web site: <http://www.caladan.co.uk/batc>

Or write to: 'Free BATC offer' Caladan Communications 25 Dando Close, Wollaston, Northants, NN29 7QB

BATC Publications

Publication	Each	Qty	Total
An Introduction To Amateur Television (225gm)	£5.00
The latest handbook full of detailed information on how to set up your ATV station, plus lots of new video and RF construction projects.			
Slow Scan Television Explained (275gm)	£5.00
The latest SSTV handbook detailing all the information you need to enter the fascinating world of Slow Scan Television: Basic principles, explanations of all the modes to date, commercial hardware and computer-based SSTV systems. Also various construction projects for SSTV equipment.			
The Amateur TV Compendium (155gm)	£3.50
The BATC handbook featuring construction articles on video units, 24cm and 3cm ATV, a Digital Frame Store, and much more.			
The Best of CQ-TV (150gm)	£3.50
A compilation of the best construction articles from CQ-TV's 133 to 146			
CQ-TV Back Issues:	£1.50
The following issues are still available. Please circle those required: 142, 143, 144, 147, 150, 153, 154, 156, 158 159, 162, 163, 164, 166, 167, 168, 169, 170, 171, 173, 174, 175,176, 177,178, 179, 180, 181.			
Special Offer: Any four of the above issues	£5.00
182, 183, 184, 185	£2.50
Index on a PC format disk (25gm)			
This item has now been discontinued, as this index is included on the BATC CD.			
CQ-TV Binders (A5 sized)	£3.50
The BATC CD (IBM type PCs only)	£5.00
Total Goods and Postage - Amount Enclosed.			£.....

The indicated prices for **Publications** include postage within the EEC. Will members outside the EEC please either try to estimate the extra postage required, or write for a quotation.

Publications orders *ONLY* to: **BATC Publications, Fern House, Church Road, Harby, Notts., NG23 7ED, England.** Tel: 0152 270 3348 (Evenings/Weekends only please).

E-mail: publications@batc.org.uk.

Name:		Mem No:	
Address:			

Members' Services

A description of the various PCB's and components can be found in the 'What's What' guide, or on the BATC Internet pages. URL <http://www.batc.org.uk> (A printed copy available on request, if you send a S.A.E.). Components for club projects are not available from Members Services unless contained within these lists. All club crystals are HC18/U (wire ended). To avoid delay and inconvenience, please be careful to include the correct payment with your order – please do **NOT** send stamps or cash. Post and packing costs are for despatch of one item to United Kingdom members.

Circuit Details can be found as follows:

Revised ATV Handbook (vol. 2): PCB's 21, 22. **An Introduction to ATV:** PCB's 10, 25, 36, 40, 41, 47, 85, 86. **TV for Amateurs:** PCB 19. **Slow Scan TV Explained:** PCB's 59, 60, 61, 62. **Amateur TV Compendium:** PCB's 12, 27, 54, 55, 56, 57. **CQ-TV (Issue No. in brackets):** PCB's 7(174), 13(128), 16(134), 20(130), 26(142), 58(139). Item 46 is supplied with circuit details, etc

CAMERA TUBES A tube guide appears in CQ-TV 149 and 150. Tubes are now difficult to obtain and members requesting information on availability, prices or other types of tubes or equivalents are asked to send a stamped addressed envelope for their reply.

	All prices in UK pounds (£)	Each	P&P	Qty	Total
Camera Tubes, Scan Coils, Bases & Lens Mounts					
3	One inch Vidicon base	£1.20	£0.30
4	2/3 inch Vidicon base	£0.80	£0.30
6	Camera tube (see note above)	*	£1.20
Video and I²C Circuit Boards/Components					
7	Sync pulse generator PCB	£12.00	£0.43
12	Teletext pattern PCB**	£3.50	£0.43
13	Greyscale/Colour bar generator PCB.....	£3.50	£0.43
16	PAL colour Coder PCB**	£7.00	£0.43
19	Video filter PCB	£1.20	£0.30
20	Video processing amplifier**	£4.70	£0.43
21	Vision switcher matrix**	£4.70	£0.43
26	Video level indicator PCB	£5.90	£0.43
40	I ² C CPU PCB.....	£10.00	£0.43
41	I ² C VDU PCB.....	£10.00	£0.43
42	13.875 MHz crystal.....	£4.70	£0.30
70	6.0 MHz Teletext crystal	£1.75	£0.30
43	SAA5231 genlock IC.....	£8.80	£0.30
44	SAA5243PE Teletext IC.....	£14.70	£0.30
45	PCF8583 Clock IC.....	£7.00	£0.30
39	LM1881N Sync separator IC.....	£3.50	£0.30
81	I ² C 27256 EPROM	£9.70	£0.30
37	GX414 Video switch IC	£8.80	£0.30
38	PCF8574P Input expander IC	£4.70	£0.30
10	I ² C Relay PCB	£6.50	£0.43
9	PCF8574A Input expander IC	£4.70	£0.43

All prices in UK pounds (£)		Each	P&P	Qty	Total
RX, TX and SSTV PCB's and General Components					
47	70cm up converter PCB	£13.50	£0.43
50	108.875 MHz crystal.....	£8.20	£0.30
86	24cm solid state amplifier PCB	£10.50	£0.43
55	Gunn diode modulator PCB.....	£3.00	£0.43
56	10Ghz head unit PCB set**	£3.00	£0.43
57	Tuneable IF PCB**	£3.00	£0.43
88	XR215 phase locked loop IC.....	£5.00	£0.30
60	G4ENA colour etc. SSTV mod PCB set.....	£5.90	£0.43
61	G4ENA SSTV transmit mod PCB	£7.00	£0.43
62	G4ENA auxiliary PCB.....	£2.35	£0.30
68	4.433618MHz crystal.....	£3.25	£0.30
69	5.0MHz crystal	£3.25	£0.30
46	4 Rail power supply PCB.....	£3.50	£0.43
Stationery & Station Accessories					
73	BATC blue diamond clutchpin badge.....	£1.75	£0.30
74	BATC cloth badge	£4.00	£0.30
75	BATC equipment label (6)	£0.25	£0.30
76	BATC square windscreen sticker.....	£0.10	£0.30
78	BATC test card	£0.50	£0.43
79	BATC reporting chart	£0.10	£0.43
Total Goods and Postage - Amount Enclosed					£.....

Members Services orders ONLY to: Mr. P. Delaney, 6 East View Close, Wargrave, Berkshire, RG10 8BJ, England. Tel: 0118 940 3121 (Evenings, Weekends only please).

Items from these lists can **ONLY** be supplied to **CURRENT** members of the BATC. These lists supersede all previous ones.

The indicated **P&P** prices are for postage within the EEC. Will members outside the EEC please either try to estimate the extra postage required, or write for a quotation. All cheques **MUST** be drawn on a UK bank. (Eurocheques, in £ sterling, are acceptable). Items marked thus: ** are available only until present stocks are exhausted.

PLEASE MAKE CHEQUES PAYABLE TO 'BATC'.

Name:		Mem No:	
Address:			



**A must for all
PC owners.
Hundreds of
back Projects,
many not
available in
any other
Format.**

Send orders to
the BATC
Publications
department.

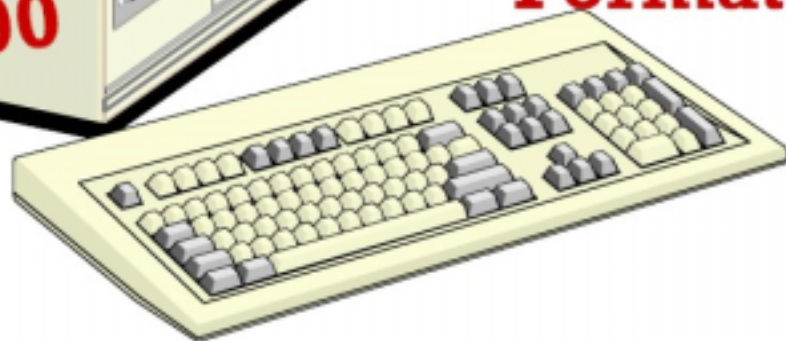

9GHz DRO pucks £6 each

Also small quantities of

8.6, 9.4, 9.75/9.8, 10.3 and 10.6GHz.

Exact frequency depends on operating conditions.

Cash or cheque made payable to:

Beacons Repeater Group,

40 Monument Avenue, Wollescote, Stourbridge

DY9 8XS, or telephone Alan Kendal G6WJJ

01384 894512 7-9pm weekdays

Two Filters and a Diplexer for 23cms

By Ian Waters G3KKD

This article describes two interdigital bandpass filters for 23cm that have been designed, made and tested to information contained on pages 6-39 to 42. of the ARRL publication "UHF / Microwave Experimenters Manual". It also describes a diplexer that uses one type of filter to enable transmission and reception via a single antenna.

response of filter B is shown with an expanded frequency scale in Fig 2.

It may be mentioned that the ARRL information covers the design of 23cm filters from 3 to 8 active elements and percentage bandwidths from 1 to 10%. In total 4 filters have been made using the ARRL data; they have all performed exactly as expected and have tuned up without difficulty. This gives confidence in the data that is

Construction

The filters can be constructed in aluminium, as I have done, or using silver-plated brass. Plated brass would probably give a better performance, although it is difficult to say how much better, but would be much more expensive.

The mechanical details of filter A are given in Fig 3 and those of filter B in Fig 4. They are quite simple to construct provided that a small lathe and the usual hand tools are available, but the work especially for filter B, is quite time consuming. If no lathe is available the services of a friendly model engineer might be obtained.

The top and bottom plates are made from 1" x 1/4" stock aluminium strip. The side plates are cut from 16 SWG or preferably 14 SWG aluminium sheet. The top and bottom plates should be drilled and tapped M3 or 4 BA and the sides attached with screws at 1" intervals. Care should be taken to remove any burrs and ensure good contact.

The rods are turned down from the next largest size of stock aluminium rod. They should be accurate to within $\pm 0.002"$. They are centre drilled and tapped for attachment to the top and bottom plates using any suitable screws. The tapped ends are

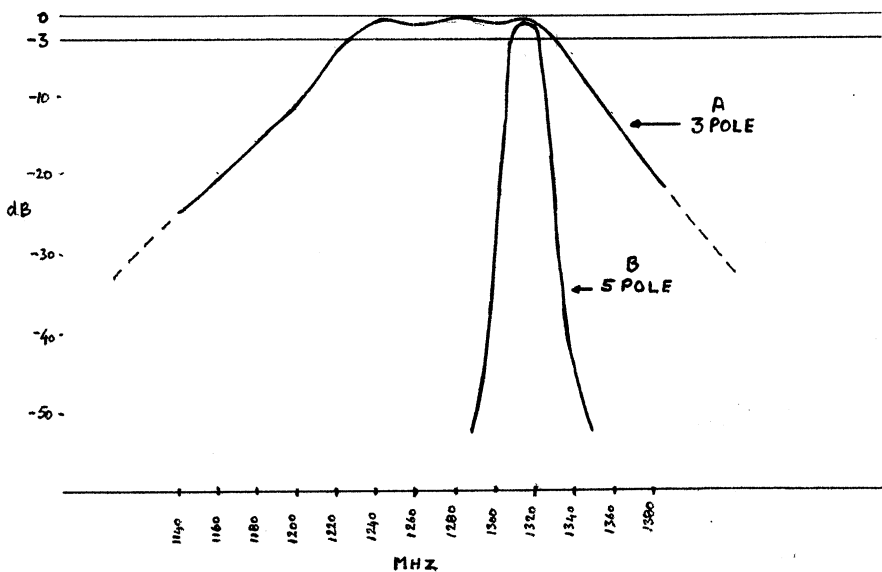

Fig 1 MEASURED AMPLITUDE/
FREQUENCY RESPONSES, FILTERS
A & B G3KKD 20-3-1999

Filter A is a fairly simple design of modest performance with 3 active elements. It has a -3dB bandwidth of 8.2% or 105 MHz centred on 1282.5 MHz and thus covers the whole 23 cm band. It has a VSWR of 1.5:1 and, when made in aluminium, an insertion loss of approx. 1 dB.

Filter B is a somewhat more complex design with 5 active elements and a much better performance. It has been designed to have a -3 dB bandwidth of 1.1% or 14.5 MHz centred on 1316.0 MHz. and thus covers the RMT-2 repeater output channel, although it can be tuned to cover any other 14.5MHz segment of the band for instance a repeater input channel. It too has a VSWR of approx. 1.5:1 and, when made in aluminium, a slightly higher insertion loss of 1.5 dB.

The **measured** amplitude frequency responses of these filters are shown together in Fig 1, while the **measured**

more than can be said of that in some other publications.

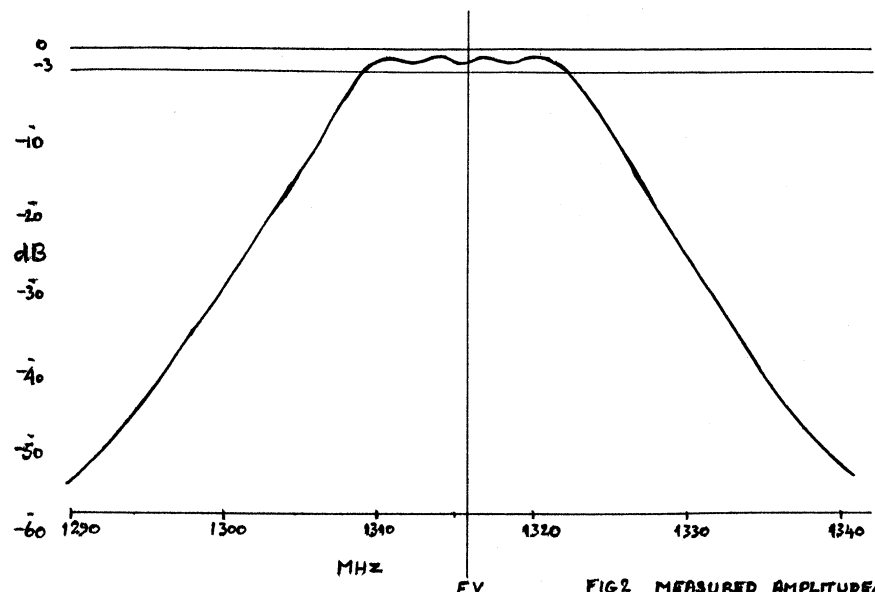

FIG2 MEASURED AMPLITUDE/
FREQUENCY RESPONSE FILTER B
G3KKD 20-3-1999

countersunk slightly to ensure that electrical contact is at the circumference. The end rods, or input and output transformers, are drilled to accept the centre contacts of the input and output plugs. These are clamped by small screws in tapped radial holes at the ends of the rods.

and the shape to be optimised with minimum ripple. One problem is to first tune the filter to allow enough sweep signals to pass through it to enable alignment to start. With the 3-element filter it is not too difficult to randomly turn the tuning screws until something is seen. The larger number of permutations possible with the 5-

IF modulated transmitter to remove unwanted mixing products.

Filter B has been applied in a number of ways.

It can be used at the output of a transmitter, perhaps a repeater transmitter, to remove unwanted

ROD Ø
 1&5 0.514"
 2&4 0.327"
 3 0.353"

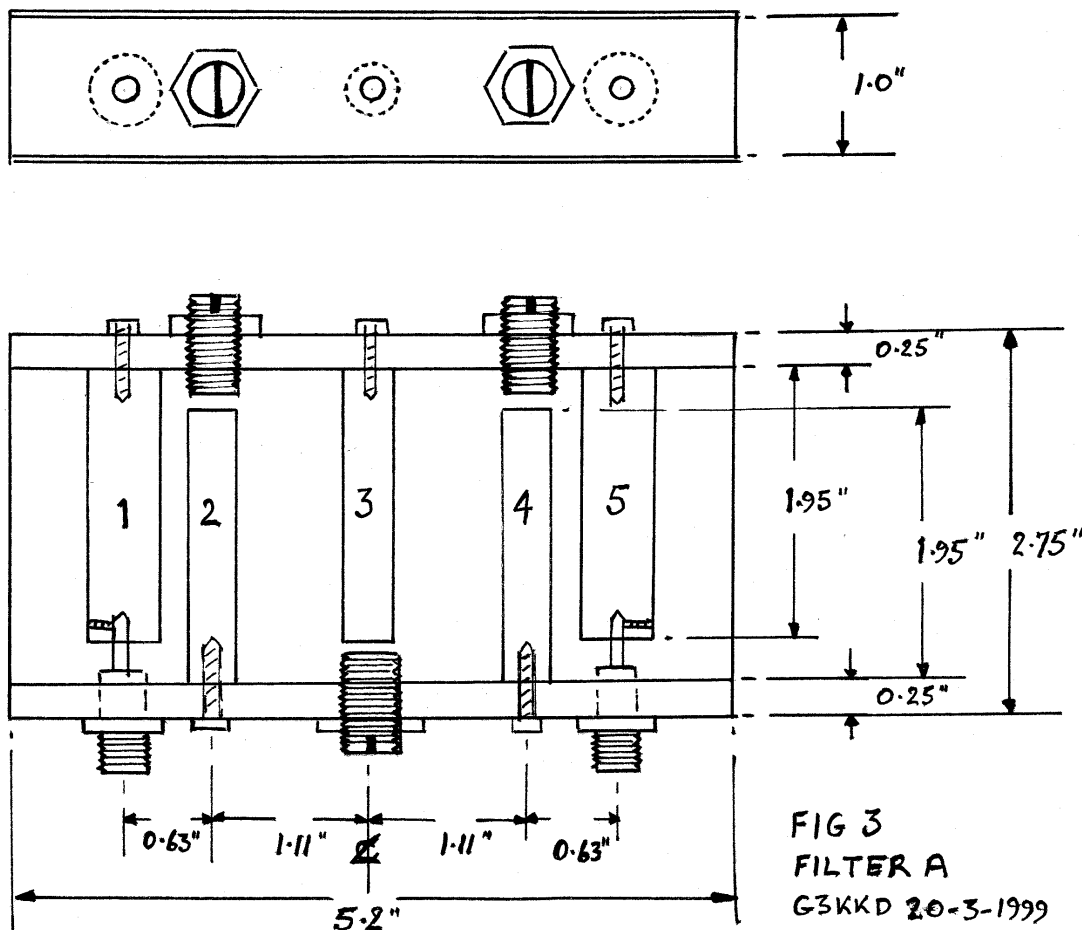

The tuning screws may be of any size from 1/4" to 3/4" and can use any fine thread for which taps and dies are available. I have used 32 threads per inch, which gives a very nice tuning adjustment. However care must be taken as fine threads can pick up and seize quite easily. Plenty of cutting paste or oil! Lock nuts are required which are tightened once the filter is tuned.

The connectors may be N, TNC or BNC to taste. The method of fitting will depend on the connectors available.

Tuning up.

I have to admit that I have tuned these filters up using a sweep oscillator with frequency markers. This permits the passband to be set exactly as desired

element filter make this much more difficult. I have inserted a CW signal at the passband centre frequency and looked for something at the output using a spectrum analyser. Once something is seen, even at -70 dB, the tuning can be quickly optimised. Another way, which I have not tried, would be to use a communications receiver.

I appreciate that not everyone has sweep generators and spectrum analysers. If anyone would like me to tune up a filter that they have made I would be happy to do so.

Applications

Filter A was designed for use as an image noise filter placed between the RF stages and the mixer in a receiver, or after the up-conversion mixer in an

modulation sidebands. If the insertion loss of 1.5dB is too much to loose, then assuming that the PA is a class AB linear brick amplifier, the filter may be placed between the drive stage and the PA. A class AB amplifier, if not overdriven, will not reinsert the removed sidebands and the loss of drive power can usually be made up quite easily.

It can be used at the input to a receiver, either at the home station or at a repeater to protect against adjacent channel, probably radar, interference.

It can be used at the home station in the feeder of a look through antenna to reject sidebands of the stations own transmissions that can degrade the look through picture.

Diplexer

Two filters type B, one tuned to the transmit frequency and the other to the receive frequency, connected together by a coaxial T junction, as shown Fig 5 can be used to make a very effective diplexer to enable transmission and reception via a single antenna. This may be used at a repeater constrained to use only one antenna, or at the home station to enable look through via a single antenna.

The T splitter is made from an N type coaxial connector and two lengths of semi-rigid coaxial line fitted into male N plugs. The length of these is such that the effective length from the centre

point of the T to the start of the filter input transformers is one wavelength taking the velocity factor of the coaxial line used into consideration. The theory is: Each filter has a reasonable match and so presents a low impedance at its passband frequencies, but a high impedance at the other channel some 65MHz away. The one-wavelength T arms transfer these impedances to the junction point. An incoming signal thus sees a low impedance path to the receiver, while the other path appears as a high impedance. Conversely the transmitter sees a low impedance path to the antenna, but the route to the receiver appears as a high impedance.

The transmit filter suppresses out of band modulation products, particularly any that may be in the receiver passband. The receiver filter also suppresses the transmitted signal and any other signals beyond the wanted receiver passband. Although its insertion loss degrades the receiver sensitivity by 1.5dB, the improvement in received picture quality in the presence of interfering signals makes this well worth while.

The transmit/receive cross loss is beyond the limit of practical measurement. When receiving a P1 picture, it is possible to switch the transmitter on/off without seeing any change in the received picture quality.

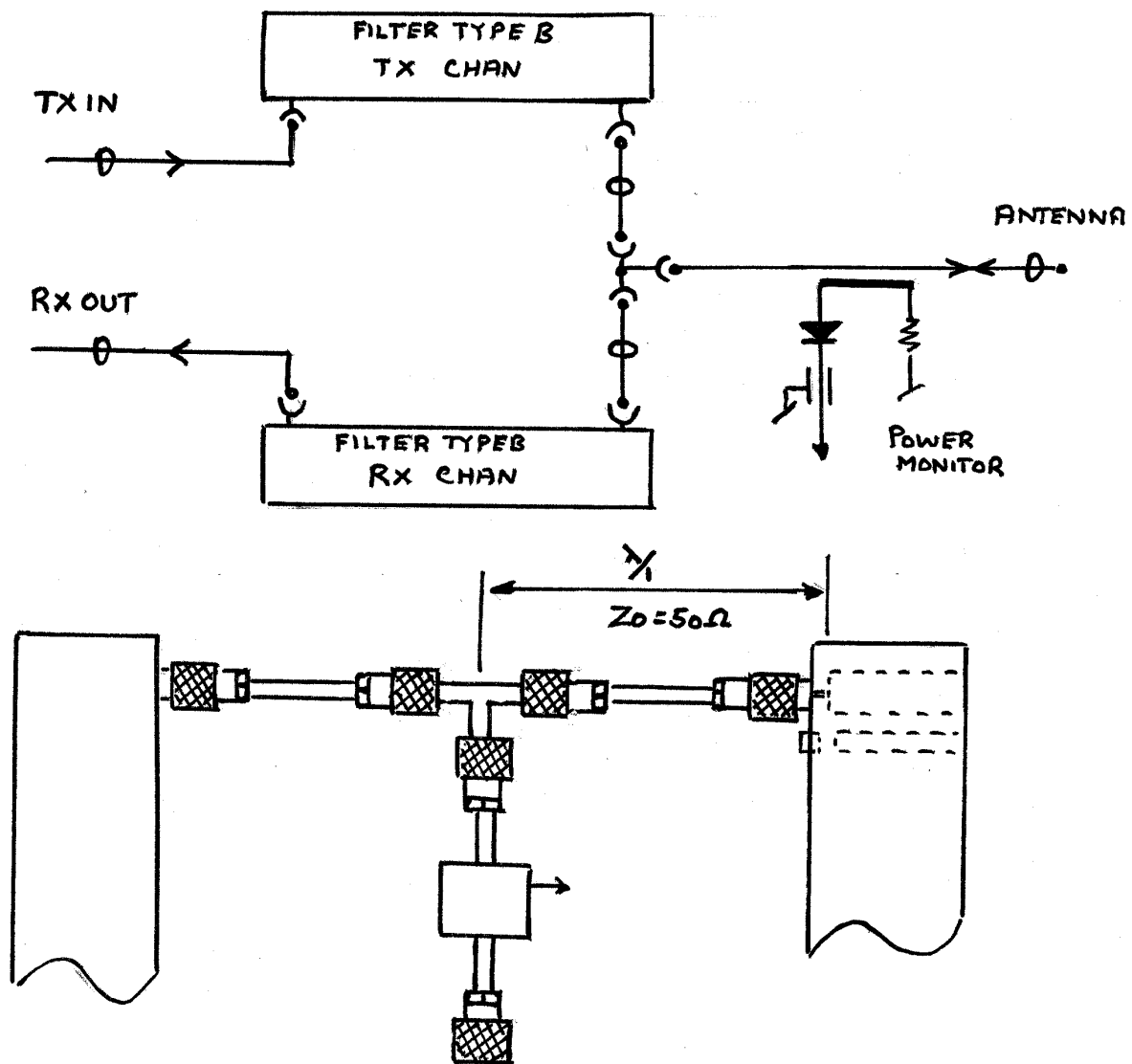

FIG 5

TX/RX DIPLEXER

G3UKD 20-3-1999

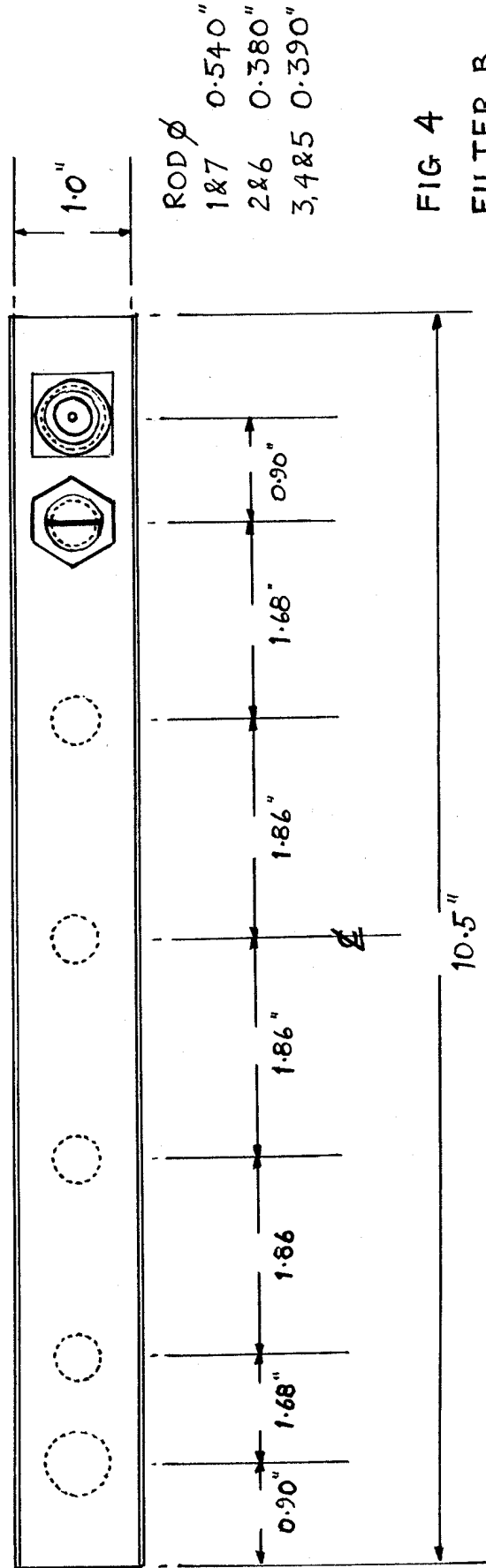
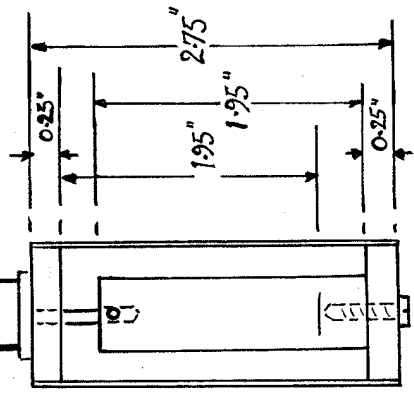
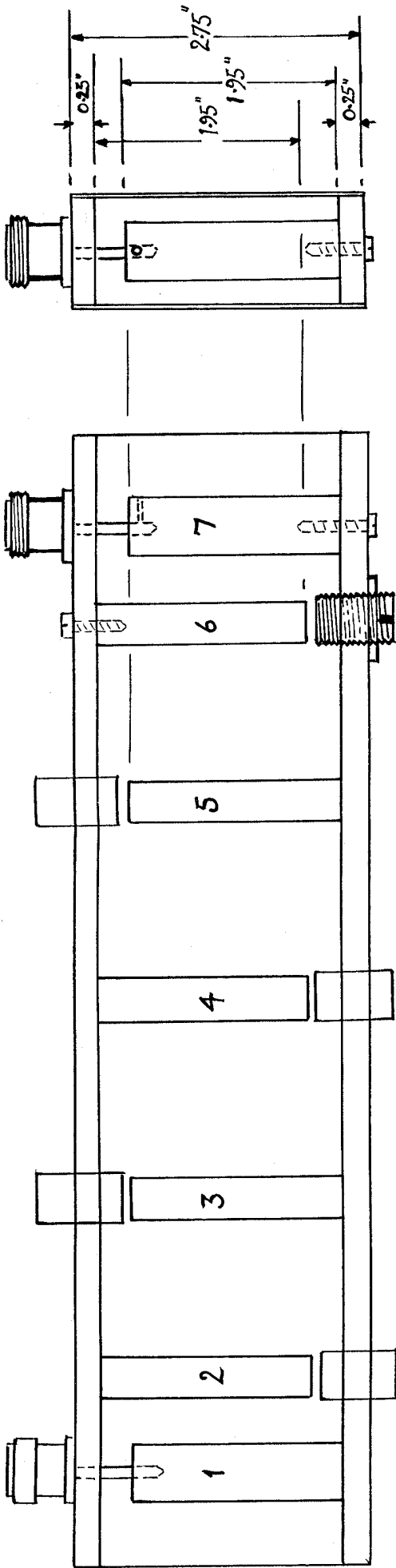

FIG 4
 FILTER B
 G3KKD 20-3-1999

Low cost on-screen text generator

By Brian Kelly, GW6BWX

Designs for overlaying text on video are not new to CQ-TV; several have appeared over the past few years. This article describes a design that is very simple to build and should cost less than £15 to build. Unlike most other designs, it also has a selection of pre-programmed messages that can be selected by a switch or logic control.

Circuit description

There are three sections to the design, each using one of the IC devices. Firstly there is a sync separator chip. The LM1881 was chosen for its low cost and availability, the EL4581 can be substituted if one is available in which case the capacitor across the 680k resistor can be omitted. This IC is fed with the composite video from the input source. It samples the levels of the video peaks and sync tips and then determines the optimum slice level to remove the video content from its input signal. Through an internal filtering system it then extracts the vertical sync and composite sync pulses, presenting them at its pins.

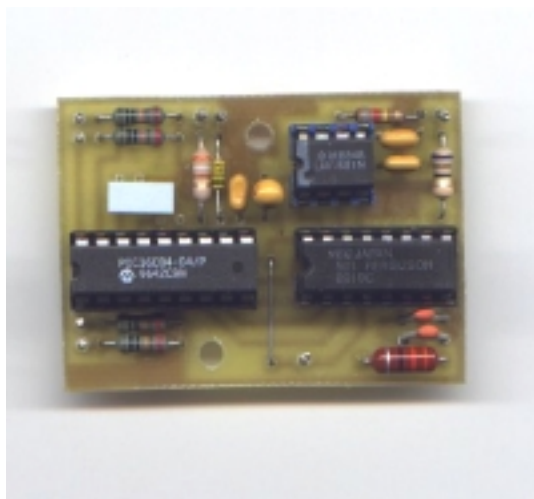

A prototype. A three pin resonator is used (the light coloured box above the 16C84), if a standard two pin resonator is used an extra two capacitors have to be fitted in the holes provided.

Both syncs are fed to the NEC graphics generator. I confess to knowing very little about this device except its source. It was salvaged from a Pace

satellite receiver, actually an SS6000 model although an almost identical device is used in the 9000 and 9200 models which are readily available at rallies for just a few pounds. Look out for the PRD800 and PRD900 models and their badged clones. These are usually scrapped when their power supply goes bang. The chip in the prototype was labelled "501" which may be a reference to the uPD6501 but I can't verify this. The chip contains on-board 64 bytes of RAM and a font (character set) stored in ROM. The sync pulses are used to reset its internal timing generators so the text can be displayed in a fixed position on the screen. By changing the values written to the chip it is possible to set the horizontal and vertical text placement. I have indicated the locations responsible for this in the source code. Also inside the chip is the dot clock oscillator circuit. It is tuned by an LC tuned circuit that sets the clock frequency at approximately 5.7MHz.

The third circuit block comprises our friend the PIC16C84 and its clock resonator. This chip produces the three signals which program the NEC IC and tell it which characters to display. Eight four-line messages are stored inside the 16C84; the message number is read from the logic state of the three selection lines. Resistors normally pull the inputs low which selects message 1. Pulling the select inputs high (+5V) will allow the other messages to be displayed. An on/off switch is provided via one of the remaining input lines. Because the NEC chip slightly loads the video line, it was decided to turn the overlay on and off under software control rather than by isolating the video output signal. This way the loading problem doesn't cause a shift in video level as the text is turned on. The



Off screen images of the eight default messages

on/off control is also pulled low by a resistor and needs to be pulled high to clear the screen. A five volt output is provided on the board to make selection easier.

Software

One of the more challenging aspects of PIC programming is coping with data and code which exceeds 256 bytes in length. Because these devices only have 8-bit wide program counters, it is necessary to combine two registers to reach addresses beyond 256 (FF in hex). In this design, virtually all of the chips 1k of storage is used, so in order to simplify the program, it is split into four blocks of 256. Most of the program resides in the first block (page 0). The second block holds two tables, the first is the list of bytes which are sent to the NEC chip to initialise it, the other block is an ASCII to font look-up table. To simplify the entering of messages I have used this look-up table so normal text can be entered. Without it, the message would have to be typed as a sequence of hexadecimal numbers. The final two pages hold messages 1 to

4 and 5 to 8 respectively. Note that the last line in messages 4 and 8 are shorter by one character; this is because of the jump instruction (ADDWF PCL) at the start of each page occupies one address, leaving one byte short at the end of each table. To customise the messages, simply replace the sample text with words of your choice. The whole alphabet, numbers 0 – 9 and some symbols are available. The chip actually holds a selection of non-alphanumeric symbols too. If you want to experiment, try changing some of the characters in the look-up table to see what you can find. Hint: the character codes start at zero and finish at 3F. After changing the messages, it will be necessary to recompile the program using MPASM, MPLAB or which ever compiler you prefer.

Construction

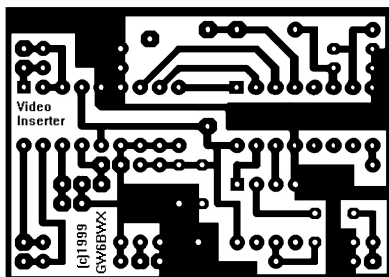

PCB layout, actual size

The only critical components are the two capacitors and the inductor that set the NEC dot clock frequency. With the suggested values, the text will be centred and about 75% of the screen width. Increasing the clock frequency

will have the effect of squashing the characters closer together, lowering it will run the risk of the end of the lines disappearing off the side of the screen. It is important that the ground on the two capacitors does not carry excessive noise which could result in the clock being modulated, causing wiggly letters. For the same reason, keep magnetic fields away from the inductor. None of the other components are critical except the 5.1V Zener diode,

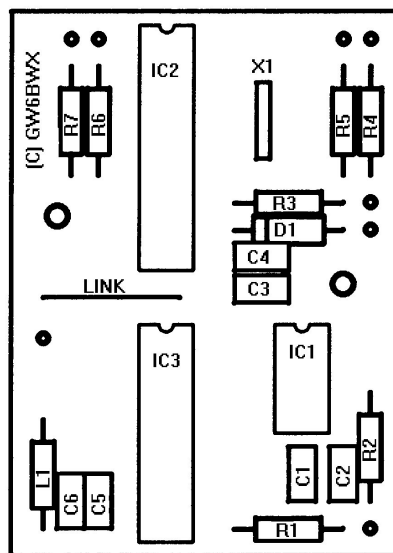

Component placement overlay

which stabilises the supply voltage. The suggested PCB layout accommodates all the components and has pads to take two kinds of PIC clock resonator. If the three-legged type with internal capacitors is used it simply fits the holes on the board. If a two-legged component is used it will be necessary

to add a capacitor from each end to ground. 47pF should do the trick; there are holes in the PCB to take them if needed. The resonator can be either 4MHz or 3.58MHz.

Connections

To select the different messages, simply connect the five-volt pin to one or more of the select pins. As there are pull-down resistors on all the inputs, any pin not raised to 5V (logic 1) will assume ground potential (logic 0). The current drawn in to the select pins is negligible and they can be driven either from a switch or the output of any TTL or CMOS device. The video mixing circuit is rather crude but works quite well. Connecting the graphics output to the incoming video does not significantly upset the sync slicing level and has the benefit of simplifying the loop through of the video signal. The video input and output sockets can be wired across each other with just a ground and signal wire running to the PCB.

Over to you

As mentioned earlier, what little I know about the NEC chip was gleaned by experimentation. I worked out the character set and initialisation commands by watching data being sent to the chip while pressing keys on the satellite receiver remote control. The three data connections were hooked up to a PC parallel port and a small program written to capture and format the traffic entering the chip. I have included the program and its source

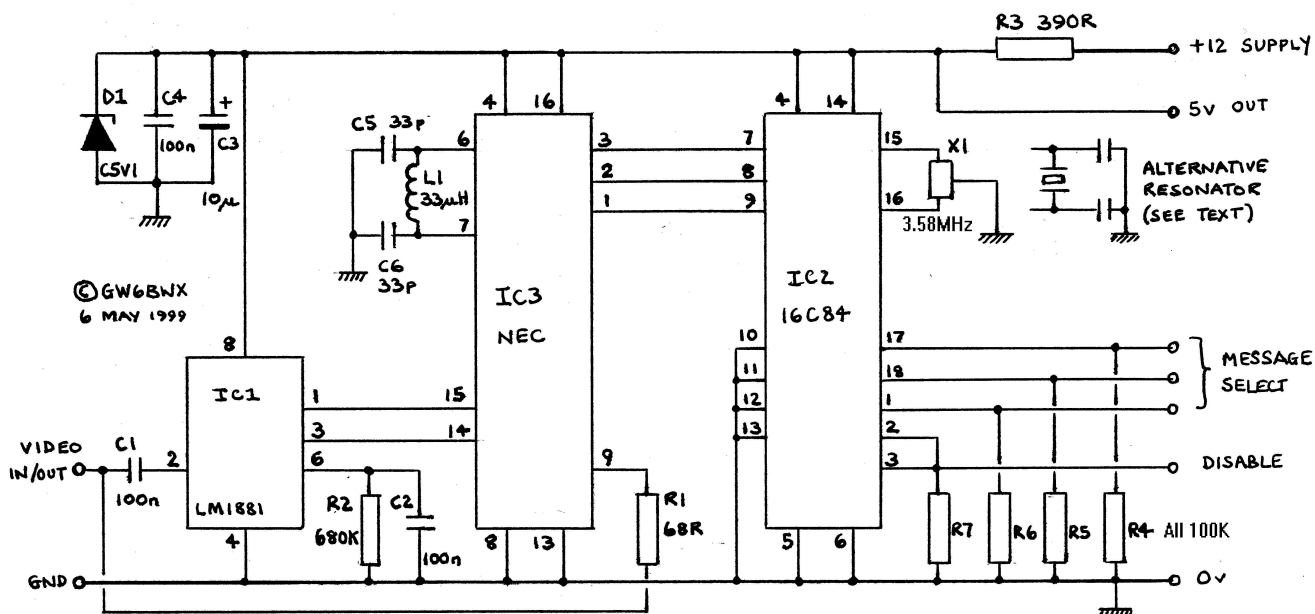

code (written in Turbo C) in the software package accompanying this article; it should be available on the club's WWW pages and on the club's CD. If a different type of chip is used it will be necessary to monitor the data flow and substitute new bytes in the table in page 1 of the program. Beware of the possibility of some chip types using more than eight bit data lengths. If a 16 bit (for example) chip is used you will have to modify the monitoring program to count twice as many bits and display larger result values.

Final word:

The rather odd arrangement of the pins on the 16C84 arises because this design was adapted from a unit that also generated an audio output. Some of the pins were used for other purposes and have simply been tied together or to ground in this unit. It should be a simple enough task to re-assign the pins in the source code header to allow port A to drive the NEC chip and port B to check the selection inputs. This would offer the advantage of being able to use the port B internal pull-up resistors,

eliminating the ones on the PCB. If this is done, be aware that the inputs would be inverted (need pulling to ground instead of 5V) and the PCB would of course have to be redesigned.

The support files contain the PIC program and these layouts in a format that should be printable on any HPGL compatible printer.

Satellite TV News

By Paul Holland G3TZO

Sorry to report that we are unable to include this column this issue, due to circumstances beyond our control.

(Actually, Paul's PC is bust)

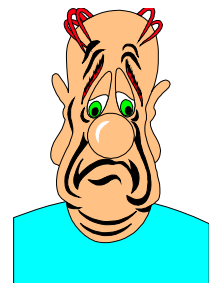

A Power Meter for Microwaves

This is a design for a microwave power meter covering 0.5GHz to 18GHz, with a max input of 250mw, providing a load match at 50 ohms, and a linear scale.

The circuit is simple, easy to construct, and uses surface mount components and costs about six pounds sterling. Fig 1 shows the layout and size in millimetres.

Components required

One mixer dual diode removed from an Amstrad/Marconi Bluecap LNB

Two 100ohm 0.125 watt sm resistors type 1206, 3.2mm x 1.6mm x 0.6mm.

Three 1000pF sm capacitors type 0805, 2.0mm x 1.25mm x 0.5mm.

Two 1000pF sm caps type 0805.

Two miniature ferrite beads.

Two 6 hole wideband Philips ferrites 5mm dia by 15mm long.

One tin box 30mm by 10mm by 10mm. Home-made, best bent tin, soldered and sealed, SMA socket sticking out at one end and two feed-throughs at the other for the meter connections.

Two 1000pF feed-through caps (solder type) used for the meter connections.

One short length of solid copper ptfе co-ax, 3.5mm diameter.

One solder SMA to fit the co-ax.

Two 1mm Veropins and a small piece of PCB material size 15mm by 10mm.

Construction

Make as shown in the drawing using a small amount of fine gauge solder for all joints - the input caps are soldered end up to support the diode package. The two resistors are at 90 degrees to each other and about 45 degrees to the horizontal as seen end on, no more and no less than 0.1mm from cut end of co-ax tube, with the centre conductor cut

at 2.0mm precisely. This must be correct.

Calibration

If you have a source of known power at 10.0GHz it should be quite easy, (if not the next best is perhaps to use a 430MHz hand held if its power output is known) and by use of attenuators plot a graph for power versus volts, it should be quite linear and stay about the same at most frequencies; at least one may compare output powers. Mine produces 0.6V at 30mW, 1.2V at 60mW and 2.4V at 120mW.

This holds true within +/-10% at all frequencies tested to date. It does work at 24GHz but I cannot guarantee how well, as I only have one source at a very low level, perhaps some experiments could be done to find out by persons with a suitable source. Please let me know.

I hope that you find this a rewarding project.

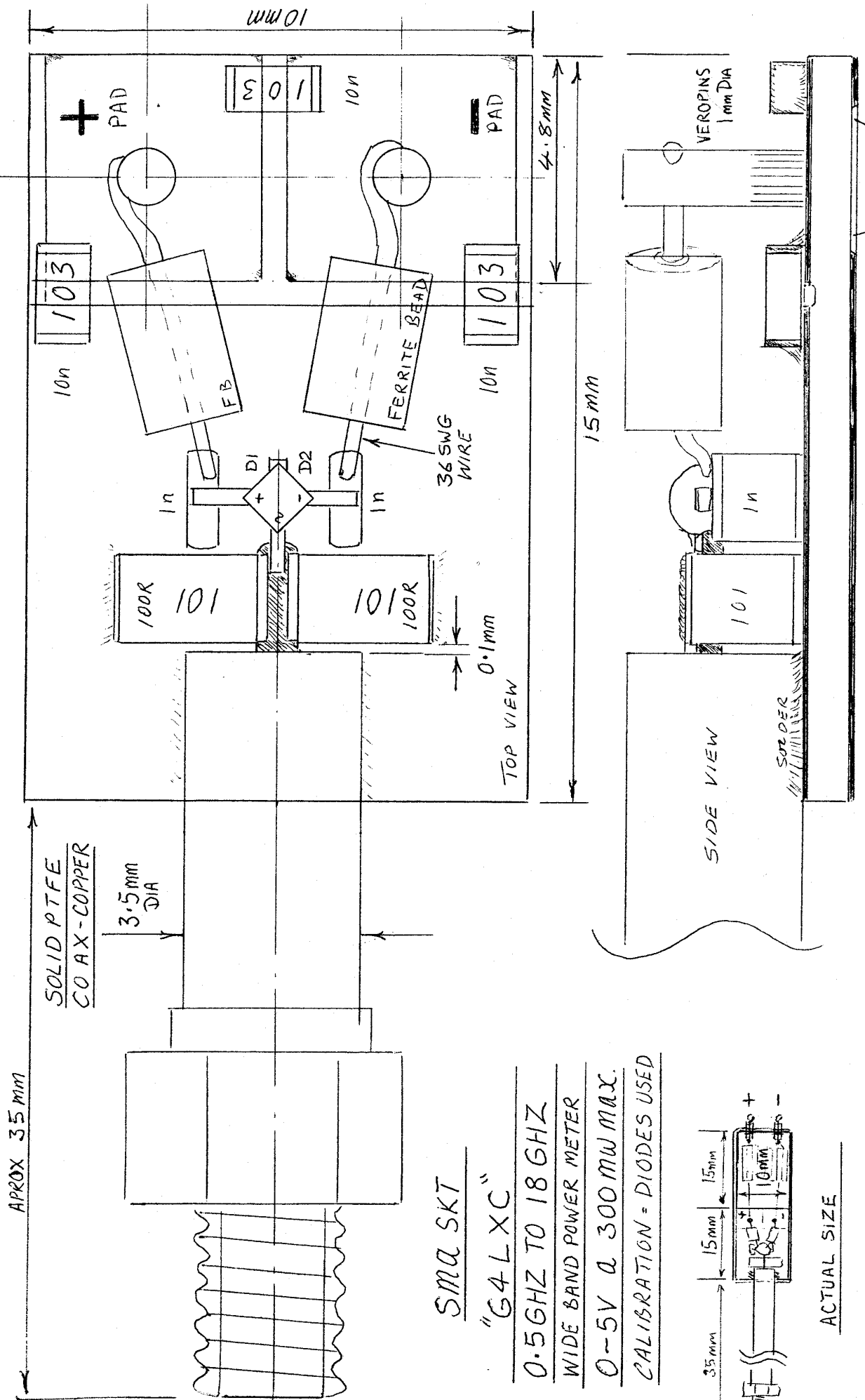

APROX 35 mm

SOLID PTFE
CO AX-COPPER

3.5mm
DIA

SMA SKT
"G4LXC"

0.5GHZ TO 18GHZ

WIDE BAND POWER METER

0-5V @ 300MW MAX.

CALIBRATION - DIODES USED

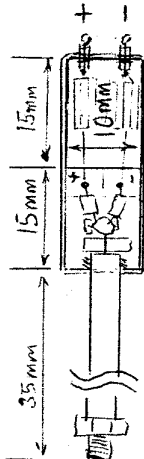

ACTUAL SIZE

PYE Down Under

Dicky Howett talks to Barry Lambert about a special television project in OZ

Barry Lambert is on a mission. He needs to reconstruct history and he's got only until the beginning of the Third Millennium to accomplish it. Specifically, Barry Lambert is reviving a vintage Pye monochrome TV o.b. van. The van used to belong to the Australian Broadcasting Commission, and now the van needs to be restored in time for the next Olympic Games in the year 2000.

Cuttings and Photos

Barry elaborates, "I used to work for ABC television back in the 1950s. In 1991 I visited a television exhibition in Canberra and saw this old Pye o.b. van which I had actually worked with. Later, I found some cuttings and photos my mother had kept for me about the van. This fired my enthusiasm and I tracked down the van again, which I found lurking in a big shed in a suburb of Canberra. I contacted the current owners, the National Museum of Australia and offered to restore and catalogue the equipment. I also suggested that they might like a working commemorative exhibit in time for the Australian 2000 Olympic Games. I any event the van could definitely be ready for the opening of the Museum's new headquarters on the Acton Peninsular in Canberra in 2001."

Fortunately for Barry, the o.b. van is in excellent and driveable condition.

Historically, the van was purchased by the (then) Australian Broadcasting Commission for use in the November 1956 Melbourne Olympic Games. Barry Mitchell continues, "I joined the ABC in June 1956 as a 17 year old 'technician's assistant'. The Pye o.b. van, one of two identical units, was delivered and put into operation mid-1956. Initially, the signals from the van went to air 'live'. For special events (e.g. the Olympic Games) the programmes were recorded on film and the film recordings were then distributed around Australia for replay. There was no 'networking' then. It was not until the early 1960s that video recording was used extensively in Australia. The o.b. van remained operational as a monochrome unit for 17 years with minimal modification. The last recorded journey was in March 1973. The van was acquired in 1985 from the ABC, as part by of the 'ABC Collection' by The National Museum of Australia. Previously, many historical events were covered by this van and it's hoped that researchers in the future will piece together a comprehensive biography of its operation."

Barry, who works for an Australian



Dicky Howett and Barry Lambert discuss the finer points of TV technology.

company making defence electronics, is off to a good start. He has now listed the entire contents of the van and prepared a 'stock list'. The van itself, with its Morris engine, was built of wood with aluminium panels attached to a relatively small chassis. The original paintwork of blue/cream is complimented by hand painted red lettering proclaiming 'ABN CHANNEL 2'. The van has three Pye Mk III 3-inch image orthicon cameras, a number of lenses plus control and sync apparatus, vintage tripods and pan heads.

PCB Oil Problem

Barry Lambert, "I came to England recently looking for information about Pye and visited the National Museum of Photography, Film and Television at Bradford. Curator, John Trenouth was most helpful, showing me the Museum's collection. Currently I'm seeking advice about leaking PCB oil from high voltage capacitors. I've heard that there is a replacement remedy using paraffin or some other inert substance. I would like any suggestions please. Also, I'm after certain handbooks and schematics of Pye equipment. I would be most grateful for any information."

Barry Lambert can be contacted at the National Museum of Australia GPO Box 1901, Canberra ACT 2601, Australia.

Phone: (06) 242 2122 FAX (06) 242 2123 Email: b.lambert@nma.gov.au



The Pye van down in OZ.

Where have all the G6***/T gone

By Trevor Brown

A look back over the last 30 of 50 years

Well the BATC has now been in existence for 50 years, and it's time to reflect. Unlike some of the older members, I was not struggling with the intricacies of television engineering 50 years ago; I had other challenges such as mixed feeding, walking was the next thing on the horizon and TV engineering was still some years away. By the time I had mastered Ohms law it was the 60s - late starter or what. I did however have a G6AGM-T call sign and was on the air with A.M. video on 70 cms back in the 60's, which then extended all the way to 450 MHz. There was no packet radio activity whatsoever, just a well-known beacon called Fylingdales at the bottom of the band. My 70 cms transmitter used valves (remember them - they glowed),

as did the receiver and most of the 2 metre talk back equipment. I think the final power amplifier for the 70 cms TV transmitter was a QQV02/6 running about 2 watts. I can't remember how many contacts I made, but you did not need to take your shoes

and socks off to count them. The video side of things was all 405 line with a CQ-TV 47-design camera using 8 valves and an electronic pattern generator, which used the syncs from the camera and generated a black cross on a white background. Because it used the syncs from the camera, I could mix between the two sources with a couple of 100-ohm pots. The pots later grew quadrant levers made from Meccano gear wheels (a Circuit Notebook idea, not mine) by the late 70s I had added an electronic character generator using a 2513 generator character generator chip and a diode matrix to set the characters (see the blue Amateur Television Handbook).

Sound was always a problem and I had a single A.M. modulator that could be plugged into the anode circuit of the two-metre transmitter or the anode of the 70cms transmitter - about 250 volts on standard Post Office jacks. The ATV receive side was a standard TV, but the tuner had extra capacitors added to the tuning capacitor to enable it to tune down to 70 cms; this was preceded by a trough line pre-amp. 2 metres talkback was received on a CR100 communication receiver with a 2-metre converter built into the inside of the lid. There was also a 12v inverter in the lid that produced 250v, so that the CR100 could be used for portable work. The inverter only needed to supply the HT, as the valve heaters could be re-patched to operate on 12v via a large plug on the rear; it always raised eyebrows at rallies, but it worked.

Halcyon days. I was sad when the powers that be called in my G6AGM-T



callsign. TV was then available to all without a special callsign, but somehow it was never as much fun. My first encounter with the BATC was the magazines I borrowed from a colleague at work. I was by then an assistant engineer in the electronic maintenance department of Yorkshire Television. Eventually I stopped pushing my luck and subscribed to my own copies, £1 for a 2 years subscription. The first magazine was CQ-TV 68, and my first contribution was a re-engineered black cross generator, that appeared on the front cover of CQ-TV 85. This was a redesign of the original I used in my 405 days, but using modern SN74121 TTL logic chips and running on 625-line standard. The advantage of this simple waveform was it showed up

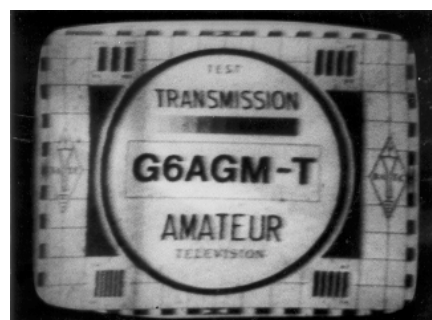

well through the noise, and did not demand much linearity from my early transmitter. The redesigned cross was part of my first training course at Leeds Polytechnic; you could choose your own practical project to work on in the lab. I still remember the first day of that course. It was all Boolean algebra and Venn diagrams. When the morning session ended with the words "any questions", my colleague who lent me the original CQ-TV magazines announced his name and "Yorkshire Television" and asked if we were in the right room. At this point I did not feel too bad, as he was a senior engineer.

I must have excelled on the course because on my return I was let loose on other parts of the station - usually accompanied though. The first such trip was the presentation mixer, where the department supervisor pulled open a rack door to reveal several banks of relays, (I didn't remember *them* on the logic course). "The top row is the emergency switcher, the next row down is the preview bank and the bottom row is the on-air bank" he announced; I refrained from taking notes. He then removed a relay from the top emergency bank and a shout came from the other side of the rack, "what have you done, we have lost station output?" He put the relay back, the shouting subsided and he said "let me run over that again the top row is the on-air bank the middle is the preview, and the bottom is the emergency". I was starting to re-think my chosen career. The trip back to the workshop proved even more memorable, going through VTR. A self-contained department with its own engineering staff and nothing to do with electronic maintenance. The machine compliment was 2 RCA TR 70's and 4 TR70B's. Whilst we had been looking at the mixer, they had been having one or two problems of their own. One of the machines had

developed a fault and the operator had removed the two-inch tape during the commercial break and set off to put it on a different machine. There had not been sufficient time to rewind the tape, so he had removed both spools. On the way to another VTR booth he caught the loop of tape between the spools on a door handle. The spools were pulled out of his hands and were rolling down the corridor spilling tape as they went. The same voice was on the talkback with "whichever machine you are on Peter just roll it". (25 years later Granada were so impressed they bought the company)

I think the distinctions between professional television in the day and amateur television in my spare time were starting to blur at the edges. Looking back, I must have been impressed with my visit to VTR, as I left electronic maintenance and joined VTR - I thought they were in need of my engineering know-how. The new job brought the title of engineer and a chance to work on my own; I stayed over 25 years. The training courses improved as they were all with RCA, who held them on Jersey. I became a regular visitor to the small island and made many friends over there. The

engineering of the courses jumped in technology; Quadruplex VTR was a complex way to store pictures. TTL gave way to microprocessors as the 4040 micro appeared and soon gave way to the 8080 for an advanced edit controller called the AE 600. The 8080 technology was superseded by the Z80, and what I had learnt was used for a BATC project called Teletron which was used in GB3ET's logic.

GB3ET was an interesting period and started off as a flashing LED and a small earpiece. If you injected video the LED lit to indicate the state of a not yet developed video switch to take you out of beacon mode. When your time was up, it dropped back and the earpiece gave a Morse code ident, or a K if you dropped out before your time was up. Not much for my first machine code programme that almost half filled a 1k EPROM. I remember the late Barry Keedy coming into the VTR workshop to see it; I think the subtleties of micros were lost on Barry. I talked him through and said imagine the LED as a relay (back to the presentation mixer, on-air bank) switching in and out of beacon mode. I then let him listen to the earpiece and his face lit up from ear to ear in one big grin. Less

than two months later the TX, RX, beacon mode video source, and vision switch; (which never was a relay) had been added, and the 'ET' ident was emanating from the top of the Emley Moor TV transmitter some 1200 ft above ground.

ET's CPU board became Teletron and eventually developed into the I²C project. I²C would have never got off the ground without Chris Smith's programming and Bob Robson's PCB designing. The video source for beacon mode became the Teletext Pattern Generator. With the demise of British Satellite Broadcasting, Chris and I again joined forces to adapt the redundant receivers from Dmac to D2mac and finally PAL. It all seems a long way from 8-valve cameras and CR100's. I have now been a BATC member for 28 years, a committee member for 25 years and Chairman for the last 10 years. The club has changed considerably in that time and I hope it will continue to change and develop, and that in another 50 years it will still be going strong and supporting the next generation, who I hope will be as inspired as I have been.

The BATC Big Breakfast

By Roy Powers, G8CKN

A wholesome helping of amateur TV was served up on the Channel 4 TV show Big Breakfast on May 4th. The show turned its spotlight on ATV and featured the British Amateur Television Club (BATC). Channel 4 contacted the BATC after visiting its web site and asked the club to appear on the Big Breakfast 'Join Our Club' slot the following week.

Roy Powers, G8CKN, of the BATC said: "It was very short notice (about



48 hours) but Dicky Howett of BATC organised 3 photographs for slides and Mike Sanders, G8LES, and I managed to make a 35 minute video showing the sort of activities ATVers are involved in. (Thanks to Mike's Digital Video Editing Studio)".

Two of the slides, Jergan, a Dutch Member sending ATV on three microwave bands and Paul Marshall (BATC Hon Sec), with his 'home built' camera were shown during the live six minute slot. Dicky Howett offered an insight into the difference between 1947 and 1999 TV cameras.

Asked by the presenter Johnny Vaughan "Isn't this 'pirate TV'?", and all three replied "no way pirate TV". Mike clarified by saying, "it is part of the Amateur Radio Licence requiring a C & G Exam". What pictures ATVers transmit was discussed, which ended with Mike's well known catch phrase



"That's no good" being taken up by all in the studio. Included towards the end of the session was footage of Roy reading a GB2RS script via the ATV Repeaters GB3HV (High Wycombe) and GB3AT (Winchester).

At the end of the slot it was stated that BATC contact could be obtained via The Big Breakfast phone, fax and web site. Roy said: "It was all light-hearted but we were able to demonstrate what ATV was really about. We received lots of congratulations for bringing ATV to the public attention."

Review of Electronic Designs Videomaker Card

By Mark Bloor

I had been looking for some time for a replacement for my ageing Amiga 2000 that was acting as a graphics/caption generator in my O.B. vehicle. The Amiga was genlocked and externally coded, providing a small, compact, good quality caption generator which could easily be inserted into my Grass Valley vision mixer for overlaying on live or video taped sequences. It had become increasingly apparent that, some 15 years ago whilst the Amiga was, head and shoulders above any P.C. the lack of newer software and support was becoming a potential problem - despite the many promises of a new release of the platform. This is a real shame, as in the USA the Amiga with the legendary Newtek Video Toaster still enjoys many high end applications - just look at "Babylon 5" to see what it can do!

After several hours on the Net, I found a card that promised everything I required - PAL output, smooth scrolling of true-type fonts and the ability to display Windows bit map images (BMP). The card, the Videomaker from Electronic Designs (a PCI card) was available from White Knight Technology, ironically one of the few Amiga dealers left. Following a couple of e-mails to the extremely helpful staff at White Knight, I confirmed the output was true PAL, i.e. with proper 25Hz offset and that RGB signals were available for external coding, so I purchased the card at a little over £300, with the guarantee that if it didn't do what was required I could have a refund.

When the card arrived and I had installed it in my machine nothing happened. A phone call later and the inclusion of a small routine in my root directory and all was well. It transpired that an interrupt was not being assigned to the card, which is quite common; the suggestion is that the same one is assigned as for the graphics adapter. In the supplied software there is a diagnostic routine which confirms everything is well and the German manufacturers can be e-mailed if there are problems.

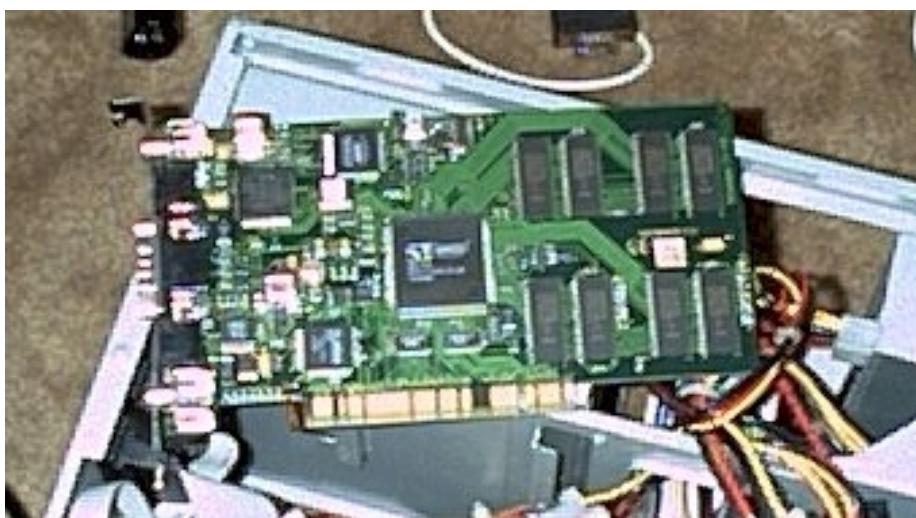

Having got everything working, and armed with a few 24 bit BMP images for backgrounds, I tried the scrolling, which is always a good test. It was superb - not a trace of jerkiness and with the HQ filter selected (there is a choice of 3) not a trace of aliasing. As far as I was concerned this and the brilliant quality of displayed bit map images made it worth while, but there was much more.

The incoming video can be resized from a dot to full screen and positioned anywhere on the active picture but the aspect ratio is maintained at 4:3 and once again with very creditable quality. Any windows bit map image can be displayed as a PAL "picture", thus making it an extremely compact and cost effective slide file, all images being displayed in full 24 bit colour.

The titling software included allows the use of any Windows true-type font (of which there must be thousands) to be used in any colour with variable shadows, outlines and edges - all of which are adjustable in all dimensions and colours. Different lines of text can utilise different font types which, once converted to BMPs can be overlaid on the incoming video in a variety of ways including 2 dimensional DVE and various wipes, all being fully adjustable. The scrolling, however, is only up the screen or left to right. The dynamics of all the moves are also adjustable.

Once the title has been created as mentioned previously, it has to be rendered to a BMP. These pages are

then added to a playlist in the Fx module, which is selected by the usual windows type tab. The transitions etc can all be checked by "playing" the title sequence, which can be cycled to play continuously. This may have uses for adding advertising logos over video presentations.

The in-built mixer allows the use of composite or Y/C video in and the caption or image can be keyed over it; also chromakey effects can be employed by using the standard windows pipette to pick a colour from the scene, or by using HSV (Hue Saturation Value) sliders in addition to the delta Y and delta C sliders. The window or range can be preset to one of 3 values.

The internal processing of the card allows for timebase correction of incoming video with the insertion of stable syncs and burst. The gain, chroma gain, black level and sharpness are all fully adjustable and there is the facility to invert the chroma signal for special effects. The inclusion of a variable length fade to black which is selected by clicking on the up or down buttons allows fades of a predetermined rate. Whilst this was better than most, it did suffer from some "stepping".

The output from the card is indeed "correct PAL", which means it can be put through broadcast type synchronisers which do not decode to YUV, and recorded directly onto 1in C format video tape recorders (neither will work if the proper PAL sequence is not present). Because of the timebase



facility, I can now bump VHS tapes up to 1in should I ever need to, which does occasionally arise. The one very important point to mention at this time is that the card is NOT GENLOCKABLE i.e. if you want to time it into a system you will need some sort of synchroniser. However, broadcast genlock graphics cards for PC's cost around £2000 so, as you can see, this card represents a considerable saving on that option! The coded output if viewed on a scope does have some shortcomings in terms of PAL balance. That being said, the subjective results are wonderful and, if you are worried by these mild imperfections, you can always code externally; remember that normal level RGB and syncs are available on the 9 pin D connector. These connection details are not supplied with the instructions, but White Knight do have them, as do I.

One final trick left is a standards converter - yes, I said standards converter - albeit one way, but you can convert NTSC to PAL and despite the denigration in the manual, the results are pretty damned good. In fact there

very good, especially in view of the price!!!

I have now had the unit for some time and have used it to download images from my digital stills camera to my Quantel slide file and can tell you the results are most impressive. The ability to display the Windows desktop is also very useful, especially if you have to do computer presentations, where a PAL large screen monitor or video projector can be used to great effect.

The software supplied is quite comprehensive and drivers are supplied which allow the Scala 1000 software to be used with a normal TV. Additionally there is some Russian software called Alpha-pro that is this can be downloaded for evaluation purposes and is fully functional, except for the save command. When available, expect the price to be around \$150.

I have demonstrated the unit to a number of other people now and all are impressed. If you

have the need for such a card, I feel you would be hard pressed to find one that offered such good quality at a modest cost.

Min requirements Pentium 100 with plug and play 2.1 motherboard, 16 meg ram, 1 free PCI interrupt, VGA compatible graphics adapter as there isn't an on board one, 40 meg HDD space, Win 95, though it appears to work fine with 98 CD ROM to load the program. Electronic Design www.electronic-design.com

White Knight e-mail: White_Knight_tech@compuserve.com



What a Fine Bunch of Chaps

By Dicky Howett

Spotted recently in an old copy of the Marconi house journal, 'THE MARCONI COMPANIES AND THEIR PEOPLE', Dicky Howett adds, "This piece is from the July 1962 edition which I discovered in a pile of magazines at a local second-hand shop. I note that the group had a barn where they kept all their equipment. Where is that barn now, and where is all the equipment? Come to think of it where is Marconis now also...?"



Article:

MARCONI PEOPLE played a pioneering role in amateur television, a hobby which spread all over the world, and particularly distinguished themselves by producing the very first amateur colour transmissions.

R.K. Flood Thain, an engineer in Receiver Test and a member of the Chelmsford group of amateur

televisors, says that keen amateur activity going on in East Anglia between such places as King's Lynn, Baldock and Saffron Walden has stimulated a new interest in the Chelmsford group.

The chief ambition of these East Anglia stations is to establish contact with each other at increasing distances, the current record being a link of 120 miles from Saffron Walden to Birmingham.

The target of the Chelmsford group at the moment is to establish contact with

viewfinder that is a re-build of the group's very first camera by Jim Brett of the Microwave Physics Laboratory, Baddow.

The control unit incorporates a 7inch monitor, and they are in the process of constructing another orthicon and a vidicon camera.

Also on the stocks are a 405-line double interlaced sync generator, two pulse generators and a receiver for other amateur stations. Another interesting survival is the home-made colour monitor which was used to demonstrate colour at the

Amateur Television Convention in London in 1958.

There are Marconi people in both the Chelmsford and Romford branches of the

British Amateur Television Club, and both groups include demonstrations at local functions among their activities. The Romford group, for instance, have televised the Dagenham Town Show from the roof of the Civic Centre, and Gala Day 1959 was the subject of an outside broadcast by the Chelmsford branch. These are mere diversions, however, compared with the serious business of stretching tentacles further and further over the countryside. The actual content of these transmissions is restricted by the terms of the licence to the purely technical, the commercial channels not relishing competition in the entertainment line.

The satisfaction of this kind of television lies in the exchange of pictures, not in what the pictures are showing.

A Rose by any other Name

Grant Dixon, who should know better, has come up with the following raw anagrams of 'amateur television club'.

I'm absolute, clean virtue
Omit actual unbelievers
Value in absolute metric

Numerical tube violates
Suitable, unclear motive
Verbatim outline clause
Valuable, erotic minutes
I'm noticeable as vulture
I'm a clever, absolute unit
I am a cult to unbelievers
O man! Curse it! leave built
Virtual, absolute, nice me
Attic bullies manoeuvre

Meet lubrication values
I've mutual celebrations
I'm a surveillance to tube
Inclusive beta emulator
Built to manual, receives
Ambition leaves Culture
Meets lubrication value
Nebulous caveat limiter
I'm unstable, erotic value
Vacuum lines obliterate

Using a Timebase Corrector

By John Stockley, G8MNY

What is it for?

A timebase corrector (TBC) is a device used with a VCR to remove timebase wobble (jitter) due to the mechanical tape systems in the VCR.

VCR Jitter

The Jitter or line phase errors are caused by: -

The 2 video heads not being precisely 180 deg apart around the head drum, this causes 25Hz line phase shifts (left right on alternate fields) at the head switching point.

Tape stretch, this causes bending left or right (early or late) as the lines get more and more out of place down each frame until the next head changeover. This is effectively the same as tape tension faults.

Tape capstan speed varying very slightly, this makes the pictures move left to right very slowly. It can be as a result of noise (hum) on the 25Hz control signal off the replay head.

Of course different record and playback machine tolerances also cause all sorts of timing errors.

Modern frame store video mixers negate the need for a TBC, as the frame store is a TBC that does not need a genlock signal to be able to mix video. For mixers without frame stores or just the copying of a video the use of a TBC will improve the end result.

How does it Work?

The VCR's wobbly video is written to a short-term video store of a few lines, and this is then read from the store later, using a steadier timebase. This timebase is normally loosely locked to the replay video.

To be able to store the video in a digital or bucket delay line the composite video first has to be split up into component parts, usually Syncs, Luminance (Y), and the U and V colour signals. The low bandwidth colour

signals are recombined into a single UV colour signal to simplify the storage. These components are filtered to reduce aliasing (patterning) in and out of the store, as the store must clock around 7MHz for VHS quality. With digital stores further analogue to digital and digital to analogue processes are required.

The syncs are used for generating the stores clocks. Two stores handle the Y & UV signals separately as this give better definition with less memory than an RGB store system. Once in the store the signal is clocked at a varying rate depending on delay time required to iron out the VCR wobble.

The O/P of the store is then converted back into Y, U, & V components and with new syncs, all fed into a PAL encoder.

Genlock

Some TBCs and VCRs enable full genlock to a master camera or station syncs for mixing etc. Genlock can usually be a normal camera video signal, but some simple studio kit may only work with a Black & Burst signal. To lock up the VCR in playback mode, the head drum is required to be locked to external syncs, (some VCRs will do this with external video present) in the same way as it does in record mode. The TBC can then generate a frame advanced VCR LOCK signal (syncs only) to feed to the VCR; the frame syncs are a few lines early so that the TBC output is exactly in lock.

Features

As the video is split into many bits inside a TBC it is easy to add useful controls such as video gain, black level, colour gain, sharpness, and with genlock line phase, fine and course colour phase.

D. O. C.

Drop Out Compensation can be designed for a VCR without DOC. If the VCR has a suitable RF output from

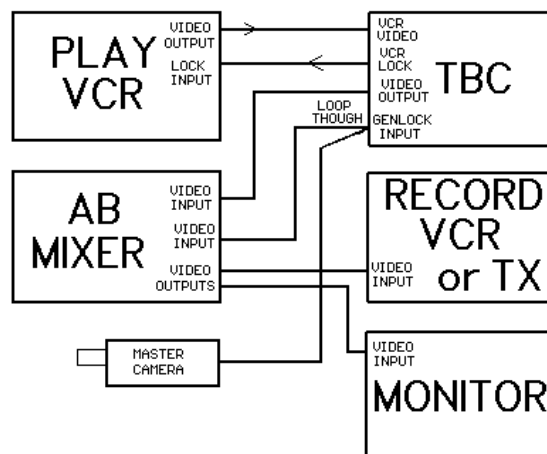

the replay head to feed a missing carrier drop out detector in the TBC, then a full colour replacement line(s) using the incoming line to the store to replace the dropped out one can be done. I have found that the VCR's own black and white DOC (64µS glass delay line) of the last good line generally looked better than replacing dropouts with coloured video from a several lines earlier.

In Use

Providing there are usable syncs from the playback the TBC should give a wobble free output within a few frames. If a crash edit is played back, the TBC may make the replay picture roll up or down until the frame syncs are again locked, but still using its steady syncs. This effect can be slower than a TV would be at regaining sync lock, but a re-recording of this should be no worse, as it will not see a sudden frame sync phase change that usually causes a 2nd generation tape to totally loose total lock for a while.

With a genlock system, a badly tracking video noise bar can be hidden behind captions etc. making a poor video usable again.

Using 3 identical VCR machines, I was able to modify them all to take external VCR drive signals from the TBC, just using a 3 way video and sound crash switcher to have them all genlocked together to my master camera.

I have also been able to genlock a freeze-frame from a colour video printer's frame store using the TBC.

Worthing & District Video



Repeater Group

GB3VR GB3RV & GB7VRB



1Watt FM-TV 24cms Transmitter

The 1 watt transmitter generates its signal at the wanted frequency which can be set anywhere in the band, colour or B/W. On board intercarrier sound and fixed pre-emphasis are standard features. The kit includes the PCB all the on board components, pre-drilled heat sink, an Eddystone Di-cast box and full and comprehensive instructions. Building time is three evenings work. The new price for this kit is £85.00, P&P £2.50. Only available to licensed radio amateurs.

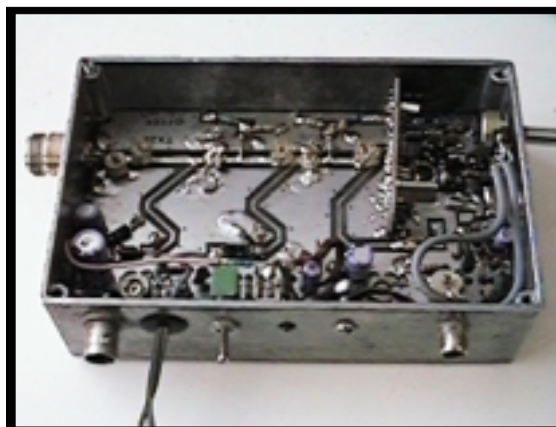

Two channel phased locked loop kit.

This add-on kit vastly improves the overall stability of the 1-watt transmitter. Two crystal locked channels and a third free running tuning position are available. Kit price £30.00

Amiga ATV Program-2

The New Amiga ATV program has more features than ever, up to 56 testcards, 20 wipes, superb text control, 30 screens of text messages, QRA calc, Testcard music, selectable displays, and this version has a DTMF tone pad to control your repeater. All testcards are over-scan i.e. the whole screen is used, Load in your own customised testcards, Extra large text, scrolling text, clock, callsign extensions, Hot key operation, Doc reader, ATV Cli, Cross Hatches, Purity and a comprehensive section for genlock users. For any Amiga with 1meg or more, state callsign and QRA (if known) when ordering, this three disk set is now only £10.00 P&P 75p

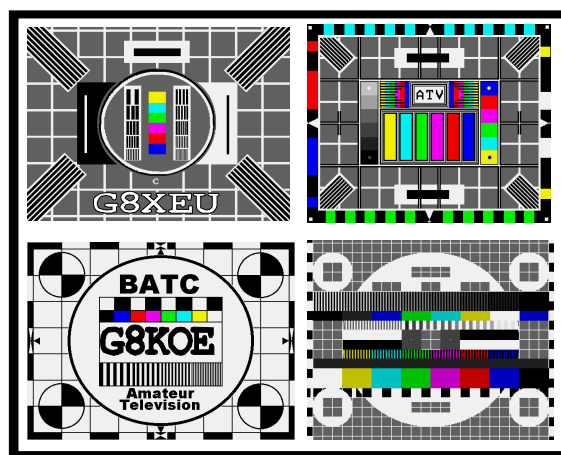

Spectrum ATV Program

Still selling after all these years, why, it's good, its cheap and it works on all spectrum based machines. The 48k version has over 60 commands which include 7 Testcards, Memo pad, clock, maps, tones, QRA locator, various size printing, plus disk transfer routines and much more. Now only £5.00 P&P 75p

Visit the all new GB3VR-RV web site at: - <http://www.g8koe.demon.co.uk/>

Orders should be sent to:-

Treasurer of GB3VR, R. Stephens, 21 St. James Ave., Lancing, Sussex, BN15 0NN.
Cheques payable to "W&DVRG" Tel (01903) 765760, 7 to 8pm.

70cms ATV?

By Howard Chapman, G3NZL

The combination of RSGB's recent errors with Graham's request for feedback has finally made me start up the hated PC (instead of the much-preferred ATV Amiga) so that I can send this long-winded Email.

What is SCART?

The Solent Club for Amateur Radio and Television has catered for the interests of (mainly) ATVerS in central southern England for some years. Members come from Hampshire and Dorset to our meetings at The British Legion, Park Gate, (off the A27 near Southampton) on the 1st & 3rd Tuesdays of every month, where we have sociable constructional sessions. We have also designed, constructed and maintained the GB3AT 24cms ATV repeater. The Club is affiliated to BATC and UKRS but not to RSGB - see below for some reasons!

GB3AT's History

We decided to build a repeater several years ago but we made the silly mistake of assuming that RSGB (acting as RA's sub-contractors), would be as competent as the RA themselves are at approving commercial base stations (PMR etc) - we were very very wrong! The application was submitted in February 1994 and took nearly three years to process, largely due to RSGB incompetence: e.g. on one occasion when trying to find out why our application had died AGAIN, I discovered that our file had been sleeping peacefully in a filing cabinet at Potters Bar for six months - I tracked this down as a result of a tip-off from the RIS (who were feeling sorry for us)! GB3AT finally went on the air from our Park Gate HQ at Christmas/New Year 1996/7 - results were P5 to Portsmouth and the Isle of Wight but very poor out of the Solent Basin due to the hills - particularly towards Southampton (about 5 miles away), so after proving that the problem was solely due to terrain, we looked for a better site. We found a site at the 3rd attempt, on the top of the South Downs, near Winchester and yet again, people (including the commercial telecomms site owners)

were amazed at how long the (simple for commercial users) re-siting procedure took; e.g. the RSGB stated that the initial process would take 3 weeks - it took four months (even then it was only completed when the RA "laid the law down")! We finally extracted our Approval by pressurising the RA direct, and went back on the air six months after RSGB received the application to re-site.

GB3AT Abbreviated Technical Details

TX - Solent synthesised TX driving a pair of bricks into a set of four Antec/G8CKN radomed plate aerials giving just under 25W omni coverage. Rx - Solent synthesised Rx fed by four GasFET pre-amps from four Antec/G8CKN radomed plate aerials with auto-sensing of best direction (giving 6db advantage). Technical co-ordination is in the able hands of G8LES (who is also the Keeper of GB3HV).

Control, captions, DTMF decoding, menus and displays - Amiga 1200 with SCART software written by G6H NJ. Several significant enhancements are planned.

N.B. Hardware and software modules are available (in return for a contribution to Club funds) to other groups.

The only problem with the new (plateau) site is that we are limited to 6 metres aerial height - this limits coverage to the Solent "bowl" to good sites only (e.g. I can't receive it 9 miles away - thank heavens that we've still got 70)! This is why ATV operators are using ATV on 70 in addition to the microwave bands.

If I need to see the output from GB3AT; G7JTT or G8LES receive it on 23 and relay it (with a VCR interposed of course!) to me on 70. This is also used for non-repeater working. I know of at least one ATV repeater which can switch to 70cm DX ATV input (like other IARU Region One countries) when required

Re 70cms ATV Activity "DOWN SOUTH"

This region is difficult (often impossible) for microwave ATV use over "normal" distances, therefore the reports of 70 ATV's demise are considerably exaggerated - e.g. 70cms regularly works well between Southampton and Bournemouth, Andover, Alton and Portsmouth to my knowledge; there are also regular local 70TV QSOs on Sundays and Club nights, plus "on request" signals during the day. RSGB's self-centred recent Band "Plan" pronouncement has had the opposite effect to what they apparently intended - new 70cms ATV stations (just starting up/ re-starting after a long gap=*) are: Hampshire - G7AFT (Calshot), G0SBV (Holbury), G0LPP (Gosport), G8CKN (Medstead)*; Dorset - G3KTU (Southbourne) also probably G3UXR & G7PNW (Hengistbury).

Other Developments on 70ATV

In a recent email to me, Graham Shirville says you shouldn't have sound with your 70cms pictures due to bandwidth limitations - RUBBISH! I have transmitted NBFM sound on my vision carrier for over 3 years to such stations as G7BVK (Andover), G8LES (Four Marks), G8CKN (Medstead), G7JTT (Southampton) with colour or black & white, with sync-stretching, either 4.5 MHz or 2MHz bandwidth filters, etc., with no problems at all.

G8LES has developed narrower bandwidth FM for 70cms ATV with 25 Hz energy dispersal, and has PROVED both its effectiveness and that it can hardly be detected by other modes - even with local signals.

So to answer your real question: 70ATV is a long way from dying in the south - unless "the Society that represents all Radio Amateurs" wins the day.

Keep up the good work - we really appreciate it. Howard Chapman, G3NZL SCART Secretary.

Graham G3VZV was asked about the sound on 70 statement attributed

to him by Howard and states that he was referring only to the normal 6MHz i/c sound system. Graham also mentioned that he used NBFM on the vision carrier on 70cms, and that it was common practise in the 70s!

A letter from our chairman to the RSGB

T Brown, Talltrees, Stairfoot Close,
Adel, Leeds, LS16 8JR

12/4/99

Dear Mrs Clayton-Smith,

Re: BATC/RSGB relations and usage of the 70cms band

I am writing to you at the request of the Committee of the British Amateur television Club and subsequent to our recent Committee meeting when the above matters were discussed *.

It was the unanimous view of the Committee members that the RSGB is presently failing to correctly listen to and represent the views of Television Amateurs in general and members of its affiliated society, the BATC, in particular.

The BATC has for many years been represented on both the VHF and Microwave Committees of the RSGB but, in recent months, has been increasingly excluded from the work of them and, it appears, that BATC liaison membership of the VHF Committee has been discontinued – although we have not been told this officially!

This apparent exclusion has led to a number of problems, none of which has shown the RSGB in a good light.

Having worked closely with the RSG to assist in the defence of the amateur usage of 70cms during the recent DTI review we are feeling especially aggrieved at the recent approach of the Society to the apparent requirement for extra packet frequencies in the 70cms band.

Contrary to the impression given in the GB2RS new bulletin, BATC was never properly consulted or even asked for an

opinion. When we challenged the VHF Committee on this matter, we received only abusive comments from an RSGB Spectrum Manager and from an RSGB Committee Chairman.

They both stated that, as ATV activity had moved from 70cms to 23cms, the BATC should have no further interest.

You will appreciate that fast scan ATV is specifically listed in the licence as a permitted mode in the band and I do not think that the RSGB would, strategically, wish to have it removed! Please also note that there is an IARU Region 1 ATV contest on the band every year and that digital ATV could be just around the corner.

ATV is perhaps the only amateur mode where every transmitter is home made or assembled from a kit – there are no production items on the market. ATV is also an activity where the medium is as important to the users as the message and which has helped fill many of the unused Megahertz that we have in the UHF and microwave bands.

The proud announcements from the RSGB in August last year about the changes in the 10GHz band show that the RSGB appears to have little interest in and knowledge about ATV. (Lambda House appeared unaware that the result would be frequency changes to six out of the seven ATV repeaters on the band. Then it took over three months of chasing to get the Microwave Committee to adopt a new band plan to enable the groups to be advised of the new frequencies)

With ever fewer radio amateurs in existence it is especially important that the National Society works constructively to ensure that all specialisms are encouraged rather than ignored. This requires openness and communication between all parties. This need is at present not being fulfilled by the RSGB and this is greatly regrettable.

In an effort to rectify this, may I make three requests:

A: please reply to this letter – a letter sent by us a couple of years back to a predecessor of yours was not replied to.

B: ensure that the future plans for 70cms can be issued with the

knowledge and hopefully endorsement of the BATC.

C: On Sunday August 8th, the BATC will be holding a special event to celebrate 50 years of the BATC. This event will be held at Shuttleworth College (part of Cranfield University) Nr Bedford, just off the A1. It will not be another boot sale or mobile rally and there will be no traders. We will be having lectures and demonstrations of all aspects of ATV new and old. It would be a perfect opportunity for the RSGB in the shape of its President and, I would request, the Chairmen of the VHF and Microwave Committees to be present and to make a short presentation on how the Society is working for all ATVerS. Obviously we would ask you to be willing to respond to questions from the floor afterwards but would ensure that you are well briefed beforehand!

I look forward to hearing from you at the earliest opportunity.

Yours faithfully,

Trevor Brown

Chairman BATC

* NB this meeting was held before the April Edition of Radcom – which put a two month hold on the proposed band plan changes - was distributed. Again the BATC had no notice of this further change of policy until reading the article on page 43 – unfortunately we missed the update on the DCC web page.

Letter to Graham Shirville

From: Jörg Hedtmann Subject:
Repeater Info

Dear OM Graham,

You might not be the proper contact for my request, but maybe you could pass it on, if necessary.

On behalf of Horst, DL7AKE, who is responsible for some part of AGAF-magazine, could you provide me with an up-to-date TV-repeater list of the UK and possibly Ireland for publication? Horst tells me that he cannot find a comprehensive list anywhere, and, trying myself on the

BATC-web site, I can only find a link to listing of all UK-repeaters.

The latest channel allocation I have noticed the article in CQ-TV 186.

As for your research into 70-cm activity: I am the licence holder for a new TV-repeater south of Berlin. The main input frequency is on 13 cm at 2329 MHz in FM with a SSC of 6 MHz. The output is on 1280 MHz, SSC 6 MHz, FM with vertical polarisation to reduce interference to nearby DB0KK in Berlin, which is on 1285.5 MHz in AM.

As you might have heard, there is a new novice licence in DL using DO-prefixes, which are allowed 2m and 70 cm operation with low power. They are also allowed ATV-operation, and as an encouragement to those operators, we will include a 70 cm experimental input to out repeater using reduced bandwidth (abt. 2 MHz) on 434.25 MHz with sound at 5.5 MHz spacing on 439.75 MHz. Whilst this will only accept b/w

pictures, it should reduce possible interference to satellite users and from FM-repeaters / PR-digis, and increase the range of the 70 cm input, provided the transmitting stations also reduce their bandwidth. Recently a supermarket chain has sold large numbers of b/w-video cameras for children, complete with cables, microphone and adapters for as little as DM 29.95, about GBP 12!!! They have been bought up by amateurs on mass and so everybody interested in ATV will have one (at least, I bought ten). As a result, a lot of novices are now being able to cheaply start ATV, especially, since a lot of redundant 70 cm gear is floating around on the surplus market. I would expect, and this is my point, that this will increase 70cm activity, provided, that the satellite lobby within DARC and RSGB and the like are not able to cut this, too. As for digital ATV, being from Wuppertal, where this is being developed, I have taken a strong interest in this, but I doubt that it will provide the same cheap entry into the hobby and the same public relevance for training and

Amateur-related news broadcasting as analogue TV, at least for the next 5 years or so. I, therefore, advocate the continuing use of 70cm ATV, compromising on the bandwidth and the colour. I can live with that, since DX-contacts rarely provide colour anyway. In neighbouring Poland some ATV-repeaters are using 70 cm for input or output. It would be nice, if we were able to contact them, if conditions are right.

Last remark: Why don't you in the UK use sound on 70 cms. I have been testing from my old QTH north of Aberdeen using 5.5 MHz sound spacing and a cheap sound converter at the UK-TV end. I know, it's not the UK-norm, but who cares.

Thank you for your help and best regards to all TV-Hams in the UK.

Jörg Hedtmann, (DF3EI) Fritz-Jaeger-Allee 6 D-15838 Waldstadt Tel. +49 (0)33702 6 67 22 Fax +49 (0)33702 6 67 23 eMail: GM4YRI@online.de



1/1999

Repeater

Zelfbouw
Nicam-
encoder

- Multiplier voor 3 cm
- 13 cm converter
- ATV via de satelliet !
- Rotorbesturing
en nog veel meer...

Het tijdschrift voor ATV
en microgolfsystemen

'Repeater' is the premier ATV magazine in Holland.

Repeater is a new ATV magazine published in the Netherlands in Dutch. The 13/24cms TX in this issue is reprinted from Repeater with the kind permission of the Editor Rob Ulrich PE1LBP. I hope we can from time to time bring you other extracts as we do with all the ATV magazines.

Information about 'Repeater' magazine can be found on their web site at <http://www.euronet.nl/users/rulrich>, email: repeater-nl@rocketmail.com

Snail mail:- Gibbon 14, 1704 WH Heerhugowaard, Netherlands.

Photo Gallery



Dicky Howett writes: This charming picture taken at Marconi's London Strand establishment in May of 1954, shows a Marconi two-tube colour camera, apparently unique at the time. The two ladies, Miss Gloria Clarry and Miss Anne Sturnham, along with Leslie Mitchell (not pictured) wowed the press with on-screen displays of gaily coloured hats, cigarettes and scarves. Later a camera was wheeled to a window to catch sight of a buses and a G.P.O van all in startling red. Some of these scenes were actually recorded on film off the screen, and a short extract was shown recently at the NFT.

The first British demonstration of compatible colour television.



Technical crews seem to get younger every year

On the way to DATV

By Peter Erhard, DL9EH

(excerpt from TV-AMATEUR 111)

“At November 29th 1995 the first tests in digital amateur TV (DATV) were performed over a 50 km path. This way DATV had an encouraging start towards digital television and high speed data radios, but preserving our complete 70 cm amateur radio band is absolutely necessary for direct contacts over long distances.”

TV-AMATEUR reported this in issue 99 in 1995. Uwe Kraus, DJ8DW, had transmitted still pictures via GMSK link from Wuppertal to Kamp-Lintfort.

Meanwhile a DATV developing working group has been formed at the Wuppertal University under direction of DJ8DW. As one of its members I was asked to state the facts, but this is not an easy task.

During the last 3 years different test facilities for digital TX and RX and processing of video signals were produced by this group. That are data-I/O for PC, GMSK-Coder, I/Q-modulator and -demodulator, data slicer, sync regenerator, oscillator and mixer. All these parts of a DATV station are now available in different

versions and are presently prepared for reproduction. There seems to appear a solution for the core problem of DATV, a payable MPEG-decoder and above all -coder in real-time. Until now only pre-recorded MPEG-coded video scenes were transmitted, a point of criticism sometimes. But remember: the first TV on-the-spot reports were done via intermediate film scanners as no daylight TV cameras were available, and nobody queries this to be real television.

On September 9th 1998 we succeeded in a transmission of MPEG1 video scenes over more than 100 km (TV-AMATEUR 110, page 45). The CD-ROM recording of the received pictures has been shown at various amateur radio rallies proving the quality of the 2 MHz wide channel. All this tests consumed not only our free time but also much money, and we are thankful to AGAF for a donation of 1000 Marks. On November 18th 1998 the executive committee was able to visit the works at the Wuppertal University.

Another good point is the initiative by the DARC districts chairmen DF1QM, DJ1KF, DL1EAG and DJ4VF to promote our work and to help also financially.

This development of DATV is needed to replace the present AM-ATV on 70cm by a digital mode with only 2 MHz bandwidth, in order to place the different amateur radio modes in this band side by side after all instead of one upon the other. As soon as possible the 3 German ATV repeaters with 70cm outputs will switch to DATV (without compulsory measure). The first one is DB0CD in Gelsenkirchen, it's accountable Georg Boettinger, DH8YAL, already applied for a DATV licence on 70 cm on April 18th 1998. This was given on November 10th 1998, and from November 28th on we have carried out first digital transmissions in GMSK at DB0CD. As a next step MPEG-coded video scenes will be available permanently, so all OM in the Ruhrgebiet have the opportunity to build up receiving equipment and start DATV tests.

You see, it is a long and difficult way to get DATV being a normal part of an amateur TV station. But it is a good starting point now, and the longest way begins with a first step, so: lets go DATV!

vy 73 Peter Erhard, DL9EH
(translation: DL4KCK)

Confidential Communications Ltd

Video Surveillance

Design Your Own Professional Video Surveillance. Smallest pinhole camera in the world 15mm x 15mm (B&W) £29.00

32mm x 32mm Board camera, pinhole, high resolution (B&W) £29.00

32mm x 32mm Board camera (colour) £65.00

B & W Quad £79.00

Colour Quad £350.00

Picture in Picture with alarm input £299.00

1.394GHz video transmitter module, 100mW £85.00

2.4GHz video transmitter module, 10mW £85.00

1.294 - 1.3 GHz Linear PA 2W output £250.00

Four channel video receiver module with auto switcher £120.00

Time & Date Generator Module £42.00

Time, Date & Character Generator Module £65.00

5W infra-red light source £25.00

Audio amplifier module £7.00

Convert your VCR to automatic video recorder £45.00

4" LCD monitor £190.00

6.8" LCD monitor £290.00

We also stock RF parts such as Power Modules, MMIC's, RF transistors, etc...

Above prices are subject to VAT and are for one unit order, 10% discount for 5 or more.

Confidential Communications Ltd., 344 Kilburn Lane, Maida Vale, London, W9 3EF, England.

Tel: 0181 968 0227

Fax: 0181 968 0194.

e-mail: 106075.276@compuserver.com

My First BBC Television Experience.

By Reg Moores G3GZT

Way back, shortly after the second World War ended, I found my way into "Show Biz", firstly as an agent, in an office in Shaftesbury Avenue, London, and later, performing in an Ice Show!

When the conflict started, I was an Electrical Engineering apprentice, working on all manner of equipment, lifts, refrigeration, generating plant, press printing machines, neon lighting in fact most branches of this type of work.

I then joined Allen West, a large electrical firm, employed in the manufacturing of all types of electrical control units, covering installations for the Royal Navy, railways, coal mines, ships, harbours and in many other world-wide places.

This company later was employed in anti-mine, de-gaussing, oscillators, and in fact very many branches of the War protection effort.

Of course, being young and keen to get involved in the War I volunteered several times for the services, but there were only two options, submarines or aircrew, I being in a reserved occupation job.

My application for the submarine service was refused, being as the firm was very much involved in Naval

work, but my application for aircrew was eventually allowed, so I finished up flying on Liberators in Coastal Command, as a Pilot/Flight Engineer.

Like all returned service men, things had changed, and our outlook also, so for sometime, I tried several different ideas of earning a living, and after working for sometime as an agent, I was offered a contract in an Ice Show, as prior to, and in the early part of the War, I had been involved in several different branches of ice skating, and had been hoping that as a good speed skater, I stood a chance of being picked for the 1940 Olympics, - had my parents been able to cover my costs, as in those days, unlike today, it was an amateur sport!, however, this wasn't to be.

The Ice Show I joined toured the country, mainly in the "number two" theatres, using a very small portable segmented ice floor, which could be transported and re-assembled quite quickly, although it still took many hours to build up the surface, even using crushed ice, bought in.

This floor was circular, only some 18 feet across, so left very little room for performing. I at that time was doing several "spots", Barrel Jumping, Stilt Skating, Unicycling, Fire Eating etc. etc., as well as doing the get-ins and outs, - travelling with the floor to the next engagement!

Around this time, BBC Television was getting under way; producer Richard Afton saw the Show at the Empire Theatre, Oldham and decided it would be ideal for his regular Saturday show spot, from the studios at Alexander Palace!

The BBC had only the two, "A" and "B" Studios, which were very small, compared with today's, with only one being used at any one time, the other being left with the camera trained on a test card, which were marked A or B accordingly, so it was easy to see which studio wasn't being used for performances.

In those days, the old pre-war Marconi Iconoscopes were being used, and the amount of lighting needed produced a very large amount of heat, which didn't help the freezing process!

The BBC Television transmissions were limited to two and a half hours per day, with the news read in sound only for the last 15 minutes, finishing off the day's viewing, so different from today!

So, the viewer had two options, either to see the afternoon one hour, or the evening one hour repeat of our show, and yes, it was all live, no V.C.Rs then!

This show, being the first of its type proved to be a great success, and was the fore-runner of so many of the Ice Skating Shows seen since!

PC ATV£5.75



PC-ATV is here, a program to generate Testcards on your PC brightens up any transmission.

Written by Robln Stephens author of ATVAmlga & Spectrum

Send a cheque for £5.75 inc P&P, to "The Arcade Shop" 17 The Arcade, Worthing, West Sussex, BN11 3AY

or download a shareware version from <http://www.batc.org.uk/software.htm>
e-mail: pcatv@arcadeshop.demon.co.uk



FAX 0870 1641889

TELEPHONE SALES VISA MASTERCARD AMEX SWITCH CONNECT Tel (01903) 765760 7-8pm

Post and News

Please send all correspondence for **Post and News** to the CQ-TV Editor. Ian Pawson, 14 Lilac Avenue, Leicester, LE5 1FN, England.

Tel: 0116 276 9425.

E-mail editor@batc.org.uk

Members' sales and Trade adverts should be sent to the advertising manager, Trevor Brown, 14 Stairfoot Close, Adel, Leeds, LS16 8JR.

Tel: 01132 670115.

Email: adman@batc.org.uk



Trevor Brown,
Tailtrees,
Stairfoot Close,
Adel,
Leeds LS16 8JR
21st April 1999

Dear Trevor,

Thank you for your letter and your concerns over the BATC relationship with the RSGB. I am sorry that you feel that difficulties have developed in the working relationship between BATC and the Society. Let me now turn to some of your specific concerns.

On band plans, having spoken to the VHF Committee Chairman, I understand that he has been in contact with Graham Shirville throughout the process of preparing the new band plan proposals. My understanding is that Graham has been representing the BATC position in these discussions.

The two month extension to the period of consultation will now allow BATC time to make input to the Society and I believe, having spoken to Graham, that this is now well under way.

Let me make a general point about groups such as BATC. Over recent years, amateur radio has become very diversified, with additional modes and technologies being exploited by specialist interest groups. I believe the

RSGB should be supporting such initiatives, as it is here that much of the future innovation in our hobby is likely to originate. I would like to see ways in which RSGB could support you. I have taken the liberty of speaking with Steve White, the RadCom editor, to see how the RSGB could help raise the profile of amateur television. Steve has agreed to publish an article in the "getting started" series on amateur television, should you feel able to provide one. He would also be willing to run a two-monthly column in RadCom on ATV matters and would welcome a topical constructional article as well. Please would you contact Steve directly if you would like to take up these offers. Steve would be looking for a reliable columnist who is prepared to commit to deadlines for the two-monthly column. I have not, as yet, broached the subject of the 8th August meeting with the VHF or Microwave Committee Chairmen, but I would like to be present at the meeting to take any questions and hopefully get some feedback on the new initiatives suggested by Steve White. I will let you know nearer the date if the two Chairmen can also be there.

Please feel free to ring me any time if you would like to discuss any matters.

Yours sincerely,

Hilary Clayton-Smith, G4JKS

President, RSGB



Dear Editor,

I recently had a short holiday in Malta and met a BATC member, John Scicluna. I thought that there might be other members in Malta and it turns out that there are three other members. I thought that it would be a good idea to put these members in touch with one another but we are not allowed to reveal addresses because of the Data

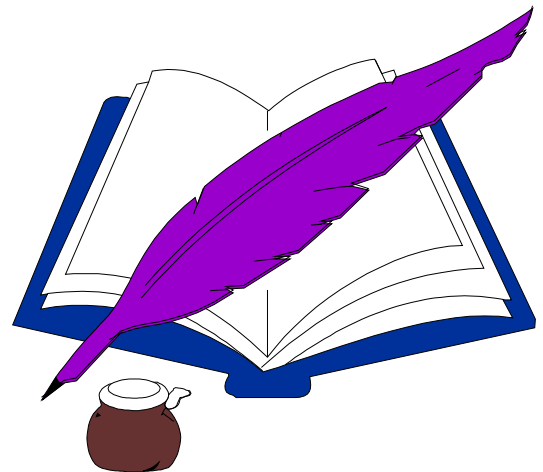

Protection Act. Can I therefore suggest that other Maltese members might like to get in touch with John, who lives at 12c St. Bartholomew St, Zurrieq, with the idea of forming a small group for the exchange of ideas.

Yours, Grant Dixon.



Dear Mike,

Just a little note to thank you and your family for organising the BATC Rally. Due to our group participating it will enable the two Bristol Television Repeaters to be kept running for another year, giving enjoyment to all who use them.

Thanks once again for all the hard work you put in.

Regards, Viv & Ivor, G1IXE



Michael J Wooding
5 Ware Orchard
Barby
Nr. Rugby
CV23 8UF
04/05/99

Dear Committee,

It has been seventeen years or so since I first joined the BATC Committee as Assistant Editor and a lot of the

proverbial has passed through the ether. I spent of the order of ten years as Editor of CQ-TV after John retired and then when that had become just too much, what with VHF Comm, I handed the reigns to Chris Smith and took up post as Rally Organiser.

My first rally, whilst still Editor, was jointly organised with Trevor at the then called Coventry Esso Hotel - an event that will always remain with Trevor and I, both as an incredible success and an absolute nightmare!

After the club was not invited to go back to Harlaxton Hall I offered to organise the annual rally at Coventry the next year, which was fortunately a moderate financial success. Subsequently, the next three rallies at Coventry have been quite financially rewarding for the Club, bringing in of the order of £1000 to £1200 profit per rally.

However, this year was a very difficult one, as many of you know from the email correspondence over the last few weeks. The end result, after much reorganising and cajoling of traders, was that we made a small loss - namely £2.64. I had thought on the day that we had actually broken into a small profit of around £20, but I had miscalculated slightly. That aside, I am very pleased that the outcome was such, because I was anticipating a possible loss amounting to four figures!

The consequence of all this is that I am unable to recommend to the Club that it continues to hold such an annual event of this size - at least the BATC went out looking good. Perhaps a smaller event can be envisaged, but I feel that the signs are that perhaps the Club would better spend its time and resources in other ways.

Finally, I must advise Committee of my intention not to seek re-election at this year's Biennial elections, at which my position on Committee is up for grabs. I have enjoyed my time serving the Club and participating with you all in this task. My time is in extremely high demand these days, such that we are even considering selling VHF Comm. The day job does pay the bills after all!

73, Mike



Leicester Repeater Group News Flash
- received by post at G8EMX 2 June 99

'Repeater Group in Trouble'

At the Annual General Meeting of the Leicestershire Repeater Group held in April both the Chairman and Treasurer were re-elected without opposition, as were the Membership Secretary and Newsletter Editor.

Both the latter have been trying to stand down for some time but in the absence of any new volunteers to fill the positions both reluctantly agreed to remain in office for one final year. The post of Minutes Secretary that became vacant during the course of the last year remains unfilled, as does the newly created post of Site Manager. The committee will try to fill these positions by co-option but at the moment they have no one in mind for any of these positions.

Far more importantly however was the failure to find any new Repeater Keepers to assist the Engineering Manager who currently holds the NoVs for all three-voice repeaters GB3CF, GB3LE and GB3UM. The present incumbent took on the job last year for one year only due to his commitments at Leicester DeMontfort University. After some considerable persuasion he has agreed to continue for a further six months to give the Group time either to find a replacement or at least to find some assistants prepared to take on the responsibility of holding the NoVs and maintaining the Repeaters.

By the end of October therefore, unless the committee can find some volunteers to assist there is a serious risk of these repeaters having to close down which of course is something that none of us wants.

If you would like to offer your services as a Repeater Keeper (or Minutes Secretary or Site Manager) or would like any further information, then please contact the Chairman John Senior G7RXS (QTHR for 'snail mail'). By phone 0116 284 1517 or E-mail to Repeaters@aol.com

END OF PRESS RELEASE.

From the Internet

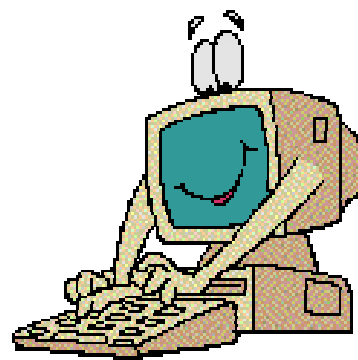

Dear Trevor,

It's been a while since we last corresponded so with the last issue of CQ-TV I thought I would congratulate you and your team on the change of format. Having spent the past 41yrs in the broadcast industry, the vision and hearing (I am sure it was the VR1000c's and VR2000's that caused it) are starting to fail. The A4 version does make it easy to read and to see the fine print on the circuit diagrams.

I can remember the MIKE COX colour camera in CQ-TV and in fact started membership with No.58. Mikes name always rings a bell as we had many of his colour coders within the ABC. ATV here in Brisbane is still going great guns and we are now celebrating 20yrs of activity. Most people are active on 70cms and 1250mhz FM with two repeaters now serving Brisbane City and suburbs while the other tends to cover the upper northern areas.

We managed to obtain the power amplifiers (4w and 8w) units from the old channel 28, SBS transmitter, however who ever stripped it down also took all the combiners, loads, power supplies etc. I have tested all the power units after many dry joints, and only one is not working. This is a 8w unit in which one of the pair of power transistors lit up like a lighthouse. I know Walters worked on these units for Pye and I did in fact met him at an IREE in Sydney many years ago. To enable us to use these units we need to replace the faulty transistor. Therefore would it be possible to ask around on our behalf if anyone had a new or used TPV598. It came to my notice that Adelaide had a similar problem, however someone had a used one in his

draw. If anyone could help out it would be greatly appreciated.

I have enjoyed the articles in CQ-TV on the old equipment and remember the CPS Emitron used in our news studio, with the white peeling when the news reader turned the page. Also remember the Marconi Mark3,4 and the 8 colour camera, the LDK5 and of course the PYE units used in our OB vans.

Again thanks for CQ-TV. Hope to see you all on ATV in the near future (we still replay the old BATC tapes now and then).

Kindest Regards, Richard Carden
VK4XRL

You might be interested to hear that there is a description of the features of our Test Card F on the BBC's web site:

<http://www.bbc.co.uk/info/reception/tcf/testcard.shtml>

This has a small (and rather over-compressed) JPEG version of the test card, but this links to a larger and much better quality GIF at
<ftp://ftp.bbc.co.uk/pub/video/stills/tcf.gif>

There is another site I have found, nothing to do with the BBC, but part of the "Test Card Circle", which has lots of pictures and gossip about test cards, station idents, and so on, run by Darren Meldrum:

<http://www.meldrum.co.uk/mhp/testcard/index.html>

Regards, Peter Vince (G8ZZR) Email: Barney.Wol@noctua.demon.co.uk
Web: <http://www.noctua.demon.co.uk/index.html>

My 10 page ATV Repeater Application Notes are now available to hams as a .pdf file for the asking by e-mail.

If you do not have Adobe Acrobat Reader to open and print the pdf file, you can download a free copy by

clicking on the Get Acrobat Reader graphic on page 4 of our web site: <http://www.hamtv.com> Tom O'Hara W6ORG, P. C. Electronics, tom@hamtv.com

SATELLITE-NEWS FOR FREE:

If you want to receive latest sat-news and transponder-listings, here's a special information for you. More news:

<http://www.hagedorn.komtron.com>

You can join to the highly informative sat information-service (currently more as 19,000 members world-wide) Be member of the news-source no. 1!

Superb list of ATV clubs in the UK and elsewhere:

<http://www.gthelectronics.com/clublink.htm>

You might like to look at this software vectorscope display program that uses any bog-standard video-for-windows compatible capture card:

<http://www.DigitalMediaWorks.com/Products/VScope.html>

It looks very nice.

From: Andy Smith-PY

Sent: Sunday, April 18, 1999 11:55 AM

To: 'atv@ukrs.org'

Subject: Safety whilst operating mobile

Hi Mike,

I operate ATV in the Plymouth area, and for a job I work for the BBC as a camera/sound operator, OB links operator etc.

I was reading your UKRS web page with interest, when I came across a section that gives me great concern regarding safety advice.

Firstly you mentioned placement of the camera and tripod whilst mobile:

"[...] If you are on your own, the camera sits on its tripod, with one leg on the back seat and the other two in the foot well behind the front seats. The tripod top should be tied-off with string for safety. You will set the camera up so that it looks forward through the screen and then let it all get on with it as it is illegal to watch TV while mobile."

Yes, good, but I would like to tie it down with rope instead of just string.

Secondly, after a promising start, some extremely bad advice:

"[...] If you want to follow a race either use something like a Land Rover with a standing platform, stand-up through the sunroof of a car or, [...]"

NO NO NO!! Standing up through the sun-roof is the WORST possible thing you can do! Imagine the car stopping suddenly or having a collision, even from a slow speed. It is very likely serious injury will result to the camera operator, possibly breaking his back. If the police caught you operating like this they would be well within their rights to book the driver and camera operator for dangerous driving. BBC safety advice specifically excludes operating in this manner (even though some operators are still seen doing it now and then!). The BBC will only allow filming from a vehicle if both the camera and the operator and properly harnessed to the vehicle.

I would like to see your web page amended to reflect a safe operating practise, and specifically advise against standing up through a sun-roof.

Would you want your advice to result in someones injury?

Regards, Andy G7IZU. >
andy.smith.03@bbc.co.uk



Contributions

If you have any snippets of news or information, then please send them in

to my the editor either by snail mail or email

Visit our Web site at www.batc.org.uk to view or download electronic versions of recent issues of CQ-TV



HS PUBLICATIONS

7 Epping Close, Derby DE22 4HR, England
☎ 01332 38 16 99

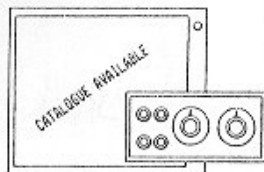

- DX-TV CONVERTERS • VHF-UHF TV AERIALS
- DX-TV PUBLICATIONS & VIDEOS
- AMPLIFIERS • FILTERS • HARDWARE
- TECHNICAL BOOKS
- BBC TEST CARD MUSIC C.D's
- TV CLOCKS & ARCHIVE PUBLICATIONS

Send 3 First Class stamps for our latest Catalogue
Personal callers by prior arrangement only please.

S. Marshall

20dB gain 10GHz horns £25.00

Waveguide 16 and 17 flanges £5.00

Slot antennas and filters made to order.

For further information, contact: -

S. Marshall, G6NHG,
25 Carlcroft,
Stonydelph,
Tamworth,
Staffs., B77 4DL.

Telephone: 01827 897920. 7:30pm - 10pm weekdays.

Members adverts

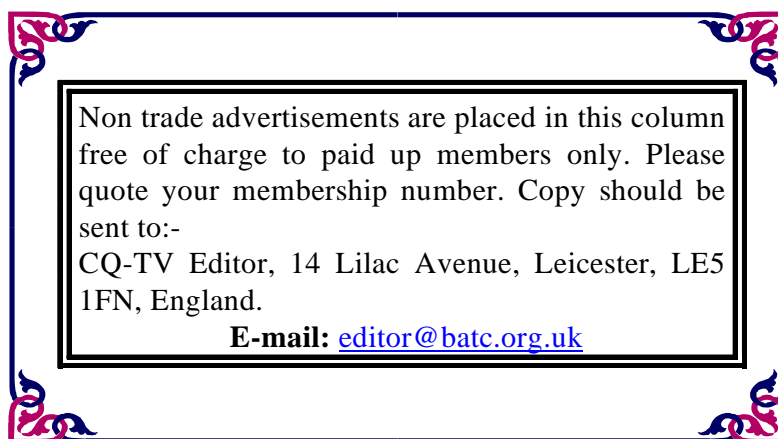

For Sale

INDEPENDENT TELEVISION IN BRITAIN. Bernard Sendall. 1982. Vol 1. Origin & Foundation 1946-1962. How ITV began. Invaluable history for the TV buff. £15.

TELEVISION. T.J.Morgan. 1961. How-it-works book. Nice pictures of ABCtv ob vans and studio shots of the opening of the BBC TV Centre in 1960. £5

ONE DAY IN THE LIFE OF TELEVISION. Edited by Sean Day-Lewis. Mammoth BFI book charting a day in the life of British Tv as was on 1st Nov 1988. A comprehensive illustrated snapshot of past televisual glories,Thames Tv, TVAM, tubed cameras etc... £8

BBC YEARBOOK 1945. d/w. £10. Getting scarce.

BBC YEARBOOK 1946. £8. Television starts again. Very smart laser repro d/w

FANTASTIC TELEVISION. Gary Gerani & Paul Schulman. Titan Books 1987.

Illustrated guide to SF tv favourites including The Invaders, The Outer Limits, Superman. £3

GERRY ANDERSON. The authorised biography. 1996. Quite a few photos of model spaceships, surprisingly. £6

GIRL FILM & TELEVISION ANNUAL No1 1957. No d/w. £5. 1st of this attractive series

Marconi Manual. 14" Picture & WAVEFORM MONITOR 1965. £5.

Magpie Annual 1973 £2. One for sorrow.

Magpie Annual 1974 £2 Two for joy.

Vintage US ELECTRONICS MAGAZINES.

RADIO NEWS June 1947.

RADIO & TELEVISION NEWS July 1951.

RADIO & TELEVISION NEWS July 1955.

All magazines stuffed with old-style electronics/ads/articles. £3 each

All VGC. Postage minimum on all items £1.50

Contact Dicky Howett. 01245 441811. Email: dicky.howett@btinternet.com

A) LDK44 Philips Colour Cameras, complete with Plumbicons, 10:1 zoom lens, 1.5" viewfinders, carry cases, service manuals. (These cameras were put in their boxes 8 months ago fully working, but on trying recently, all

have developed faults). 3 off available 550 pounds each

B) Tripods and heads with Pan bars and lens control for above. 3 off available 180 pounds each.

C) Triple camera power supply. 1 off available 220 pounds

D) Various camera cables for above POA

E) AMIGA 500 Computer with extra memory and extra disc drive, Gen-lock, RGB out, handbook 80 pounds.

Buyer, with cash, collects. **Contact: Jim Attew 01428 - 604 110 (daytime)**

For sale, a quantity of practical TV magazines from 1950 to 1958 all in good condition phone for a list to Dave 01579 345740 all at £1 each or 75p if you buy more than 5. **Dave Kemplen, 2 Vicarage Close, Menheniot, Liskeard, Cornwall PL14 3QG**

Studio Colour 19" monitor by Electronic Visuals. RGB/Composite 75-Ohm inputs, front controls. In working order with trolley, £40.00 Buyer collects. **Trevor Wiltshire, G8AKA Tel: 0118 970 1163 (Central**

Southern Area) or mobile 0402 005813

EMI 2001 Camera inc. manuals, Phillips LDK 25 Camera inc. wide angle, telephoto lenses and manuals and 'home made' tripod with 1950's pan/tilt head for above cameras. Sony 20" Profeel Monitor, Marconi Monitor (B/W era) with manual. Special effects amplifier, vertical aperture corrector and 2 U-matic recorders. Ferguson VHSC video camera and separate recorder, Chinnon super 8 sound lo-light cine camera. BSB squarial and receiver, working condition varies depending on item. Selection of IT/BA 1970's and 80's yearbooks, some BBC books 1940's to 70's as well. 1937 Radio times. Good homes and sensible offers required. Can deliver anywhere in the UK. **Contact Paul Gibbs 01749 675839 (Answerphone/Fax) Somerset.**

Lots of panels, parts and service manuals for 1970/80's CTV and 1960/70's mono TV, several unused regun CRT's and used colour/mono CRT's, Ultra 22" CTV (Thorn 8800), Grundig 6010TDGB 26" CTV, Bush CTV1122 22" CTV (Rank A823A/V), Ferguson 3763 22" CTV (Thorn 9600), Several black & white portables and some Goodmans/HMV audio units from early 1970's. **Contact David Hazell Tel: 01793 765390**

BBC 6 output video distribution amplifiers. AM4/517, 518, 519. About 70 available in racks of 8. Mostly in good condition complete with MUSA termination panels, some with cable equalisers. £20 ono per rack, discounts for quantity.

Double ended MUSA cables, mostly PSF1/3 cable. Various lengths from 10cm to 3m. About 200 available. 50p each, discounts for quantity.

Double ended BNC cables, mostly URM70 cable. Various lengths from 10cm to 3m. About 30 available. 50p each, discounts for quantity.

"Samson" tripod and dolly. Suitable for cameras up to about 10kg weight. Good condition. £60

"Gizat" tripod and dolly. Suitable for cameras up to about 25kg weight.

Pan handle not original. £70

Fluorescent lights with downlighting shades for use over production desks etc. 4 feet long. £15 each ono.

CoxBox series 4 caption colouriser. The 153 PAL coder module is missing. £20.

Cox routing switchers as listed. Generally decent condition. No control panels. Manuals available to photocopy.

Type 184. 2U rack with 2 modules giving 20 inputs, 4 outputs. £30

Type 217. 7 inputs, 4 outputs. £20

Type 177. 10 inputs, 4 outputs. £20

Type 168. 5 inputs, 1 outputs, 3 level (for RGB etc). £20

Cox chroma keyer type 282. No control panel. No data. £10.

BBC rack PA1M/539 "Output processing panel" Believed to come from CO6/501A 625 to 405 standards converter. Complete with all modules, nice condition. Swaps or offers?

Contact Jeffrey Borinsky. 0208 343 8121 (North London).

EMI 2001 Camera inc. manuals, Phillips LDK 5 Camera inc. wide angle & telephoto lenses and manuals and "home made" tripod with 1950's pan/tilt head for above cameras. Sony 20" Profeel Monitor, Marconi Mk. V Picture and Waveform Monitor Type B3901 with manual. Special effects amplifier, vertical aperture corrector and two U-matic recorders. Murphy Radio 1940's model type A168. Bush Monarch Record Player Type SRP.31D. 1954 Cossor TV Model 933A 17" screen complete with receipts of purchase and first licence. Bush two tone single dial portable Radio TR 82C. Ferguson VHSC video camera and separate portable recorder, Chinon 506 super 8 sound lo-light cine camera. BSB Squarial and receiver. - Condition varies depending on item. Selection of IB/TA 1970's & 80's yearbooks, also some BBC books 1940's to 70's. 1937 Radio Times. Can deliver anywhere in the UK to good home(s). Offers: **Contact - Paul Gibbs: 01749 675839 (Answerphone/Fax) Somerset.**

Fortop 70cm ATV transmitter crystallised for 435 and 437MHz plus receive converter, tx/rx switch, RF sniffer and many other goodies. £10 the lot. **Contact John Gomer G8UNZ, Colchester 01206-794656.**

Gunnmod2 3 cms ATV TX with Horn antenna. 3 cms LNB with dish antenna. TVRO3 ATV IF/RX plus all controls with built in b/w 5" monitor. Spare 8" b/w monitor. 12v RCA b/w camera with 25mm 1.9 Lens. Antenna rotator, three wire remote control, TV antenna grade. £200 the lot.

Contact Gordon 01594 832494 or gordon@g3kkn.demon.co.uk

Wanted

Service manuals (not copies) for Ferguson 3V29, Sharp VC780HM and Sanyo VTC5000 VCR's, original stand for Ferguson 59H5 CTV, remote gun

for Fidelity ZX3000 CTV (4 buttons). **Contact David Hazell Tel: 01793 765390**

Ikegami 79D 3inch top-mounted studio viewfinder. Any condition. **Contact Dicky Howett. 01245 441811. email: dicky.howett@btinternet.com**

Wanted Service Manuals for the following: - JVC VHS recorder BR 8600E, SONY Betacam Player BVW15P, AVITEL Time code reader TRE 2060, AVITEL Time Code Generator TGE 2020, SELTECH Vision Switcher 6010. **Contact Trevor on 0113 2670115 or email Chairman@batc.org.uk**

Legal Niceties (the small print)

E&OE. Whilst every care is taken in the production of this publication, the editor accepts no legal responsibility for the advice, data and opinions expressed. The BATC neither endorses nor is it responsible for the content of advertisements or the activities of those advertisers. No guarantee of accuracy is implied or given for the material herein. The BATC expressly disclaims all liability to any person in respect of anything and in respect of the consequences of anything done or omitted to be done wholly or partly in reliance upon the whole or any part of this magazine.

The contents of this publication are covered by international copyright and must not be reproduced without permission, although an exception is made for not-for-profit publications (only) wishing to reprint short extracts or single articles and then only if acknowledgement is given to CQ-TV.

Apart from any fair dealing for the purposes of published review, private study or research permitted under applicable copyright legislation, no part of this publication may be reproduced, stored in a retrieval system or transmitted in any form or by any means, electronic, mechanical, photocopy, recording or otherwise, without the prior permission of the publisher. All copyrights and trademarks mentioned in this publication are acknowledged and no infringement of the intellectual copyright of others is intended. Printed in Great Britain. ISSN 1466-6790

Index of Advertisers

9GHz DRO pucks.....	35	'Repeater' magazine.....	54
BATC advertising rates.....	10	S. Marshall.....	61
BATC Publications.....	32	Sevenside Television Group.....	30
Caladan Communications.....	31	The Arcade Shop.....	57
Confidential Communications Ltd.....	56	The BATC CD.....	35
GB3XT Kits and Bits.....	27	VHF Communications.....	30
HS Publications.....	61	Worthing & District Video Repeater Group.....	51
Members Services.....	33		

