

# I AM RADIO HORIZONS



HAM RADIO HORIZONS - DECEMBER 1977

# CERTIFICATES AND AWARDS



# The DRAKE TR-33C



\$229.95

## Amateur VHF FM Transceiver

### DRAKE TR-33C SPECIFICATIONS

**GENERAL:** • **Frequency Coverage:** 146-148 MHz, 12 channels (2 supplied: 146.52 and 146.94). Crystal determines receive frequency. • **Transmit frequency offset for repeater operation** determined by 5-position switch: Simplex, +600 kHz, and -600 kHz supplied; any two additional offsets available with accessory crystals. • **Power requirements:** 13.0 volts dc  $\pm$  15% external supply OR internal battery supply. • **Current Drain (Batteries):** Squelched receive: 30 mA; transmit: 400 mA. External supply: above plus 45 mA for channel switch indicator lamp. • **Antenna:** 50ohm external antenna through SO-239 connector OR screw-on telescoping whip antenna supplied, may be replaced with rubber helix antenna. • **Dimensions:** 5.5" x 2.8" x 8.5" (13.8 x 5.8 x 21.6 cm). • **Weight:** 4.4 lbs (2 kg).

**RECEIVER:** • **Sensitivity:** less than .5  $\mu$ V for 20 dB noise quieting. • **Selectivity:** + 30 kHz adjacent channel rejection greater than 75 dB. • **Modulation acceptance:** at least  $\pm$  7 kHz. • **Inter modulation Rejection:** 70 dB referenced to sensitivity level. • **First I-f:** 10.7 MHz with monolithic crystal filter. • **Second I-f:** 455 kHz with ceramic filter. • **Audio Output:** nominal 1 watt at less than 10% distortion into 8 ohm built-in speaker or external speaker.

**TRANSMITTER:** • **Rf Output Power:** 1.5 watts minimum with 13.0 volts dc supply. • **Frequency Deviation:** Direct frequency modulation adjustable to at least  $\pm$  7 kHz deviation, factory set at  $\pm$  5 kHz • **Separate microphone gain and deviation adjustments** • Drake 1525EM Push Button Encoding Mike can be used direct with no modification.

- **Hand Held Convenience, 12 Channel Capability**
- **SCPC (Single Crystal Per Channel) Frequency Control**
- **Lower Receiver Battery Drain**
- **Expanded Portable Antenna Choice**

• 12 Channels—only one crystal per channel provides simplex OR repeater operation on ANY channel. 2 channels supplied. 5 transmit offset positions, 3 supplied. • All FET front-end crystal filter for superb receiver intermod rejection. • Small convenient microphone included. • New lower power drain circuit on squelched receive. • Nicad rechargeable batteries supplied. • Built-in battery charger. • Ac and dc power cords supplied. • Telescoping screw-on antenna supplied, rubber helix optional. • Channel indicator light when using external dc supply. • Carry strap supplied. • Meter indicates receive strength, xmit output, or battery voltage. • External speaker jack on rear panel. • Auxiliary jack on rear panel—may be used for tone-pad connections, etc. • Traditional R.L. Drake service backup.

### DRAKE TR-33C ACCESSORIES

#### Drake AA-10 Power Amplifier

10 dB power increase greatly adds to the transmitting distance covered by any 2-meter fm transceiver running up to 1.8 watts output



Small size: 2"H x 2.1"W x 5.5"D (51 x 52 x 140 mm)

#### Drake AC-10 Power Supply

Powers the AA-10, TR-22C, TR-33C and TR-72. Simultaneously can charge the TR-22C/33C nicads. Supplies 13.8 volts up to 3 amps from 120 V-ac 60Hz input. • **Accessory Crystals.** • **Model No. 1333 Drake MMK-33 Mobile Mount.**

- **Model AA-10 Power Amplifier** ..... \$49.95 ea.
- **Model AC-10 Power Supply** ..... 49.95 ea.
- **Accessory Crystals** ..... 6.30 ea.
- **Model MMK-33 Mobile Mount** ..... 12.95 ea.
- **Model 7079 Vinyl Carrying Case** ..... 9.95 ea.

#### Drake 1525EM Push Button Encoding Mike



- Microphone and auto-patch encoder in single convenient package with coil cord and connector. Fully wired and ready for use.
- High accuracy IC tone generator, no frequency adjustments.
- High reliability Digitran® keyboard.
- Power for tone encoder obtained from transceiver through microphone cable. No battery required. Low current drain.
- Low output impedance allows use with almost all transceivers.
- Four pin microphone plug: directly connects to Drake TR-33C without any modification in transceiver. Compatible with all previous Drake and other 2 meter units with minor modifications.

**Drake 1525EM, microphone with tone encoder — \$49.95**  
**Drake 7073DM without tone encoder — \$19.00**

To receive a FREE Drake Full Line Catalog, please send name and date of this publication to:

**R. L. DRAKE COMPANY**



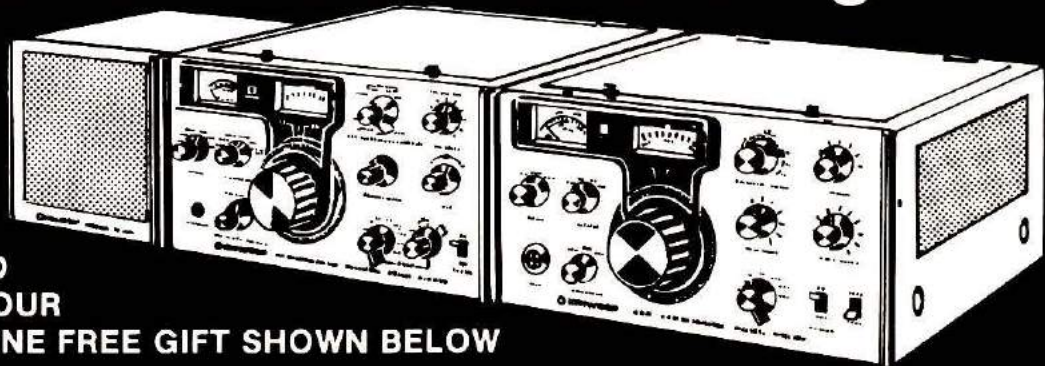
540 Richard St., Miamisburg, Ohio 45342  
 Phone: (513) 866-2421 • Telex: 288-017

Western Sales and Service Center, 2020 Western Street, Las Vegas, Nevada 89102 • 702/382-9470



# Buy the 599D's & get a Free gift

Call: 1-800-633-3410 for your FREE gift and 599D station from Long's



1023.00

FOR THE 599D STATION & YOUR CHOICE OF ONE FREE GIFT SHOWN BELOW

## KENWOOD S-599D speaker

The S-599D speaker is designed specifically for the 599D series station. • Frequency range: 100 to 5000 Hz • Speaker diameter: 4 3/4" • Dimensions: 5 1/2" W x 5 1/2" H x 7 1/4" D • Weight: 3.3 lbs.

## KENWOOD R-599D receiver

R-599D: • Entirely solid-state • Covers 10-160 meters • Highly stable VFO • Oscillator for 5 fixed channels • Built-in crystal filters • Noise blanker • Squelch circuit • Modes: USB, LSB, CW, AM, FM • Power consumption: 15 watts.

## KENWOOD T-599D transmitter

T-599D: • Solid-state, except driver and final stage • 10-160 meters • Modes: USB, LSB, CW, AM • Effective 8-pole crystal filter • Antenna impedance: 50 to 75 ohms • Carrier suppression: 40 dB • Power consumption: 350 watts.

**CUSHCRAFT ATB-34**  
10, 15, 20 meter antenna.  
List Price: 239.00



FREE GIFT NUMBER 1.

**BIRD Model 43**  
THRULINE wattmeter  
List Price: 120.00



FREE GIFT NUMBER 2.

**KENWOOD TR-7200A**  
2m FM transceiver List Price: 189.00



FREE GIFT NUMBER 3.

**HYGAIN 3806**  
handy-talky.  
List Price: 189.95



FREE GIFT NUMBER 4.

**DENTRON 160-10AT**  
super tuner  
List Price: 129.50



FREE GIFT NUMBER 5.

**REGENCY HRT-2**  
handy-talky.  
List Price: 179.00



FREE GIFT NUMBER 6.

Remember, you can call TOLL-FREE: 1-800-633-3410 in U.S.A. or call 1-800-292-8668 in Alabama for our low price quote. Store hours: 9:00 AM til 5:30 PM, Monday thru Friday.



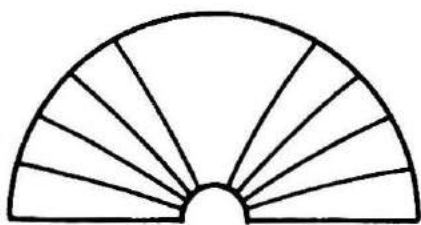
# Long's Electronics



MAIL ORDERS: P.O. BOX 11347 BIRMINGHAM, AL 35202 • STREET ADDRESS: 3521 10TH AVENUE NORTH BIRMINGHAM, ALABAMA 35234



# THIS MONTHS



# HORIZONS

## All Is Not Gold That Glistens

Amateur Awards are many and varied; their colorful certificates of merit grace the walls of any shack, testimonials to effort and accomplishment, and the "fine tuning" of operating skills.

## First QSO

Someone helped when you needed to learn the code, when theory seemed to be a foreign language, and when the Rules and Regulations just weren't getting to you. Now you are about to go on the air and actually talk to the other hams! Still need help? Author Sundstrom gives you a few ideas of what to expect and how to get through the first plunge. It's reassuring to know that you'll survive and really enjoy talking to the rest of the world.

## Wire Yagi Antenna

Most wire Yagi beam antennas grow on trees, especially the 160- and 80-meter varieties. Fortunately, with the invention of the antenna spreader, compact high-frequency multiband wire Yagis with reasonable bandwidth can be a reality. Author W1HXU tells you how.

## Power Supply

There are dozens of interesting and useful projects described

in the amateur magazines today. The power required to run them comes in a variety of voltages and in different polarities. There is no need to build a separate supply for each one when it is so easy to make one that will provide either fixed or variable, positive or negative, voltages. W1KLL first tells you about power supply principles, then shows you how to build one.

## Make Your Own Enclosure

An interesting part of amateur radio is building your own equipment. Sometimes the enclosures that are available are just not right; they are the wrong size or shape, or they cost too much compared to the value of what you just built. You can make your own enclosure too, and turn out something that is unique, functional, and inexpensive. WA2PVV tells you how to do it with ordinary tools.

## That Professional Look

There's an old adage that goes, "If it's worth doing, it's worth doing right." If you'll apply that same thought to building your own gear, you can have a shack full of equipment that you will be proud to let your buddies see. The usual side benefit of a well-planned and nicely done project is that it works well, too. VE3GFN passes along some pointers on how to do it.

## Resistors, Capacitors, Inductors

You can probably figure out the function of a resistor by studying the name — it obviously resists something or other. But Capacitors? Inductors? What in the world are they and what do they do? Author Schreier takes you through their functions step-by-step, and gives you a bit of mathematics to show how they can work in your electronic circuits.

## Ionospheric Focusing

Is there an explanation for those unusually strong signals that come and go in unpredictable patterns? Computers and sounders have helped find the reason, and W5LFM tells you what it takes to understand this phenomena. Sharpen your wits and get ready to use the focusing to your advantage next time.

## Questions? And Answers!

This segment of the Question and Answer series gets you almost to the end of the Rules and Regulations section, then delves into some of the more fun parts of amateur radio. In addition to listing some things you cannot do, W1SL talks about courtesy, finding a frequency, and what countries allow third-party traffic.

## The Cover

Awards and Certificates — recognition of effort and accomplishment. To many amateurs, award chasing is what amateur radio is all about; for others the certificates are a nice reminder of contests won, friendships made, or unusual experiences. Our thanks go to W4SYL, ex-KP4AOO, for most of the certificates used on our cover, and many of those used in the story that begins on page 12. Color photograph by Ralph Wright, K1EGS.

**HAM RADIO HORIZONS** December 1, 1977, Volume 1, No. 10. Published monthly by Communications Technology, Inc., Greenville, New Hampshire 03048. One-year subscription rate, \$10.00; three-year subscription rate, \$24.00. Second-class postage paid at Greenville, New Hampshire 03048 and additional offices.



# Call toll-free 800-647-8660 for products by MFJ ENTERPRISES



**\$69<sup>95</sup>**

### MFJ-16010 ST Super Antenna Tuner

This NEW MFJ Super Antenna Tuner matches everything from 160 thru 10 Meters: dipoles, inverted vees, long wires, verticals, mobile whips, beams, balance lines, coax lines. Up to 200 watts RF OUTPUT. Built-in balun, too!

- Operate all bands with one antenna • Works with all solid state and tube rigs • Ultra compact: 5 x 2 x 6 inches • Uses toroid cores



**\$39<sup>95</sup>**

### MFJ-16010 Antenna Tuner

Now you can operate all bands — 160 thru 10 Meters — with a single random wire and run your full transmitter power output — up to 200 watts RF power OUTPUT.

- Small enough to carry in your hip pocket, 2-3/16 x 3-1/4 x 4 inches • Matches low and high impedance by interchanging input and output • SO-239 coaxial connectors • 12 position tapped inductor. Stacked toroid cores • At 1.8 MHz tuner matches 25 to 200 ohms.



**\$29<sup>95</sup>**

### CWF-2BX Super CW Filter

This MFJ Super CW Filter gives you 80 Hz bandwidth, and extremely steep skirts with no ringing for razor sharp selectivity that lets you pull signals out of heavy QRM. Plugs between receiver and phones or connect between audio stage for speaker operation.

- Selectable BW: 80, 110, 180 Hz • 60 dB down one octave from center frequency of 750 Hz for 80 Hz BW • Reduces noises 15 dB • 9 V battery • 2-3/16 x 3-1/4 x 4 inches • CWF-2PC, wired PC board, \$19.95.

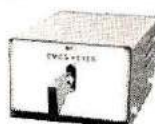


**\$69<sup>95</sup>**

### MFJ-8043 IC Deluxe Electronic Keyer

This NEW MFJ Deluxe Keyer gives you more features per dollar than any other keyer available.

- Uses Curtis-8043 keyer chip • Sends iambic, automatic, semi-automatic, manual • Use squeeze, single lever, or straight key • Dot memory, self-completing dots and dashes, jam proof spacing, instant start • RF proof • Solid state keying  $\pm 300$  V max • Weight, tone, volume, speed controls • Uses 4 C-cells; external power jack • 6 x 6 x 2 inches • Sidetone and speaker • Optional squeeze key: \$29.95



**\$54<sup>95</sup>**

### CMOS-8043 Electronic Keyer

State of the art design uses CURTIS-8043 Keyer-on-a-chip.

- Built-in Key • Dot memory • Iambic operation with external squeeze key • 8 to 50 WPM • Sidetone and speaker • Speed, volume, tone, weight controls • Ultra reliable solid state keying  $\pm 300$  volts max. • 4 position switch for TUNE, OFF, ON, SIDETONE OFF • Uses 4 penlight cells • 2-3/16 x 3-1/4 x 4 inches

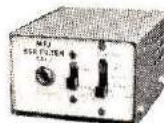


**\$59<sup>95</sup>**

### LSP-520BX II Log Speech Processor

Up to 400% more RF power. Plugs between your microphone and transmitter.

- Gives your audio punch power to slice through QRM • 30 dB IC log amp and 3 active filters • RF protected • 9 V battery • Two Mic jacks: 1/4" phone jacks, uncommitted 4 pin jack • Output cable • 2-1/8 x 3-5/8 x 5-9/16 inches • LSP-520BX, in standard MFJ enclosure, electronically identical, \$49.95.



**\$29<sup>95</sup>**

### SBF-2BX SSB Filter

Dramatically improves readability.

- Optimizes your audio to reduce sideband splatter, remove low and high pitched QRM, hiss, static crashes, background noise, 60 and 120 Hz hum • Reduces fatigue during contest, DX, and ragchewing • Plugs between phones and receiver or connect between audio stage for speaker operation • Selectable bandwidth IC active audio filter • Uses 9 volt battery • 2-3/16 x 3-1/4 x 4 inches



**\$29<sup>95</sup>**

### MFJ-200BX Frequency Standard

Provides strong, precise markers every 100, 50, or 25 KHz well into VHF region.

- Exclusive circuitry suppresses all unwanted markers • Markers are gated for positive identification. CMOS IC's with transistor output. • No direct connection necessary • Uses 9 volt battery • Adjustable trimmer for zero beating to WWV • Switch selects 100, 50, 25 KHz or OFF • 2-3/16 x 3-1/4 x 4 inches



**\$49<sup>95</sup>**

### MFJ-1030BX Receiver Preselector

Clearly copy weak unreadable signals (increases signal 3 to 5 "S" units).

- More than 20 dB low noise gain • Separate input and output tuning controls give maximum gain and RF selectivity to significantly reject out-of-band signals and reduce image responses • Dual gate MOS FET for low noise, strong signal handling abilities • Completely stable • Optimized for 10 thru 30 MHz • 9 V battery • 2-1/8 x 3-5/8 x 5-9/16 inches



**\$29<sup>95</sup>**

### MFJ-40T QRP Transmitter

Work the world with 5 watts on 40 Meter CW.

- No tuning • Matches 50 ohm load • Clean output with low harmonic content • Power amplifier transistor protected against burnout • Switch selects 3 crystals or VFO input • 12 VDC • 2-3/16 x 3-1/4 x 4 inches

MFJ-40V, Companion VFO ..... \$29.95  
MFJ-12DC, IC Regulated Power Supply,  
1 amp, 12 VDC ..... \$29.95



**\$17<sup>95</sup>**

### CPO-555 Code Oscillator

For the Newcomer to learn the Morse code.

For the Old Timer to polish his fist.

For the Code Instructor to teach his classes.

- Send crisp clear code with plenty of volume for classroom use • Self contained speaker, volume, tone controls, aluminum cabinet • 9 V battery • Top quality U.S. construction • Uses 555 IC timer • 2-3/16 x 3-1/4 x 4 inches

TK-555, Optional Telegraph Key ..... \$1.95



**\$19<sup>95</sup>**

### C-500 Digital Alarm Clock

This digital alarm clock is also an ID Timer. Assembled, too!

- Gives ID buzz every 9 minutes automatically, or after tapping ID/doze button • Pressing ID/doze button displays seconds • Large .63 inch digits • Easily zeros to WWV • AM and PM LED indicators • Power out indicator • Fast set, slow set buttons • 110 VAC, 60 Hz • 3-1/8 x 3-3/4 x 3-3/8 inches • One year warranty by Fairchild

Order any product from MFJ and try it. If not delighted, return within 30 days for a prompt refund (less shipping).  
Order today. Money back if not delighted. One year unconditional guarantee. Add \$2.00 shipping/handling.

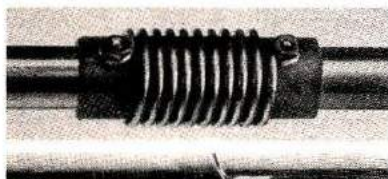
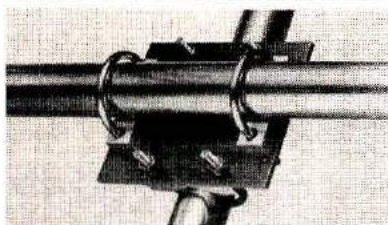
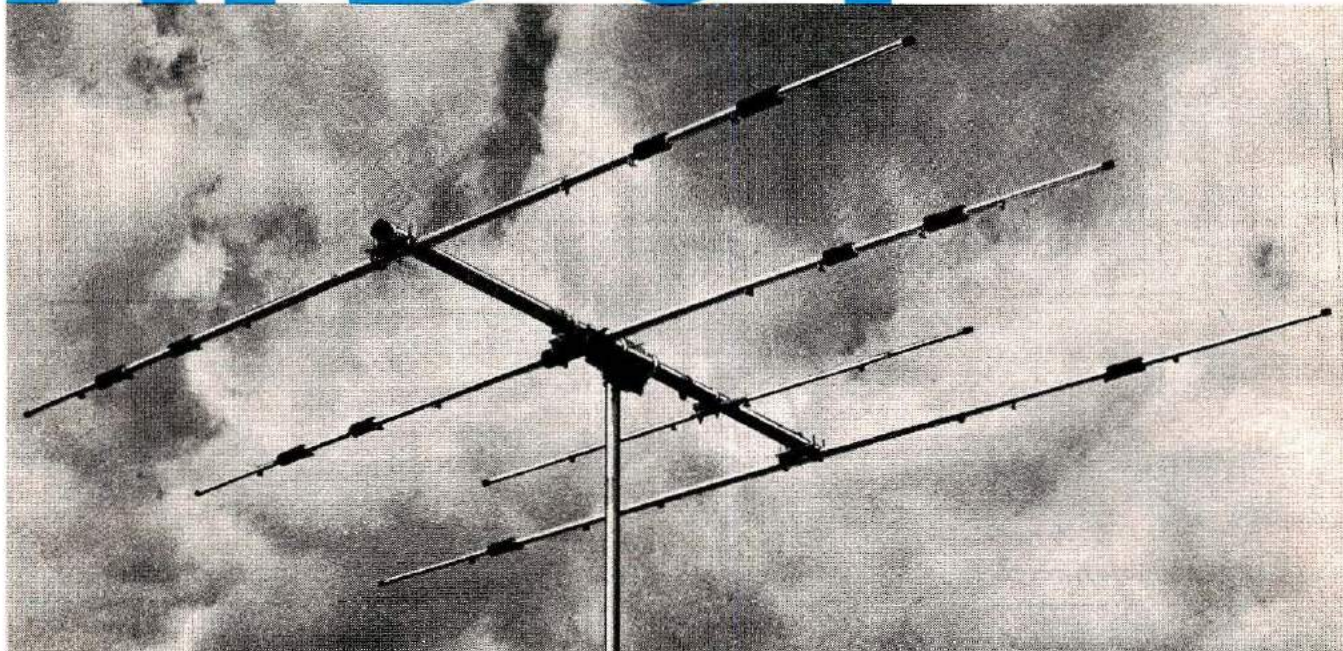
Order By Mail or Call TOLL FREE 800-647-8660 and Charge It On



**MFJ ENTERPRISES** P. O. BOX 494  
MISSISSIPPI STATE, MISSISSIPPI 39762  
In Europe contact: ING I. STERN, Lohkoppelstrasse 27, 2000 Hamburg 76, West Germany. Tel.: (040) 299-6110, Telex: 2161808 STEX D



# ATB-34



## 4 ELEMENT-3 BAND 10-15-20 METER BEAM

**Cushcraft** engineers have incorporated more than 30 years of design experience into the best 3 band HF beam available today. **ATB-34** has superb performance with three active elements on each band, the convenience of easy assembly and modest dimensions. Value through heavy duty all aluminum construction and a price complete with 1-1 balun.

Enjoy a new world of DX communications with ATB-34!

### SPECIFICATIONS

FORWARD GAIN -	7.5 dBd	WIND SFC -	5.4 Sq.Ft.
F/B RATIO -	30 dB	WEIGHT -	42 Lbs.
VSWR -	1.5-1	WIND SURVIVAL -	90 MPH.
POWER HANDLING -	2000 WATTS PEP		
BOOM LENGTH/DIA. -	18' x 2 1/8"		
LONGEST ELEMENT -	32'8"		
TURNING RADIUS -	18'9"		

**\$239.95**

**COMPLETE  
NO EXTRAS TO BUY**

**UPS SHIPPABLE**

**IN STOCK WITH DISTRIBUTORS WORLDWIDE**



# cushcraft

CORPORATION

BOX 4680, MANCHESTER, N.H. 03108



December 1, 1977  
Volume 1, Number 10

# HAM RADIO HORIZONS

## CONTENTS

**T.H. Tenney, Jr., W1NLB**  
Publisher

**James R. Fisk, W1HR**  
Editor-in-Chief

### Editorial Staff

Thomas F. McMullen, Jr., W1SL  
Managing Editor

Patricia A. Hawes, WA1WPM  
Executive Editor

Charles J. Carroll, K1XX  
Alfred Wilson, W6NIF  
Assistant Editors

### Publishing Staff

C. Edward Buffington, WB1AMU  
Assistant Publisher

Fred D. Moller, Jr., WA1USO  
Advertising Manager

James H. Gray, W1XU  
Assistant Advertising Manager

Therese R. Bourgault  
Circulation Manager

Ham Radio Horizons  
is published monthly by  
Communications Technology, Inc  
Greenville, New Hampshire 03048  
Telephone 603-878-1441

Subscription rates are  
\$10.00 per year, worldwide

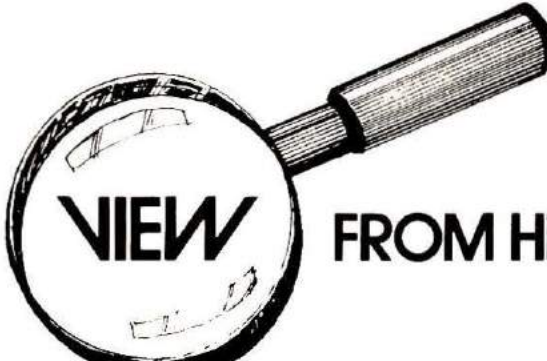
Copyright 1977 by Communications  
Technology, Inc. Title registered  
at U.S. Patent Office

Microfilm copies  
are available from  
University Microfilms, International  
Ann Arbor, Michigan 48103

Cassette tapes of selected articles  
from *Ham Radio Horizons* are available to  
the blind and physically handicapped  
from Recorded Periodicals  
919 Walnut Street, 8th Floor  
Philadelphia, Pennsylvania 19107

<b>Awards That Glitter</b>	12	
James H. Gray, W1XU		
<b>Your First Contact</b>	21	
Thomas R. Sundstrom, WB2AYA		
<b>Build A Wire Yagi</b>	26	
John P. Tyskewicz, W1HXU		
<b>A Power Supply for Your Projects</b>	30	
Douglas A. Blakeslee, W1KLK		
<b>Build an Equipment Enclosure</b>	38	
William Roth, WA2PVV		
<b>That Professional Appearance</b>	42	
Michael J. Goldstein, VE3GFN		
<b>Resistors, Capacitors, Inductors</b>	46	
Paul G. Schreier, WA1TWT		
<b>Ionospheric Signal Focusing</b>	54	
Calvin R. Graf, W5LFM		
<b>Questions? And Answers! Part 4</b>	60	
Thomas F. McMullen, W1SL		
<b>Activities Calendar</b>	76	<b>Newsline</b> 11
<b>Ad Check</b>	78	<b>Post Box</b> 71
<b>Ad Scan</b>	73	<b>Product Showcase</b> 66
<b>Advertiser's Index</b>	78	<b>Propagation Chart</b> 75
<b>DX Forecaster</b>	74	<b>The View from Here</b> 6
<b>Focus and Comment</b>	8	<b>This Month's Horizons</b> 2





# THE VIEW FROM HERE

It was just thirty years ago, on December 23rd, 1947, to be exact that a group of scientists at Bell Laboratories built a one-stage amplifier circuit around the world's first transistor, giving birth to a whole new era of electronics and communications. But the beginning of the story was not in 1947, but long before. There had been hints of amplification in semiconductors as early as the 1920s but few experimenters could duplicate the results. Nobody realized the effect of semiconductor impurities nor understood the action of semiconductor materials.

In 1930, Dr. Julius Lilienfeld, a German physicist, actually patented a semiconductor amplifier that could be compared to today's mosfet. Although Dr. Lilienfeld's amplifier worked, it could not be duplicated by other workers, and it slowly slipped into oblivion.

In 1939, Dr. William Shockley made an entry into his lab notebook at Bell Labs, "It has today occurred to me that an amplifier using semiconductors rather than vacuum is in principle possible." It was nearly eight years before this concept would bear fruit. A large part of this period was spent in learning more about that old bugaboo, semiconductor impurities.

The 1N21 crystal detector, developed during World War II and the workhorse of wartime radar receivers, provided some of the impetus. After the war a solid-state research team at Bell Labs, co-headed by Dr. Shockley, started experimenting with germanium and silicon, two semiconductors that were easy to work with. As one of the group said recently, "We felt that the area was so fertile that you could devise an experiment in the morning, go out in the lab and try it in the afternoon, and then write a paper about it that evening."

The first device the group attempted to build was what is now called an insulated-gate fet. The device didn't work. The group scrambled around, dug into the literature, and spent long hours discussing the alternatives.

Dr. Walter Brattain tried an experiment where he covered a metal point with a thin layer of wax and pushed it down on the surface of a piece of silicon. He then surrounded the point with a drop of water and made contact to it. The water was insulated from the point by the wax layer. He found that voltages applied between the water and the silicon would change the current flowing from the silicon to the point. Power amplification had been achieved! Unfortunately, the drop of water would evaporate almost as soon as things were working well.

This led to experiments with other electrolytes that didn't evaporate so readily. Then they discovered a thin oxide layer on the surface of the semiconductor under the electrolyte and decided to use a spot of gold as a field electrode to eliminate the electrolyte.

When this was tried, an electrical discharge between the point and the gold spoiled a spot in the middle — when they had washed off the electrolyte they had inadvertently washed off the oxide film, which was soluble in water. However, by placing the point around the edge of the gold spot they observed a new effect — when a small positive voltage was applied to the gold, the current flow was greatly increased. Four days later two gold contacts less than two-thousandths of an inch apart were made to the same piece of germanium and the first transistor was born.

Nine years later, in 1956, the three inventors, Dr. William Shockley, Dr. John Bardeen, and Dr. Walter Brattain were awarded the Nobel prize in physics. Little did they realize that their crude laboratory device would spawn a multi-billion dollar semiconductor industry that today affects all our lives.

**Jim Fisk, W1HR**  
editor-in-chief



ICOM wants you to

# Begin with the Best

As you develop your skills, increase your participation in Ham Radio activities, and add hardware for ever-increasing flexibility of operations, you'll come to know ICOM. Just ask any old Ham. ICOM is the quality name in VHF/UHF Amateur Radio equipment because it is simply the best. ICOM is the line you'll want to move up to for unequaled quality and features.

But you needn't wait until you can trade in a truck load of equipment to reach up to ICOM. You can begin building your Amateur Radio operations with reasonably priced ICOM units that have flexible add-on features when you purchase your very first voice transceiver. And when you are installing ICOM's top-of-the-line fixed station unit, the ICOM equipment you began with will probably still be an important integral part of your active hardware.

Don't delay in moving up to ICOM: begin with the best.



Clockwise from lower left: **IC-211** 4MHz, 2 meter, All Mode Transceiver; **IC-245** Mobile 2 meter Transceiver; **IC-225** Mobile VHF FM Transceiver; **IC-502** Portable 50 MHz SSB Transceiver; **IC-215** Portable 2 meter FM Transceiver; **IC-30A** Mobile UHF FM Transceiver.

Ask your dealer for ICOM's complete product line catalog, or mail your request to an address below.

VHF/UHF AMATEUR AND MARINE COMMUNICATION EQUIPMENT

Distributed by:

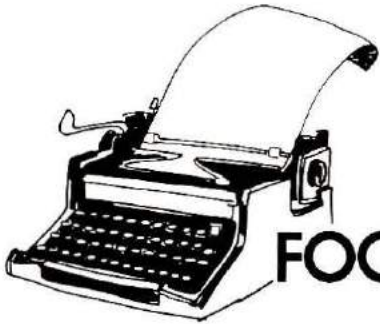


**ICOM WEST, INC.**  
Suite 3  
13256 Northrup Way  
Bellevue, Wash. 98005  
(206) 747-9020

**ICOM EAST, INC.**  
Suite 307  
3331 Towerwood Drive  
Dallas, Texas 75234  
(214) 620-2780

**ICOM CANADA**  
7087 Victoria Drive  
Vancouver B.C. V5P 3Y9  
Canada  
(604) 321-1833





## FOCUS & COMMENT

The flea-market season is over, the radio club picnics are all just a memory, and the field-day exercises are left behind with a resolve to improve the performance and score next year; what do you do now?

Well, this is the time to increase your personal enjoyment or involvement in our hobby. There are plenty of on-the-air activities in which you can do your stuff during the winter months. A whole new set of conditions are in evidence on our bands. The static has gone south with the sun, leaving 160, 80, and 40 meters fit to inhabit again. The vhf bands are no longer subject to sporadic openings as in the summer, but there is activity there — especially during the January VHF Sweepstakes event. Generally, conditions are more predictable in that there'll always be some band where you can find lively activity if you look around a bit. Club meetings, of course, should not be forgotten; they're great for keeping you informed about new developments, new activities, meeting new hams in the area, and for generating ideas and the enthusiasm to carry them out. But, it is in the area of on-the-air activities that you can really do things during these cool months. There are some big contests that you can enter — like the Annual ARRL DX test, or the CQ World Wide WPX Contest. If you like single-band forays, try the 160-meter Contest, or the 10-meter Contest, or both.

You don't have to go for the big ones to get your baptism in contest operating; there are dozens of smaller activities to be heard on the air every week. Try some of the QSO Parties sponsored by a club or group in some particular state or county. If you would like to hear how some of the earlier transmitters behaved, listen to (or join) the Classic Radio Exchange, where they use equipment that has been built since 1945, but is at least 10 years old — the age of the rig figures in the contest score. Then there is the Ten-Ten International Net QSO Party to keep the 28-MHz band alive during the winter.

Are you a beginner, afraid to dive into one of the big events? Don't let that stop you; there's a Novice Roundup coming soon. Or, how about public-service work? Several of the well-established traffic nets have slow-speed auxiliary sessions that are designed to train newcomers in the procedure of handling messages. You can join the local club effort in the Simulated Emergency Test, and gain experience and confidence that will stand you in good stead when the real thing hits your vicinity.

There are many things that you older hands can do — like the OOTC (Old Old Timer's Club) QSO party. Or, try dragging out your hand key, dropping in on a Novice contest, and working a few of them. Your good sending and correct procedure will give them an example to follow, and they'll get a kick out of working someone who is farther up the ladder than they are; "Gee, he's an Extra, and he called *me!*"

If you *really* want to start something, stand up at the next club meeting and ask who is the newest licensee in town, or if anyone has his ticket but doesn't have a rig or antenna yet, or who has so much TVI that operating in a contest is out of the question. Offer him the use of your station for some on-the-air event. I'll bet neither one of you will ever forget it!

**Tom McMullen, W1SL**  
Managing Editor



# SPECIAL TRIPLE BONUS DEAL on KENWOOD TS-820S

**SERVING  
HAMS  
BETTER!**

*North ... south ...  
east ... west*

All leading brands ...  
in-depth stocks ...  
new/used gear.



### The deal:

- 1)—Send us 1048.00\* (in the form of check, M/O, BankAmericard, VISA, Master Charge)
- 2)—We'll ship you immediately, a beautiful brand-spanking-new, peerless performing **KENWOOD TS-820S TRANSCEIVER!**
- 3)—PLUS a BIRD Model 43 wattmeter (a 120.00 retail value).
- 4)—PLUS prepaid shipment of both items by **U.P.S. (Brown).**

\* (Calif. residents add 6% sales tax)



**BIRD ELEMENTS**  
(Not supplied with BIRD wattmeter)  
2-30MHz ... **42.00**  
25-1000MHz ... **36.00**



### TRI-EX W-51 TOWER

### HY-GAIN TH6DXX

De Luxe, 6 element Hy-Gain Thunderbird, covers 10, 15, 20 meters. Separate low loss traps for each band. Hy-Gain Beta match for low VSWR with 50 ohm line.

Longest element: 31.1 ft.  
Boom: 24 ft.  
Turning radius: 20 ft.  
Wind load: (80 mph): 156 lbs.  
Max. wind survival: 100 mph.  
Surface area: 6.1 sq. ft.  
Net weight: 57 lbs.

Our "package" deals can't be beat! The "package" antenna, tower, rotator *Inquire*

Every-day special  
**CDE HAM III  
rotator  
12995**

**SHURE 444  
33.95**

shipped prepaid,  
UPS (Brown).



**OTHER  
BIG VALUE  
SPECIALS**

**ICOM IC-22S VHF Transceiver  
plus CUSHCRAFT  
Ringo Ranger  
Antenna**

**279.00!**  
shipped  
prepaid,  
UPS  
(Brown).



OVER THE COUNTER (Mon. thru Sat. 10AM to 5:30PM), PHONE, WRITE. SAME DAY SHIPMENT MOST ITEMS.

# HAM RADIO OUTLET

### SOUTH

Anaheim, Calif. 92801  
2620 W. La Palma, (714) 761-3033  
1 mile east of Knott's Berry Farm.

### NORTH (Main Office)

Burlingame, Calif. 94010  
999 Howard Ave., (415) 342-5757  
5 miles south on 101 from S.F. Airport.

### SOUTH

Van Nuys, Calif. 91401  
13754 Victory Blvd., (213) 988-2212  
Dealer inquiries invited.



**Bob Ferrero,**  
K6AHV/W6RJ.  
Jim Rafferty,  
WA9UCE/K6AAR,  
other well known hams,  
give you courteous,  
personalized service.



• ATLAS • BIRD • CDE • COLLINS • CUSHCRAFT • CURTIS • DENTRON • DRAKE • EIMAC • HUSTLER  
• HY-GAIN • ICOM • KENWOOD • KLM • MOSLEY • SWAN • TEMPO • TEN TEC • TRI-EX • YAESU • more.

More details? Ad Check page 78.

December 1977 **RR** 9





# NEWS

# BULLETIN

**LOOK WHAT WE'VE GOT  
IN STORE FOR YOU!!**



YAESU FT-301D "GOLD LINE"



**HALLICRAFTERS  
H2M-1000 and H2M-500**

## VARIETY *PLUS* . . . S-E-R-V-I-C-E



DENTRON MLA-2500



TEN-TEC TRITON IV



ATLAS 350-XL



DRAKE TR-4CW



KENWOOD TS-520S



TEMPO 2020

73's STAN BURGHARDT WØIT BILL BURGHARDT WBØNBO JIM SMITH WBØMJY ERV HEIMBUCK KØOTZ

**STORE HOURS:**  
TUESDAY thru SATURDAY  
9:00 A.M. to 5:00 P.M.  
Closed Sunday & Monday

124 First Avenue Northwest  
P.O. Box 73  
Watertown, South Dakota 57201  
Phone 605-886-7314



Write today for our latest Bulletin/Used Equipment list.

"America's Most Reliable Amateur Radio Dealer"

**Your Full-Line Ham Dealer Where S-E-R-V-I-C-E is our most important product.**



# NEWSLINE

W8YMB'S LIFE WAS SAVED recently when a fellow engineer at WKYC-TV, who had just assisted at the taping of a show on the "Heimlich Technique," used that technique on Cliff as he choked on a bite of food in the station cafeteria. Ironically, the Lake Erie ARA, to which Cliff belongs, had had a club program on the Heimlich technique and CPR about 15 months ago, and has a repeat scheduled for next month's program. It's highly recommended as a club program with life-saving potential.

EXTRA CLASS APPLICANTS wishing to apply for a 1x2 callsign immediately after passing the Extra exam should bring their 1x2 application along when they appear for the exam. Then — assuming they've passed — ask the examiner to send in the 1x2 application along with the upgrade papers. If the 1x2 application is submitted separately, before the new Extra Class license is received, considerable delay is likely while the two submissions find each other.

Pre-1917 Amateur Licensees must apply for "Grandfather" credit toward an Extra Class license before next March 1, after which it will no longer be offered. Grandfather credit has been available for quite a few years but no one has claimed it for some time.

THE FCC WAS CHALLENGED sharply by Richard Ziegler's lawyer in the aftermath of the former FCC Special Licensing Chief's conviction for bribery (November HRH). What upset the lawyer (and Federal Judge Malcolm Muir) was a memo from the Chairman's office reportedly cautioning Commission employees to restrict their testimony at the trial. The Lawyer's Contention is that the circumstances of Ziegler's case really go much further than the four cases for which he was indicted and tried, and that "favors (such as preferred Amateur callsigns) are routinely granted," even though they shouldn't be. Further Investigation is going on, with some stories currently going around that the number of Amateurs potentially involved is "in the hundreds!"

AMSAT-OSCAR 7 ORBITAL DATA CALENDAR has been published by Skip Reymann, W6PAJ. This improved version contains all orbital dates and information for 1978. It is designed to be hung on the wall, and includes information on operating schedules and frequencies, telemetry decoding equations, and step-by-step methods of determining times of satellite passage.

The Calendar Is Available, post-paid, for \$5.00, U.S. funds, or 30 IRCs. Cost to AMSAT members is \$3.00; free to AMSAT Life members. Orders and payments should be sent to Skip Reymann, W6PAJ, P.O. Box 374, San Dimas, California 91773. A self-addressed gummed label will speed handling of your order.

Proceeds From The Sales of the calendar will help AMSAT in their continuing program of developing and launching new satellites.

SIMPLIFYING AMATEUR RULES in a fashion similar to the proposed CB Rules rewrite (Docket 21318), has drawn some favorable comment in view of the very positive reaction thus far registered for the CB-Rules effort. Such a rewrite could have many benefits for the amateur fraternity, for example, elimination of many of the ambiguities that confuse amateur operators and thereby generate new petitions for rule making.

FCC's Radio Control Rules, Part 95(C) is stock number 004-000-0341-1 and sells for 80¢ from the Superintendent of Documents, U.S. Government Printing Office, Washington, D.C. 20402.

CB Rules Subpart E (Technical Specifications) is newly out; its stock number is 004-000-00343-8, also 80¢. Note the GPO's minimum order is \$1.00.

ARRL'S "WASHINGTON AREA ACTIVITIES COORDINATOR" is Hal Steinman, K1FHN. Hal's responsibilities will include the entire Washington scene; Congress, OTP, the White House, and various government agencies including the FCC. He'll continue to work out of Newington while continuing other League responsibilities.

"RELICS OF THE ELECTRICAL AGE" is a 48-page directory of both museums and private collections featuring electrical and electronic memorabilia just published by the Smithsonian Institution. Compiled by Robert Belfield with the aid of a grant from IEEE, it is available free from the Division of Electricity and Nuclear Energy, Smithsonian Institution, Washington, D.C. 20560.

FOUNDATION FOR AMATEUR RADIO'S 1977 scholarships went to WB4HBK (the John W. Gore Memorial Scholarship), WB9NIQ (The Richard G. Chichester Memorial Scholarship), WB0QCC (the Edwin S. Van Deusen Memorial Scholarship), and WB9SZN (the Radio Club of America Scholarship). Congratulations to all!

FEWER NEW AMATEURS RECEIVED LICENSES this past July than in July 1976 — 14518 vs 15873. This August's totals just barely exceeded last August's 16685 to 16414. All those totals were comfortably ahead of earlier summers; 1975 and before averaged about 8000 a month for July and August.





# All Is Not Gold That Glistens

BY JIM GRAY, W1XU

"... Hey, OM, do you belong to the RCC?" If you're a newcomer, a beginner, a Novice, this question may come as a surprise during one of your QSOs. What is "RCC?" What does the other station mean by "belong?" You don't quite know how to answer the question, so you ask for information, and learn that RCC stands for *Rag Chewers' Club*. In short, you're being asked if you have qualified for membership in a group whose members have each made one, continuous, half-hour contact by Amateur Radio with another member. "Rag chewing" is the

amateur's name for "Ratchetjawing," a term well known to CBers, and is a time-honored pastime among hams. To join, you must be sponsored by someone who is already a member, and your badge of membership is a certificate signed by "The Old Sock." The membership, and the piece of paper for your wall, constitute an award, perhaps the first of many you'll receive during a long and active career in Amateur Radio.

## What is an award?

In Amateur Radio there are literally hundreds of awards,

usually earned for an operating activity of some kind in which an amateur fulfills the requirements established by a group that sponsors the award. Awards are sometimes made for perseverance and operating skill, for meritorious service to the public, or for operating achievement. Some, like the RCC award, are very easy to achieve, but others are extremely difficult, and may be held by only a few distinguished amateurs in the entire world.

Although a few amateurs may be criticized sometimes as certificate seekers, the



certificate is only the symbol of the award itself, and the ham who has qualified for it and earned the right to display the certificate has the satisfaction of knowing that he has worked long and hard for the award. In most cases, it's the trip and not the arrival; the means and not the end, that brings the greatest satisfaction.

### Who awards the awards

The first awards in Amateur Radio were established by the ARRL (American Radio Relay League) and the RSGB (Radio Society of Great Britain). Some of these original awards are still being issued and are greatly sought by hams everywhere. Newer awards by other organizations of Radio Amateurs including the International Amateur Radio Union (IARU) and similar groups — all in some way radio-associated — are just as prestigious, and as difficult to earn.

At present there are over 80 major awards, and many more minor ones for which amateurs everywhere are competing — not always against each other, but also against time, propagation conditions, power and antenna limitations, and other factors that are often beyond their control. Such conditions make the chase more exciting and the award more valuable when, and if, it is finally won.

Perhaps one of the earliest domestic awards sponsored by the ARRL was the WAS — *Worked All States* — award, which requires the amateur to show proof of having worked all fifty states of the United States of America. You can use any band or any mode to accomplish your WAS, and the proof will be the confirmation of contact — QSL — cards that you receive. The QSL cards are sent to the ARRL, which verifies them, issues a numbered certificate, and returns the cards to you.

Although you may think that

this is a simple and easy award to earn, remember that states having low Amateur populations may be difficult to work. For example, Delaware, Montana, Utah, Nevada, Vermont, and Wyoming are among the more difficult for this reason.

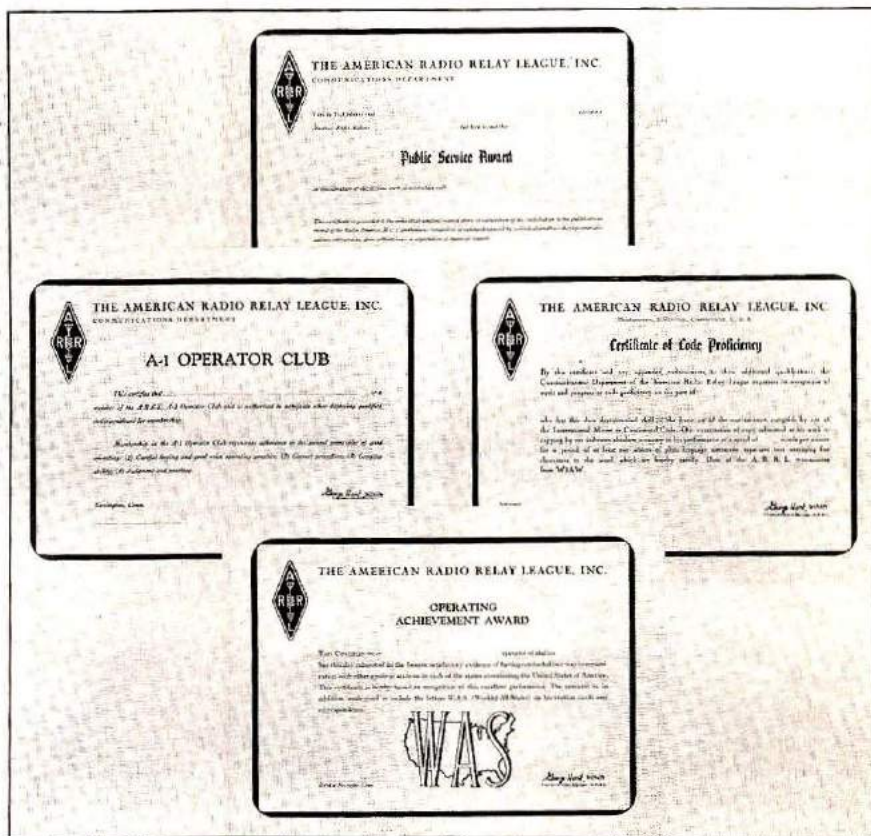
After you have achieved WAS, you may want to try it on each band, or perhaps all five high-frequency bands, from 80 through 10 meters. There are single-band endorsements for your original WAS certificate, and there is a separate certificate entirely for the *Five-Band WAS* award which became effective January 1, 1970, and requires that you work all states on each of five different amateur bands.

You must make all of the contacts for any award from

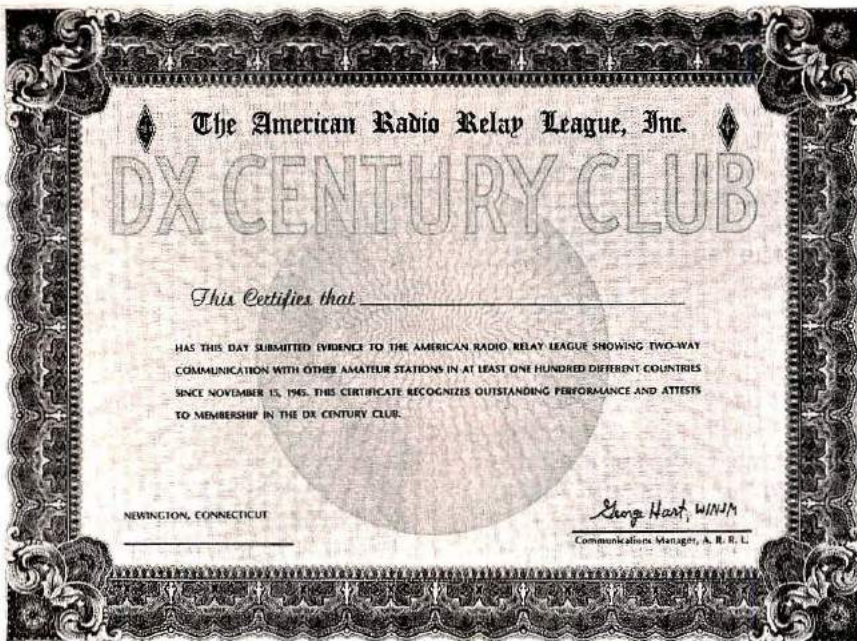
the same location, or locations within 25 miles (40km) from each other. You cannot count contacts made before the official dates of statehood for Alaska or Hawaii (August 21, 1959, and January 3, 1959, respectively) and you cannot count contacts made by repeater. The one exception is OSCAR contacts, which entitles you to a special endorsement for working all states via the Amateur Satellites.

In the early days of radio, when fewer amateurs were on the air, when the average station was perhaps 25-50 watts power, when receivers — especially at the higher frequencies — were not all that good, and when fifteen meters was not available to Amateurs, WAS was somewhat more

A sampling of several of the better-known certificates from the American Radio Relay League shows some that are awarded by nomination and others that can be applied for. The Public Service award is given for outstanding performance during times of emergency; a good operator can be nominated for the A-1 Operator Club in recognition for on-the-air habits. You can apply for a Code Proficiency certificate at the lowest level, 10 wpm, and work up to the highest, 40 wpm. If you contact all 50 states you can apply for the WAS certificate.







This is perhaps the most prestigious and most sought award in amateur radio. With a minimum requirement of contact with amateurs in 100 countries, it is just hard enough to keep you on your toes. Between 100 and 200 countries, you'll spend a lot of time in the shack, playing the propagation and pileup games, and by the time you get near the 300 countries mark, you will know you have been through the mill. It's an ARRL award, and when they say it recognizes outstanding performance they're not kidding! Various band and mode endorsements are available. Just to keep you in top form, they also offer a five-band DXCC.

difficult to achieve. That is why *Single-Band*, or *Five-Band*, *WAS* was introduced, to make the accomplishment as difficult to obtain as it used to be, and to encourage Amateurs to sharpen their operating skills

and hone their stations to a fine edge of efficiency.

Interestingly, *Five-Band WAS* is a one-time award only, and a beautiful, personalized tile commemorates your achievement.

The Czechoslovakian version of the Worked All Continents award is S6S (*Spojeni se 6 Svetadily*). Contacts with stations on each continent can be recognized for five amateur bands by endorsement stickers for each one.



One more thing: Anyone in the United States or its possessions, Puerto Rico, or Canada, who wishes to try for the *WAS* or *Five-Band WAS* award, must be a member of the ARRL. From this you may correctly infer that Amateurs elsewhere in the world are eligible; the only difference being that they do not have to belong to the ARRL.

### DXCC

The *DX Century Club* award is, as its name implies, an award issued to an amateur



An interesting award for the amateur who uses both phone and CW is this certificate from South Africa. To earn this one you have to work stations in six countries on each of six continents on both phone and CW.

who has worked 100 countries by Amateur Radio. This is one of the oldest and most prestigious awards, and doesn't stop at 100 countries, either. The basic certificate is issued in honor of your accomplishing the first 100 confirmed contacts, but there are endorsements for each additional ten countries, submitted in groups of 20, that will be added to your certificate as you increase your stations-worked totals.

The contacts for general (mixed modes) and phone *DXCC* must have taken place



since November 15, 1945, (effectively three months after cessation of World War II hostilities). Recently, a CW DXCC award was introduced, and contacts for this one must have been made since January 1, 1975.

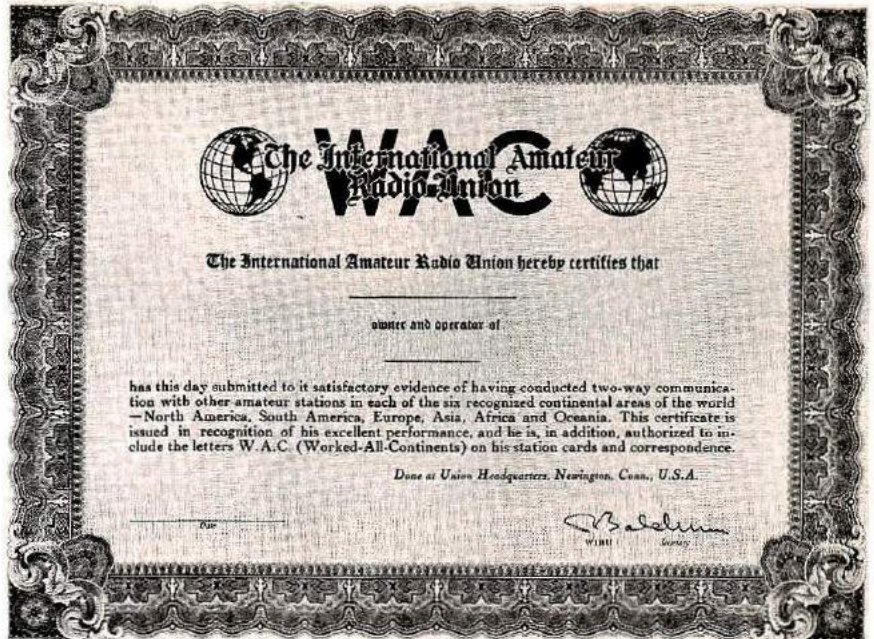
Although it is relatively simple to work 100 countries, or even 200 countries, the going begins to get really tough after about 250 DX confirmations have been received. As with other awards, the cards must correctly list your call, and give details



This interesting certificate comes from Poland. To obtain it you must talk to amateurs in 16 of the 23 countries that are on the 21st Meridian, where Warsaw is located. It is also available to Short-Wave listeners on a "heard" basis.

confirming the fact that two-way communication was established. This means that "heard-only" stations don't count for DXCC. As you pass the 250-countries-worked total, you may submit cards in groups of 10; and when you pass 300, you may submit in groups of 5.

As political climates and boundaries change, some countries are created and others deleted, meaning that the "official countries" list —

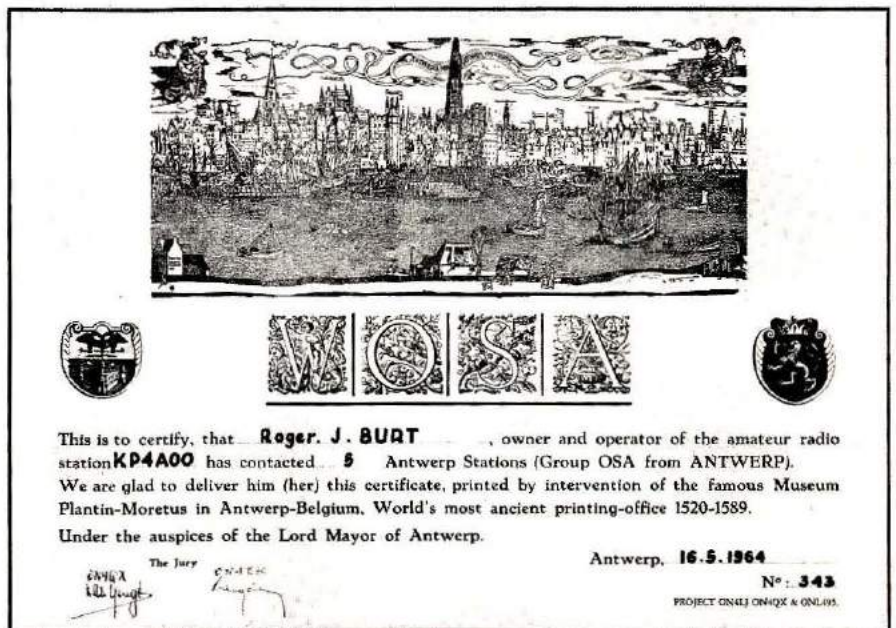


One of the earliest tests of a beginners skill at operating, propagation forecasting, and patience is to contact an amateur station on each of the six major continents. The recognition of that feat is in the form of a Worked All Continents (WAC) certificate. It is an International Amateur Radio Union award, administered by the IARU Headquarters (ARRL Headquarters) in Newington, Connecticut. It can be endorsed for a specific band or mode of operation. A five-band WAC certificate is also available. Amateurs outside the United States and Canada must apply through their own IARU member society.

which is established at ARRL Headquarters — changes. In the years since DXCC has been established, many countries have been deleted, but before then many amateurs worked

them for credit. When you reach the "top ten" status in DXCC, the worked countries that no longer exist are deleted from your totals, but are listed along with your name and call

What appears to be a wood-cut print adorns this certificate from Group OSA in Antwerp, Belgium. It was printed by the World's most ancient printing office, which was established in 1520. You can obtain one of these by contacting 5 stations in Antwerp. It's a large certificate, sure to attract attention on your shack wall.





# IARU FIVE-BAND WORKED ALL CONTINENTS AWARD



is presented with this award in recognition of having contacted, since January 1, 1974, each of the six recognized continental areas of the world on each of five frequency bands allocated to radio amateurs.

The IARU Five-Band Worked-All-Continents certificate is a handsome color photograph of the Earth as seen from Apollo 8 in orbit around the Moon. Contacts made since January 1, 1974 on five amateur bands, count toward this award. A most decorative addition to any hamshack wall.

in an *Honor Roll*, that is published in *QST*. Aside from the distinction of having worked the countries, you have also accomplished something

that's far more important: You have become an international Amateur Radio operator, using your skills to communicate with fellow amateurs around

Satellites get into the act too. You can earn this one by contacting new stations (10 points each), new countries (50 points), and new continents (250 points) for a total of 1000 points. Only contacts made after December 15, 1972, through the Oscar satellites, count toward this award.



the world. You have done something to cement the bonds of friendship among hams, and you have proved your endurance and tenacity in meeting a challenge.

Someday, you will travel and meet some of these amateurs you have talked to. Imagine walking into a foreign Amateur's station and seeing *your* QSL card prominently displayed on his wall! QSLs themselves become collectors' items, and many permanent friendships have been established through *DXCC*.



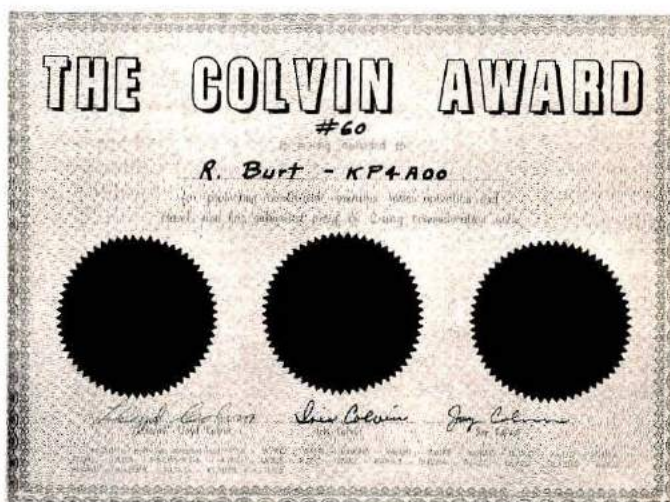
The contest operator is not forgotten either. When you come out ahead of the competition in your section during one of the many ARRL-sponsored contests, you receive this Contest Achievement Award. A neat, modern, certificate that is well worth striving for.

Stamp collectors, in particular, find all kinds of opportunities to share their interest in this hobby, too, inasmuch as many foreign DXers are avid stamp collectors.

## Five-Band DXCC

Just to make things more interesting, a new award was established on January 1, 1969. It combined the *DXCC* idea but, in a fashion similar to the *Five-Band WAS*, made the stipulation that you had to work 100 countries on each of the five high-frequency Amateur bands from 80 through 10





There are many interesting and unusual awards from all parts of the globe. Here is a small sample, including the OHA certificate from Finland that is given for contacting a specified number of Finnish amateur stations. A South American certificate, WHC is offered for contacting a minimum of 5 districts within Ecuador. The Colonial America award can be earned by contacting two stations in each of the original 13 Colonies. The Colvin Award is unique in that it recognizes the accomplishment of contacting people who are hams in the same family. The Colvins, Lloyd, Iris, and Joy, had operated under 28 calls at the time the certificate was printed!

meters. This is an award that permits you to use any mode of communication and, when achieved, consists of a very attractive seven-color plaque bearing your name, call and a serial number.

#### WAS — IARU

The *Worked All Continents* award is not strictly an ARRL award, but the ARRL administers the award through the IARU — the International Amateur Radio Union. In other countries, the respective radio societies administer this international award for their own Amateurs. *Five-Band* or *Six-Band WAC* awards were issued after January 1, 1974,

and it is possible to get special endorsements for all-ssb, single-band, RTTY-only, and other similar categories.

It is required that you submit proof, in the form of original QSL cards, confirming contact with each of the six major continental areas of the world: Europe, Asia, Africa, Oceania, and North and South America. All of the contacts must have been made from a single location, or from a spot within 25 miles (40km) of that location — such as in a metropolitan area.

#### Satellite Achievement Award

Amateurs who have accumulated 1000 points for working other amateurs by

means of the Amateur Satellites since December 15, 1972, may qualify for this multi-colored certificate and award. The points are counted as 10 for each station, 50 for each new country, and 250 for each new continent.

#### Brass Pounders League

One of the oldest activities in amateur radio is traffic handling. In fact, The ARRL got its name from traffic handling — the American Radio Relay League — in which hams sent and received messages (traffic) *free of charge* by amateur radio to all parts of the United States. These messages were of all kinds, and often





Licensed amateurs, and SWLs on a "heard" basis, can apply for this handsome certificate from Switzerland. It is truly impressive with all of the Coat-of-Arms in color. Swiss amateurs must work two stations in each of the 22 Cantons; others can work just one in each Canton. Two of the oldest towns show dates of 1291!

originated from persons who had no regular mail or telephone service, but did know a friendly ham in the neighborhood. Since the early messages were sent by CW (continuous wave) Morse Code telegraphy, and because most early keys were made of brass, amateurs became known as "brass pounders." The up-and-down action of these old straight keys was analogous to pounding with a hammer, and exists to this day.

In a very real sense, this is an operator's award for performing a unique service, and is based on each participant's monthly "traffic" count — the number of messages sent and/or received — as reported to the ARRL Section Communications Manager for the section in which the Amateur lives. Some hams make *BPL* every month, and devote their operating activities almost wholly to traffic handling.

#### Public Service Award

One of the awards you don't consciously work for is this award based on meritorious

service to the public in times of emergency or disaster. Perhaps your station forms a vital communications link for handling priority messages in and out of a stricken area, where other types of communication have failed or are badly strained. Amateurs who perform this valuable service are almost always surprised when they receive ARRL's *Public Service Award*, because they have not *consciously* striven for it, but have been proposed as a recipient by others who have recognized — and wish to compliment — their efforts.

#### Awards of other nations

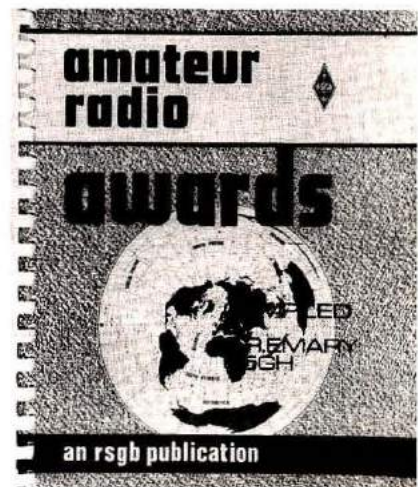
Most of the countries of the world have active Radio Amateurs who have banded together in Societies, Leagues, Federations, and Groups. Among the better-known are the Radio Society of Great Britain (RSGB), the Japanese Amateur Radio League (JARL), the Deutscher Amateur Radio Club (DARC), Reseau des Emetteurs Francais (REF), VERON of Holland, ARI of Italy, the Central Radio Club of the

USSR, the South African Radio Relay League, and many, many others in Australia, New Zealand, South America — virtually every major country.

The *Helvetia-22* award is issued by L'Union Suisse Des Amateurs Sur Ondes Courtes (USKA), the Swiss Amateur Radio Union, to any Amateur who works all 22 of the Swiss Cantons (provinces) by phone, CW, or mixed modes. The certificate is colorful and bears the coat of arms of each Canton on its border.

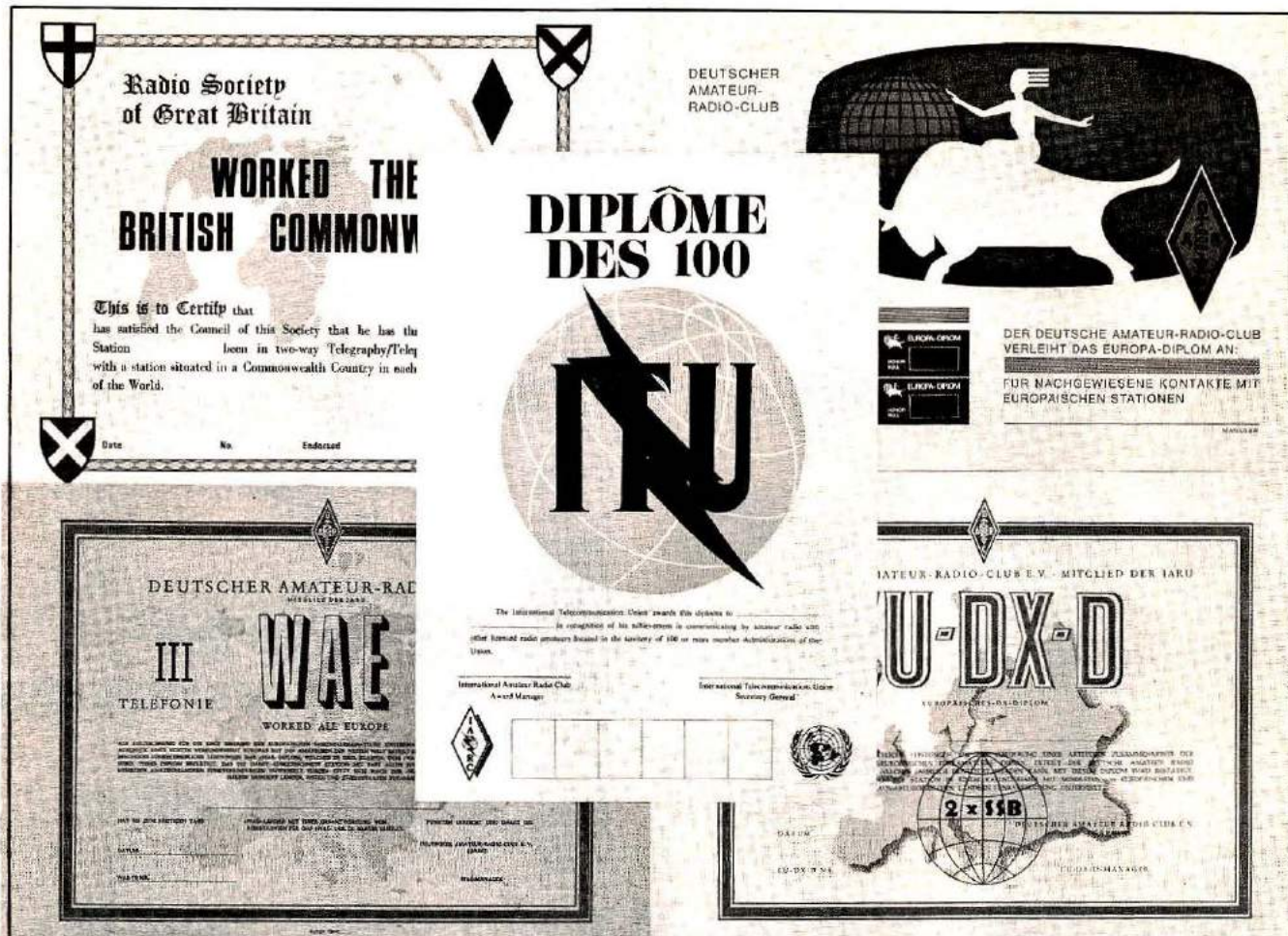
The *WACAN* and *WAVE* awards are issued by the Canadian Radio Relay League (CRRL). The *Worked All VE* requires that you confirm contact with two different stations on two different bands in each of eight Canadian Provinces (those having VE prefixes); and the *Worked All Canada* requires that you confirm contact with two stations in each of the 12 Canadian Provinces or Territories. Holders of one award can qualify for the other by making the proper showings.

The *Worked All Europe*



If you want to know more about awards, and how to apply, there are a couple of books that will help. Here's one, *Amateur Radio Awards*, by G5GH. It's available for \$4.95 from Ham Radio's Communications Bookstore, Greenville, New Hampshire 03048. Order RS-AW. Another is the *DX Awards Log*, by W6IZE. It is a handy place to keep track of your progress toward many of the more popular awards. The price is \$2.50, order DX-AL from Ham Radio's Communications Bookstore.





Many of the European certificates are quite colorful in addition to recognizing a significant achievement. The red, blue, and white Worked the British Commonwealth certificate is awarded for working one station in a Commonwealth country on each continent. The Europa Diplom is awarded for a total contact points of 100 or more, earned by a sliding scale of points per contact with European stations over a five-year period; it is a green, blue, and orange certificate. EU-DX-D is a blue, green, and red certificate awarded for a 50 point minimum, with each country generally counting as one point per year. The WAE award is red, blue, and green, on simulated parchment, and can be earned by working each European country, with several variations as to level of difficulty. On an International level, the Diplome des 100 is awarded by the International Telecommunications Union and the International Amateur Radio Club for contacting amateurs in the 100 or more administrations of the ITU. It has a bright red lightning stroke crossing a blue globe.

Award (WAE) is issued by the German Amateur Radio Club (DARC) to a licensed Amateur who confirms contact with 40, 50, or 55 of the 60 European Countries, and accumulates 100, 150, or 175 points, respectively. The WAE certificate is numbered WAE 3, 2, or 1, for the above-numbered contacts; the latter being the most difficult to win. Of the six bands (180 - 10 meters) permitted, only four bands per country may be used to accumulate the necessary points.

The Worked All Pacific Award (WAP) is issued by the New Zealand Association of Radio Transmitters (NZART) to

any licensed Amateur who confirms contact with any 30 of the 58 listed islands, countries, territories and protectorates that make up Oceania.

These are just some of the literally hundreds of possible awards that are available from the different Amateur Radio organizations of the world. They make attractive "wallpaper" but, more important, they symbolize your operating proficiency. Besides that, they are a lot of fun to work for, and the result will be a host of new friends and a better understanding of geography.

The references will give you source names and addresses

where you can write for additional information about one of the most fascinating of all amateur activities — award and certificate hunting.

### References

1. C. R. Emary, G5GH, *Amateur Radio Awards*, Radio Society of Great Britain, London, 1973. Available from *Ham Radio's Communications Bookstore*, Greenville, New Hampshire 03048. Order RS-AW, \$4.95.

2. *ARRL Ham Radio Operating Guide*, American Radio Relay League, Newington, Connecticut 06111, 1976. Available from *Ham Radio's Communications Bookstore*, Greenville, New Hampshire 03048. Order AR-OG, \$4.00. **HRH**



# Attention! Novice licensees . . .

KLM-21-21.5-6LD  
"BIG STICKER"

# 15 meters is on the rise

Cash in on the  
tremendous potential  
of this  
super DX band.

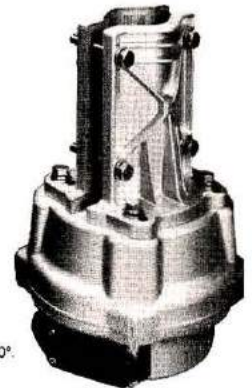
## Start right with KLM's big value combo.

(Antenna, 189.95. Rotator, 109.95. Total 299.90 suggested list)

Here's a beam that could well be the 15 meter mainstay of any big-gun DXer. It's a full size, super performance antenna with **six elements** that can put you in the drivers seat with a whopping 10-fold increase in equivalent output power and a big, bang-through signal. KLM's exclusive "Big sticker" design that features **dual driven elements**, assures front-to-back ratio of more than 30db and low VSWR across the entire band. . . **without retuning.**

This high quality beam is affordable. Costs have been reduced by decreasing boom diameter to 2 inches compared to 3 inches for the standard model. This change reduces weight from 60 to 34 pounds resulting in a beam that can be turned easily by KR-400, KLM's modestly priced, medium duty rotator. So now you can enjoy all-out performance while saving substantially on cost of both antenna and rotator (for severe ice loading conditions the heavy-duty model is recommended.)

The combo is a good, long-term investment. Install this beam and rotator now for your present novice operations. . . stay with it and continue to rack up the DX when you move to other 15 meter frequencies with your general class ticket.



**INR VOLTAGE:** 115VAC, 50/60Hz.  
**ROTATION TIME:** Approx. 1 minute for 360°.  
**BRAKE:** Motor disc brake holds to 1750 inch/pounds (200 cm/KG).  
**LIMIT SWITCH:** 360° limits.  
**CONTROL CABLE:** 7 conductor (use Belden 8448)  
**CONTROL BOX:**  
**Inches:** 5.9H, 4.33W, 7.48D.  
**MM:** 150H, 110W, 190D.  
**ROTATOR DIMENSIONS:**  
Max. diameter: 7.75" (197mm)

**KR-400 Rotator**

**MAST SIZES:** 1.5" to 2.5" (38-63.5mm)  
**SHIPPING WEIGHT:** 18 lbs (8.16KG)  
**All hardware stainless steel.**

At your favorite dealer. Write for catalog.

# KLM

electronics, inc.

17025 Laurel Road, Morgan Hill, CA 95037 (408) 779-7363

**Part No.** (for ordering): KLM-21-21.5-6-LD  
**Freq. of operation:** 21 to 21.5MHz  
**Elements:** Six  
**Element length:** (Max) 24.66 ft (7.53M)  
**Gain:** 10.5 dbd  
**Front to back ratio:** 30db typical  
**VSWR:** Less than 1.5:1 across band.  
**Feed impedance:** 200 ohms balanced  
KLM-3-60-4:1 Balun optional.  
**Boom length/diam.:** 38.5 ft (11.75M)  
D. 2 ins. (50.8mm)  
**Turning radius:** 20 ft (6.1M)  
**Wind area:** 5 sq. ft (0.46 sq. M)  
**Shipping container:** 11 ft. (3.35M)  
Wgt. 37 lbs. (16.78KG)  
**Weight:** 34 lbs. (15.42KG)  
**Nom. mast size:** 2 ins. (50.8mm)



# THAT FIRST QSO



**Strike up a conversation with your fellow ham**

**BY THOMAS SUNDSTROM, WB2AYA**

What's it like? What happens? You are a newly licensed Novice who has endured eight or ten weeks of adult evening school or club class designed to get you that first ticket, and now you have it. But where's all the help you thought you were going to get once the ticket arrived? Too often, you, the new amateur, are cast adrift without such help, so where to from here?

It's not hard to assemble a station nowadays. The equipment is compact and relatively simple to operate, and your first order of business is to select either a transceiver or a separate receiver and transmitter and get on the air.

Much already has been written in the pages of *Ham Radio Horizons* and elsewhere on how to do this, and now the dits and dahs are pouring through the speaker or the headphones. How do you get into that apparently large mass of signals?

### The first step

"You gatta hear 'em before you can work 'em," is an old, but very true, adage. Select one of the bands that seems to be active and tune very carefully. Your receiver section should have a CW filter within it, and you may also want to use an external CW filter such as the variable selectivity Autek

Research QF-1, or the fixed bandwidth MFJ Enterprises CWF-2BX.

Make sure you are within the band edges for your class license, and look for an empty spot. Thanks to the filter, what at first seemed to be a myriad of signals is now a number of separate conversations. Having trouble copying through the speaker? Get a comfortable pair of headphones and tune again. Found an empty spot where no one seems to have been for two or three minutes? Let's go!

The first QSO! Every ham remembers that exciting event. What happens in a QSO? What's a QSO? That's a two-way contact; an exchange of information.

Contacts in the Novice bands invariably take the form of "RST-QTH-name" on the first exchange of both parties. You should send code at the same speed that you want to receive. If you fly through your call, the operator at the other end is going to answer you at that same speed. If you are sending faster than you can copy code, you are going to have a problem. Let's look at the opening of a QSO:

CQ CQ CQ DE WB2AYA  
WB2AYA WB2AYA K

A 3X3 call (three CQ's followed by my call three times), "calling any station out there, this is WB2AYA, go ahead," should be sufficient unless the band is inactive. You have dumped your CQ into that empty spot you found, so listen for a reply, and tune a little (very little — don't crank the knob like a steering wheel) up and down near your transmitting frequency. If you get no response, try again.

Sometimes, depending upon the band activity, a longer CQ is called for, perhaps a 5X3 or a 10X3, but no longer. I have listened to some stations who call CQ for five minutes straight before signing their call! No one is going to hang



around to answer something like that. Shorter calls with numerous breaks to listen is the proper procedure.

WB2AYA WB2AYA DE WD8AAA  
WD8AAA K (or AR)

"WB2AYA, this is WD8AAA. Go ahead." A 2X2 call in reply should be enough unless the band is very crowded and the signals are poor. Sometimes a prosign AR is used by a station replying to a CQ. AR means "end of message;" the intent is the same, that WD8AAA is kicking it over to me to transmit.

WD8AAA DE WB2AYA BT TNX FER  
CALL BT UR RST 5NN 599 BT QTH  
QTH IS WILLINGBORO, NJ IMI  
WILLINGBORO, NJ BT NAME IS  
TOM TOM BT HW? AR WD8AAA  
DE WB2AYA K

"WD8AAA from WB2AYA . . . thanks for the call . . . your readability is perfect with a very strong signal and good tone . . . location is Willingboro, New Jersey . . . name is Tom . . . how do you copy? . . . end of message . . . WD8AAA from WB2AYA, go ahead."

The BT is a pause, and IMI (also a question mark) as used here means "repeat." These letters usually are sent together as one continuous character.

In the RST report, some hams will send the letter N in place of the number "9." It just speeds things up.

R WB2AYA DE WD8AAA BT  
FB TOM  
ES TNX FER RPT BT  
UR 56N IN  
CLEVELAND BT  
NAME DICK DICK  
BT RIG SUPER SKYROCKET 3  
RUNNING 1TT WTS BT  
ANT INVERTED VEE BT  
WATSA TOM?  
AR WB2AYA DE WD8AAA K

"All understood, WB2AYA from WD8AAA fine business Tom and thanks for the signal report . . . you are perfectly readable with good signal strength and pure tone in Cleveland, Ohio . . . my name is Dick . . . the rig is

a Super Skyrocket III running 100 watts input power . . . the antenna is an inverted V dipole . . . what do you say, Tom? . . . end of message . . . WB2AYA from WD8AAA, go ahead."

Note that Dick has recognized the fact that I am receiving excellent signals so he has abbreviated the "RST-QTH-name" format. There is only one well-known Cleveland in W8-land. If a W6 says "QTH LA," that has to be Los Angeles



If there seems to be just too many stations near the spot where you are operating, perhaps your receiver needs more selectivity. Some of the older or less expensive receivers can be improved by adding an audio filter to the output. This one, by MFJ, has three degrees of selectivity that will narrow your listening "window" down to a small slice of the band. For more information write to MFJ Enterprises, P. O. Box 494 Mississippi State, Mississippi 39762.

. . . and the same with a host of other larger cities around the country.

Notice the "1TT WTS." Rather than take the time to send 5 dashes for the numeric zero (written with a slash, 0, when copying code to distinguish it from the letter O), it is acceptable to send one longer dash, which sounds like a slow-speed T, for each 0.

The QSO can go in any direction from this point. Often it gets into weather and equipment. When discussing temperature, you may hear "23 C" or "74 F" and that means the temperature given in degrees Celsius and Fahrenheit, respectively.

To get a longer-than-average QSO going, mention your age and what you do for a living. End the transmission by asking a question. You may get a

ragchew started, and you may wind up with a life-long friend.

### Procedural signals

You have already seen some of them: **K** means "go ahead to any station," whereas **KN** says "go ahead to only the station I am in QSO with and all others keep out."

**KN**, therefore, is meaningless at the end of a CQ. You'll often hear **KN** used by stations working DX.

**CQ** is a general call to any station, whereas **CQ DX** used by a stateside station means he or she wants to talk to someone outside the United States or Canada.

**CQ DX** is usually a waste of time for the Novice although you may get lucky in a situation where the band is open but appears to be inactive (everybody is listening!).

Some of the other prosigns are **R**, meaning "all understood and received correctly," and **AR** meaning "end of message"

Don't send **R** and then ask "QTH? NAME?" because if you have to ask for a fill (that's when you missed something) you did *not* get everything and **R** is incorrect.

**AR** is a flag that's sent prior to the two call signs at the end of a transmission, and alerts the receiving station to be ready to respond.

**AS** means *wait* and it should be one of the first prosigns you learn. As soon as you get settled into a QSO, the telephone will ring, the newsboy will bang on the front door to collect his weekly dues, or your wife, child, or girlfriend will ask you a very important question (that could have waited ten or fifteen minutes). It never fails . . .

One prosign is often not understood and you can drag out a QSO by not using it: **BK** means "break" and you should know how to use it. FCC regulations say you have to identify only every ten minutes, and on short exchanges the swapping of call letters is a total waste of time. Don't confuse **BK** with the



abbreviation **BK** for *back*; some operators will send "... BK to U..." instead of **AR**, and this also drags out a QSO.

To give an example of the use of **BK**, let's carry out the QSO, started above, one step further. If I didn't understand the name of WD8AAA's rig, the following exchange might take place:

WB2AYA: WD8AAA DE WB2AYA  
BT QRM BT RIG? BK  
WD8AAA: BK RIG SUPER SKY  
ROCKET 3 BK  
WB2AYA: R TNX BT ALL OK BT  
RIG HR IS ...

Be alert for the use of **BK**. You'll often find me prowling around the 40-meter Novice band, and I'll use **BK**. I can't tell you how many times there's been a long silence on the other end of a QSO because a Novice was waiting for the callsigns. If a **BK** (and not **BK**) gets sent to you, respond with only a **BK** and the answer to the question (or whatever) and conclude with a **BK**. Don't stop to send callsigns again; it is not necessary.

### Q-signals

Q-signals are derived from the early days of the telegraph (that's the end of this history lesson), and you are already familiar with some of the more common ones.

Q-signals can be either in the form of a positive statement or a question, if you tack a question mark on the end. For example, **QTH** means "my location is..." and **QTH?** means "what is your location?" In a QSO, if I have sent my QTH information to you and I get back on the following return transmission **BK QTH?** **BK** I know I need to repeat my location because you didn't get it the first time.

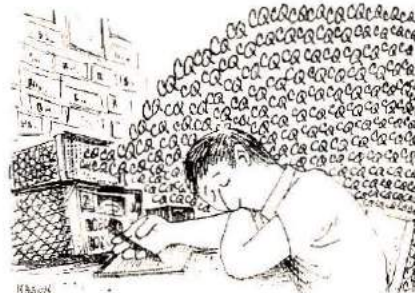
WHAT IS UR QTH? or SRI BT QRM ES QSB BT PSE REPEAT UR QTH? is unnecessary and redundant. Brevity is the order of the day.

Some of the common Q-signals are **QRM** (interference),

**QRN** (static), **QSB** (fading of signals), and **QSL** (verification). While there are many other Q-signals, these are the ones you'll probably encounter in your first QSOs.

You should also not be afraid to send **QRS**, which means "slow down your sending speed." An experienced ham would rather oblige than keep up a rapid pace and then a number of fills.

A comprehensive list of Q-



"Don't overdo the QQ."

signals can be found in any edition of the *Radio Amateur Callbook* magazine which advertises in *Ham Radio Horizons* and *ham radio*, and is available through *ham radio's* Communications Bookstore.

There is one Q-signal which is not listed in any of the many sources for Q-signal lists. **QLF?** means "are you sending with your left foot?" It is intended as a joke for someone sending hard-to-copy, poorly-defined-characters-and-spacing, code, and I would recommend that you know the person well before you ask that question. If you drop the question mark it becomes a statement of fact, so be forewarned.

What is **HI**? That is laughter in morse code. Smile when you say that, pardner ...

There are various ways to end a QSO. I have heard some that are longer than the original QSO. Don't drag it out.

You'll find **CU AGN** (see you again) or **CUL** (see you later), **GM/GA/GE/GN** (good morning/afternoon/evening/night), and **73** or, in a few cases, **88**. The ending signal **73** means "best wishes" and **88** means "love and kisses." Note

these are already plural, so don't add an s to them ... "best wishes" would make an English teacher or an editor cringe.

If you hear **QRT** or **CL** at the end of a QSO, it means that the station is terminating operations and will be closing his station. **QRT** means "stop transmitting" and **CL** means "closing station," and the latter is sent as the last item ... **SK** (signing clear) **WD8AAA DE WB2AYA CL**.

If the station is not terminating operations, and sends **SK WD8AAA DE WB2AYA SK**, you can assume that the station is now finished with the prior conversation, and you can give a **CQ** call.

### DX QSOs

DX QSOs tend to be brief because that single station is usually swamped with stateside stations calling him. If you get through, be prepared for a very abbreviated "RST-QTH-name" transmission followed by a **BK**. Send one **BK** at the start of your transmission and give the data once, sending in the best code possible, and conclude with a **BK**.

If you can, write the QTH and name down, copied from a prior QSO, so that all you have to do is to get the RST. You may get **QSLing** information too, that is, how to get a verification card.

In the DX version of the "RST-QTH-name" QSO, I suggest you stick to using the state as the QTH. In my case, Willingboro is hardly known outside the state, but New Jersey comes through easily. As an alternative, put yourself in promixity to a large city. In my case, I'll occasionally send **NR** (near) **PHILA**, which is adequate for any beam headings.

In some cases, you'll find DX stations are DXpeditions to a remote spot to operate for a short period of hours or days. Again, the exchange is short so don't give a fancy dialogue. Listen for the data on **QSLing**, QTH, and the name of the



operator. Once the exchange has been completed, clear out with a 73, SK and the two calls.

One way to increase your chances of finding a DXpedition is to check around a band like 15 meters prior to the start of one of the big international DX contests for Morse Code operators. Many of the dates will be listed in *Ham Radio Horizons'* "Ham Calendar."

The DXpedition will probably not bother with the slow-speed Novices during the heat of a contest period, but many will venture to the Novice frequencies a few hours or a few days prior to the contest. They hand out some DX QSOs to Novices and shake down their equipment. This is your chance to pick up some rare contacts and countries, so take a look.

#### Where is the DX?

First of all, what is DX? Those are rare and distant stations not normally heard or worked. DX is relative, because someone a couple of hundred miles away running QRP (low power . . . enthusiasts usually set a maximum of 5 watts) could be classified as DX.

Normally, DX denotes stations outside the continental United States and Canada. If you are in the United States and hear a station in the US or Canada calling CQ DX, don't cause QRM by calling him.

You, as a Novice or a Technician, are entitled to operate CW on four different bands. Let's take a look at them.

**80 meters, 3700-3750 kHz:** Daytime activities are pretty slow here and local QSOs up to 100 or 200 miles (160-300km) are possible. Static is a limiting factor, especially during the summer months. Late afternoon and evening are the hours of peak activity, and QRM limits distances to 800 or 1000 miles (1600km). If you can stick around until the early morning, coast-to-coast QSOs are possible on those mornings

that atmospheric static is low.

Set up some means to measure frequencies, and get away from the horrendous pileups on and around 3725 kHz, where too many Novices stay "just to be safe." Keep at least 1 kHz inside the band edges and look around the bottom 10 kHz or the top 10 kHz for some quieter spots. You won't find much foreign



"Look around for a DXpedition."

DX in here, if any, but the hours prior to sunrise can produce a lot of good QSOs from stations in North America.

**40 meters, 7100-7150 kHz:** Often a frustrating band because it is shared with broadcast stations located outside the Western Hemisphere, but it can be most rewarding with QSOs possible 24 hours a day. Use a sharp CW filter and headphones, be patient, and tune carefully.

Daytime QSOs on the band are good up to 1000 miles (1600km), or so, but the broadcast QRM starts building up on the east coast at four hours before sunset and this diminishes your range.

This is another band to check out after midnight and before sunrise. Hawaii to the east coast is a possibility around sunrise. The European broadcasters will have long since faded out at sunrise in Europe, several hours ago, and 40 should be nice and quiet.

Coast-to-coast QSOs are easy after 0300 or 0400 GMT, and you can try a vertical antenna on this band. A quarter-wave vertical is practical in terms of physical size, and its low angle of radiation produces good results across the continent.

Again, there's not much foreign DX here because those hams outside the Western Hemisphere are not allowed to operate in an international broadcasting band, and most hams on our side of the world tend to stay below 7040 kHz to avoid the broadcast QRM. But, DX sometimes does show up after the broadcasters fade out.

**15 meters, 21100-21200 kHz:** Long-range forecasts for the peak of the next sunspot cycle, which we are starting into now, predict that this band will be the mainstay for DXers. The band opens to Europe in the morning, coast to coast during midday to late afternoon, and to Latin America in the afternoon. If the band is in good shape, a few Africans can be heard in the late morning.

Although 15 meters is classified as a daytime-only band, check during the late evenings. Occasional openings do occur providing east coast Novices with an opportunity to work Japan and Australia/New Zealand.

Where's the DX? Well, many Novices tune up on 21150 kHz, the center of the band, and that's a good spot to launch a few CQs if the band appears to be dead.

However, I never found much DX around there. The bottom end seems much more productive. If I had to pick one frequency, it would be 21120 kHz.

The Europeans seem to congregate in the bottom 30 kHz. On the other hand, the amateurs in the Caribbean and in Central America seem to spread out over the bottom 60 kHz.

Watch for some of these Latin American stations working Novices on ssb, giving



instructions and signal reports on USB (upper sideband) and copying the code the Novices are sending.

The key to hunting DX is to listen, listen, listen. More than once I've heard a station call CQ on top of a strong DX station.

**10 meters, 28100-28200 kHz:** This band can have the same characteristics as 15 meters, but the sunspot activity hasn't been enough to keep this band open consistently. If the band is going to open at all, it will probably be during the middle of the day and toward Latin America. There are a few infrequent openings to Europe from the east coast, and coast to coast in the United States but — at least right now — it takes a lot of listening.

If there is skip on CB, a long 10X3 CQ would be in order on 28150 kHz. Monitor CB ssb channels 16 and 35 to 40 to find out where the skip is coming from.

At night 10 meters is a great band for local QSOs. If you and your nearby friends are trying to have a local Novice net on 80 or 40, come on up here. There's lots of room and no QRM. Groundwave is good for up to 30 miles (50km) or so, and signal strengths are excellent.

Now you've gotten through that first QSO and quite a few more to boot. In your first few weeks on the air you probably have a dozen states and Canada to your credit, and maybe VP9 from Bermuda on 40 meters, and some QSL cards are starting to arrive.

Make sure you are keeping your log in 24-hour GMT (Greenwich Mean Time) and start to solicit some sample QSL cards from card printers who advertise in *Ham Radio Horizons* and elsewhere. You are on your way. You are at a point in your ham life that will generate some terrific experiences and feelings that you never find again after upgrading, so enjoy yourself and go to it.

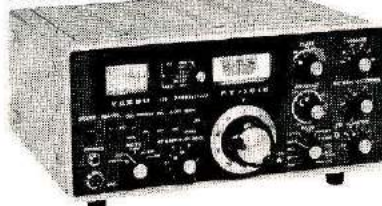
HRH

## AMATEUR PRODUCTS GALORE!

### YAESU

FT-301D all solid-state transceiver; 160-10 meters; AM, CW, SSB, FSK; 200 watts PEP input on SSB, 200 watts DC input on CW, and 50 watts DC input on AM or FSK; features 100-Hz frequency stability, 6-digit LED frequency display; tailored audio response, 0.25  $\mu$  sensitivity, variable selectivity from 0.6 to 12 kHz, requires only 13.5-volts DC power source; matching AC supply and speaker available.

### YAESU



FT-101E TRANSCEIVER

Popular? I guess! Over 200,000 units of this FT-101 series are in service around the world. 10 thru 160M, SSB, CW, AM, built-in WWV reception, solid state, RF speech processor, VOX, AC or DC operation are some of the many reasons for this rig's popularity. We'll be happy to discuss the many fine features of the FT-101E with you today.

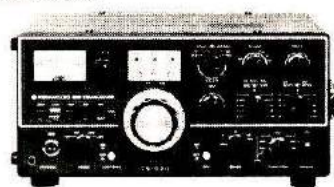
Call or visit with us today for assistance in selecting the Amateur product that is the most likely to meet your operating requirements. **Write for our low price today.**



1207 W. 14 MILE, CLAWSON, MICHIGAN 48017  
313-435-5660



### KENWOOD



TS-520S  
160-10M TRANSCEIVER

Ask around about Kenwood's TS-520. It's in constant use around the globe and has a record of reliability that is universally admired. USB, LSB, CW, operates AC or DC, WWV receiver, RIT, VOX and noise blanker are some features that make the TS-520 a very welcome companion in your shack.

Also, come in and ask about the **NEW** Kenwood TS-820 that has all of the great features found in the TS-520 plus so many truly unique operating advantages that it is the Pacesetter of the industry.

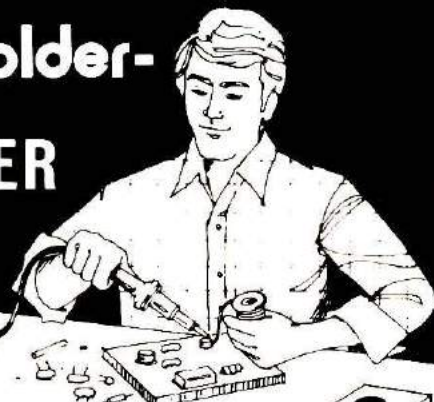
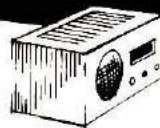
### KENWOOD

TR-7400A two-meter FM transceiver covers 144-148 MHz in 5-kHz steps, selectable simplex and 600-kHz offset; PLL circuitry with unlock protection; LED digital frequency display; CTCSS encode/decode, plus tone-burst; MOSFET with helical resonators, plus 2-pole 10.7-kHz crystal IF filter for superior sensitivity and selectivity, and much more. Write today for details and price.

## RSE HAM SHACK

This is easy-  
anyone can solder-  
WITH  
KESTER SOLDER

KESTER  
SOLDER



Handymen! Hobbyists!  
DO-IT-YOURSELFERS!

Let Kester Solder aid you in your home repairs or hobbies. For that household item that needs repairing — a radio, TV, model train, jewelry, appliances, minor electrical repairs, plumbing, etc. — Save money — repair it yourself. Soldering with Kester is a simple, inexpensive way to permanently join two metals.

When you Solder go "First Class" — use Kester Solder.

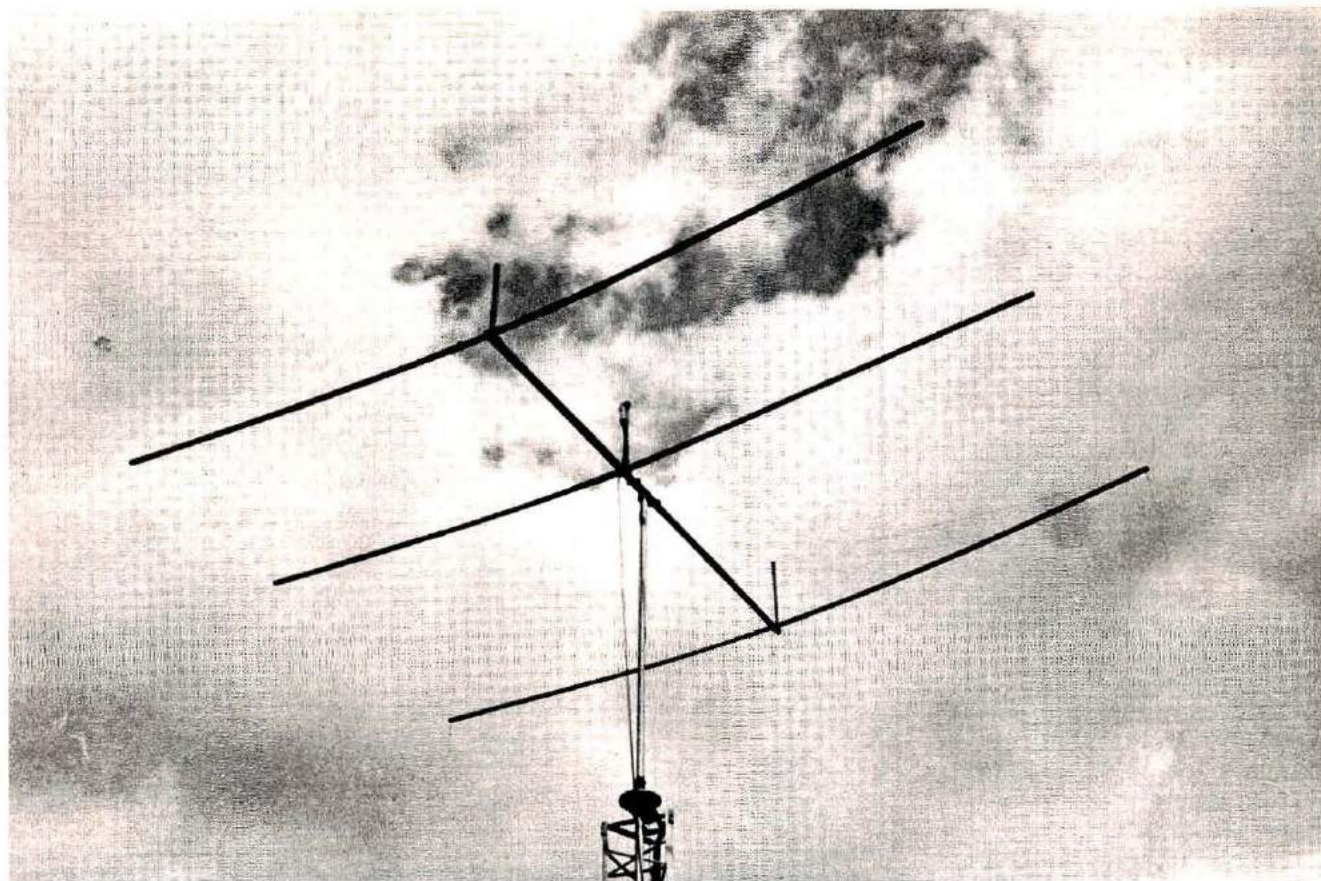
For valuable soldering information send self-addressed stamped envelope to Kester for a FREE Copy of "Soldering Simplified".



KESTER SOLDER

Litton 4201 WRIGHTWOOD AVENUE/CHICAGO, ILLINOIS 60639





# Tri-Band Wire Yagi Antenna

BY JOHN P. TYSKEWICZ, W1HXU

Yagi beam antennas are among the most popular in use by those amateurs who want a directional antenna. They are certainly without equal when it comes to ease of rotation, and most top DXers would not be without one.

The shining aluminum contraptions that adorn the tops of many towers are intriguing, but to many beginners they also represent a large investment in work and money. Yagi beams that used wooden support structures were often seen in the 1940s and later, so why not now. In keeping with the amateur tradition that "there has to be a way," here is how to go about making your very own Yagi — for three bands.

During the design and

construction period of this tribander, a recurring thought concerned the probable bandwidth of a wire-element Yagi. The  $Q$  or bandwidth is determined by the shape factor of the excited element, so standard practice is to use elements constructed from tubing. The larger the element outside diameter, the greater the bandwidth, but at the expense of greater weight. A practical substitute can be several spaced wires per element, preferably fanned outward.

This *conical effect* appears to function in this wire Yagi by virtue of using a common feedline and elements in parallel. When operating on one band, the other two band-elements are not entirely

passive, as evidenced by some residual rf. Also, by making changes to one band-element, the tuning of the other two band-elements is affected. The resulting bandwidth is comparable to my first tribander, an all-aluminum-tubing, full-size Yagi.

Projects generally get underway sooner when started off backward, so Fig. 3 shows the construction details of the spider upon which the success of *das Eindexer* (monoplane) spreader, pylon, and wire, structure depends. Assuming a 2-inch (5cm)-diameter boom, the saddle fitting is made from standard 2-inch (5cm) iron pipe. Two cut-off pieces are parted with a hacksaw, leaving a spare. If necessary, you can squeeze the half shells in a



wise for a perfect fit. Make a curved template from tin-can stock to locate the 4 3/16-inch (4.8mm) diameter holes. The remaining difficult part is to match the pipe shell and spreader angle iron for a right angle joint and complete all welds.

Those in a hurry can omit the handy spreader clamps shown and use a wrapping of friction tape and galvanized iron wire. Most of the fasteners can be of common stove-bolt grade, providing they're protected with a coating of silicone grease (this also applies to flashplated iron wire). The complete driven element is attached to the boom with four no. 10 (M5) sheet-metal screws plus one stainless-steel hose clamp and the stove-bolt hardware used for the reflector and director elements.

Fig. 1 shows the layout dimensions of the driven element. The reflector and director are similar but don't require a connector block; their wires pass through small side holes in the pylons (see Fig. 3).

A complete set of six spreaders can be obtained from one clear piece of 2- by 4-inch (50x100mm) lumber if a thin saw and saw table equipped

with two parallel fence guides are used to keep the lumber from wandering (Fig. 1). The spreaders are used with the 1.1-inch (2.8cm) dimension in a horizontal plane for maximum lateral stiffness. The side corner edges should be beveled 1/8-inch (3mm). Drill all holes except for the inboard side of loading coils, then apply several coats of outdoor grade varnish. Be sure to observe directions on the varnish can for surface preparation and drying time between coats.

The loading coils, Fig. 2, are wound directly around the wood spreaders with no. 14 (1.6mm) plastic insulated "house wire," type TW600V. The winding is started near the drop-wire location. Since the coil form is rectangular, the wire can be formed with some mallet tapping. After obtaining the proper number of turns, wrap this coil end with masking tape to hold the wire, and drill a hole for the lead wire. The lead wire will extend along the top of the spreader to the no. 14 (1.6mm) antenna wire attach point see (Fig. 1).

### Final assembly

Select the driven-element

pair of spreaders (complete with all coils) and fasten them to the spider fitted with the phenolic connector block. Clamp the assembly, with the pylon vertical, to an immovable object. Attach the 20-meter-band antenna wire near its loading coil, draw opposite ends through the connector block, and pull the wires in an equal amount until the spreaders curve upward to the estimated dihedral.

Stretch a bowline string, with a stout rubber band in series, between spreader tips. Adjust the wires for a chord of 10 inches (25.4cm) (Fig. 1). Next, install the 10- and 15-meter-band wires.

All soldered joints to the antenna wires at the spreaders and connector block *must* be located outside the wrapped connection. See soldering detail in Fig. 2.

The drop wires are made from no. 14 (1.6mm) copper-weld wire or hard-drawn brazing rod. Add 3 1/2 inches (9cm) to the dimensions shown in Fig. 1 for the bends. The spreader holes must be small pilot holes. The drop-wires are forced through these holes. See Fig. 2.

The reflector and director

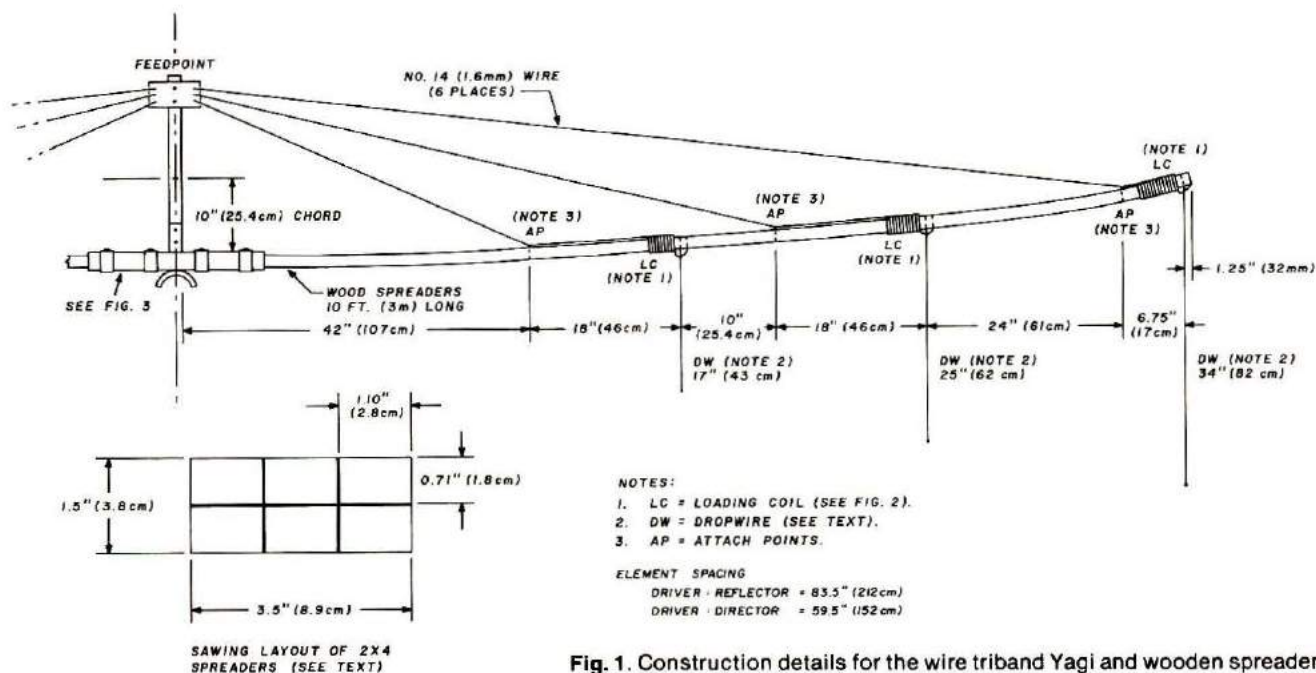


Fig. 1. Construction details for the wire triband Yagi and wooden spreaders.



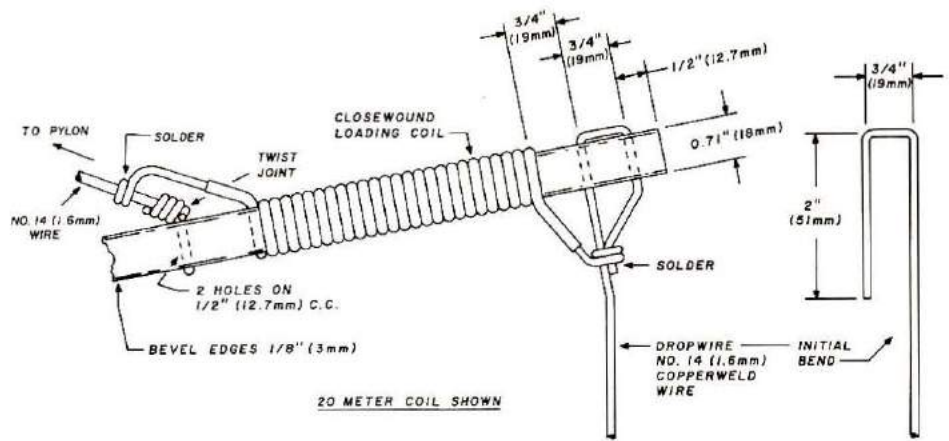
parts are assembled in the same order except for the pylon antenna wire, which is one continuous piece per band and which passes through the pylon side holes (Fig. 3).

The elements can now be attached to the boom and spaced to the dimensions indicated in Fig. 1. Alignment is a bit easier when reflector and director are bolted on first, then the driven element secured with a hose clamp before drilling holes for the sheet-metal screws. The beam is now ready to be mounted on a mast by whatever hardware or method you wish.

### Feed system

The feed system consists of a single length of RG-8/U coaxial cable together with a 1:1 balun that was available and installed on the premise that the balun might do some good.

Since the element spacing varies between being wide on 10 meters and close on 20 meters, so does the driving



	BAND		
	10	15	20
— REFLECTOR	13.5 TURNS	17.5 TURNS	37.5 TURNS
— DRIVER	12.5 TURNS	15.5 TURNS	34.5 TURNS
— DIRECTOR	11.5 TURNS	13.5 TURNS	31.5 TURNS

COILWIRE - NO. 14 (1.6mm) PLASTIC INSULATION, TYPE TW600V

Fig. 2. Construction details for loading coils and drop wire.

impedance. By using a transmatch or tuner and a coax line stretcher, the vswr can be made to look good.\* The line stretcher consists of selected pieces of RG-8/U cable used to change line electrical length when necessary.

The elements can be tuned

by trimming the drop wires, either by folding back the bottom ends 180 degrees or by clipping. The latter, if overdone, will require some patching. Work in 1/2-inch (12.7mm) increments per leg on 10 meters, 3/4 inch (19mm) on 15, and 1 inch (25.4mm) on 20 meters.

### Test and adjustment

The resonant frequency of the elevated antenna was measured with an antenna noise bridge. The drop wires of the driven element were trimmed for the most desirable part of a band, after which the reflector and director drop wires were adjusted to the same dimensions. This procedure may not satisfy those who are free to pursue the tuneup game to ultimate satisfaction.

Looking ahead, the spinoff from this *Eindeker* construction suggests a 40-20-15-meter tribander with a 40-foot (12.2m) span; also a variation of the 20-15-10-meter job could be one without the loading coils, requiring longer spreaders and drop wires. **HRH**

\*The vswr is "good" if it's below 5:1. Too much emphasis is placed on a "low" vswr. If the antenna takes a load, then your transmitter power will radiate. **Editor.**

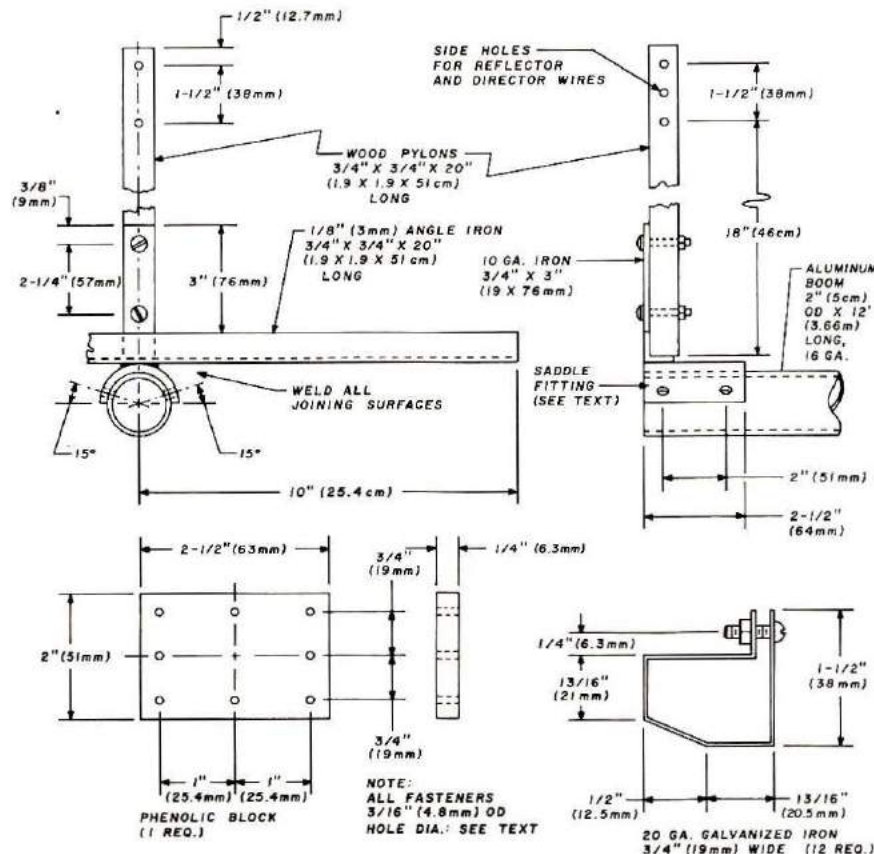


Fig. 3. Construction details for the wood pylons, saddle fitting, and connector block.



# HEATHKIT: The name in Amateur radio...and now computers!



## SB-104A Amateur Transceiver

The world-famous SB-104 with significant improvements. We've increased the sensitivity to  $0.5 \mu\text{V}$  on all bands and included a fully assembled and tested receiver front end circuit board for reduced assembly time. The optional 400 Hz filter is independently selectable for CW operation. We've maintained the features that made it famous too — totally broadbanded, all solid-state, digital frequency readout and more. Make the SB-104A the "heart" of your station. Only \$669.95



## HW-2036 2-Meter Mobile Transceiver

Our value-standard 2-meter rig offers true digital frequency synthesis in 5 kHz steps and a built-in tone encoder to access most repeaters! Also features built-in simplex, + and - 600 kHz offsets, and an aux. position that lets you add your own crystal for any other offset crystal you may want. The HW-2036 has  $0.5 \mu\text{V}$  receiver sensitivity and a transmitter that can operate into an infinite VSWR without damage! Come on up to 2-meters with one of the best mobile rigs you can get. Only \$269.95

# FREE!

## HEATHKIT CATALOG

Nearly 400 kits for you to build! Whatever your interest—hi-fi, television, automotive, marine, home appliances, test gear—it's all in our big new catalog.



Send Today! ▶

Prices are mail order net F.O.B. Benton Harbor, Michigan. Prices and specifications subject to change without notice.



H8  
Computer  
Kit  
\$375

H11  
LSI-11  
Computer  
Kit  
\$1295

H9  
Video  
Terminal  
Kit  
\$530

H10  
Paper Tape  
Reader/Punch  
Kit  
\$350

**New** The personal computer products you've been waiting for.

And the ones to which all others will be compared. Total computing systems for home, hobby, educational and business applications. Powerful, comprehensive software to get you up and running fast. Unequaled documentation and product support services coupled with low Heath prices make the difference.



LA36  
DEC  
Writer II  
Keyboard Printer  
Terminal at Heath's  
SPECIAL LOW PRICE:  
\$1495 Assembled

## New Self-Instruction Course in Microprocessor Operation and Application

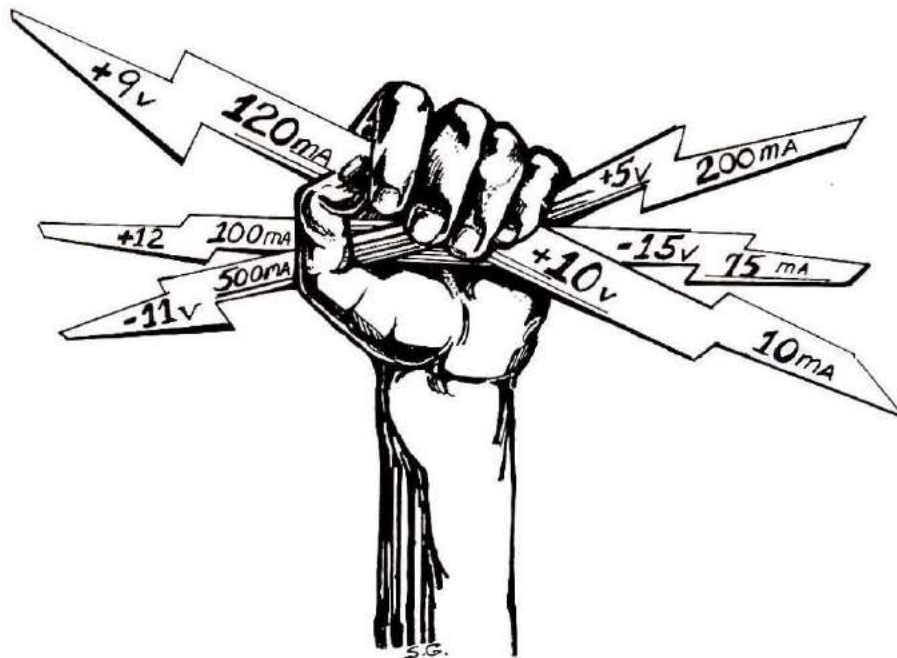
Another addition to Heath's famous Continuing Education Series. Learn microprocessor operation, interfacing and programming. Hardware and software experiments let you get hands-on experience using the ET-3400 Microprocessor Trainer.



HEATH	
Schlumberger	Heath Company, Dept. 348-360 Benton Harbor, Michigan 49022
Please send me my FREE Heathkit Catalog. I am not on your mailing list.	
Name _____	
Address _____	
City _____	State _____ Zip _____
AM-356	



# POWER to the Projects



*A handy power supply for a variety of uses*

BY DOUG BLAKESLEE, W1KLLK

Almost all amateur equipment requires direct-current (dc) power. Some items can be battery powered, but most ham gear uses power obtained from the ac lines. In this article I will review some of the basics of power supplies to acquaint you with the subject and will present construction details for a simple multiple-voltage supply. If you have never attempted a construction project, a power supply is an excellent starter, easy to build, and easy to get working. And the finished product is useful for years in the ham shack and on the workbench.

## Inside the power supply

Home electrical service is usually 120 or 240 volts alternating current (ac). A power supply uses a transformer (two coil windings on a metal core) to isolate the rest of the supply from the ac service and to provide a step up (or step down, as

appropriate) to the required voltage. A power supply that connects directly to the ac line can be very dangerous unless special precautions are taken,<sup>1</sup> so you should always use a transformer. The transformer is chosen to give a desired output voltage and current. For example, if you were going to power a small two-meter fm transceiver which required 12 volts (dc) at 600 milliamperes (mA), a transformer with a 120-volt primary and 12-volt, 1-ampere secondary could be suitable with an appropriate rectifier and filter.

The conversion from ac to dc is accomplished with a rectifier stage. Today, silicon diodes are universally used as power rectifiers. The diode has two terminals, one positive (anode) and one negative (cathode). The action of the diode is very much like that of a switch. When positive voltage is applied to the anode, current will flow through the diode as

if it were a closed switch. However, if negative voltage is applied, a very small reverse current will flow, as with an open switch.

## Rectifier circuits

The three popular rectifier circuits are half-wave, full-wave, and full-wave bridge. The *half-wave* circuit of Fig. 1A uses a single diode. When the ac output from the transformer is at a positive part of the cycle, current flows through the diode to the load. When the transformer output goes negative, current flow stops. Thus, the output from the half-wave rectifier is just half the waveform of the applied ac. A peak occurs once in each cycle, or 60 times a second.

To make more efficient use of the ac power, a *full-wave* circuit is used. In Fig. 1B, I use a center-tapped transformer that has an output voltage twice that required for half-wave rectification. When one output side of the transformer goes positive, the other side goes negative. Thus, when one diode is conducting, the other is not. But, both halves of the ac cycle are used. The rectifier output has two peaks for each input cycle, or 120 per second.

If a transformer has no center tap, full-wave action can still be obtained with a *bridge* circuit of four diodes (Fig. 1C). Here two diodes are attached to each transformer secondary lead, but with opposite polarity of connection, so both the positive and negative swings of the ac voltage will be conducted.

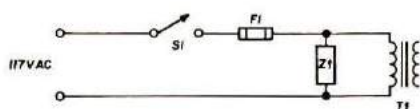
Like a transformer, power diodes are chosen to handle desired voltage and current. The forward-current rating of the diode determines how much current can pass through the unit on a regular (repetitive) basis (called  $I_{REP}$ ). Silicon diodes are very forgiving about very short-duration overload currents because they have surge (called  $I_{SURGE}$ ) current ratings that are much greater



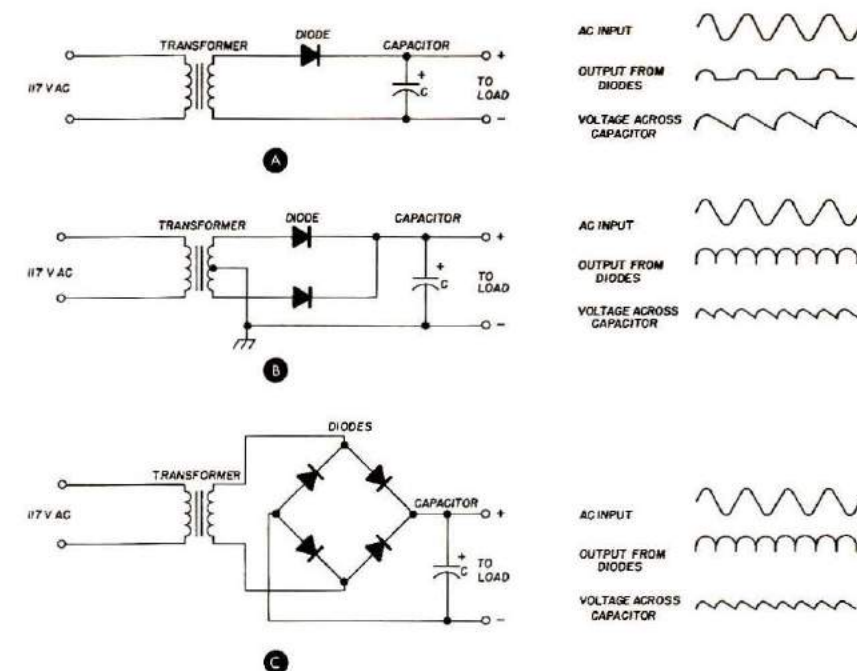
than the average specification. They are far more particular about voltage; diodes are rated for the amount of reverse voltage they can take without failure, called *peak-reverse voltage* or *peak-inverse voltage* (PRV and PIV, respectively). If the PIV rating is exceeded for even a short period of time, the diode will break down and be destroyed. Minimum PIV ratings are 1.4, 2.8, and 1.4 times the transformer secondary voltage for half-wave, full-wave, and full-wave-bridge circuits, respectively. It is good practice to use diodes rated at least twice the minimum PIV. The waveform on home ac service is not clean. Running appliances and abrupt changes in load in a neighborhood can cause voltage transients, high-voltage spikes which ride along the ac line. Nearby lightning strikes can cause transients of up to 2000 V on a 120-V line. For protection, use a PIV rating of 2 or 3 times the minimum requirement. If you live in an area where thunderstorms are prevalent, use a transient suppressor, as shown in Fig. 2.

### Filters and loads

Pulsating dc from the rectifier stage is fed to a filter capacitor. The capacitor charges and discharges with each cycle, alternatively taking in and giving up energy. The action of the capacitor smooths out much of the pulsating dc, but some *ripple* (voltage fluctuation) remains. The larger the capacitance, the lower the ripple for a constant load. Electrolytic capacitors are generally used as filters in power supplies because of



**Fig. 2.** A transient suppressor can be installed after all switches directly across the transformer primary. General Electric calls their units *MOVs* while International Rectifier uses the trade name *Klip-Sets*. For amateur use a unit rated at 120 Vac, 3 or 10 ampere surge is appropriate.



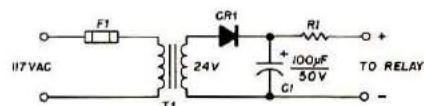
**Fig. 1.** Simplified circuit diagrams and waveforms for **A** half-wave, **B** full-wave, **C** full-wave-bridge rectifiers.

their relatively small size and high storage capability.

The load for a power supply is the external device which is using the power. A load is usually represented as a resistance because it will draw constant current in relation to the applied voltage. The value of this equivalent resistance can be determined using Ohm's law; the resistance is equal to the voltage (V) supplied, divided by the current (I) in amperes (A). The current drawn by ham equipment is seldom, if ever, constant. A change of one degree in temperature will cause a change in the current drawn by every transistor in a radio set.

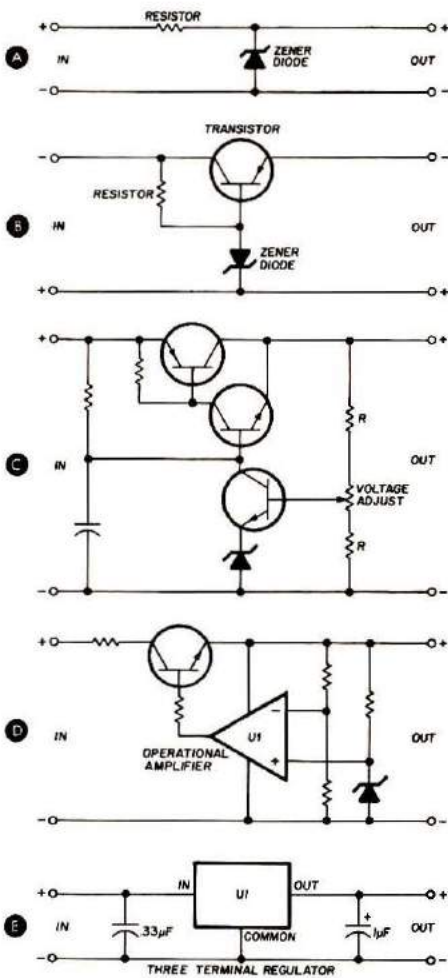
Two important specifications for a power supply are line and load regulation. Line regulation refers to what happens to the output voltage when the ac-line voltage varies. The load-regulation specification indicates how a power supply will perform when the load changes, drawing more or less current. Half-wave supplies are the poorest when it comes to load regulation, so they are used in applications where load regulation is not important or where poor regulation is desirable.

A power source for an antenna changeover relay is an example of an application for a half-wave supply. In CW or ssb operation using automatic relay control, the antenna relay must close as fast as possible to prevent sparking of the contacts caused by energy from the transmitter reaching the contacts before they have closed. In the circuit of Fig. 3 a half-wave power supply has been designed to produce a no-load output of three times the voltage required by the antenna relay. The relay coil initially opposes the build-up of current (a property called inductive reactance), which tends to slow down the relay closing. Using a high voltage allows the reactance effect to be overcome more quickly, allowing the relay contacts to snap closed.



**Fig. 3.** Schematic diagram of the relay power supply. CR1 is a 400 volt PIV diode (RS 276-1103). C1 is an electrolytic capacitor (RS 272-1044). F1 is a 1-Ampere fuse, and T1 is a 24-volt, 300-mA transformer with 117-V primary (RS 273-1386). R1 is a power resistor (see text).





**Fig. 4.** Zener-diode regulator for positive voltage, **A**. Zener-diode regulator with power booster for negative voltage, **B**. Positive-voltage regulator with improved load regulation and adjustable output, **C**. Positive fixed-voltage regulator using an operational amplifier such as the 741, **D**. Three-terminal-regulator circuit for fixed output voltage. Use RS 276-1770 for 5 volts, RS 276-1771 for 12 volts, or RS 276-1772 for 15 volts.

As the current load of the relay is drawn from the half-wave supply, its output voltage drops. The current to the energized relay is limited by a resistor to the value specified by the relay manufacturer. The same technique is used in modern power supplies for *Teletype* machines so the electromagnets which operate the printer have snap action.

Power supplies usually include some form of regulator to provide improved line and load regulation. A supply can be designed to provide constant voltage or constant

current. The half-wave relay supply described above can be considered as a simplified constant-current supply except for the start pulse which kicks the relay closed. Most amateur equipment requires constant-voltage supplies. If the voltage varies, oscillators shift frequency, amplifiers can distort signals, and power output can be reduced. Some transmitter and receiver stages are more susceptible to voltage changes than others. Frequency-determining oscillators often have a regulator of their own (even when a power supply with good regulation is used) to make sure that the supply voltage stays put.

The simplest form of regulator is the Zener diode. The Zener is a silicon diode operated in the breakdown region. When discussing power diodes earlier, I mentioned that exceeding the PIV rating of a device could cause instant destruction. This is because very high current would flow. If the current can be limited to a small value by using a resistor,

the diode can perform as a regulator. Zener diodes are manufactured in such a way that the breakdown current increases very rapidly once a specific voltage (the Zener point) is reached. Thus, inserting a Zener diode and its associated resistor between the supply and the load (**Fig. 4A**) improves voltage regulation because current changes caused by the load add to or subtract from the current flowing through the diode. The voltage remains essentially constant.

Zener diodes are good regulators in low-current applications where the current through the unit produces 1 watt or less of heat (determined by multiplying the current through the diode by the voltage across it). The dynamic performance of a Zener is only fair; they help eliminate some ripple, but not as much as more sophisticated regulator circuits.

If higher current is needed, a transistor booster (**Fig. 4B**) can be added to a Zener-diode circuit. The gain of the



This handy supply will provide three different and independent regulated voltages for your experimental projects. The 5-volt supply can be changed to 9 volts with an internal adjustment. The two large knobs are for adjusting the plus and minus supplies to a maximum of 15 volts. One supply has its negative terminal grounded; the other is positive ground. This arrangement is most useful when working with modern integrated circuits that require a dual voltage.



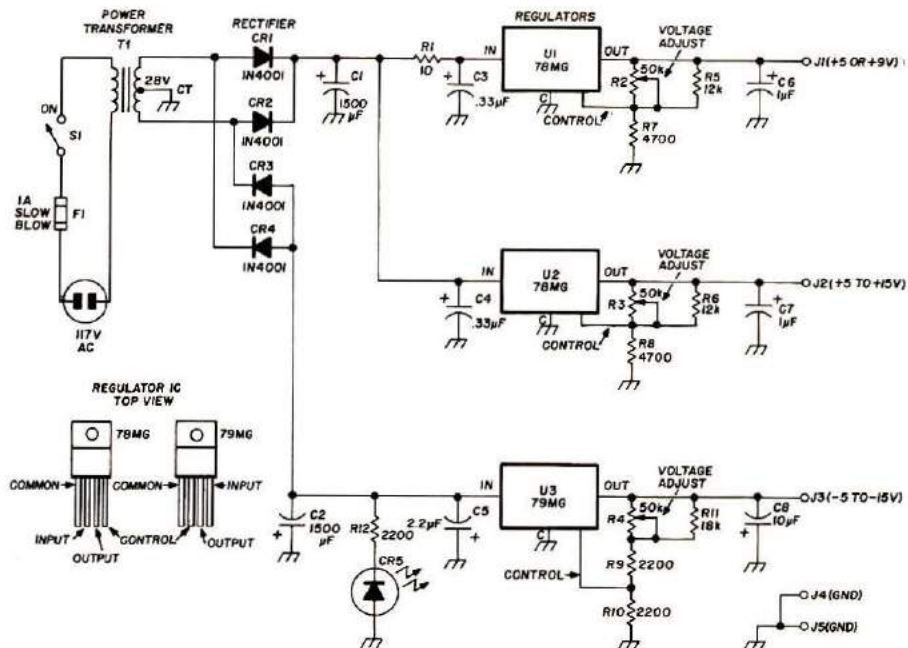
transistor aids in the regulation process. An even more useful circuit can be produced by adding a current-booster transistor, Q2 in Fig. 4C. The gain of the booster improves regulation and ripple rejection. Q3 and a voltage divider have been added to the Zener-diode circuit so that the output voltage can be varied.

In general, the higher the gain of the control elements, the better the performance of a regulator. A high-gain operational amplifier can be used to sense the voltage difference between a Zener-diode reference voltage and the output voltage (Fig. 4D). A discussion of operational amplifiers and how they work appeared recently in *Ham Radio Horizons*.<sup>2</sup>

By using integrated circuit (IC) technology rather than individual components, a complete regulator system including a Zener reference diode, op-amp, and control transistors can be built in a single package. Modern IC regulators include overload-protection circuits. Each power regulator has a maximum-power and a maximum-current specification. The IC regulator will automatically shut down if the unit gets too hot from excessive power or if the output current is too high.

Fairchild has been a pioneer in the field of integrated regulators. Their general-purpose, low-power, adjustable regulator, the  $\mu$ A723, has become an industry standard. In 1970 they introduced the 78-series of three-terminal regulators which have fixed output voltages and current up to 1 ampere. Later, adjustable versions were produced with a control terminal added. A typical circuit for a three-terminal regulator is given in Fig. 4E.

Today, the IC manufacturers are taking dead aim at the Zener-diode market. They intend to produce integrated regulators with 50-mA current ratings which will replace the diodes, because the IC has far



- |         |   |        |  |
|---------|---|--------|--|
| C1, C2  | Electrolytic, 1000 to 3000 $\mu$ F, 35 V (RS 272-1020 or BA 18A 1506-6) | R3,R4  | Panel mount, linear taper (RS 271-1716)  |
| C3-C8   | Tantalum (RS 272-1400 series)   | R5-R11 | 1/2 or 1/4 watt, composition (RS 271-1300 or 271-000 series)                           |
| CR1-CR4 | Silicon, 400 PIV, 1 A (RS 276-1103)                                     | S1     | Spst toggle (RS 275-324)   |
| CR5     | Light-emitting diode (RS 276-041)                                       | T1     | 24 or 28 V, center tapped, 1 A (BA 18A-1489-4, BA 12P-83476, L 33P84872, RS 273-1512)  |
| F1      | Slow blow, 1 A (RS 270-1283)  | U1,U2  | Voltage regulator IC, Fairchild 78MG (G.R. Whitehouse) Use heat-sink shown in Fig. 6.  |
| J1-J5   | Five-way binding posts (RS 274-661 or L 99-P-63943)                     | U3     | Voltage regulator IC, Fairchild 79 MG (G.R. Whitehouse) Use heat-sink shown in Fig. 6. |
| R1      | 2-watts minimum, 10 watts preferred (RS 271-080 or 271-132)             |        |  |
| R2      | PC mount, linear taper (RS 271-219)                                     |        |  |

Fig. 5. Circuit diagram of the triple-output power supply. Letters at beginning of part numbers indicate the source: RS — Radio Shack; L — Lafayette; BA — Burstein-Applebee. See Appendix for addresses.

better dynamic performance and ripple rejection, plus overload protection. Of course, the new ICs must have a cost similar to Zener diodes; this will require efficient production techniques that are now being developed.

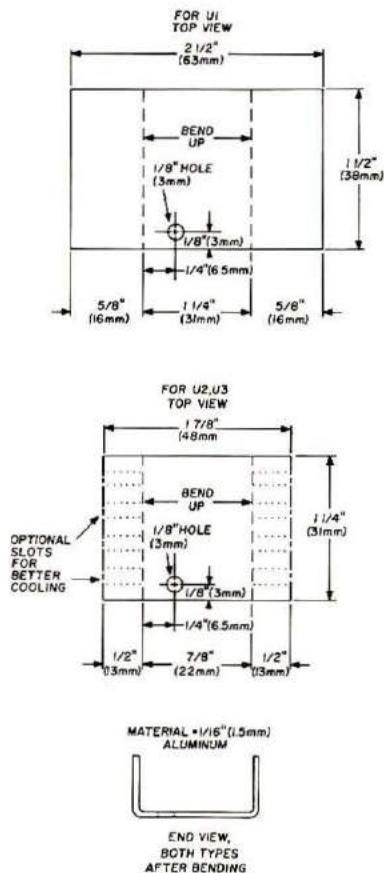
### Let's build one

It's time to get down to a practical power supply which can be both fun to build and handy to have around. The circuit, shown in Fig. 5, uses three adjustable regulators. One output is intended to be

fixed at 5 volts as a TTL (transistor-transistor-logic) supply or at 9 volts as a transistor-radio battery replacement. The two other outputs provide plus and minus 5 to 15 volts for op-amp circuits and for powering experiments.

Ac power is fed to transformer T1 through a fuse and on/off switch. The fuse is a vital protection element, and no amateur power supply should be built without one. The transformer, T1, should give from 24 to 36 volts at 800 mA to 2 A, and have a center tap.





**Fig. 6.** Heat sinks for the regulator ICs can be made from 1/16-inch (1.5mm) aluminum sheet. Drill the holes before bending, and if you choose to cut the extra slots in the heat sink for U2 and U3, do that before bending. Paint the metal a flat black for increased radiation cooling. Use a small amount of thermal conductive grease between the metal tab on the IC and the heat sink. Be sure to turn U3 around (backwards from U2) before fastening it to the sink.

Two full-wave rectifiers are used; CR1/CR2 produce a positive voltage output, and CR3/CR4 provide negative potential. The full-wave rectifier circuits were chosen because they can produce negative and positive voltages simultaneously from one transformer. C1 and C2 are filter capacitors. Because they are electrolytics, it is necessary to observe the polarity of connection as indicated by the plus signs on the schematic diagram.

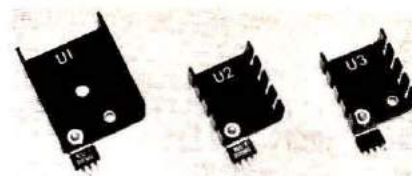
The input to each regulator IC is bypassed by a capacitor to reduce any tendency of the regulator to oscillate and to eliminate the effects of lead length between the filter

capacitor and the IC. An output capacitor is used to improve transient response. A voltage divider across the output provides a control current to the regulator, which sets the output voltage. The ratio of fixed to variable resistance sets the output-voltage range according to the formula given in the *Appendix*.

The 5-to-15-volt regulators have been designed for an output current of 150 mA, each, while the fixed-output supply has a capability of 5, 9, or 12 volts at 500 mA. The regulators alone do not have the capability to dissipate the heat which they will generate, so external heatsinks (large metal structures which radiate heat) are required. A resistor, R1, has been added to reduce the input voltage to regulator U1, thus reducing the size of the needed heatsink. A light-emitting diode, CR5, has been included as a pilot lamp.

### Construction

Most of the circuit is assembled on an etched circuit board. The board may be purchased from the source listed in the *Appendix*, or it may be made at home

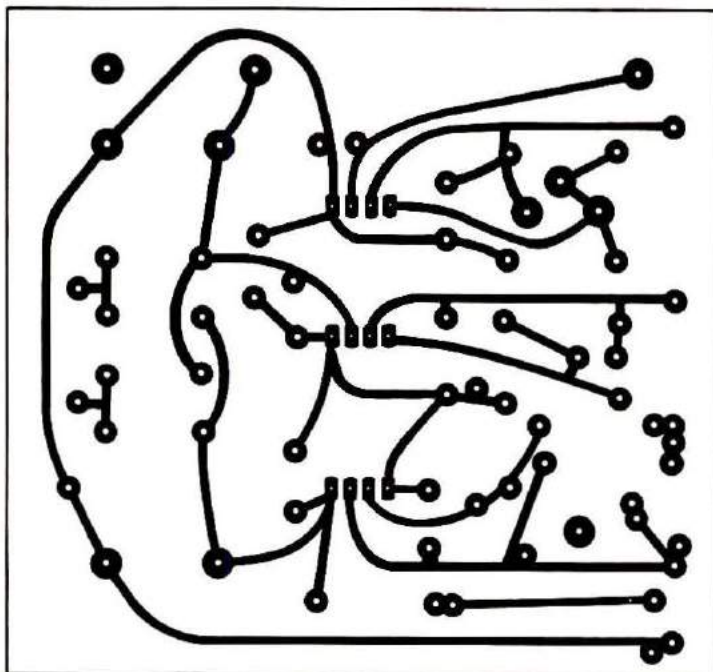


Here are the voltage-regulator ICs mounted on their heatsinks. Note that U3 is mounted backwards compared to the other two — the printing is on the side away from the fins. The layout of the power supply circuit board and heatsink assembly is critical in order to prevent errors in IC position.

following the pattern of **Fig. 7**. Be sure the foil leads are shiny before starting assembly; if not, touch up the board with fine steel wool.

Assemble the parts a few at a time, following the layout diagram of **Fig. 8**, and bend the leads slightly to hold the components in place. Then, touch a soldering iron to the lead and foil pad for a second and add a dab of rosin-core solder. Apply heat until the solder flows around the joint. A good solder joint will appear bright and shiny. A dull or mounded appearance indicates that insufficient heat was applied.

The integrated circuits should be mounted last. A



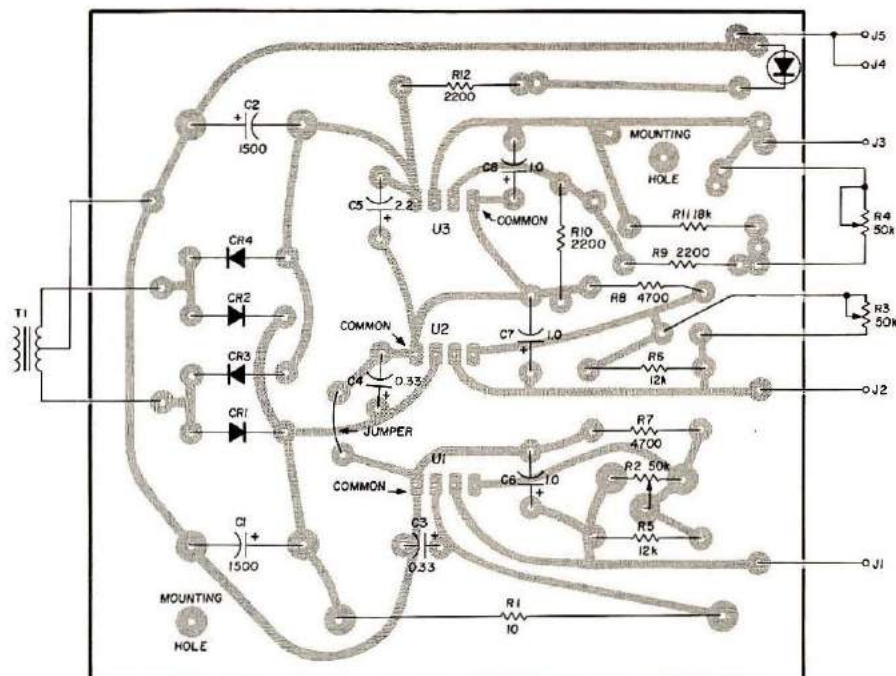
**Fig. 7.** Pattern for the etched circuit board. A finished board is available from Whitehouse, see *Appendix*. A parts-placement guide is given in **Fig. 8**.



heatsink is needed for each IC. The general dimensions are given in Fig. 6. If you make your own, use 1/16-inch (1.5mm) thick aluminum stock. Bend the aluminum into a U-shape. Then paint the heatsink with flat-black spray paint to improve radiation efficiency. Apply a thin film of heat-conducting compound (RS 276-1372) to the top of the IC, then bolt the heatsink in place. Mount the assembly on the PC board and solder the IC leads in place. Be sure to check the position of the IC before installation. Note that the two positive-voltage regulators face toward R1 while the negative unit faces the opposite direction. (The tab is positioned to come up at the rear of the IC.) If a regulator is installed with the pin connections reversed, it will probably be destroyed when power is applied.

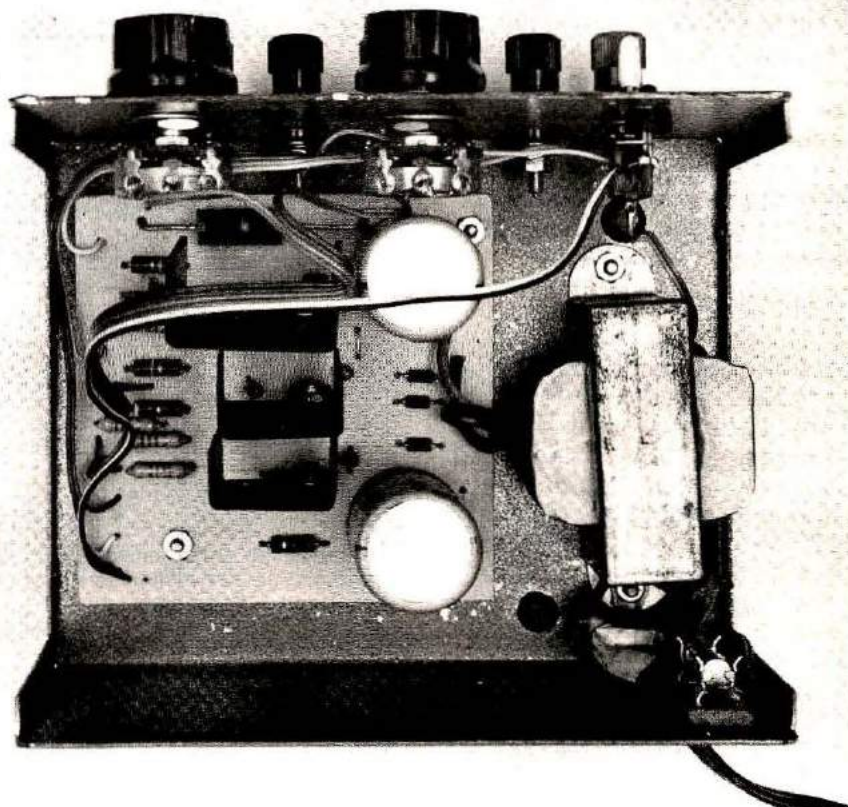
Next, do the metal work on the cabinet. The parts placement is not critical. I used a 5 3/4 x 3 1/2 x 5-inch (15x9x13cm) cabinet (BA 5A3076-2) but any case of similar size (Radio Shack 270-261 or Lafayette 12P83746) will do. The cabinet can be given several coats of spray paint, if desired, in your favorite color. Then, mount the transformer and panel components. Wire the circuit board to the transformer and controls. Use sufficiently long leads so that the board can be removed a short distance from the case for troubleshooting.

When the wiring is complete, connect an ohmmeter across C1 and then C2. As the capacitor charges from the ohmmeter battery, the meter will indicate a low resistance momentarily and then should rise to over 10,000 ohms. Observe meter lead polarity when making the check. If a low resistance reading occurs, there is probably a short circuit or a defective component which must be corrected. If the unit passes the ohmmeter check, mount the circuit board, then plug in the power cord, switch

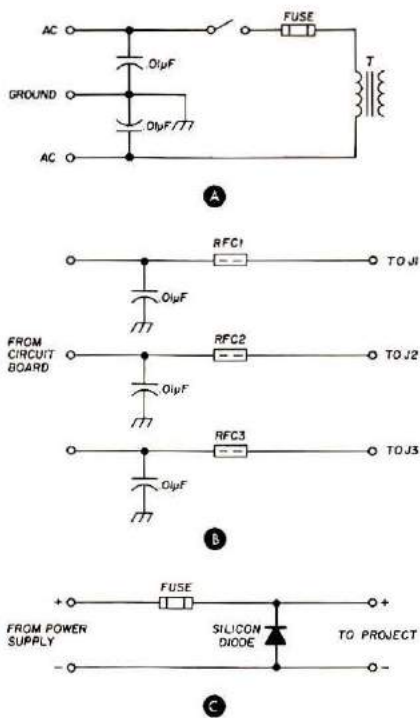


**Fig. 8.** Component placement on the etched circuit board. Note that the location of R10 is not the same here as in the photograph of the completed supply. It was sandwiched in between R9 and R11 on the prototype. Follow the placement shown here when you assemble your unit.

The printed-circuit board is mounted on metal spacers, located under the hex nuts visible in this top view. Note the position of the heatsink fins; if you followed the layout given, it is impossible to plug the regulator ICs in backwards. Just be sure that U3 is the one nearest the back panel. The 117-volt line fuse is located inside the rear of the cabinet.







**Fig. 9.** Circuit diagrams of input rf protection, **A**; output rf suppression for a power supply, **B**; and polarity protection, **C**. All capacitors are disk ceramic (RS 272-120 series). RFCs are jumbo ferrite beads (available from Whitehouse, see *Appendix*).

S1 to ON, and measure the output from U1. It should be in the range of 5 to 12 volts. Adjust R2 for the fixed output voltage you want. Next, check U2 and U3 which should provide variable voltages from approximately 5 to 15 volts. If all three regulators are working properly, assemble the case. Mark the panel controls with press-on or *Dymo* labels.

### Applications

The power supply is useful to power projects that would otherwise use 9-volt transistor radio batteries. For example, the audio generator described recently in *Ham Radio Horizons*<sup>3</sup> would be powered by U2 set for 15 volts. The *Ham Radio Horizons* wavemeter would use the outputs of U2 and U3, both set for 9 volts.<sup>2</sup> When powering digital logic circuits, 5 volts from U1 for example, use a short connecting lead of No. 22 (0.6mm) or larger diameter wire. The resistance of small-

diameter wire will cause the voltage to drop when current of several hundred milliamperes is drawn. Include a 0.1 μF bypass capacitor for each two or three logic ICs; high-speed logic circuits produce noise spikes on the power lines which can cause erratic operation if bypass capacitors are not located close to the logic devices. Operational amplifiers also have a tendency to oscillate unless 0.1 μF bypass capacitors are included close to each IC.

Radio-frequency energy can get into the power supply when you experiment with rf circuits. The rf can be rectified by components within the regulator ICs and cause erratic operation. If you have rf problems, add 0.01-μF bypass capacitors from either side of the ac line to ground, as shown in **Fig. 9A**.

Be sure to use a three-wire power cord with this modification, because the capacitors will cause an ungrounded chassis to be a shock hazard. Add jumbo ferrite beads on the leads from the board to J1, J2 and J3 (see

**Fig. 9B**). Also, add 0.01-μF capacitors from these three leads to ground.

One sure way to damage a project is to apply voltage of the wrong polarity. A simple polarity-protection circuit consists of a fuse and a diode, **Fig. 9C**. If the voltage applied is in the correct polarity, nothing happens. If the polarity is reversed, the diode will look like a short, drawing enough current to blow the fuse. With the power supply just described, the fuse can be omitted, because the shutdown circuit in the IC regulator will work when the diode draws heavy current. But, don't leave out the diode!

### References

1. James H. Gray, W2EUQ, "Your Station From the Ground Up," *Ham Radio Horizons*, April, 1977, page 28.
2. Douglas A. Blakeslee, W1KLLK, "Is It Working Properly?" *Ham Radio Horizons*, June, 1977, page 52.
3. Douglas A. Blakeslee, W1KLLK, "Making Waves — Electronically," *Ham Radio Horizons*, March, 1977, page 38. **HRH**

### Appendix

The output voltage of the 78MG regulator is determined by the value of resistance from the output terminal to the control terminal, R1, plus the resistance from control terminal to ground or common, R2, divided by R2 and multiplied by the control-terminal voltage (5 volts). Thus:

$$\text{Output voltage} = \frac{R1 + R2}{R2} \times 5$$

The same formula is used for the 79-MG negative regulator except that the control terminal voltage is 2.23 volts.

$$\text{Output voltage} = \frac{R1 + R2}{R2} \times 2.23$$

In the design of the regulator circuits for **Fig. 5** parallel resistances have been employed. The resultant value of two resistors in parallel can be calculated from the formula:

$$\text{Total resistance} = \frac{RA \times RB}{RA + RB}$$

For example, the value of R2 and R5 used in parallel at the output of U1

produces a calculated value of 9677 ohms, if R2 is at maximum resistance. Thus, using this value for R1 in the 78-MG formula, the maximum possible output is 15.3 volts. If R2 is set to zero, the formula shows that the output will be 5 volts.

A knowledge of mathematics is useful in circuit design. With the introduction of the inexpensive four-function calculator anyone can do calculations useful for simple projects by just depressing the appropriate buttons.

Sources of components used in this article are: (RS) Radio Shack — local stores only; (L) Lafayette — local stores or mail order from Lafayette Radio Electronics, 111 Jericho Turnpike, Syosset, New York 11791; (BA) Burstein-Applebee, 3199 Mercier, Kansas City, Missouri 64111.

G. R. Whitehouse, 15 Newbury Drive, Amherst, New Hampshire 03031, offers a kit that includes the Fairchild 78MG, and 79MG regulator ICs, the printed circuit board, and jumbo ferrite beads for \$14. The PC board alone is available for \$4.00



# the super-compact ALDA 103

only 3¼" high x 9" wide x 12½" deep • less than 8¼ pounds

ALDA 103, the trim little powerhouse with incredible performance for the price! ALDA 103 provides a full 250 watts PEP input for SSB operation, and 250 watts DC input for CW. And when it comes to performance, ALDA 103 is the hottest little transceiver going — all solid state, totally broadbanded and super-stable VFO.

Ideal first transceiver for brand new novices! You'll want a full-capability CW/USB/LSB unit with all the power and performance you can use. ALDA 103 gives you 250 watts DC input for CW, the maximum allowable power for your novice license. When you upgrade to technician, you've got 3 bands for CW operation. And with

your general license, just plug in your mic and use the ALDA 103's full 250 watts PEP on SSB!

Perfect second or mobile unit for seasoned hams! If you're looking for a super-sharp, compact unit to use in your car or boat, ALDA 103 will live up to your expectations. Absolute worst case sensitivity 0.5  $\mu$ V for 10 dB S+N/N — a must for mobile operation. Receiver audio output of 3 watts minimum — another must. Also, very low receiver power drain of only 5.5 watts — that's 0.4 ma at nominal 13.8 VDC including power for dial and meter lamps!

Totally solid state SSB Transceiver • 80 through 20 meters • 250 watts



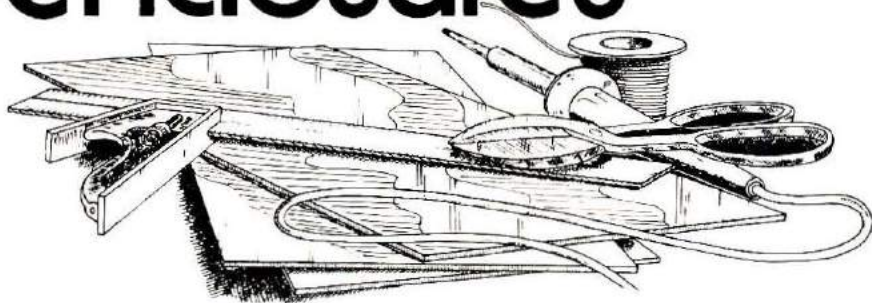
ALD Industries, Inc.  
215 Via El Centro  
Oceanside, CA 92054  
(714) 433-6123

# \$495

including microphone and  
mobile mount, too.



# build your own enclosures



*Use simple tools and save bucks constructing your favorite projects*

BY BILL ROTH, WA2PVV

As a radio amateur I'm interested in many aspects of the hobby, but my main interest is in construction. After constructing a number of projects ranging from a keyer to a solid-state 2-meter repeater, I found that a good percentage of my cost was spent in packaging my projects. Well now, it's not the true amateur spirit to run out and purchase an enclosure that might represent 50 per cent of the total cost of a project.

I decided I couldn't afford the \$25 that a local supply house wanted for an enclosure for my latest project. Then I had an idea. Why not build my own? Now that's more like the true dyed-in-the-wool amateur spirit, isn't it? Then I had to decide what to use for materials — wood, nails, glue? No, I wasn't building a house! Aluminum, pop rivets, sheet-metal screws? No, I tried that before and what a mess! For this project (a frequency counter) I wanted something strong, rf tight, and nice to look at. After seeing some of the smaller projects that a friend, K2CBA, had made using double-sided PC board, I decided to go that route.

As you'll see, using my construction methods, you can

end up with a very strong rf-tight, good-looking enclosure. And if you're lucky enough to have a surplus house nearby, the cost for an 8 x 12 x 4-inch (204x306x102mm) box may be as low as \$2.00.

## Let's build a box

Well, let's construct the enclosure. You'll need a pair of sharp tin snips, an electric drill, brass nuts and bolts, solder, and a soldering iron. Lay the pieces out on your sheet (or sheets) of PC board so that you get the most area with the least amount of waste. Now carefully cut each section of your enclosure, noting that the top and bottom pieces and their supports will be somewhat smaller than the side sections (Fig. 1). How much smaller will depend on the thickness of the PC board and how carefully you

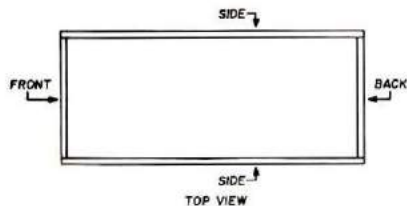


Fig. 1. Looking down on the enclosures, showing how the side, front, and back panels go together. It's important that everything be square. Use a carpenter's square to true up sides before soldering.

place the sections when you solder.

Now that you've cut out all the sections, get the soldering iron hot and let's get to work. Solder the front to one of the sides. Note that the front and back should be placed *inside* the two side sections. For now, just tack them in two or three places. Check to make sure you have a 90-degree angle between front and side, then tack-solder the back into place. Now tack-solder the other side section. You should have something looking like the sketch of Fig. 1. Put the cover or bottom in place and solder the two support sections to the inside of the side sections making sure that the cover (top or bottom) is flush with the sides of the box. See Fig. 2. If you want to remove both the top and the bottom of your enclosure, do the same thing to the other cover. Now, with the cover in place, drill holes through both the cover and its supports as in Fig. 2.

## Additional hints

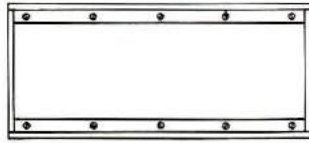
Use a *sharp* drill and don't push down too hard, because things aren't very strong yet. Use a drill that has plenty of clearance for the bolts you are going to use. I recommend 4-40 (M3) or 6-32 (M3.5) machine screws. When all screws are in place and tight, solder the nuts to the cover supports. Make sure you don't let the solder flow into the bolt threads. If this should happen, just heat the nut, remove the bolt, and replace them with a new nut and bolt. Again, if you want the other cover removable, repeat this procedure.

Well, we're almost finished. Now the only thing to do is to flow solder around all the joints and mount your project in your enclosure. Some hints for making your enclosure attractive might be to polish and/or lacquer it, or to cover it with wood grain contact paper.

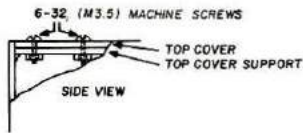
A trick I picked up from an old gunsmith might be of some



interest. By using a pencil with an eraser chucked into an electric drill and some fine value-lapping compound, you can create a nice *damascene* effect. Carefully apply the drill and pencil eraser to the metal surface, one spot at a time. Use



TOP VIEW



SIDE VIEW

Fig. 2. Top and side views of the enclosure showing how to mount retaining hardware. Measure spacing between screws carefully and mark their place before you drill holes. Use a centerpunch to locate holes, then apply the drill. Remove burrs from the holes before adding the mounting hardware. You can use a countersink to make screw heads flush with the top surface for a professional touch.

the lapping compound liberally. Let the spots created by the eraser overlap slightly. This finish was popular on radio equipment during the 1920s and still looks good today on certain types of equipment. The choice is yours, of course. HRH



"Gee, Dad, your license is almost two years older than I am."



# hallicrafters IS BACK — BIGGER and BETTER THAN EVER — and "HAM" BUERGER HAS IT!



**H2M-500**  
Frequency synthesized 800-channel (5 kHz steps) 144-148 MHz FM Mobile Transceiver with PLL digital frequency readout, 1W or 25W output, 13.8 VDC and repeater capability.

**H2M-1000**  
Frequency synthesized 800-channel (5 kHz steps) all-mode CW/AM/FM/SSB 144-148 MHz Transceiver with PLL digital frequency readout, 12 watts output, 117 VAC, 13.8 VDC and VXO, SSB, VOX noise blanker and repeater offset.

**H2M-1000.....\$749<sup>00</sup>**

**H2M-500.....\$389<sup>00</sup>**

Call or write TODAY for our very best deal on: Antenna Specialists, Astatic, Drake, Hallicrafters, Hy-Gain, Mosley, Regency, Rohn, Telex, Ten-Tec, and Wilson. REMEMBER: We pay shipping charges on all prepaid orders!

## "HAM" BUERGER, INC.

ELECTRONIC EQUIPMENT DISTRIBUTOR

WA3ZID-Bob

WB3BPJ-Bob

WB3GXP-Dave

WB3HOF-Jeff

68 NORTH YORK RD.

WILLOW GROVE, PA

19090

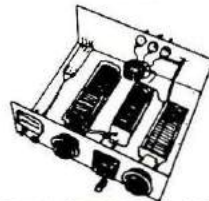
(215) 659-5900



# G.R. WHITEHOUSE & CO.

15 Newbury Drive, Amherst, N. H. 03031

## TRANSMATCH PARTS



PACKAGE  
DEAL \$129.95

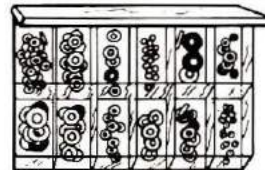
LOOK AT THESE PRICES, LOWEST YET:

154-10 Single section 350 pf. transmitting capacitor, 154-507 Dual-section 192 pf. section transmitting capacitor, 229-203 Roller Inductor 28  $\mu$ h by Mulltronics, 3902-1 Turns Counter by Barker & Williamson.

SEPARATELY PRICED AT \$163.80 NOW \$129.95

WE ALSO STOCK THE OTHER TRANSMATCH PARTS.

## POPULAR TOROID ASSORTMENT



We Stock a Complete Line of Powdered Iron and Ferrite Products.

CONVENIENCE AND LOWER COST \$15.50 Value for \$9.95

INCLUDES: 2 pcs. each, T25-2, T25-6, T37-2, T37-6, T37-10, T37-12, T50-10, T50-12, T68-10, T80-2, T80-6, T94-2. 3 pcs. each, T50-2, T50-3, T50-6, T68-2, T68-3, T68-6

AND CONVENIENT STORAGE BOX AND SPEC SHEETS

TRANSMATCH BALUN SPECIAL 3 T200-2 cores plus 20' #14 Teflon Covered Wire SAVE \$3.45 TBS Kit.....\$9.75

## FERRITE BEAD ASSORTMENT

Includes convenient plastic storage box and one dozen each of FB43-101, FB43-801, FB64-101, FB64-801, FB73-101 and FB73-801 plus new spec sheets. Value \$7.50 for \$6.95

Add \$2.00 to each order for shipping and handling. Prices subject to change.



# DenTron Radios... Built by Americans for the whole world.

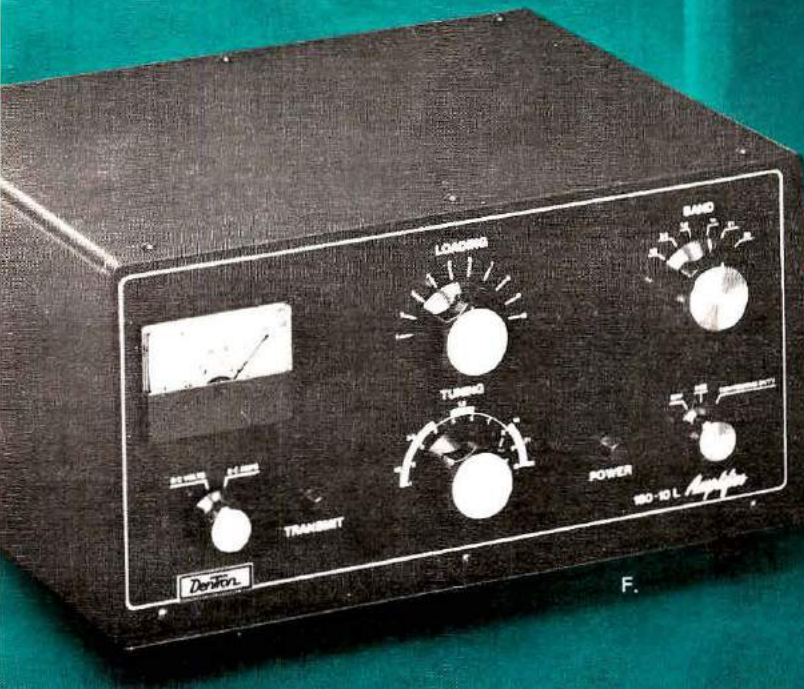
One of the greatest pleasures ham radio brings is contact with distant lands. What other organization can boast of daily communication among its members throughout the world?

It's a great hobby and we want to make it more fun for you!

DenTron antenna tuners do just that. Our Super Tuners are the only tuners on the market capable of matching everything between 160 and 10 meters, plus handling 1-3 KW PEP. ©



G.



F.



H.

*Professional hams depend on*



**A. The Original Super Tuner 1KW PEP \$129.50.**

If you're new at ham radio you'll find it's invaluable.

**B. Super Super Tuner 3KW \$229.50.**

If you've added more power to your station it's a must. Both the Super Tuner and the Super Super Tuner match balanced feed, coax, random or long wire. Both transfer maximum power from the transmitter to the antenna.

**C. NEW! The MT-3000A \$349.50.**

The MT-3000A was designed for the serious ham interested in professionalizing his station. It is a rugged antenna tuner that easily handles 3KW PEP. It has built-in dual watt meters, and a built-in dummy load. The antenna selector switch: (a) enables you to by-pass the tuner direct; (b) select the dummy load or 5 other antenna systems.

**D. 80-10 Wire Tuner \$59.50.**

Our random wire tuner handles 500 watts and is ideal for the ham on the move.

**E. W-2 Watt meter \$99.50.**

DenTron's dual in-line Wattmeter allows you to read forward and reflected watts simultaneously.

**F. SuperAmp \$574.50.**

The SuperAmp is one of the best amplifier values currently on the market. It covers 160-10 meters, and features four 572B triodes in grounded grid. With it add 2000 watts PEP SSB and 1KW CW power. No other amplifier delivers so much at such a reasonable price.

**G. NEW! MLA-2500 \$799.50.**

The MLA-2500 is one of the world's finest high performance military amateur amplifiers. It was designed for the discriminating buyer who knows and appreciates precision plus power. Coast along with a full 2000 watts PEP input on SSB, 1000 watts DC input on CW, RTTY, or SSTV. The heart of the MLA-2500 is a heavy duty, self contained power supply, and it features 2 Eimac 8875's.

**H. NEW! MLA-1200 \$399.50,**

external AC supply, \$159.50, DC supply \$199.50. The MLA-1200 shares many fine features with its famous big brother, the MLA-2500, but also has a few distinctive features of its own. It employs a single Eimac 8875, running 1200 watts PEP or 1KW DC. It incorporates the same built-in ALC as the 2500. The MLA-1200 is the smallest 1200 watt linear amplifier on the market, great for your mobile home, boat or car!



# DenTron

Radio Co., Inc.

2100 Enterprise Parkway  
Twinsburg, Ohio 44087  
Phone (216) 425-3173



DenTron for Amateur fun!



# FOR THAT PROFESSIONAL LOOK . . .

BY MIKE J. GOLDSTEIN, VE3GFN

*Save money, impress friends; build professional looking ham gear*



Are you a builder or an appliance operator? If you're a builder, read on; these words are directed to you. If you're an appliance operator, turn the page quickly, for the secrets to be revealed here could usher you into the art of building such magnificent ham gear that you will end up enjoying the awe reserved by your fellows for the successful builder.

It has been my experience many times in the past few years to have non-hams arrive in my shack, look at a piece of homebrew, and ask where I bought it. Hams who have built equipment themselves have even bought equipment born on my workbench. Since I have been building electronics gear for almost fifteen years (making a living at it at times), I have picked up many ideas and tips that contribute tremendously toward a finished product that is professional looking and a source of pride to me when it is finished. For those of you who are just starting out and don't know where to begin, and for those hardy souls who struggle toward perfection, I submit the following suggestions.

The first rule of thumb, and

the most important, is to have patience with the job. Think it out beforehand, do it carefully, and don't be satisfied with second best. This is hard when you want to get the job finished, but every rushed job and short cut will hit you right in the eye when you sit back to survey your handiwork; you will end up being dissatisfied. Since I have now imparted one-half of my hard-won knowledge, I can proceed to the remainder.

## **Metalwork**

The most popular form of ham-gear construction is the "chassis and panel" type. With this type of construction, everything is mounted on a metal chassis or sub-chassis, with the meters, control knobs, and switches on the front panel. Small units can be built directly into small commercially available utility boxes.

While it is certainly cheaper to scrounge sheet aluminum and bend up your own metalwork, the job will turn out poorly unless you have a good metal-working shop at your disposal. It is far better to buy the proper panel and chassis

new and start from there. Since aluminum is very easy to work with, use it as much as possible.

Always keep a catalog of metal parts handy when you're designing a project. Never use painted chassis for building — the grounding problems presented by the paint are horrible, and scraping paint from the inside of a chassis is awkward.

If the job is a large one, it may be better to use several chassis bolted together than one large one. This provides shielding between circuits and eliminates flexing which results from a large, flat, metal surface. This can often be a major factor in stabilizing receivers and exciters.

Cutting holes in metal can be an awful chore, or, part of the fun. Let's start with the drill — most of us don't have access to a drill press, but an effective hand-drill and a set of *sharp* bits will usually suffice. Set the work on a firm base before drilling and make sure it won't slip. Before drilling any holes, center-punch them first. This centers your hole in the right place and your drill won't slip and gouge the paint or your finger. When drilling, don't exert too much pressure on metal surfaces that will bend easily.

For larger holes, use a little machine oil on the bit. When working on a painted chassis, cover the entire surface with masking tape or thin paper; lay out the hole centers with a pencil and drill through the protective paper layer. Don't remove the paper until all the holes are drilled. Also, don't put an unprotected painted item on the workbench for drilling — all the metal bits you didn't brush off the bench will pepper your paint with scratches. It takes conscious effort not to make this mistake, and I always have a can of spray paint handy for touch-up jobs.

Try to avoid cutting holes with a drill larger than 1/4-inch



(6.5mm) in diameter. If you need a hole larger than this, cut a small hole and enlarge it to the desired size with larger drills. Larger holes should be cut with chassis punches. If you have a set of punches on the bench, life can be beautiful. A complete set is rather expensive, but you can usually find someone who has the size you need. Since they are so handy, a lot of hams get together and collectively buy a set.

If you have access to a machine shop, a circle cutter can be used instead of a punch. However, don't attempt to use a circle cutter with a hand drill — blood makes a poor lubricant. The *Adel* nibbling tool\* is handy for many metalworking jobs. This gadget will cut practically any size hole in material up to 1/16inch (1.5mm) aluminum or 18-gauge steel, and is practically a machine shop in itself.

When you use a chassis punch, put a little light machine oil on the bolt threads before each hole is cut. If possible, support the punch in a vise. Cut the clearance hole for the punch bolt just large enough for the threads to clear without scraping; then your carefully-placed centers will not be too far off after the hole is cut. One of the greatest *faux pas* you can make is to return a chassis punch with a metal ring inside it; the owner will think twice before lending it to you again.

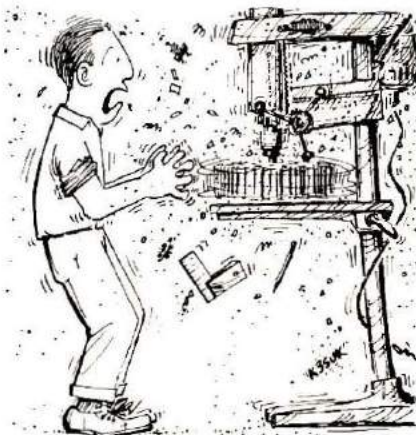
Chassis punches can even be used to cut 1/8-inch (3mm) thick aluminum rack panels; this can be done safely, even with the smaller sizes, if you protect the punch. Turn the bolt slowly and use lots of oil — the shearing torque developed on a punch bolt is surprising.

Since painting or retouching

metal is an art, I shall desist from comment except to mention that the aerosol-can spray paints do a beautiful job if you follow the directions on the can.

### Mounting components

Once you have the chassis and panel reasonably prepared for construction, you have to



Cutting holes in metal can be an awful chore . . .

consider the problems of mounting components. It has been my sad experience that predrilled holes never seem to end up where they should, despite the care I have taken to lay them out. Therefore, I always line up my sockets, control holes, etc., with a grease pencil line so I know how things are going to fit. And, I never drill any holes until I am ready to use them. Otherwise (I confess) I end up with at least one hole in the wrong place. This requires disguising, which is difficult; the "ventilating hole" excuse is thin, at best. If you don't pre-drill your chassis, you can change your mind as you build without inviting disaster.

As far as the layout is concerned, everybody says "keep it square" — I second the motion. Draw centering lines on the chassis with a grease pencil (washes off with solvent) so everything fits properly. Even vhf equipment can be laid out neatly, short

leads and all. Think the layout out on paper first so you won't forget some essential component. At one club station I know of, the entire rig and control system sit in a six-foot (2 meter) rack — except for the main high-voltage transformer; this sits in a desk drawer beside the operator. I never did figure that one out.

When the components are all mounted, nothing should wiggle. Keep the leads short, and mount all components along tag (terminal) strips. You can buy these in all sizes and combinations of terminals, so you should have a supply on hand before construction starts. Build everything as though it were going to be used in a Volkswagen during the Baja 1000. Use lock washers under all nuts.

Uniform hardware adds a great deal to the finished appearance of homebrew equipment. Keep a supply of standard nuts, screws, lock washers, and solder lugs on hand. I stock 6/32 (M3.5) screws in several lengths, with nuts and washers to match, and scrounge the odd sizes as I need them.

Speaking of hardware, never throw any away. When you strip a chassis, throw all the hardware into a box. The gismo you throw away is exactly the item you'll need next year when Hurricane Whatnot is raging and the world is doomed for the lack of a 3-mil, 1/2-inch (M1x13mm) white metal bolt with a hex head (thought you'd never need it, hah?). I have saved for years, and haven't been stuck for an odd size yet.

### Soldering

Ah, yes, soldering. There are solderers, and there are solderers. I have a friend who takes an hour to install one connector on a cable; the man who can tear it off afterwards is a *strong* man. I also know people who finish large kits in a day, but they are not on the air too much. Rig problems, you know.

\* \$10.05 at Allied Electronics Corporation, 401 E. 8th Street, Fort Worth, Texas 76102, or other Allied/Radio Shack outlets. Catalog number 527 R 5904.



Except for big jobs that require a lot of heat, the soldering gun is a crude instrument. The ideal soldering iron is between twenty and fifty watts and has a spade bit not more than 1/4-inch (6.5mm) in diameter.

If it's easy to replace bits on your iron, have a machinist friend turn a couple



Build everything as though it were going to be used mobile in a Volkswagen during the Baja 1000.

of bits down for fine work. Note that several of the tips manufactured today have a special coating on them to extend their life and prevent pitting — filing or removing the coating will shorten tip life.

When you first use a new tip, dip it into acid-free paste and tin it with the solder you intend to use. Don't use a rag to clean the tip; keep a tin containing a wet sponge handy and wipe the iron off on that. If you leave a little solder on the tip when the iron is sitting hot, the tip will not pit nearly so rapidly.

The rules for good soldering — clean surfaces, lots of heat, etc., all apply. Since heat rises, put the iron *under* the terminal being soldered. Use a minimum of solder, and don't depend on solder to hold a wire in position. Each wire should be hooked around the terminal to prevent it from springing off. It is a good idea to wrap the wires securely around a terminal if the wiring is to be permanent. As Ben Franklin

said, "The only permanent things in this world are death and taxes," and the former is being disputed in medical circles. Once you have attempted to remove a wire that has been securely wrapped, you will tend to depend on the solder bond for mechanical strength.

If you have to remove the solder to take off a wire or a component, don't just heat the connection directly. The flux in the solder has long since disappeared, and the hot solder will sit there while components and/or printed board char. Take a length of braid (like the shield on small coax) and dip the end in solder paste. Place the pasted end under the solder connection, put the iron against the braid, and press against the solder. The solder will run up the braid, nothing will overheat, and the wires will be exposed. If all the solder doesn't come off the first time, snip off the solder-saturated braid, redip the end, and repeat the process.

When soldering to rotary-switch terminals, it is sometimes difficult to keep solder from running down the terminals into the switch deck. If you color the switch terminal just below the solder point with a soft lead pencil, it isn't possible for the solder to flow down too far.

When you're soldering hookup wire, don't grip the wire just above the stripped section — the insulation will stick to the pliers and peel off when they are removed.

### Wire

There are many types of hookup wire available, and what you use must be governed only by your finances — buy the best you can afford. The best general hookup wire is stranded, number 20 to 24 (0.5-0.8mm) tinned copper with Teflon insulation. Teflon insulation will never peel back under heat and is really the best stuff to come along in years. The only drawback is

that it is expensive. The other types of insulation should be assumed to be susceptible to heat, and proper precautions should be taken to protect it while soldering.

My method is to strip the insulation back about 1/8-inch (3mm) further than I actually require. After stripping, I twist the strands tightly, and tin to



Speaking of hardware, never throw any away.

within 1/8-inch (3mm) of the insulation. The tinning allows such a fast transfer of heat that by the time the heat works up to the insulation, soldering is complete. Incidentally, twist and pre-tin all stranded wire, or you will have ends sticking out all over as soon as you try to bend it.

I have not mentioned solid wire because I find it often snaps off after being bent a few times — especially if you're modifying a circuit. Many of you will disagree with me, but I think solid wire just increases your headaches.

### General wiring

Try to cable all the interwiring on a chassis. Use different colored wires so you can easily identify different wires in the cable. Set up a standard color code: green for filaments, red for high-voltage, black for ground, etc., and stick to it. Don't lace your cables — it is difficult enough to modify a cable. If you want to tie them



down, tie separate loops at intervals along the cable with waxed lacing cord. You can cut these easily for modifying and then replace them. Unlacing a long cable in a tight spot is messy, and while you can sometimes remove a wire, replacing it in a tightly-laced cable is a hairy job indeed!

A better system is to use the small nylon clips which are available in a wide range of sizes. These loop around the cable and are held in place with screws and nuts. They make a beautiful appearance and modifications are a snap.

Two precautions: *never* run any rf or af signal leads (unless they're shielded) in a cable — the resulting pickup and feedback can run you in short circles for a month. Also, don't solder directly to the chassis — use solder lugs held in place with screws, nuts, and internal-tooth washers.

### The finishing touch

When the unit being built has been tested and debugged, the last decals are drying on the front panel, and the TVI test show negative, the time has *not* come to place your masterpiece in the console. Not yet.

While it is all open in front of you and your memories are still fresh, collect all your notes. Draw a schematic diagram, and make sure all the changes you made along the way are incorporated. Jot down the calibration procedure you discovered was the best. Make a note of the current and voltage readings at pertinent points. Your memory isn't nearly as good as you think, and this information will be necessary if anyone else ever inherits the equipment. Finally, file the information away where you can find it in a hurry.

There it is. You've done a nice job, and it looks as good as it works. It took a little longer, and perhaps cost you a little more, but, "Say, Sam, where did you buy that classy-looking rig?" **HRH**

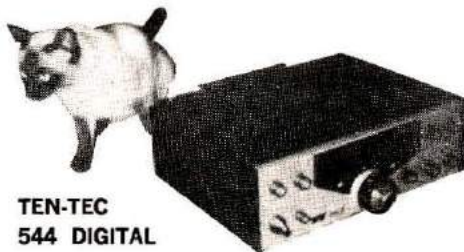


502-886-4534



## YAESU — TEN-TEC — TEMPO — DENTRON

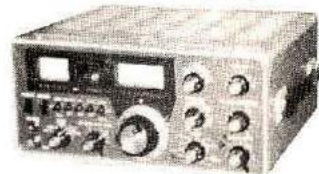
- WE HAVE FULL SERVICE ON WARRANTY AND NON-WARRANTY RADIOS.
- ALL NEW DIGITAL MODELS ARE NOW IN STOCK.
- CALL US SOON FOR PERSONAL SERVICE.



TEN-TEC  
544 DIGITAL

TRENTON, KY. 42286

**COHOON**  
AMATEUR SUPPLY



## FOR THE HAM

A BELT BUCKLE



From The COLORADO SILVER CO

Cast In SOLID BRONZE

ENGRAVED WITH CARE

This fine personalized belt buckle can be yours for only \$12.50, plus \$1.00 for postage and handling.

OR SEND FOR FREE DESCRIPTIVE BROCHURE.

COLORADO SILVER CO

P. O. BOX 1755  
ASPEN, COLO. 81611



COLO. RES. INCLUDE 3% SALES TAX

## MADISON SUPER BUYS

HY GAIN 18AVT/WB . . . 100 ft. RG8 coax \$100, 18V vertical . . . \$19.95, Model 214 2m Yagi . . . \$21.50  
VHF SPECIAL: Kenwood TS-700A List \$599. Special Price \$499  
KLM: Antennas, Linears, Accessories In Stock, FREE balun w/2m base antenna.  
ROTORS: NEW HAM X (turns 28 sq. ft. of antenna) List . . . \$325 Order now for \$289.  
NEW ITEM — CDE Ham III . . . \$129.00  
WE STOCK JANEL PREAMPS, TECHNICAL BOOKS (ARRL, Sams, Tab, TI, RCA & more).  
BIRD 43 WATTMETER & slugs, TELEX HEADSETS.  
SWAN: WM 6200 VHF Wattmeter . . . \$49.95  
SWR 1A Meter . . . \$21.95  
CETRON 572B tubes . . . \$24.95 ea.  
KESTER Solder 1:60/40, .062 . . . \$6.50  
NYLON CORD 5000 ft. . . per roll \$15.00  
BELDEN 14 gauge copper stranded antenna wire . . . \$5.00/100 ft.  
RG8 foam Xtra-Flex coax . . . 23 ft.  
RG8 foam Superflex coax . . . 23 ft.  
22 gauge plastic covered wire for long wire antennas, radials. . . \$3.50/1000 ft.

CALL FOR FAST QUOTE ON THESE OR ITEMS NOT LISTED: YAESU FT301D, FT301, FT101E, ATLAS 350XL, KENWOOD TS520S, TS820S, TS600A, TR7400A, TEMPO 2020 & ETO ALPHA. ALL IN SEALED CARTONS. CALL FOR FAST QUOTE OR WRITE & INCLUDE YOUR PHONE NUMBER. IF WE HAVE YOUR BARGAIN, WE'LL CALL YOU PREPAID.

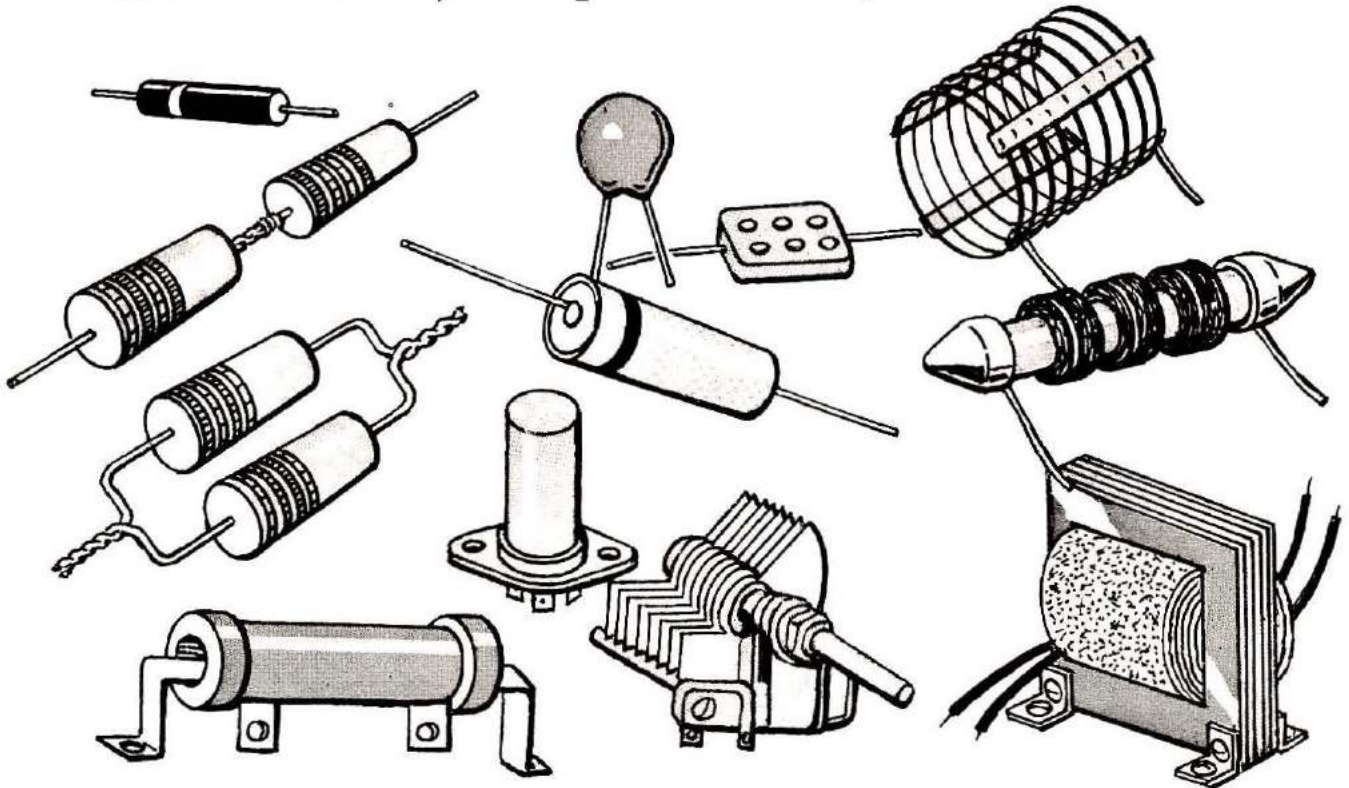
TERMS: All prices FOB Houston. Prices subject to change without notice. All Items Guaranteed. Some items subject to prior sale. Send letterhead for Amateur Dealers price list. Texas residents add 5% tax. Please add postage estimate, excess refunded.

**MADISON**  
ELECTRONICS SUPPLY, INC.

1508 McKinney Houston, Texas 77002  
713/658-0268 Nites 713/497-5683



# Understanding Resistors, Capacitors, & Inductors



Some basic principles behind three of the most common electronic components

BY PAUL G. SCHREIER, WA1TWT

If you're just starting to study electronics you've probably been overwhelmed by the huge number of new devices and concepts. Although this collection of unfamiliar ideas may appear bewildering, if each is analyzed separately you'll be surprised how easy electronic theory can be.

Almost every electronic circuit uses three basic elements: *resistors, capacitors, and inductors*. Let's get acquainted with them and see how they behave in electronic circuits.

## Resistors slow down everything

Probably the most common component in all electronic circuits, resistors do nothing

more than agree with their name — they "resist" and limit the flow of electrons in a circuit. You can tell how much a device resists current flow by looking at its resistance value, measured in *ohms* (and represented by the Greek symbol  $\Omega$ ).

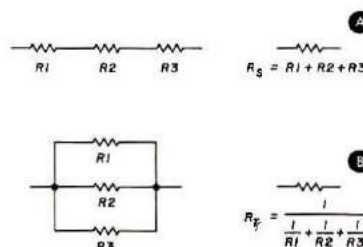


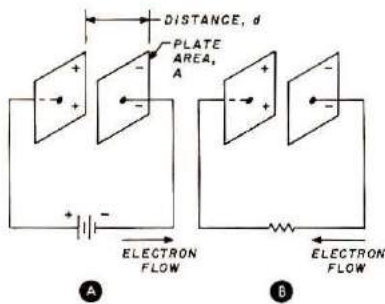
Fig. 1. With series resistors, **A**, electrons must pass through each resistor; sum their values to find the equivalent resistance. For the parallel case, **B**, however, electrons are split among the possible paths.

Also note that even conductors — wires or other paths designed to carry current — have resistance, although these values are very small, and you'll generally ignore such effects when working with circuits. But every resistor operates *linearly*. This means that, no matter how much voltage you apply across a resistor, the resistor passes only a certain current, *I*, with a value represented by

$$I = \frac{\text{volts}}{\text{resistance}}$$

Linearity also means that if you double the voltage, you double the current, so that a resistor's value remains *constant* under any condition, no matter if you apply ac or dc





**Fig. 2.** Capacitors charge when a source pushes electrons into one plate, leaving an absence of electrons (or holes, indicated by + signs) in the other plate, **A**. If given the opportunity, however, the charged particles will return to equilibrium; you can encourage that by removing the source holding the electrons on the plate and providing a return path, **B**.

power. Resistors pass all frequencies with equal ease.

What would you expect if you hindered current flow once with one resistor and then did the same thing immediately afterwards with another resistor? **Fig. 1A** shows that you can add these *series* resistances directly:

$$R_S = R_1 + R_2 + R_3 + \dots$$

where

$$R_S = R_{sum} \text{ of the resistors} \quad (1)$$

$R_1 \dots R_2 \dots$  = Resistance of each element (ohms)

For instance, suppose you needed a 1 kilohm (1000 ohm) resistor, but you have only smaller values? Just connect two 500-ohm resistors in series — it's as simple as that.

**Parallel resistors (Fig. 1B)** are a bit more tricky. Instead of making it more difficult for current to flow, the additional resistors offer more paths for the current to take and thus reduce the *effective* total resistance. You can calculate parallel resistance with this formula:

$$R_T = \frac{1}{\frac{1}{R_1} + \frac{1}{R_2} + \frac{1}{R_3} + \dots} \quad (2)$$

where

$$R_T = \text{Total resistance (ohms)}$$

Again, using those two 500-

ohm resistors, wire them in parallel. This time you have the effective value of each resistor and get  $R_T = 250 \text{ ohms}$ . Note, also, that in a mixed group of parallel resistors,  $R_T$  is always smaller than the smallest resistor in the group.

### Capacitors store energy

Capacitors collect electrical charges. That goes for *all* capacitors, whether they are made of plates, are electrolytics, are discaps, or tiny chips. All capacitors operate on the same principle so once you understand simple plate capacitors, you'll understand them all.

The capacitor in **Fig. 2A** is made of two parallel plates, each with surface area,  $A$ , and separated by distance,  $d$ . If you connect a battery or other voltage source across the capacitor, the voltage source forces electrons to flow from one plate to the other. (Remember, "like" particles repel each other and eventually the repulsive forces between the electrons will equal the force of the source trying to pack them into the plate. At that point, the voltage difference of the plates equals the source voltage.)

Now disconnect the voltage source. Because the packed electrons have no place to go, you have *stored energy*. When you place a load (such as a

resistor) across the capacitor as in **Fig. 2B**, the electrons will follow that path trying to find a spot as far as possible from other electrons. This action occurs when you have the same number of electrons anywhere on either plate, as when you attached the voltage source; but in the meantime, while moving to equalize the charge, these electrons perform *work* in your load circuit.

The amount of charge you can store on a capacitor depends on the applied voltage and the geometry of the device; the term *capacitance* describes this geometry. And while you measure capacitance in *farads*,  $F$ , you'll see most component values in the less cumbersome form of  $\mu F$  (microfarads) or  $pF$  (picofarads).

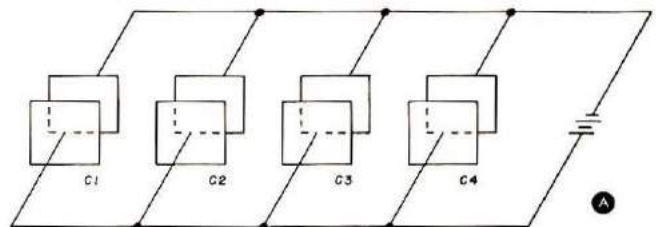
For a parallel-plate capacitor,

$$C = 0.224 \frac{KA}{d} (n-1) \quad (3)$$

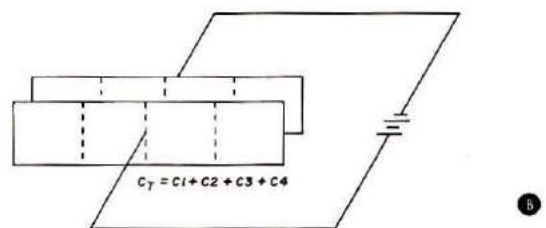
where

- $C$  = capacitance (pF)
- $K$  = dielectric constant of material between plates
- $A$  = area of one side of one plate (square inches)
- $d$  = separation of plate surfaces (inches)
- $n$  = number of plates

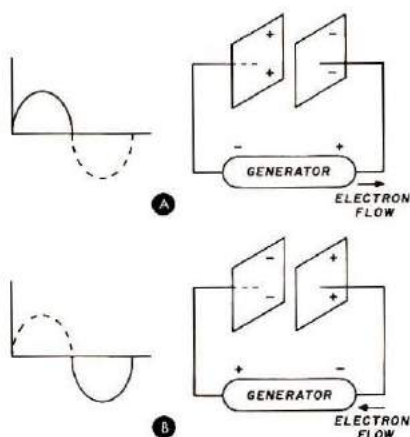
In **Equation 3** we have two physical constants,  $K$  and  $n$ . Constant  $K$ , is the dielectric



**Fig. 3.** Think of parallel capacitors **A** as disconnected sections of one larger capacitor, **B**.







**Fig. 5.** Capacitors appear to pass ac by charging one plate during each positive half cycle **A**, and then by transferring that stored charge to the other plate for the negative half cycle, **B**, creating a current flow in the exchange.

constant of the insulating material used between the capacitor plates; for air,  $K$  is unity and physical materials such as glass, paper, mica, have  $K$ 's larger than one. The other constant in **Equation 3** is  $n$ , the number of plates in the capacitor.

If square centimeters are substituted for  $A$  and centimeters for  $d$ , then the factor  $0.224$  should be replaced with the factor  $0.0882$ ; all other terms remain the same.

Examination of **Equation 3** shows that increasing plate size or decreasing plate separation increases capacitance.

### Make a dielectric sandwich

To keep the charges on the plates isolated, you have to separate the plates from each other with an insulator. Different insulators give any configuration different capacitances;  $K$  tells you how that capacitance compares with an air-filled device, whose  $K$  is one. Thus, with a value of  $K=1$  for air, if you fill a capacitor with mica ( $K=5.4$ ) you'll increase its capacitance by that same factor, 5.4. Thus, dielectrics let you buy higher capacitance components in smaller packages. The

discussion above shows you how variable-plate capacitors work. As you turn the dial, you change the relative position of the plates from fully meshed (maximum  $C$ ) to totally unmeshed (minimum  $C$ ).

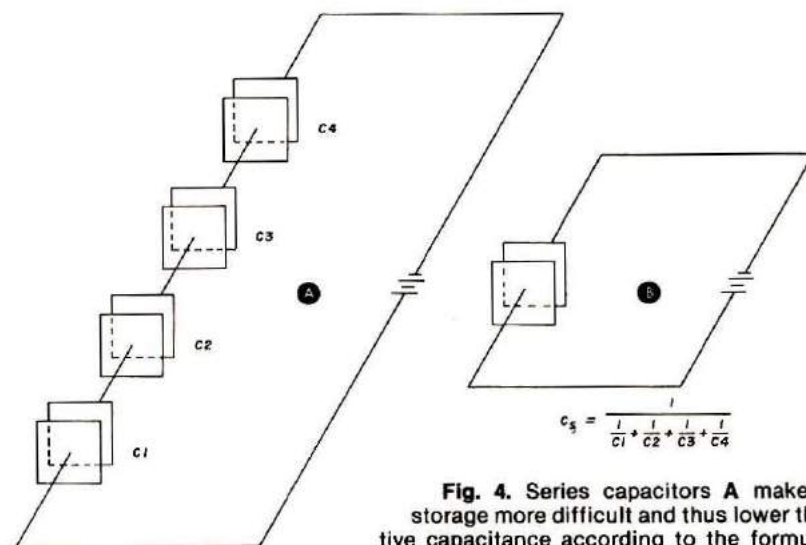
The concept of multiple-plate capacitors leads directly to the next point — how you add values of  $C$  in various arrangements. Suppose you have a number of plate capacitors connected as in **Fig. 3A**. Could you pretend they were all made of one big plate, as in **Fig. 3B**? Well, that's exactly right, because parallel capacitors merely sum their values to obtain the equivalent value (just as with series resistors).

Series capacitors (**Fig. 4A**), like parallel resistors, are a little more tricky. Instead of increasing total  $C$ , the additional components make it more difficult to store charges and thus reduce the effective value according to the formula

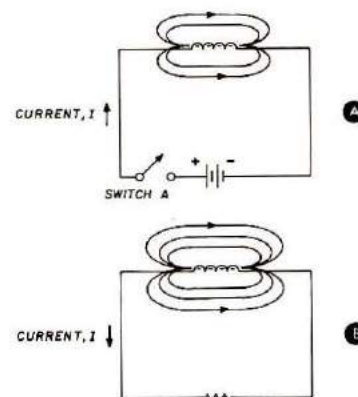
$$C_S = \frac{1}{\frac{1}{C_1} + \frac{1}{C_2} + \frac{1}{C_3} + \dots} \quad (4)$$

For example, suppose you need  $2 \mu\text{F}$  but only have  $4\text{-}\mu\text{F}$  caps on hand. Just connect two  $4\text{-}\mu\text{F}$  caps in series to halve the effective value of either one.

It's easy to see, also, how



**Fig. 4.** Series capacitors **A** make charge storage more difficult and thus lower the effective capacitance according to the formula in **B**.



**Fig. 6.** The current that a voltage source pushes through an inductor builds up and maintains a magnetic field, **A**. But if you provide a path, as in **B**, the field will collapse, releasing its energy through the electrons it pushes through the circuit.

capacitors react to different frequencies. As you just learned, if you apply a dc voltage to a capacitor, the plates charge up and then current stops flowing. Thus capacitors block dc current. That certainly makes sense because in reality you've got a gap in the path — equal to the distance between the two plates. Any time you've got such a gap, you can't expect current to flow.

But, amazingly, even with this gap, capacitors do pass ac currents! In a typical ac signal's positive half-cycle (**Fig. 5A**), the source moves electrons to one plate. When the source goes to zero and



**TEN-TEC 544 DIGITAL.** Another ahead-of-its-time achievement from the pioneers in solid-state HF amateur radio technology. The 544 Digital joins its successful companion, Triton IV, to chart new paths in engineering.

**THE RECEIVER.** Deserving of all superlatives. Range: 3.5-30 MHz (plus "160" with option). MOSFET RF Amplifier with Resonate Control for a sensitivity of 0.3  $\mu$ V for 10 dB S+N/N. And overload minimized. Noise Blanker option: remarkably effective against impulse noise, functions in the IF, controls from the front panel. Hetrodyne crystal mixed VFO: steady as a rock. 8-pole 9 MHz Crystal-Lattice IF filter for a selectivity curve straight out of the text books: steep skirts, flat top, and narrow (2.5 kHz bandwidth, 1.8 shape factor at 6/60 dB points). Offset Tuning, with LED indicator, permits independent tuning of the receiver through a 10 kHz range (approx.). As one owner put it, "it makes SSB nets a breeze." And that beautiful Digital readout: six 0.43" LED digits, 5 in red and the least significant 6th in green, reading to 100 Hz with an accuracy of  $\pm$  50 Hz, settable to WWV. (Who needs a calibrator? And, indeed, it has none). WWV reception at 10 & 15 MHz. The sound? So beautifully clean and clear, it wins raves from all. Less than 2% distortion. Built-in speaker to clear the operating position. And External Speaker/Phone jack. CW Filter option, 2-position, 150 Hz width. Zero-Beat Switch for right-on CW. Whether you operate SSB or CW or both, you'll agree the 544 has a truly superior receiver section.

**THE TRANSMITTER.** 200 Watts Input - all bands, SSB or CW. Instant band change *without* tuneup! And no danger of off-resonance damage, even with the wrong antenna. 8-Pole SSB Filter. Automatic Sideband Selection, reversible. Push-Pull Output with the heat *outside* of the cabinet. 100% Duty Cycle so you can use it for RTTY and SSTV. Front panel ALC control with LED to show operation in the ALC region. Meter shows SWR when transmitting. VFO circuit is permeability tuned, has less than 15 Hz change per F° after 30 min. warmup, less than 10 Hz

change from 105-125 VAC with accessory power supply. SSB speech quality is completely natural, CW signals clean, articulate. And *full* CW break-in! So right you wonder why it wasn't done before - turns monologs into conversations. Sidetone is adjustable in pitch and volume. Automatic CW offset of 750 Hz. P-TT. Hi-Z mic. input. RF Output-Z 50-75 ohms, unbalanced.

**THE CONSTRUCTION.** Styled for today and tomorrow - etched aluminum front panel, black nomenclature, black top and sides. Ruggedized chassis stands up to the rough handling of mobile/portable use. Modular construction: 10 plug-in assemblies, 9 fixed circuit boards (65 transistors, 38 diodes, 14 ICs, 1 LSI, 6 LED displays). Snap-up front feet. Size: 4½ x 13-5/8 x 13. Net weight: 12 lbs.

**THE ACCESSORIES.** Model 242 Remote VFO for six-mode operation; 241 Crystal Oscillator for 6 spot freqs.; 240 Converter for 160 Meter operation at slightly reduced power level; 215P Microphone & Stand; 252G protected power supply; 262G power supply plus VOX plus 2 speakers; 207 Ammeter for supply monitoring; 249 Noise Blanker; 245 CW Filter; 212 Crystal for 29.0-29.5 MHz; 213 Crystal for 29.5-30.0 MHz. Plus various sized matching blank enclosures.

**TEN-TEC 544 DIGITAL.** So right, so advanced, it may well be the last rig you'll ever need to buy!

544 Digital - \$869

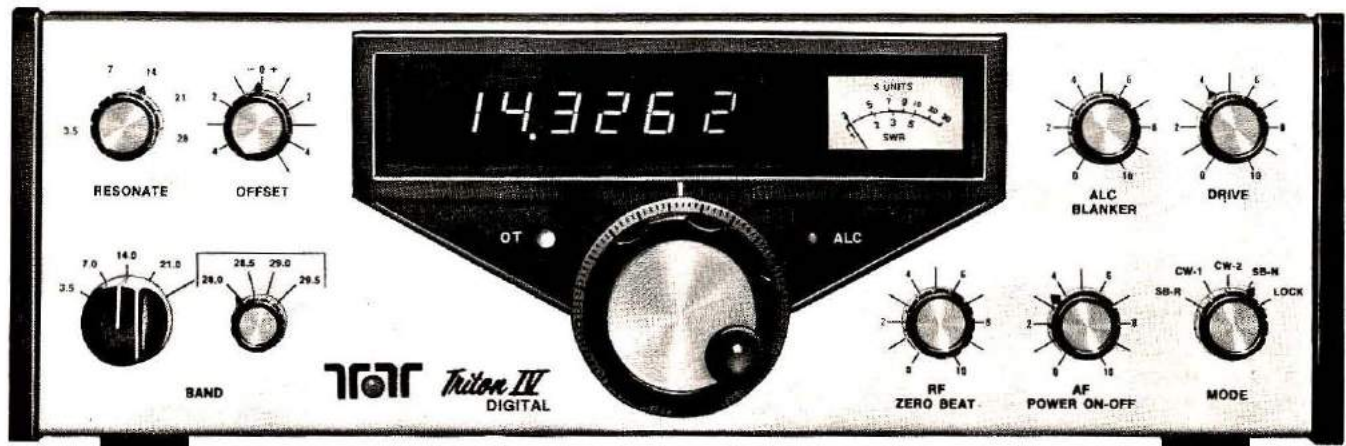
540 Non-digital - \$699

See the 544 and its companion 540 non-digital transceiver at your nearest TEN-TEC dealer, or write for full details.

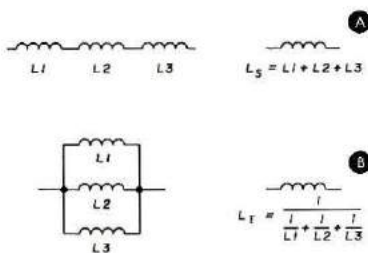
**TEN-TEC, INC.**  
SEVIERVILLE, TENNESSEE 37862  
EXPORT 5715 LINCOLN AVE., CHICAGO, ILL. 60648

We have been notified that Motorola has been granted registration of the tradename "Triton." Consequently, TEN-TEC will refrain from using "Triton IV" when referring to our transceivers, beginning January 1, 1978. We say "goodbye" to the name, but certainly not to models 540 and 544.

# ENCORE! ENCORE! TRITON GOES DIGITAL







**Fig. 7.** Series inductors, **A**, and parallel inductors, **B**, both behave identically to their resistor counterparts.

then into its negative half-cycle (**Fig. 5B**), this stored-up charge moves to the other plate, and current flows back and forth as if it had a completed path. On the other hand, if the capacitor's plates weren't there, the source would have no place to store a charge and no current would flow at all. Thus, even though electrons do not actually flow through a *continuous* path through the capacitor, the circuit can't tell the difference.

### Inductors play the field

In addition to capacitors, there's one other category of basic energy-storage devices you'll see quite often — inductors. To understand how they work, it's necessary to introduce two very simple concepts from physics: moving charges create magnetic fields, and a changing magnetic field likewise pushes charges around.

According to these laws, even a single wire carrying current sets up a magnetic field. That's true, but the resulting field is so small you can't depend on it to do anything useful. Instead, wind that wire into a coil, because that arrangement intensifies the magnetic field as much as any other; then you can put the field to work.

Just like capacitors, inductors (often called coils) store energy. For instance, when you throw switch **A** in **Fig. 6A**, current begins to flow. But remember, a moving charge creates a corresponding

magnetic field. Just as you isolated your charged capacitor, disconnect the inductor's power source when the field has built up to its maximum intensity (**Fig. 6B**). The field stores energy because it wants to move electrons, but there's no place for the coil to release the electrons. If you connect a load resistor across the coil, the built-up energy begins to escape. This collapsing magnetic field induces a current flow through the load circuit.

The magnetic field that a coil can build depends on its geometry which is measured in *henrys* (H), *millihenrys* (mH) or *microhenrys* ( $\mu$ H). We can measure this *inductance* (L) with the formula

$$L = \frac{a^2 n^2}{9a + 10b} \quad (5)$$

where

- L = inductance ( $\mu$ H)
- a = coil radius (inches)
- b = coil length (inches)
- n = total number of turns

If a and b are in centimeters, **Equation 5** becomes:

$$L = \frac{0.16a^2 n^2}{3.5a + 3.9b} \quad (6)$$

Thus, while coil radius can either increase or decrease coil inductance, increasing the number of turns for a given length increases L; while increasing the length for a certain number of turns will decrease L. The ratio of coil length, b, to coil diameter (2a) is called the form factor, which is important in many designs using inductances.

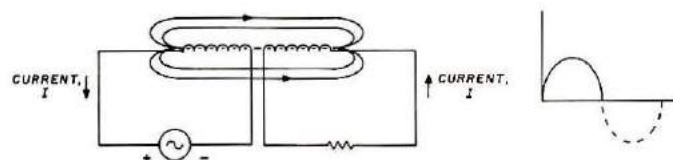
You should easily recognize what happens when you connect inductors in series — it's just like piecing one longer coil together (**Fig. 7A**), adding all the turns. Thus, you can merely sum their individual values together, as with series resistors. As with parallel resistors, you'll have to use the trickier formula for parallel inductors, as shown in **Fig. 7B**.

### Changes mean more work

Remember how capacitors block dc and pass ac signals? Inductors do just the opposite — they pass dc and inhibit ac. You just saw how dc sets up a magnetic field in a coil. But once the dc builds up the field to its maximum value, the current passes through the coil unimpeded without doing any additional work, because only *changing* currents set up these fields. (When you turn on the current, you change its value for a brief instant, right? That's when the field builds up. The continuous current flow merely maintains that field.)

However, if you place an ac source across the coil, the current changes constantly from positive to negative. The current is so busy in the coil building up a field in one direction and then, when it changes polarity, building up another field in the other direction, that it has a tough time getting through the coil to do any useful work. Now you can see how inductors inhibit ac signals while passing dc.

There's one additional effect to become familiar with: *mutual inductance*. If you align two coils properly and build up a field in one, that field extends into the field of the other coil



**Fig. 8.** This field couples, or connects, the two inductors, so that a current flowing in the left-hand circuit produces a proportional current in the right-hand circuit.



as well (Fig. 8). Remember that a changing magnetic field pushes electrons; so moving electrons in one coil with a current will induce a field that couples the two coils. Thus a current in the second coil occurs without any physical interconnection. Transformers, in particular, rely on this effect.

### Put the pieces together

Now you'll see that you can connect these various components — resistors, capacitors, and inductors — in various ways to work with different frequencies. (How to make these connections, however, is the topic of other articles.) For now, you've mastered a very important lesson: different components let you select different frequencies for whatever purposes you wish.

### Bibliography

1. David Halliday and Robert Resnick, *Physics*, Part II, John Wiley & Sons, Inc., New York, 1962.
2. Sy Levine, *Electronic Business Magazine's Basic Electronics Course — From Ohm's Law to Microprocessors*, Cahners Publishing Co., Boston, 1976.
3. *The Radio Amateur's Handbook*, American Radio Relay League, Newington, Connecticut, 1977.

HRH

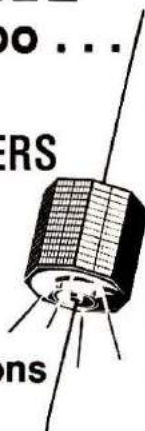


"I'd like a phone patch to Santa Claus, please, grampa."

# 2 METER FM

## and HF too . . . SATELLITE HEADQUARTERS

See Erickson for all of your Oscar communications needs!



Call or Write for Erickson's Deal

- Ameco • ASP • Atlas
- Belden • Bird • CDE
- CES • Collins • Cushcraft
- Dentron • Drake • HAL
- Hy-Gain • Icom • KLM
- Kenwood • Larsen • MFJ
- Midland • Mosley • NPC
- Newtronics • Nye
- Regency • Shure • Swan
- Standard • TPL • Tempo
- Ten-Tec • Wilson • Yaesu



Hours: 9:30-9 Mon. & Thurs,  
9:30-5:30 Tues, Wed. & Fri.  
9-3 Sat.



**E** ERICKSON COMMUNICATIONS  
5935 N. Milwaukee Ave.  
Chicago, IL 60646  
(312) 631-5181

## FREQUENCY STANDARD



- ✓ Precision crystal.
- ✓ Markers at 100, 50, 25, 10, 5 KHz.
- ✓ Zero adjust sets to WWV.

The Palomar Engineers Frequency Standard gives sharp clear markers throughout the high frequency band from 160 through 6 meters. With the panel switch in 100 KHz position the markers can be heard every 100 KHz for checking calibration of your receiver, transceiver, or VFO. Additional markers can be turned on with the panel switch every 50, 25, 10 or 5 KHz.

The exclusive Palomar Engineers circuit generates only the wanted markers. No extra "ghost" markers appear.

Connection to your receiver is simple. A twisted-wire capacitor from the Standard to the receiver rf amplifier or mixer. Or a short "antenna" connected to the Standard may radiate enough marker signal.

The Frequency Standard is factory set to frequency and the setting can be checked and adjusted with the "zero" trimmer while listening to WWV or a broadcast station. All markers are as accurate as the WWV calibration, typically .0001%.

Don't take chances; check your frequency. Use the Standard with the wide range of selectable markers, the time-proven Palomar Engineers Frequency Standard.

Send for free brochure.

The price is \$37.50 (9-v battery not included) and we deliver postpaid anywhere in the U.S. and Canada. California residents add sales tax. ORDER YOURS NOW!

**PALOMAR ENGINEERS**  
BOX 455, ESCONDIDO, CA 92025  
Phone: (714) 747-3343



# the famous HAM KEYS

The keys that are easy  
to put your fingers on!



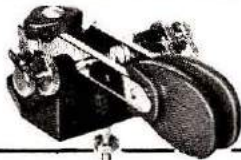
JUST DIAL  
**1-800-325-3636**  
TOLL FREE



**Model HK-1**

- Dual-lever squeeze paddle
- Use with HK-5 or any electronic keyer
- Heavy base with non-slip rubber feet
- Paddles reversible for wide- or close-finger spacing

**\$29<sup>95</sup>**



**Model HK-2**

- Same as HK-1, less base for incorporation in own keyer

**\$19<sup>95</sup>**

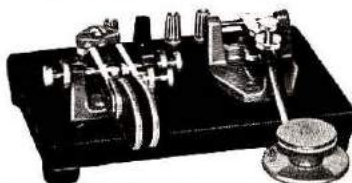


**Model HK-3**

- Deluxe straight key
- Heavy base - no need to attach to desk
- Velvet smooth action

**\$16<sup>95</sup>**

Navy type knob, only \$2.75



**Model HK-4**

- Combination of HK-1 and HK-3 on same base

**\$44<sup>95</sup>**

- Base only with rubber feet \$12.00

Terminals, red or black, \$.75 each



**BRAND new**

**Model HK-5  
Electronic Keyer**

- Taptic Circuit for squeeze keying
- Self-completing dots and dashes
- Dot memory
- Battery operated with provision for external power

- Built-in side-tone monitor
- Speed, volume, tone and weight controls
- Grid block or direct keying
- For use with external paddle, such as HK-1

**\$69<sup>95</sup>**

Same day shipment . . . PREPAID

We welcome the use of your



**HAM RADIO CENTER, INC.**

8340-42 Olive Blvd. • P.O. Box 28271 • St. Louis, MO 63132

## Price-Buster.

The **Kantronics Mobile 2 Antenna Kit** offers a reasonable alternative to the high priced VHF antenna! The **Mobile 2** is a high-quality, quarter-wavelength antenna that is quickly assembled. Everything needed for use with your 2 meter rig is included in the kit.

Adjustable whip length and accompanying Allen wrench permit tuning your **Mobile 2** for best SWR, and 18 feet of RG-58/U coax connect to almost any point on your car. Kit also includes a standard PL-259 connector.

**All these features . . . for a low, low price!**

Write us, or ask your dealer about the **Mobile 2** and other **Kantronics** amateur radio products.



only **\$8.95**

**KANTRONICS**  
The Lightweight Champs.

Telephone 913-842-7745  
1202 East 23rd St.

Lawrence, Kansas 66044

## MORSE CODE COURSES

INCLUDES  
SPECIAL PREP  
FOR THE NEW  
COMPREHENSIVE  
CODE EXAM

*Specially Designed  
for Beginners*

OUR 2 NOVICE COURSES TAKE YOU FROM DAY 1 (NO KNOWLEDGE OF ANY CODE) THRU 6 OR 8 WORDS PER MINUTE

### NO CLASSES-LEARN AT HOME

OUR NEW METHOD SUCCESSFULLY USED BY PEOPLE FROM 10 THRU 65 YEARS OLD. PLENTY OF PRACTICE MATERIAL, OUR 6 & 7 CASSETTE METHODS SUCCEED WHERE 1 & 2 FAIL.

INCLUDES EXCLUSIVE NOVICE TRAINING SCHEDULE ALL REFERENCE MATERIALS, CHECKING SHEETS TO VERIFY ACCURACY, INFO ON OTHER HAM LICENSE REQUIREMENTS.

STANDARD 2 TRACK MONAURAL CASSETTES PROVIDE 60 MINUTES EACH OF SCIENTIFICALLY PREPARED CODE PRACTICE (LETTERS, NUMBERS, PUNCTUATION, CODE GROUPS, WORDS) CASSETTES ARE DESIGNED TO MINIMIZE LEARNING PLATEAUS, EMPHASIZE NEW MATERIAL.

SET 1 0-6 WPM (Novice License)	6 CASSETTES	\$15.95
SET 2 0-8 WPM (Novice License)	7 CASSETTES	17.95
SET 3 7-14 WPM (Gen Cl License)	3 CASSETTES	8.95

First class postage and handling required per CASSETTE 0.40

SPECIALISTS-- OUR ONLY PRODUCTS ARE TAPE COURSES

THE HERRMAN CO.  
DEPT J, BOX 1101, LARGO, FLA 33540

CLUBS - GROUPS ANY 10 OR MORE SETS  
10% OFF + 25 ¢ PER CASSETTE 1ST CL. POST & HNDLG.



# ME-3 microminiature tone encoder

Compatible with all sub-audible tone systems such as: Private Line, Channel Guard, Quiet Channel, etc.

- Powered by 6-16vdc, unregulated
- Microminiature in size to fit inside all mobile units and most portable units
- Field replaceable, plug-in, frequency determining elements
- Excellent frequency accuracy and temperature stability
- Output level adjustment potentiometer
- Low distortion sinewave output
- Available in all EIA tone frequencies, 67.0 Hz-203.5 Hz
- Complete immunity to RF
- Reverse polarity protection built-in



**\$29.95 each**

Wired and tested, complete with K-1 element

**communications specialists**

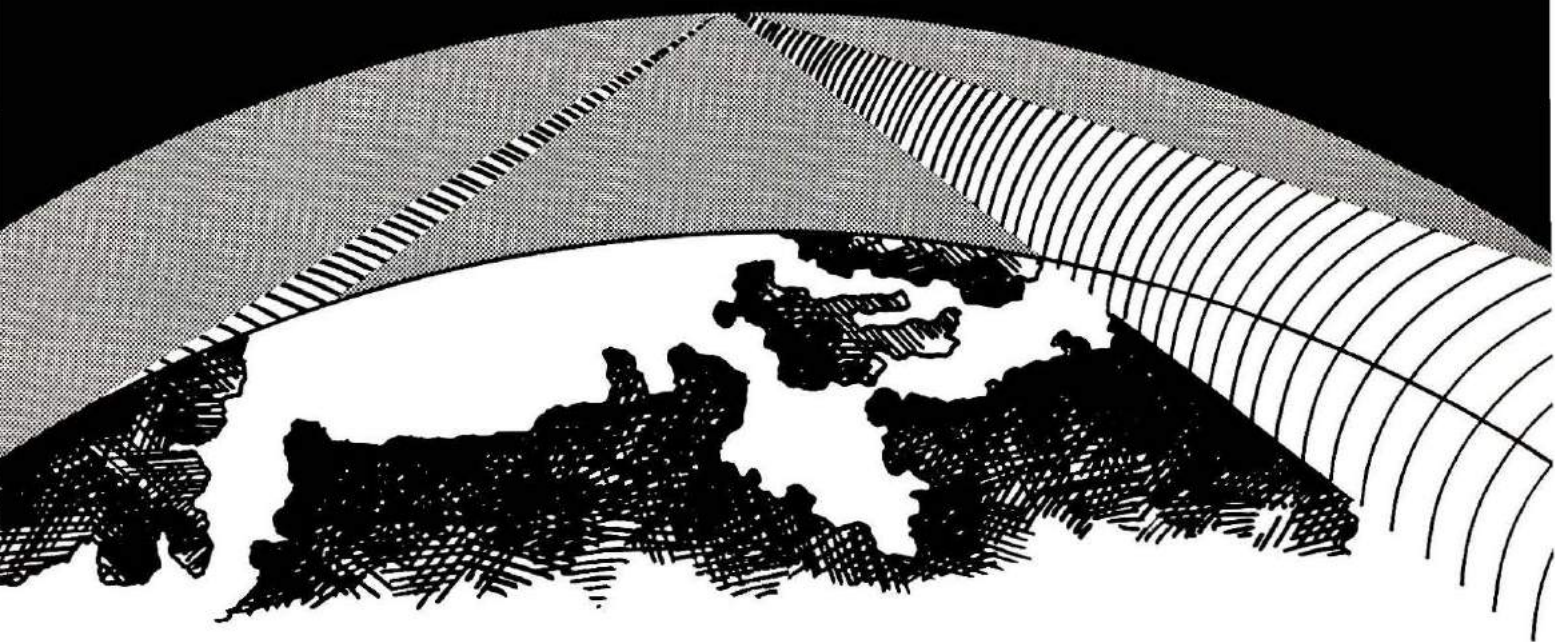
P. O. BOX 153  
BREA, CALIFORNIA 92621  
(714) 998-3021



K-1 FIELD REPLACEABLE,  
PLUG-IN, FREQUENCY  
DETERMINING ELEMENTS

**\$3.00 each**





# IONOSPHERIC FOCUSING

*It will help your operating if you know it's there and get ready*

BY CALVIN R. GRAF, W5LFM

Have you ever wondered why every so often you'll work or hear a station that runs low power and yet comes booming in like the *Voice of America*? Have you also wondered why at certain times stations from a particular direction will peak greatly in signal strength then, a short while later, sound as if the bottom of the band had dropped out? What you're witnessing is a phenomena of radio propagation, which until recently had been discussed

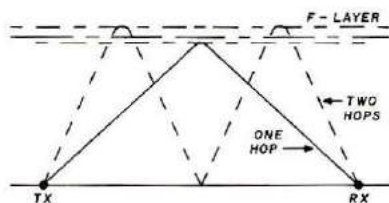


Fig. 1. Signals from transmitter (point TX) arrive at receiver (point RX) by means of one- and two-hop F-layer ionospheric propagation. (The F-layer is about 165 miles [265km] above the earth's surface.)

only in advanced scientific circles — the intriguing effects of *ionospheric focusing*.

## What's in it for me?

Just what is "ionospheric focusing?" Is it just a scientific curiosity? Is there something mysterious about it? Can one get something for nothing? Why has ionospheric focusing not been discussed much in technical circles until now?

Two techniques adapted recently in radio propagation research have helped greatly in pointing out the usefulness and merits of ionospheric focusing. These are the computer, which is programmed to calculate various ionospheric paths (ray tracing), and the oblique ionospheric sounder.

Before we further describe the "why for," let's discuss the "what for." If you're sufficiently interested in studying the "hows" and "whys" of ionospheric focusing and following certain operating procedures, it's possible to

realize 9-10 dB of increased gain in the signal you effectively radiate.

Consider the fellow who runs a kilowatt input on CW or a-m into a 10-dB gain antenna, such as a well-designed Yagi or log-periodic array. The output of an efficient transmitter will be

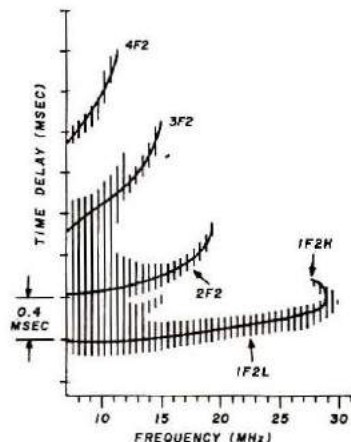


Fig. 2. This is an *ionogram* produced by obtaining data from a swept-frequency oblique ionospheric sounder. Strong one-hop F-layer, two-hop F-layer, and three-hop F-layer paths are shown. A weak four-hop F-layer path is also discernible.



about 70 per cent of the final input, or 700 watts in this case. The 10-dB antenna gain provides an effective radiated power of 7000 watts. Through the effective use of a focusing gain of 9-10 dB, the total effective communication circuit power, as observed at a distant receiver site, is 70,000 watts! And what is of great interest is the fact that this 10-dB gain is also realized in the receiving case.

### Recent research techniques

To describe the mechanism of ionospheric focusing gain, we'll look at several aspects of the techniques used in propagation research. In Fig. 1, we see how two-way communication is established between two stations separated

by a nominal 850 statute miles (1370km).

For the distance and frequency involved, one-hop F and two-hop F propagation paths are open. Note that the two-hop F path penetrates further into the ionosphere before refraction occurs, because the launch angle from the transmitter site is higher than for the one-hop path. If we were to place a swept frequency oblique sounder at the transmitter site and sweep the frequency from 7-30 MHz, we'd obtain at the receiver site an ionogram as shown in Fig. 2.

### The swept-frequency oblique sounder

The swept-frequency sounding technique requires the receiver to be swept in

frequency in time synchronization with the transmitter to within less than a few tenths of a millisecond. Usual sweep rates are 25 kHz/second to 1 MHz/second, with radiated power levels of milliwatts to tens of watts.

From Fig. 2, we see that one-hop propagation occurs from 7-29 MHz and two-hop propagation occurs from 7-19 MHz. If we further examine the nose of the ionogram produced, we see that both low-ray and high-ray energy is present in the one-hop path. Two-, three-, and four-hop F-layer propagation also occurs.

### Computer ray tracing

A computer can be programmed to plot (trace out) all possible ray paths from the

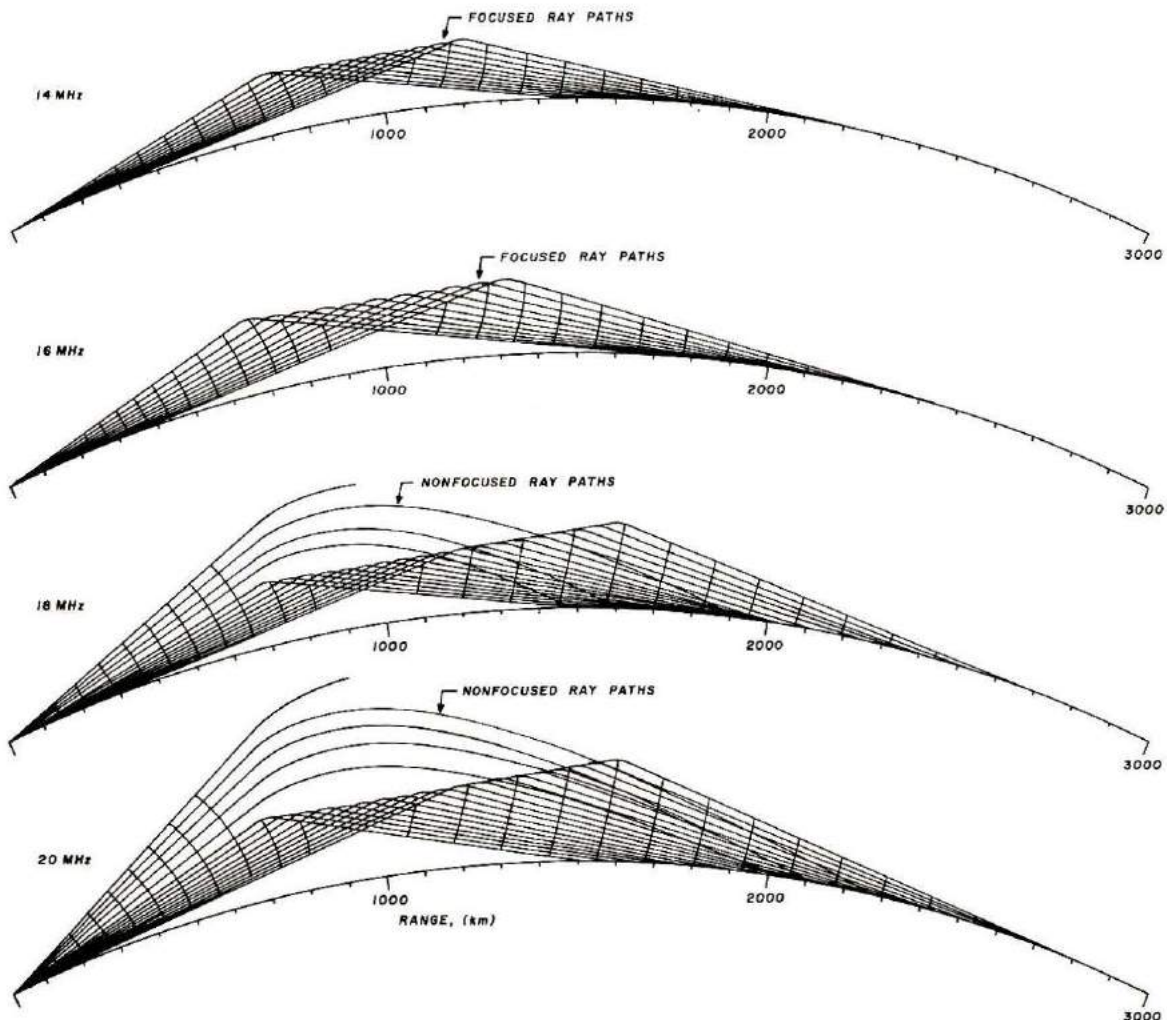
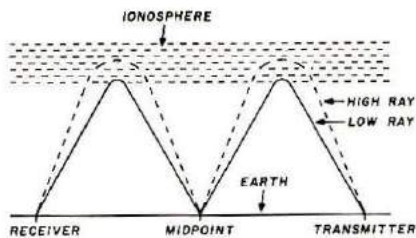


Fig. 3. Computed rays that show the mechanism of ionospheric focusing. The rays are focused at a range of about 1240 statute miles (2000km) for frequencies of 14 and 16 MHz. Ray paths for 18 and 20 MHz are not focused.





**Fig. 4.** Geometry for two-hop oblique ionospheric propagation at a single frequency, showing both high and low ray paths.

transmitter to the receiver. **Fig. 3** shows such a plot. Note that for departure takeoff angles of a number of the rays, the rays are *focused at the receiver site*.

It can be seen that for a frequency of 14-16 MHz, the energy is concentrated at a range of about 1240 statute miles (2000km). For ray paths closer to, and further from, the transmitter than this distance, normal spreading occurs and there is no focusing. From **Fig. 3** we also see that no focusing occurs for a frequency of 18-20 MHz. **Fig. 4** shows a simple plot for the two-hop case for the same path to illustrate low and high rays.

### Signal fade rate

To understand more about a signal from its amplitude and fade rate, and thus when ionospheric focusing might come into play, let's look at the plot shown in **Fig. 5**. The plot shows received signal amplitude with time for a particular frequency and path. Much information can be obtained from such a record. At **A**, the signal level is determined by the one- and two-hop signal levels. **B** shows a deep, rapid fade as the MUF (maximum usable frequency for the path) for the two-hop path begins to decrease in frequency.

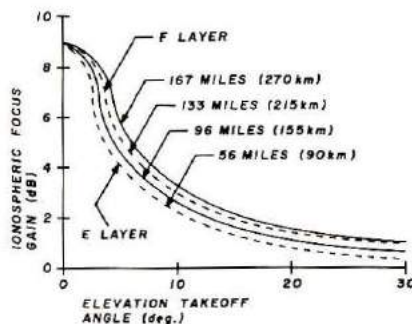
Remember, the two-hop signal takes off at a higher angle, so its MUF must be lower in frequency to be reflected from the ionosphere. As the two-hop "skip zone" wanders back and forth across

the receiving site, the signal level fades as it reinforces and cancels that of the one-hop signal, which is the stronger of the two. At **C**, two-hop MUF failure occurs. The signal remaining at **D** is due now to one-hop propagation only. At this time, the signal level may begin to peak as we approach the nose of 1F2L and 1F2H of **Fig. 2**. It's during this time that ionospheric focusing occurs on this particular path. It also occurs at point **C** as the path is near the skip distance for the two-hop signal.

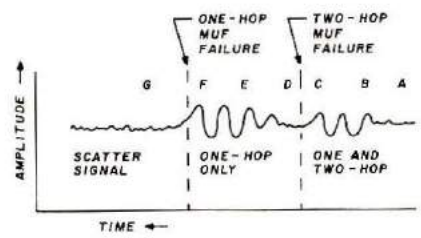
The signal level will continue for about 10-15 minutes in this enhanced mode until we reach point **E** of **Fig. 5**. Then the signal will experience deep fades (approximately 30-40 dB) with a frequency of about one fade per second. This occurrence triggers the onset of MUF fading before MUF failure, which occurs at point **F**. The signal will fade rapidly into the receiver noise level or ionospheric-scatter signal level (point **G**). Ionospheric scatter occurs from a nominal frequency range of 10-60 MHz and for distances of approximately 500-1400 statute miles (800-2240km). Ionospheric focusing would occur at points near **C** and **F** of **Fig. 5**.

### When and where to look for ionospheric focusing

We've discussed the occurrence of ionospheric focusing. But how can this phenomenon be used to best



**Fig. 6.** Ionospheric-focus gain realized at different takeoff angles of elevation. Broken lines show relative E- and F-layer heights.



**Fig. 5.** Received signal amplitude as a function of time for one- and two-hop propagation.

advantage in day-to-day amateur contacts?

Because it's a "sometime" thing, we must make the situation fit its occurrence. Ionospheric focusing is present when the MUF is going up or down, so it's present twice on *any one* path, direction, and frequency. Other than for propagation to the antipodes, two principal conditions occur when focusing occurs for ionospherically propagated signals:

- A.** Near the skip distance.
- B.** For rays of low elevation angles.

Focusing gain versus elevation takeoff angle is shown in **Fig. 6**.

In general, the MUF follows the sun, so we can say, "Sun to east, MUF high to east, focusing to east. Sun to west, MUF high to west, focusing to west."

Usually, the higher the frequency, the more readily the effects of focusing will be observed. The amateur 20-, 15-, and 10-meter bands are ideal for using this effect to the best advantage.

### When to use ionospheric focusing

Contest operating or DX work are choice candidates for using good amounts of operator patience and ionospheric focusing. By listening to "how" the desired signal fades (or other stations in the same general area and operating band), you can time calls to the desired station by knowing when he should be



getting through with the best possible signal strength.

A second unique thing is happening at this time: that of geographic selection. The geographic area of coverage over which focusing occurs at a particular time is not large. Thus, many stations that might also be seeking to work that rare DX you're about to snag must wait their time until they, too, are favored by ionospheric focusing.

### Acknowledgement

Acknowledgement in the preparation of this article is made to Andrew S. Weeks, Stein Associates, Waltham, Massachusetts.

### Bibliography

1. Bradley, "Focusing of Radio Waves Reflected from the Ionosphere at Low Angles of Elevation," *Electronics Letters*, July 23, 1970.
2. Croft, "The Interpretation of HF Sweep-Frequency Backscatter Soundings to Deduce the Structure of Localized Ionospheric Anomalies," Radio Science Lab, Stanford University, *Tech Report 116*, December, 1967.
3. Sweeney, "Spatial Properties of Ionospheric Radio Propagation as Determined with Half-Degree Azimuthal Resolution," Radio Science Lab, Stanford University, *Tech Report 155*, June 1970.

HRH



"Wow! Look at that! Night like this really makes a guy want to bounce a signal off the moon."



**the Audio Amateur**  
THE AUDIO AMATEUR is a quarterly for the enthusiast who enjoys hands-on work in building or customizing his audio equipment, or technical savvy about his hi fi gear.

**TYPICAL ARTICLES:** Octave equalizers, Transmission line loudspeakers with 8" to 24" drivers, Electrostatic speakers with a 900 Watt direct drive amplifier, Mixers, preamps, parametric equalizers, stock equipment modifications for Heath and many Dynaco units. Completely tested circuits, construction aids, etched circuit boards, parts sources.

**READERS SAY:** "A hit here at WLWT Television... provided several useful ideas for our engineers" "... Cannot praise you enough for your understanding of just what it is audio enthusiasts with limited know-how yearn to do." "As an audio technician I have found TAA one of the best sources for technical help in the audio field..." *Craig Stark of Stereo Review says: "Those interests of the 'home constructor' The Audio Amateur serves are... absolutely top quality. The magazine is, I think, the only American publication devoted to the really serious audiophile constructor."*

DEPT. H  
P. O. BOX 176,  
PETERBOROUGH  
N.H. 03458 U.S.A.

**the Audio Amateur**

- Check here for free prospectus.  
 I enclose \$9.00 for 4 quarterly issues.  
 I enclose \$25.00 for twelve issues.

NAME \_\_\_\_\_

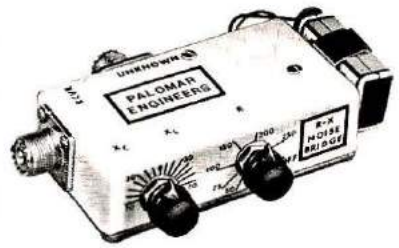
ADDRESS \_\_\_\_\_

CITY \_\_\_\_\_ STATE \_\_\_\_\_

ZIP CODE \_\_\_\_\_

Please allow six weeks for delivery. Rates above are for the U.S.A. only. Rates for other areas available on request.

## R-X NOISE BRIDGE



- ✓ Learn the truth about your antenna.
- ✓ Find its resonant frequency.
- ✓ Adjust it to your operating frequency quickly and easily.

If there is one place in your station where you cannot risk uncertain results it is in your antenna.

The Palomar Engineers R-X Noise Bridge tells you if your antenna is resonant or not and, if it is not, whether it is too long or too short. All this in one measurement reading. And it works just as well with ham-band-only receivers as with general coverage equipment because it gives perfect null readings even when the antenna is not resonant. It gives resistance and reactance readings on dipoles, inverted Vees, quads, beams, multiband trap dipoles and verticals. No station is complete without this up-to-date instrument.

Why work in the dark? Your SWR meter or your resistance noise bridge tells only half the story. Get the instrument that really works, the Palomar Engineers R-X Noise Bridge. Use it to check your antennas from 1 to 100 MHz. And use it in your shack to adjust resonant frequencies of both series and parallel tuned circuits. Works better than a dip meter and costs a lot less. Send for our free brochure.

The price is \$39.95 and we deliver postpaid anywhere in U.S. and Canada. California residents add sales tax.

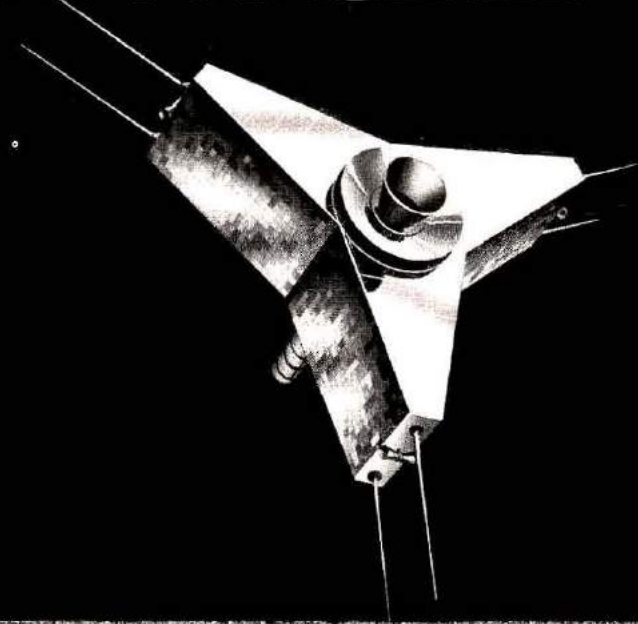
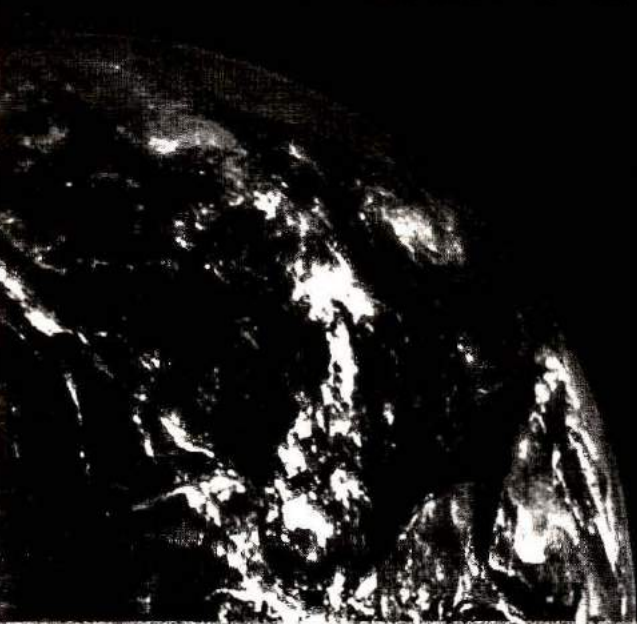
Italy write i2VTT, P.O. Box 37, 22063 Cantu. Elsewhere send \$42.00 (U.S.) for air parcel post delivery worldwide.

Fully guaranteed by the originator of the R-X Noise Bridge. ORDER YOURS NOW!

**PALOMAR ENGINEERS**  
BOX 455, ESCONDIDO, CA 92025  
Phone: (714) 747-3343



# YOU... AND AMSAT PHASE III



An exciting new era in amateur radio is about to begin... the era of AMSAT PHASE III OSCAR satellites.

Many of you are familiar with the benefits of the AMSAT OSCAR satellites, notably OSCAR 6 and 7. These satellites, with a combined total of over 8 years in orbit, have provided communications between amateurs throughout the world. They have also provided a capability for an educational program in space sciences and many interesting experiments.

AMSAT, with members and contributing groups worldwide, and headquarters in Washington, D.C., has been responsible for our current satellite program. Many people feel that perhaps the greatest value of the amateur satellite program is the dramatic demonstration of amateur resourcefulness and technical capability to radio spectrum policy makers around the world.

The value of this aspect of amateur radio as we prepare for the 1979 World Administrative Radio Conference (WARC) is enormous.

The AMSAT PHASE III satellite program promises a continuing demonstration that amateur radio is at the forefront of modern technology. PHASE III satellites will routinely provide reliable communications over paths of up to 11,000 miles (17,600 km) for 17 hours each day. You can think of them as a resource equivalent to a new band.

The cost of these PHASE III satellites is a projected \$250,000. Commercial satellites of similar performance would cost nearly \$10,000,000.

Your help is needed to put these PHASE III OSCAR satellites in orbit.

Your valued, tax-deductible contribution can be as small as one of the 5000+ solar cells needed. A handsome certificate will acknowledge the numbered cells you sponsor for \$10 each. Larger components of the satellites may also be sponsored with contribution acknowledgements ranging to a plaque carrying your name aboard the satellites. Call or write us for the opportunities available.

Your membership in AMSAT is important to the satellite program, and will give AMSAT a stronger voice in regulatory matters concerned with satellites. At \$10 per year or \$100 for life, you will be making a most significant contribution to the satellite program and the future of amateur radio. You will also receive the quarterly AMSAT newsletter.

Clip the AMSAT PHASE III coupon below and send your support today, or call 202-488-8649 and charge your contribution to your BankAmericard (VISA) or Master Charge card.



AMSAT PHASE III  
Radio Amateur Satellite Corporation  
Box 27, Washington, D.C. 20044  
202-488-8649

HRH

YES, I want to support AMSAT PHASE III OSCAR satellites. Enclosed is:

- \$\_\_\_\_\_ in sponsorship of \_\_\_\_\_ solar cells (@ \$10 each)  
 \$10 Annual membership     \$100 Life membership  
 Send information on sponsoring larger satellite components.

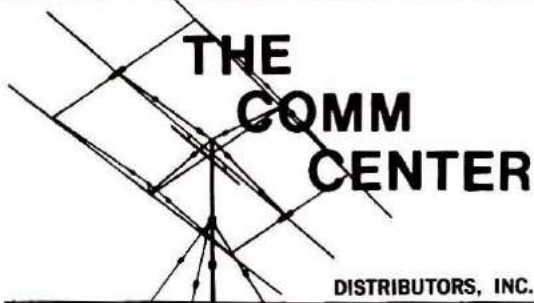
Name \_\_\_\_\_ Call \_\_\_\_\_ AMSAT Member? \_\_\_\_\_

Street \_\_\_\_\_

City \_\_\_\_\_ State \_\_\_\_\_ Zip \_\_\_\_\_

The publisher has donated this space to AMSAT in support of AMSAT and the PHASE III program.





# THE COMM CENTER

COMM CENTER 40 PAGE HAM-LINE CATALOG  
AVAILABLE FOR \$1.00  
(REFUNDABLE WITH FIRST PURCHASE)

TOM W3ZSX  
JIM WA3HQR  
LOUIE WA3YMH  
STAN WB3CJI  
DOUG WB3ECZ

DISTRIBUTORS, INC.

9624 FT. MEADE RD. LAUREL, MD. 20810

AREA CODE 301 - WASHINGTON 953-9535 - BALTIMORE 792-0600

## AMERICAN MADE **SOLID** STATE-OF-THE-ART



by **TEN-TEC**



76th  
Edition

### ARRL Radio Amateur's LICENSE MANUAL

Just released! Brand new completely restyled, rewritten and updated version of the popular ARRL License Manual. New 8½" x 11" format — over 3 times more copy than 75th edition.

Now written in a conversation style with multiple choice questions similar to FCC exam for Tech, General, Advanced and Extra. Study guide provided for Novice. Most up-to-date compilation of rules and regulations — a must for every active Amateur.

Order AR-LG2

\$3.00



GREENVILLE, NH  
03048

## NEW VISUAL CODE READER AND ELECTRONIC KEYS



Works with any keyer, including squeeze keyer in speeds from 7 WPM to 40 WPM. Both in a single unit.  
Model CR101EK  
\$249

from **ATRONICS**

- Display letters, numbers, and commonly used punctuation visually as Morse Code signal is received.
- Operating speed 5 to 50 WPM at selected speeds.
- All Solid State
- Makes code learning faster and easier.
- A single connection to your receiver or transceiver speaker puts it into operation.
- Hard copy read-out of CW available with TU-102 TTY interface Module accessory.

Our popular, lowest priced CODE READER KIT

Model KCR101 ..... \$149

Ready made CODE READER... Model CR101 ..... \$225

BUY FACTORY DIRECT & SAVE! SEND FOR FREE LITERATURE.

USE YOUR BANKAMERICARD OR MASTER CHARGE

P.O. BOX 77 ESCONDIDO, CA 92025 (714) 746-1971

# Atronic



# QA

## QUESTIONS & ANSWERS

*Logs, forbidden practices, operating courtesy, and Q signals*

BY THOMAS McMULLEN, W1SL

If this section about Rules and Regulations seems to go on forever, let me assure you that it really *does* have an end to it. I have spread it over several installments because it is important to cover it thoroughly. These rules are the "Freedom Foundation" of amateur radio, and knowledge of them will play a large part in your passing the exam; your adherence to them will assure that amateurs will continue to enjoy the freedom that we now have.

However, things are going to become more interesting. I'll tell you how your receiver can be used, or modified, to find a spot in a crowded band, and what you should do if someone accidentally drops in on the frequency you are using. Also, what do you know about broadcasting music from an amateur station? Hang in there, and I'll tell you about it.

### Station logs

Amateurs who are starting this wonderful hobby today are among the most lucky people that I know of — deregulation is making life so much easier for them. For example, logging requirements are greatly relaxed today as compared to a few years ago. My old logbooks contain page after page of entries that are no longer necessary — every CQ

was entered, along with a notation (nil) that no one answered, and equally as many pages are filled with callsigns of station called who didn't answer, or they talked to someone else. You only have to keep logs for one year following the last entry (97.105), of course, but I like to hang on to them for reference to stations that I knew and worked at one time (and as a reminder of how things were before deregulation).

Here's the section of FCC Rules concerning logging:

#### 97.103 Station log requirements

An accurate legible account of station operation shall be entered into a log for each amateur radio station. The following items shall be entered as a minimum:

(a) The call sign of the station, the signature of the station licensee, or a photocopy of the station license.

(b) The locations and dates upon which fixed operation of the station was initiated and terminated. If applicable, the location and dates upon which portable operation was initiated and terminated at each location.

(1) The date and time periods the duty control operator for the station was other than the station licensee, and the signature and primary station call sign of that duty control operator.

(2) A notation of third party traffic sent or received, including names of all third parties, and a brief description of the traffic content. This entry may be in a form other than written, but one which can be readily transcribed by the licensee into written form.

(3) Upon direction of the Commission, additional information as directed shall be recorded in the station log.

(c) The log of a remotely controlled station shall have entered the address for each control point and a functional block diagram and a technical explanation sufficient to describe the operation of the control link. Additionally, the following shall be entered.

(1) Description of the measures taken for protection against access to the remote station by unauthorized persons.

(2) Description of the measures taken for protection against unauthorized station operation, either through activation of the control link or otherwise.

(3) Description of the provisions for shutting down the station in case of control link malfunction.

(4) Description of the means provided for monitoring the transmitting frequencies.

(5) Photocopies of all control station licenses and all auxiliary link station licenses.

(d) When a station has one or more associated stations, i.e., control station and/or auxiliary link station, a system network diagram shall be entered.

(e) The log of a control station or an auxiliary link station shall have the following information entered:

(1) A system network diagram for each system with which the station is associated.

(2) The station transmitting band (s).

(3) Description of the means provided for monitoring the transmitting frequencies.

(4) The transmitter power input and justification that such power is in compliance with 97.67 (b).

(5) If an auxiliary link station is being operated by remote control, all of the information required by paragraph (b) of this section shall also be entered.

(f) Notwithstanding the provisions of 97.105, the log entries required by paragraph (c), and (d), and (e) of this section shall be retained in the station log until such time as they are amended.

#### 97.105 Retention of logs.

The station log shall be preserved for a period of at least 1 year following the last date of entry and retained in the possession of the licensee. Copies of the log including the sections required to be transcribed by 97.103, shall be available to the Commission for inspection.

You need to be concerned with sections 97.103 (a), (b), (c), and 97.105 as a novice-



station operator. The other sections will be of interest after you obtain a higher grade of license and become associated with a repeater or other remotely controlled station.

A short explanation of some of the sections might help a bit here, although most of the language is pretty clear. Simply stated, you must make an entry in your log when you first put the station on the air, and again if you make any major changes, like moving, operating portable at a fixed location for a while, or if someone else is operating your station. If you handle messages you must keep a record of them, either in written form or on a recording of some sort. If you use a tape recorder, or other non-written form of log, you must be prepared to transcribe it for a representative of the FCC when he requests it.

These are the FCC requirements for log keeping, but most of the more experienced amateurs go a lot further than that. A log of every contact is indispensable if you are after some of the many awards available to amateurs. Additionally, a neat and complete log is a mark of a careful and thoughtful operator, and can be very valuable in case of any question about what you were (or were not) doing at a particular time. For instance, suppose that you get word that one of your neighbors experienced TVI a couple of nights ago. Your log can prove that you were not on that evening, and the more complete the log is, the more believable it is to an outsider. It could help you to track down the cause of TVI in case you were on the air — it would tell you what band you were operating, etc., and give you a starting point to look for the problem. If you think of all the things that you could do with a complete log, you'll see that there are many common-sense reasons beyond the FCC requirements for logging — which is the way it should be.

## Prohibited practices

Well, you knew it would happen, sooner or later — a list of things that you cannot do, right? But, really, when you look at the things that you *can* do, it's not all that bad. Besides, most of the forbidden territory is just plain common sense protection for amateurs and their frequencies, so here's the list:

### 97.112 No remuneration for use of station

(a) An amateur station shall not be used to transmit or receive messages for hire, nor for communication for material compensation, direct or indirect, paid or promised.

(b) Control operators of a Club Station may be compensated when the club station is operated primarily for the purpose of conducting amateur radiocommunication to provide telegraphy practice transmissions intended for persons learning or improving proficiency in the International Morse Code, or to disseminate information bulletins consisting solely of subject matter having direct interest to the Amateur Radio Service provided:

(1) The station conducts telegraphy practice and bulletin transmission for at least 40 hours per week;

(2) The station schedules operations on all allocated medium and high frequency amateur bands using reasonable measures to maximize coverage.

(3) The schedule of normal operating times and frequencies is published at least 30 days in advance of the actual transmissions. Control operators may accept compensation only for such periods of time during which the station is transmitting telegraphy practice or bulletins. A control operator shall not accept any direct or indirect compensation for periods during which the station is transmitting material other than telegraphy practice or bulletins.

### 97.113 Broadcasting prohibited.

Subject to the provisions of 97.91, an amateur station shall not be used to engage in any form of broadcasting, that is, the dissemination of radio communications intended to be received by the public directly or by the intermediary of relay stations, nor for the retransmission by automatic means of programs or signals emanating from any class of station other than amateur. The foregoing provisions shall not be construed to prohibit amateur operators from giving their consent

to the rebroadcast by broadcast stations of the transmissions of their amateur stations, provided, that the transmissions of the amateur stations shall not contain any direct or indirect reference to the rebroadcast.

### 97.114 Third party traffic.

The transmission or delivery of the following amateur radiocommunication is prohibited:

(a) International third party traffic except with countries which have assented thereto;

(b) Third party traffic involving material compensation, either tangible or intangible, direct or indirect, to a third party, a station licensee, a control operator, or any other person.

(c) Except for an emergency communication as defined in this part, third party traffic consisting of business communications on behalf of any party. For the purpose of this section business communication shall mean any transmission or communication the purpose of which is to facilitate the regular business or commercial affairs of any party.

### 97.115 Music prohibited.

The transmission of music by an amateur station is forbidden.

### 97.116 Amateur radiocommunication for unlawful purposes prohibited.

The transmission of radiocommunication or messages by an amateur radio station for any purpose, or in connection with any activity, which is contrary to Federal, State, or local law is prohibited.

### 97.117 Codes and ciphers prohibited.

The transmission by radio of messages in codes or ciphers in domestic and international communications to or between amateur stations is prohibited. All communications regardless of type of emission employed shall be in plain language except that generally recognized abbreviations established by regulation or custom and usage are permissible as are any other abbreviations or signals where the intent is not to obscure the meaning but only to facilitate communications.

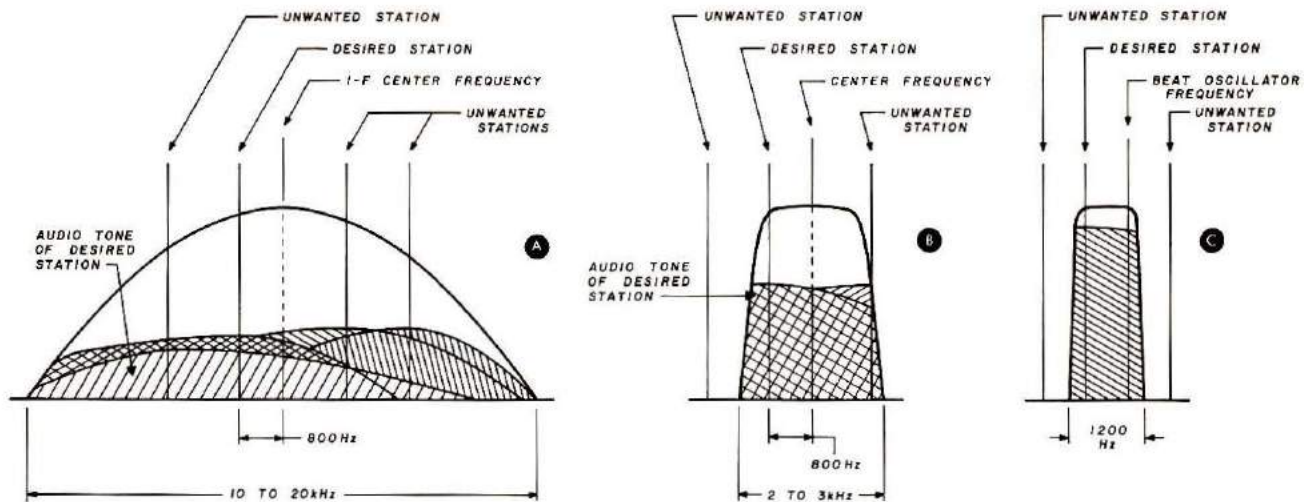
### 97.119 Obscenity, indecency, profanity.

No licensed radio operator or other person shall transmit obscene, indecent, or profane words, language, or meaning.

### 97.121 False signals.

No licensed radio operator shall transmit false or deceptive signals or communications by radio, or





**Fig. 1.** A receiver with poor selectivity in the i-f stages can give you the impression that the band is crowded with signals, as shown at **A**. The beat-frequency oscillator (BFO) is near the i-f center frequency, and it heterodynes with the desired signal and with the unwanted ones as well. This produces several tones, which can all be heard at once. By using more selectivity (improved circuits) in the i-f, **B**, some of the unwanted stations are placed outside the bandpass (window), and you do not hear them. Receivers with very good filters in their i-f amplifiers provide a narrow slice of frequencies and a window with steep skirts, **C**. This further reduces the number of signals that are heard at any one time, allowing you to hear just one station, or lets you find a "hole" in the band to operate in. Some high-performance receivers have filters that pass a slice of the band that is only 200 Hz wide, or may have additional filtering in the audio circuitry which will eliminate unwanted signals that are very close to the desired one.

any call letter or signal which has not been assigned by proper authority to the radio station he is operating.

**97.123 Unidentified communications.**

No licensed radio operator shall transmit unidentified radio communications or signals.

**97.125 Interference**

No licensed radio operator shall willfully or maliciously interfere with or cause interference to any radio communication or signal.

**97.126 Retransmitting radio signals.**

No amateur radio station, except a properly licensed repeater station, auxiliary link station, or a remotely controlled station may automatically retransmit the radio signals of other amateur radio. A remotely controlled station, other than a remotely controlled repeater station or auxiliary link station, may retransmit only the radio signals of auxiliary link stations shown on the station system network diagram.

**97.127 Damage to apparatus.**

No licensed radio operator shall willfully damage, or cause or permit to be damaged, any radio apparatus or installation in any licensed radio station.

**97.129 Fraudulent licenses**

No licensed radio operator or other person shall obtain or attempt to obtain, or assist another to obtain or attempt to obtain, an operator license by fraudulent means.

Let's skim through those

with a brief explanation of what they are intended to do. The first one, **97.112**, is there to maintain the amateur image and status as a non-profit service, and to protect the commercial services and the amateur service from each other. There are plenty of businesses in the world that handle messages for pay, and they have paid operators at their stations. They don't need an amateur station competing with them, and amateurs do not need business organizations competing with them for either frequencies or people. However, you'll notice that there is an exception made for the operation of a bona fide club station that is conducting code classes or transmitting information that is valuable to radio amateurs. Without this provision it would be very difficult for any large group or club to help newcomers on a reliable basis. Volunteer help has a habit of sometimes not being there when needed.

The prohibition against broadcasting is, again, a protection of the amateur frequencies, and a protection of commercial stations against amateur competition. Part of

this was also covered in my discussion of one-way transmissions in last month's *Questions and Answers* session. That's the provision for remote control of models, emergency operations round-tables, and code practice. It was covered in sections **97.91** and **97.99**. The transmission of music is much the same as broadcasting and one-way transmissions, and accordingly is prohibited as an undesirable thing to do. Throughout all of this list of things that amateurs cannot do, remember that when the radio frequencies were being sliced up for the different services there were (and still are) a lot of business-radio and broadcast people who were very jealous of *their* slice of the pie and the profits that they could see there. The planners had to go all out to assure these other interests that the amateurs were not going to encroach on their territory and profits. So if some of the rules and prohibitions seem to belabor the same point, it's because the planners wanted to be sure that the roles of the different services were clear and understood.



# STILL UNDER \$500

DO YOU KNOW  
OF ANOTHER  
FULL POWER, FULLY  
ASSEMBLED,  
HF TRANSCEIVER  
STILL UNDER \$500?  
WE DON'T!



BUT DON'T LET THE LOW PRICE FOOL YOU. THE TEMPO ONE'S QUALITY AND RELIABILITY HAVE BEEN PROVEN BY THE TENS OF THOUSANDS IN USE BY GENERAL AND ADVANCED CLASS AMATEURS.

AND NOW UNDER THE NEW FCC REGULATIONS THE TEMPO ONE BECOMES THE PERFECT RIG FOR THE NOVICE AND TECHNICIAN CLASS.

Ask any of the thousands of owners about its dependability, look at its features and specifications...and the reasons for its unparalleled popularity will be obvious.

**FREQUENCY RANGE:** All amateur bands 80 through 10 meters,  
**MODES OF OPERATION:** SSB upper and lower sideband, CW and AM.

**SOLID STATE VFO:** Very stable Colpitts circuit

**RECEIVER OFFSET TUNING (CLARIFIER):** Provides  $\pm 5$  kHz. variation of receiver tuning when switched ON.

**FREQUENCY STABILITY:** Less than 100 cycles after warm-up, and less than 100 cycles for plus or minus 10% line voltage change.

**INPUT POWER:** 300 watts PEP, 240 watts CW

**AF BANDWIDTH:** 300-2700 cps  
**RECEIVER SENSITIVITY:**  $1/2 \mu\text{v}$  input S/N 10 dB  
**AGC:** Fast attack slow decay for SSB and CW.  
**SELECTIVITY:** 2.3 kHz. (-6 dB), 4 kHz. (-60 dB)  
**IMAGE REJECTION:** More than 50 dB.  
**AUDIO OUTPUT:** 1 watt at 10% distortion.  
**AUDIO OUTPUT IMPEDANCE:** 8 ohms and 600 ohms  
**TUBES AND SEMICONDUCTORS:** 16 tubes, 15 diodes, 7 transistors  
**ANTENNA IMPEDANCE:** 50-75 ohms  
**CARRIER SUPPRESSION:** -40 dB or better  
**SIDE BAND SUPPRESSION:** -50 dB at 1000 CPS  
**THIRD ORDER INTERMODULATION PRODUCTS:** -30 dB (PEP)  
TEMPO "ONE" TRANSCEIVER ..... \$399.00  
AC/ONE POWER SUPPLY ..... \$ 99.00  
TEMPO VF/ONE External VFO ..... \$109.00  
CW FILTER KIT ..... \$ 46.00



### Tempo RBF-1 Wattmeter

An inexpensive, in-line Wattmeter and SWR bridge for use with any transceiver, transmitter, or amplifier from 1.9 to 150 MHz. Test and tune for maximum output or for monitoring on-the-air performance.

Allows selection of wattmeter scales of 0-200 watts or 0-2000 watts. Insures consistent, efficient transmitter operation.

As with all Tempo equipment, the RBF-1 delivers performance value far beyond its price. Only \$42.95



### Tempo DM-20 Desk Mike

Features PTT and LOCK switches. Converts easily to high or low impedance (600 or 50k ohm). Only \$39.00

Prices subject to change without notice.

AVAILABLE AT SELECT DEALERS THROUGHOUT THE U.S.

## Henry Radio

11240 W. Olympic Blvd., Los Angeles, Calif. 90064

213/477-6701  
931 N. Euclid, Anaheim, Calif. 92801  
714/772-9200  
Butler, Missouri 64730  
816/679-3127



Third-party traffic is a subject that you'll hear discussed many times, and is something that you'll become more aware of when you obtain a higher-class of license and operate in the phone portions of the amateur bands. Many countries prohibit third-party traffic entirely. Here's an easy rule that will help you remember what third-party traffic is all about: you are the first party; the station you are talking to is the second party; anyone else is a third party.

There are a few countries that permit third-party messages when the messages are of a nature that would not make it worthwhile to use overseas telephone or telegraph services, and you'll find a list of them in **Table 1**. The list changes from time to time, as countries enter into agreements with the United States. You can keep up-to-date on their status by watching the ARRL publication *QST*, or you can send a stamped, addressed envelope to American Radio Relay League, 225 Main Street, Newington, Connecticut 06111, and ask for the current list of third-party countries.

It's about time for a sample question:

**Amateur stations can transmit**

- (a) codes and ciphers
- (b) music
- (c) false signals
- (d) indecent language
- (e) none of the above

If you marked (e) as correct, that shows that you have been paying attention. Good going!

There are only a couple of small parts of the Rules and Regulations section left to talk about, but I'll let those wait until next month. It's time to switch to a more interesting side of amateur radio — it has to do with what you will be sending and receiving when you put your station on the air and really start making contacts with other amateurs.

### Operating procedures

This is an essential section of the exam, even if it is not specifically covered in the FCC

Rules and Regulations. It covers some things that we should do without being reminded, and others that are accepted practice to the old-timer, but are a mystery to the newcomer. At the top of the list is *courtesy*; it is just as important here as it is in other parts of our life. There are a lot of other amateurs who will be near your frequency, and there may be some that seem to be exactly on the frequency you pick. The courteous thing to do is try to find a spot that is less crowded; if all else fails, wait until they get through. Then, too, you can listen for a break in their conversation and ask if you may join them. Some interesting round-table sessions are started this way, with each sending in turn. These can get unwieldy, however, and if the average code speed of the members is low, it takes considerable time to complete the circuit. For this reason, round-table

**Table 1.** Third-party-message agreements are currently in effect between the United States and the following countries.

Argentina	Haiti
Bolivia	Honduras
Brazil	Israel
Canada	Jordan
Chile	Liberia
Colombia	Mexico
Costa Rica	Nicaragua
Cuba	Panama
Dominican Republic	Paraguay
Ecuador	Peru
El Salvador	Trinidad & Tobago
Guatemala	Uruguay
Guyana	Venezuela

The traffic must be of a nature that would not normally be sent by existing communications systems. Additionally, Canada will permit messages to be handled from remote points that are not connected to the normal communications network, but they must be placed in that network at the nearest point for handling. With the exception of Peru, all the countries listed will permit handling messages concerned with the safety of life and property in emergencies.

contacts are more popular on phone.

Almost hand in hand with courtesy is frequency selection. The first thing is to pick a band that will get signals to the area you want to contact at the particular time of day or night. You can determine what band you need by studying about propagation (which I talked about in part two of this series, October, 1977, *Ham Radio Horizons*), or by listening to the various bands to see where the loudest signals are coming from.

After you have decided which band to use, then you must look for a clear spot to operate in. At this point let me say that your receiver can fool you. Each receiver has a characteristic called selectivity. This refers to its ability to separate one signal from another. **Fig. 1** shows some response curves for receivers with different degrees of selectivity. The most simple receivers will hear signals that are several kHz away from the frequency you want to listen to. Better receivers have good filters in their i-f systems, which will restrict the band of frequencies that pass through to the detector stage. The really good receivers can be equipped with a filter that allows only signals in a 100-hertz wide segment of the band to be heard. This degree of selectivity is used most often by operators who go all out in contest operation, or who need to copy weak DX through a lot of interference. Some of the less expensive receivers available today have an audio filter that will help reduce the number of signals that you hear at any one time. Filters of this type are available as accessories and can be added to your receiver to improve its performance.

The point of the whole thing about selectivity is, if your receiver does not have a good filter, you will hear a lot of signals all at the same time, and will have trouble finding a clear spot to use. A good filter

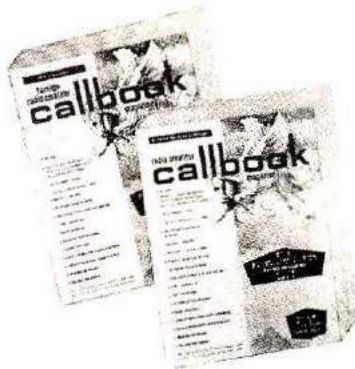


allows you to find holes between the hundreds of other stations on the band.

Along with using common-sense courtesies, and finding a frequency that is not in use, you should realize that no one has a permanent claim to any frequency on any amateur band. This point is emphasized by the FCC when they grant you a license. You are given permission to use any frequency within a designated band of frequencies, but no one spot is yours exclusively.

Always remember that, because of propagation conditions, you may not hear all that is happening on a given frequency. You might find what appears to be an unoccupied spot and decide to call CQ there. You could land on top of a contact already in progress, but you couldn't hear the station that was sending at the moment. If this happens, the station who was listening at the time might call you and ask you to move (please QSY). He's not claiming that frequency for his own; he is simply saying, "Hey, we have a conversation going here, and you are making it hard for me to hear the other guy." Of course, you have the privilege of doing the same thing if someone lands on top of you while you are in the middle of a QSO. The watchwords are "always listen first."

It seems that I've just gotten started on the operating procedures part and it's time to end this segment. There are some interesting things available for the next installment — like Q-signals, operating signs and abbreviations, and (I promise) the last two items under Rules and Regulations: notices of violation, and license eligibility. Meanwhile, if you get restless, go back and review some of the sections I have already talked about. Try your hand at making up some questions — wouldn't you be surprised if you found one on the exam just like one you made up! **HRH**



**There's  
nothing  
like it !**

RADIO AMATEUR  
**callbook**

*Respected worldwide as  
the only complete authority  
for radio amateur  
QSL and QTH information.*

The **U. S. Callbook** has nearly 300,000 W & K listings. It lists calls, license classes, names and addresses plus the many valuable back-up charts and references you come to expect from the **Callbook**.

Specialize in DX? Then you're looking for the **Foreign Callbook** with almost 235,000 calls, names and addresses of amateurs outside of the USA.

**U.S. Callbook \$14.95**

**Foreign Callbook \$13.95**

Order from your favorite electronics dealer or direct from the publisher. All direct orders add \$1.50 for shipping. Illinois residents add 5% Sales Tax.

RADIO AMATEUR  
**callbook** INC.  
Dept. E 925 Sherwood Drive  
Lake Bluff, Ill. 60044

## TOROID CORES



- ✓ All the popular sizes and mixes.
- ✓ Fast Service. Same day shipment via first class mail or air.
- ✓ No minimum order.

### IRON POWDER TOROIDS:

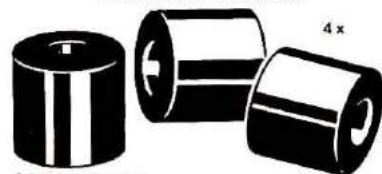
CORE SIZE	MIX 2 5-30 MHz u = 10	MIX 6 10-90 MHz u = 8.5	MIX 12 60-200 MHz u = 4	SIZE OD (in.)	PRICE USA \$
T-200	120			2.00	3.25
T-106	135			1.06	1.50
T-80	55	45		.80	.80
T-68	57	47	21	.68	.65
T-50	51	40	18	.50	.55
T-25	34	27	12	.25	.40

### RF FERRITE TOROIDS:

CORE SIZE	MIX Q1 u = 125 .1-70 MHz	MIX Q2 u = 40 10-150 MHz	SIZE OD (in.)	PRICE USA \$
F-240	1300	400	2.40	6.00
F-125	900	300	1.25	3.00
F-87	600	190	.87	2.05
F-50	500	190	.50	1.25
F-37	400	140	.37	1.25
F-23	190	60	.23	1.10

Chart shows uH per 100 turns.

### FERRITE BEADS:



\$2.00 DOZEN

### WIDE BAND CHOKES



95¢ EACH

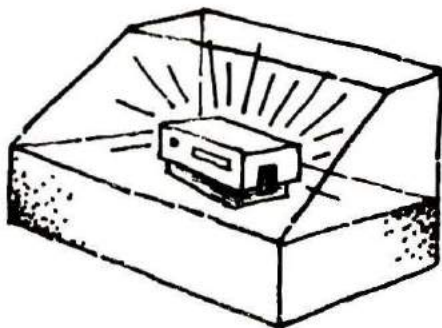
**TO ORDER:** Specify both core size and mix for toroids. Packing and shipping 50 cents per order USA and Canada. Californians add 6% sales tax.

Fast service. Free brochure and winding chart on request.

**PALOMAR  
ENGINEERS**  
BOX 455, ESCONDIDO, CA 92025  
Phone: (714) 747-3343



## PRODUCT



## SHOWCASE

### Hallicrafters Two-meter Equipment



The Hallicrafters Company, of Grand Prairie, Texas, is in the amateur-radio vhf-equipment business with a selection of rigs and antennas that will take care of your needs for either a home station or a mobile unit. They offer two transceivers, two solid-state amplifiers, and four antennas for the two-meter amateur band. Now you can consider a Hallicrafter system, as well as just individual items of equipment.

**Hallicrafters H2M-1000** is an all-mode transceiver that covers the amateur two-meter band in 5-kHz steps with its synthesizer, and allows in-between-channel coverage by means of a VXO circuit. According to information from the manufacturer, the synthesizer is a military type, working on the phase-locked-loop principle. It covers from 144 to 148 MHz, providing 800 channels for operation. The H2M-1000 will work ssb, fm, and CW, and is set up to provide split-frequencies of either 600 kHz or 1 MHz for repeater use, in addition to normal simplex operation on fm. The VXO will allow  $\pm 7$ -

kHz variation in frequency in the ssb and CW modes. Frequency indication is by means of an LED readout.

The power output is better than 10 watts in the high-power mode, with a switch to select a low-power output of 1 watt. The transceiver can be operated from either 117 Vac or 12 Vdc. Two panel meters are provided; one indicates either signal strength or power output, the other monitors discriminator zero during fm use. Some of the operating features include a noise blanker, standard or slow AGC, built in VOX, and receiver incremental tuning (RIT). The H2M-1000 has an internal speaker, with provisions to plug in an external one, plus jacks for headphones and key.

**Hallicrafters H2M-500** is a two-meter mobile fm transceiver, with synthesized frequency selection that allows 5-kHz spacing across the range of 144 to 148 MHz. The unit provides an output of 25 watts, or, at low power, 1 watt. The operating frequency is shown on a 6-digit LED readout. This mobile unit has provisions for simplex operation, or offsets of either 600 kHz or 1 MHz for repeaters. It requires 12 Vdc for operation.

Other features of the H2M-500 are a combination S/Rf meter, protected output transistor, internal speaker, and diode antenna switching for transmit receive functions. There are accessory sockets for an external speaker and autopatch connections. The unit is supplied complete with mounting bracket, quick-release hardware, microphone, and a combination operation and service manual.

**RF Power amplifiers** are included in the amateur vhf equipment bearing the Hallicrafters name. The **PA-250L** is a solid-state, 250-Watt, broadband, linear amplifier for two meters. It will accept drive levels up to 15 watts, to provide an output of 130 to 250 watts on fm; 150 to 300 watts PEP on ssb.

The **PA-120** is also a solid-state amplifier, designed to work with input levels of 20 to 40 watts, resulting in an output of 80 to 120 watts on fm. Both the **PA-250L** and the **PA-120** are designed to be powered by 13.8 Vdc from either a battery or an ac supply.

**Four antennas** are offered by Hallicrafters to take care of the radiating part of amateur two-meter systems. The **HA-700** is a base-station antenna, rated to a power of 500 watts, and featuring 6-dB gain.

The **HA-800** is a 5/8-wavelength mobile antenna that will work across the band of 132 to 174 MHz. It requires a 3/4-inch (2cm) hole for mounting, and is rated to 200 watts.

The **HA-900** antenna is also a 5/8-wavelength mobile whip that will mount either through a 3/4-inch (2cm) hole or on a trunk lid. It covers the range of 144 to 148 MHz, with a power rating of 200 watts.

A magnetic mobile mount is offered in the Hallicrafters model **HA-985**. It also is a 5/8-wavelength whip rated to 200 watts.

This new line of equipment from Hallicrafters makes it possible for an amateur to equip his home station and his car with a complete system that was designed by one of the oldest names in amateur radio. They are giving the amateur fraternity the benefit of their considerable expertise in developing and building equipment for commercial and military users on a world-wide basis. The combination of modes available with this equipment will definitely increase the enjoyment that amateurs can derive from vhf operation.

For more information about the Hallicrafters amateur vhf equipment, write to The Hallicrafters Company, 2501 Arkansas Lane, Grand Prairie, Texas 75051. You can also contact any of the several authorized Hallicrafters dealers nationwide, or use *ad check* on page 78.



## Tower Donated to University



Dr. Robert E. Kennedy (right), president of California Polytechnic State University, received a radio antenna tower gift from Tri-Ex Tower Corporation President Frank Clement (left) during a brief campus ceremony (photograph courtesy California Polytechnic).

A new telescoping antenna tower, donated by an alumnus, is expected to extend the range of the amateur radio station operated by students at California Polytechnic State University in San Luis Obispo.

The 80-foot (24 meter) tower, valued at \$3,000, is a gift of Frank Clement of Visalia. Mr. Clement is president of Tri-Ex Tower Corporation and a founder and board chairman of High Voltage Devices, Inc.

Designed so it can be raised by an electric motor when being used and lowered when not in use, the new tower has been installed on the patio of the Engineering East Building on the university campus. It replaces a stationary 25-foot (7 meter) tower which has been on the roof of the Engineering East Building for the past 20 years.

Edward J. Clerkin, advisor to the Cal Poly Amateur Radio Club and a member of the university's electrical engineering faculty, said the telescoping tower

should extend the range of W6BHZ, the club's ham station, beyond its present range. "We regularly talk with ham operators in South America and Japan, and the additional height should get us well beyond that. We won't know how much until we can run some tests," Clerkin added.

Licensed since 1948, the Cal Poly station has a medium-power transmitter. It has used a three-band beam antenna at an elevation of 45 feet (13m) since its former antenna was replaced in 1974. The three-band antenna placed atop the new telescoping tower will get the station's signal above nearby university

# TEST REPORT



## ALPHA 374

It's a no tune-up power house... and the fine print is on your side

You could safely load your ALPHA 374 to a full KW, lay a brick on the key, and leave town for the weekend. It's built to take it. Every ALPHA linear amplifier, from the moderately priced ALPHA 76 rock-crusher to the most deluxe models, is engineered and built for continuous "brick on the key" service.

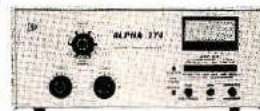
Contests, dxing, and lots of rag chews are just about as demanding as a brick on the key. Wouldn't it be great to own an ALPHA and know that the fine print clearly says "maximum legal power in all modes with no time limit?"

When you go ALPHA you forget about duty cycle limits. You forget about service hassles, too. The line print in ETO's 18 month factory

warranty protects you six times as long as most guarantees!

Flip the bandswitch and instantly your ALPHA 374 is ready to deliver QRM—piercing maximum legal power—even on RTTY and SSTV—10 thru 80 meters. The ultra convenient ALPHA 374 needs no tune-up in normal amateur service, and it's quickly set up for MARS or other special operation by simply switching to the auxiliary manual tune controls. Put your signal on top with

ALPHA POWER. Contact your dealer, or Ray Heaton at ETO for literature on all ALPHA's. And ask for a copy of "Everything You Always Wanted to Know About (Comparing) Linears... But Didn't Know Whom to Ask."



Regardless of what transmitter you're using, for an even bigger signal the new ALPHA/VOMAX split band speech processor can boost your SSB talk power as much as ten times when you



need it most, for just \$179.50. Like the ALPHA linears, VOMAX is exceptionally low in distortion, compatible with all popular exciters, and easy to install and use.

ALPHA: Sure you can buy a cheaper linear... But is that really what you want?

**ETO** Ehrhorn Technological Operations, Inc.

P.O. Box 708 Industrial Park · Canon City, Colorado 81212 · (303) 275-1613



buildings and should provide some additional range.

Clement, who completed his studies in electrical engineering at Cal Poly in 1937, and then graduated from University of California at Berkeley, is an amateur radio operator (W6KPC) who parlayed his interest in electronics into a significant role in the nation's space program.

Before organizing Tri-Ex Tower and High Voltage Devices, he spent several years with Hughes Aircraft Company in its development laboratories and then became the first employee of Ramo-Wooldridge Corporation (now TRW) when it was organized in the early days of the space program.

Tri-Ex Tower Corporation is among the nation's largest manufacturers of guyed, free standing, and telescoping towers.

## RF Clipper



Holdings Photo Audio Center in Blackburn, England has just announced a new rf clipper designed specifically for the Yaesu FT-200 transceiver (also known as the Sommerkamp FT-250 in Europe, and the Tempo One in the United States).

The rf clipper, designed by G3LLL, was originally developed for the Yaesu FT-101 and enjoyed enormous success. Now, it has been tailored for use with the Tempo One, and may be installed without drilling any holes. The all-fet design uses dual stage, low-level, low-impedance clipping and may be adjusted for maximum effectiveness on *both* receive and transmit. The *receive* gain may be independently set to give an increase in received signal of up to two S units. An extra side-

band filter improves adjacent-channel selectivity and enhances agc action.

On *transmit*, the new clipper is said to provide up to six times more effective power, but should be used with a microphone having a sharply rising response characteristic — such as the Shure Model 444. To the station on the other end of your two-way QSO, the effect is as if you had turned on a linear amplifier.

The G3LLL rf clipper is attractively packaged to complement the appearance of the Tempo One, and will retail for under \$100. Further information may be obtained from Holdings Photo Audio Centre, Mincing Lane, Darwen Street, Blackburn, England BB2 2AF.

## New Motorola HEP Catalog

Motorola's HEP semiconductors are offered as replacements for over 60,000 different discrete devices and ICs. Intended for, but not limited to, the hobbyist, experimenter, and the professional service-technician/dealer, Motorola HEP products are specified to *meet* or *exceed* the important mechanical and electrical characteristics of the replace device. In many cases, one HEP device will be recommended as the replacement for a large number of components. Because of this broad scope, the HEP device specifications will often exceed some of the specifications of the replaced devices. For example, a HEP device that replaces a series of transistors whose individual  $BV_{CEO}$ 's range from 20 V to 80 V would have a  $BV_{CEO}$  specification of 80 V.

Because Motorola is not responsible for the design of the circuits in which HEP products are installed, and because the HEP device parameters may exceed the original, Motorola Semiconductor Products, Inc., does not guarantee that the HEP device will perform *exactly* as the original device. However, the

availability of this vast array of potential replacement devices, through a large, national, network of retail outlets, (over 1500) can offer a considerable savings of time or money, or both, to the hobbyist and the professional technician, alike.

This 184-page book describes discrete silicon and germanium power transistors, thyristors, small-signal FETs and bipolar transistors, CB rf power transistors, zener diodes, rectifiers, and opto-electronic devices. Digital ICs, in RTL, HTL, DTL, TTL, and CMOS technologies, are also included as well as linear bipolar radio/television ICs, voltage regulators, and op-amps.

One hundred and ninety-eight new products have been added to the Catalog; 104 are newly offered TTL functions. The TO-220-packaged components, popular in industry, are also included. A single chip,  $3\frac{1}{2}$  digit voltmeter IC, that utilizes CMOS technology to provide both linear and digital circuit functions, is also described. The *Catalog* also describes the Educator II Microcomputer which is based on the popular M6800 technology.

The price of this new *Motorola HEP Semiconductor Cross Reference Guide and Catalog* is \$2.00; it is available from HEP/MRO Operations Headquarters and HEP distributors. For further information, please contact Motorola HEP/MRO National Sales Manager, 705 West 22nd Street, Tempe, Arizona 85282; or use *ad check* on page 78.

## Ten-Tec Triton IV Digital Transceiver



All of the good features of the Triton IV appear in the Triton IV *digital*, with the added benefits of a built-in digital frequency



display, plus a new zero-beat switch.

The Model 544, as the Triton IV digital transceiver is known, incorporates a six-digit display with 0.43-inch (11mm) high numerals in red, except for the least significant digit (hundreds of Hz) which is in green.

The frequency-counter circuit was the latest large-scale integrated circuit available for this function, and CMOS medium-scale ICs for the remaining requirements.

All crystal-tolerance deviations in the vfo mixer oscillators are accounted for in the final reading since the counter is fed from the vfo output. The remaining error from the carrier oscillator is adjusted out by setting the time-base gating oscillator while receiving WWV, assuring band-to-band accuracy.

When used with Ten-Tec's Model 242 remote vfo, the display indicates the vfo in use at the time, whether it be the internal or the remote vfo.

The Model 544 has incorporated a zero-beat switch on the rf control. By pulling the knob out, engaging the switch, it is possible to zero beat an incoming CW signal, putting the transmitter on exactly the same frequency. This eliminates the need to tune to a 750-kHz beat note, as in the case with the Triton IV.

Specifications for the digital Model 544 are identical with those for the Model 540 Triton IV, with these exceptions and additions:

Frequency accuracy:	± 200 Hz
Receiver power required:	12-14 volts dc, @ 1 ampere
Semiconductors:	1 LSI; 19 ICs; 63 Transistors; 33 diodes

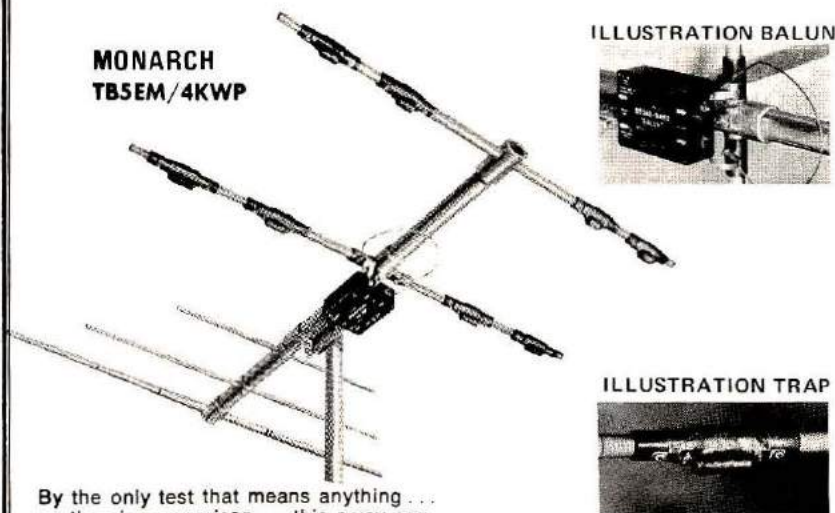
Zero-beat switch on rf control.  
No crystal calibrator included (or necessary).

The suggested Amateur Net Price is \$869. For additional information, write Ten-Tec, Inc., Sevierville, Tennessee 37862, or use *ad check* on page 78.

# STEP UP TO TELREX

## Professionally Engineered Antenna Systems

### Single transmission line "TRI-BAND" ARRAY



**MONARCH  
TB5EM/4KWP**

ILLUSTRATION BALUN



ILLUSTRATION TRAP



By the only test that means anything... on the air comparison... this array continues to outperform all competition... and has for two decades. Here's why... Telrex uses a unique trap design employing 20 HiQ 7500V ceramic condensers per antenna. Telrex uses 3 optimum-spaced, optimum-tuned reflectors to provide maximum gain and true F/B Tri-band performance.

For technical data and prices on complete Telrex line, write for Catalog PL 7



**Save  
time  
and  
energy**

the easy way — just call  
**TOLL FREE**  
**800-258-5353**

to order books from Ham Radio's Communications Bookstore and subscriptions to Amateur Radio's best publications, Ham Radio HORIZONS, HAM RADIO Magazine and HR Report.

**SAVE MONEY TOO!**  
5% discount plus Free Shipping on orders of \$35 or more.

Please use this number to PLACE ORDERS ONLY. To inquire about book orders and subscriptions please write, or call (603) 878-1441.



GREENVILLE  
NH 03048

**We're Amateur Radio's Book People!**

## SPECIALS



**\$245.00**

**ICOM IC-22S**



**\$199.00**

**CUSHCRAFT ATB-34**

**Factory Authorized**

- DRAKE • TEN-TEC • ICOM
- KLM • CUSHCRAFT • HYGAIN
- SWAN • MFJ • DENTRON
- NYE VIKING • MIDLAND • CDE

**Drake and MFJ  
matchboxes in stock**

**WE DEAL • WE TRADE  
WE DISCOUNT • WE SHIP  
CALL OR WRITE**

**ham-bone  
radio**

LEE  
WA2ACF

ART  
WB2YPP

— Div. of Stereo Repair Shop  
3206 ERIE BLVD. EAST  
SYRACUSE, N. Y. 13214  
315-446-2266



# EVERYTHING YOU NEED TO PREPARE FOR THE NOVICE LICENSE

OUR DELUXE PACKAGE is really outstanding! You are given Ameco's outstanding Radio Amateur Theory Course, the best known book of its type in print today, the Ameco Radio Amateur Q & A guide, the finest way to check your progress plus Ham Radio's own Novice Radio Guide, a complete introduction and how to do it book for the prospective Novice. A super package and a super deal as you save \$6.00 over the total individual list prices.

## DELUXE BEGINNER'S TRAINING PACKAGE

MFJ CPO-555 Code Practice Oscillator	\$15.95
Battery	1.00
Telegraph Key	1.95
ARRL "Tune in the World with Ham Radio"	7.00
Ameco Radio Amateur Theory Course	4.95
Ameco Radio Amateur Q & A Guide	1.00
Ham Radio "Novice Radio Guide"	3.95

Total List Price \$35.80

**SAVE \$6.00**

**YOUR PRICE**

**\$29.95**

Order HR-DBTP

Order Today from

**ham  
radio's  
communications  
Bookstore**



Greenville, NH 03048

## 77/78 AMATEUR RADIO EQUIPMENT DIRECTORY



Here's everything you want to know about Amateur Radio Equipment. Featuring descriptions, specification, prices and pictures. A one stop buying and reference guide to all your amateur needs. The new 77/78 supplement (32 pages) updates the 1977 Edition and brings the total number of pages to 168 (2 volumes). Almost 100 manufacturers/distributors are included. Only \$3.50 (plus postage and handling) for both volumes! Send for your directory today! (The 77/78 supplement is available for \$1.00 postpaid if you have already purchased the 1977 Edition.)

KENMORE CORPORATION, Dept. A  
9 James Avenue  
Kendall Park, N. J. 08824

Please send the 1977/78 AMATEUR RADIO EQUIPMENT DIRECTORY (2 volumes). I'm enclosing \$3.75 (\$3.50 plus 25¢ postage and handling—U.S. only.) Canadian orders \$4.00, Foreign orders \$5.00 (air).

Name/Call \_\_\_\_\_  
Address \_\_\_\_\_  
City \_\_\_\_\_ State \_\_\_\_\_ Zip \_\_\_\_\_

## NEW HAM STATION OR ANTENNA SYSTEM IN THE WORKS?

SSB - FM - AM - CW  
SSTV - RTTY - EME  
OR . . . ?

*Let us HELP you*

As we have helped thousands  
of others, the world over,  
for the past 39 years!

WE CARRY EVERY  
TOP BRAND OF HAM  
AND COMMUNICATIONS GEAR.

**ELECTRONIC DISTRIBUTORS, Inc.**

*Communication Specialists*

1960 Peck St., Muskegon, Mich. 49441  
Tel. (616) 726-3196 Telex 22-8411

## ENERGY CRISIS SOLVED!

Personal energy crisis? Get precious RF on DX target with World Record Breaking antenna that won W6TYP the QRP ARC 1,000,000 miles/watt award.

### THE JOYSTICK VFA

(Variable freq. ant) gives low angle, omnidirectional, harmonic free radiation on all bands 160 thru 10 (+ MARS and receive on all BC & SW).

1000's of glowing reports in our files of the VFA in use, often in poor QTH and/or under QRP., contests, etc.

### SYSTEM 'A' \$75.00

250W P.E.P. &/or Receiving Only

### SYSTEM 'J' \$99.00

500WP.E.P. &/or Improved Q Factor Receive  
Air Mail cost included. (Each system 3 sections easily assembled to make unit 7' 6" long. Matching ATU). Not only will you save space but you will save \$\$\$ at present low exch. rate and by buying direct UK manuf. Rush your order — Mastercharge or check, or ask for brochure.

**PARTRIDGE (HH)  
ELECTRONICS LTD.**

Broadstairs, Kent, England  
Tel. Thanet 62535

**G3CED**

**G3VFA**





**Dear Horizons:**

I have a complaint. Nowhere in my records, files, or the like, do I find that I have ever given permission for you to show or depict my workbench as you have so wantonly done in your July, 1977, issue. I have kept this a closely guarded secret for many years. For you to display it in the manner you have has caused me much embarrassment and mental anguish. I was sure it was unique . . .

**Robert W. Keown, WA3QID  
Wilmington, Delaware**

*Gosh, I used my workbench for the artist's model, and I originally copied it from one that I admired when I was a youngster. Tell me, Bob, who was your shop teacher in High School? Editor*

**Dear Horizons:**

I was disappointed that Ms. Sargent, in writing history "Before Spark" (June, 1977), failed to include my admired Chinese scientist, One Long See Cue. It was he who invented the static eliminator but discarded it as being useless because at that date radio had not yet been discovered.

**Franklin K. Matejka, K5RS  
Kerrville, Texas**

**Dear Horizons:**

May I compliment you on your outstanding publication. Your magazine, plus two or three amateur radio operators in my area, were the prime movers for me to join amateur radio. Your articles are most interesting; the type is easy to read, and more

importantly, it is aimed at that segment of hams who are in their early stages of development in this most marvelous of hobbies.

Your June issue concerning antennas should find its place among other technical literature in most ham libraries. The article, "Working DX — Longpath, Shortpath," by Robert C. Locher, W9KNI, is a great piece of writing and should serve as an inspiration for all future DXers. Kudos to W9KNI.

**Stanley M. Hirsch, WD4DCW  
Norfolk, Virginia**

**Dear Horizons:**

I enjoyed your May issue. The article "A Plan for Morse Code," was very good. At the top of this article you wrote the title in Morse Code. However, the way I read this it says, "A Plan INOR Morse Code." I suppose you have gotten many letters about this, but thought I would add myself to the list. I enjoy Horizons; please keep up the good work.

**Jeff Johnson, WB9WPF  
Indianapolis, Indiana**

*Thanks for the kind words, Jeff. Yes, we have received several letters about that letter F. I have pointed out to our illustrator the difference between artistic spacing and correct Morse Code. Now if I could only do the same for some of the fists I hear on the air from time to time! Editor*

**Dear Horizons:**

I would just like to let you know I subscribe to six different ham magazines and your *Ham Radio Horizons* is my favorite.

Keep up the good work.

**Gerald Jordan, WA1YYX  
West Kingston, Rhode Island**

**Dear Horizons:**

Re your July issue: Ten pages about radio control of model airplanes is, generously speaking, nine pages too many. In a magazine supposedly about and for Amateur Radio I would expect the articles to relate more directly to our hobby.

It's not enough just to say that blank percentage of hams are also

interested in model airplanes. On that basis, why not include a nude centerfold on the assumption that 99 per cent of all hams are also interested in sex!

On the plus side, I enjoyed the antenna article very much, and both receiver articles were excellent. I found your other articles very informative and pertinent to Amateur Radio, as they usually are. Keep up the good work!

**Norman N. Sullivan, WB8VLG  
Scott AFB, Illinois**

*Norm, you are missing the point a bit. The article about Radio Control had two purposes: It gave some people who are now amateurs a bit of insight into something new, but, more importantly, it told some non-hams what they had to gain by joining amateur radio. What's in it for amateur radio? I have seen construction work done by some RC modelers that would put most of our better Extra-Class licensees to shame. We need people like that in ham radio, and in return amateur radio can offer them more space for their segment of the hobby as well as the ability to communicate with other flying enthusiasts anywhere in the world. Admittedly, we need numbers to join amateur radio to help justify its existence, but we cannot ignore the need for quality. Editor*

**Dear Horizons:**

After being licensed for approximately 24 years, I find I am learning all over again. *Horizons* is one of the freshest, most informative things to appear on the ham scene in quite some time. I enjoy every issue and article.

I have one complaint, and that is you are too far ahead with the issues. It is June and I have received, and read from cover to cover, the August issue. Now what am I going to read in August?

Keep up the splendid work.

**F. G. Warsalla, K8MFK  
Port Huron, Michigan**

*In August you can read about October, of course. But don't worry too much about the cover dates; just keep reading and enjoy. If you would like to practice a bit of mind-twisting, try planning for a December issue (and Christmas) during the heat of July! Editor*





- Advance Registration \$14.00 per person; with Hotel Sahara Late Show and two drinks \$28.00 per person or with Hotel Sahara Congo Dinner Show (entree Cornish Hen), no drinks \$35.00 per person. Tax and Gratuity included.
- Entertainment in Hotel Sahara's Congo Room has not been selected at press time.
- Advance Registration must be received by **SAROC** on or before December 22, 1977.

## The NATION'S ANNUAL LAS VEGAS PRESTIGE CONVENTION

# SAROC™

## HOTEL SAHARA'S CONVENTION SPACE CENTER

### January 5-8, 1978

- **SAROC** Registration includes: registration tickets, admission to technical sessions, Friday cocktail party hosted by TRI-EX Tower Corp.; Saturday cocktail party hosted by Ham Radio Magazine; Hotel Sahara Buffet Brunch on Sunday, Tax and Gratuity.
- Hotel Sahara room rate for **SAROC** registered delegates \$22.00 per night plus room tax, single or double occupancy.
- Hotel Sahara room reservation request card will be sent only to **SAROC** registered delegates and exhibitors only until December 22, 1977.



Send your check or money order to **SAROC**, P. O. Box 945, Boulder City, NV 89005





# HORIZONS ad-Scan

**RATES** Regular classified is available at 50¢ per word. Display classified (1 inch deep x 2 1/4 inches wide) is \$50, or at the 12x rate is \$35. All Ad Scan payable in advance. No cash discounts or agency commissions allowed.

**HAMFESTS** Sponsored by non-profit organizations receive one free regular classified ad (subject to our editing). Repeat insertions of hamfest ads pay the standard rate.

**COPY** No special layout or arrangements available. Material should be typewritten or clearly printed (not all capitals) and must include full name and address. We reserve the right to reject unsuitable copy. **Ham Radio** cannot check each advertiser and thus cannot be held responsible for claims made. Liability for correctness of material limited to corrected ad in next available issue.

**DEADLINE** 15th of fourth preceding month.

**SEND MATERIAL TO:** Ad Scan, Ham Radio Horizons, Greenville, N. H. 03048.

**FREE LICENSING CLASSES** in Flushing, NY area. Send inquiries to FRATS (Flushing Radio Amateur Technical Society), 62026 Boelsen Crescent, Rego Park, NY 11374.

**CHRISTMAS GIFT IDEAS FOR "HAMS"** — Executive Desk Set — 2x8" sign in silver desk set w/pens — \$11.75 ppd. 2x8" desk sign w/clear acrylic base — \$5.50 ppd. Sign in your choice of black or woodgrain. Custom ENGRAVED with your call and NAME. The Elbridge Engraver, Box 118, Elbridge, N.Y. 13060. SAME DAY SERVICE!

**SST T-1 RANDOM WIRE ANTENNA TUNER**



All band operation (160-10 meters) with most any random length wire. 200 watt output power capability. Ideal for portable or home operation. Toroid inductor for small size. 3 x 4 1/4 x 2 3/8. Built-in neon tune-up indicator. SO-239 coax connector. Guaranteed for 1 yr., 10 day trial. Compact — easy to use... only \$29.95 postpaid. (Add Sales Tax in Calif.) (213) 376-8887

SST ELECTRONICS, P.O. BOX 1, LAWDALE, CA. 90260

**STOP THIEVES!** Protect your rig with guaranteed slide mount. \$7.95 ppd. Adams H-101, Box 408, Chadron, NE 69337.

**QSL's with class!** Unbeatable quality, reasonable price. Samples, 25¢. QSL's Unlimited, Box 27553, Atlanta, GA 30327.

**AWARD CERTIFICATES**  
Award for Public Service or Emergency Communications Award. Send 2.00 each, event, name and address. FREE Information. 49'er RADIO CLUB, Box 1400-HH, Downey, Calif. 90240.

**TOROIDS** 88 or 44 mH. Same day shipment. 5 for \$3.50 postpaid. Gull Electronics, 12690 Rt. 30, N. Huntingdon, PA 15642.

**HAM EQUIPMENT PRICES TOO HIGH?** I used to feel the same way until I learned how to shop and buy for ham rigs. I'll show you how you can save \$\$\$ on your ham gear and antenna too. It's easy. Send \$3.00 now to: Ham Savings, P.O. Box 4221, Compton, CA 90224.

**PAN AMERICAN HAM JAMBOREE/EXPOSITION**, Ft. Lauderdale, FL, National Guard Armory (State Road 84). October 29 & 30 starting at 12 noon on Saturday to 10 PM. Sunday 9 AM to 5 PM. Talk-in on 31/91 & 52 simplex. Additional information from WA4ZRW (305) 581-2718.

**NORTH CAROLINA QSO PARTY** — from 1900Z Dec. 2 through 0100Z Dec. 4. Suggested frequencies are plus/minus 10 kHz: cw, 3560 7060 14060 21060 28060; Novice, 3720 7120 21120 28120; ssb, 3900 7270 14290 21390 28590. Out-of-state stations transmit RS(T) and state, province or country. NC stations send RS(T) and NC county. Logs must be postmarked no later than Jan. 10, 1978 and sent to: Alamance ARC Inc., 2822 Westchester Dr., Burlington, NC 27215. For additional information write K4EG.

**DELAWARE QSO PARTY** — (4 periods — times in GMT); 0001 - 0600 & 1600 - 2200 Sat. Nov. 12; 0001 - 0600 & 1600 - 2200 Sun. Nov. 13. Exchange: QSO number, RS(T), and QTH. County for Delaware & ARRL Section or County for others. Once per band, per mode for points. CW: 3560, 7060, 14060, 21060, 28160; PHONE: 3975, 7275, 14325, 21425, 28650; NOVICE: 3710, 7120, 21120, 28160. S.A.S.E. to K3YHR for results or certificate.

**MOBILE IGNITION SHIELDING** provides more range with no noise. Bonding strap sale less than 50¢ each. Literature. Estes Engineering, 930 Marine Drive, Port Angeles, Wash. 98362.

**SOCIETY OF WIRELESS PIONEERS** second annual membership on-the-air CW QSO Party, December 17th & 18th for the full GMT period. All members with Amateur licenses are encouraged to call CQ SOWP 55 kHz up from the low end of each Amateur band. Information from Bill Wilmot, K4TF, 1630 Venus Street, Merritt Island, FL 32952.

**MICROCOMPUTER INTERFACING WORKSHOP**, December 8 - 10, 1977. A three-day workshop based on the 8080 and 8085 microprocessors, with over 20 microcomputers available for participant use; and...


**DIGITAL ELECTRONICS FOR AUTOMATION WORKSHOP**, December 6 & 7, 1977. A two-day workshop based on small-scale and medium-scale TTL integrated circuits, with in-depth lectures and individual breadboarding stations. For more information on these workshops, write Dr. Norris Bell, V.P.I. and S.U. Continuing Education Center, Blacksburg, VA 24061, or call (703) 951-6328.

**WEST COAST BULLETIN** edited and transmitted by W6ZF, 9 PM PDT (8 PM PST) (0400 UTC) 3450 kHz, A-1, 22 WPM, FIRST AND THIRD MONDAYS each month. Ten to fifteen items of latest current events of interest to Amateurs, with final few minutes at 25 WPM to help build code speed.

**CODE PRACTICE OSCILLATORS**, hand keys, electronics keyers, other products. Free catalog. Globalman Products, Box 246, El Toro, CA 92630. 714-533-4400.

**VHF CONFERENCE** Western Michigan University will hold its 23rd annual VHF Conference, November 19, 1977. Contact Dr. Glade Wilcox, W9UHF/8, Dept. of Electrical Eng., WMU Kalamazoo, Michigan 49008.

**UR TRIPOLE MULTI-BAND**



All-band antenna. 80 to 6 Meters plus 160' 5 SWL. Bands built in balun. 2 kW PEP rating. No return, tap or trap changes. 80 to 120 ft inverted-V or horizontal. Available in kit form or assembled. Kit T80-K ..... \$54.95 cash PPD in USA. Focus residents add 5% sales tax. Send payment for information on TRIPOLE antenna and feed me key.

Universal Radio Co. Dept. M3  
Box 26041 El Paso, TX 79926  
Telephone (915) 582-1910

**ENGRAVED NAMETAGS** 1 1/2" x 2 1/2" — \$3.00. QTH added \$0.50. Black, blue, red, green, walnut. White letters. Beveled. Locking pin. Other colors available. Tag-it Co., Box 2062, Indianapolis, In. 46206.

**NOV 27 — CARA HAMFEST** Ellicott City Armory, Ellicott City, MD. Exhibits, Flea market, Prizes, Refreshments. All indoors. No tailgating. Talk-in 147.99/39 146.16/76 146.52/52. Info contact CARA, PO Box 850, Columbia, MD 21044.

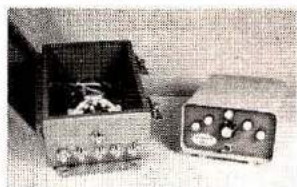
**CADILLAC" of QSL's** — New! Samples: \$1.00 (Refundable) — MAC'S SHACK, Box #1171-G, Garland, Texas 75040.

**1977 ARRL FLORIDA GULF COAST CONVENTION**, Clearwater Beach, November 19 & 20. Sponsored by Florida Gulf Coast A.R.C. Exhibits, flea market, technical sessions, FCC exams, forums and much more. Full info and reservation for Sheraton Hotel, contact: F.G.C.A.R.C. Convention, P.O. Box 157, Clearwater, FL 33517.

**CASH** for your clean ham gear. Beacon Communications — used equipment specialists, 879 Beacon St., Boston, Mass. 02215. 617-267-1975.



## REMOTE CONTROLLED ANTENNA SWITCH



- The SW-5 is a heavy-duty remote controlled RF switch. Handles 4 kW PEP with negligible insertion loss and SWR below 30 MHz. Housed in rugged, weather-proof enclosure.
- Safe, low-voltage operation from 26 VDC supply in control unit.
- Indicator lights show at a glance which antenna is in use.
- Requires six-wire control cable. Ham-M cable satisfactory to 150 feet.
- Models from 3 to 9 positions. Optional connectors and special switching systems are available.
- Five position Model SW-5 \$120.00 (Shipping \$3.00 in USA — IA res. add 3%)

### ANTENNA MART

Box 1010 ISU Station  
Ames, IA 50010  
Phone: 515-292-7114

## RADIO & ELECTRONICS CONSTRUCTOR

Here is an interesting general electronics hobby magazine. It's loaded with lots of interesting simple circuits and ideas, not only about radio, but in all phases of electronics including test gear, audio, remote control and security electronics.

We are sure that you will find a number of worthwhile projects in this British magazine.

1 Year (12 issues) \$11.00

Radio & Electronics  
Constructor  
Greenville, NH 03048

# DX forecaster

## December, 1977

### Last-minute forecast

December is likely to be a disturbed month. Look for possible geomagnetic and solar upsets between the 6th and 13th and again between the 21st and 26th. As usual, be alert for weather changes during or shortly following unusual ionospheric activity.

For moonbouncers, perigee occurs on December 10th (23rd hour, UTC). The winter solstice (longest night, shortest day) occurs on December 21st (23rd hour, UTC).

### Band-by-band propagation

*Ten Meters* will be remarkable for very little activity. Although the sunspots of cycle 21 are really beginning to blossom, it is still too early to expect any radical improvement in this band. Wait for springtime conditions to do your DXing.

*Fifteen Meters* will be somewhat better than it was last year at this time, but not as good as this fall. DX openings, when they occur, will favor Europe, and Africa, during the forenoon, South America in the early afternoon, and the Pacific in the late afternoon.

*Twenty Meters* is the DXer's choice, and will be open until an hour or so past sunset. Signals from Europe can be expected to peak at noon, from Africa in the early afternoon, South America in the late afternoon, the Pacific in the early morning, and from Antarctica (occasionally) in the late evening.

*Forty, Eighty, and One-Sixty* are excellent band choices for the DXer who is not fortunate enough to be home during the day, because these bands don't really begin to peak until long after sunset. Look for European

DX signals from late afternoon until late evening hours, signals from Africa and South America after sunset, and signals from the Pacific before sunrise. Except for disturbed periods the generally low signal absorption levels and lack of thunderstorm activity during the winter months make these bands a joy to operate. Because South American stations will be booming in after sunset — often until the wee hours — it will be worth your effort to plan for some kind of directional antenna, at least on forty meters, to help you dig for signals from the weaker European and Pacific stations.

### VHF

The *Geminid* and *Ursid* meteor showers take place in December, providing some meteor-scatter propagation during the month, but only for a day or two at the time of each shower. Look for the *Geminids* on the 13th and the *Ursids* on the 22nd. At peak, you can expect about 50 meteors per hour (*Geminids*) and 15 meteors per hour (*Ursids*) to enter the Earth's atmosphere and produce their ionization trails.

Sporadic-E propagation again peaks in December, but at a slightly lower level than in June and July.

### Long path DXing

Remember that twilight zone DX opportunities will be present for an hour or so surrounding the sunrise and sunset periods. As we mentioned a few months ago, look for DX when the sun is rising at the eastern end of the DX path. Signals will be surprisingly strong and clear.



**WESTERN USA**

**MID USA**



**EASTERN USA**

GMT	WESTERN USA										MID USA										EASTERN USA																
	PST	N	NE	E	SE	S	SW	W	NW	FAR EAST	CENTRAL ASIA	EUROPE	S. AFRICA	S. AMERICA	ANTARCTICA	NEW ZEALAND	W. AUSTRALIA	OCEANIA	FAR EAST	CST	N	NE	E	SE	S	SW	W	NW	FAR EAST	CENTRAL ASIA	EUROPE	S. AFRICA	S. AMERICA	W. AUSTRALIA	OCEANIA	FAR EAST	
0000	4:00	—	—	20	20	—	20	20*	15	—	—	—	—	—	—	—	—	—	—	—	6:00	20	40	—	—	40	20	20	20	—	—	—	—	—	—	—	
0100	5:00	20	—	—	20	20	20	20*	20	20	40	40	40	40	40	40	40	40	40	40	7:00	—	80	40	—	—	40	—	—	—	—	—	—	—	—	—	—
0200	6:00	15	—	—	20	20	20	20*	20	20	40	40	40	40	40	40	40	40	40	40	8:00	—	80	40	—	—	40	—	—	—	—	—	—	—	—	—	—
0300	7:00	20	—	—	40	—	—	—	20	20	40	40	40	40	40	40	40	40	40	40	9:00	—	80	80	—	—	80	—	—	—	—	—	—	—	—	—	—
0400	8:00	—	80	—	40	—	—	—	—	40	40	40	40	40	40	40	40	40	40	40	10:00	—	40	80	—	—	80	—	—	—	—	—	—	—	—	—	—
0500	9:00	—	40	—	80	20	—	—	—	80	40	40	40	40	40	40	40	40	40	40	11:00	—	40	80	—	—	80	—	—	—	—	—	—	—	—	—	—
0600	10:00	—	40	—	80	20	40	40	—	80	40	40	40	40	40	40	40	40	40	40	12:00	—	40	80	—	—	80	—	—	—	—	—	—	—	—	—	—
0700	11:00	—	40	—	80	40	40	40	—	80	40	40	40	40	40	40	40	40	40	40	1:00	—	40	80	—	—	80	—	—	—	—	—	—	—	—	—	—
0800	12:00	—	40	—	80	40	40	40	—	80	40	40	40	40	40	40	40	40	40	40	2:00	—	40	80	—	—	80	—	—	—	—	—	—	—	—	—	—
0900	1:00	—	—	—	40	40	40	40	80	—	—	—	—	—	—	—	—	—	—	—	3:00	—	—	—	—	—	—	—	—	—	—	—	—	—	—	—	
1000	2:00	—	—	—	40	40	40	40	80	—	—	—	—	—	—	—	—	—	—	—	4:00	—	—	—	—	—	—	—	—	—	—	—	—	—	—	—	
1100	3:00	—	—	—	40	40	40	80	40	—	—	—	—	—	—	—	—	—	—	—	5:00	—	—	—	—	—	—	—	—	—	—	—	—	—	—	—	
1200	4:00	—	—	—	—	—	—	80	40	—	—	—	—	—	—	—	—	—	—	—	6:00	—	—	—	—	—	—	—	—	—	—	—	—	—	—	—	
1300	5:00	—	—	—	—	—	—	40	80	—	—	—	—	—	—	—	—	—	—	—	7:00	40	—	—	—	—	—	—	—	—	—	—	—	—	—	—	
1400	6:00	—	—	—	—	—	—	40	40	—	—	—	—	—	—	—	—	—	—	—	8:00	40	—	—	—	—	—	—	—	—	—	—	—	—	—	—	
1500	7:00	—	—	—	—	—	—	40	40	—	—	—	—	—	—	—	—	—	—	—	9:00	—	20	—	—	—	—	—	—	—	—	—	—	—	—	—	
1600	8:00	—	—	—	—	—	—	—	20	—	—	—	—	—	—	—	—	—	—	—	10:00	—	20	—	—	—	—	—	—	—	—	—	—	—	—	—	
1700	9:00	—	—	—	15	20	—	—	—	—	—	—	—	—	—	—	—	—	—	—	11:00	—	20	—	—	—	—	—	—	—	—	—	—	—	—	—	
1800	10:00	—	20	15	15	—	—	—	—	—	—	—	—	—	—	—	—	—	—	—	12:00	—	20	—	—	—	—	—	—	—	—	—	—	—	—	—	
1900	11:00	—	20	15	15	—	—	—	—	—	—	—	—	—	—	—	—	—	—	—	1:00	—	20	—	—	—	—	—	—	—	—	—	—	—	—	—	
2000	12:00	—	—	15	15	—	—	—	—	—	—	—	—	—	—	—	—	—	—	—	2:00	—	—	—	—	—	—	—	—	—	—	—	—	—	—	—	
2100	1:00	—	—	20	15	—	—	—	—	—	—	—	—	—	—	—	—	—	—	—	3:00	—	—	—	—	—	—	—	—	—	—	—	—	—	—	—	
2200	2:00	—	—	20	15	—	—	—	—	—	—	—	—	—	—	—	—	—	—	—	4:00	20	40	—	—	—	—	—	—	—	—	—	—	—	—	—	
2300	3:00	—	—	20	20	—	—	—	—	—	—	—	—	—	—	—	—	—	—	—	5:00	20	40	—	—	—	—	—	—	—	—	—	—	—	—	—	
																					6:00	20	40	—	—	—	—	—	—	—	—	—	—	—	—	—	



# HAM CALENDAR

# December 1977

SUNDAY	MONDAY	TUESDAY	WEDNESDAY	THURSDAY	FRIDAY	SATURDAY
<p>*All international events such as contests are shown on the GMT days on which they take place although they may actually begin on the evening of the preceding day in North America.</p> <p>See Dec. 2, 3, 5, 7, 15, 17, 19, 28, 31</p> 	<p>FLORIDA HAM NEWS — SWAP NET by the Broward ARC — Ft. Lauderdale, FL — 146.31-91 at 7:30PM WEST COAST BULLETIN Edited &amp; Transmitted by W6ZF 8PM PST 3540 KCS, A-1, 22 WPM</p>	 <p>AMSAT Eastcoast Net 3850 kHz 8PM EST (0100Z Wednesday Morning) AMSAT Mid-Continent Net 3850 kHz 8PM CST (0200Z Wednesday Morning) AMSAT Westcoast Net 3850 kHz 7PM PST (0300Z Wednesday Morning)</p>	<p>West Coast Qualifying Run</p>	<p>Microcomputer interfacing workshop — 8-10 — A three-day workshop based on the popular 8080 and 8085 microprocessors. Over 20 operating microcomputers are available for participant use Digital Electronics for Automation Workshop — 6-7 — A two-day workshop based on the small scale and medium scale TTL integrated circuits. Many hours of laboratory time with individual breadboarding stations will be provided along with in-depth lectures. These sessions will be held at the VPI &amp; SU campus in Blacksburg, VA. For more information on these workshops contact Dr. Noring Bell, VPI &amp; SU, Blacksburg, VA 24061 (703) 951-0338</p>	<p>North Carolina OSD Party — By the Alumnance ARC, Inc. — 1900Z 12/2 — 0100Z 12/4* — Suggested frequencies are ±10 kHz — CW: 3560, 7080, 14080, 21060, 28060, NOVICES: 3720, 7220, 14250, 21380, 28590 — logs must be postmarked no later than 1/10/78 and sent to: Alumnance ARC, Inc., 2822 Westchester Dr., Burlington, NC 27215</p>	<p>APRIL 160 Meter Contest — 3-4 Connecticut QSO Party — By the Connecticut ARRL — moved from the traditional of May to the weekend of Dec. 17-19/77. The contest will be held on 160M, 170M, 180M, 200M, 220M, 240M, 280M, 300M, 330M, 360M, 400M, 430M, 470M, 500M, 560M, 600M, 630M, 690M, 730M, 780M, 80M, 84M, 90M, 94M, 100M, 108M, 114M, 120M, 126M, 138M, 144M, 148M, 156M, 162M, 168M, 174M, 180M, 186M, 192M, 198M, 204M, 210M, 216M, 222M, 228M, 234M, 240M, 246M, 252M, 258M, 264M, 270M, 276M, 282M, 288M, 294M, 300M, 306M, 312M, 318M, 324M, 330M, 336M, 342M, 348M, 354M, 360M, 366M, 372M, 378M, 384M, 390M, 396M, 402M, 408M, 414M, 420M, 426M, 432M, 438M, 444M, 450M, 456M, 462M, 468M, 474M, 480M, 486M, 492M, 498M, 504M, 510M, 516M, 522M, 528M, 534M, 540M, 546M, 552M, 558M, 564M, 570M, 576M, 582M, 588M, 594M, 600M, 606M, 612M, 618M, 624M, 630M, 636M, 642M, 648M, 654M, 660M, 666M, 672M, 678M, 684M, 690M, 696M, 702M, 708M, 714M, 720M, 726M, 732M, 738M, 744M, 750M, 756M, 762M, 768M, 774M, 780M, 786M, 792M, 798M, 804M, 810M, 816M, 822M, 828M, 834M, 840M, 846M, 852M, 858M, 864M, 870M, 876M, 882M, 888M, 894M, 900M, 906M, 912M, 918M, 924M, 930M, 936M, 942M, 948M, 954M, 960M, 966M, 972M, 978M, 984M, 990M, 996M, 1000M, 1005M, 1010M, 1015M, 1020M, 1025M, 1030M, 1035M, 1040M, 1045M, 1050M, 1055M, 1060M, 1065M, 1070M, 1075M, 1080M, 1085M, 1090M, 1095M, 1100M, 1105M, 1110M, 1115M, 1120M, 1125M, 1130M, 1135M, 1140M, 1145M, 1150M, 1155M, 1160M, 1165M, 1170M, 1175M, 1180M, 1185M, 1190M, 1195M, 1200M, 1205M, 1210M, 1215M, 1220M, 1225M, 1230M, 1235M, 1240M, 1245M, 1250M, 1255M, 1260M, 1265M, 1270M, 1275M, 1280M, 1285M, 1290M, 1295M, 1300M, 1305M, 1310M, 1315M, 1320M, 1325M, 1330M, 1335M, 1340M, 1345M, 1350M, 1355M, 1360M, 1365M, 1370M, 1375M, 1380M, 1385M, 1390M, 1395M, 1400M, 1405M, 1410M, 1415M, 1420M, 1425M, 1430M, 1435M, 1440M, 1445M, 1450M, 1455M, 1460M, 1465M, 1470M, 1475M, 1480M, 1485M, 1490M, 1495M, 1500M, 1505M, 1510M, 1515M, 1520M, 1525M, 1530M, 1535M, 1540M, 1545M, 1550M, 1555M, 1560M, 1565M, 1570M, 1575M, 1580M, 1585M, 1590M, 1595M, 1600M, 1605M, 1610M, 1615M, 1620M, 1625M, 1630M, 1635M, 1640M, 1645M, 1650M, 1655M, 1660M, 1665M, 1670M, 1675M, 1680M, 1685M, 1690M, 1695M, 1700M, 1705M, 1710M, 1715M, 1720M, 1725M, 1730M, 1735M, 1740M, 1745M, 1750M, 1755M, 1760M, 1765M, 1770M, 1775M, 1780M, 1785M, 1790M, 1795M, 1800M, 1805M, 1810M, 1815M, 1820M, 1825M, 1830M, 1835M, 1840M, 1845M, 1850M, 1855M, 1860M, 1865M, 1870M, 1875M, 1880M, 1885M, 1890M, 1895M, 1900M, 1905M, 1910M, 1915M, 1920M, 1925M, 1930M, 1935M, 1940M, 1945M, 1950M, 1955M, 1960M, 1965M, 1970M, 1975M, 1980M, 1985M, 1990M, 1995M, 2000M, 2005M, 2010M, 2015M, 2020M, 2025M, 2030M, 2035M, 2040M, 2045M, 2050M, 2055M, 2060M, 2065M, 2070M, 2075M, 2080M, 2085M, 2090M, 2095M, 2100M, 2105M, 2110M, 2115M, 2120M, 2125M, 2130M, 2135M, 2140M, 2145M, 2150M, 2155M, 2160M, 2165M, 2170M, 2175M, 2180M, 2185M, 2190M, 2195M, 2200M, 2205M, 2210M, 2215M, 2220M, 2225M, 2230M, 2235M, 2240M, 2245M, 2250M, 2255M, 2260M, 2265M, 2270M, 2275M, 2280M, 2285M, 2290M, 2295M, 2300M, 2305M, 2310M, 2315M, 2320M, 2325M, 2330M, 2335M, 2340M, 2345M, 2350M, 2355M, 2360M, 2365M, 2370M, 2375M, 2380M, 2385M, 2390M, 2395M, 2400M, 2405M, 2410M, 2415M, 2420M, 2425M, 2430M, 2435M, 2440M, 2445M, 2450M, 2455M, 2460M, 2465M, 2470M, 2475M, 2480M, 2485M, 2490M, 2495M, 2500M, 2505M, 2510M, 2515M, 2520M, 2525M, 2530M, 2535M, 2540M, 2545M, 2550M, 2555M, 2560M, 2565M, 2570M, 2575M, 2580M, 2585M, 2590M, 2595M, 2600M, 2605M, 2610M, 2615M, 2620M, 2625M, 2630M, 2635M, 2640M, 2645M, 2650M, 2655M, 2660M, 2665M, 2670M, 2675M, 2680M, 2685M, 2690M, 2695M, 2700M, 2705M, 2710M, 2715M, 2720M, 2725M, 2730M, 2735M, 2740M, 2745M, 2750M, 2755M, 2760M, 2765M, 2770M, 2775M, 2780M, 2785M, 2790M, 2795M, 2800M, 2805M, 2810M, 2815M, 2820M, 2825M, 2830M, 2835M, 2840M, 2845M, 2850M, 2855M, 2860M, 2865M, 2870M, 2875M, 2880M, 2885M, 2890M, 2895M, 2900M, 2905M, 2910M, 2915M, 2920M, 2925M, 2930M, 2935M, 2940M, 2945M, 2950M, 2955M, 2960M, 2965M, 2970M, 2975M, 2980M, 2985M, 2990M, 2995M, 3000M, 3005M, 3010M, 3015M, 3020M, 3025M, 3030M, 3035M, 3040M, 3045M, 3050M, 3055M, 3060M, 3065M, 3070M, 3075M, 3080M, 3085M, 3090M, 3095M, 3100M, 3105M, 3110M, 3115M, 3120M, 3125M, 3130M, 3135M, 3140M, 3145M, 3150M, 3155M, 3160M, 3165M, 3170M, 3175M, 3180M, 3185M, 3190M, 3195M, 3200M, 3205M, 3210M, 3215M, 3220M, 3225M, 3230M, 3235M, 3240M, 3245M, 3250M, 3255M, 3260M, 3265M, 3270M, 3275M, 3280M, 3285M, 3290M, 3295M, 3300M, 3305M, 3310M, 3315M, 3320M, 3325M, 3330M, 3335M, 3340M, 3345M, 3350M, 3355M, 3360M, 3365M, 3370M, 3375M, 3380M, 3385M, 3390M, 3395M, 3400M, 3405M, 3410M, 3415M, 3420M, 3425M, 3430M, 3435M, 3440M, 3445M, 3450M, 3455M, 3460M, 3465M, 3470M, 3475M, 3480M, 3485M, 3490M, 3495M, 3500M, 3505M, 3510M, 3515M, 3520M, 3525M, 3530M, 3535M, 3540M, 3545M, 3550M, 3555M, 3560M, 3565M, 3570M, 3575M, 3580M, 3585M, 3590M, 3595M, 3600M, 3605M, 3610M, 3615M, 3620M, 3625M, 3630M, 3635M, 3640M, 3645M, 3650M, 3655M, 3660M, 3665M, 3670M, 3675M, 3680M, 3685M, 3690M, 3695M, 3700M, 3705M, 3710M, 3715M, 3720M, 3725M, 3730M, 3735M, 3740M, 3745M, 3750M, 3755M, 3760M, 3765M, 3770M, 3775M, 3780M, 3785M, 3790M, 3795M, 3800M, 3805M, 3810M, 3815M, 3820M, 3825M, 3830M, 3835M, 3840M, 3845M, 3850M, 3855M, 3860M, 3865M, 3870M, 3875M, 3880M, 3885M, 3890M, 3895M, 3900M, 3905M, 3910M, 3915M, 3920M, 3925M, 3930M, 3935M, 3940M, 3945M, 3950M, 3955M, 3960M, 3965M, 3970M, 3975M, 3980M, 3985M, 3990M, 3995M, 4000M, 4005M, 4010M, 4015M, 4020M, 4025M, 4030M, 4035M, 4040M, 4045M, 4050M, 4055M, 4060M, 4065M, 4070M, 4075M, 4080M, 4085M, 4090M, 4095M, 4100M, 4105M, 4110M, 4115M, 4120M, 4125M, 4130M, 4135M, 4140M, 4145M, 4150M, 4155M, 4160M, 4165M, 4170M, 4175M, 4180M, 4185M, 4190M, 4195M, 4200M, 4205M, 4210M, 4215M, 4220M, 4225M, 4230M, 4235M, 4240M, 4245M, 4250M, 4255M, 4260M, 4265M, 4270M, 4275M, 4280M, 4285M, 4290M, 4295M, 4300M, 4305M, 4310M, 4315M, 4320M, 4325M, 4330M, 4335M, 4340M, 4345M, 4350M, 4355M, 4360M, 4365M, 4370M, 4375M, 4380M, 4385M, 4390M, 4395M, 4400M, 4405M, 4410M, 4415M, 4420M, 4425M, 4430M, 4435M, 4440M, 4445M, 4450M, 4455M, 4460M, 4465M, 4470M, 4475M, 4480M, 4485M, 4490M, 4495M, 4500M, 4505M, 4510M, 4515M, 4520M, 4525M, 4530M, 4535M, 4540M, 4545M, 4550M, 4555M, 4560M, 4565M, 4570M, 4575M, 4580M, 4585M, 4590M, 4595M, 4600M, 4605M, 4610M, 4615M, 4620M, 4625M, 4630M, 4635M, 4640M, 4645M, 4650M, 4655M, 4660M, 4665M, 4670M, 4675M, 4680M, 4685M, 4690M, 4695M, 4700M, 4705M, 4710M, 4715M, 4720M, 4725M, 4730M, 4735M, 4740M, 4745M, 4750M, 4755M, 4760M, 4765M, 4770M, 4775M, 4780M, 4785M, 4790M, 4795M, 4800M, 4805M, 4810M, 4815M, 4820M, 4825M, 4830M, 4835M, 4840M, 4845M, 4850M, 4855M, 4860M, 4865M, 4870M, 4875M, 4880M, 4885M, 4890M, 4895M, 4900M, 4905M, 4910M, 4915M, 4920M, 4925M, 4930M, 4935M, 4940M, 4945M, 4950M, 4955M, 4960M, 4965M, 4970M, 4975M, 4980M, 4985M, 4990M, 4995M, 5000M, 5005M, 5010M, 5015M, 5020M, 5025M, 5030M, 5035M, 5040M, 5045M, 5050M, 5055M, 5060M, 5065M, 5070M, 5075M, 5080M, 5085M, 5090M, 5095M, 5100M, 5105M, 5110M, 5115M, 5120M, 5125M, 5130M, 5135M, 5140M, 5145M, 5150M, 5155M, 5160M, 5165M, 5170M, 5175M, 5180M, 5185M, 5190M, 5195M, 5200M, 5205M, 5210M, 5215M, 5220M, 5225M, 5230M, 5235M, 5240M, 5245M, 5250M, 5255M, 5260M, 5265M, 5270M, 5275M, 5280M, 5285M, 5290M, 5295M, 5300M, 5305M, 5310M, 5315M, 5320M, 5325M, 5330M, 5335M, 5340M, 5345M, 5350M, 5355M, 5360M, 5365M, 5370M, 5375M, 5380M, 5385M, 5390M, 5395M, 5400M, 5405M, 5410M, 5415M, 5420M, 5425M, 5430M, 5435M, 5440M, 5445M, 5450M, 5455M, 5460M, 5465M, 5470M, 5475M, 5480M, 5485M, 5490M, 5495M, 5500M, 5505M, 5510M, 5515M, 5520M, 5525M, 5530M, 5535M, 5540M, 5545M, 5550M, 5555M, 5560M, 5565M, 5570M, 5575M, 5580M, 5585M, 5590M, 5595M, 5600M, 5605M, 5610M, 5615M, 5620M, 5625M, 5630M, 5635M, 5640M, 5645M, 5650M, 5655M, 5660M, 5665M, 5670M, 5675M, 5680M, 5685M, 5690M, 5695M, 5700M, 5705M, 5710M, 5715M, 5720M, 5725M, 5730M, 5735M, 5740M, 5745M, 5750M, 5755M, 5760M, 5765M, 5770M, 5775M, 5780M, 5785M, 5790M, 5795M, 5800M, 5805M, 5810M, 5815M, 5820M, 5825M, 5830M, 5835M, 5840M, 5845M, 5850M, 5855M, 5860M, 5865M, 5870M, 5875M, 5880M, 5885M, 5890M, 5895M, 5900M, 5905M, 5910M, 5915M, 5920M, 5925M, 5930M, 5935M, 5940M, 5945M, 5950M, 5955M, 5960M, 5965M, 5970M, 5975M, 5980M, 5985M, 5990M, 5995M, 6000M, 6005M, 6010M, 6015M, 6020M, 6025M, 6030M, 6035M, 6040M, 6045M, 6050M, 6055M, 6060M, 6065M, 6070M, 6075M, 6080M, 6085M, 6090M, 6095M, 6100M, 6105M, 6110M, 6115M, 6120M, 6125M, 6130M, 6135M, 6140M, 6145M, 6150M, 6155M, 6160M, 6165M, 6170M, 6175M, 6180M, 6185M, 6190M, 6195M, 6200M, 6205M, 6210M, 6215M, 6220M, 6225M, 6230M, 6235M, 6240M, 6245M, 6250M, 6255M, 6260M, 6265M, 6270M, 6275M, 6280M, 6285M, 6290M, 6295M, 6300M, 6305M, 6310M, 6315M, 6320M, 6325M, 6330M, 6335M, 6340M, 6345M, 6350M, 6355M, 6360M, 6365M, 6370M, 6375M, 6380M, 6385M, 6390M, 6395M, 6400M, 6405M, 6410M, 6415M, 6420M, 6425M, 6430M, 6435M, 6440M, 6445M, 6450M, 6455M, 6460M, 6465M, 6470M, 6475M, 6480M, 6485M, 6490M, 6495M, 6500M, 6505M, 6510M, 6515M, 6520M, 6525M, 6530M, 6535M, 6540M, 6545M, 6550M, 6555M, 6560M, 6565M, 6570M, 6575M, 6580M, 6585M, 6590M, 6595M, 6600M, 6605M, 6610M, 6615M, 6620M, 6625M, 6630M, 6635M, 6640M, 6645M, 6650M, 6655M, 6660M, 6665M, 6670M, 6675M, 6680M, 6685M, 6690M, 6695M, 6700M, 6705M, 6710M, 6715M, 6720M, 6725M, 6730M, 6735M, 6740M, 6745M, 6750M, 6755M, 6760M, 6765M, 6770M, 6775M, 6780M, 6785M, 6790M, 6795M, 6800M, 6805M, 6810M, 6815M, 6820M, 6825M, 6830M, 6835M, 6840M, 6845M, 6850M, 6855M, 6860M, 6865M, 6870M, 6875M, 6880M, 6885M, 6890M, 6895M, 6900M, 6905M, 6910M, 6915M, 6920M, 6925M, 6930M, 6935M, 6940M, 6945M, 6950M, 6955M, 6960M, 6965M, 6970M, 6975M, 6980M, 6985M, 6990M, 6995M, 7000M, 7005M, 7010M, 7015M, 7020M, 7025M, 7030M, 7035M, 7040M, 7045M, 7050M, 7055M, 7060M, 7065M, 7070M, 7075M, 7080M, 7085M, 7090M, 7095M, 7100M, 7105M, 7110M, 7115M, 7120M, 7125M, 7130M, 7135M, 7140M, 7145M, 7150M, 7155M, 7160M, 7165M, 7170M, 7175M, 7180M, 7185M, 7190M, 7195M, 7200M, 7205M, 7210M, 7215M, 7220M, 7225M, 7230M, 7235M, 7240M, 7245M, 7250M, 7255M, 7260M, 7265M, 7270M, 7275M, 7280M, 7285M, 7290M, 7295M, 7300M, 7305M, 7310M, 7315M, 7320M, 7325M, 7330M, 7335M, 7340M, 7345M, 7350M, 7355M, 7360M, 7365M, 7370M, 7375M, 7380M, 7385M, 7390M, 7395M, 7400M, 7405M, 7410M, 7415M, 7420M, 7425M, 7430M, 7435M, 7440M, 7445M, 7450M, 7455M, 7460M, 7465M, 7470M, 7475M, 7480M, 7485M, 7490M, 7495M, 7500M, 7505M, 7510M, 7515M, 7520M, 7525M, 7530M, 7535M, 7540M, 7545M, 7550M, 7555M, 7560M, 7565M, 7570M, 7575M, 7580M, 7585M, 7590M, 7595M, 7600M, 7605M, 7610M, 7615M, 7620M, 7625M, 7630M, 7635M, 7640M, 7645M, 7650M, 7655M, 7660M, 7665M, 7670M, 7675M, 7680M, 7685M, 7690M, 7695M, 7700M, 7705M, 7710M, 7715M, 7720M, 7725M, 7730M, 7735M, 7740M, 7745M, 7750M, 7755M, 7760M, 7765M, 7770M, 7775M, 7780M, 7785M, 7790M, 7795M, 7800M, 7805M, 7810M, 7815M, 7820M, 7825M, 7830M, 7835M, 7840M, 7845M, 7850M, 7855M, 7860M, 7865M, 7870M, 7875M, 7880M, 7885M, 7890M, 7895M, 7900M, 7905M, 7910M, 7915M, 7920M, 7925M, 7930M, 7935M, 7940M, 7945M, 7950M, 7955M, 7960M, 7965M, 7970M, 7975M, 7980M, 7985M, 7990M, 7995M, 8000M, 8005M, 8010M, 8015M, 8020M, 8025M, 8030M, 8035M, 8040M, 8045M, 8050M, 8055M, 8060M, 8065M, 8070M, 8075M, 8080M, 8085M, 8090M, 8095M, 8100M, 8105M, 8110M, 8115M, 8120M, 8125M, 8130M, 8135M, 8140M, 8145M, 8150M, 8155M, 8160M, 8165M, 8170M, 8175M, 8180M, 8185M, 8190M, 8195M, 8200M, 8205M, 8210M, 8215M, 8220M, 8225M, 8230M, 8235M, 8240M, 8245M, 8250M, 8255M, 8260M, 8265M, 8270M, 8275M, 8280M, 8285M, 8290M, 8295M, 8300M, 8305M, 8310M, 8315M, 8320M, 8325M, 8330M, 8335M, 8340M, 8345M, 8350M, 8355M, 8360M, 8365M, 8370M, 8375M, 8380M, 8385M, 8390M, 8395M, 8400M, 8405M, 8410</p>





### 3 for the adventure of it!

**The adventure of 80 METER DXing**

by John Devoldere, ON4UN  
 Invaluable knowledge for any DXer, with a special section on Grey-line propagation. Discussion of antennas, basic to advanced.  
 Order HR-80M **\$4.50**

**Pure adventure: FRENCH ATLANTIC AFFAIR**

by Ernest Lehman, K6DXK  
 Intrigue and adventure on the high seas where Amateur Radio is the hero! Award-winning author — as reviewed in the August issue of QST. (recommended for mature readers)  
 Order A-FAA hardcover **\$10.95**

**The adventure of 160 to 190 kHz LOW & MEDIUM FREQUENCY RADIO SCRAPBOOK**

by Ken Cornell, W2IMB  
 Everything you want to know about the license-free 160-190 kHz band! See W1FB's review in the May issue of QST.  
 Order HR-LF **\$6.95**

**Ham Radio's Communications Bookstore**  
 GREENVILLE, NH 03048

Enclosed is check or MO for the following

- 80 METER DXing     FRENCH ATLANTIC AFFAIR     LOW & MEDIUM FREQUENCY RADIO SCRAPBOOK

NAME \_\_\_\_\_

ADDRESS \_\_\_\_\_

CITY \_\_\_\_\_

STATE \_\_\_\_\_ ZIP \_\_\_\_\_

## The Ultimate IAMBIC PADDLE...



- Full range of adjustment in tension and contact spacing
  - Self-adjusting nylon and brass needle bearings
  - Solid silver contact points
  - Precision-machined, chrome plated brass frames
  - Heavy steel base; non-skid feet
- Write for detailed literature

Available at selected dealers or send \$39.95 plus \$2.00 shipping and handling. Money-back guarantee

**BENCHER, INC.**

333 W. Lake St., Chicago, IL 60606 • (312) 263-1808



## CALL TOLL FREE 1-800-535-9598

LA. RESIDENTS CALL COLLECT

AUTHORIZED DEALER FOR...



**DRAKE**



**ICOM**

**YAESU!**



MOTOROLA HOBBY COMPUTERS  
**ATLAS • BIRD • CDE • DENTRON**  
**ETO • HUSTLER • HY-GAIN**  
**KLM • LARSEN • MOSLEY**  
**ROHN FOLD OVER TOWERS**  
**SWAN • TEMPO • TEN-TEC**  
**TRI-EX • WILSON • CUSHCRAFT**

- Prompt phone and mail service
- Liberal trade-ins
- Large inventory
- Same day shipment if ordered before noon
- Visa and Master Charge accepted

## DIGITAL ELECTRONICS, INC.

1201 ANNUNCIATION ST.  
 P.O. BOX 30566  
 NEW ORLEANS, LA. 70190  
 PHONE 504-568-9879



# AD CHECK

... for literature, in a hurry — we'll rush your name to the companies whose names you check.

Place your check mark in the space between name and number. Example: HRH ✓ 150.

ALD ___ 625	Heath ___ 060
Amsat ___ 220	Henry ___ 062
Antenna Mart ___ 009	Herrman ___ 568
Atlas ___ 198	Holdings Photo ___ 252
Atronics ___ 382	Icom ___ 065
Audio Amateur ___ 564	KLM ___ 073
Bencher ___ 629	Kantronics ___ 605
Burghardt ___ 530	Kengore ___ 538
Cohoon ___ 559	Kenwood *
Colorado Silver ___ 630	Kester *
Comm. Center ___ 534	Long's ___ 468
Comm. Spec. ___ 330	MFJ ___ 082
Cushcraft ___ 035	Madison *
Dentron ___ 259	Motorola ___ 599
Digital Elect. ___ 631	Palomar ___ 093
Drake ___ 039	Partridge ___ 439
E. T. O. *	Personal Comm. Found. *
Elect. Dist. ___ 044	RSE Ham-shack ___ 607
Erickson ___ 047	Callbook ___ 100
Hallcrafters ___ 632	Radio Constructor ___ 586
Ham-Bone *	SAROC *
"Ham" Buerger ___ 604	Telrex ___ 377
Ham Center ___ 491	Ten-Tec *
H. R. C. B. ___ 150	Textec ___ 619
Ham Outlet ___ 595	Tri-Ex ___ 116
	Whitehouse ___ 378

\*Please contact this advertiser directly.  
Limit 15 inquiries per request.

DECEMBER, 1977

Please use before January 31, 1978

Tear off and mail to  
**HAM RADIO HORIZONS — "Ad Check"**  
Greenville, N. H. 03048

NAME \_\_\_\_\_

CALL \_\_\_\_\_

STREET \_\_\_\_\_

CITY \_\_\_\_\_

STATE \_\_\_\_\_ ZIP \_\_\_\_\_

## CALL TOLL FREE 800-228-4097

for prices on Yaesu, Tempo, Swan, Ten-Tec, Icom, MFJ, Nye-Viking, Drake, Hy-Gain, Dentron, Midland, and CDE.

### DRAKE

TR4-CW (RIT) 80-10m hf trans. with CW filter	reg. \$699.00	Now \$629.00
34PNB Noise blanker for TR-4C	reg. \$100.00	Now \$90.00
RV-4C Remote VFO/speaker	reg. \$150.00	Now \$134.95
AC-4 AC power supply for TR-4C & T-4XC	reg. \$120.00	Now \$109.00
DC-4 DC power supply	reg. \$135.00	Now \$124.00
L4B Linear amplifier	reg. \$895.00	Now \$789.00
SSR-1 Gen. coverage rcvr. 5-30 MHz	reg. \$350.00	Now \$279.00
R-4C 80-10m receiver	reg. \$599.95	Now \$539.95
4-NB Noise blanker for R-4C	reg. \$70.00	Now \$64.00
T-4XC 80-10m transmitter	reg. \$599.95	Now \$539.95
TV-3300LP Low pass filter	reg. \$26.60	Now \$19.95
MN-2000 Antenna Tuner	reg. \$240.00	Now \$219.95
MN-4 Antenna Tuner	reg. \$120.00	Now \$109.95
1525 Encoder Microphone	reg. \$49.95	Now \$45.95
TR-33C, 2m Portable Xcvr	reg. \$229.95	Now \$209.95

### HY-GAIN

TH6DXX 6 element super Thunderbird	reg. \$249.95	Now \$209.95
TH3-MK3 3 element tri-band	reg. \$199.95	Now \$169.95
204BA 4 element 20m beam	reg. \$189.95	Now \$159.95
Hy-Quad, 2 el. Quad, 10-20 meters	reg. \$219.95	Now \$189.95
TH3JR 3 element tri-band	reg. \$144.50	Now \$129.95
TH2MK3, 2 element tri-band	reg. \$139.95	Now \$124.95
402BA 2 element, 40m	reg. \$199.95	Now \$169.95
203BA 3 element 20m	reg. \$129.95	Now \$109.95
153BA 3 element 15m	reg. \$79.95	Now \$69.95
103BA 3 element 10m	reg. \$54.95	Now \$49.95
DB10-15A 3 element 10, 15m	reg. \$149.95	Now \$134.95
18HT Hy-Tower, reg. \$279.95	Now \$239.95	
2BDQ Trap Doublet 40, 80m	reg. \$49.95	Now \$44.95
5BDQ Trap Doublet 10 thru 80m	reg. \$79.95	Now \$69.95
12AVQ 10-20m vertical	reg. \$37.95	Now \$33.95
14AVQ/WB 10-40m vertical	reg. \$67.00	Now \$57.00
18AVT/WB 10-80m vertical	reg. \$97.00	Now \$84.95
LA-1 Lightning Arrestor	reg. \$44.95	Now \$39.95
BN-86 Ferrite Balun	reg. \$15.95	Now \$14.95
203 3 el 2m beam	\$12.95	
205 5 el 2m beam	\$16.95	
208 8 el 2m beam	\$19.95	
214 14 el 2m beam	\$26.95	
273 4 el J-Pole	\$49.95	
3806 2m Handheld	reg. \$189.00	Now \$169.00
3750 Transceiver	reg. \$1895.00	Now \$1695.00

CALL FOR DAILY SPECIALS  
OPEN 7 DAYS A WEEK

Talk to Bob, WB0RQZ, Joe, WA0WRI, Don, WB0YEZ, Roy, WB0WWA, Bill, WB0YHJ, or Ken WD0EMR.

## 800-228-4097

Nebr. residents call  
402-466-3733 collect

### Communications Center

2226 North 48th Street  
Lincoln, NE 68504

# AD INDEX

ALD Industries	37
Amsat	58
Antenna Mart	74
Atlas Radio	Cover IV
Atronics	59
Audio Amateur	57
Bencher, Inc.	69
Burghardt Amateur Center	10
Cohoon Amateur Supply	45
Colorado Silver Co.	45
Communications Center	78
Communications Specialists	53
Cushcraft	4
Dentron Radio Co.	40, 41
Digital Electronics, Inc.	77
Drake Co., R.L.	Cover II
Ehrhorn Technological Operations	67
Electronic Distributors	70
Erickson Communications	51
Hallcrafters Company	66
Ham-Bone Radio	69
"Ham" Buerger	39
Ham Radio Center	52, 79
Ham Radio's Communications Bookstore	59, 70, 77
Ham Radio Outlet	9
Heath Company	29
Henry Radio Stores	63
The Herrman Co.	52
Holdings Photo Audio Center	68
Icom	7
KLM	20
Kantronics	52
Kengore Corporation	70
Trio-Kenwood Communications, Inc.	Cover III
Kester Solder	25
Long's Electronics	1
MFJ Enterprises	3
Madison Electronic Supply	45
Motorola Semiconductors	68
Palomar Engineers	51, 57, 65
Partridge Electronics Ltd.	70
Personal Communications Foundation	80
RSE Hamshack	25
Radio Amateur Callbook	65
Radio & Electronics Constructor	74
SAROC	72
Telrex Labs	69
Ten-Tec	49, 59, 68
Textec Systems	79
Tri-Ex Tower	67
G. R. Whitehouse & Co.	39

### Foreign Subscription Agents for Ham Radio HORIZONS

Ham Radio Austria Karin Ueber Postfach 2454 D-7850 Loerrach West Germany	Ham Radio Holland MRL Electronics Postbus 88 NL 2204 Delft Holland
Ham Radio Belgium Sierrouse Brusselssteenweg 416 B-9218 Gent Belgium	Ham Radio Italy STE. Via Maniago 15 I-20134 Milano Italy
Ham Radio Canada Box 114, Goderich Ontario, Canada N7A 3Y5	Ham Radio Switzerland Karin Ueber Postfach 2454 D-7850 Loerrach West Germany
Ham Radio Europe Box 444 S-194 04 Upplands Vasby Sweden	Ham Radio UK P.O. Box 63, Harrow Middlesex HA3 6HS, England
Ham Radio France Christiane Michel F-89117 Parly France	Ham Radio Germany Karin Ueber Postfach 2454 D-7850 Loerrach West Germany
	Holland Radio 143 Greenway Greenside, Johannesburg Republic of South Africa



Calling  
All Hams...



...All Hams  
Call Us!

It's Toll Free... So Dial Away!

# 1-800-325-3636

**FOR NEW OR USED AMATEUR RADIO GEAR**... we're specialists and carry *in stock* most of the famous-brand lines. Or, we will talk trade.

**FOR FAST, DOOR-STEP DELIVERY**... give us a call. You'll be amazed; for we guarantee we'll ship your equipment the same day. Plus, most shipments are **PRE-PAID**.

**TO SAVE MONEY**... join thousands of our satisfied customers who buy from us as easily as from their local supplier. So, remember your call is *Toll Free*.



We welcome your Master Charge or Bank Americard



## HAM RADIO CENTER, INC.

8340-42 Olive Blvd. P.O. Box 28271 St. Louis, MO 63132

# ANTENNAS

VERTICALS    QUADS    YAGIS

## VERTICALS FREIGHT FREE!

With loading coil      To the lower 48

FOR 80-40-20-15-10-6 METERS ALL ON THE SAME ANTENNA!!! COMPLETE PACKAGE!

Ideal for low space requirements. Ominidirectional "Rag-Chew" ability

SPECIFY Model Number TTV-80 — **\$35.00**

## QUADS—QUADS—QUADS

PREFERRED BY THOSE WITH "DX" IN MIND

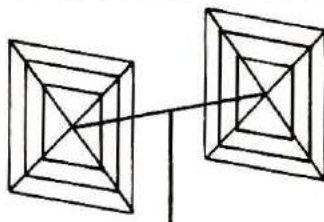
STEEL REINFORCED STRESS POINTS KEEP YOUR QUAD DURABLE

Tri-bander 20-15-10 meters COMPLETE AND READY TO ASSEMBLE

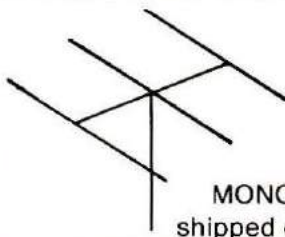
SHIPPED cheapest way.

Freight charge C.O.D.

SPECIFY Model TTQ-3 — **\$68.75**



## YAGI BEAMS



PROVEN PERFORMERS

MONOBANDERS FOR BEST RESULTS

shipped cheapest way. Freight charge C.O.D.

	3 ELEMENTS	4 ELEMENTS
10 METERS	TT103— <b>42.00</b>	TT104— <b>46.00</b>
15 METERS	TT153— <b>49.00</b>	TT154— <b>55.00</b>
20 METERS	TT203— <b>55.00</b>	TT204— <b>65.00</b>

Send check or money order to:  
(TEXAS ADD 5% SALES TAX.)

## TEXTEC SYSTEMS

6003 Maple Ave. Dept. 101-J  
Dallas, Texas 75235





# THE PERSONAL COMMUNICATIONS FOUNDATION

## Legal research for the amateur radio and citizens band services.

The Personal Communications Foundation is a non-profit, tax-exempt California corporation established in November, 1976. Its Board of Trustees, Officers and Advisors consist of lawyers, judges and law school professors with substantial experience in the representation of users who have encountered communications related legal problems.

The Foundation has been organized expressly for the purpose of creating a comprehensive personal communications law library. The Foundation continues to collect available court decisions, briefs and legal memoranda relating to personal communications.

The Foundation has already expended thousands of dollars in funding special studies. One study on the issue of Federal Pre-emption has already been incorporated into a brief before the California Court of Appeals.

## Why you, the user, need the Personal Communications Foundation...

- 1 In 1976 there were over 7,000 legal matters involving all aspects of non-profit personal communications. In 1956 there were only 200.
- 2 *If you have an outdoor antenna*, you may be the subject of a criminal action for violating a zoning ordinance. If you are not now in violation of a zoning ordinance, be advised that they are being changed all over the country with the purpose of eliminating towers and outdoor antennas. You can be the subject of a civil action for violation of private deed restrictions.
- 3 *If you use a transmitter*, you may be sued if you interfere with a neighbor's TV or stereo, even if the interference is due to the inadequate designing of the TV or stereo.
- 4 Litigation of this nature can cost \$10,000 or more. It is estimated that 40% of that amount represents time expended in research. By providing your attorney with our research material, the Personal Communications Foundation can save you thousands of dollars in addition to helping your attorney better represent you.

## ...and why the Personal Communications Foundation needs you.

The Personal Communications Foundation is a membership corporation. Four classes of membership have been established, known as Associate Membership, for a yearly contribution of \$10.00, Full Membership, for a yearly contribution of \$25.00, Contributing Membership, for a yearly contribution of \$100.00, and Life Sustaining Membership, for a single contribution of \$250.00 or more. All contributions are completely tax deductible. All members of the Foundation will receive the newsletter.

NAME (first, middle initial, last) or COMPANY NAME

STREET ADDRESS

CITY

STATE

ZIP

PCF use only

MEMBERSHIP CLASS (check one)

- LIFE MEMBER (\$250)
- CONTRIBUTING MEMBER (\$100)
- FULL MEMBER (\$25)
- ASSOCIATE MEMBER (\$10)

AMOUNT ENCLOSED

DATE

SIGNATURE

SEND CHECK PAYABLE TO:

**PERSONAL COMMUNICATIONS FOUNDATION**  
10960 Wilshire Boulevard, Suite 1504  
Los Angeles, California 90024



# NEW TS-700S

WITH DIGITAL FREQUENCY DISPLAY



Kenwood has done it again! We've combined the fine, time-proven characteristics of the original TS-700A together with many of the ideas and comments for improvement from amateurs worldwide. Check out the new "built-ins": digital readout, receiver pre-amp, VOX, semi-break in, and CW sidetone! Of course, it's still all mode, 144-148 MHz and VFO controlled.

Features: Digital readout with "Kenwood Blue" digits • high gain receiver pre-amp • 1 watt low power switch • built in VOX • semi-break in on CW • CW sidetone • Operates all modes: SSB (upper & lower), FM, AM and CW • Completely solid state circuitry provides stable, long lasting, trouble-free operation • AC and DC capability (operate from your car, boat, or as a base station through its built-in power supply) • 4 MHz band coverage (144 to 148 MHz) • Automatically switches transmit frequency 600 KHz for repeater operation. Simply dial in your receive fre-

quency and the radio does the rest... simplex, repeater, reverse • Or accomplish the same by plugging a single crystal into one of the 11 crystal positions for your favorite channel • Transmit/Receive capability on 44 channels with 11 crystals.

## VFO-700S

The perfect companion to the TS-700S! This handsomely styled unit provides you with extra versatility and the luxury of having a second VFO in your shack. Great for split frequency operation and for tuning off frequency to check the band.

The function switch on the VFO-700S selects the VFO in use and the appropriate frequency is displayed on the digital readout in the TS-700S. In addition, a momentary contact "frequency check" switch allows you to spot check the frequency of the VFO not in use.



TRIO-KENWOOD COMMUNICATIONS INC.  
1111 WEST WALNUT/COMPTON, CA 90220

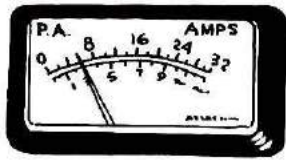
**KENWOOD**  
...pioneer in amateur radio





# THE ALL SOLID STATE **ATLAS 350-XL**

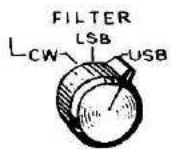
*Its face has many interesting features:*



**350 WATTS SOLID STATE POWER**

P.E.P. and CW input.

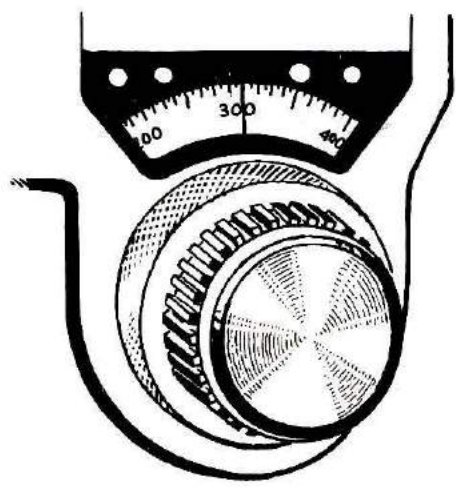
**SSB/CW TRANSCEIVER**  
SSB with PTT or VOX operation and full break-in CW operation.



**CW-LSB-USB FILTER**  
Selection of upper or lower side-band with 2700 Hz bandwidth, 1.6 to 1 shape factor, or 500 Hz CW bandwidth with 2.5 to 1 shape factor.

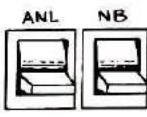


**A.F. NOTCH FILTER**  
Provides better than 40 dB rejection of an audio frequency, adjustable from 300 to 3000 Hz.

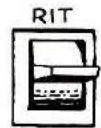


**ANALOG DIAL SCALE**

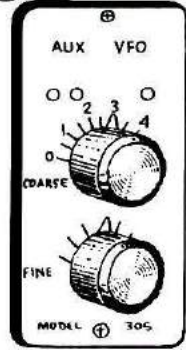
0 to 500 kHz dial scale in 5 kHz increments. Velvet smooth dual speed tuning, with 18 kHz per revolution of fine tuning control.



**ANL AND NOISE BLANKER**  
Automatic Noise Limiter reduces hash type noise interference which is not intermittent pulse type. Blanker effectively reduces or eliminates pulse type noises.



**RECEIVER INCREMENTAL TUNING**  
Permits receiving up to 5 kHz above or below your transmitting frequency. Especially useful for CW operation or in a net of SSB stations that are on different frequencies.

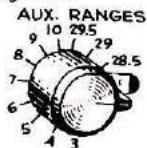
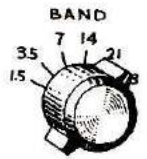


**PLUG-IN AUXILIARY VFO (Optional)**

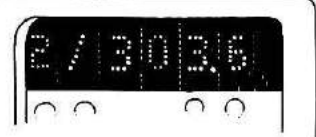
Can be either a tunable VFO with the same 500 kHz tuning range as primary VFO or a crystal controlled fixed channel oscillator with choice of up to 11 crystal controlled channels.

**10-160 METERS COVERAGE**

Provides a full coverage of all amateur bands in 500 kHz segments.



**AUXILIARY RANGES**  
Up to 10 additional 500 kHz ranges between 2 and 23 MHz can be added by plugging in auxiliary crystals. (Will not operate between 23 and 28 MHz.)



**DIGITAL DIAL READOUT (Optional)**

Provides precise frequency readout within 50 Hz. All L.E.D. Dot Matrix 6 digit display.



417 Via Del Monte, Oceanside, CA 92054  
Phone (714) 433-1983  
Special Customer Service Direct Line (714) 433-9591

- ATLAS 350-XL (less options) . . . . . \$995.
- Model DD6-XL Digital Dial Readout . . . \$229.
- Model 305 Plug-in Auxiliary VFO . . . . \$155.
- Model 311 Plug-in Auxiliary Crystal Oscillator . . . . . \$135.
- Model 350-PS Matching Power Supply \$229.
- Plug-in Mobile Mounting Bracket . . . \$ 65.