

# HAM RADIO HORIZONS

Expanded Horizons  
New Look—New Features

MARCH 1980 / \$1.50

Propagation:  
A Major Key To DX

New Monthly  
Bill Orr Column

Atlas 210/215X  
Owners Report

Introducing:  
Regular Questions  
& Answers Section

AMATEUR  
RADIO'S  
CHANGING

AND  
SO ARE  
WE

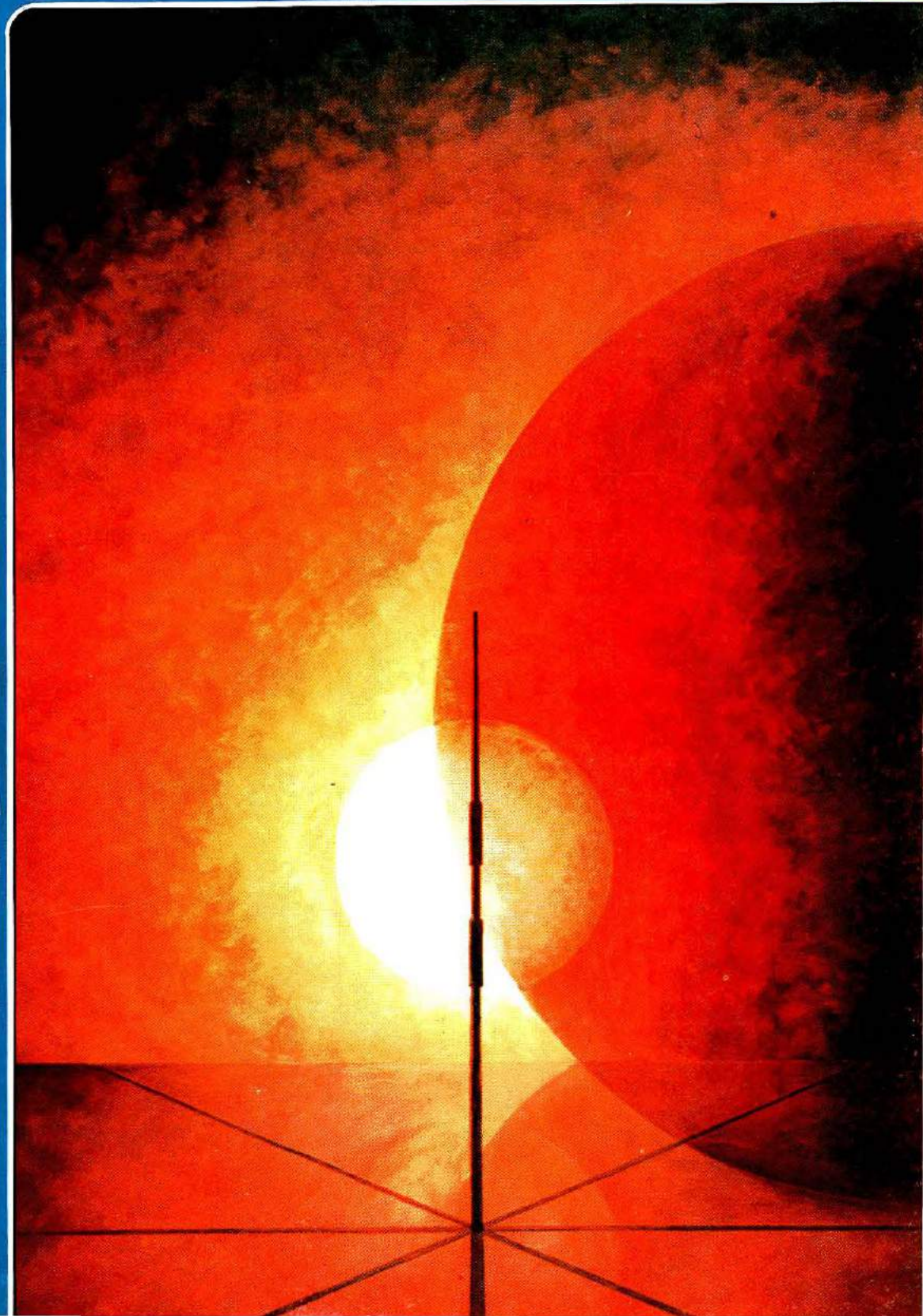



# THE OLYMPIC EDGE

During the XIII Olympic Winter Games in Lake Placid, New York, a complete amateur radio network communicates to the world emergency and personal messages for participants in the games.

HF transceivers used by the Winter Olympic Radio Amateur Network (WORAN) at Olympic Village are Ten-Tec OMNI models loaned by Ten-Tec, Inc., Sevierville, TN 37862.

The OMNI all-HF-band coverage and 100% duty cycle offers SSB, CW, RTTY, TELETYPE, and SSTV capability directly from the Olympic Village. The elaborate network, staffed by nearly 200 amateur radio operators, is one of the most extensive in recent amateur radio history.

Ten-Tec is proud to help in this exciting amateur radio venture.





# A Knob with a new twist "VRS"<sup>TM</sup>

**Swan Astro 150 Exclusive Microprocessor Control w/memory gives you over 100,000 fully synthesized frequencies, and more!**

- VRS — Variable Rate Scanning, a dramatic new technique for unprecedented tuning ease and accuracy
- POWER — 235 watts PEP and CW on all bands for that DX punch
- Advanced microcomputer technology developed and manufactured in the U.S.A.
- Price? See your authorized SWAN dealer for a pleasant surprise!

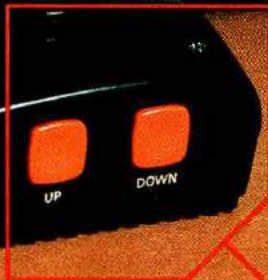

**Dual Meter**  
Reads PEP output in watts and receive "S" units.

**Full Break-in CW**  
(or semi, switch selected)

**Wide Frequency Coverage**

- 10M — 28.0-30.0 MHz
  - 15M — 20.8-23.0 MHz
  - 20M — 13.8-16.0 MHz
  - 40M — 6.0-8.3 MHz
  - 80M — 3.0-4.5 MHz
  - 160M — 1.8-2.4 MHz\*
- \*in lieu of 10M band on Model Astro 151

**Mike Tuning**  
For accurate 100 Hz steps or fixed rate scan.

PSU-5 Power Supply with Speaker



ASTRO 150 Transceiver

ST-3 Antenna Tuner

THE MOST ADVANCED HF SSB TRANSCEIVER AVAILABLE.

FULLY SOLID-STATE **SWAN ASTRO 150**



A division of Cubic Communications, Inc.

305 Airport Rd. • Oceanside, Ca. 92054 • 714-757-7525



# THIS MONTH'S

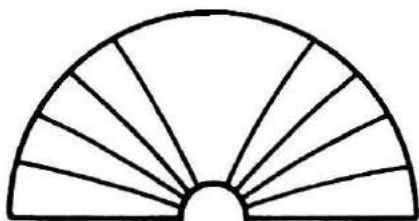

# HORIZONS

## Keys to Working DX

DXing is one of the oldest and most intriguing parts of Amateur Radio, and is actively pursued by the newest licensee and the veteran of the pile-up with equal fervor, if not technique. What makes DX possible? Why are the signals inconsistent in strength? Why does a band "fold up" at certain times? What does the sun have to do with all this? Our new DX column will attempt to answer these questions, and more. It's great reading, and you find the first of the series on page 12.

## Antennas and Ideas

In his first regular, monthly column for *Ham Radio Horizons*, well-known author Bill Orr gives you a taste of the future, a hint of the past, and provides information about a practical and inexpensive antenna you can whip up in a couple of hours this weekend. Look on page 21.

## Adventure In The Siberian Arctic

Welcome aboard *Nanuk*, a wooden sailing ship bound for Siberian trading posts in the early days of radio. The time is 1929, the vessel is a schooner rigged for sailing in the ice, and the author is Bob Gleason, radio operator and dedicated amateur, W3KW. Bob gives a glimpse of what it was like at sea and while his ship was icebound in the early days of radio communications. But there's an added twist — Bob had a homebrew 40-meter ham rig aboard the ship, which shaped the events of the voyage. Interesting

reading for those who would like to know how it was when radio was young.

## Understanding Keyers

Take a few simple rules of digital logic, a couple of integrated circuits, and a step-by-step explanation by someone who knows what's happening, and the muddy waters of electronic keyer operation start to clear. Run through it a couple of times, and it'll be a piece of cake. You can even build the gadget if you want. N9AKT spells it out, starting on page 31.

## Questions and Answers

Here's another new department which you'll find each month in *Horizons*. Selected questions will be answered, providing a service to both the person who asked and to the rest of you who were too shy to ask. The most popular (or useful) question will earn a prize for its author, determined by the opinions you, the reader, send in. The first question is on page 43.

## Oscar And Your Computer

If you think it's hard to keep up with modern technology, you should try to get ahead of it! The planners of the new Phase-III satellites — to be named OSCAR after launch — are doing just that. They've made provisions for another advanced technology, computers, to take advantage of the International Network capabilities of the satellite. As the saying goes, "It's a whole new world," and WA2LQQ lets you take a peek at a QSO of the future, starting on page 48.

## Atlas Owners' Report

The returned questionnaires for the Atlas 210/215X transceivers have been sorted, counted, tabulated, and summarized. As with the previous reports, there are some notable comments among the replies, and some interesting charts and tables came out of it all. Read what more than 100 users and owners had to say about their Atlas rigs, starting on page 34.

## Vertical Antenna For 160 Meters

The 160-meter band has always been attractive and intriguing. Perhaps one of the more intriguing aspects is how to make an antenna that will play there, especially if you have limited space. WA4JQS tells you about a short vertical that is easy to build, and performs well too; look on page 53.

## Airborne Games

Ever long for a nice game of checkers in front of a cozy fire? How about playing chess with a partner from France, Italy, or Russia? Does the rest of your family shy away from your expertise at Monopoly? There's a whole world full of adversaries out there, and you can reach a lot of them through the magic of Amateur Radio. It's happening all the time, and WB2IBE tells you how to get in on the fun and games.

## The Cover

An antenna immersed in the field of influence of the sun symbolizes the Amateur world of DX and Propagation; as our lead article points out, everything hinges on what solar radiation does to the layers of gasses around us. Original painting by Wayne Pierce, K3SUK.

**HAM RADIO HORIZONS** March 1980, Volume 4, Number 3. Published monthly by Communications Technology, Inc., Greenville, New Hampshire 03048. Telephone (603) 878-1441. Second Class Postage paid at Greenville, New Hampshire and at additional mailing offices. ISSN 0147-8818.

Subscription price: Domestic, one year, \$12.00; two years, \$20.00; three years, \$27.00. Canada and Worldwide, one year, \$12.00; two years, \$22.00; three years, \$30.00, payable in United States funds.

Subscription inquiries and changes of address should be directed to *Ham Radio Horizons*, Greenville, New Hampshire 03048. Please include address label from most recent issue if possible.



# This NEW MFJ Versa Tuner II . . .

has SWR and dual range wattmeter, antenna switch, efficient airwound inductor, built in balun. Up to 300 watts RF output. Matches everything from 1.8 thru 30 MHz: dipoles, inverted vees, random wires, verticals, mobile whips, beams, balanced lines, coax lines.

## MFJ LOWER PRICES!

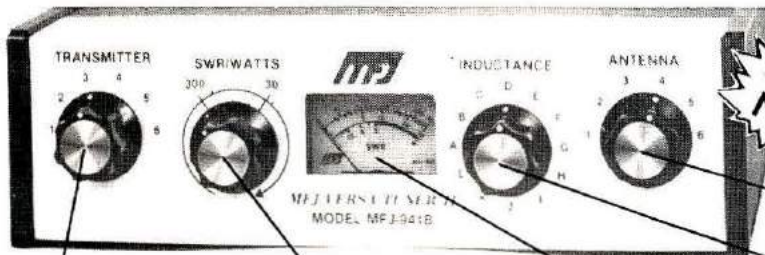

**BRAND NEW**

**NEW, IMPROVED MFJ-941B HAS . . .**

- More inductance for wider matching range
- More flexible antenna switch
- More sensitive meter for SWR measurements down to 5 watts output

NEW LOWER PRICE

# \$79<sup>95</sup>

**Transmitter matching capacitor.** 208 pf. 1000 volt spacing.

**Sets power range,** 300 and 30 watts. Pull for SWR.

**Meter reads SWR and RF watts** in 2 ranges.

**Efficient airwound inductor** gives more watts out and less losses.

**Antenna matching capacitor.** 208 pf. 1000 volt spacing.

Only MFJ gives you this MFJ-941B Versa Tuner II with all these features at this price:

A **SWR and dual range wattmeter** (300 and 30 watts full scale) lets you measure RF power output for simplified tuning.

An **antenna switch** lets you select 2 coax lines direct or thru tuner, random wire/balanced line, and tuner bypass for dummy load.

A **new efficient airwound inductor** (12 positions) gives you less losses than a tapped toroid for more watts out.

A **1:4 balun** for balanced lines. 1000 volt capacitor spacing. Mounting brackets for mobile installations (not shown).

With the **NEW MFJ Versa Tuner II** you can run your full transceiver power output — up to 300 watts RF power output — and match your

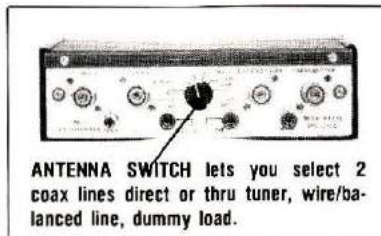

**ANTENNA SWITCH** lets you select 2 coax lines direct or thru tuner, wire/balanced line, dummy load.

transmitter to **any** feedline from 160 thru 10 Meters whether you have coax cable, balanced line, or random wire.

You can tune out the **SWR on your dipole**, inverted vee, random wire, vertical, mobile whip, beam, quad, or whatever you have.

You can even operate all bands with just

one existing antenna. No need to put up separate antennas for each band.

**Increase the usable bandwidth** of your mobile whip by tuning out the SWR from inside your car. Works great with all solid state rigs (like the Atlas) and with all tube type rigs.

It **travels well, too**. Its ultra compact size 8x2x6 inches fits easily in a small corner of your suitcase.

This beautiful little tuner is housed in a deluxe eggshell white Ten-Tec enclosure with walnut grain sides.

**S0-239 coax connectors** are provided for transmitter input and coax fed antennas. Quality five way binding posts are used for the balanced line inputs (2), random wire input (1), and ground (1).

## NEW 300 WATT MFJ VERSA TUNER II'S: SELECT FEATURES YOU NEED.

**NEW MFJ-945 HAS SWR AND DUAL RANGE WATTMETER. NEW LOWER PRICE**

**\$69<sup>95</sup>**

**BRAND NEW**



Same as MFJ-941B but less 6 position antenna switch.

**NEW MFJ-944 HAS 6 POSITION ANTENNA SWITCH ON FRONT PANEL. NEW LOWER PRICE**

**\$69<sup>95</sup>**

**BRAND NEW**



Same as MFJ-941B but less SWR/Wattmeter.

**NEW MFJ-943 MATCHES ALMOST ANYTHING FROM 1.8 THRU 30 MHz. NEW LOWER PRICE**

**\$59<sup>95</sup>**

**BRAND NEW**



Same as MFJ-941B, less SWR/Wattmeter, antenna switch, mounting bracket. 7x2x6 in.

## ULTRA COMPACT 200 WATT VERSA TUNERS FOR ALL YOUR NEEDS.

**MFJ-901 VERSA TUNER MATCHES ANYTHING, 1.8 THRU 30 MHz. NEW LOWER PRICE**

**\$49<sup>95</sup>**

**BRAND NEW**



Efficient 12 position air inductor for more watts out. Matches dipoles, vees, random wires, verticals, mobile whips, beams, balanced lines, coax. 200 watts RF. 1:4 balun, 5x2x6 in.

**MFJ-900 ECONO TUNER MATCHES COAX LINES/RANDOM WIRES. NEW LOWER PRICE**

**\$39<sup>95</sup>**

**BRAND NEW**



Same as MFJ-901 but less balun for balanced lines. Tunes coax lines and random lines.

**MFJ-16010 RANDOM WIRE TUNER FOR LONG WIRES. NEW LOWER PRICE**

**\$29<sup>95</sup>**



1.8 thru 30 MHz. Up to 200 watts RF output. Matches high and low impedances. 12 position inductor. S0-239 connectors. 2x3x4 inches. Matches 25 to 200 ohms at 1.8 MHz. Does not tune coax lines.

**For Orders Call toll-free 800-647-1800**

Order any product from MFJ and try it. If not delighted, return within 30 days for a prompt refund (less shipping).

Order today. Money back if not delighted. One year unconditional guarantee. Add \$2.00 shipping/handling. For technical information, order/repair status, in Mississippi, outside continental USA, call 601-323-5869.

Order By Mail or Call TOLL FREE 800-647-1800 and Charge It On



**MFJ ENTERPRISES, INC.**

P. O. BOX 494

MISSISSIPPI STATE, MISSISSIPPI 39762



# FACTORY DIRECT SALE!!

## Wilson Electronics



**MARK II**  
Save \$105.90

**MARK IV**  
Save \$112.90

- At greatly reduced prices.
- Mark II and IV accessories.
- Introducing the new Mobile Amplifier Charger.
- Battery and Five free Xtal pairs of your choice with radio.

### Mobile Amplifier Charger and Amplifier Specifications

|           |                          | POWER (Watts) |             |              | AMP*<br>13.8 Vdc |
|-----------|--------------------------|---------------|-------------|--------------|------------------|
|           |                          | Useable       | In<br>(Typ) | Out<br>(Typ) |                  |
| WMH 440TT | Mobile Amplifier Charger | 1-6           | 4           | 40           | 5.0              |
| WMH 480TT | Mobile Amplifier Charger | 1-6           | 4           | 85           | 15.6             |
| WA 440    | Broad Band Amplifier     | 1-6           | 4           | 40           | 4.8              |
| WA 480    | Broad Band Amplifier     | 1-6           | 4           | 85           | 15.5             |
| WA 2080   | Broad Band Amplifier     | 10-25         | 20          | 90           | 11.0             |

### MOBILE AMPLIFIER FEATURES

- 5-watt audio amplifier for external speaker.
- Automatic fast/trickle charge.
- Front panel Touch-Tone® Pad which allows generation of DTMF tones.
- Over and under mounting bracket for under dash, floor mounting or base station use.
- A Key-locking feature for security.
- Mobile antenna connect.

(Detach Here)

| MODEL NUMBER                       |  | SALE PRICE |
|------------------------------------|--|------------|
| <input type="checkbox"/> MARK II   | 1 and 2.5 Watt 2m HH   | \$189.00   |
| <input type="checkbox"/> MARK IV   | 1 and 4 Watt 2m HH Radios<br>(Includes battery and 52/52 plus 5 Xtal pairs of your choice) | 212.00     |
| <input type="checkbox"/> BC-2      | Desk Battery Charger   | 31.00      |
| <input type="checkbox"/> BP-4      | Extra Battery Pack   | 19.00      |
| <input type="checkbox"/> LC-3      | Leather Case   | 15.00      |
| <input type="checkbox"/> LC-3P     | Leather Case for Touch-Tone® Pad   | 15.00      |
| <input type="checkbox"/> TTP       | Touch-Tone® Pad (Factory Installed)  | 48.50      |
| <input type="checkbox"/> MC-12     | Mobile Charger Only  | 135.00     |
| <input type="checkbox"/> WMH 440   | 40W Mobile Amplifier Charger   | 199.00     |
| <input type="checkbox"/> WMH 480   | 80W Mobile Amplifier Charger   | 271.00     |
| <input type="checkbox"/> WMH 440TT | 40W Mobile Amplifier Charger with Touch-Tone® Pad  | 240.00     |
| <input type="checkbox"/> WMH 480TT | 80W Mobile Amplifier Charger with Touch-Tone® Pad  | 309.00     |
| <input type="checkbox"/> WA 440    | 40W No Tuning Amplifier for Portable Radios  | 108.00     |
| <input type="checkbox"/> WA 480    | 80W No Tuning Amplifier for Portable Radio   | 181.00     |
| <input type="checkbox"/> WA 2080   | 80W No Tuning Amplifier for Mobile Units   | 147.00     |

TO: **Wilson Electronics**  
4288 South Polaris Avenue  
Las Vegas, Nevada 89103



Ship me all indicated on above chart.

Enclosed is \$ \_\_\_\_\_  Check  Money Order  MC  VISA

Card Number \_\_\_\_\_ Expiration Date \_\_\_\_\_

Xtals 52/52 / / / / /

Name \_\_\_\_\_ Address \_\_\_\_\_

City \_\_\_\_\_ State \_\_\_\_\_ Zip \_\_\_\_\_

Signature \_\_\_\_\_

Shipping Prepaid — Nevada Residents Add 3¼% Sales Tax



March, 1980  
Volume 4, Number 3

**T.H. Tenney, Jr., W1NLB**  
Publisher  
**James R. Fisk, W1HR**  
Editor-in-Chief

**Editorial Staff**  
Thomas F. McMullen, Jr., W1SL  
Managing Editor  
Martin Hanft, WB1CHQ  
Administrative Editor  
Robert Schneider, N6MR  
Joseph J. Schroeder, W9JUV  
Alfred Wilson, W6NIF  
Assistant Editors  
W.E. Scarborough, Jr., KA1DXQ  
Production Manager  
James R. Wales  
Art Director

**Publishing Staff**  
J. Craig Clark, Jr., N1ACH  
Assistant Publisher  
T.H. Tenney, Jr., W1NLB  
Advertising Manager  
James H. Gray, W1XU  
Assistant Advertising Manager  
Harold P. Kent, WA1WPP  
Dorothy A. Sargent, KA1BEB  
Advertising Sales  
Susan Shorrock  
Circulation Manager

Cassette tapes of selected articles  
from *Ham Radio Horizons* are available to  
the blind and physically handicapped  
from Recorded Periodicals  
919 Walnut Street, 8th Floor  
Philadelphia, Pennsylvania 19107

Microfilm copies  
are available from  
University Microfilms, International  
Ann Arbor, Michigan 48103

Copyright 1980 by Communications  
Technology, Inc. Title registered  
at U.S. Patent Office

*Ham Radio Horizons*  
is published monthly by  
Communications Technology, Inc  
Greenville, New Hampshire 03048  
Telephone 603-878-1441  
ISSN 0147-8818

# HAM RADIO HORIZONS

## CONTENTS

|                                      |    |
|--------------------------------------|----|
| <b>Keys to Working DX</b>            | 12 |
| James H. Gray, W1XU                  |    |
| <b>Ham Radio Techniques</b>          | 21 |
| William I. Orr, W6SAI                |    |
| <b>Adventure in the Arctic</b>       | 26 |
| Robert J. Gleason, W3KW              |    |
| <b>Understanding Keyer Circuitry</b> | 31 |
| William B. Jones, N9AKT              |    |
| <b>Atlas Owners' Report</b>          | 34 |
| Thomas F. McMullen, W1SL             |    |
| <b>Questions and Answers</b>         | 43 |
| <b>Satellite-Linked Computers</b>    | 48 |
| Vernard Riportella, WA2LQQ           |    |
| <b>Vertical Antenna for 160</b>      | 53 |
| Anthony W. De Prato, WA4JQS          |    |
| <b>Playing Games Over The Air</b>    | 59 |
| John J. Edwards, WB2IBE              |    |
| <b>Activities Calendar</b>           | 76 |
| <b>Ad Check</b>                      | 78 |
| <b>Ad Scan</b>                       | 71 |
| <b>Advertiser's Index</b>            | 78 |
| <b>Benchmarks</b>                    | 65 |
| <b>DX Forecaster</b>                 | 74 |
| <b>Focus and Comment</b>             | 8  |
| <b>Ham Radio Techniques</b>          | 21 |
| <b>Horizons Locator</b>              | 72 |
| <b>Newsline</b>                      | 11 |
| <b>Post Box</b>                      | 63 |
| <b>Product Showcase</b>              | 67 |
| <b>Propagation Chart</b>             | 75 |
| <b>Publisher's Log</b>               | 10 |
| <b>Questions and Answers</b>         | 43 |
| <b>This Month's Horizons</b>         | 2  |
| <b>The View From Here</b>            | 6  |





## THE VIEW FROM HERE

As you look through this issue of *Ham Radio Horizons*, you'll notice several new features, as well as our normal fare of good reading for active Radio Amateurs; I would especially like to welcome Bill Orr, W6SAI, as a monthly columnist. Bill has been writing technical magazine articles and books for more than 25 years, and is well known for his many contributions to the radio art, especially in the field of antennas; he has written articles for us from time to time in the past, but now he will hold forth each and every month with his new column **Ham Radio Techniques**. This month the emphasis is on antennas, but antennas are not Bill's only interest, so in the months ahead you can look forward to his own special viewpoint

on receivers, transmitters, linear amplifiers, and other radio subjects. Welcome to *Ham Radio Horizons* Bill!

Also beginning this month is our **Question and Answer** column, where we will try to answer interesting questions about Amateur Radio from our readers. Note that we are not able to respond to questions personally; each month we will select those which we feel are most interesting, and answer them in **Q & A**.

DX and DXing have always been a special interest of mine, and I've burned my share of midnight oil waiting up for "that rare one" on the bottom end of 40 meters, so I'm especially pleased that we will shortly be featuring a regular DX columnist. Since DXing tends to follow the height of the sunspot cycle, DX activities are at a peak right now, and with new DXpeditions being announced almost every week, you need a scorecard to keep track of the players. A DX column in a monthly magazine obviously can't compete with a DX newsletter for late breaking news items, but a monthly column is ideal for the casual DXer or for filling in the details that the newsletters don't have room for, for providing up-to-date QSL information, for information on new certificates and awards, and for publicizing the many DX contests that are scheduled each year.

We're kicking off our DX coverage this month with an article by our resident propagation expert, Jim Gray, W1XU. Jim is no stranger to most of you because he often attends hamfests in his role as our Assistant Advertising Manager; behind the scenes he spends a good deal of his spare time poring over computer charts and scientific data to put together our monthly propagation forecast. Next month we will be featuring another guest columnist, and beginning with the May issue, Bill Kenamer, K5FUV, will be joining us as our regular DX contributor. Bill is a very active DXer and edits the new and very popular weekly DX newsletter, *QRZ DX*, so we were delighted when he agreed to do our monthly DX column.

And while I'm on the subject of DX, I would like to comment on some of the questionable ethics and poor operating procedures which some DXers are apparently willing to accept. Jamming, snide comments, cat calls, "traffic cops" on the DX station's operating frequency — these practices only slow down the DX station's ability to handle a pileup. However, I've noticed that this unnecessary conversation on the DX frequency is usually inversely proportional to the skill of the DX operator; those who attack the pileups with speed and grace draw little fire from the many stations who want to work them, but DX operators who cannot pick out callsigns and are unable to make more than one contact a minute must continually compete with intentional interference on their own operating frequency.

And as a side note, being able to raise the funds for a DXpedition to some rare place like Clipperton, Bouvet, or Kingman Reef isn't enough — the operators must be top notch. When a person — or group of persons — plans a DXpedition, it is essential that the operators who are invited to make the trip are both experienced and able to handle the pileups. During the recent DXpedition to Kingman, for example, CW operations were closed down several times because they couldn't deal with the huge pileup; that is a very sad commentary on the operator's ability. By contrast the parent group on Palmyra worked through the pileups quickly and smoothly. And on SSB the Kingman group occasionally reverted to a list operation; under some circumstances I feel the use of a DX list is completely justifiable, but DXpeditions to a rare spot for the sole purpose of providing Amateur Radio contacts are not one of those circumstances!

Jim Fisk, W1HR  
editor-in-chief



# EITHER WAY YOU GO...2 OR 6!



**GO WITH QUALITY.  
GO WITH ICOM.  
GO WITH THE BEST.**

The IC-251A is the newest addition to ICOM's all mode transceiver line. Like the matching IC-551, the IC-251A has dual digital VFO's, three memories, scanning (even SSB), and many other features you only get from ICOM.

Both units include the no backlash, no delay light chopper, similar to the IC-701, as a standard feature at no cost. Coupled to the microporcessor, this provides split frequency operation as well as completely variable offsets.

Check the specs, and you'll agree, either way you go, ICOM is simply the best.

#### SPECIFICATIONS

Listed below are some of the

IC-551 specifications. IC-251A's specs are identical except where noted (in **bold**).

**Frequency Coverage:** 50~54MHz  
(143.8~148.19MHz)

#### RF Output Power:

SSB 10W PEP  
(1~10W adjustable) (10W)  
CW 10W  
(1~10W adjustable) (10W)  
AM 4W  
(0~4W adjustable) ( — )  
FM\* 10  
(1~10W adjustable) (1~10W)

#### Sensitivity: SSB/CW/AM

Less than 0.5 $\mu$ V for 10dB S+N/N  
FM\* More than 30dB  
S+N+D/N+D at 1 $\mu$ V

#### Squelch Sensitivity: SSB/CW/AM

1 $\mu$ V  
FM\* 0.4 $\mu$ V (0.4 $\mu$ V)

#### Selectivity: SSB/CW/AM

More than  $\pm$ 1.1KHz at -6dB (1.2)  
Less than  $\pm$ 2.2KHz at -6dB (2.4)  
(When Pass Band Tuning Unit is installed: less than 1KHz at -6dB)  
FM\* More than  $\pm$ 7.5KHz at -6dB  
Less than  $\pm$ 15KHz at -60dB

**Dimensions:** 111mm (H)  
 $\times$  241mm (W)  $\times$  311mm (D)

**Weight:** 6.1kg (5kg)

**Spurious Response Rejection Ratio:**  
More than 60dB

HF/VHF/UHF AMATEUR AND MARINE COMMUNICATION EQUIPMENT



# ICOM

## ICOM AMERICA, INCORPORATED

Sales Service Centers located at:

2112 116th Avenue NE  
Bellevue, WA 98004  
Phone (206) 454-8155

3331 Towerwood Dr., Suite 307  
Dallas, TX 75234  
Phone (214) 620-2780

#### ICOM INFORMATION SERVICE

2112 116th Ave., N.E.  
Bellevue, WA 98004

Please send me:  IC-551 specifications sheet;  IC-251A specifications sheet;  List of Authorized ICOM Dealers.

NAME \_\_\_\_\_ CALL \_\_\_\_\_

ADDRESS \_\_\_\_\_

CITY \_\_\_\_\_ STATE \_\_\_\_\_ ZIP \_\_\_\_\_

You may send a machine copy of this form



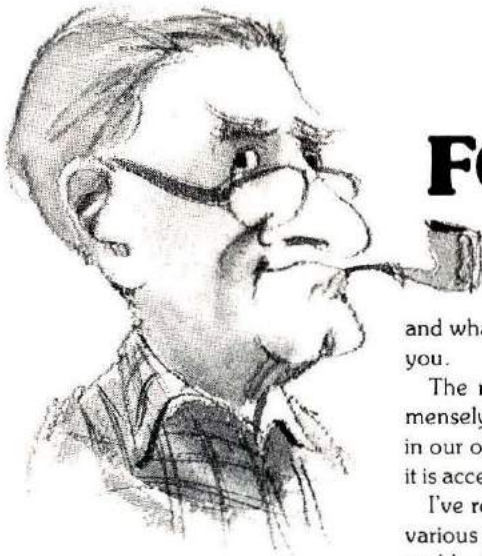

## FOCUS & COMMENT

It's time for a few words about our *Ham Radio Horizons* owners' reports, and what they are intended to do. Perhaps I can answer a few questions for many of you.

The response by people who have the rigs, or have used them, has been immensely gratifying. We've received enough reports that a tabulation of the results is, in our opinion, a credible representation of what is right or wrong with a rig, and how it is accepted by the hams in general. And, the number of returns is growing.

I've received some letters asking us to do a *Consumer Reports* type of analysis on various rigs. Now, at first glance, this idea seems to have merit. However, on the second look, it falls apart. Think of the size of organization it would take to provide this type of report. It requires people. For these people to do their work properly, a large, well-equipped lab must be provided, and their test equipment must be maintained in good shape, with calibration traceable back to the U.S. Bureau of Standards. (No, you cannot just say "I calibrated it to WWV last week;" You must be able to show inspection and calibration stickers from an accepted standards lab). Further, you must be prepared to defend your findings when a manufacturer feels that you are giving his equipment a bum rap.

I've only scratched the surface, but you can see that it is beginning to add up to one answer — money. Frankly, the Amateur fraternity just cannot support an organization of that size, considering that the total number of licensed amateurs does not equal the total sales and circulation of *Consumer Reports*. So, it's nice to think about, but just not practical.

Next, I've received individual requests for reports on some of the newest rigs on the market. To this, I counsel patience. You see, it takes time for enough of the rigs to get in use so that the returns on the questionnaire have some meaning. Look at it this way: If there are only 1000 of a particular rig in the field, and our magazine reaches only 25 per cent of the owners, there's a possibility of 250 rigs that will get reported on. Survey forms of any type are notoriously low-return devices, so let's be optimistic and figure that 25 per cent take the time to fill out the form and return it — 62.5 rigs. Call it 65. Is that a fair sample of the 1000 new rigs? I think not.

Also, how many of those reporting on the rig have really used it enough to put it through its paces? Nobody operates 24 hours a day, seven days a week, so the new rig spends most of its time turned off. It is conceivable that a ham could use his new gear for months, firing it up on CW several nights a week, and the first time he tries it on phone, finds that there is a dead whatchamaycallit in the microphone circuit.

The troubles that show up in use are the ones that are important to prospective buyers. Lab reports are great — they list specifications, weight, price, and give one reviewer's opinion of the looks, feel, and operating "pleasure" of a rig.

However, the opinion of several hundred owners who are not bashful about speaking out (and we guarantee them anonymity if they desire) can be immensely more useful to someone shopping around for a new (or used) rig. Perhaps even more important are the comments on how troubles were handled by the manufacturer, dealer, service shop, or the ham himself. We're currently receiving input from owners of the Heath HW-104A/SB-104A, and I've seen some answers that provided cures for problems that I've had with my own unit. Since our purpose is to help our readers, they'll be reported in the summary in a couple of months.

All this is not to discourage you who have been making suggestions on the back of the form as to which rig you would like to see reported on in the future. Your ideas are always welcome, and will make a difference in the order in which we seek reports. It is the request, "how about a report on the new (Collins, Yaesu, Kenwood, Icom, etc.)" that cannot be handled right away, for the reasons I've just given.

One final observation. Some manufacturers have been, and are, somewhat nervous about the whole owners' survey idea. From what I've seen so far, there's no cause for alarm. The owners seem to be fair in their evaluation. A look at the number of rigs that were reported to need service, or had problems, then a comparison with the percentages of those who would buy the same rig again, leads one to the opinion that the user does not hold "troubles and problems" against the rig.

Besides, it's a great opportunity for management to hand a copy of the results to each department head, from engineering to service to sales, along with the admonishment, "Okay, team, let's beat these numbers on the next run."

This, too, works to the benefit of you, the Radio Amateur, which is what we had in mind.

*Tom*

Thomas McMullen, W1SL  
Managing Editor



# UNSURPASSED RTTY

No other RTTY terminal made gives you ALL the features of our new DS3100 ASR:



- TX/RX operation with 3 codes: Baudot RTTY, Morse Code, ASCII RTTY
- Storage buffers for 150 lines of RX storage and 50 lines of TX storage
- The HAL "original" split screen shows both RX and TX buffers or whole screen for RX
- Ten programmable "Here Is" messages can be chained from one to next
- The EAROM allows power-off storage of 2 "Here Is" messages and terminal operating conditions
- Programmable WRU answer-back and selective-call features
- Separate CW identification key for RTTY operations
- Automatic TX/RX control with KOS plus 4 keyboard controlled accessory switches
- Internal real time clock keeps 24 hour time plus date
- Newly developed CW receive circuitry and programs give superior CW reception
- New green, P31 phosphor display screen gives clear, eye-easing viewing
- On-screen status indicators give continuous display of terminal operating conditions
- Word-Wrap-Around prevents splitting of words at end of display line
- Continuous, line, and word modes offer flexibility in editing transmit text
- Attractive streamlined metal cabinet gives effective RFI shielding from transmitters

*Here Are More DS3100 ASR Specifications that Give You State-of-the-Art RTTY Operation:*

QBF and RY test messages ■ Loop and RS 232 RTTY I/O ■ Plus or minus CW key output ■ 25 pin EIA modem connector ■ Half or full duplex ■ Upper-lower case ASCII ■ All ASCII control codes ■ Optional line printer for all codes ■ Selectable ASCII parity ■ 110 to 9600 baud ASCII ■ 45 to 100 baud Baudot ■ 1 to 175 WPM Morse receive and transmit ■ UnShift on space for Baudot ■ SYNC idle for RTTY and Morse ■ Break key for RTTY ■ Tune key for Morse ■ Automatic CR-LF ■ 120/240 v, 50/60 Hz power ■ Custom labeled key tops show control operation ■ Copy receive text into transmit buffer ■ TX flags allow segmenting of TX buffer ■ One year warranty ■ Price \$1995.00



**HAL COMMUNICATIONS CORP.**  
Box 365  
Urbana, Illinois 61801  
217-367-7373

For our European customers, contact: Richter & Co. D3000  
Hannover 1 • I.E.C. Interelco, 6816 Bissone/Lugano • Radio  
Shack Ltd., London NW6 3AY • Erik Torpdahl Telecom, DK 3660  
Stenløse Denmark

**HAL Communications and  
amateur radio serving  
the 1980 Winter Olympics  
through W.O.R.A.N.  
(Winter Olympics Radio  
Amateur Network)**





## PUBLISHER'S LOG

As we enter the eighties, much of the world around us seems to be in the middle of significant changes. Everything from how we heat our homes or drive our cars to who's who in the world has undergone much revision.

Amateur Radio is certainly no exception. A couple of years ago each new edition of the U.S. *Callbook* was bursting with an increasingly larger number of Novices, and there was great excitement from coast to coast as clubs and other Amateur organizations scurried to find more new candidates for Amateur Radio, and then kept busy conducting licensing classes to finish the job of bringing thousands of newcomers fully into our ranks.

At the same time, WARC-79 had been casting an ominous shadow over the ham community for a number of years. Some forecasters said we'd be lucky to have much of any Amateur Radio when it was over — existing bands would be much smaller, if they existed at all, while new bands were out of the question. Well, it's all over now and the results were terrific: Virtually nothing was lost, and we have three new high-frequency bands plus new uhf privileges to look forward to as the eighties unfold. We'll be needing 9-band high-frequency transceivers and all kinds of new multiband antennas. It all boggles the mind in a most pleasant way.

*Ham Radio Horizons* was a product of all this excitement. We thought of ourselves as a bridge from CB or SWLing to becoming a full-fledged "on-the-air" ham. We worked hard to lead the way through the licensing process and on into the details of just how to put together and maintain an efficient, up-to-date beginning Amateur station.

Well, as I said at the beginning, times have changed. The CB boom is over, and, while we're still seeing newcomers in our ranks, the actual total counts of Novice licensees is starting to drop as insufficient numbers of new Novices become licensed each month to replace those who leave their Novice days — through either upgrading or allowing their licenses to expire.

There is a very positive side to all of this, however. Amateur Radio is very much holding its own as we see ever-increasing numbers of General, Advanced, and Extra-Class Amateurs. Upgrading appears to be underway on a large scale. You only have to be on our bands for a short while to realize that there are a large number of quite recent Novice calls already operating in the higher class portions of our bands. Obviously the emphasis, at least for now, is on the middle ranks of our hobby. The average ham has become a bit more sophisticated, and we'll guess his station is a lot more so.

A magazine is much like a living being; maturing and affected by the world around it as time goes by, and *Ham Radio Horizons* is certainly no exception to this concept. We've decided to march right along with our many readers of recent years (and, we hope, many new readers also) and broaden our horizons — if you'll stand the pun.

Starting in this issue, you'll find that we're still going to work for the reader who gave us our start — the beginner and Novice. This person is still the backbone of tomorrow's Amateur Radio, and we feel a very real obligation to him. However, you'll also find a good deal of material aimed at the more experienced Amateur. We've put together a whole new look from cover to cover, plus several new columns such as Bill Orr's "Ham Radio Techniques," the Q & A Section, plus a unique how-to-do-it DX feature, all of which will help to make *Ham Radio Horizons* more than ever the most exciting magazine in Amateur Radio.

Of course, you've already seen our users' reports for several months. These have been credited by many as one of the most refreshing approaches to product reviews to come along in many years. We have some other ideas along these lines that will add ever more excitement, so stay in touch with us.

Not only will you find new features, but, as the months go by, we'll be including many articles of a more advanced nature as we try to keep up with our readers.

We think you'll find a lot to like in the new *Ham Radio Horizons*, and it will get even better as we get used to our new mission. Look us over very carefully and let us know what you think. It's your magazine, and in the end you are the final judge. Welcome to Amateur Radio, 1980.

Skip Tenney, W1NLB  
Publisher



# NEWSLINE

---

"NO PERMIT" RECIPROCAL operation by U.S. Amateurs in Canada and Canadian Amateurs in the U.S. is now in effect. The Department of Communications agreed with the FCC to make the rules relaxation effective, so as of mid-January, the Amateurs of either country can operate as freely across the border as they do at home. Novices, for whom there is no Canadian equivalent, will apparently be excluded.

HAWAII'S DEVASTATING STORMS in January took out power for over 60 per cent of the island state's residents, caused tremendous property damage and a number of deaths. The inter-island 2-meter network was knocked out when 115 mph winds wiped out the system's hub on Maui's 10,000 foot Mt. Haleakala. Inter-island Amateur communications were, however, maintained on the lower bands for the emergency, particularly on 40 meters.

On Oahu, Amateurs Manned each of the Civilian Defense District Emergency Operations Centers and the main centers at Diamond Head and Honolulu city hall around the clock, while a staff of Amateurs at the National Weather Service's Meteorological Forecast Office provided weather updates. Amateurs provided a great deal of emergency information not available from other sources, and with both power and telephones out, they were using portable and mobile equipment to fill in communications gaps in many areas.

75-METER BROADCAST STATIONS planned by the Canadian Broadcasting Corporation could well appear on the air as early as June, 1981, according to a senior CBC official. Fortunately, only one, or possibly two, are projected for the Sackville, New Brunswick, installation, where curtain antennas will be directed northwest into the Canadian arctic. As total transmitter bandwidth is to be limited to eight kHz, relatively little of the top end of 75 will actually be occupied.

250-Kilowatt Transmitters are to be used in CBC's arctic service, however, so even with main antenna lobes pointed northward some strong lobes should be heard in the U.S. New England and the East Coast will be especially susceptible. With only one (or two) channels in use, disturbance of U.S. Amateur operation is not expected to be severe.

PLANNED LAUNCH DATE FOR AMSAT PHASE III-A satellite is now May 30, 1980. The European Space Agency now also puts the proposed apogee for the spacecraft at 35,786 kilometers.

A Reminder For Phase III Users: Circular polarization of antennas is a must. Spin modulation due to the constant spin of the spacecraft will cause severe fading if linear, polarized antennas are used. The circular polarization should be "right hand" circular, as defined by the IEEE.

Attempts Are Being Made to keep the OSCAR 7 435.1 MHz beacon in the TTY mode on mode A days early in the week for those who would like to copy it on space-only-keying TTY.

Launch Of The Soviet RS3 Amateur Satellite now is expected sometime in the late spring or early summer of 1980.

"PLAIN LANGUAGE" AMATEUR RULES are now moving toward reality, following the Commission's adoption January 16 of a Notice of Proposed Rule Making for plain language radio control rules. Staff losses from John Johnston's Rules group will unquestionably slow the effort, however.

ASCII Implementation may not be too far off after all. New rules encompassing ASCII have been drafted and could go to the Commissioners for approval near press-time.

Old Timers Wishing To Claim CW credit for Extra Class by virtue of having once held an Amateur "Extra First Class" ticket have only a few months left to do so. FCC adopted Docket 79-22 on January 16, which will delete provisions from the Rules that let former "Extra First Class" holders claim 20 wpm code ability. Effective date hasn't yet been set, but early summer is likely.

Special FCC Field Exams have been discontinued due to lack of funds, the Commission has announced. The cutback affects only exams at hamfests, club meetings and the like — field office and scheduled periodic exams in cities without field offices are not affected, and hamfest commitments already made will be honored.

220 MHZ USE IS GROWING at a rate of 125 per cent per year, according to the 220 MHz Spectrum Management Association of Southern California. The Los Angeles, San Diego, San Francisco, Chicago, Detroit, and New York metropolitan areas show the greatest 220 use, with more than 440 220-MHz systems listed in these areas. Southern California now has 83 repeaters on 220, and about 2,000 stations using them, the group reports.



# FAR HORIZONS

By Jim Gray, W1XU

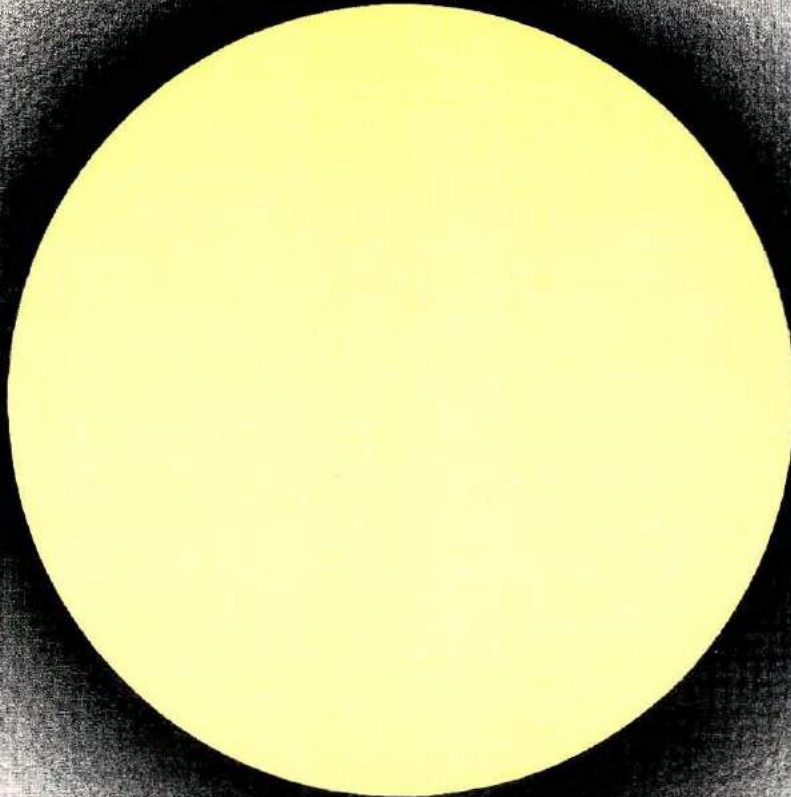

## Something new about something old

Starting with this issue, *Horizons* is going after DX — the DX story, that is. Future issues will see this subject treated in a regular, monthly column, complete with interesting bits about rare or prominent DX stations, propagation information that will help you find and work the DX, operating hints and tips from the "Big Guns," and the latest information about stations and how to get QSLs to and from them.

This first in the series starts with the element that is vital to working DX — propagation, and we've given it a prominent position in the magazine to get the word out that we're up to something new. You'll enjoy following the DX news in this and future issues — and the news starts at the end of this article, with a late-arriving note about still unclaimed QSLs from the ZK2 operation of July, 1979.

## A cosmic view

Against the blackness of space, a giant pinwheel of scintillating stars slowly spins on its axis, trailing spiral "arms" of gas, dust, interstellar debris, and other stars. In some portions of this galaxy, the stars are remote from one another and can be seen as individuals with various colors and temperatures. In other portions, the stars are so thickly clustered that they can be seen only as masses of diffused light. If we look from the center of this galactic pinwheel about two-thirds of the way toward the edge, and perhaps near the beginning of a spiral arm, we will find a middle-aged, yellow-white, G-class star.

Zooming closer, we begin to make out some details of this star whose closest neighbor is over four light-years — twenty-four trillion miles — away. From this new perspective, we can see that the star is really a system, accompanied by nine planets majestically revolving about the star in varying orbits of approximately circular shape, and all in more or less the same plane. Some, small and close to the star, revolve in short periods; others, larger and farther away, swing in ponderous and stately orbits — all in balance, and pirouetting in a cosmic harmony.

Still closer, we see the star as a gigantic nuclear reactor at a temperature of a million degrees, slowly ro-



# Patience, Propagation, and Perseverance — Keys To The Kingdom of DX

tating on its axis as it converts billions of tons of hydrogen into helium each second, hurling the product of this combustion — energy — outward in all directions.

The energy is both visible and invisible, consisting of gases, plasma, molecules, atoms, ions, electrons, and other — smaller — particles; shredded remnants of atoms created, destroyed, and re-formed countless times before escaping the magnetic and gravitational field of the star.

Slightly shifting our point of view, we notice a planet, third outward from the star, that appears to be intermittently bathed in the star's "atmosphere." Like some other planets, this one has a magnetic field whose lines of force crowd tightly together at the poles and spread farthest apart at the equator. The planet's atmosphere is a thin, bluish-white layer against the blackness; and, on the night side near the polar regions, there flickers a subdued, greenish-white curtain of fluorescence — a ghostly dance of ions where the star's fierce radiation impinges on the atmospheric gases, tearing them apart and abandoning them to the magnetic field that drives them toward the poles.

The star, of course, is Old Sol — our sun — affectionately and not inappropriately named for his six billion years, waxing mellow in his middle age. The planet is Earth, our home.

## All power to Old Sol

All of Earth's activity begins with Old Sol, for without him there would be no heat, no light, no life. Only a tiny fraction of all solar radiation, but just enough, is intercepted by Earth. More, and we'd be crisped to a cinder; less, and we'd be a ball of eternal ice.

At the upper levels of Earth's atmosphere, where air is so thin that its molecules are inches apart and collide only infrequently, ultraviolet radiation falls upon the sun side of the planet. The wavelengths are too short for this radiation to be visible to the unaided

eye. It lies beyond the purple end of the spectrum; hence the name "ultraviolet." Atoms of oxygen, nitrogen, hydrogen, and other gases are torn apart — dissociated by the ferocity and energy of this radiation — into ions and electrons, becoming electrical conductors in the process, and forming the ionosphere.

Some u-v radiation reaches the surface of Earth, creating suntan on humans and causing mutations in bacteria. Some is absorbed in chemical processes, and some by plants.

At the other end of the spectrum, beyond the visible red range, lie infrared frequencies, long-wavelength oscillations that we associate with heat. Even beyond these — still longer wavelengths — lie the radio waves used by Earthlings for purposes of communicating.

## DXers are made, not born

The subdued lighting in Bill's hamshack is complemented by the soft green glow from the dial lamps of his Drake R-4 receiver. Faintly revealed in this light are an open logbook, a pencil, and a nearby microphone and electronic key. On the wall above the old library table that Bill uses for his equipment table, desk, and operating position, the ruby LEDs of the digital clock indicate 2330 hours — UTC, naturally. Making a quick mental conversion, Bill is thinking: "... Hmmm, seven-thirty PM here in New Hampshire; the 20-meter band should still be open to Europe. I wonder if that 8Z4 is on yet?"

Rotating the antenna-select switch from GROUND to POSITION 1, Bill hears the R-4 come to life with signals picked up by his tri-band Yagi pointed toward the northeast.

"There's a YU calling 'CQ DX' on 14.048 MHz. Let's move down a bit. Oh, oh! Here's a pileup . . . wow, listen to that bedlam . . . they're calling 8Z4A." Every usable bit of space is occupied with signals — all calling the neutral zone in the Sinai where King

Hussein, JY1, and others have mounted a DXpedition.

"Aha! the 8Z4 is listening up-band rather than on his own frequency." Sometimes a rare DX station does that to avoid jam-ups on his own frequency — just to keep things clear, and his own signals audible to the world.

"Let's tune down a bit more and see if I can hear him."

The pileup gets thicker, and individual callers can no longer be recognized in the hubbub of jumbled calls. Here, an isolated numeral can be pulled out of the mess; there, a letter or two.

"Boy, that op at 8Z4A sure must have ears and filters like they won't quit! I wonder how he can hear anything? Guess I'd better flip in the 400-Hz filter and see if I can separate some of these DXers from each other. Hmmm . . . that's better; the filter has sure narrowed things down a bit, and I can identify a few stations."

Suddenly, at 14.026 MHz, Bill hears: ". . . de 8Z4A BK," and it's LOUD! Fifteen over nine; could it be? Yep, here he is again: "QRZ W1 . . . de 8Z4A, BK."

No, Bill didn't work him that night — or the next night, either — in spite of his spending over two hours patiently trying to guess where the skillful 8Z4 op would be listening next. Finally, the combination of patience, perseverance, and favorable conditions — propagation — clicked, and Bill got his new country.

## What is DX?

Basically, DX means distance — an old-time CW expression that saves time and energy in conveying information. Here is yet another case where a noun has been forced into bonded servitude as an adjective ("Hey, listen to that DX station"); a participle ("DXing is a way of life"); and a verb ("Let's DX tonight"). In spite of the grammatical misuse of this perfectly fine old gentleman, a bare fact of life emerges: DX is FUN, and



# FAR HORIZONS

whole generations of Radio Amateurs have devoted lifetimes of energy, (physical, psychic and electrical) and not inconsiderable fortunes in the pursuit of this hobby of Kings, Crown Princes, and Commoners.

## Propagation of signals

DX, communications at a distance, would not be possible without the propagation of radio waves — the means by which signals travel around the world. Radio propagation is no longer a mystery, since the fundamentals are now well known. But — as in all good thrillers — there is still a hint of the unknown and the unpredictable. As a science it is not yet fully a science, nor does art entirely give way to engineering in the realm of propagation of radio signals. In spite of the “rules,” there are always exceptions.

In general, there are three types of propagation: ground-wave, skywave, and line-of-sight. These can be broken down still further into special-effects, oddities, and variations on a theme. Let's begin with a look at sky-wave propagation.

## Ionization

When the sun's radiation strikes the Earth's atmosphere, it is powerful enough — even at a distance of 93 million miles — to cause the upper levels of air molecules to break up into atoms, and the atoms to break up into particles, *i.e.*, electrons, ions, and so forth. Because of this dissociation of atoms, called ionization, the upper atmosphere turns into a reflector of signals — a radio “mirror” — named the ionosphere by Robert Watson-Watt, a British pioneer in the development of radar. The mirror is not perfect, however, and some portions of the signal are lost because of poor reflection. Reflectivity, in turn, depends on several things: frequency of the signals, angle of arrival of these signals, their polarization, and the degree of ionization of the ionosphere.

As with an ordinary optical mirror, the angle of reflection is equal to the angle of incidence, and the signals “bounce” from the ionosphere back to Earth, skipping between Earth and the mirror many times. The steeper the angle of arrival at the mirror, the steeper the angle of descent, and the shorter the distance between skips or hops. The angle of arrival depends on the height of your antenna above ground, meaning that the shallower

the angle (high antenna) the greater the distance. Multiple-skip propagation is common, and the skywave travels over land and sea many times before coming to your receiving antenna, losing energy by absorption on each skip. No surface, including the ionosphere, is a perfect reflector, and each “hop” absorbs a part of the arriving signal's energy. Sometimes, so much of the signal is absorbed that a receiving station on the other side of Earth cannot hear it. At other times, so little is absorbed (highly activated

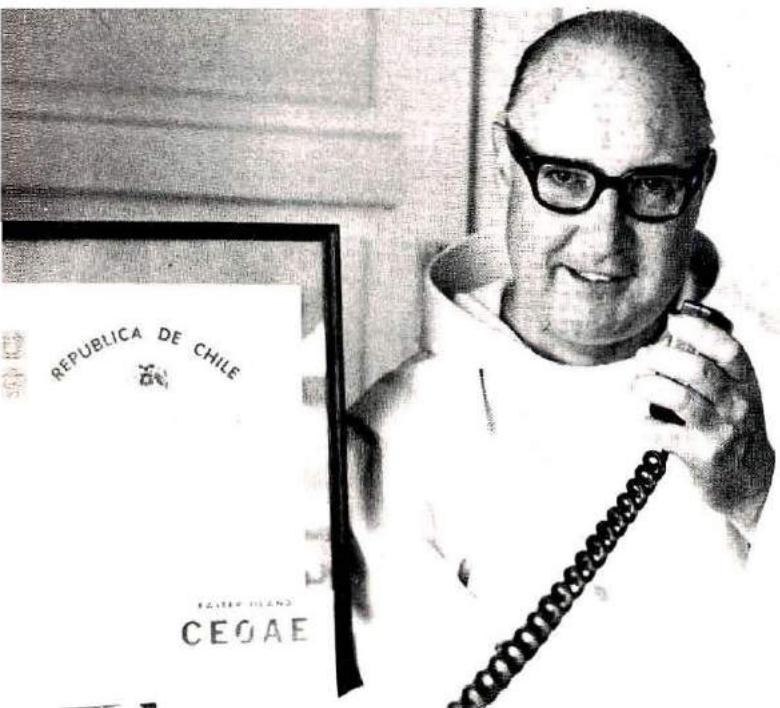



ionosphere and overwater propagation) that the signals arrive with great strength and readability. Occasionally, the ionosphere is too highly ionized and refuses to reflect — becoming a signal absorber again.

Ionization varies from daytime to nighttime, and with the season, as well as year by year — partly because of Old Sol's highly variable nature, and partly because of the Earth's tilted axis. Then, too, particles are in essentially unstable states, having been forced into aberrant behavior by Old Sol. Naturally, they have an affinity for one another and recombine at the

drop of a hat, or, more properly, at the drop of the sun below the horizon. Therefore, the upper atmosphere is almost always in a state of constant motion caused by dissociation and recombination of atoms.

Just as visible light is composed of many different frequencies, ultraviolet light is also composed of many different frequencies, and the gases in Earth's atmosphere react differently to these frequencies, resulting in the formation of layers of ionized particles at different heights above the surface.

When Sir Edward Appleton, a British scientist, discovered the electrically conducting layer in 1924, he proved a theory that had been proposed way back in 1902 by two independent researchers, Arthur Kennelly in the United States and Oliver Heaviside in Great Britain. Because the ionosphere is electrically conductive, Appleton assigned to it the letter E — a letter generally used to designate an electric-field vector. In subsequent work, Appleton discovered another layer at higher altitude, and called it the F layer. A short time later, he discovered another, lower, layer and called it the D layer. The D layer extends from about 50 to 90 kilometers above the Earth, but contains a very low degree of ionization compared with other layers, and lasts only during the daylight hours, peaking in intensity at noon. It is possible that frequencies below about 0.3 MHz (300 kHz) may be reflected from the D layer, but it is known for certain that it does allow the higher frequencies to pass through — weakening them as they go — to the higher layers. It is the D layer that becomes an absorber of radio signals during magnetic storms whose effects are felt mostly within the ionosphere. The D layer also strongly absorbs frequencies

below about 5 MHz during the daytime. In effect, the 3.5-4.0 MHz Amateur band (80 and 75 meter bands) may become useless at noon on a summer day.

The E layer occupies a position about 90-120 kilometers above the Earth, and has an intensity greater than that of the D layer; an intensity that varies with the sun's position and follows the sun across the sky. There is a strange cousin to the E layer, called sporadic E, meaning that it comes and goes irregularly, and in patches that move westward at about 300 kilometers an hour. Although irregular, sporadic E occurs most often during the day in summer and during the night in winter. The patches are quite small and last for only a few hours. Although the mechanism of sporadic E is not understood, it is believed that different relative movement between higher and lower layers of atmosphere, perhaps the jet stream, has something to do with it. Sporadic E often supports vhf propagation at higher frequencies than one would expect; well above 50 MHz, which is the lowest vhf Amateur band.

The F layers extend from about 150 kilometers to about 500 kilometers. The lower one, the F1 layer, extends up to about 250 kilometers; and the higher one, the F2 layer, extends the full distance. The F2 layer is ionized at all times, unlike the other layers, but its height varies from season to season, being lower in winter. The F1 layer is more like the E layer, and varies with the sun angle. Of all the layers that enable skip communications, the F layers are the most important. Their ability to reflect signals also varies with latitude, and, in general, the farther north (or south) one goes toward the poles the lower the critical frequency. That is why DXers in Florida and Texas are often able to work DX on frequencies where stations in New England, for example, can barely hear them.

Daily, seasonal, and annual changes (as well as some that come in between, for no assignable reason) in the ionosphere account for skip propagation — or lack of it, and the location of the stations on Earth have an important bearing on behavior of skywave communications. Before getting any deeper into skywave propagation, which bears the majority of long-dis-

## DX, SPORT OF KINGS

Some of the people you'll find on the Amateur bands: Opposite — John, PE1ARZ, can often be found on the Oscar satellites; far left — Fr. Dave, CE0AE, Easter Island; center — The Crown Prince Albert of Monaco operating at 3A2GX; below — left to right, 9K2AM; 7Z3AB; King Hussein, JY1; SU1MA.





# FAR HORIZONS

tance communications (excepting satellite communications) we should take a quick look at groundwave and line-of-sight.

Groundwave contradicts the ordinary expectation that, because radio signals travel in straight lines and because the Earth curves, they leave the

While tropospheric refraction can, and does, affect lf (low-frequency) propagation, that is, frequencies between about 0.3 and 3.0 MHz, its effect is most noticeable — and useful — in the vhf (very-high-frequency) region between about 30 and 300 MHz.

## Solar cycles

Old Sol goes through periodic changes of condition. Some are due to the 27-day rotation of the sun on its own axis, which can cause active

years — and are called sunspots. Each spot, often larger than the entire Earth, appears dark against the solar disk, and can be safely viewed only through a very dense optical filter, or by projection. As the sun's activity increases, more and more spots appear and form groups, starting at high sun latitudes — 30 degrees or so above or below the sun's equator, and gradually increasing in number and density as the years go by — and they move toward the equator. In a given sunspot

## TUVALU ISLANDS

ZONE 31

Pacific Expedition by  
Bob Duckworth  
WB4MNF-3D2MD

# T2T

| TO RADIO | DATE      | UTC   | RST | 2-WAY | MHZ |
|----------|-----------|-------|-----|-------|-----|
| W1HR     | 11 MAR 79 | 2257z | 5-7 | SSB   | 28  |

Confirmed by  
W5RBO

73

TNX QSO QSL

Special thanks to Hanf, Captain  
of the ship that provided  
transportation to the Islands.

DUSHANBE

# UJ8

Zone 17

To RADIO

W1HR

on. 9 MAR 1979 at 14.10  
on. 3,5-7-14-21-28-144.

TRCVR 200 wtt. Ant: Qu  
PSE QSL via. P.O. Box 88, Moscow

surface and move toward the reflective layers at angles that depend on frequency and antenna height. Some portion of the radiation from a transmitter is affected by the surface of the Earth itself, and seems to "cling" to the surface for dozens of kilometers; particularly signals below about 3 MHz. For example, broadcast stations from 0.5 to 1.5 MHz, and Amateur stations in the 160-meter band (1.8-2.0 MHz) make extensive use of groundwave propagation. Similar to groundwave in effect, but not in cause, is tropospheric bending, i.e., refraction. As in the case of light appearing to bend as it leaves the air and enters water (ever notice that when you look at a fish in shallow water and try to reach him, he is not where you think?), radio waves also bend as they enter various densities of atmosphere, and some portions of the wave are kept closer to the surface.

areas on the surface of the sun to rotate toward or away from the Earth on a regular basis. Quite often an active area will reappear, still active, 27 days later, bringing with it similar conditions and effects on the Earth's ionosphere. For this reason, it is possible to predict general conditions on a 27-day cycle.

The sun is by no means a simple fusion reaction, because it now is seen to be an infinitely variable and complex body of high-temperature gases, compressed by gravity to extraordinary density, and possessed of highly unusual magnetic and electrical properties. Huge vortexes of swirling gases, cooler areas, and magnetically complex areas can appear and disappear on the sun's disk. These have been noticed and tabulated for about two centuries, and it was soon discovered that they have a cyclic variation — approximately every eleven

cycle, the spots may appear mostly in the sun's Northern Hemisphere. In another cycle, they may be predominantly in the Southern Hemisphere. From cycle to cycle, the magnetic signatures of the spots also change sign. As spot groups increase, the solar activity also increases, and greater amounts of ultra-violet energy reach Earth. The ionosphere is accordingly ionized more heavily, with the result that higher and higher frequencies can be reflected.

No one can say for sure why sunspots do what they do or even what they are — or exactly how they are formed — but the study goes on. In each successive cycle, more is learned and passed on for the benefit and use of all of us. For example, it is now known that Earth's weather is somehow related to the sun's distribution of energy. Solar flares produce magnetic storms on Earth, violent upsets of the



Earth's magnetic field that change propagation and sometimes block it completely. It is observed that atmospheric storms frequently accompany solar flares, but the coupling is not fully understood.

Some observers have noticed that certain planetary positions seem to "focus," or otherwise influence, solar radiation and interplanetary magnetic fields, creating still more minor variations in the behavior of the ionosphere — hence affecting radio signal

quite regular. If you are interested in working South Africa, Argentina, or the Antarctic, your best shot will be during the spring and fall equinoxes; that is, in March and September.

The moon, too, has an infrequent but observable effect on the ionosphere; an effect that proves the theory of propagation by ionospheric reflection and the existence of layers of differing ionization. When a solar eclipse occurs, the moon passes between the sun and earth, casting a

tored by the Swiss observatory at Zurich which publishes an "official" sunspot number. It is a "smoothed" number, taking into account the monthly average of spots, and is used by solar physicists, ionosphere physicists, and even hams, as a guide. Because of the smoothing effect, we cannot say with great accuracy that this month or that month is the peak of Cycle 21, until several months afterward. It is possible that Cycle 21 peaked in November or December

ADJIK SSR

# B B Q

Reg 040

op. *JL 177*

GMT, RS/T *599* *KW* — SSB

Dip, G.P.

y 73! op. PETR.

REPUBLIQUE ISLAMIQUE DU MAURITANIE

# 5 T 5 C J

| RADIO       | QSO            | GMT         | RST        | MHZ       | 2X         |
|-------------|----------------|-------------|------------|-----------|------------|
| <i>W/HR</i> | <i>20.4.79</i> | <i>1947</i> | <i>5X8</i> | <i>21</i> | <i>SSB</i> |

QSL TO W4BAA | MERCI, MON AMI JACQUES CRETE  
 CAPTIVA ISLAND | B.P. 202  
 FLA. 33924 | NOUAKCHOTT

*JL*



propagation. One can make a lifetime study of the sun and its effects on radio communications.

In winter, the Earth is actually closer to the sun than in summer because of the slight ellipticity of the Earth's orbit. However, because the Earth's axis is tilted approximately 22.5 degrees (producing seasons), the Northern Hemisphere is tilted away from the direct rays, causing the sun to appear lower in the sky. As a consequence, solar radiation in the Northern Hemisphere during winter is not as pronounced and the ionosphere is less heavily ionized. In summer, the reverse is true. At the equinoxes, daily variations in the ionosphere caused by the Earth's rotation are equalized (not exactly, but nearly enough for practical purposes) between the Northern and Southern Hemispheres, making trans-equatorial propagation particularly useful and

huge shadow when all visible light is cut off. At the same time, ultra-violet radiation is blocked by the moon, and the ionized particles of the upper atmosphere recombine — leading to "nighttime" conditions of propagation. It is quite interesting to monitor the high-frequency bands during a solar eclipse, because these effects can be readily observed at your own station.

Sunspot cycle 19, the one that peaked in 1958, produced the largest number of sunspots ever recorded, and DX propagation was better than ever before. Cycle 20, which peaked in about 1969, produced fewer spots, but still good propagation. The present cycle 21, peaking just about now, is perhaps the second or third largest producer of sunspots ever recorded. As a result, DX has been unusually good this cycle. Sunspot numbers are added, divided, grouped, and fac-

of 1979.

Cycle 21 was unusual in that it got a very late start but matured early. One may surmise a gradual decline, meaning that propagation conditions, hence DX, will be very good for at least three or four more years. In general, sunspot cycles decline somewhat more slowly than they rise, affording a lingering, last look at DX before MUFs fall below the level needed to support long-haul communications on the high-frequency bands.

### Long-path propagation

At times, signals may arrive more strongly at your station after traveling the long way around the Earth than they do coming direct via the short path. Unless your station happens to be exactly half-way around the Earth from the station you are working, there will be a long and a short path. Perhaps because of darkness (re-



# FAR HORIZONS

duced D-layer absorption), unusual magnetic effects, or because a significant part of the long path extends through fewer polar areas, the long-path signal may arrive at your station significantly louder. Long-path propagation usually occurs at frequencies near the MUF, and at times when overall ionization is fairly good at both ends of the path; or, at least, when the largest portion of the long path is through regions which are highly reflective. Long-path skip is often best in practice over the oceans where little in the way of land masses exist to absorb, reflect, or refract the signals in any less favorable manner.

## Grey-line propagation

There are times when signals seem to travel with unusual ease along the path of the terminator, that is, in the twilight zone between daylight and night. Arriving at both ends of the twilight path, such signals are often strong and undistorted, much better than would be expected, and sometimes at frequencies lower than would be expected. Examples of grey-line DXing are prevalent on 40 and 80 meters.

If you pick, as an example, a time about a half-hour before or after dawn or dusk, you will find conditions most suited to this phenomenon. I remem-

ber a station on Bear Island in the arctic which I worked on 40 meters early one evening. His signals were so abnormally loud and clear I was convinced it was a "pirate" station "bootlegging" the call. As it turned out, he was "legit," and we had just enjoyed a good example of propagation enhancement in the twilight zone.

Ordinarily, signals passing through the polar regions are more greatly affected than those passing through equatorial regions because of the Earth's magnetic field, and its tendency to crowd ionized particles toward the poles and disrupt a uniform dispersion of such particles. Very frequently, polar-path signals will be refracted into two signals, much as light is refracted into "slow" and "fast" rays by a bi-refracting medium. (Bi-refracting only means doubly refracted, or split.) Similarly, a signal can be split into two parts in the Earth's atmosphere — most often the F2 layer — into ordinary and extraordinary waves. These will arrive (but sometimes not at all) by slightly different paths, and out of phase by fractions of a second. The result is "garble," a funny echo-like effect that renders the signals unintelligible.

The phenomenon of "backscatter" propagation may also be a part of bi-refracting, where a small part of the signal is refracted in such a manner as to return by skip directly to the sender, or to other stations in his vicinity. Backscatter often works best when signals are at, or near, the MUF.

## The fine art of listening

The competition for DX is fierce, and the rarer the DX, the fiercer the fray. You will need patience and persistence to locate, isolate, and finally work that elusive station. In the first place, almost all of the "locals" will be louder than the station you want to hear, and you will have your ears assaulted by these "rock crushers" calling on the DX frequency, or close to it. Therefore, patience, and the willingness to put up with discomfort will pay off in your DX score.

Guile is often a good substitute for power, and if you persist in your efforts to outsmart the competition, you'll work your share of DX — even the rare ones. For example, a smart DX operator often listens on a frequency different from his transmitting frequency. It's your job to find out where he's listening and place your transmitter signal there so he can hear you. Sometimes a DXer will develop a habit or pattern of operating that you can discern after a few minutes. If he works one high, one low, and one in the middle, you will be able to place your signal exactly where he listens next.

As a budding DXer, you will want to keep up with all of the DX bulletins you can afford. These will tell you what DX will be forthcoming, the approximate time of beginning operation, and the frequency. If you are diligent and don't crave too much sleep, you can be there among the very first — long before the horrible "pileup" begins. It is surprising how many of the rare DX stations operate at times when your part of the world is asleep!

Develop a habit of listening for second and third level signals, i.e., signals an order of magnitude or so weaker than the louder ones. Much good DX is weak because of distance or band conditions, but more often because of power and/or antenna limitations at the DX station's end of the path. You will be surprised at how many U.S. stations refuse to work anyone unless they hear him S9 or better! Scan the band looking for weak ones; really "dig into the mud," and be the first to call when they sign. There is a good chance you may be the first to snag him. The pileup often starts, not because Stateside stations hear the DX, but because they hear

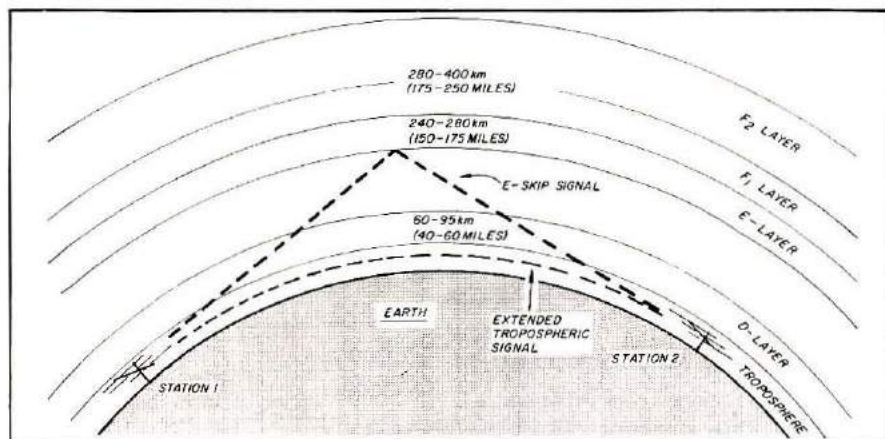

**Fig. 1.** The space through which radio signals propagate is made up of several layers. The lower one, called troposphere, bends the signal path by temperature differences or disturbances in the air mass. Higher layers, in the ionosphere, are subject to varying degrees of ionization — which either helps or hinders the signals as they pass through. The layers are not in fixed positions, but rather shift up and down depending upon weather conditions, solar activity, and the time of day.



# SUN EARTH RELATIONSHIPS

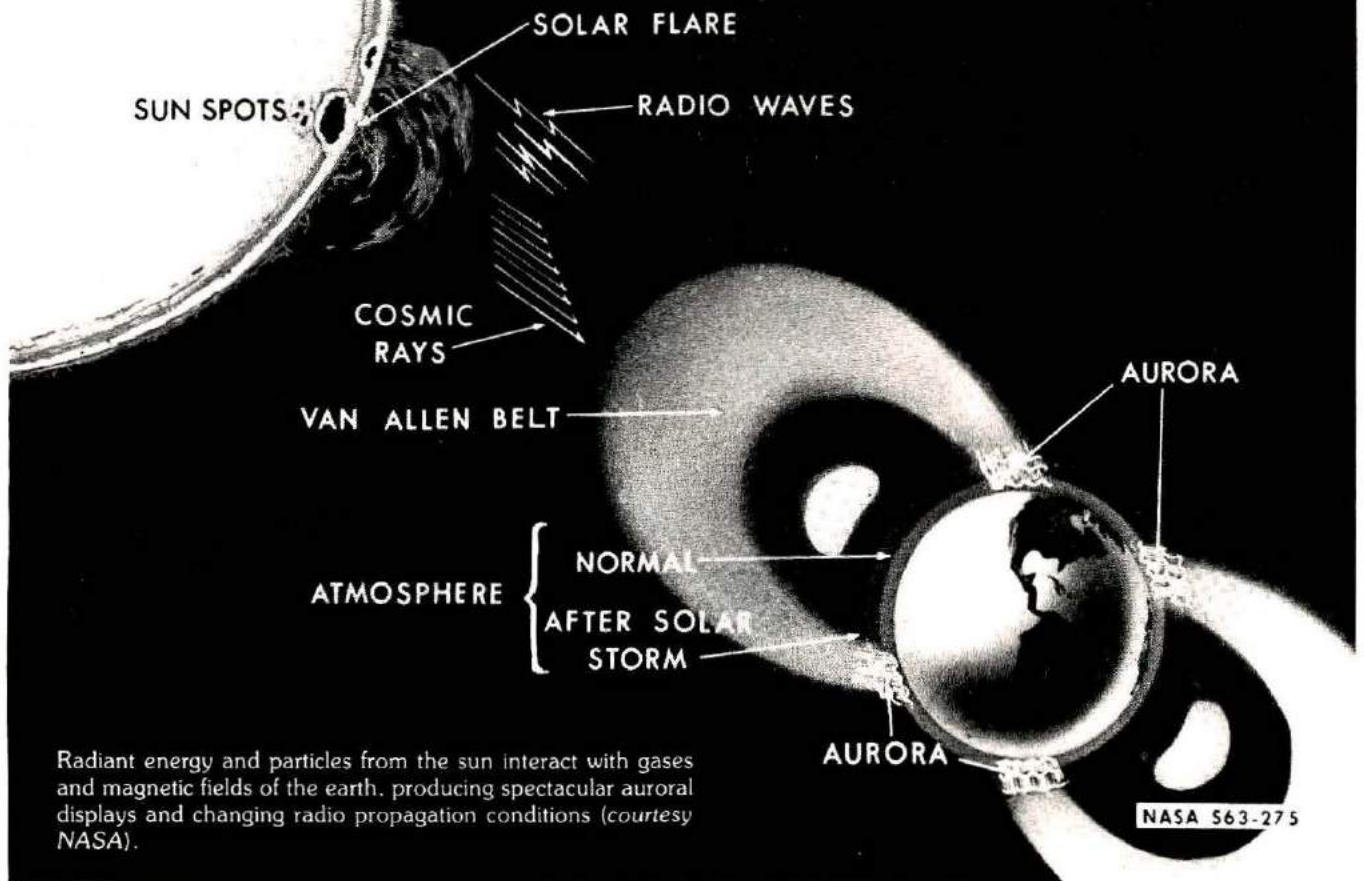

Radiant energy and particles from the sun interact with gases and magnetic fields of the earth, producing spectacular auroral displays and changing radio propagation conditions (courtesy NASA).

you! It's a bit like a feeding frenzy among piranha — otherwise sane citizens go mad with blood fever and do some very illogical things. Many would-be "big guns" don't have the patience or persistence to deal with the problem, and they take it as a personal affront if the DX comes back to another station. Slighted by the DXer's seemingly cold shoulder, they waste the rest of the evening trying to QRM the frequency, spoiling their own fun and that of many others as well.

There is a lot of DX waiting to be worked, even if you have only 100 watts and a vertical antenna! Develop skill by practice. There is no substitute for working DX in order to learn how to work it. In other words, each station's operator has his own particular style, or *modus operandi*. Discover what it is, and be ready with the right approach. Be courteous. It is true that many a "loudmouth" is answered just to shut him up, but remember that

you have to live among your fellow hams when you're not chasing DX. They won't want to talk with you if you become a loudmouth, so keep cool. Being LOUD is a different matter, and means that your station and antenna system are up to par — as good as you can possibly afford in terms of time and money, to say nothing of energy.

It has been said that U.S. operators are among the best and most courteous in the world, and I believe it — for the most part. Try to behave as if the rest of the world is judging us by your behavior, for in a very real sense they are! You are the best foreign diplomat we have because you are a "real" person (not an official) and because you are also reaching a real person and not (usually) an official — it's people-to-people all the way.

Don't waste a DXer's time. Develop precise, efficient operating habits. Exchange only the information that is absolutely necessary — or desired.

Don't "rag chew" if the DX station doesn't want to, but be polite and pleasant. You don't have to be an ogre or a clam to be a first-class op, but be guided by what you hear. Listening is, indeed, a fine art, and will be THE key to your success.

. . . . .

On the night that Bill worked 8Z4A, a portion of his signal was not reflected but penetrated the ionosphere, outbound from the solar system. The radio wave overtook Pioneer on its way into deep space, and continued, getting weaker according to the inverse-square law . . .

In the great square of Pegasus, Andromeda sparkles against the black velvet of deep space — a giant pinwheel of stars, spinning slowly on its axis. Near one of the spiral arms, a middle-aged, class-G star emits a yellow glow. It is part of a system . . .



### Ionospheric reading

George Jacobs, W3ASK, and Theodore H. Cohen, N4XX, *The Shortwave Propagation Handbook*, Cowan Publishing Corp., 14 Vanderventer Ave., Port Washington, New York 11050, (\$7.50, Ham Radio's Bookstore.)

*The Radio Amateur's Handbook*, 56th edition, 1979, American Radio Relay League, Newington, Connecticut.

Oak Okleshen, W9RX, "Introduction to the Propagation of Radio Waves," *Ham Radio Horizons*, April, 1977.

William I. Orr, W6SAI, "The Strange World of Sunspots," *Ham Radio Horizons*, July, 1977.

Calvin Graf, W5LFM, "Ionospheric Focusing," *Ham Radio Horizons*, December, 1977.

Bob Locher, W9KNI, "The Far Horizon," *Ham Radio Horizons*, February, 1978.

Doug Blakeslee, N1RM, "Stalking the Wild Ionosphere," *Ham Radio Horizons*, May and June, 1978.

William I. Orr, W6SAI, "What You Can Expect From the Hambands," *Ham Radio Horizons*, November, 1978.

Jay Buscemi, K2OVS, "A Guide to VHF Propagation," *Ham Radio Horizons*, February and March, 1979.

Thomas Sundstrom, W2XQ, "Propagation Information You Can Use," *Ham Radio Horizons*, April, 1979.

Alf Wilson, W6NIF, "Working DX," *Ham Radio Horizons*, September, 1979.

### Late QSL Information

All QSL requests for ZK2DD, ZK2DJ and ZK2YL as received either by VE3MR or the Canadian DX Association have been filled. There are, however, still several thousand W and VE QSOs in the logs, for which there have been no requests for QSLs. Anyone who now wishes to have a QSL for a contact with one or more of these ZK2 stations can have one by sending a request to VE3FRA. An S.A.E. with IRCs, or an S.A.S.E., are mandatory (no North American QSLs will be sent via bureaus), and any donation will not be turned away. The operation was in July, 1979, and netted some 11,000 QSOs by the three stations. VE3FRA is not handling any QSLs for the trio's operation from 5W1 and A35, but will answer any ZK2 requests. QSL to Alan Leith, VE3FRA, 10 Fairington Crescent, St. Catharines, Ontario, Canada I2N 5W3 — the address does not appear in any callbook.

**LAOS**  
VIENTIANE

# XW8FN

SWAN 350 TH-3

Radio WA6PNN confirming QSO of 12-10-1974  
at 2355 G.M.T. on 14 MHz. Ur 2XSSB sigs  
RST 5-6 73  Pse QSL  Tnx   
**W3HNK - QSL MGR. LLOYD GRUHN**

**SAIGON, VIETNAM**

# XV5AA



**ROBERT BROUGHAM**  
**WA7QDG - exHS1AFA**

**9V1NR**  
**Zone 28**



**QTH SINGAPORE 150 YEARS 1819-1969**

LOCATION  
80 miles north  
of the Equator,  
at 1° 17' North,  
103° 50' East.

HRH



# HAM RADIO TECHNIQUES

BY WILLIAM I. ORR, W6SAI

I became interested in antennas at an early age. My dad had given me a crystal set for my birthday, and I was going to string up an antenna from our house to a nearby tree for the ultimate in DX reception.

Climbing the tree, armed with a roll of wire, I suddenly noticed the girl in the next yard taking — a sunbath! All at once the realization that girls were different struck me like a blow from a hammer! Wow! I dropped the roll of wire and made such a racket trying to catch it that the young lady realized she had a "Peeping Tom" next door.

I paid for this transgression dearly. I was nine years old and she was twelve, and she rewarded me with a punch in the nose next day in school.

Even after this inauspicious start, my interest in antennas (and girls) still remains high.

I'll leave it to other magazines to concentrate on girls. This column will

deal with technical topics of general interest to Radio Amateurs: antennas, equipment design and operation, new products and techniques, and some interesting home projects for your station that you can build and that will work.

This will be a two-way effort, as I'll want to hear from you with regard to your successful projects. I'll want descriptions and photos, if possible. If you have solved a perplexing problem as far as antenna installation goes, I'd like to hear about that, too. In return, I hope this column will be a clearing house and fountain-head of up-to-date information. Those contributions from readers printed in this column will win the contributor a year's free subscription to *Ham Radio*

*Horizons*, either in his name, or in the name of a friend. (Here's a great way to get your buddy interested in Amateur Radio. Win a free subscription to this magazine for him.)

## The first antenna in 1749?

The antenna is older than radio, and older than the United States. Benjamin Franklin used an antenna in his famous lightning experiments, and an antenna was again used in the mid-1880s by Dr. Mahlon Loomis when he sent induction signals between two stations at Harper's Ferry, WV, by employing wires immersed "in the electrical equilibrium of the atmosphere."

In 1887, Hertz generated and detected radio waves, making use of dipole antennas and reflectors, and in 1895 Marconi developed a long-range transmitting antenna that today bears his name (Fig. 1).

The early experimenters, such as Hertz and Marconi, might be dazzled by today's electronic equipment and antennas if they were magically transported from the past, but they would readily understand the underlying principles of operation, as all antennas obey the fundamental laws of electricity set forth before the turn of the century by Faraday and Maxwell. Antennas, in other words, are old hat.

## Antennas today

Antennas are of great interest to

### Welcome aboard

*It's always a pleasure to work with good people, and it is our good fortune to have a well-known author and long-time Amateur such as Bill Orr on our team.*

*Bill's name and call have been associated with articles and books on many subjects, from propagation to old-time radio, from antennas to uhf, so you're never quite sure which direction this column will take at any given time. He will not be restricted to antennas — although that certainly will be a large part of his monthly section in Horizons — nor to any one subject for long. A suggestion was made to title his column "Ramblings of . . ." but that suggests something without direction. Bill's works do have direction — aimed at improving the Amateur's understanding of all phases of this great hobby. You'll enjoy what he has to say in this and future issues of Horizons.*

**Editor**

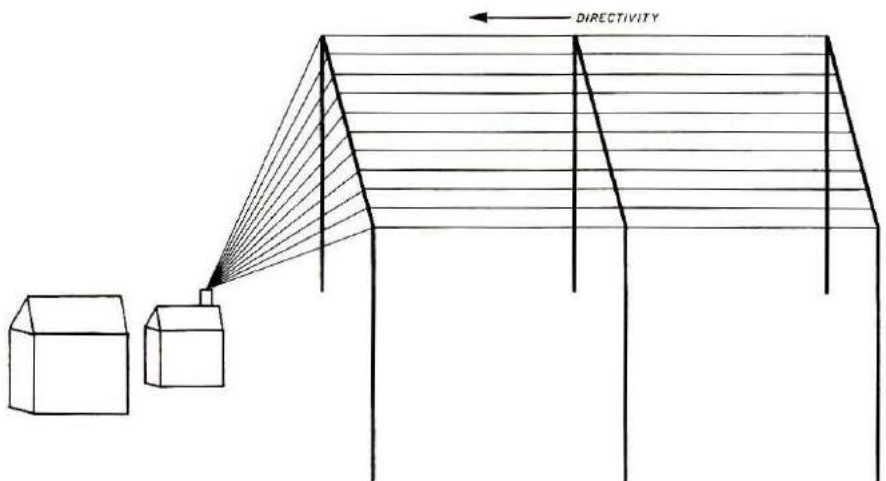

**Fig. 1.** The Marconi antenna was turned into the world's first beam antenna in 1902. Marconi found that his antenna exhibited definite directional properties, giving stronger reception when the free end pointed away from the transmitting station than when it was pointing towards it. It was later found that the directivity effect was equally apparent with a transmitting antenna of this type. Experiments were conducted at a wavelength of about 3666 meters. (From "A History of the Marconi Company" by W. J. Baker, Methuen & Co., Ltd., London.)



radio hams today because they represent the last, great field of experimentation open to enthusiasts. Some fellows are at home with solid state and ICs; others prefer tube gear, and others are into computers. But, the expertise and test gear required for exotic fields cuts out a great number of would-be experimenters. Antennas, on the other hand, are a wide-open field of inquiry. Many antennas can be built with nothing more than a roll of copper wire and a few insulators, and a bit of curiosity.

You may not have the expertise to build a solid-state transceiver, complete with readout and encoding, but you do have the expertise to build a lot of interesting antennas, and you'll have a lot of fun, especially when you work DX with your creation!

The antennas we'll talk about most are the popular ones: the Yagi, the Quad, the dipole (and its many variants), and the ground plane. A very energetic conversation can be started at the local radio club, debating the merits and faults of each type of antenna. You'll hear a lot of misinformation about antennas on the ham bands from self-appointed experts, and you'll read a lot of puffery about antennas in some advertisements, particularly those that are composed in the advertising department instead of the engineering department.

### The W6SAI rules of antenna operation

Chasing DX for over 40 years has taught me three basic antenna rules that I'll impart to you for free. If you remember these, they will save you a lot of headaches, and may even save you money.

First: Poor antennas perform better than average when conditions are good, and perform poorly when conditions are marginal. (You can work a lot of DX today on 10 meters with a wet string. When the sunspot cycle drops off, you will need a very good beam antenna to work 10 meter DX, and the boys with dipole antennas will suffer. Eventually, when the band becomes "dead," you won't work DX with any type of antenna!)

Second: A low-gain antenna up high will usually beat a high-gain antenna low-down. (If you have a choice of placing a simple antenna up

in the air versus a complex antenna close to the ground, go for the high installation for best DX results on the high-frequency bands.)

Third: No matter how good your antenna, somebody will always beat you out. (The ionosphere is a great leveller of signals and the race does not always go to the swift, etc.).

### An interesting two-band antenna

From time to time, I'm going to include in this column material that appears in overseas Amateur Radio magazines that I think is of interest to U.S. Amateurs. Some very fine ham publications are printed in Europe, Australia, and Japan, and material that otherwise may go unnoticed will be introduced here as time and space permits.

One of the most interesting magazines is *Amateur Radio* published by the Wireless Institute of Australia. (For more information on the magazine, you can write to the Institute at P.O. Box 2611W, GPO Melbourne 3001, Australia.) A recent issue of the magazine featured a two-band antenna for 80 and 40 meters, Fig. 2.

The antenna is made of lengths of 300-ohm "TV ribbon" feedline. On 80 meters, the antenna functions as a

half-wave dipole with a T-match to the 300-ohm transmission line. On 40 meters, the center portion of the antenna acts as a folded dipole which presents a close match to the 300-ohm line. The end sections, which are a quarter-wavelength long on 40 meters, act as linear isolation stubs, and are electrically "disconnected" from the 40-meter dipole.

The impedance at the bottom of the 300-ohm feedline can be matched to a 50-ohm coaxial line when a 4-to-1 balun transformer is used. Note that the ends of the ribbon forming the flat top of the antenna are left open.

The feedline length is not critical. If desired, the balun may be mounted directly at the antenna terminals and the 300-ohm line to the shack omitted. This arrangement, however, places more weight at the center of the antenna, causing it to sag.

The antenna may be trimmed to frequency by adjusting the placement of the shorting links for 40 meters, and trimming the overall length for 80 meters. As shown, the antenna is trimmed to the phone portion of 80 meters and the center of the 40 meter band.

A four-to-one balun quite possibly may be purchased, but one can be

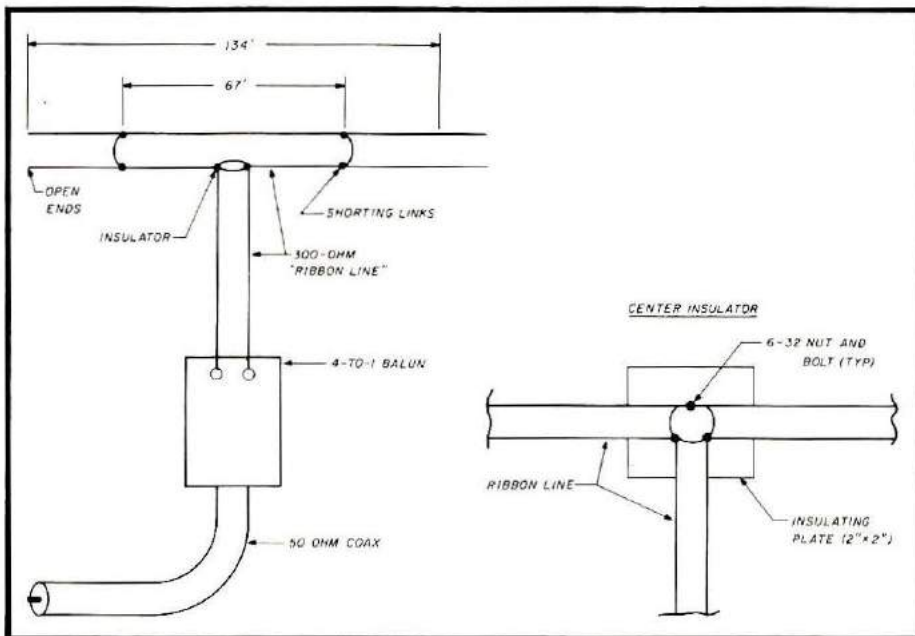

Fig. 2. The Australian dipole for 80 and 40 meters. The flat top is cut in two at the middle, and the wires soldered to bolts mounted in a small insulating plate (plastic or phenolic will do). One set of wires is broken, and the feedline attached at this point. The other set make a continuous connection through the insulating plate. The wires are left open at the ends of the antenna. Similar plates may be used for end insulators and the antenna supported by nylon rope.



home-built easily and inexpensively. The electrical circuit of a practical design is shown in Fig. 3. Basically, it consists of two broad-band transformers parallel-connected on the input side and series-connected on the output side. This provides a 2-to-1 voltage stepup, equivalent to a 4-to-1 impedance stepup. Each transformer consists of two windings on a ferrite core. The wires are wound on together as shown in Fig. 4. One winding of each transformer should be marked with a dab of paint so that the windings can be identified when the time comes to interconnect them.

The balun transformers can be suspended by their leads in a small aluminum box. The input windings attach to a coaxial receptacle, and the outputs to a two-terminal connector strip. If the balun is to be used outdoors, it's a good idea to seal the seams and joints of the box with bathtub caulk to make the assembly waterproof.

#### Adjusting the antenna

The antenna should work as-is on both 40 and 80 meters, with a reasonably low value of SWR on either band. It may be possible to improve transmitter loading by varying the length of the 300-ohm line a few feet at a time, since a small standing wave does exist on the line at all frequencies of operation. Antenna height above ground also affects the SWR on the coaxial line, to a degree.

#### Antenna specifications

Antenna specifications, like horsepower and miles-per-gallon in automobiles, are readily inflatable to meet a particular situation, and it takes a lot of willpower for a manufacturer to resist the specifications race when his competitor starts to boost the various virtues of his antenna past generally accepted values. We'll have something to say about that in future columns.

As a matter of general interest, the American Radio Relay League doesn't allow advertisers to specify antenna-gain figures in their ads in League publications. Other magazines don't follow this restrictive policy. It is interesting to take a particular antenna ad and compare the one in *QST* magazine against an identical

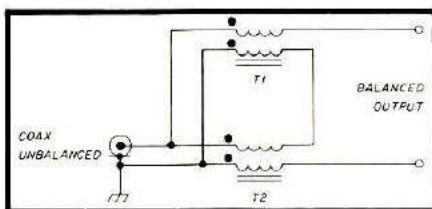

Fig. 3. The 4-to-1 (unbalance-to-unbalance) transformer. When a 50-ohm line is used, the output impedance is about 200 ohms. This is sufficiently close to work well with the "ribbon line" feed system of the two-band antenna. Dots indicate beginning of windings. Note that, if a 75-ohm coaxial line is used, instead of a 50-ohm line, the balanced output impedance is 300 ohms. This provides a closer match to the antenna, but how many hams have SWR meters that will work properly with a 75-ohm line? Overseas, there's no problem — but, such devices are rare in the United States. Better stick with the 50-ohm coax and accept a somewhat higher value of SWR.

ad in another magazine. As an example, compare the *Cushcraft Corporation* full-page ad for their ATB-34 multiband beam antenna in the November, 1979, copy of *QST* and the September, 1979, copy of *Ham Radio Horizons*. The same ad? They certainly look the same. Close examination of the two, however, shows that antenna-gain figures and front-to-back ratio are given in the *Horizons* ad and the space for the figures is

blank in the *QST* ad. There's a footnote in the *QST* ad that says "Antenna gain specifications cannot be published in *QST*," and informs the reader to write the manufacturer for full specifications.

You'll note that other antenna advertisements in *QST* are free of gain figures, too. Of course, this does not imply that *Cushcraft* antenna data is imprecise. Everybody in the industry knows that Bob Cushman is a straight-arrow. What it does mean is that, in the past, some advertisers have published extravagant antenna claims and *QST* finally did something about it. As a result, all antenna advertisements in that magazine are bereft of this information.

I must say that it is hard to discuss beam antennas without gain figures. Unfortunately, these figures are hard to prove or disprove, and it is debatable that omitting the information is much of a help. Most magazines keep a close watch on ad content and the *QST* policy certainly irritates advertisers. Time will tell if it is worthwhile.

#### "Ham" gain versus "CB" antenna gain

Those Amateurs who happen to read CB publications may well raise their eyebrows at some of the extravagant antenna claims trumpeted by some CB antenna makers. In fact, many CBers who become hams may

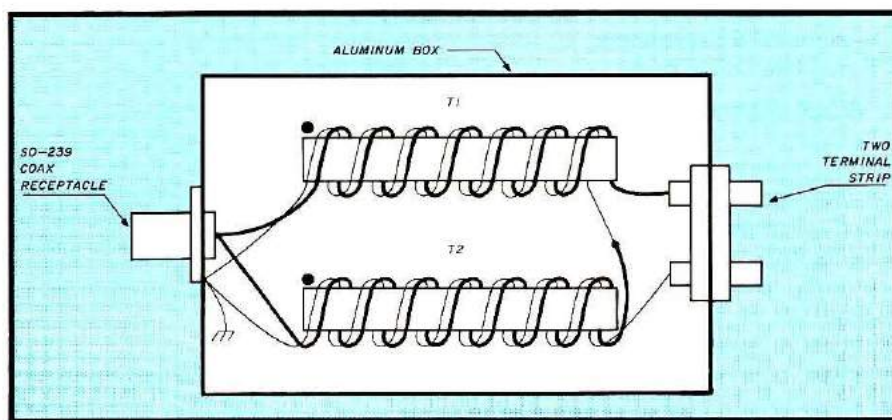

Fig. 4. Transformers T1 and T2 are identical. Each consists of eight bifilar turns of No. 14 (1.6 mm) enamel or Formvar wire. When winding is completed, it will look as if there are sixteen turns in the completed transformer. The wires are wound on side-by-side, the ends being held in a vise to keep tension on as you wind. The ferrite slug is Q-1 material rated for rf application (Indiana-General CF-503). The slug is 12.5 mm (1/2-inch) diameter and about 95 mm (3 3/4 inches) long. The ferrite material is broken to length by nicking it with a file around the circumference, and breaking it with a sharp blow. When completed, the transformer is given a thin coat of Krylon spray. The ends of the winding may be held in place by wrapping the assembly with heavy thread before applying the Krylon. Make sure the windings are interconnected as shown in the diagram, Fig. 3.



wonder why various ham beams produce less gain (on paper) than equivalent CB beams. The reason, of course, is that some manufacturers take advantage of the nontechnical CBers, and try to overpower them with the imaginary virtues of their products. It is a wild game, for sure, and a lot of companies have gone belly-up in the CB business trying to keep up with the numbers game.

Measuring antenna gain is a tedious and expensive business, and it takes a lot of know-how and dollars to make an accurate antenna test-range that will provide meaningful results. Only the larger and better-heeled manufacturers have such luxurious equipment.

Old-time DXperts in the ham game, who have played around with antennas, have come to the conclusion that on-the-air success is 90 per cent operator ability and 10 per cent equipment. Just because you, my friend, are limited to a simple dipole, or an inconspicuous vertical antenna, doesn't mean that you can't enjoy the great hobby of ham radio and work plenty of DX. Contrary to the number of "big signals" you hear on the air, a majority of hams don't own six-element Quad antennas on 170-foot high towers! Plenty of DX can be worked with simple antennas, and we'll discuss practical designs you can build in future columns, too.

### An actual DX Experience "From The Other End"

A few years ago, I had the thrilling experience of working DX from an exotic location — 3AØAF in Monaco, on the coast of the Mediterranean. Each afternoon in the fall, twenty meters would open to the west coast, and my W6 friends in California would pound into 3A-land, via the long path. I knew most of the fellows I worked; had visited their stations and knew all about their power and their antennas. So, it was instructive to listen to them on the air during pile-ups on 3AØAF and on other European DX. I was listening from the viewpoint of the DX station!

No doubt, the "California Kilowatt" stations with huge antennas dominated the frequency. But, the difference in *audibility* and *readability* between these superstations and others

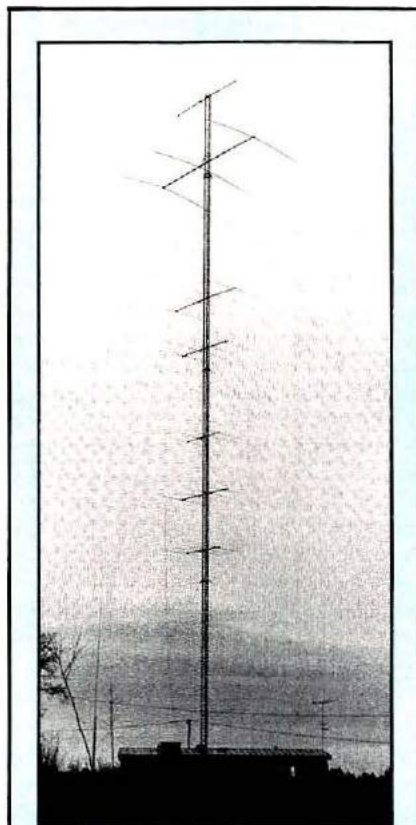

**Tired of QRM?** Do you ever wonder why some stations seem to work all the DX? This picture of the "antenna tree" at OH8SR (Finland) may provide an insight. The main structure is a rotatable tower 205-foot high, guyed to three slip rings. The tower supports a 40-meter, three-element Yagi on a 40-foot boom at 178 feet elevation; stacked four-element over four-element Yagis for 20 meters at 205 and 141 feet elevations; stacked "four over four" for 15 meters at 121 and 79 feet elevations; and stacked "four over four" for 10 meters at 97 and 64 feet. Listen for the outstanding signal of OH8SR, Markku Nyysönen of Finland, and tell him you saw his antenna photo in *Ham Radio Horizons*!

was not all that great. It was comparatively easy, for example, to pull an S6 signal out of a pileup of S9 signals, and I had no trouble at all working many W6 stations running "barefoot" with simple dipole or ground-plane antennas. The secret was that the big stations with the large antennas "opened and closed" the band. But when the band peaked, everybody was more or less on an equal footing. This was the period when the "little

fellow" was able to work DX.

Another fact was observed. It was futile for stations in Northern California to call me when I was working stations in Southern California. I just didn't hear my northern friends at all. The skip moved about as if it were alive. After a week or so, a pattern emerged. The band would open from California to Monaco about 1500Z. That was about 7 AM in California and 4 o'clock in the afternoon at 3AØAF. Calls before that time were wasted; the band was closed. First, I would hear the San Diego area, and in ten or fifteen minutes, I would hear Los Angeles but no San Diego stations at all. Did the San Diego boys quit? I doubt it, they just weren't coming through.

Slowly and predictably, the skip would work up the coast of California — San Diego, Los Angeles, Santa Barbara, San Luis Obispo, San Jose, San Francisco. And finally, I would start to work Oregon stations and — at last — Washington. If the band was very good, I would sometimes work into British Columbia.

Superimposed on this majestic movement of the skip path from south to north was another phenomenon which I called the "Swiss-Cheese" effect. This was most puzzling.

### The "Swiss-Cheese" effect

It was as if there were numerous "holes" in the ionosphere and signals reaching me would often "fall" into these holes. A certain signal would drop out for a period of seconds or minutes, and I would hear someone else in the same area on the frequency. I would talk, on occasion, to two friends in the same town, the stations being only a few miles apart. The signals would fade in and out, and sometimes one would be much stronger than the other for a few minutes. Then the quirky ionosphere would shift, and the second station would be louder than the first.

Because of the "Swiss-Cheese" effect, and the great variations in S-meter readings between various makes of ham equipment, you should not take signal reports too seriously. Just because UK9AAN gives you buddy an S-unit up on you doesn't mean the end of the world. **HRH**



# ARRL Publications!



## The Foundation of a Dynamic Hobby.

- THE RADIO AMATEUR'S HANDBOOK** Internationally recognized, universally consulted. The all-purpose volume of radio. Packed with information useful to the amateur and professional alike. Contains hundreds of photos, diagrams, charts and tables. 57th Ed. **\$10.00 U.S. \$11.00 Canada. \$12.50 Elsewhere.**
- THE RADIO AMATEUR'S LICENSE MANUAL** Study guide and reference book. FCC style questions and answers for Technician through Extra. 77th Ed., 2nd printing. **\$4.00 U.S. \$4.50 Elsewhere.**
- THE ARRL ANTENNA BOOK** Theoretical explanation and complete instructions for building different types of antennas. Simple doublets, multielement arrays, mobile types, rotaries and others. 13th Ed. **\$5.00 U.S. \$5.50 Elsewhere.**
- A COURSE IN RADIO FUNDAMENTALS** Twenty-six chapters present the electrical and electronic principles that are basic to understanding radio circuit operation. 5th Ed. **\$4.00 U.S. \$4.50 Elsewhere.**
- SATELLITE COMMUNICATIONS** Popular series of reprints from QST. Includes *Getting to Know OSCAR from the Ground Up*. 1st Ed. **\$4.75 U.S. \$5.50 Elsewhere.**
- SOLID STATE DESIGN FOR THE RADIO AMATEUR** Thorough treatment of the use of solid state devices. Provides a wealth of tried and proven circuitry plus practical application data. 1st Ed. **\$7.00 U.S. \$8.00 Elsewhere.**
- WEEKEND PROJECTS FOR THE RADIO AMATEUR** Fast and easy projects from accessible parts. Vol. 1 **\$3.00 U.S. \$3.50 Elsewhere.**
- HINTS AND KINKS** If you build and operate an amateur radio station, you'll find this a mighty valuable book in your shack and workshop. Vol. 10. **\$4.00 U.S. \$4.50 Elsewhere.**
- SINGLE SIDEBAND FOR THE RADIO AMATEUR** A digest of the best articles from QST. Includes discussions of theory and practical how-to-build-it descriptions of equipment. 5th Ed. **\$4.00 U.S. \$4.50 Elsewhere.**
- SOLID STATE BASICS** Perfect as a study guide for the beginner or as a refresher for the more experienced builder. Complete with a ten watt transmitter as a workshop exercise. 1st Ed. **\$5.00 U.S. \$5.50 Elsewhere.**
- UNDERSTANDING AMATEUR RADIO** Explains in simple language the elementary principles of electronic and radio circuits. Includes how-to-build-it information on low cost receivers, transmitters and antennas. A "must" guide for the newcomer. 3rd Ed. **\$5.00 U.S. \$5.50 Elsewhere.**
- TUNE IN THE WORLD WITH HAM RADIO** The complete beginner's package. Everything needed to obtain a Novice license: Theory, rules, how to assemble a station, and operating practices. With one-hour code cassette. 2nd Ed. **\$7.00.**
- FM AND REPEATERS FOR THE RADIO AMATEUR** A complete treatment of fm and repeaters. Includes chapters on receivers, transmitters, antennas as well as repeater operation. 2nd Ed. **\$5.00 U.S. \$5.50 Elsewhere.**
- REPEATER DIRECTORY** **\$1.00 U.S. \$1.50 Elsewhere.**
- ARRL ELECTRONICS DATA BOOK** Includes data on radio frequency circuits, filter design, L, C, and R networks, antennas and feed systems. This 128-page reference is a useful addition to the amateur's technical library. 1st Ed. **\$4.00 U.S. \$4.50 Elsewhere.**
- RADIO FREQUENCY INTERFERENCE** A must publication for all hams! Full treatment is given to the causes and solutions for those pesky interference problems. Complete with illustrations and photos of the more common kinds of interference. 1st Ed. **\$3.00 U.S. \$3.50 Elsewhere.**

- THE RADIO AMATEUR'S VHF MANUAL** A thorough treatment of vhf. Covers receiving and transmitting principles, techniques and construction, antenna and feed system design, uhf and microwaves, test equipment, interference causes and cures. 3rd Ed. **\$4.00 U.S. \$4.50 Elsewhere.**
- ARRL CODE KIT** Two cassettes provide practice at 5, 7½, 10 and 13 wpm. Step-by-step progression and use of random code characters plus proven suggestions and hints in the accompanying instruction book make increasing your code proficiency easy! **\$8.00.**
- THE ARRL ANTENNA ANTHOLOGY** Four chapters packed with information on vertical, Yagi, quad and miscellaneous antenna types along with a section on antenna theory and test methods. Taken from the pages of QST. 1st Ed. **\$4.00 U.S. \$4.50 Elsewhere.**
- Q & A BOOKS**
  - NOVICE** **\$2.00 U.S. \$2.50 Elsewhere**
  - TECHNICIAN/GENERAL** **\$2.50 U.S. \$3.00 Elsewhere**
  - ADVANCED/EXTRA** **\$3.00 U.S. \$3.50 Elsewhere**

Prices subject to change without notice

I would like these publications shipped to me postpaid:

\_\_\_\_\_ \$ \_\_\_\_\_  
 \_\_\_\_\_  
 \_\_\_\_\_  
 \_\_\_\_\_

Total enclosed or charge to MC or VISA Account \$ \_\_\_\_\_

VISA Account No. \_\_\_\_\_ Expires \_\_\_\_\_

Master Charge No. \_\_\_\_\_ Expires \_\_\_\_\_

Master Charge Bank No. \_\_\_\_\_

Ship to:

Name \_\_\_\_\_ Call \_\_\_\_\_

Address \_\_\_\_\_ Apt. No. \_\_\_\_\_

City, State or Prov., Zip or Postal Code



The American Radio Relay League, Inc.  
 225 Main Street, Newington, CT 06111



Amateur radio 50 years ago was quite different from what it is today. Virtually all communications were in the continuous wave (CW) mode. Although many hams were already experimenting with radiotelephone, it had not yet come into general use by the then licensed 16,000 Amateurs. Perhaps the most popular tube was the 5-watt UV-202, which was superseded by the 7½-watt UX-210. Five-watt and seven-watt tubes didn't mean power output — it meant how

much plate power dissipation the tube could handle. If you were lucky, a transmitter with a 7½-watt tube would probably deliver 10-15 watts *output*.

Receivers used an oscillating detector followed by a one- or two-tube audio amplifier. Yagi and quad antennas were unknown. Angle of radiation, skip distance, height above ground, and all the other fine points of today's antenna design were ignored. But we got out, and we had a tremendous amount of fun.

Today, we have a lot of transceivers. It's easy now. You can work your buddy on the same frequency, with stable signals both ways, for hours on end. In the early days you called CQ and combed the band for a reply. And I mean the *entire* band! Maybe you made a contact; maybe you didn't. Most likely you didn't, because transmitting equipment was primitive, mostly homemade, and of low power by today's standards. Almost everyone built their own receiver, which

## Adventure In The **SIBERIAN ARCTIC**

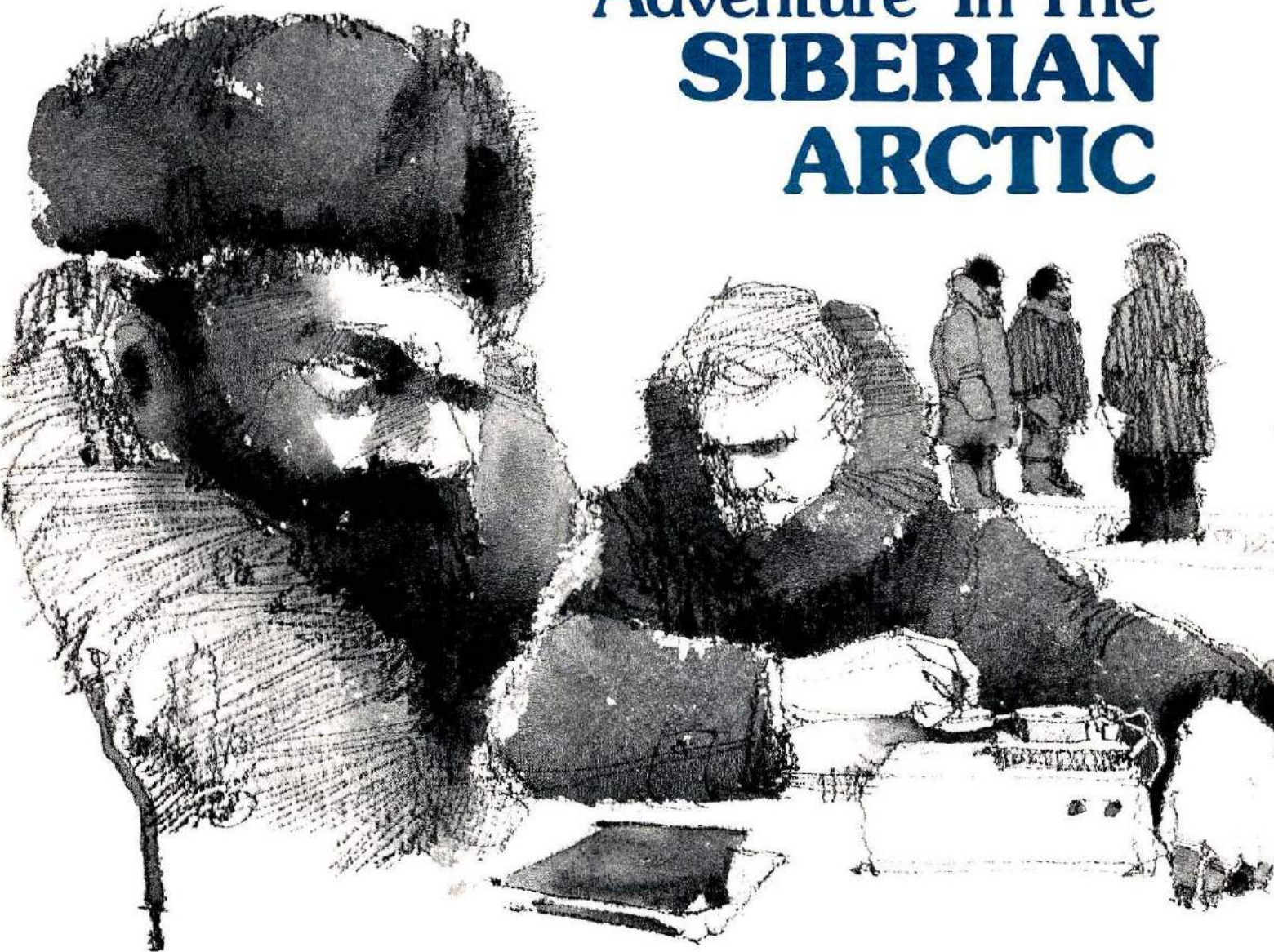



was far from selective. Good tubes using ac heaters had just become available, but were not in general use; "B batteries" supplied plate voltage. As you tuned across the 40-meter band in the early days, signals from Amateur stations were few and far between. There weren't any foreign shortwave broadcast stations as in today's world. Yes, 40 meters was an amateur band.

### Recollections

In 1929 I signed on as radio opera-

tor for the Radiomarine Corporation of America (RMCA) radiotelegraph station that had just been installed on an old wooden 3-masted schooner, *Nanuk*, which was sailing out of Seattle to the Arctic. Before installation, the transmitter had been converted from a spark to an interrupted continuous wave (ICW) transmitter using two 250-watt tubes in a self-rectified circuit. The 500-Hz spark transmitter operated on 500 kHz and lower frequencies. (Shortwave radio was not yet regularly available for ships.)

Having been a licensed ham since March, 1923, I took along my homebrew shortwave receiver, a UX-210, a 32/400-volt dynamotor, and some transmitter parts. This outfit became K7ABF, my portable station call for my home station, 70Y. In 1929, U.S. regulations had been modified to permit Amateur operation aboard U.S. ships, but only when in U.S. ports — not maritime mobile as we know it now. I took this equipment along, not for a DXpedition, but to get messages to and from my family and friends.

My first contacts from *Nanuk* were with K7LY in Cordova, Alaska, and VE5AW in Whitehorse, Yukon Territory, with the little ham transmitter on 40 meters working into the ship's

By  
Robert J. Gleason,  
W3KW

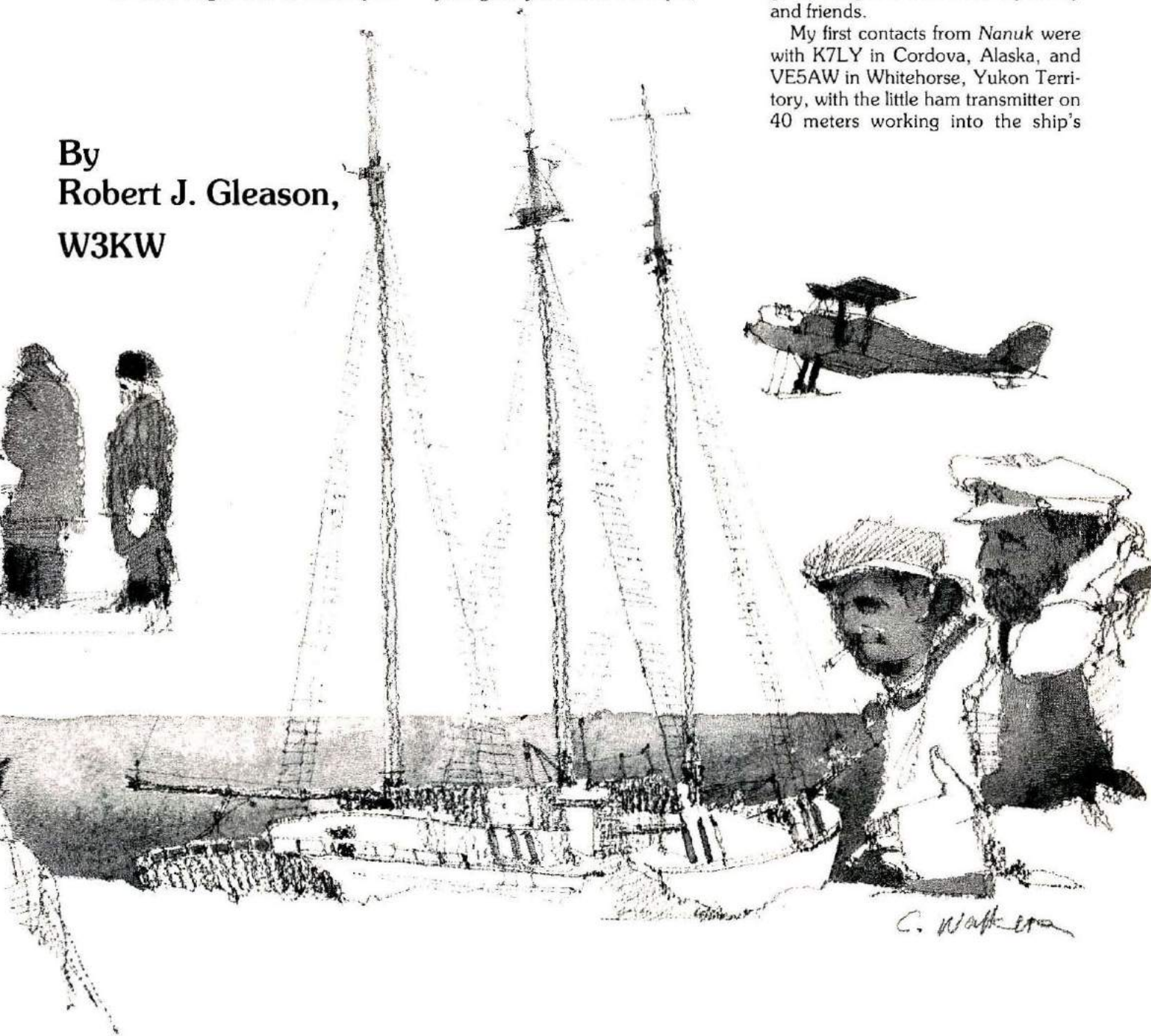



large antenna. The dynamotor whined and QRP really worked! While at anchor off Teller, Alaska, I had several good QSOs with my colleagues in what are now called "the lower 48."

After we left Alaska and went through the Bering Strait into the Arctic Ocean, I didn't expect to use the ham transmitter until we returned to Alaska, but events turned out differently.

### About the ship

I first saw *Nanuk* in dry dock in Seattle. Even on chocks she didn't look very big. She displaced only 237 metric tons and was 37 meters (120 feet) long. *Nanuk* was built in 1892 in Eureka, California, and was originally christened *Ottile Fjord*. In 1923 she was sold to the Northern Whaling and Trading Company and renamed *Nanuk*, the Eskimo word for polar bear. For working the Arctic ice, her hull was sheathed with a thick coating of Australian ironbark.

*Nanuk* was schooner rigged, with a small, low cabin and the wheel aft. Her crow's nest, mounted high on the mainmast for observation and navigation in the ice — and her new radio antenna — distinguished her topside. Below, she had a big six-cylinder auxiliary diesel engine.

One of the four staterooms opening into the after cabin saloon had been pressed into service for the radio shack. Most of the space was occupied by the RCA 500-watt converted spark transmitter and a desk for the receiver. There was just barely room for me, my typewriter, and chair.

For power, I had to depend on an ancient two-cylinder make-and-break-ignition gasoline engine driving a 220-volt dc generator. This generator performed many other duties besides powering the radio equipment. Its output was used for powering a winch for raising sails, anchor, and cargo handling as well as for charging the ship's batteries.

An undesirable complication was that power for the filaments of the two big transmitter tubes came from the ship's 32-volt batteries, which were old and were difficult to keep charged. They were eventually thrown overboard, which ended my ham activities, as discussed later.

All radio equipment used in ocean shipping at the time operated on

## A 1927 Radio Room

Wireless station at the Kake, Alaska, salmon cannery ca. 1927. Top photo shows an overall view. Center photo is the 1/2-kW quenched-gap spark transmitter, which was converted by the author into a CW rig using two 50-watt UV203 tubes (on the bulkhead over the spark rig). The spark transmitter tank circuits were on 500 kHz and lower frequencies, and the transmitter could be used at about 4 MHz by flipping the three-blade knife switch mounted on the upper panel with the tubes and circuitry. The beautifully crafted Colin B. Kennedy long-wave receiver is shown in the top photo at right of the transmitter. This receiver tuned between about 15 kHz (that's right — 15 kHz!) to about 1600 kHz. A two-stage audio amplifier is in the cabinet to the right of the receiver. Craftsmanship of this receiver was exquisite inside and out. The operator, lower photo, looks as if he could use a cup of coffee after battling QRM and the ancient Underwood typewriter.

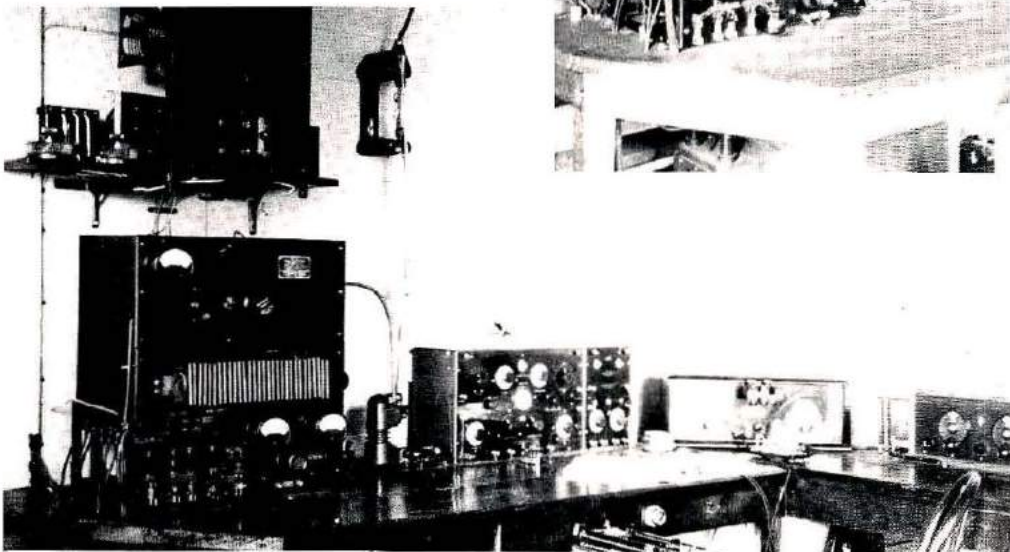
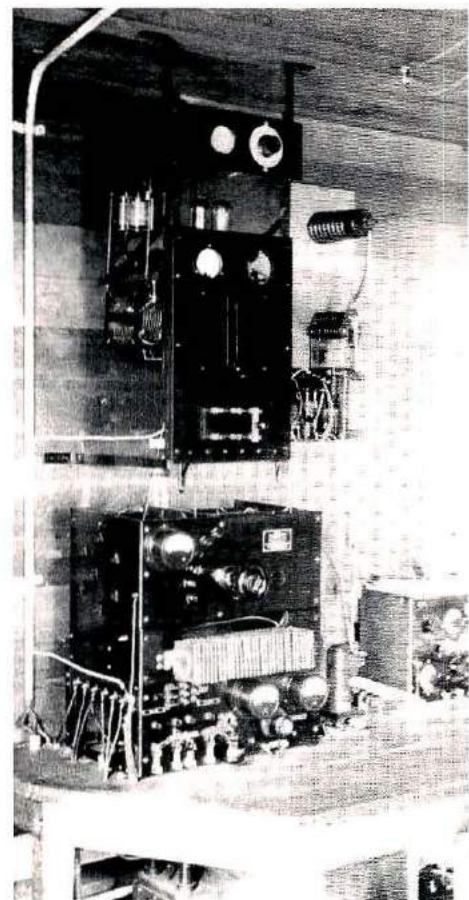







- ★ Technical Forums
- ★ ARRL and FCC Forums
- ★ GIANT 3-Day Flea Market
- ★ New Products and Exhibits
- ★ Grand Banquet
- ★ Women's Activities
- ★ Special Group Meetings
- ★ Hundreds of Prizes
- ★ CW Proficiency Tests
- ★ Amateur of Year Award
- ★ Special Achievement Awards
- ★ Expanded Exhibits and Parking

# DAYTON HAMVENTION '80

**April 25, 26, 27, 1980**

**Hara Arena and Exhibition Center Dayton, Ohio**

Meet your amateur radio friends from all over the world at the internationally famous Dayton HAMVENTION.

Banquet speaker Saturday evening will be Senator Barry M. Goldwater, K7UGA. Seating will be limited so please make reservations early.

If you have registered within the last 3 years you will receive a brochure in late February. If not write Box 44, Dayton, OH 45401.

Nominations are requested for Radio Amateur of the Year and Special Achievement Awards. Nomination forms are available from Awards Chairman, Box 44, Dayton, OH 45401.

For special motel rates and reservations write to Hamvention Housing, 1980 Winters Tower, Dayton, OH 45423. **NO RESERVATIONS WILL BE ACCEPTED BY TELEPHONE.**

All other inquiries write Box 44, Dayton, OH 45401 or phone (513) 296-1165 — 5-10 P.M. EST.

**Rates for ALL 3 Days:**

**Admission:** \$5 in advance, \$6 at door.  
**Flea Market Space:** \$11 in advance, \$13 at gate.  
**Banquet:** \$12 in advance, \$14 at door.

Make checks payable to Dayton HAMVENTION, Box 333, Dayton, OH 45405.

**Bring your family and enjoy a great weekend in Dayton.**

Sponsored by the Dayton Amateur Radio Association, Inc.



# Understanding KEYERS

They're really simple,  
if you know what to look for.

This article was originally presented by N9AKT in the West Allis (Wisconsin) Amateur Club newspaper, *HAMTRIX*, February, 1979. Their permission to reprint is gratefully acknowledged.

BY WILLIAM JONES, N9AKT

One of the most common accessories in the modern ham shack is the electronic keyer. Capable of producing perfect code elements, this relatively simple device greatly enhances one's ability to send and receive CW in our busy bands. As common a device as the keyer is, many new Amateurs do not understand how it works. In the discussion to follow, I will present a schematic diagram of an extremely simple keyer and will examine it stage by stage on an elementary level. This should give the reader a good understanding of basic keyer fundamentals.

## Code elements

Before getting involved in the electronic part, let's back up for a moment and examine the various relationships between dots, dashes, and spaces that form Morse-code characters. The *Radio Amateur's Handbook* tells us that the basic code element is the dot, or unit pulse. A dot and a space is two unit pulses, and a dash is three unit pulses long. The space between letters is three unit pulses, and the space between words is seven unit pulses. Re-

member this relationship, because it will appear later on, when we begin to examine the keyer's operation.

Although this is not designed to be a lesson in digital electronics, I feel the need to define a few terms and acquaint you with the rules concerning the operation of the two building blocks in our keyer. You will see the terms, *logic one*, or "high," and *logic zero*, or "low," used throughout. This simply refers to the *voltage levels* present at the input or output of the

various integrated circuits. For our purposes, a logic one will be defined as nine volts and a logic zero will be at ground potential, or zero volts.

There are only two logic-circuit elements in the whole keyer: gates and JK flip-flops, see Fig. 1. The gates being used are called two-input NAND gates, and they are packaged four to an IC (CD-4011). The rules for their operation are as follows: on any one gate, with either or both inputs low, the output will be high. With both in-

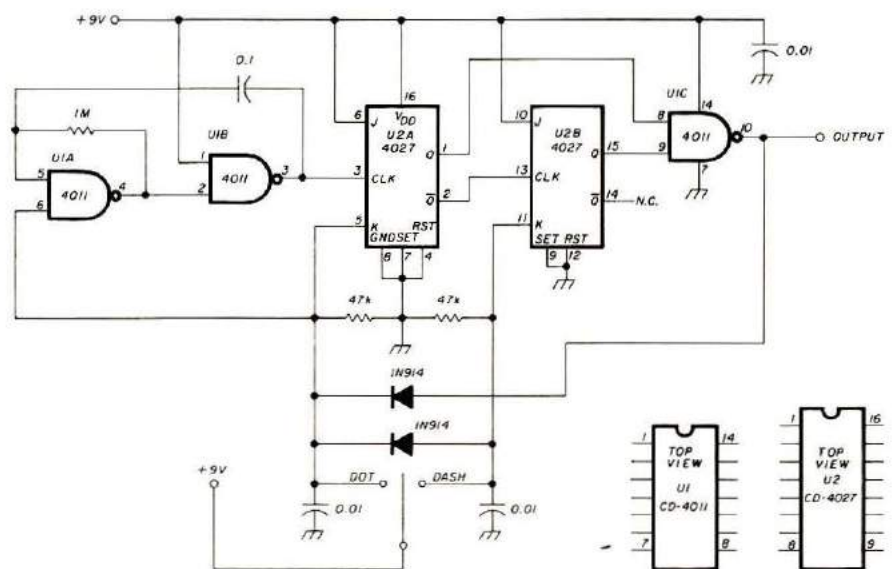

Fig. 1. The schematic diagram of the keyer shows only two integrated circuits and a handful of components. U1, the CD-4011, has four sections, but one of them is unused. The output can be connected to a transistor which will key a transmitter or drive a relay, as shown in Fig. 3.



puts high, the output will be low. That's all there is to it. Try to memorize this, or at least be prepared to refer back to this paragraph, as it is essential to the understanding of the keyer.

The JK flip-flops come two to the package (CD-4027), and are simple to understand in the way they are being used here. The flip-flops can be controlled by using any of the inputs (set, reset, J, or K). For this discussion, I will disable everything except the K inputs. Notice that there are two outputs, Q and  $\bar{Q}$  (called *not* Q). These outputs complement one another. That is, when one is high, the other will always be low, and vice versa. Finally, note the clock inputs (pins 3 and 13 respectively). Although the logic state of the K input dictates what the outputs will do, it will not happen until the positive-going edge of a square-wave clock pulse is presented to the flip-flop. The CD-4027 chip is a dual, edge-triggered JK flip-flop. Now, here are the only rules we will have to consider regarding the operation of the flip-flops: If K is *low*, a clock pulse forces Q high and, of course,  $\bar{Q}$  low. If K is *high*, clock pulses cause the Q and  $\bar{Q}$  states to alternate.

### How the works work

Now it is time to examine the innards of the keyer. The first trip through the logic may seem confusing, but try to think your way through a step at a time and it will become clear how things work.

Refer to Fig. 1 and you will see that there are four stages involved. Gates U1A and U1B form a digital relaxation oscillator which I will refer to as the "clock." It is the heart of the whole system, and its function is to generate a string of square-wave pulses, upon command, to be presented to the clock input of U2A. The logic level at pin six of U1A determines whether the clock is running or not. If pin six is high, the clock begins running, and if pin six is low, the clock is inhibited (stops running). Okay so far? Let's continue.

The JK flip-flop, U2A, is the dot generator; its job is to convert the clock pulses from pin three of U1B to a symmetrical square wave at its Q output, pin one. In the process, it divides the clock frequency by two.

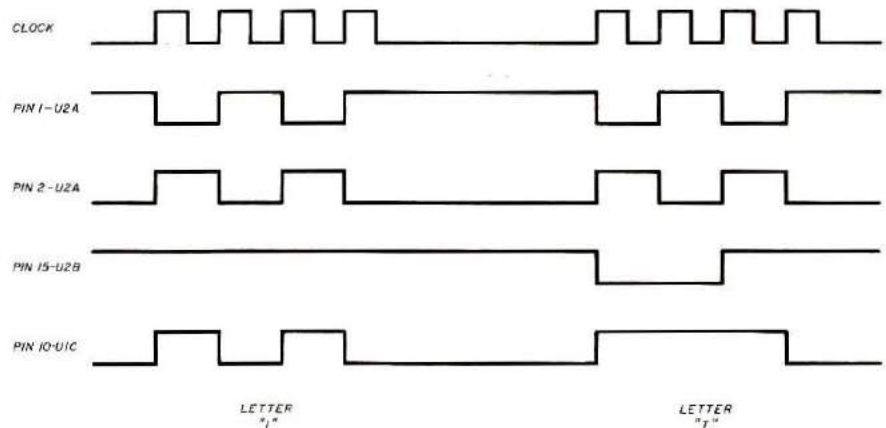

Fig. 2. The train of pulses and logic levels found at various points in the keyer.

The second JK flip-flop, U2B, is the dash generator; its function is to fill the space between two consecutive dots to form a perfect (three-unit-length) dash. This method of dash generation is almost universally used, and accounts for the precision character lengths so typical of modern digital keyers. You'll see how U2B accomplishes this task shortly.

Finally, U1C serves as an output gate, and can be used to drive a transistor which will either key the transmitter directly or operate a high-speed reed relay to do the job.

### Getting your act together

Let's generate a "dit" with the keyer, and watch everything work in slow motion. Refer once again to Fig. 2, and consider the logic levels of the various inputs and outputs before the dot paddle is closed. Pins five of U2A and six of U1A are low by virtue of the 47 kilohm resistor connected to ground. The clock is inhibited (stopped). Pin one of U2A is high (remember the rule for a JK flip-flop when K is low). Pin fifteen of U2B is also high for the same reason. Finally, pin ten of U1C is *low* because both inputs to the gate are *high*. It will help you to visualize the action about to take place if you lightly mark the logic states just described on the schematic, and then change them one step at a time. Ready? Here we go.

Closing the dot lever brings pin five of U2A and pin six of U1A high. The clock begins running by changing from a low to a high, and a positive going clock pulse is now being presented to the input; the outputs can now change states, see Fig. 2. Q goes low, which forces pin ten of U1C

high, and our dit has begun. With the next positive going edge of the clock pulse, the Q output of U2A again changes state and ends the dit. If the dot lever were to be held closed, the cycle would repeat itself endlessly. Notice that pin ten of U1C is also connected to the dot lever by means of a 1N914 diode. This would continue to hold the K input and clock control line high, even if the dot lever had been released before the dit was finished. Thus, all characters are self-completing, once initiated.

### Filling the gaps

So far, the dash generator, U2B, has contributed nothing except a logic one to pin nine of the output gate. Big deal! Let's generate a dash and see how it works in conjunction with the dot generator to form a perfect, three-unit-length letter "T" at the output.

Closing the dash lever does two things. Besides bringing the K input of U2B high, it also starts the clock running by forward biasing the second 1N914, thus bringing pin six of U1A high. Again, see Fig. 2. As the dot generator changes states, its  $\bar{Q}$  output (pin 2) goes high and causes pin fifteen of the dash generator to go low. The output gate now has two logic zeros on its inputs but the result is still the same; pin ten is high. Review the rules for NAND gates if this seems confusing to you. With the continuing string of clock pulses to the dot generator, its output will again toggle (change states), causing pin eight of U1C to go high again — but pin nine is still low and the output gate is still at a logic one. The third time the dot generator changes states, a positive-going pulse is again generated at the







Tom McMullen, W1SL

# ATLAS <sup>210/</sup> <sup>215X</sup> Owners' Survey

Read what over 100  
Atlas owners have to say about their rigs.

As this summary was being prepared for the magazine, announcement was made stating that Atlas was closing its Amateur Equipment Manufacturing plant doors. This is saddening news from several points of view. It means that Amateurs have one less option when they start shopping for new equipment; it also increases their reliance on imported radios. Disheartening, too, is the realization that people who, in the past, have been responsive to Amateur needs are no longer feeding the pipeline that ends in the hamshacks of thousands of DXers, traffic-hounds, sailors, mobileers, and vacation-bound hams with a rig in a suitcase or tucked under an arm.

Here, again, we are reporting on a rig which is no longer produced — but our report is still valid because there are several thousand Atlas rigs out there. You'll find them offered for sale on supplier's shelves, in classified advertising, at flea markets, or perhaps at a local swap-fest or auction. This report will give you a "handle" on what is good or bad about the rigs, and an indication of the results you'll get from one perched on your desk. Read, enjoy, and make the best deal you can.

Note: For those of you who own Atlas equipment, or are concerned about service if you find a good buy on an Atlas, there is a place to get the rigs fixed. Specialty Communications, 2523 Peach St., Erie, Pennsylvania 16503, will handle both in- and out-of-warranty repairs. Write to (or call) them before shipping your rig, however. Now to the report.

#### What's good about it?

Plenty of hams had good things to say about their Atlas rigs, but the majority, 59 per cent, liked the size best of all (lightweight, compact, portable), see **Table 1**. The next best-liked feature was "No Tuning" (broadband, ease of band changing), at 26 per cent. This was closely followed by "Simplicity" (ease of operation, not cluttered with knobs). Other well-liked features ranking near the top were Good (Ideal) mobile rig, 12-volt operation, Excellent performance, and Solid-state design. **Table 1** represents the number of times a particular feature was mentioned, tabulated from a total of 110 replies.

Some comments about likes and good features: "It's small, compact, and works from 12 volts. I have used

it all over the African continent, portable and mobile." — WA2RUD. "Because the rig is solid-state it is not necessary to tune up each time it is to be used, or each time the band is changed. I use it mobile very often, and it has to be by far the best mobile rig on the market." — WB9ZLO. "Easy to operate in shack, car, or on boat — by me or any licensed ham, even if he has never used an Atlas before." — WB3HZC. "(I like) the slide-in mobile bracket." — N8DM. "Small size and 12-volt supply make it great for mobile use." — AL7B. "(It is an) excellent mobile unit. I purchased it strictly for that purpose. Easy to use with minimum 'hands-on' time while driving." — WA5CMC. "Good sensitivity and selectivity, and ease of operation when switching bands." — WA7SAA. "I have taken this rig all over the world on many trips. Carried it as hand baggage, shipped it by mail, shipped it as baggage, and it always operates — sometimes for several days of continuous operation in a poor environment." — N5RM. (Look at the list of calls this rig has operated under: W9DD/KG6S, N5RM/C6A, /KG6, /KG6S, /KC6E, /KG6W, /NH2, /G5BYY, GU5BY,



GJ5BYY, F0EWY . . . "Probably 15,000 contacts in 3 years." The rig is well-traveled.) "The easy changeover from base to mobile operation." — WA9DKG. "Fits my Datsun well . . . the slide-in mount is great!" — W6JEX. "No tuning involved for mobile use; does not take much room in the car." — WA6AKQ. "The Atlas 210X was easy to operate and never gave me a bit of trouble in the two years I owned it." — WB5YWX.

And, finally, from WB7DBS — "It is easy to take mobile and portable, and I operate both. It is also very durable — the rig was in a car wreck and survived a big jolt which didn't seem to bother it. I leave it in the truck when it is bitter cold . . . sure takes a lot of misuse." (In answer to a later question, he further states that there is a bit of drift, "But, then, it sits by a heater duct!").

#### What's bad about it?

There were many comments about dislikes, too. The most-often-heard grumble was about the dial mechanism and the calibration of it (21 per cent). This was followed by VFO drift at 12.7 per cent, and "No Sidetone" and "No RIT" at 10.9 per cent each. **Table 1** shows the list of "worst features," as well as the good ones. "Too sensitive to SWR/mismatch" drew about 10 per cent of the vote in its unfavorable category.

Some owner comments on this side of the coin: "The dial readout had a total of 22 division marks. This means you have to guess where you are in the band. 25 divisions would have been better." — WA6OWM. "Drifting is very noticeable, especially on 40 meters." — WA8KOQ. "No RIT . . . transmit and receive frequencies are not exactly the same." — WB6FBM. "VFO dial backlash . . . feels like you're winding up a spring. It's hard to tune in SSB signals." — WA0DYZ. "I seldom use CW, but need to hear myself when I'm sending." — W1DQO. "I spent over \$150 to get the noise out of my car. I have other rigs in the car completely quiet, but not the 210X. When the noise blanker is on, the radio will pick up A-M/FM broadcast bands." — WD4DAH. "No RIT makes it very difficult to use in RTTY QSO." — F6EYG. "Unstable VFO . . . totally unsuited for Air Force MARS operation and RTTY oper-

# hy-gain®

## 18HT The World's Finest Multiband Vertical

The 18HT "Hy-Tower" is the only full size, automatic band-switching vertical antenna for 80 thru 10 meters on the market today! It features a unique stub decoupling system which effectively isolates various sections of the antenna so that an electrical ¼ wavelength (or odd multiple of a ¼ wavelength) appears on all bands. As a result, the VSWR is less than 1.5:1 at resonance 80 thru 10 meters.

#### Typical 2:1 VSWR Bandwidths are:

- 700 kHz on 10 meters
- 300 kHz (or better) on 15, 20, and 40 meters
- 250 kHz on 80 meters

**With the addition of a base loading coil, the 18HT also provides exceptional 160 meter performance!**

Many 18HT's have been in service for 15 years or more and they still deliver "original spec" performance. This enviable record is the result of Hy-Gain's no-compromise attitude toward materials and construction. The 18HT is complete with a 24 foot galvanized tower that supports the entire system without guys in winds up to 75 mph. The top section consists of dependable 6063-T832 taper swagged aluminum tubing that extends the antenna to an overall height of 50 feet. A special hinged base allows complete assembly on the ground and permits easy raising and lowering.

Hy-Gain offers a wide selection of vertical antennas as well as a complete line of beams and crank-up towers. Write for detailed information today!

**TELEX hy-gain®**

TELEX COMMUNICATIONS, INC.

DEPARTMENT H-24

8601 NORTHEAST HIGHWAY SIX, LINCOLN, NE 68505 U.S.A.  
EUROPE: 22, rue de la Légion d'Honneur, 93200 St. Denis, France

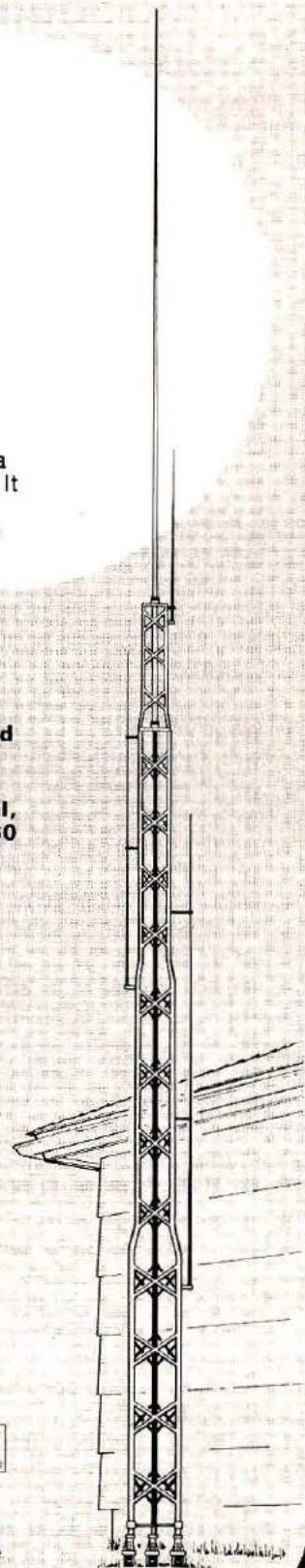



ation." — W4YP/AFB2MC. "Special antenna tuner is required if large frequency excursions are anticipated." — (unnamed by request). "Rigs will not tolerate impedance mismatch or moderately high SWR." — WB5VCU. "Worst Feature? Noise blanker . . . I'm not at all sure it works." — W7DFC. "Noise blanker . . . when it's on in high-signal-level conditions, causes noise and out-of-band signals to be heard." — AE9H. "Readability of VFO dial is a bit coarse, and I wish the calibrator had a 10-kHz position. I often find myself depending upon someone else for precise frequency setting." — WB5AOH. "Rotary switch has to pass through 'Transmit' to get to 'CW,' unless an external switch is used. I am often in a noisy area, and with the microphone plugged in, there is a burst of noise before you can send CW." — ZS6BBW. "Like most American-made rigs, it doesn't have all six high-frequency bands. I like to work six bands, not just five." — W8HXC. "Too broadbanded for use with CW in QRM without an external filter." — KI4X.

### What's troubling you?

Now for a look at the trouble spot, question 12 — have you had any problems? A quick totaling of the digits provides this information:

No = 38.2 per cent  
Yes = 61.8 per cent

Some specific troubles are listed, by number of times reported, in **Table 2**. The most-frequently reported trouble, final transistor failure, seemed to be one of those "when the rig was new" phenomena. Several hams commented about the early failure, and some had nice things to say about the prompt service or quick replies from the factory in response to pleas for help.

"Diodes and transistors failed when rig was new." — WDØBYV. "Final transistors failed in spite of protective circuits — there was no apparent reason, like high SWR or . . .?" — DL2QB. "Power-amplifier (transistor) went, was fixed by service rep in one hour." — WD4ASW. "Blew rf-driver transistor once, it took about 30 minutes to troubleshoot and fix, so no major problem." — N4SC. "Output

**Table 1.** Best and Worst Features tabulated from 110 reports. Some respondents listed more than one feature liked or disliked.

| Best Feature   | Per Cent |
|--|----------|
| Size (lightweight, compact)  | 59.0     |
| Broadband (no Tuning)  | 23.6     |
| Simplicity (ease of operation)   | 21.8     |
| Ideal (excellent) mobile rig   | 12.7     |
| Excellent performance  | 11.8     |
| Good portable rig  | 9.0      |
| Quick installation   | 5.4      |
| 12-volt supply   | 5.4      |
| Solid-state construction   | 5.4      |
| Rugged (reliable)  | 4.5      |
| Versatile  | 4.5      |
| Frequency coverage   | 1.8      |
| American made  | 0.9      |
| Noise Blanker  | 0.9      |
| Selectivity  | 0.9      |
| Worst Feature  | Per Cent |
| Dial mechanism/calibration   | 20.9     |
| VFO drift  | 12.7     |
| No sidetone  | 10.9     |
| No RIT   | 10.9     |
| Too SWR sensitive  | 10.0     |
| Poor noise blanker   | 8.1      |
| No CW filter   | 6.3      |
| No QSK (break-in)  | 4.5      |
| Key and Mic jacks in rear  | 3.6      |
| Poor switching to CW   | 2.7      |
| Incomplete 10-meter coverage   | 1.8      |
| Poor AGC   | 1.8      |
| TVI/harmonics  | 1.8      |
| Only 5 bands   | 1.8      |
| Poor cabinet, no QRP switch, no VOX, poor image rejection, poor power supply, receiver overloads easily, spurious signals — each | 0.9      |
| None   | 11.8     |

**Table 2.** Troubles reported by those who answered "Yes" to Question 12. Some listed more than one problem.

| Trouble  | Number of Instances |
|--|---------------------|
| Final transistor failure   | 19                  |
| VFO drift  | 16                  |
| Will not load to antenna   | 4                   |
| Noise blanker defective  | 4                   |
| Receiver quit  | 3                   |
| Low transmitter output   | 3                   |
| Power supply quit  | 3                   |
| Transmit/receive frequency not the same  | 3                   |
| FMing  | 3                   |
| Poor receiver sensitivity  | 3                   |
| Images/spurious signals in receiver  | 2                   |
| Hum, AGC circuit, alignment, poor service, transmit/receive relays failed, speaker rattle, faulty VFO drive — each | 1                   |

transistors went west slightly after their warranty period, but were replaced free of charge by the manufacturer." — WA2QLT. "One (PA) transistor had high leakage current, consequently idling current was unstable

and this caused distortion. Dealer sent a matched pair, free!" — F6CVU/W2.

I noted some comments on other troubles as I skimmed through the reports: "A thermal-sensitive chip shut



**Table 3.** Accessories purchased for the Atlas 210/215X.

| Item                            | Per Cent |
|---------------------------------|----------|
| Mobile mount                    | 37.2     |
| Power supply                    | 28.1     |
| Digital readout                 | 27.2     |
| Console                         | 18.0     |
| Noise blanker                   | 16.3     |
| VOX                             | 10.0     |
| Crystal oscillator              | 9.0      |
| Mobile Matcher                  | 9.0      |
| Remote VFO                      | 9.0      |
| Microphone                      | 2.7      |
| Antenna Tuner                   | 2.7      |
| Audio filter,<br>speaker — each | 0.9      |

the receiver down when it was cold.” — WAØVLT. “Exposed collector of driver transistor mounted on rear heatsink can destroy the transistor, along with several components, if shorted to ground.” — AE9H. “The original noise blanker did not work perfectly. The replacement does.” — W4NSP. “FMing! I sent it back to the factory three times — the third time I got a new 210X. It’s still bad!” — WD4DAH. “Had to request information from the factory on adjustment of the noise blanker kit.” — WA2ICE. “Rig broke down three times so far. Repair took as long as 2 months from Atlas. Cost of repair was low from Atlas, relatively low from dealer.” — WA2QWR. “AGC was slightly out of adjustment when I purchased the set.” — W8IFI. “Drift was excessive, but factory corrected it.” — WA8MQS. “Did not transmit and receive on the same frequency on 75-80 meters. Called manufacturer, and they repaired it and put in all the latest modifications free.” — K9CGD.

### Service

A natural follow-up to the listing of troubles and problems is question 13: Have you had the rig serviced? In reply, they said:

No = 40.9 per cent  
 Yes = 49.0 per cent  
 No answer = 10.1 per cent

Of those who had their rig serviced, 74 per cent went to the manufacturer, 7 per cent went to a dealer, and 18.5 per cent checked “other,” which included “myself” several times.

As to the quality of the service, 85 per cent were satisfied and 11 per cent were unhappy; 4 per cent didn’t

# headsets

## New Headsets With Selectable Microphone Impedance

When traffic is heavy and the session is long, you need the comfort and efficiency of a Telex headset. The new ProCom 300 and ProCom 200 provide hands-free operation and the exact mike-to-mouth distance for consistent and reliable VOX operation.

### ProCom 300

The ultimate in comfort, the ProCom 300 is an ultra-light, single-sided, aviation style headset with a powerful, electret noise-cancelling microphone. This dual impedance microphone has a 200 to 3500 Hz frequency response specifically tailored to the human voice. The earphone has a low impedance, dynamic element with a sensitive tailored frequency response of 300 to 3000 Hz.

### ProCom 200

This dual muff headset has a powerful, dual-impedance, electret microphone with a typical frequency response of 200 to 3500 Hz. The dynamic, low impedance headphone has a very sensitive 200 to 12000 Hz frequency response.

Footswitch (FS-1) and handswitch (HS-1) accessories or the built-in VOX select switch provide total professional flexibility. Write for complete details today.

**TELEX hy-gain**

TELEX COMMUNICATIONS, INC.

DEPARTMENT H-26

8601 NORTHEAST HIGHWAY SIX, LINCOLN, NE 68505 U.S.A.  
 EUROPE: 22, rue de la Légion-d'Honneur, 93200 St. Denis, France.

Tower shown is  
 The NEW Hy-Gain  
**HG-52SS**  
 Self Supporting  
 Crank-Up Tower



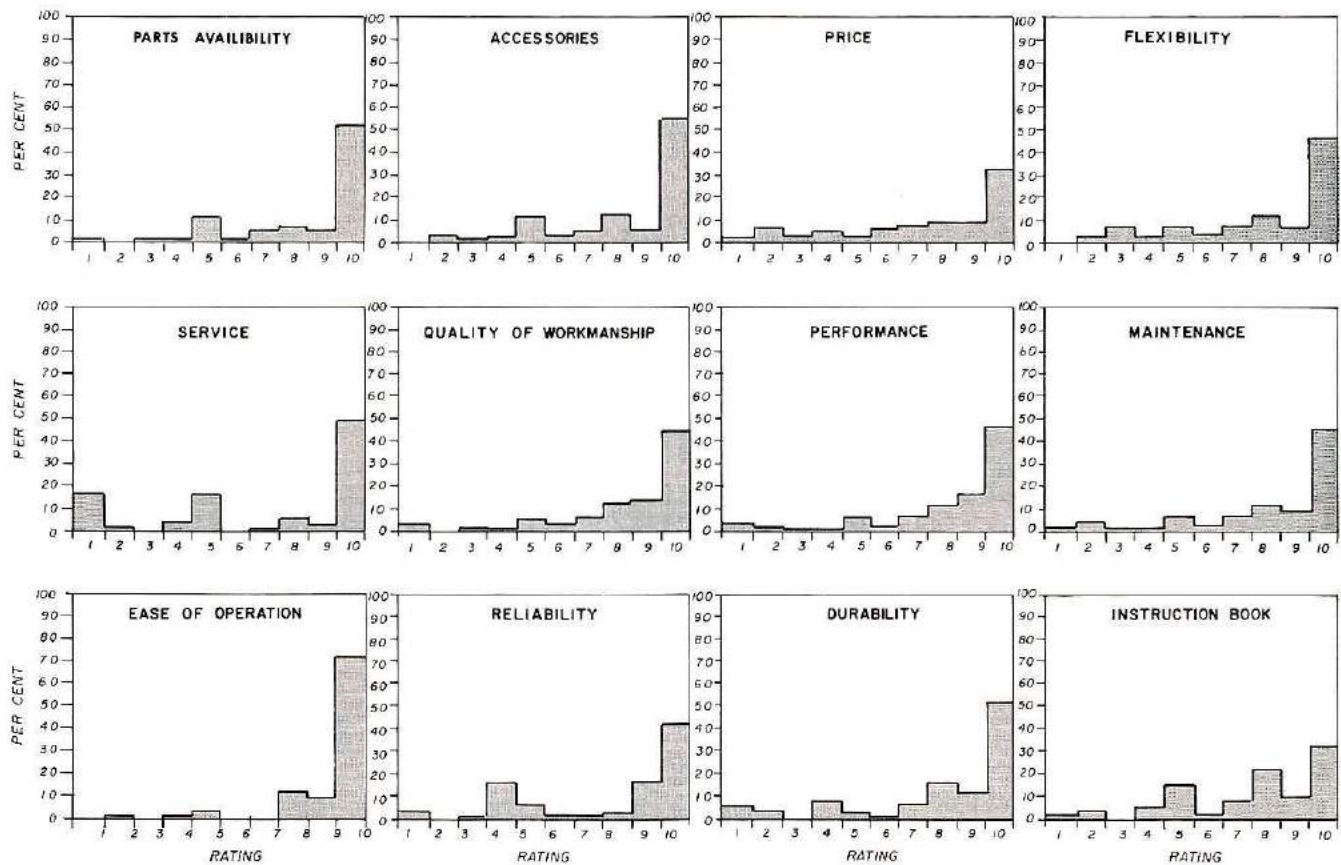

**Fig. 1.** The answers to question 21, the ratings, provide this group of "skyline" profiles for the various categories. They show percentages of the number of respondents who answered each category. The features receiving a predominately good rating have more weight at the upper end of the scale.

say one way or the other. Perhaps I should have stated the question a bit differently. Some people answered question 13 with a "No," then indicated that they repaired it themselves. Others answered "Yes," when they serviced their own rig. This ambiguity meant that I couldn't just count the "No" answers, but had to read the whole response to see what happened. I foresee another revision to future questionnaires!

The question of quality of service may seem a bit academic at this point, in view of Atlas' closing their doors. However, there are still dealers who also service rigs, and there are other manufacturers who might like to know what their prospective customers like and dislike. Then, too, it might lead you to be a bit more inquisitive about what you buy and who is behind it — which is a benefit, in the long run. So, here are a few BOOs and HISSes, and some applause:

"Factory service in (repairing) blunders on my part has been superb." — WB6AJR. "Trouble with 220-CS power supply. (It was) in warranty

and there was no trouble with dealer repair." — (Unnamed by request). "Poor reception . . . the person I talked to at the factory couldn't give me the answer. I sent (the rig) to the factory for service but they did it no good." — WA7GSM. "Receiver sensitivity not as good as on later models. Atlas has adjusted and tuned it up twice, at no charge!" — WB3HZC. "No power when rig was purchased, dealer obviously had not checked it. He advised me to send it to the manufacturer (why do I need the dealer?). Manufacturer handled it very promptly." — KB5BX. "RF finals (transistors) blew up into open feedline because of self-oscillation. Service was excellent, and Clint Call (service manager) was great!" — WA2RUD. "I can't use (the rig) because it's sitting on a shelf at the factory, waiting for a technician to look at it. At first, maintenance was exemplary, but there has been a change in Customer Service personnel, and it has not been an improvement!" — (Unnamed by request).

W4UD says, "Only rig I ever used

for five years with no problems!"

Just in case you missed it at the start of this article, let me remind you again that there is still a place to get Atlas rigs serviced. If you have a problem with your Atlas equipment, either in warranty or out of warranty, get in touch with Specialty Communications, 2523 Peach St., Erie, Pennsylvania 16503. I suggest you write or call them *first*, before you ship the rig.

#### I'd like to have . . .

Have you been able to obtain all the accessories and parts you need? In answer to this question, 80 per cent said yes, 4.5 per cent said no, and 15.5 per cent were not listening (I guess), or maybe they didn't need anything.

Of those who did buy accessories, (question 17), 72.7 per cent said yes, we're satisfied with them, 9 per cent didn't like them, and another 18.3 per cent didn't answer. **Table 3** shows a list of some of the things and goodies bought to go with their rigs.

A look at some of the accessories wanted includes: remote VFO, CW



filter, digital readout, antenna tuner, speech processor, noise blanker, linear amplifier, phone-patch, carrying case, and a quick-disconnect for the dc cord.

Those, as near as I could interpret the answers, were accessories wanted, but not yet purchased. In the category of features they would like to see I find: RIT (top of the list), built-in sidetone, built-in VOX, bandpass tuning, full break-in, WWV capability, notch filter, digital dial, full 10-meter coverage, rf-output meter, better dial mechanism, pulsed calibrator signal, spinner knob for tuning, and better customer service!

### Would you do it again?

If I asked this question now, in view of the latest developments at Atlas, the response would most likely be "Are you kidding?" However, the intent of the question was to find out if the buyer felt that he got enough of a good deal that he would make the same deal again. So, on that basis, a look at the answers to question 25 reveals:

|           |                 |
|-----------|-----------------|
| No        | = 57.2 per cent |
| Yes       | = 28.2 per cent |
| Maybe     | = 4.6 per cent  |
| No answer | = 10.0 per cent |

A few added comments indicating poor service as the reason, but most who said no indicated that later rigs with more built-in features had caught their eye. Some had already traded their 210/215 for something with more knobs and goodies, but reported on their past experience with the Atlas transceiver.

### The ratings

Fig. 1 shows the overall pattern of the ratings. Some respondents felt compelled to comment, instead of simply supplying a number, and others provided both a number and a comment. Others misinterpreted the question, and, in a spot marked "Price," answered with the exact dollar figure they paid out. That's not what I had in mind at all. I wanted an opinion of the price, based on the value you think you received. (Yes, I know, *everything* costs too much — especially to those of us who can remember buying enough parts to build a receiver for \$10. But, then, wages were a bit lower, too.)

Anyway, the ratings charts, called "histograms" by those who know about such things, sum up the opinions of Atlas owners for the various categories. Again, if a category was left blank, it was not used in the total.

### Dealer or ?

For a clue as to where you might find Atlas rigs, here's a summary of those answers. Don't discount the "Dealer" category, because there are still plenty of rigs out there, and many will show up on shelves of Amateur equipment suppliers who are not necessarily "factory authorized" Atlas dealers.

|             |                 |
|-------------|-----------------|
| Dealer      | = 69.0 per cent |
| Mail Order  | = 11.8 per cent |
| Individual  | = 11.8 per cent |
| 800 Number  | = 0.9 per cent  |
| Flea Market | = 0.9 per cent  |
| Other       | = 5.6 per cent  |

A further look at this early part of the questionnaire shows that, in answer to "Would you buy from the same source again?" the totals are:

|           |                 |
|-----------|-----------------|
| Yes       | = 90.0 per cent |
| No        | = 6.3 per cent  |
| Undecided | = 3.7 per cent  |

Apparently, hams are not holding the rig's troubles against the dealers or other sources — in most cases. Of the 6.3 per cent who said "No," five of the replies showed that there was very poor service provided by either the dealer or the manufacturer, usually without the trouble(s) being fixed, or there were too many long delays involved in getting the repairs/modifications done and done right. The remaining two forms, after careful reading, lead me to believe that the negative response was because the owners would go for a different brand of equipment next time around, but not necessarily because they were grossly dissatisfied with Atlas or their dealers. There's a lesson there — communication and cooperation between parties is vital.

### Next time

As you read this, I'll be fingering the buttons on my calculator, adding up the responses to our survey No. 2. It'll be interesting to see how people feel about three different rigs — Yaesu, Heath, and Ten-Tec. And then, farther down the road, some vhf rigs.

HRH

# Reliability Service Experience



**CDE T-2X**  
**\$197.00**  
**prepaid**



**CDE  
HAM IV**  
**\$145.00**  
**prepaid**



**ALLIANCE  
HD-73**  
**\$109.95**  
**prepaid**

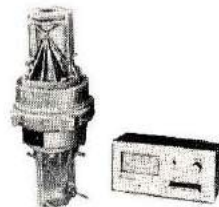

**KENWOOD  
TR-2400**



**Check our price last!**

**PREPAID SHIPPING  
CONTINENTAL 48 ONLY**



Quantities limited. Michigan residents add 4% sales tax. Please include your area code and telephone number with any correspondence.



# RSE HAM SHACK

1207 W. 14 MILE, CLAWSON, MI 48017  
(313) 435-5660

31155 PLYMOUTH, LIVONIA, MI 48150  
(313) 522-4232

**MAIL ORDER TELEPHONE  
(313) 435-5660**



# New from Longs . . . Kenwood R-1000 compact communications receiver KENWOOD

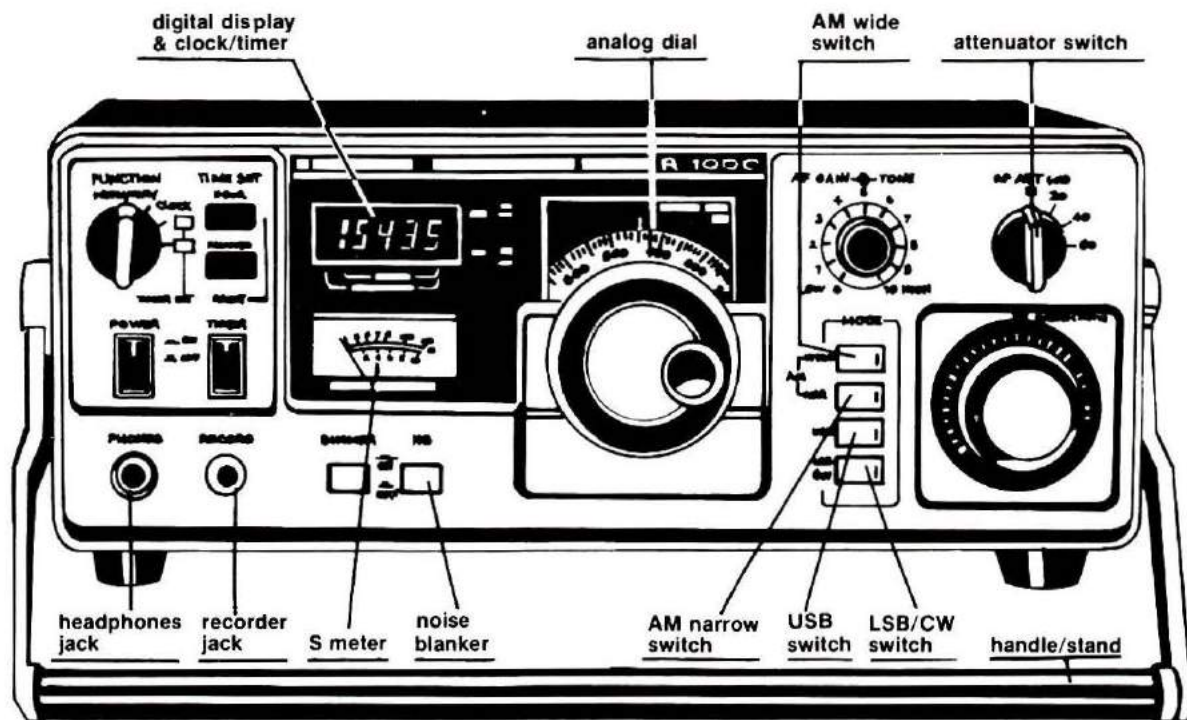

The new, compact (12<sup>3</sup>/<sub>4</sub>" x 4<sup>1</sup>/<sub>2</sub>" x 8-9/16"D) R-1000 is a high class general coverage receiver covering 30 bands from 200 KHz to 30 MHz. It features: PLL synthesizer, digital display readout (1 KHz step) and analog dial calibrated at 10 KHz intervals from 0 to 1,000 KHz. The 12 hr. quartz digital clock with timer can be set to go on or off at any time. A stepped RF attenuator provides 20, 40, and 60 dB attenuation to protect the unit from damage by high input power signals. Also features: 3 stage IF filter, tone control, built-in noise blanker, dimmer switch, recording terminal, selectable AC power voltage (100, 120, 220 or 240 VAC), wire antenna terminals and UHF connector (SO-239 for coax cable), large 10 cm built-in speaker, external speaker jack, 2 position antenna selector switch, accessory terminals for timer and muting circuit. Has calibrated S meter, AF gain control, 4 mode switches. Selects LSB/CW, USB, narrow AM or wide AM.

Sensitivity (S + N/N 10 dB or more): SSB 200 KHz - 2 MHz: 5 micro V, AM 50 micro V, SSB 2 MHz - 30 MHz: 0.5 micro V, AM 5 micro V. Frequency stability: ± 2 KHz Max. from 1-60 min. after power on, + 300 Hz max. in every subsequent 30 min. Selectivity AM (wide) 12 KHz at -6dB, 25 KHz at -50dB. AM (narrow) 6 KHz at -6dB, 18 KHz at -50dB. SSB/CW 2.7 KHz at -6dB, 5 KHz at -60dB.

## 499.00

List Price. Call for quote.

# Long's



Use your Master Charge or BankAmericard/VISA when you order.

# Ham Radio Department Store

MAIL ORDERS: P.O. BOX 11347 BIRMINGHAM, AL 35202 • STREET ADDRESS: 2808 7TH AVENUE SOUTH BIRMINGHAM, ALABAMA 35233



Call  
Toll Free

# 1-800-633-3410

IN ALABAMA CALL 1-800-292-8668 9 AM TIL 5:30 PM CST, MONDAY THRU FRIDAY

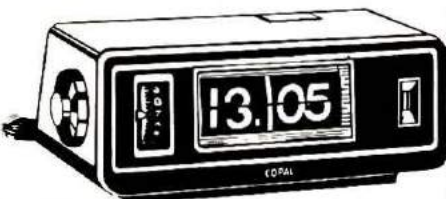

**COPAL RP-205 24 hour clock with 24 hour alarm**

A highly accurate 24 hr. clock with a 24 hr. alarm system that you can set for either AM or PM and in 10 minute intervals. It also features illuminated leaf type numerals and a precision synchronous motor.

**19.00 ea.**

**NEW!**

**COPAL QG-500 pocket sized 24 hour World Timer**

This clock tells the time in 24 world locations. Quartz crystal accuracy using a 4 MHz crystal oscillator, a 24 hr. alarm system that can be set at 5 minute intervals and drum type numerals are some of its many features. With battery power and an LED to show when the clock is running.

**74.32 ea.**



**TR-7625 KENWOOD 25W 2m transceiver**

A synthesized transceiver with full 4 MHz coverage 144.00-147.995, 800 channels. 5 KHz offset switch, memory channel with simplex or repeater operation  $\pm$  600 KHz transmitter offset, mode switch for selecting the transmit frequency up or down, MHz selector switch, digital freq. display, unlock indicator for transceiver. Connections for the optional RM-76 remote control unit.

**425.00** List. Call for quote.

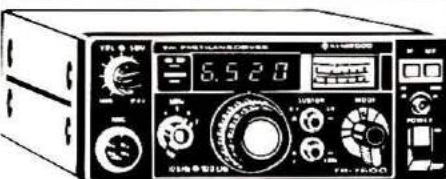

**KENWOOD TR-7600 2m FM transceiver**

A high performance transceiver with memory, designed for full 4 MHz coverage 144-148, 800 channels. Featuring 10W RF output/1W Lo. memory channel with simplex or repeater offset, 13.8 VDC at 3A continuous. Also LED frequency display & tone pad terminal. Connections for the optional RM-76 remote control unit.

**375.00** List. Call for quote.



**KENWOOD TS-700SP all mode 2m transceiver**

Covers the entire 2m band, SSB, CW, FM and AM. Features semi-break-in CW, side tone monitor, digital frequency readout, receiver preamp and 600 KHz repeater offset operation within all 2m repeater subbands including the new 144.5-145.5 MHz. With 10 watts RF output and AC/DC power supply.

**799.00** List. Call for quote.



**KENWOOD RM-76 microprocessor control unit**

Designed for the TR-7625/TR-7600, it has 6 memory channels, MARS channel, scans for either busy or open channels. TX frequency can be shifted  $\pm$  600 KHz, scans memory channels. Memory data remains stored even when power switch is off if the power cord is connected.

**125.00** List. Call for quote.

**YAESU FT-202R 2m handheld FM transceiver**

Featuring: 1 watt output minimum, 6 channel capability - 3 prs. of crystals included, flexible helical whip antenna, toneburst, S meter and battery condition indicator, built-in speaker and condenser mic. Compact and light weight. Operates on 8 AA NiCad or 7 AA dry cell batteries.

**199.00** List. Call for quote.

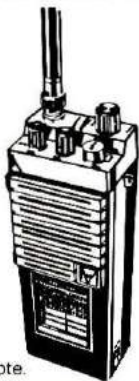

**Dentron**

**DENTRON Clipperton L linear amplifier**

Hi/Lo power switching, covers 160 thru 15 meters, 2000W PEP SSB, 1000W DC on CW, RTV, SSTV, continuous duty power supply 2500V idle SSB 1800V idle CW, covers most MARS frequencies, easily changed 117V or 234V AC 50/60 Hz. Final tubes: 4-572B.



**699.50** List. Call for quote.

**YAESU FT-101Z**

**high performance HF transceiver**

Covers: 160-10 meters plus WWV, modes LSB, USB, and CW, built-in power supply. Input power: 180 watts PEP, analog frequency readout, 6146 final tubes, RF speech processor, variable IF bandwidth (300 Hz - 2.4 KHz), noise blanker, VOX, attenuator 10 dB or 20 dB, 100-234V operation & TX/RX frequency offset.

**749.00** List. Call for quote.



**KENWOOD TS-120S solid state Hf SSB transceiver**

No tune up! Miniaturized circuits, solid state construction, built-in digital display, IF shift, final transistor protection, VOX, noise blanker, 25 KHz marker. Frequency range is 80-10 meters and WWV. Modes: SSB and CW, 200W SSB & 160W DC CW. Power requirements: RX-0.7 13.8 VDC, TX-18A 13.8 VDC, 9 1/2" x 3 1/4" x 11-9/16"

**699.95** List. Call for quote.



**TEN-TEC Century 21 CW transceiver**

Great for the novice or the dedicated CW operator. It features: full break-in, 70W input, all solid state, built-in speaker, receives CW or SSB but transmits CW only. It has overload protection, offset receiver tuning, linear crystal mixed VFO, adjustable level sidetone, built-in regulated power supply. Crystals are provided to cover the 80-10 meter novice banus

**349.00** List. Call for quote.





# Reading Ideas FROM **h r b**

**SAVE TIME  
ELIMINATE  
HASSLE  
SHOP BY  
MAIL**

**ORDER TODAY  
Ham Radio's  
Bookstore  
Greenville, NH 03048**

**LATEST RELEASES!**

PLEASE INCLUDE \$1.75 for CALLBOOK SHIPPING

## 1980 RADIO AMATEUR CALLBOOK

Don't be one of those who waits until the year is half over to buy a new callbook. Invest in a callbook today and get a full year's use out of your purchase. Crammed full of the latest addresses and QSL information. You'll find • Bold-face calls, names and addresses for every licensed Amateur in the U.S. — It's a list that's more accurate than the FCC's • Slow Scan TV directory • The latest ARRL countries list • International Postal info • QSL Managers from around the world • Standard time charts • A complete census of international Amateur population • PLUS MUCH, MUCH MORE! A super value at an amazingly low price. The 1980 callbook is a perfect Christmas gift for friends or for yourself. Order today to make sure you have the new callbook before the holiday season.

CB-US **Softbound \$16.95**

## 1980 ARRL HANDBOOK

Full of exciting new features for the 80's, now is the time to order your copy of the 1980 ARRL "RADIO AMATEUR'S HANDBOOK." Internationally recognized and universally consulted, every amateur should have the latest edition. The new HANDBOOK covers virtually all of the state-of-the-art developments in electronics theory and design. Novices will find it to be an indispensable study guide, while the more advanced Amateur will enjoy building the many new projects.

Order AR-H880 **Softbound \$10.00**  
 Order AR-BB80 **Hardbound \$15.75**

## THE 1980 FOREIGN CALLBOOK

DXing is a real joy, but it's even better when you get back QSL cards from the countries you've worked. The most important tool in getting those cards is to have a copy of the 1980 Foreign Callbook on your operating table. Stations are listed by country, call, name and address in bold, easy-to-read type. You also get: Great Circle Beam headings from major U.S. cities, International Postal information, DXCC Countries List, Worldwide QSL bureaus, Standard time charts and more. Get the DX information you want, when you want it. Order today so you have a copy on hand for the winter DX season.

CB-F **Softbound \$15.95**

## SHORTWAVE PROPAGATION HANDBOOK

Edited by George Jacobs, W3ASK, and Theodore J. Cohen, N4XX

For many hams, both new and old, radio wave propagation is still a mystery. Realizing this, the authors went about the task of preparing a simplified text that could be understood by hams, swi's and engineers alike. Stress has been given to simplified explanations and charts. The authors also detail a simplified method of do-it-yourself propagation forecasting. To assist your forecasting efforts, the book contains a complete listing of the 12 month smoothed sunspot numbers since 1749. Join those who know how to predict when the bands will open to specific areas of the world. ©1979.

CQ-PH **\$7.50**

Please allow 2-3 weeks for delivery.

## SIMPLE LOW-COST WIRE ANTENNAS

Learn how to build simple, economical wire antennas. Even if you don't know a feedline from a feed-through, W6SAI will get you on the air with an effective low-cost wire antenna. And, apartment dwellers take note! Fool your landlord and your neighbors with some of the "invisible" antennas found here. For the old-timer as well as the beginner, it's a clearly written, well diagramed, and even humorous antenna book. 192 pages. ©1972.

RP-WA **Softbound \$5.95**

## BEAM ANTENNA HANDBOOK

by William I. Orr, W6SAI

Here's recommended reading for anyone thinking about putting up a yagi beam this year. It answers a lot of commonly asked questions like: What is the best element spacing? Can different yagi antennas be stacked without losing performance? Do monoband beams outperform tribanders? Lots of construction projects, diagrams, and photos make reading a pleasurable and informative experience. 198 pages. ©1977.

RP-BA **Softbound \$4.95**

## THE RADIO AMATEUR ANTENNA

HANDBOOK by William I. Orr, W6SAI and Stuart Cowan, W2LX

If you're pondering what new antennas to put up, we recommend you read this very popular book. It contains lots of well illustrated construction projects for vertical, long wire, and HF/VHF beam antennas. But, you'll also get information not usually found in antenna books. There is an honest judgment of antenna gain figures, information on the best and worst antenna locations and heights, a long look at the quad vs. the yagi antenna, information on balloons and how to use them, and some new information on the increasingly popular Sloper and Delta Loop antennas. The text is based on proven data plus practical, on-the-air experience. We don't expect you'll agree with everything Orr and Cowan have to say, but we are convinced that **The Radio Amateur Antenna Handbook** will make a valuable and often consulted addition to any Ham's library. 190 pages. ©1978.

RP-AH **Softbound \$6.95**

## ANTENNA BOOKS

### 73 VERTICAL, BEAM, AND TRIANGLE ANTENNAS

A collection of 73 different vertical, beam, and triangle antenna designs. It contains construction details for single and multi-element verticals, multi-element horizontal arrays, yagis, quads, and triangles. Here's an antenna cookbook sure to spark your imagination. 160 pages. ©1977.

24021 **Softbound \$5.50**

### BEVERAGE ANTENNA HANDBOOK

by Victor Misak, W1WCR

The Beverage or Travelling Wave antenna is becoming popular as a separate receiving antenna which greatly reduces interference from foreign broadcast and other stations on the lower Amateur bands. Because it consists of a single longwire and a terminating unit, the Beverage is easy and economical to construct. The author gives you theory and describes a number of different Travelling Wave and Steerable Wave antennas, all designed to greatly reduce GRM on the 40, 80, and 160 meter bands. 39 pages. ©1977.

VM-BAH **Softbound \$5.00**

### THE ARRL ANTENNA BOOK

For years this has been the standard manual on Amateur antennas. The popular vertical, wire, beam, VHF/UHF, and Oscar antennas are given full theoretical and practical treatment as well as mobile and restricted space antennas. Wave propagation and antenna measurement are also discussed. Makes a great companion to the ARRL's new "Antenna Anthology." 336 pages. ©1974.

AR-AM **Softbound \$5.00**

### THE ARRL ANTENNA ANTHOLOGY

by the ARRL staff

This brand new book pulls together a wide selection of antenna articles from QST. Written for Amateurs of all levels and interests. Included are phased arrays, verticals, Yagi's . . . even the VHF Quagi! Detailed instructions and full illustrations make this a really useful book for any Amateur. 152 pages. ©1979.

AR-AA **Softbound \$4.00**

## PRACTICAL ANTENNAS

**PRACTICAL ANTENNAS** is not quite like any of the other ham antenna books. Written by a knowledgeable DX'er, this new book is chock-full of helpful hints and suggestions on the how-to's of putting up a super antenna system. Chapters include information on design and construction of practical Yagis, quads and wire type antennas. Inside you'll also find a complete bibliography of antenna articles from the popular amateur publications. Charts and tables are designed to eliminate all those tricky calculations. And, SCLEBI has included a list of computer generated beam headings from major population centers to all the countries of the world. A new format, large easy-to-read text and durable vinyl cover make **PRACTICAL ANTENNAS** a "must" for every amateur library. ©1979.

SC-PA **\$9.95**

## ALL ABOUT CUBICAL QUAD ANTENNAS

The cubical quad antenna is considered by many to be the best DX antenna because of its simple, lightweight design and high performance. In Bill Orr's latest edition of this well known book, you'll find quad designs for everything from the single element to the multi-element monster quad, plus a new, higher gain expanded quad (X-Q) design. There's a wealth of supplementary data on construction, feeding, tuning, and mounting quad antennas. It's the most comprehensive single edition on the cubical quad available. 112 pages. ©1977.

RP-CQ **Softbound \$4.75**

Prices subject to change without notice.

Please add \$1 for shipping

**CAN'T WAIT?  
CALL TOLL FREE**

**1-800-258-5353**



# QUESTIONS AND ANSWERS

## A New Service From HRH

Here's the start of something we think you'll like, and will find very useful from time to time. This column will answer the questions you send in, and, where possible, give you the name of some books or articles that you can read to dig deeper into the theory behind our answer.

First, let's take note of the rules of the game. Questions will be answered in this column *only*. We cannot reply with individual letters, and telephone requests will not be accepted. To get your question into the circuit, simply write a letter or postcard, addressed to Questions and Answers, c/o Ham Radio Horizons, Greenville, New Hampshire 03048. Your question will be acknowledged, and it will be evaluated for possible use in this column.

We'll select the question(s) we feel are most useful to the largest number of our readers, and will provide an answer on these pages.

There are a couple of things you can do to make this scheme run smoothly — write clearly, or type. A question that is hard to read might get pushed aside when we are in a hurry. Also, be brief, to the point, and be sure the question relates to Amateur Radio.

Benefits? There are several. For one, you will obtain the answer to some part of Amateur Radio that has been puzzling you, and many of your fellow hams will gain from your experience. (Don't be bashful — we're not going to call you "dummy" just because you don't know it all. After all, there was a time when we didn't know it all either).

Then, too, there are the prizes; several of them. We're still working out the details, but there will be a prize for the most popular Question and Answer in each issue, *plus* a grand prize

for the most popular one of the year. You readers can help with this by sending us a card with your nomination for *only one* best article, and please name the author of the question. If we don't get any votes from the readers, we'll have to pick and choose ourselves — and we would much rather have your opinion.

## Let's get started

Some of our staffers turned in a list of questions, just to fill the hopper, but, before they could all be answered and set in type, some pretty good ones came in with the daily mail. A couple of those will start things off nicely.

### Receiver

*I am new at ham radio, and I am about to buy my first receiver. I'm not interested in transceivers. Which one (in the middle-price range)? — J.V. Guy.*

First, let's clarify price range. Not long ago, middle-price range meant something in the \$100 to \$150 area. Today, with the top-of-the line receivers going for \$700 to \$1200 or better, the mid-range figure is up considerably. Your comment that rules out transceivers, to my mind, excludes some of the best bargains available to today's hams — the Heath HW-8 and HW-101, and the Century 21 by Ten-Tec, all of which are in the range between \$130 to \$400.

However, let's stick to receivers. There are very few "Amateur Radio" quality communications receivers available as new units. The "all-frequency" receivers, covering from 500 kHz to 30 MHz, are not satisfactory from several standpoints, chief among them being stability, lack of good vernier (bandspread) tuning, and selectivity (especially for CW).

One acceptable new Amateur-band unit that comes to mind is the Heath HR-1680. At just a shade over \$200, it's within the reach of most beginners, and you can obtain matching speaker and (later, when you are ready for it) a transmitter. True, you do have to assemble it, but I've found that Heath's instructions make the job relatively easy, educational, and practically fool-proof if you follow them closely and don't try to out-engineer the designer.

There's also the Atlas RX-110, priced just over \$200, and the RX-110S — an improved version for slightly more money. It features an add-on transmitter module when you need it. Unfortunately, Atlas is no longer in the business, but there should be some RX-110s on dealer's shelves around the country, and there are provisions for having Atlas equipment serviced (Specialty Communications, 2523 Peach St., Erie, Pennsylvania 16503), so don't scratch Atlas off your list.

Otherwise, I suggest that you go the used-equipment route. Look in the classified advertising section of the ham magazines, ask at club meetings, check with dealers, or eyeball the local flea-markets at hamfests. Write down what you expect of a receiver, and keep the list with you. When you find a receiver that fulfills the majority of the items on the list, buy that one. However — always have an out! If local, ask that the receiver be demonstrated as working. If you send away for it, get a money-back statement in writing, and be sure you and he understand the time limits involved, and who pays the shipping costs.

What is available? Again, price will vary and will dictate how narrow the field will be. I would look for Drake R4, R4B, or R4C, Heath SB-301 or



# 1980

## Radio Amateur Callbook



Don't be one of those who waits until the year is half over to buy a new callbook. Invest in a callbook today and get a full year's use out of your purchase. Crammed full of the latest addresses and QSL information.

You'll find:

Boldface calls, names and addresses for every licensed Amateur in the U.S.

□CB-US Softbound \$16.95



## The Foreign Callbook

DXing is a real joy, but it's even better when you get back QSL cards from the countries you've worked. The most important tool in getting those cards is to have a copy of the 1980 Foreign Callbook on your operating table. Stations are listed by country, call, name and address in bold, easy-to-read type. □CB-F Softbound \$15.95 Please include \$1.75 additional shipping for each Callbook ordered.

## HAM RADIO'S BOOKSTORE

GREENVILLE, N. H. 03048

(800) 258-5353

1980  
1980  
HANDBOOK  
See page 79 for super value  
on 1980 ARRL Handbook.  
1980

SB-303, Collins 75S-1 (the 75S-3 is still commanding premium prices, but an "S-1" can be found for less than \$350), or even a Kenwood R-599. Most of these can be found as part of a "package" deal, where the seller wants to include the transmitter and other accessories, but some are sold as "separates" from time to time. All of these I've mentioned have been around for some years, but most will be found to still work well — aside from an occasional scratchy volume control or "noisy" band-switch contacts.

**Recommended reading:** "Get On The Air On A Budget," by W1DTY, *Ham Radio Horizons*, March, 1977 (photocopy \$2); "1979 Equipment Roundup," by W1HR, W1SL, and W1XU, *Ham Radio Horizons*, December, 1978 (photocopy or back issue, \$2).

### Tape recording off-the-air

I have a Panasonic Model RQ-490AS portable cassette recorder, with a built-in microphone. I have connected a shielded cable from my receiver speaker terminals and plugged the other end into the microphone jack of the recorder. When I record either CW or SSB, I get poor, distorted playback from the tape, which is unreadable. Is there a special cable I can use for this purpose, or can I make one that will work? — J. Kernaghan, KA2AEY.

I have a feeling that the audio from the speaker is entirely too loud for your recorder. Before going any further, check the quality of a recording made with the normal microphone to see if you've damaged any of the transistors in the microphone amplifier circuit. If it still records, and sounds good, breathe a sigh of relief.

The audio output of most receivers will be in the range of 1 to 10 watts. A microphone delivers a few microwatts (millionths of a watt). What you need is a means of cutting down the volume from the speaker. In the audio industry, you would use an attenuator, but I don't know of one that is specifically made to go between a speaker and a microphone-input jack. The speaker impedance is 4 or 8

ohms, and the microphone input can be anywhere from a few hundred up to several thousand ohms, therefore the usual attenuator will not work well because of this wide difference in impedances. You might visit some of the Hi-Fi shops to see if they have anything that will do the job. I've seen some "mixers" that *might* work but they are costly. Some shops have what they call a "mono speaker control," designed to control the volume of individual speakers that are not built into the Hi-Fi set. One of these might work, and would at least match the speaker impedance — although for best results you should place a resistor in series with the lead to the microphone, see Fig. 1. You can also experiment with fixed-value attenuators if you have a handful of resistors. A diagram is shown in Fig. 2. Try different values for R1 and R3 until you get good results in recording. If your recorder has an "AUX" or "LINE" input, try using that instead of the microphone input. These inputs are usually designed to handle more audio than the microphone circuit, and could do the job.

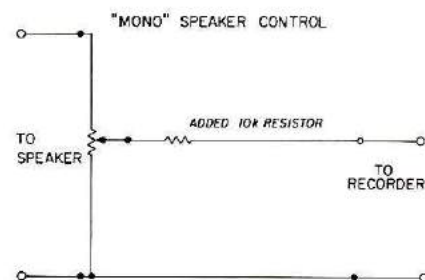

Fig. 1. A "Mono" speaker control can sometimes be used between a loudspeaker and the input to a tape recorder.

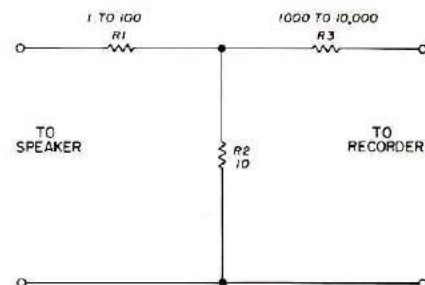

Fig. 2. A fixed-value attenuator can be built to reduce the audio level for a tape recorder. Try different values of R1 and R3 until you can get clear recordings.



Another possibility is to try one of the little inductive pick-up gadgets that are sold for the purpose of recording voices from your telephone handset. If you can place it near a circuit carrying audio, such as wires to the speaker, or an output transformer in the receiver, it should work.

One note of caution — some receivers have one of the speaker wires connected to chassis ground. Some recorders do too. If you have both devices plugged into the ac-outlet socket (wall outlet), you *could* get a very loud hum (at least), or sparks and blown fuses and transistors (worst case). Be sure the two devices are compatible by measuring between the two chassis or ground points with an ac voltmeter before you wire anything up. If you find more than a fraction of a volt, then either don't plug the recorder into ac, or use only the inductive "telephone" pickup device.

\* \* \* \* \*

#### SWR

*I've been hearing a lot about SWR. What is it? Will I need to do anything special when I buy a new, more powerful transmitter than I now have?*  
— D. A. Sargent, KA1BEB.

The abbreviation stands for *Standing Wave Ratio*, which is shortened from *Voltage Standing Wave Ratio*. This is a term used by engineers and technicians to specify the reflected rf voltage on a transmission line. It's a hard concept to visualize, and difficult to describe in nontechnical language.

Let's try it this way, using an example you have probably experienced. Suppose you are in a large room or long hallway that has hard, smooth walls. If you shout, or snap your fingers, or make some sharp sound at one end of the hall, you will hear an echo. The reason there is an echo is that the sound is reflected from the hard surface at the end of the hall. How do you get rid of the echo? Put some absorbing material on the wall — burlap, drapes, acoustic tile, etc. This material "soaks up" the sound, and the echo disappears.

In the world of antennas and transmission lines, the antenna does the "absorbing." The transmission line is the hallway. If the antenna is "matched" to the transmission line, it

## The Larsen Kūlrod® Antenna

# Good Looker...

# Great Performer

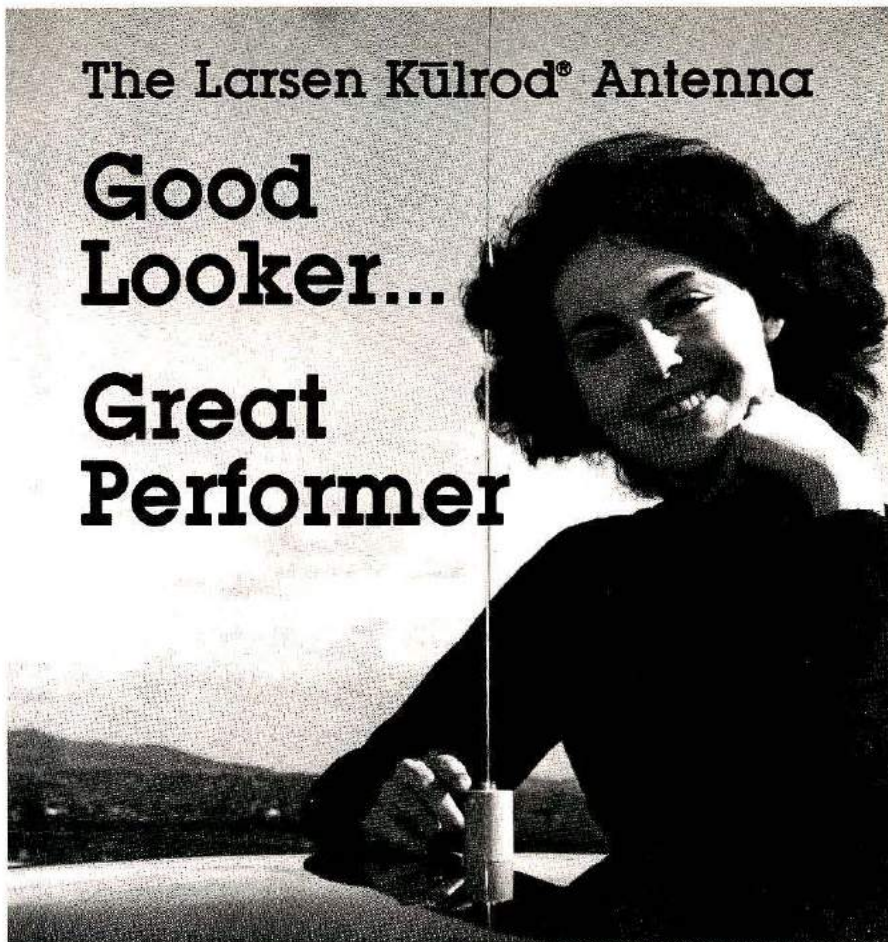

They say "beauty is as beauty does". And the streamlined, low silhouette Larsen Kūlrod Antenna performs as beautifully as it looks!

**You get real performance**, thanks to solid contacts with no power wasted in inefficient base or phasing coils. And there's no power loss through inefficient high loss whips when you use a Larsen Kūlrod Antenna.

These antennas were engineered to serve the tough, highly competitive two-way communications field. They are in demand and sold throughout the United States and around the world — though often priced a bit above other antennas. The reason? Top performance and looks.

Larsen Kūlrod Antennas are available at leading Amateur stores. Choose from a variety of easy-to-install permanent and temporary mounts in the 50, 144, 220 and 440 MHz amateur frequencies.

Write for a free catalog and name of the nearest Larsen dealer. And before long you'll be getting "fine signal" reports on your new Larsen Kūlrod.



## Larsen Antennas

*You can HEAR the difference!*

11611 N.E. 50th Ave. / P.O. Box 1686  
Vancouver, WA 98663 / Phone: 206/573-2722

*In Canada write to:* Unit 101 - 283 E. 11th Avenue  
Vancouver, B.C. V5T 2C4 / Phone: 604/872-8517

\* Kūlrod is a Registered Trademark of Larsen Electronics, Inc.



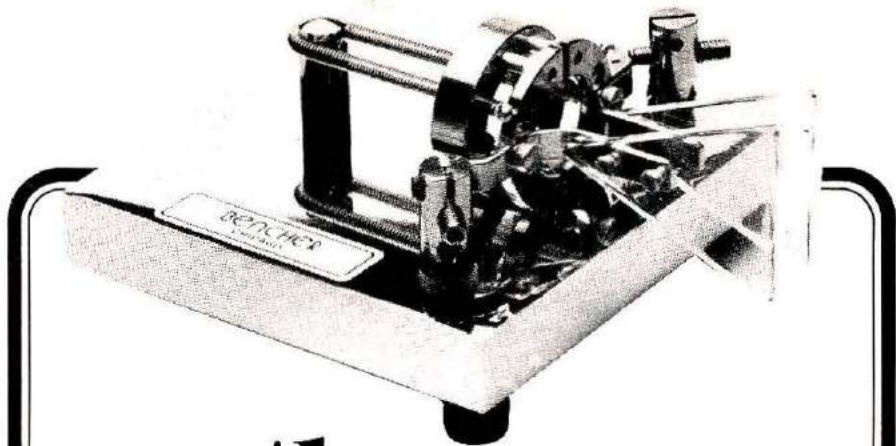

# the Ultimate IAMBIC PADDLE

- Full range of adjustment in tension and contact spacing.
- Self-adjusting nylon and steel needle bearings.
- Solid silver contact points.
- Polished lucite paddles.
- Precision-machined, chrome plated brass frames.
- Standard model has black, textured finish base; deluxe model is chrome plated.
- Heavy steel base; non-skid feet.

WRITE FOR LITERATURE

**BENCHNER, INC.**

333 W. Lake Street, Dept. A  
Chicago, Illinois 60606 • (312) 263-1808

Available at selected dealers or send \$42.95 (\$52.95 for chrome model) plus \$2.00 shipping and handling. Overseas amateurs invited to request quotation for air parcel post shipment.

"soaks up" all the rf, and none is reflected back toward the transmitter. If it is not matched, some rf is reflected, and you get an echo, or SWR. Why is it called SWR? Because the peaks and valleys of the reflected energy wave add to, and subtract from, the wave travelling toward the antenna, and cause larger peaks and valleys, which can be measured with an rf voltmeter. These voltages can then be compared to the voltage on a matched line (where there are no peaks and valleys), and expressed as a ratio. This ratio tells you how well the antenna is matched to the transmission line.

When you change transmitters, you should not have to do anything about SWR if the SWR is relatively low. Most modern transmitters will accept an SWR of 2:1 or less. Some will work well up to an SWR of 3:1 or 3.5:1. Actually, they all *should* work with ratios higher than that, but modern rigs have protective circuits built into them to reduce the output power when the SWR is high. It's a way of protecting the expensive output transistors. Rigs with vacuum tubes are not so fussy about SWR, but they require a couple of controls which you can adjust from the front panel.

Obviously, the best thing to do is to make sure your antenna is matched to the transmission line, then your transmitter will be happy. However, some antennas are very difficult to match to common coaxial cable. In this case, you must use a matching circuit — such as a "Transmatch," "Matchbox," or "Antenna Matcher," between the transmitter and the transmission line. These devices all lose some of the power as it goes through, but will fool your transmitter into working well with a mismatched antenna and transmission line.

**Recommended reading:** *The ARRL Antenna Book*, 13th edition, ARRL, Newington, Connecticut, 1974, Chapter 3, (\$5 plus \$1 shipping from Ham Radio's Bookstore, Greenville, New Hampshire 03048); "Transmission Lines — Your Pipeline to the Outside World," by W1HR, *Ham Radio Horizons*, May, 1977 (photocopy \$2); "Another Look At Reflections," by W2DU, *QST*, April, June, October, 1973 and April, 1974 (write ARRL, 225 Main St., Newington, Connecticut 06111). **HRH**



## Radio World



**CENTRAL NEW YORK'S FASTEST GROWING HAM DEALER**







Featuring Yaesu, Icom, Drake, Ten-Tec, Swan, DenTron, Midland, KDK, MFJ, Microwave Module, Tempo, Astron, KLM, Hy-Gain, Mosley, Larsen, Cushcraft, Hustler, Mini Products, Bird, DSI, Mirage, Vibroplex, Benchner, Info-Tech, Universal Towers, Callbook, ARRL, Astatic, Shure. *We service everything we sell!* Write or call for quote. **You Won't be Disappointed.**  
We are just a few minutes off the NYS Thruway (I-90) Exit 32

**Warren**  
**K2IXN**  
Call Toll Free: 1-800-448-7914

**ONEIDA COUNTY AIRPORT TERMINAL BUILDING**  
**ORISKANY, NEW YORK 13424**

**Bob**  
**WA2MSH**  
New York State Residents Call: 315-337-2622 or 315-337-0203

*... at last ...*

## your shack organized!

A beautiful piece of furniture — your XYL will love it!

### \$16450 S-F RADIO DESK

Deluxe - Ready to Assemble

Designed with angled rear shelf for your viewing comfort and ease of operation.  
FINISHES: Walnut or Teak Stain.  
Floor Space: 39" Wide by 30" Deep

Additional Information on Request.  
Checks, Money Orders, BankAmericard and Master Charge Accepted.

F.O.B. Culver City. (In Calif. Add 6% Sales Tax.)  
— DEALER INQUIRIES INVITED —

S-F Amateur Radio Services

4384 KEYSTONE AVENUE • CULVER CITY, CALIF. 90230 — PHONE (213) 837-4870



Radio equipment  
not included

Also Available . . .  
Floor Space: 51" Wide by 30" Deep  
\$192.50





Operate **Legally** Without  
An FCC License in  
the 160-190 kHz Band



**LOW & MEDIUM FREQUENCY RADIO  
SCRAPBOOK (3rd Edition)**  
by Ken Cornell, W2IMB

Here's your chance to get on the air and have some legal license-free excitement in the 160-190 kHz range. Explore the enticing world of the low frequencies and uncover some new fun! Complete details on assembling homebrew to work these frequencies plus full info on FCC rules and regulations. A book you just can't afford to miss. 110 pages. ©1977.

HR-LF                      Softbound \$6.95



**ADDENDUM '77/'78  
for the Low & Medium Frequency  
Radio Scrapbook**

by Ken Cornell, W2IMB

Even more goodies from the 160-190 kHz region, **Addendum '77/'78** is designed to complement **The Low & Medium Frequency Radio Scrapbook**. The technical data is excellent and will provide you "low-fers" even more information, applications, and techniques for these enticing frequencies. Latest revised FCC rules governing the non-licensed communication bands. 68 pages. ©1977.

HR-LFA                      Softbound \$3.95

**Be a LOWFER**

Join the fun and get on  
160-190 kHz this winter

Send your order today or call

**TOLL FREE  
1 (800) 258-5353**

Clip & Mail Today!

HR-LF                      \$6.95  
 HR-LFA                      \$3.95  
Plus shipping                      \$1.00

Total enclosed \_\_\_\_\_

Charge                       MC                       VISA

Expiration \_\_\_\_\_

Card Number \_\_\_\_\_

Name \_\_\_\_\_

Address \_\_\_\_\_

City \_\_\_\_\_

State \_\_\_\_\_ Zip \_\_\_\_\_

**Ham Radio's Bookstore**  
GREENVILLE, NEW HAMPSHIRE 03048

# All Bands Preamplifier



- Improved reception. For receivers and transceivers.
- Continuously tuneable 1.8 - 54 MHz. Covers all amateur bands 160 to 6 meters; all shortwave broadcast bands.
- Low noise figure. Up to 20 db gain. Reduces image and spurious response.

Here is an exciting new device to improve your reception on all bands 1.8 to 54 MHz. It gives up to 20 db extra gain and the low noise figure of a dual gate FET to pep up your noisy receiver or transceiver. And it adds a high Q tuned circuit to give improved overload capability and image reduction. Makes that tired old rig come to life again. Even helps new models dig into weak signal territory.

Works with all transceivers up to 350 watts input power. A unique and improved circuit automatically bypasses the preamplifier when the transceiver transmits. The bypass delay is continuously variable by front panel control.

The low profile cabinet takes minimum operating table space. A heavy die cast case gives better shielding and isolation. size: 6" x 7" x 2" high. A built-in 117 volt AC supply and a connecting coaxial cable for the transceiver are included.

Order yours now! Price \$89.50 plus \$3 shipping/handling U.S. & Canada. Calif. residents add sales tax.



# Palomar Engineers

Box 455, Escondido, CA. 92025 • Phone: [714] 747-3343



# “Satellite-Linked” Computer Network

## A Phase-III Hook-up for Your Keyboard

BY VERN RIPORELLA, WA2LQQ

The world of Amateur Radio communications will take a giant leap into the space age with AMSAT's first new breed of Amateur Radio satellites. Unlike the prior satellites of the AMSAT-OSCAR series (OSCARs 1 through 8), which were confined to orbits that limited the length of time a ground station could “see” the satellite to 20 minutes or so at best, the new Phase III satellites will often be visible for 8 hours at a time, or more. And, at certain times in the orbit, almost every Amateur in the Northern Hemisphere will be within the coverage area.

The first of these birds, OSCAR 9, is scheduled for launch in spring, 1980. Detailed planning of operations has already begun, and a bandplan for the use of the space-borne repeater has been developed. The bandplan specifies some features which further distinguish the AO-9 satellite from all its predecessors: The provision of Special Service Channels (SSCs) in the AO-9 passband supplements the General Communications Band for special types of Amateur Radio communications.

There are six SSCs specified in the AO-9 bandplan. They are:

1. General Voice Bulletin (multi-lingual)
2. Education Services
3. Scientific Services
4. (Inter)National Traffic System
5. CW/RTTY bulletin and Code Practice
6. AMICON (AMSAT International Computer Network)

Here's some speculation on the QSOs that may occur on the AMICON SSC. Let's visit the home of an Amateur friend, Rip, WA2LQQ, on an early week-day morning.

\* \* \* \* \*

The drone of Thursday morning commuter traffic combines with the aroma of freshly brewed coffee to jog Rip's consciousness one step further from slumber.

“Good grief!” he exclaims, bolting from the bed, fumbling with the belt of his robe, leaning on the doorjamb to adjust his slippers, and sneaking a peek at his wristwatch — all in one less-than-fluent motion. “It's 6:30!”

The now familiar dash down the hallway is only momentarily diverted by an apparently disembodied arm extending from within the kitchen . . . and, most significantly for the lead-lidded-lumberer . . . it bears a steaming mug of eye-opener.

A knowing “Mornin Hon” is almost lost in the muffled “tomp, tomp” of slipped feet negotiating the staircase

at what seems near-catastrophic speed.

Had this been the first such occasion, the XYL, now tending to breakfast preparations, probably would have been more concerned than she is this morning. But no, this happens now and then. You see, OSCAR 9 was on last night, and the station was set up for automatic operation on the Data SSC! Now, Rip races to his charge to learn if it has faithfully maintained the vigil.

Reaching the console, his eyes, now facing reality somewhat more boldly, quickly scan the printout from last night's data transactions on AO-9's Data SSC.

“Ah,” he grunts almost subaudibly, “Jim's got that kluge up and running again.”

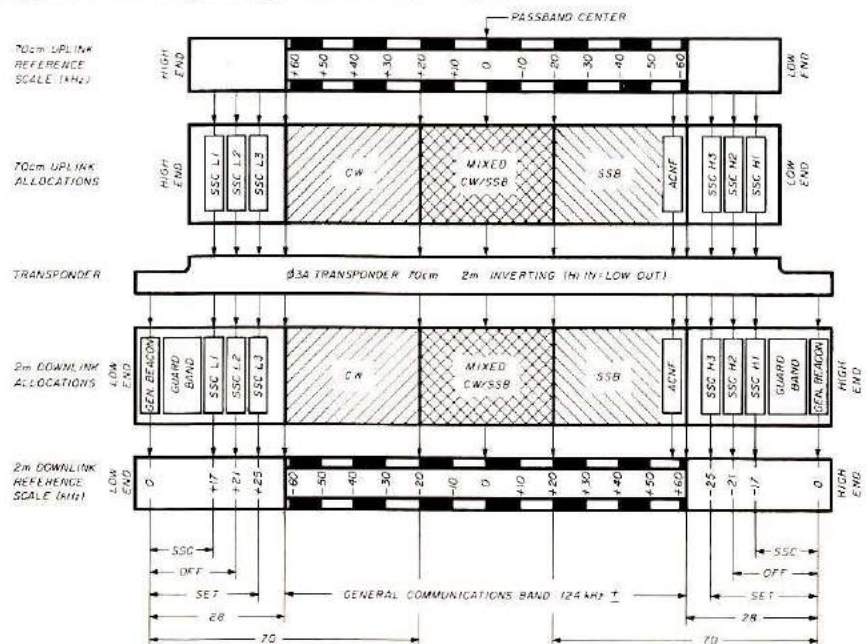

Fig. 1. Amsat Phase III-A satellite bandplan. Abbreviations are: ACNF = AMSAT Coordination and Network Frequency; SSC = Special Service Channel; Beacons; GB (General) = 145.810 MHz; EB (Engineering) = 145.990 MHz. Six types of SSC are planned for the spots designated, one of which is the AMSAT International Computer Network (AMICON).



His eyes now follow the page to learn still more. Seems like G3IOR checked into AMICON (AMSAT International Computer Network at 0725 UTC, and sent a narrative message to Jim, K5TNP, the page tells him. Jim was on, he concludes.

"That must mean he got his homebrew floppy<sup>1</sup> running! I'll have to drop a packet or two on Jim," he silently affirms.

Next down the page he sees that KØRZ has sent the latest revision of the network-subscription protocol to VE2PY for optimization and coding in ROM.<sup>2</sup> He recalls that Bill had been working with Bob and Ian, VE2BEN, for some weeks now and, "I guess that means it's ready," he concludes.

Then, on the printout, appear some familiar callsigns. WØPN, Ron, has sent ZS1BI, Greg, some digitized video data that Greg will run on his processor and through a D/A<sup>3</sup> converter to his video display unit. Looking at the gobbledygook on his printout, he recognizes that it is video data,<sup>4</sup> but wonders what secrets lie within it mask. Is it a simple picture of Ron's shack? Perhaps a centerfold from *Popular Mechanics*? He resolves once again to complete the demodulator board that appeared in *QST* some months ago, and which now ruefully sits on a bench corner anxiously awaiting the opportunity to seduce some attention from him.

Further down the page he sees another digitized video packet cluster<sup>5</sup> and recognizes that the originator of this group, WBØGAI, is another former hf SSTV "maven," now firmly hooked on OSCAR 9 Data SSC video-packet data.

"Boy," he thinks, "these guys are really serious about this thing!"

Then he spies a packet group from W3IWI.

"Wonder if these are the photos of the Saturn encounter?" he exclaims aloud.

Scanning the page further, he sees that G3ZCZ/W3 has joined the assembled multitude. He knows that this means that Joe's station will now assume store-and-forward responsibilities for any station having data for another station which is not on the air at that moment. Thus, Joe's processor serves AMICON as a temporary repository for undeliverable messages. He recalls Tom, W3IWI, hav-

ing facetiously referred to Joe's processor as a cosmic black hole: "The ultimate data sink; lots of stuff goes in but nothing ever comes out!"

His eye now catches a few packets destined for VK-land, a couple for ZL from HA5BME, and one for JA1ANG from F6BEG. The notes on the printout show that G3ZCZ/W3 is now accountable for this data, as Harry, JA1ANG, was not in view of the satellite at the time that the data was introduced by F6BEG.

"Ah, here it is!" he exclaims as his eyes refocus on the part of the printout page that bears his quarry.

"Ready for a warm-up?" comes the voice from upstairs.

"No thanks, but I'd like some more coffee" he responds with a tone she recognizes as indicating a double-entendre has been foisted upon her . . . unusual wit for this time of morning . . . she concludes.

"So, what has you in such good spirits so early this morning?"

"Well," he replies, watching the monitor over the rim of his cup, "I got a few packets from Ted, HB9OP, last night. The voice data<sup>6</sup> you see here on the printout is stored on the floppy and I'm going to run it through the synthesizer to see what he has to say in response to the voice data-gram I sent him yesterday."

"Is this the fellow who's coming over to visit with us next month on his way to New York City?"

"Right."

A few switches are thrown, a few fumble-fingered caresses on the keyboard and the CRT replies, "READY." One more caress and a strange new voice fills the shack.

"Good morning, Rip. This is Ted. Thanks for your voice data-gram which I just decoded a few minutes ago. I will make my plane reservations today and meet you at JFK on the date you specified."

After 30 or 40 seconds the voice evaporates with, "73, Rip, and talk to you again soon."

"Pretty good quality," she remarks.

"Yep, you can even detect his German accent through the synthesizer."

Sitting at the console now, Rip plucks a few keys on the keyboard and, in a second or two, a view of earth flashes on the screen.

"Does the satellite have a camera

## CODE got you stumped?

RELAX and worry not! Learn international Morse Code the EASY, Rus Farnsworth way. No books, no gimmicks, just listen & learn. Using the word method, based on modern psychological techniques, you can zoom past 13 w.p.m. in **less than half the time!** Available in cassettes @ \$10.95 and LP records at \$9.95 — you get over **two hours** of instruction!

### EPSILON RECORDS

P.O. Box 626  
San Jacinto, CA 92383

## HI-Q BALUN

- For dipoles, yagis, inverted vees & doublets
- Replaces center insulator
- Puts power in antenna
- Broadbanded 3-40 MHz
- Small, lightweight and weatherproof
- 1:1 impedance ratio
- For full legal power and more
- Helps eliminate TVI
- With SO 239 connector



\$10.95

## HI-Q ANTENNA CENTER INSULATOR



- Small, rugged, lightweight, weatherproof
- Replaces center insulator
- Handles full legal power and more

\$5.95 With SO 239 connector

## HI-Q ANTENNA END INSULATORS



- Rugged, lightweight, weatherproof
- 1:1 impedance ratio
- 300 ohm impedance
- Handles full legal power and more
- Available in standard and right-angle versions

- May be used for:
  - Guy wire strain insulators
  - End or center insulators for antennas

\$4.95 • Construction of antenna loading coils or multiband traps

## DIPOLES

| MODEL  | BANDS               | LENGTH | PRICE WITH HI-Q BALUN | WITH HI-Q CENTER INSULATOR |
|--|---------------------|--------|-----------------------|----------------------------|
| <b>Dipoles</b>   |                     |        |                       |                            |
| D-1  | 160, 80             | 130    | \$29.95               | \$34.95                    |
| D-2  | 80, 40              | 66     | 29.95                 | 34.95                      |
| D-3  | 40, 20              | 33     | 29.95                 | 34.95                      |
| D-4  | 20, 10              | 16.5   | 29.95                 | 34.95                      |
| D-5  | 10, 5               | 8.25   | 29.95                 | 34.95                      |
| <b>Shortened dipoles</b>                                       |                     |        |                       |                            |
| SD-1   | 160, 80             | 90     | 29.95                 | 34.95                      |
| SD-2   | 80, 40              | 45     | 29.95                 | 34.95                      |
| <b>Parallel dipoles</b>  |                     |        |                       |                            |
| PD-1000  | 160, 80, 40, 20, 10 | 130    | 49.95                 | 59.95                      |
| PD-2000  | 80, 40, 20, 10      | 66     | 49.95                 | 59.95                      |
| PD-4000  | 40, 20, 10          | 33     | 49.95                 | 59.95                      |
| PD-8000  | 20, 10, 5           | 16.5   | 49.95                 | 59.95                      |
| <b>Dipole shorteners — only, same as included in SD models</b> |                     |        |                       |                            |
| SS-1   | 160, 80             | —      | \$19.95               | \$24.95                    |
| SS-2   | 80, 40              | —      | 19.95                 | 24.95                      |

All prices include shipping and handling charges. Add \$3.00 per antenna for shipping and handling charges. Add \$2.00 per antenna for shipping and handling charges. Add \$2.00 per antenna for shipping and handling charges.

Antenna accessories — available in standard and right-angle versions. Add \$3.95 for shipping and handling charges. Add \$2.00 per antenna for shipping and handling charges.

All prices are in U.S. dollars. Add \$3.00 per antenna for shipping and handling charges.

Van Gorden Engineering, Inc. 4000 Van Gorden Drive, San Jacinto, CA 92583

Box 21365, S. Euclid, Ohio 44121 Dealer Inquiries Invited



# the Ultimate 1:1 BALUN

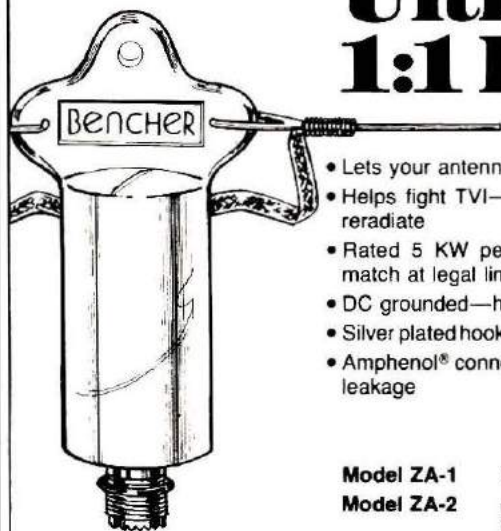

- Lets your antenna radiate—not your coax
- Helps fight TVI—no ferrite core to saturate or reradiate
- Rated 5 KW peak—accepts substantial mismatch at legal limit
- DC grounded—helps protect against lightning
- Silver plated hook-up braid; Custom molded case
- Amphenol® connector; Rubber ring to stop water leakage

|                   |   |                |
|-------------------|---|----------------|
| <b>Model ZA-1</b> | 3.5-30 mHz  | <b>\$15.95</b> |
| <b>Model ZA-2</b> | optimized 14-30 mHz<br>includes hardware for<br>2" boom | <b>\$17.95</b> |

Available at selected  
dealers, add \$2.00  
postage and handling  
in U.S.A.  
**WRITE FOR LITERATURE**

## BENCHER, INC.

333 West Lake Street, Dept A  
Chicago, Illinois 60606 (312) 263-1808



WE'VE CUT  
THIS DOWN TO A  
SHORT TALE....

EVER NEED TO HAVE YOUR HAM GEAR SERVICED?  
WELL THAT'S WHAT WE DO. AS A MATTER OF FACT,  
THAT'S ALL WE DO.

WE'VE GOT THE TECHNICIANS.  
WE'VE GOT THE EQUIPMENT.  
AND WE'VE GOT THE PARTS.

**International Electronic  
Communications, Inc.**



503 Avon St., Mocksville, NC 27028

(704) 634 5661

## UNADILLA

### FULL-POWER, QUALITY HAM ANTENNA PARTS

The  
**WA2ZOT**  
"INTERFILTER"

2000 WATT LO-PASS

LIFETIME GUARANTEE  
The **only** Lo-Pass you'll  
ever need.



**AT YOUR DEALER**

- BALUNS · TRAPS · INSULATORS
- QUAD PARTS · ANTENNA KITS
- BOOM/MAST MOUNTS · WIRE
- CABLE · CONNECTORS

Write or call for full Catalog

ASSISTANCE?

Call: HUGH GUNNISON, WA2ZOT  
Toll-Free 800-448-1666  
(NYS Collect 315-437-3953)

MICROWAVE UNADILLA/REYCO DIVISION  
FILTER COMPANY INC. (Dept. **HRH**)  
6743 KINNE STREET, EAST SYRACUSE, NEW YORK 13057

**DEALERS WANTED - OVER 300 WORLD-WIDE**

on board?" she asks.

"No, these pictures are really products of a data base and program I received from my friend Bill, N5KR, when he sent the whole shebang to me in packets on the Data SSC a few months ago. What you see," he continues, "is a representation of the area the satellite sees at this particular instant. The map is computed from the data base and uses previous knowledge of where the satellite was at some particular point in time. All areas seen now on the screen can communicate with all the others on the screen in real-time<sup>8</sup> if the stations in those areas are on the air. If they're not on, the data may go into temporary storage at the node,<sup>9</sup> such as Joe's. You see, here we are," he points out on the CRT, "and here's Roger's QTH. Since both our locations are on the screen at this time, that means that WA2LQQ can communicate with WB0GAI . . . if he's on now," he adds parenthetically. "But since it's only 4:45 AM, local time, at Roger's QTH, we can get through to his station in real-time only if he's on automatic. I doubt that he's personally manning the station at this time of the morning? Let's give it a try."

After a few more control adjustments are made, the console comes further alive, reflecting, to a degree, the further awakening of its master.

He subconsciously peers askance at the tower visible through the window, and mentally confirms that the tracking antennas have sprung from their stow position and are now drawing a bead on the unseen particle some 15,000 km aloft.

Suddenly the target makes its presence known. The manifestations are so obvious here in the shack it is still difficult for him to fully comprehend that the source is a tiny silver box more than an Earth-diameter away. Still, in they march, one by one like so many soldier-symbols of the silver box's reality; like the point scouts of an approaching army they come. The vanguard arrives with the S-meter initially clearing the zero pin, and then haltingly, then firmly lofting to S-9. Next, a few green curves appear on the scope. What had been calm seas of green are now turbid waters seen through the porthole-scope. With a note of finality, the climactic switch is thrown, and the room is suddenly filled



to overflowing with the audio equivalent of that thrashing green sea.

She recognizes the wave crashes as the voice of a computer.

"Screedle-warble-beedle-dee-doo," it says to the unknowing ears.

"Okay. We're ready," he asserts. "Let's can this one for Roger."

Tapping out a short greeting note, Rip loads the packet in RAM.<sup>10</sup>

"Just watch the screen now," he says while simultaneously striking a key with the drama of a concert maestro commanding the final chord from the orchestra.

"INAC"<sup>11</sup> spews the printer a moment or two later.

"Well, what does that mean?" she commiserates, suspecting an embarrassing glitch.

"Probably that he's not on automatic," he rejoins. "Let's just wait a second to see what happens."

"Aha, there we go," he concludes with a note of paternalistic finality, perhaps more appropriate for a father's pride in his progeny's first discernible babble.

"So, what happened to your packet to Roger?" she challenges.

"Well, do you see this line on the CRT? That means that the packet has been picked up by JA1ANG for storage and forwarding to Roger by Harry's machine. When Roger does come on-line, Harry will dump the canned message to Roger. That's one function of a node in this type of packet-switched, store-and-forward network. Harry's machine is now acting as a nodal processor or refile center."

"Pretty snazzy," she concedes.

"Well . . . guess I should get ready for work," he remarks in descending tones. "Thank goodness for the holidays next week!"

"Yeah," she adds, "and thank goodness it's also the end of the 1980 football season!"

#### Footnotes

1. "Floppy" is short for floppy-disk, which is a computer device used for bulk storage of data on flexible magnetic disks resembling 45 RPM phonograph records.
2. A "ROM," or Read-Only-Memory, is a solid-state computer memory device in which is stored non-erasable data or programs.
3. A "D/A" converter, or Digital to

Analog converter, is a device (usually an IC) that converts digital data such as binary "1s" and "0s" to analog signals such as speech. Most commercial satellite trunks used by telephone companies digitally encode voice for long-haul transmissions in an A/D converter, and then reconvert in a D/A converter for local transmission to or from the local exchange or central office.

4. Video data is the digital equivalent of analog video. Commercial TV broadcast of video is in analog form.
5. A "packet" is a set of digital data sent in bursts or groups between relay points. Handling data in a network of relay points is often expedited by the use of packets.
6. Voice data are the digital equivalent of analog voice signals.
7. A synthesizer is a device which takes digital data and processes it according to a set of rules (program) which results in the production of an audio (analog) output. Thus, a synthesizer can be programmed to "talk" if the data supplied to it is voice-data, or the digital equivalent of speech.
8. Real-time means at the instant a message is generated and sent, with no storage and delay enroute.
9. A node in a computer network is a main message-relay point around which subordinate stations or relay points cluster. The nodes are analogous to main post offices where mail is routed before being sent to local branches for delivery to the addressee.
10. "RAM" is Random Access Memory. These are solid-state devices similar to "ROM," except that data in RAM can be erased by simply writing over obsolete data, much as new recordings can be made on audio tape recorders by simply recording over the old recording. ROMs provide only the second function, i.e., read-only. RAMs are typically used for short-term storage of limited amounts of data.
11. INAC: "Inaccessible," is a computer-generated error-notification format or protocol. **HRH**

## When it comes to **AMATEUR RADIO QSL's . . .**



it's the  
**ONLY BOOK!**  
US or DX Listings

## 1980 callbooks NOW READY!

Here they are! The latest editions. World-famous Radio Amateur Callbooks, the most respected and complete listing of radio amateurs. Lists calls, license classes, address information. Loaded with special features such as call changes, prefixes of the world, standard time charts, world-wide QSL bureaus and more. The new 1980 Radio Amateur Callbooks are available now. The U.S. Edition features over 400,000 listings, over 120,000 changes from last year. The Foreign Edition, over 315,000 listings, over 90,000 call changes. Place your order now.

|   | Each    | Shipping | Total   |
|---|---------|----------|---------|
| <input type="checkbox"/> US Callbook      | \$16.95 | \$1.75   | \$18.70 |
| <input type="checkbox"/> Foreign Callbook | \$15.95 | \$1.75   | \$17.70 |

Order both books at the same time for \$34.65, includes shipping

Order from your favorite electronics dealer or direct from the publisher. All direct orders add \$1.75 for shipping. Illinois residents add 5% Sales Tax



**SPECIAL LIMITED OFFER!**  
**Amateur Radio  
Emblem Patch  
only \$2.50 postpaid**

Pegasus on blue field, red lettering. 3" wide x 3" high. Great on jackets and caps. Sorry, no call letters.

**ORDER TODAY!**

**RADIO AMATEUR**  
**callbook** INC.  
Dept. EB 2  
925 Sherwood Drive  
Lake Bluff, IL 60044



Order Your Collins KWM-380

NOW!

and receive FREE

(+ old pricing, deposit only required)

- 1) Noise Blanker — \$195.00
- 2) or 2 Filters, your choice — \$96.00 ea.
- 3) or Blower Kit — \$195.00



Get on with the Best!



**MADISON**  
Electronics Supply, Inc.

1508 McKinney • Houston, Texas 77002 • (713) 658-0268

# ANTENNAS

**THE RADIO AMATEUR ANTENNA HANDBOOK** by William I. Orr, W6SAI and Stuart Cowan, W2LX

If you are pondering what new antennas to put up, we recommend you read this very popular book. It contains lots of well illustrated construction projects for vertical, long wire, and HF/VHF beam antennas. But, you'll also get information not usually found in antenna books. There is an honest judgment of antenna gain figures, information on the best and worst antenna locations and heights, a long look at the quad vs. the yagi antenna, information on baluns and how to use them, and some new information on the increasingly popular Sloper and Delta Loop antennas. The text is based on proven data plus practical, on-the-air experience. We don't expect you'll agree with everything Orr and Cowan have to say, but we are convinced that **The Radio Amateur Antenna Handbook** will make a valuable and often consulted addition to any Ham's library. 190 pages. ©1978.

□ RP-AH

Softbound \$6.95

## SIMPLE LOW-COST WIRE ANTENNAS

Learn how to build simple, economical wire antennas. Even if you don't know a feedline from a feed-through, W6SAI will get you on the air with an effective low-cost wire antenna. And, apartment dwellers take note! Fool your landlord and your neighbors with some of the "invisible" antennas found here. For the old-timer as well as the beginner, it's a clearly written, well diagrammed, and even humorous antenna book. 192 pages. ©1972.

□ RP-WA

Softbound \$5.95

Two exciting antenna books from Ham Radio's Bookstore. Call or write today.

Please add \$1.00 to cover shipping and handling.

**HAM RADIO'S BOOKSTORE**

GREENVILLE, N. H. 03048

CALL TOLL FREE 1 (800) 258-5353

## Upgrade Your CW Easily

DATONG



Model D70  
MORSE TUTOR

- Produces random five character groups: all letters, all figures, or mixed.
- Calibrated variable speed (6½ to 37 words per minute) and variable delay (up to 3 seconds) between letters for optimum learning efficiency.
- Internal loudspeaker, plus personal ear-piece for private listening. And pocket size.
- Battery operated therefore always ready for use. Current drain is very low for long battery life.
- Eleven IC, CMOS circuit for long internal battery life.
- Built-in tone oscillator for sending practice (key required).

**\$159.95** Including Pre-Paid Shipping & Full Insurance

Dealer Inquiries Invited  
Made in England • 90 Day Warranty  
Visa Mastercharge Accepted

(Exclusive Importers of DATONG FL 1's)

**AR** Technical Products Corp. Dedicated to Excellence

Box 62  
Birmingham, Michigan 48012  
Telephone 313/844-5698

## MAXI TUNER SOLVES ANTENNA PROBLEMS

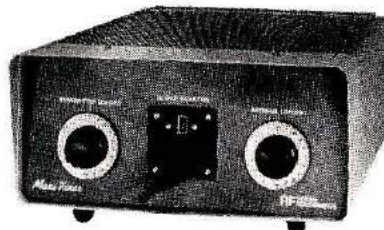

THE FINEST

ANTENNA TUNER AVAILABLE

- Presents 50-75 Ohm Resistive Load to Your Transmitter Using Virtually Any Antenna System
- Improved Ultimate Transmatch Circuit Matches Coax, Random Wire and Balanced Antennas
- Continuous 1.7-30 MHz Coverage
- 229-203 Rotary Inductor (28 µH)
- Rugged Cast Aluminum Turns Counter
- Handles 3 KW PEP
- Heavy Duty Balun
- Velvet-Smooth 6 to 1 Vernier Tuning
- 0-100 Logging Scale on Capacitors
- Available in Kit Form or Assembled
- One Year Factory Warranty
- Use with your present SWR meter or wattmeter.
- Custom Vacuum Capacitor Designs and Individual Components Available

Call or Write for Pricing, Spec Sheet, and FREE Amateur Market Antenna Tuner Comparison Chart That Tells It Like It Is!

**RF POWER COMPONENTS**

P. O. Box 11  
Ladysmith, WI 54848  
(715) 532-3971

## GEM-QUAD FIBRE-GLASS ANTENNA FOR 10, 15, and 20 METERS

Two Elements \$159.00  
Extra Elements \$113.00

Price is F.O.B. Transcona  
**INCLUDES U.S. Customs Duty**

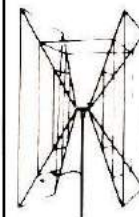

**KIT COMPLETE WITH**

- \*SPIDER
- \*ARMS
- \*WIRE
- \*BALUN KIT
- \*BOOM WHERE NEEDED

WINNER OF MANITOBA  
DESIGN INSTITUTE  
AWARD OF EXCELLENCE

Buy two elements now — a third and fourth may be added later with little effort.

Enjoy up to 8 db forward gain on DX, with a 25 db back to front ratio and excellent side discrimination.

Get maximum structural strength with low weight, using our "Tridetic" arms. Please inquire directly to:

**GEM QUAD PRODUCTS LTD.**

Box 53

Transcona Manitoba

Canada R2C 2Z5

Tel. (204) 866-3338



# VERTICAL ANTENNA

## For 160 Meters

BY TONY DEPRATO, WA4JQS

Having operated on the 160-meter band with good results for a number of years, I became interested in working DX, but found that my half-wave inverted V left a lot to be desired on receive. Since I had no room for a beverage antenna, I decided to try a helically wound vertical.

The antenna started out as a receive-only system, however, and midway through the project I decided to see how well it would work for transmitting. This meant digging through my antenna books and, before long, some facts came to light. The helical antenna has one factor to keep in mind if you want it to act like a quarter-, half-, or full-wave vertical: If you wind a half-wave of wire on a coil form it will act like a quarter-wave vertical, and a full-wave of wire will act like a half-wave vertical, and so on.

### Construction

For the coil form, I used a fiberglass pole 6 meters (20 feet) long and 3.8 cm (1½ inches) diameter. Since I wanted to make the antenna act like a half-wave vertical, I wound a full-wave of No. 12 (2.1 mm) insulated wire on the pole. From the bottom of the coil I ran a 15 meter (50 foot) piece of the same wire with an insulator attached. To the other side of the insulator I connected a 1-foot (0.3 meter) piece of No. 12 (2.1 mm) wire that runs to the ground system. The ground consists of an 8-foot (2.4 meter) rod with sixteen quarter-wave radials running from it.

The next step was to add a top-hat system, Fig. 3, to ensure a reduction in antenna Q and broaden the bandwidth of the system. The top hat also helps to prevent high levels of rf from

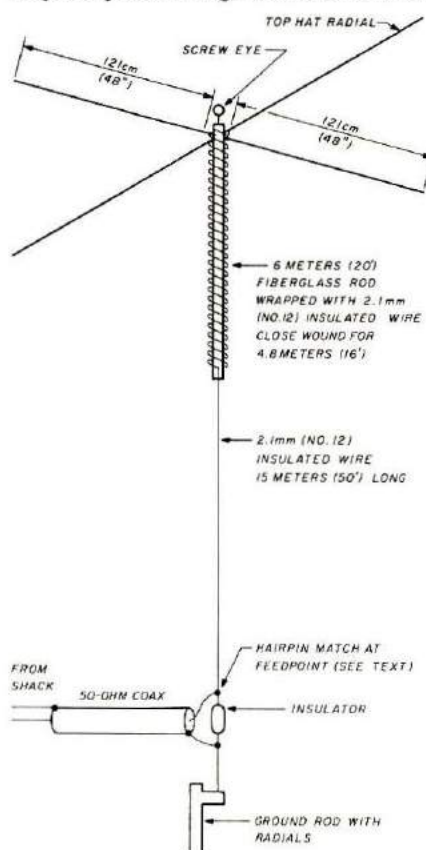

Fig. 1. The 160-meter vertical antenna essentially a length of wire with a helically wound top section. Crossed "top-hat" rods at the top help to lower the Q and prevent corona discharge from heating the wire at that point. A screw eye in the top of the pole allows a rope and pulley to be used to raise and lower the antenna for adjustments.

burning the end of the coil. The bandwidth between the 2:1 SWR points is 20 kHz, letting me operate 1,800 to 1,835 kHz.

I decided to hang the vertical from the top of my 21-meter (70-foot) tower, so a 3-meter (10 foot) 2 x 4 with a small pulley on one end was installed in the tower. I placed an eyebolt in the top of the coil form. Fiberglass filler was then poured inside the coil and allowed to harden to secure the eyebolt to the coil form. The

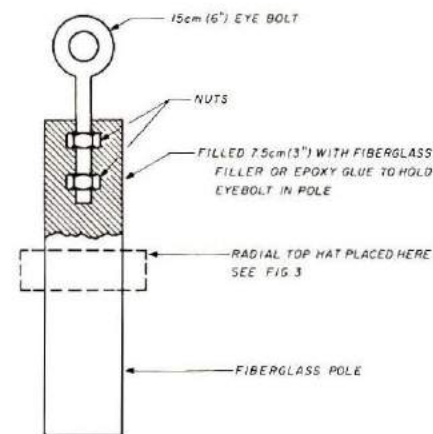

Fig. 2. Mechanical detail of the support screw eye and the method of securing it in the top of the fiberglass pole.

entire system then could be raised and lowered by rope for tuning. After the coil was completed, I covered the entire form with three coats of spar varnish, allowing each coat to dry before adding the next. All bolts and electrical connections were covered with G.E. clear silicone sealant.



**NEW**

# 80 & 84-METER TRANSCEIVERS

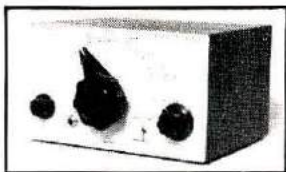

**ONLY \$79.95 EACH**

PPD U.S.A. LESS BATTERIES

- 84-meter transceiver which covers 3500 to 3600 kHz is for the old timer.
- NOVICES should order the 80-meter unit which covers 3685 to 3755 kHz.
- CW operation with VFO control.
- Output power approximately 1/2 watt.
- Expect up to 1000 mile range when used with a half-wave dipole.
- Adjustable RF output impedance.
- Low distortion sidetone oscillator doubles as a code practice oscillator.
- Direct conversion receiver.
- RF amplifier and sharp audio filter.
- Receiver independent tuning.
- Long life operation from 9 self-contained 1.5 volt carbon-zinc D cells.
- Size 9" wide by 5" high by 8" deep.
- Instruction manual included.

Accessories required but not included, are 8-ohm stereo phones, telegraph key, a good antenna such as a half-wave dipole, and a dc volt-meter.

MANUAL AVAILABLE SEP. \$2.00  
SEND S.A.S.E. FOR SPEC SHEET  
R.I. RESIDENTS ADD 6% SALES TAX

**TEDCO**

9 Canonicus Avenue  
Newport, Rhode Island  
02840

# Hobbyists:

Here is an interesting general electronics hobby magazine. It's loaded with lots of interesting ideas, not only about simple circuits and radio, but in all phases of electronics including test gear, audio, remote control and security systems. We are sure that you will find a number of worthwhile projects in this British magazine. For a sample copy, please send \$1 to cover postage and handling costs. Your dollar is applied to the cost of the subscription when ordered.

**1 Year (12 issues) \$20.00**  
**Radio & Electronics Constructor**  
Greenville, NH  
03048

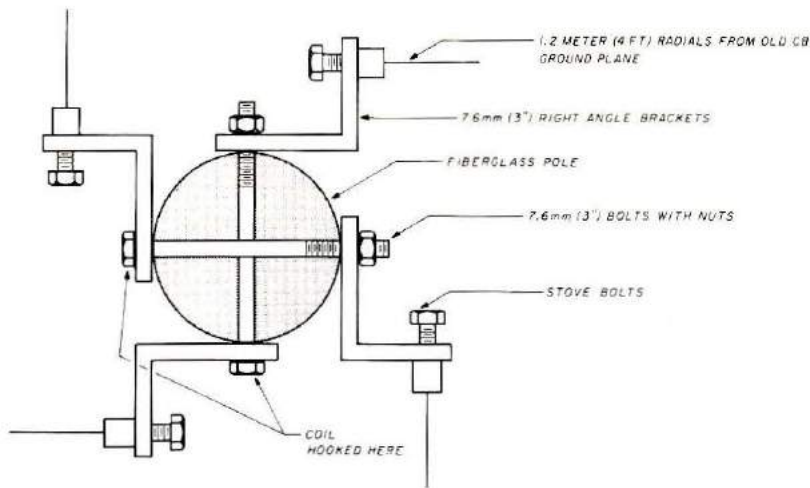

HOOK WIRE FROM COIL TO BOTH SETS OF TOP HAT RADIALS

**Fig. 3.** The radials are fastened to angle brackets which are secured to the pole with through-bolts. Be sure that the radials are all tied together electrically. Salvaged aluminum elements from CB ground-plane antennas were used for radial material.

The top hat was constructed of 7.6 cm (3 inch) angle brackets, and the 1.2-meter (4 foot) tips of old CB ground-plane elements. Two stove bolts were used to fasten the brackets to the coil form near the top, see **Fig. 3.**

### Tuning the system

After the system was in the air, I used an antenna noise-bridge and my Drake R4C receiver to tune the system to 1,815 kHz. This was done by adding or removing turns from the coil. An L or PI network could be used if desired. I thought I would use a different method, since the feed-point impedance of this type of system runs between 3 and 10 ohms. I decided to use a hairpin or beta matching network. Having a feed-point impedance of 10-ohms, and using 50-ohm coax, the *ARRL Antenna Handbook* was used to determine the exact hairpin size. Using the charts on page 122 of that book, and No. 12 (2.1 mm) wire for the hairpin, I obtained the following factors:

Antenna Z = 10 ohms, Coax = 52 ohms, then  $XL = 25$ . To change the reactance to impedance I found that by using the wire spaced 15 cm (6 inches) apart gives me an impedance of 600 ohms:

$$50 \frac{XL}{Z} = \frac{25}{600} \text{ or } 00.42$$

Looking up 00.42 on chart 3-72, page 122, I found that the hairpin length is 2.5 electrical degrees, or

2.5. Wavelength in inches is equal to  $\frac{360}{F}$ . With the antenna to be used

on 1.815 MHz, the required hairpin length is:

$$\frac{2.5}{360} \times \frac{11,500}{1,815} \text{ or}$$

$$109.2 \text{ cm (3 feet 7 inches)}$$

This should give me a match to 52-ohm coax, and better rf transfer.

During tests I found that noise, running an S-5 on the half-wave receiving inverted V, would drop to S-1 on the vertical, thus letting me copy signals that were completely lost on the inverted V. This has proven to be the case 90 per cent of the time over the last six months, showing that, for receiving purposes, this system is well worth the time and trouble.

During transmitting tests with selected stations around the U.S., I found that the inverted V outperforms the vertical out to a distance of around 1600 to 2400 km (1000 to 1500 miles). But, once that point is passed, the vertical takes over and outperforms the inverted V as the distance increases, with the vertical providing signals 2 S-units above the inverted V on the West Coast.

I would be interested to hear from others who have used coils longer than 6 meters (20 feet). I feel that this system will be very worthwhile for those who do not live on a 4-hectare (10-acre) farm.

**HRH**





**July 26 thru August 8, 1980**

*Our 21st year of successful teaching*

**Boost your Ham Skills  
on the Blue Ridge**

**"A Vacation with a Purpose"**

Two weeks saturation learning program  
in Amateur Radio:

- Novice to General
- General or Technician to Advanced
- Advanced to Amateur Extra

Expert Instruction starting at your level.  
Code and Theory in depth along with  
Friendly Amateurs, Who Care About  
You.

C. L. PETERS, K4DNJ, Director  
Oak Hill Academy Amateur Radio Session  
Mouth of Wilson, Virginia 24363

Name \_\_\_\_\_ Call \_\_\_\_\_

Address \_\_\_\_\_

City/State/Zip \_\_\_\_\_



**REMOTE CONTROLLED**

**ANTENNA SWITCHING ALLOWS YOUR FEEDLINE  
TO WORK FIVE TIMES HARDER**

Antenna Mart's Model 50 allows instant switch  
selection of up to five antennas with a single feedline  
and a control cable between the operating position  
and the remote switch location. Eliminate the tangle  
of feedlines and manual switches usually associated

with multiple antennas. Antenna Mart's Model 50 has  
a 3KW power rating, high-speed low-loss operation,  
rugged weather-proof construction and LED indication  
of antenna in use. Order factory-direct or write for  
complete information on our line of available models.

**MODEL 50**

**Remote Antenna Switch  
\$150.00 + \$3.00 shipping**

**ANTENNA MART**

P.O. BOX 1010  
ISU Station  
AMES, IOWA 50010  
(515) 292-7114



**Operate Legally Without An FCC  
License in the 160-190 kHz Band**

**LOW & MEDIUM FREQUENCY RADIO SCRAP-  
BOOK (3rd Edition) by Ken Cornell, W2IMB**

Here's your chance to get on the air and have some legal license-free  
excitement in the 160-190 kHz range. Explore the enticing world of the  
low frequencies and uncover some new fun! Complete details on assem-  
bling homebrew to work these frequencies plus full info on FCC rules and  
regulations. A book you just can't afford to miss. 110 pages. ©1977.

HR-LF **Softbound \$6.95**

**ADDENDUM '77/'78 for the Low & Medium Fre-  
quency Radio Scrapbook by Ken Cornell, W2IMB**

Even more goodies from the 160-190 kHz region, Addendum '77/'78 is  
designed to complement The Low & Medium Frequency Radio Scrapbook.  
The technical data is excellent and will provide you 'lowfers' even more  
information, applications, and techniques for these enticing frequencies.  
Latest revised FCC rules governing the non-licensed communication  
bands. 68 pages. ©1977.

HR-LFA **Softbound \$3.95**

**Be a LOWFER**

Join the fun and get on 160-190 kHz this winter

HR-LF **\$6.95** Send your order today or call

HR-LFA **\$3.95** **TOLL FREE**

**Plus shipping \$1.00 1 (800) 258-5353**

**Total enclosed** \_\_\_\_\_ **Clip & Mail Today!**

Charge  MC  VISA

Expiration \_\_\_\_\_ Card Number \_\_\_\_\_

Name \_\_\_\_\_

Address \_\_\_\_\_

City \_\_\_\_\_ State \_\_\_\_\_ Zip \_\_\_\_\_

**HAM RADIO'S BOOKSTORE**  
GREENVILLE, NEW HAMPSHIRE 03048

**BELDEN**

| Part Number    | MHz | db/100 ft. | db/100 m |
|----------------|-----|------------|----------|
| 9888<br>46¢/ft | 50  | 1.2        | 3.9      |
|                | 100 | 1.8        | 5.9      |
|                | 200 | 2.6        | 8.5      |
|                | 300 | 3.3        | 10.8     |
|                | 400 | 3.8        | 12.5     |
| 8214<br>26¢/ft | 50  | 1.2        | 3.9      |
|                | 100 | 1.8        | 5.9      |
|                | 200 | 2.6        | 8.5      |
|                | 300 | 3.3        | 10.8     |
|                | 400 | 3.8        | 12.5     |
| 8237<br>23¢/ft | 100 | 2.0        | 6.6      |
|                | 200 | 3.0        | 9.8      |
|                | 400 | 4.7        | 15.4     |
|                | 900 | 7.8        | 25.6     |
| 8267<br>30¢/ft | 100 | 2.0        | 6.6      |
|                | 200 | 3.0        | 9.8      |
|                | 400 | 4.7        | 15.4     |
|                | 900 | 7.8        | 25.6     |

**8448**  
**20¢/ft** No. of Cond. — 8  
AWG (in mm) — 6.22, (17x30), [1.76],  
2-18, (16x30), [1.19]

**9405**  
**32¢/ft** No. of Cond. — 8  
AWG (in mm) — 2-16, (26x30), [1.52],  
6-18, (16x30), [1.17]

**MADISON  
ELECTRONICS SUPPLY, INC.**

1508 MCKINNEY • HOUSTON, TEXAS 77002

713/658-0268

MASTERCHARGE • VISA



# WILSON SYSTEMS TOWERS

— IN STOCK —

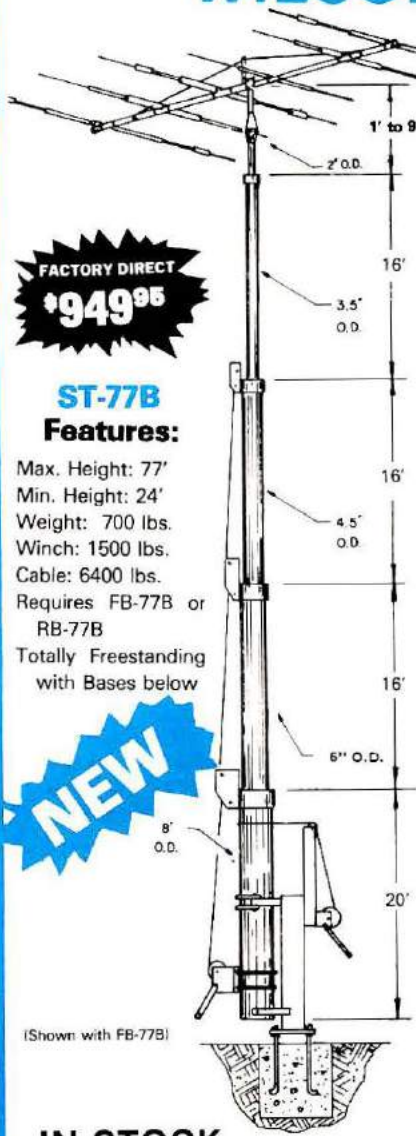

**FACTORY DIRECT**  
**\$949<sup>95</sup>**

**ST-77B**  
**Features:**  
Max. Height: 77'  
Min. Height: 24'  
Weight: 700 lbs.  
Winch: 1500 lbs.  
Cable: 6400 lbs.  
Requires FB-77B or RB-77B  
Totally Freestanding with Bases below

**FACTORY DIRECT**  
**\$549<sup>95</sup>**

**MT-61B**  
**Features:**

Max. Height: 61'  
Min. Height: 23'  
Weight: 450 lbs.  
Winch: 1200 lbs.  
Cable: 4200 lbs.  
No Guys required when mounting against house.  
For completely freestanding installation, use RB-61B or FB-61B below.

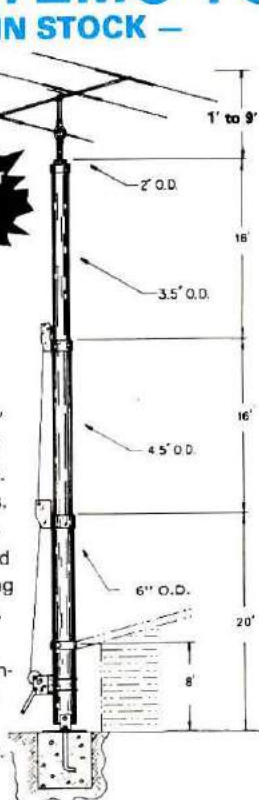

**FACTORY DIRECT**  
**\$314<sup>95</sup>**

**TT-45B**  
**Features:**

Max Height: 45'  
Min. Height: 22'  
Weight: 250 lbs.  
Winch: 1200 lbs.  
Cable: 4200 lbs.  
No Guys required when mounting against eave of house.  
For completely freestanding installation, use RG-45B or FB-45B below.

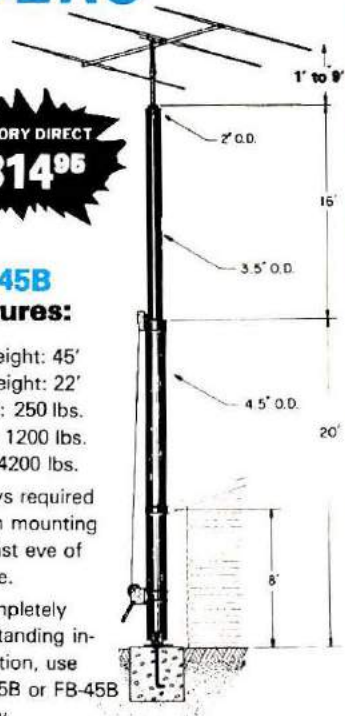

| WIND LOADING |        |         |                                     |
|--------------|--------|---------|-------------------------------------|
| Tower        | Height | Sq. Ft. | Square Footage Based on 50 MPH Wind |
| ST-77B       | 69     | 18      |                                     |
|              | 77     | 12      |                                     |
| MT-61B       | 53     | 18      |                                     |
|              | 61     | 12      |                                     |
| TT-45B       | 37     | 18      |                                     |
|              | 45     | 12      |                                     |

| BASE CHART |                 |        |
|------------|-----------------|--------|
| TOWER      | WIDTH           | DEPTH  |
| TT-45B     | 12" x 12"       | 30"    |
| FB-45B     | 30" x 30"       | 4 1/2' |
| RB-45B     | 30" x 30"       | 4 1/2' |
| MT-61B     | 18" x 18"       | 4'     |
| FB-61B     | 3' x 3'         | 5 1/2' |
| ST-77B     | See Below       | Bases  |
| FB-77B     | 3 1/2' x 3 1/2' | 6'     |
| RB-77B     | 3 1/2' x 3 1/2' | 6'     |

(Shown with FB-77B)

**IN STOCK**

Wilson Systems uses a new high strength carbon steel tube manufactured especially for Wilson Systems. It is 25% stronger than conventional pipe or tubing. The tubing size used is: 2" & 3 1/2"-.095; 4 1/2" & 6"-.125, 8"-.134. All tubing is hot dip galvanized. Top section is 2" O.D. for proper rotor and antenna mounting.

The TT-45B and MT-61B come complete with house bracket and hinged base plate for against-house mounting. For totally freestanding installation, use either of the tilt-over bases shown below.

The ST-77B can not be mounted against the house and must be used with the tilt-over base FB-77B or RB-77B shown below.

All three towers above are able to handle large arrays of up to 20 sq. ft. at 80 mph WHEN GUYED with one set of 4-point Guys at the top of the 3 1/2" section. Guying Kits are available at the following prices: GK-45B - \$59.95; GK-61B - \$79.95; GK-77B - \$99.95. When using the Guy System with RB Series Rotating Base, an additional thrust bearing at the top is required. The WTB-1 is available for \$49.95.

## TILT-OVER BASES FOR TOWERS

### FIXED BASE

The FB Series was designed to provide an economical method of moving the tower away from the house. It will support the tower in a completely free-standing vertical position, while also having the capabilities of tilting the tower over to provide an easy access to the antenna. The rotor mounts at the top of the tower in the conventional manner, and will not rotate the complete tower.

- FB-45B... 112 lbs... \$154.95**
- FB-61B... 169 lbs... \$214.95**
- FB-77B... 250 lbs... \$299.95**

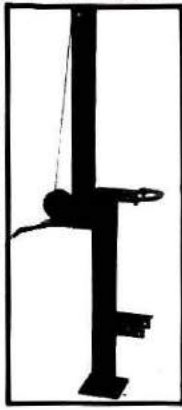

### ROTATING BASE

The RB Series was designed for the Amateur who wants the added convenience of being able to work on the rotor from the ground position. This series of bases will give that ease plus rotate the complete tower and antenna system by the use of a heavy duty thrust bearing at the base of the tower mounting position, while still being able to tilt the tower over when desiring to make changes on the antenna system.

- RB-45B... 144 lbs... \$219.95**
- RB-61B... 229 lbs... \$299.95**
- RB-77B... 300 lbs... \$449.95**



Tilting the tower over is a one-man task with the Wilson bases. (Shown above is the RB-61B. Rotor is not included.)

**ORDER**  
**FACTORY DIRECT**  
**1-800-634-6898**

**W S I WILSON SYSTEMS, INC.**  
4286 S. Polaris Ave., Las Vegas, Nevada 89103



# WILSON SYSTEMS INC. MULTI-BAND ANTENNAS

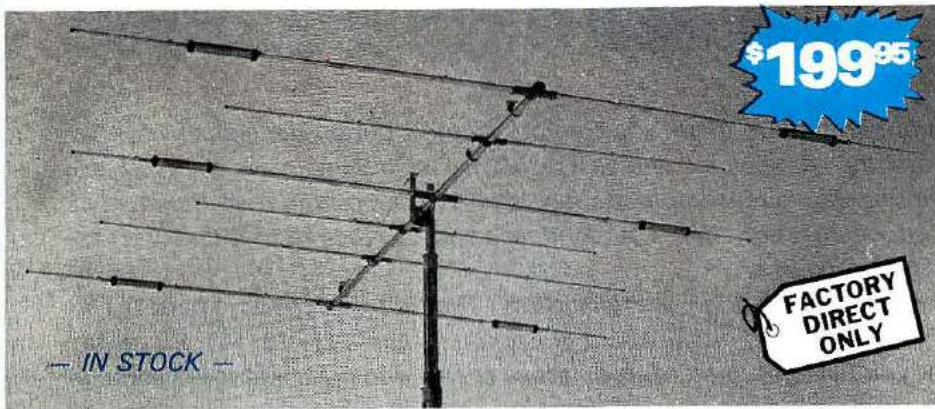

A trap loaded antenna that performs like a monobander! That's the characteristic of this six element three band beam. Through the use of wide spacing and interlacing of elements, the following is possible: three active elements on 20, three active elements on 15 and four active elements on 10 meters. No need to run separate coax feed lines for each band, as the bandswitching is automatically made via the High-Q Wilson traps. Designed to handle the maximum legal power, the traps are capped at each end to provide a weather-proof seal against rain and dust. The special High-Q traps are the strongest available in the industry today.

#### SPECIFICATIONS

|                               |                 |                                 |                 |                                     |               |
|-------------------------------|-----------------|---------------------------------|-----------------|-------------------------------------|---------------|
| Band MHz . . . . .            | 14-21-28        | Boom (O.D. x Length) . . . . .  | 2" x 24' 2 1/2" | Wind Loading @ 80 mph . . . . .     | 215 lbs.      |
| Maximum power input . . . . . | Legal Limit     | No. of Elements . . . . .       | 6               | Maximum wind survival . . . . .     | 100 mph       |
| Gain (dbd) . . . . .          | Up to 9 dB      | Longest Element . . . . .       | 28' 2 1/2"      | Feed method . . . . .               | Coaxial Balun |
| VSWR @ resonance . . . . .    | 1.3:1           | Turning Radius . . . . .        | 18' 6"          | Matching Method . . . . .           | Beta          |
| Impedance . . . . .           | 50 ohm          | Maximum mast diameter . . . . . | 2"              | Assembled weight (approx) . . . . . | 53 lbs.       |
| F/B Ratio . . . . .           | 20 dB or better | Surface area . . . . .          | 8.6 sq. ft.     | Shipping weight (approx) . . . . .  | 62 lbs.       |

**NEW!** ADD 40 METERS TO YOUR TRI-BAND WITH THE NEW 33-6 MK **\$49.95**  
 — IN STOCK —

Now you can have the capabilities of 40-meter operation on the System 36 and System 33. Using the same type high quality traps, the 40-meter addition will offer 200HKZ of bandwidth at less than 2:1 SWR. The new 33-6 MK will fit your present SY36 or SY33, and using the same single feed line.

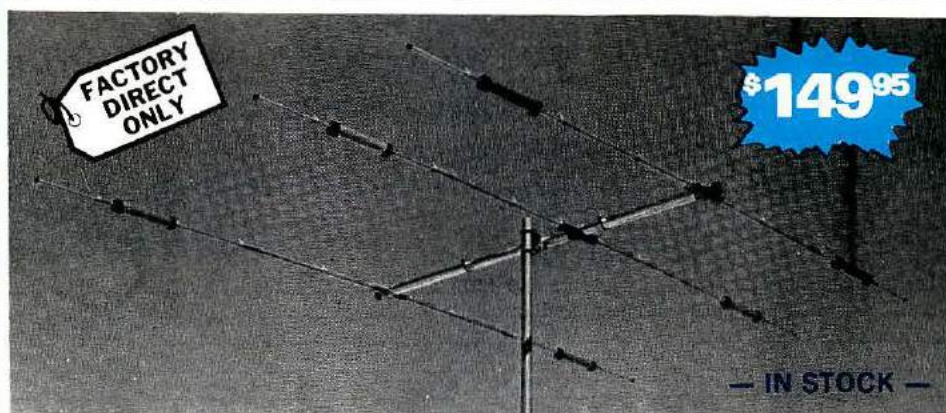

Capable of handling the Legal Limit, the "SYSTEM 33" is the finest compact tri-bander available to the amateur. Designed and produced by one of the world's largest antenna manufacturers, the traditional quality of workmanship and materials excels with the "SYSTEM 33". New boom-to-element mount consists of two 1/8" thick formed aluminum plates that will provide more clamping and holding strength to prevent element misalignment. Superior clamping power is obtained with the use of a rugged 1/4" thick aluminum plate for boom to mast mounting. The use of large diameter High-Q traps in the "SYSTEM 33" makes it a high performing tri-bander and at a very economical price. A complete step-by-step illustrated instruction manual guides you to easy assembly and the lightweight antenna makes installation of the "SYSTEM 33" quick and simple.

#### SPECIFICATIONS

|                               |                 |                                 |             |  |          |
|-------------------------------|-----------------|---------------------------------|-------------|--|----------|
| Band MHz . . . . .            | 14-21-28        | Boom (O.D. x length) . . . . .  | 2" x 14' 4" | Wind loading at 80 mph . . . . .       | 114 lbs. |
| Maximum power input . . . . . | Legal Limit     | No. of elements . . . . .       | 3           | Assembled weight (approx) . . . . .    | 37 lbs.  |
| Gain (dbd) . . . . .          | Up to 8 dB      | Longest element . . . . .       | 27' 4"      | Shipping weight (approx) . . . . .     | 42 lbs.  |
| VSWR at resonance . . . . .   | 1.3:1           | Turning radius . . . . .        | 15' 9"      | Direct 52 ohm feed — no balun required |          |
| Impedance . . . . .           | 50 ohms         | Maximum mast diameter . . . . . | 2" O.D.     | Maximum wind survival . . . . .        | 100 mph  |
| F/B Ratio . . . . .           | 20 dB or better | Surface area . . . . .          | 5.7 sq. ft. |  |          |

**W S I WILSON SYSTEMS, INC.**

4286 S. Polaris Ave., Las Vegas, Nevada 89103

Prices and specifications subject to change without notice.

**ORDER FACTORY DIRECT 1-800-634-6898**

**\$49.95**

## WV-1A

### 4 BAND TRAP VERTICAL (10 - 40 METERS)

No bandswitching necessary with this vertical. An excellent low cost DX antenna with an electrical quarter wavelength on each band and low angle radiation. Advanced design provides low SWR and exceptionally flat response across the full width of each band.

Featured is the Wilson large diameter High-Q traps which will maintain resonant points with varying temperatures and humidity.

Easily assembled, the WV-1A is supplied with a base mount bracket to attach to vent pipe or to a mast driven in the ground.

#### Note:

Radials are required for peak operation. (See GR-1 below)

#### SPECIFICATIONS

- 19' total height
- Self supporting — no guys required
- Weight — 14 lbs.
- Input impedance: 50 Ω
- Powerhandling capability: Legal Limit
- Two High-Q traps with large diameter coils
- Low angle radiation
- Omnidirectional performance
- Taper swaged aluminum tubing
- Automatic bandswitching
- Mast bracket furnished
- SWR: 1.1:1 or less on all bands

**GR-1** **\$12.95**

The GR-1 is the complete ground radial kit for the WV-1A. It consists of: 150' of 7/14 stranded copper wire and heavy duty egg insulators, instructions. The GR-1 will increase the efficiency of the WV-1A by providing the correct counterpoise.



TO: ALL AMATEURS  
FROM: WILSON SYSTEMS, INC.

I would like to take this opportunity to thank you for your support during the last six months. The response was much greater than anticipated and as a result, we fell behind in our shipping. We now have shipping under control and increased production, all of which contribute to the in-stock situation of almost all the products that we offer. Your kindness and patience at that time was appreciated by everyone at Wilson Systems.

With each product that we manufacture, we include a "Product Evaluation Sheet." This enables us to understand what you like and dislike about our products and services. We appreciate the ideas and comments that you have returned to us on these sheets and have instituted some of the changes suggested. So please continue to send them in.

I'm sure you've noticed the way prices have been creeping (and in some cases leaping) upward. We don't like to raise the prices any more than you like to see them go up, but have you seen the price of steel or aluminum lately?

Not all the price increases are directly related to increased materials costs. Sometimes it is the result of an upgrade to a better product. That is the case with the towers. I am very enthusiastic about the new "B" model towers. Did you take a look at the new specifications? Notice the features that have been changed: thickness of tubing, type of tubing used, and the wind loading. The wind load capability has increased dramatically. Oh yes, they've increased in price—but so has the quality! And did you notice the new tower? That's a 77', freestanding, rotatable tower that will safely handle 12 sq. ft. of antenna at 77' (or 18 sq. ft. at 72') in a 50 mph wind. All of this for less than \$1,400, including the rotating base!

I would also like to mention that this month we are announcing a new antenna product. We are offering you an adapter kit for the SY-36 and SY-33 to add 40-meter operation. This kit, the 33-6 MK, will add 200kc of 40-meter operation to your tribander. It will work only with the SY-33 and SY-36.

We look forward to serving you with almost all products now in stock.

Yours truly,  
**JIM WILSON**  
Wilson Systems, Inc.

P.S. Remember, most items are now in stock and ready for shipment.

WILSON SYSTEMS, INC. — 4286 S. Polaris  
Las Vegas, NV 89103 — (702) 739-7401

**FACTORY DIRECT  
ORDER BLANK**

Toll-Free Order Number  
**1-800-634-6898**

**WILSON SYSTEMS ANTENNAS**

| Qty | Model   | Description   | Shipping | Price   |
|-----|---------|---|----------|---------|
|     | SY36    | 6 Ele. Tribander for 10, 15, 20 Mtrs.   | UPS      | 199.95  |
|     | SY33    | 3 Ele. Tribander for 10, 15, 20 Mtrs.   | UPS      | 149.95  |
|     | 33-6 MK | 40 Mtr. Mod Kit for SY33 & SY36   | UPS      | 49.95   |
|     | WV-1A   | Trap Vertical for 10, 15, 20, 40 Mtrs.  | UPS      | 49.95   |
|     | GR-1    | Ground Radials for WV-1A  | UPS      | 12.95   |
|     | M-520A  | 5 Elements on 20 Mtrs.  | TRUCK    | 229.95  |
|     | M-420A  | 4 Elements on 20 Mtrs.  | UPS      | 159.95  |
|     | M-515A  | 5 Elements on 15 Mtrs.  | UPS      | 129.95  |
|     | M-415A  | 4 Elements on 15 Mtrs.  | UPS      | 84.95   |
|     | M-510A  | 5 Elements on 10 Mtrs.  | UPS      | 84.95   |
|     | M-410A  | 4 Elements on 10 Mtrs.  | UPS      | 69.95   |
|     |         | <b>ACCESSORIES</b>  |          |         |
|     | HD-73   | Alliance Heavy Duty Rotor   | UPS      | 109.95  |
|     | RC-8C   | B/C Rotor Cable   | UPS      | .12/ft. |
|     | RG-8U   | RG-8U Foam-Ultra Flexible Coaxial Cable. 38 strand center conductor, 11 gauge | UPS      | 21/ft.  |

**WILSON SYSTEMS TOWERS**

| Qty. | Model  | Description                                  | Shipping | Price  |
|------|--------|--|----------|--------|
|      | TT-45B | Freestanding 45' Tubular Tower               | TRUCK    | 314.95 |
|      | RB-45B | Rotating Base for TT-45B w/tilt over feature | TRUCK    | 219.95 |
|      | FB-45B | Fixed Base for TT-45B w/tilt over feature    | TRUCK    | 154.95 |
|      | MT-61B | Freestanding 61' Tubular Tower               | TRUCK    | 549.95 |
|      | RB-61B | Rotating Base for MT-61B w/tilt over feature | TRUCK    | 299.95 |
|      | FB-61B | Fixed Base for MT-61B w/tilt over feature    | TRUCK    | 214.95 |
|      | ST-77B | Freestanding 77' Tubular Tower               | TRUCK    | 949.95 |
|      | RB-77B | Rotating Base for ST-77B w/tilt over feature | TRUCK    | 449.95 |
|      | FB-77B | Fixed Base for ST-77B w/tilt over feature    | TRUCK    | 299.95 |
|      | GK-45B | Guying Kit for TT-45B                        | UPS      | 59.95  |
|      | GK-61B | Guying Kit for MT-61B                        | UPS      | 79.95  |
|      | GK-77B | Guying Kit for ST-77B                        | UPS      | 99.95  |
|      | WTB-1  | Thrust Bearing for Top of Tower              | UPS      | 49.95  |

**NOTE:**

On Coaxial and Rotor Cable, minimum order is 100' and 50' multiples.  
Prices and specifications subject to change without notice.  
Ninety (90) Day Limited Warranty — All Products FOB Las Vegas, Nevada

Prices Effective March 131, 1980 Nevada Residents add 3 1/2 % Sales Tax  
Ship C.O.D.  Check enclosed  Charge to VISA  MasterCard

Card No. \_\_\_\_\_ Expires \_\_\_\_\_  
Bank No. \_\_\_\_\_ Signature \_\_\_\_\_  
Name \_\_\_\_\_ Phone \_\_\_\_\_  
Street \_\_\_\_\_  
City \_\_\_\_\_ State \_\_\_\_\_ Zip \_\_\_\_\_

Prices and specifications subject to change without notice.



# Airborne Games

## Find Opponents All Over The World

BY JOHN EDWARDS, WB2IBE

Chances are, ever since you've been knee-high to a triode, people have been telling you to stop playing games. Your boss tells you, your teacher, friends, relatives, clients, the plumber — everyone tells you to act your age and stop playing games.

Yet, as we game-players know, not all types of games (of the board-and-little-plastic-pieces variety) are bad. As a matter of fact, many are downright fun! Our only problem is finding suitable opponents and a comfortable niche to play our games in.

Well, believe it or not, there are an almost unlimited number of potential game-players within your own home.

In a way, much of Amateur Radio revolves around game-playing. Hunting DX is certainly a game of wits. Traffic handling can also be looked at as a game (the competition of who can pass the most messages). Contesting, of course, is nothing but one big game. However, I'd like to concentrate on more traditional game forms — the type you and your friends might play across the kitchen table on nights when band conditions are poor.

To some, it might appear impossible to play games over the radio at all. It seems only natural that the contestants must be present in one location to view the game board. Unless you have television capabilities, that's impossible with ham radio.

Recognizing this problem, hams have devised a number of ways to bypass the necessity of having all the players looking at the same game board. The exact means depend to a great part on the game played, but usually involve having the participants keep identical game boards, and follow each other's moves. But, before we go any further, let's first take a look at some of the specific games hams play.

### Chess

Chess is the most popular game played over Amateur Radio, and, because of its mapped-out logic, also one of the easiest to play (at least at a beginner's level).

To solve the communications problem, hams have borrowed from the centuries-old rules of "postal chess." In postal chess, the opponents exchange moves via the mail. To keep track of the game, players on both sides keep a board on which they make all the moves made in the game. As you can imagine, postal chess is a lot slower than radio chess. After all, radio signals travel at the speed of light. The postal service isn't nearly that fast.

Chess moves are exchanged and recorded in a language called chess notation. In chess notation, the names of each of the pieces are abbreviated to letters. For instance, the queen is Q; the knight, N; the bishop,

B; and so on. The pawns are identified by the file they are on: The pawn in front of the king's knight (i.e., on the king's knight file) is the king's knight pawn — KNP. The queen's bishop pawn is QBP; king's rook pawn, KRP.

The squares on which the pieces stand are also identified. As you can see in Fig. 1, the name of the square depends upon the vantage point of the player. If you are playing white, the square three ranks down and four files from the left would be Q3, because it is the third rank on the queen's file. If you are playing black, that same square would be called Q6.

Set up a board and see for yourself. Which name do you use? The side making the move identifies the square as seen from his vantage point. This may sound confusing, but it very soon becomes second nature.

Now that you know the mechanics of chess notation, let's play a very short game so you can see the rules in action.

| White       | Black |
|-------------|-------|
| 1 P-K4      | P-K4  |
| 2 B-QB4     | B-QB4 |
| 3 Q-KR5     | N-QB3 |
| 4 QxBP mate |       |

In the above game, you probably noticed two elements of chess notation I previously neglected to mention, the hyphen and the x. As you may have deduced, the hyphen signifies the move of a piece to a new square; x signifies the capture of an opponent's piece. You'll see a full list of special symbols in Table 1.

Since this is an Amateur Radio magazine and not a chess magazine, I'll not go over the complete rules of chess. They are much too intricate to cover in a few, short paragraphs. If you're a complete newcomer to the game, you'll probably want to consult one of the beginner's chess hand-



A chess set and a transceiver are all you need to be in touch with a whole world full of potential players. Radio chess follows the same general rules established for postal chess (photos by WB2IBE).



# TOWERS

by ALUMA

**HIGHEST QUALITY  
ALUMINUM & STEEL**

60 Ft. Aluminum,  
Crank-Up  
Model T-60-H

40' Steel  
Crank-Up  
Model SHD-40

★ **TELESCOPING**  
(CRANK UP)

★ **GUYED (STACK-UP)**

★ **TILT-OVER MODELS**

Easy to install. Low Prices.  
Crank-ups to 100 ft.

**EXCELLENT FOR  
HAM COMMUNICATIONS**

SPECIAL  
Four Section 50 Ft.  
Van Mounted Crank-Up  
Aluma Tower

Over 36 types aluminum  
and steel towers made—  
specials designed and  
made—write for details



**ALUMA TOWER CO.**  
Box 2806 HH  
VERO BEACH, FLA. 32960  
PHONE (305) 567-3423  
TELEX 80-3405

## Digitrex Electronics

### PA-19 Wideband Preamplifier

- 2 to 200 MHz Bandwidth (3dB Points)
- 15 dB Gain!
- 50 Ohms Input & Output Impedance
- Tiny PC Board Size (7/8" x 1-5/8")
- Absolutely No Tuning Required
- Extremely Stable
- Draws only 20mA @ 12VDC
- Great Way to Increase Sensitivity of Receivers, Counters, etc.
- Fully Assembled and Tested
- Instructions Provided, Full Warranty

**\$8.95**

+ .50 Shipping/Handling

---

### Portable 600 MHz Frequency Counter

- 1600 MHz Range
- 1 KHz or 100 Hz Resolution
- Assembled and Tested
- Full Lifetime Warranty
- Size 5" L x 2 1/2" W x 1 1/2" H
- BNC Whip Antenna Opt. \$8.95

**\$59.95** (ppd. less ant.)

C.O.D. Orders Welcome  
**Digitrex Electronics**  
4412 Fernlee, Royal Oak  
Michigan 48073 313-851-9247

• 75 mV Sensitivity

## MAGAZINE SAMPLES

For a free list of  
over 100 magazines  
offering a sample copy  
send stamped envelope to

**PUBLISHERS  
EXCHANGE**  
PO Box 1368, Dept. 26A  
Plainfield, NJ 07061

**Table 1.** Symbols used in chess notation.

|        |                                  |
|--------|----------------------------------|
| e.p.   | captures en passant (in passing) |
| x.     | captures                         |
| -      | moves to                         |
| 0-0    | castles on King's side           |
| 0-0-0  | castles on Queen's side          |
| ch     | check                            |
| dis ch | discovered check                 |
| dbl ch | double check                     |
| !      | good move                        |
| !!     | very good move                   |
| ?      | bad move                         |
| ??     | very bad move                    |
| mate   | checkmate (game over)            |

books. A good source for information is the United States Chess Federation, 186 Route 9W, New Windsor, New York 12550. Through their publications, you can get all the information on chess you need — and at a fairly attractive price. The membership fee, including a subscription to their monthly magazine, is \$15 per year — \$10 for those over 65.

One important benefit of membership is that you'll receive a rating classification based on your playing ability. Ratings run all the way from less than 1000 points (beginner) up to 2500 points and beyond (senior grandmaster). As of now the USCF will award its rating points only to players who confront each other in person or through the mail. But, who knows? If enough hams get together and petition the USCF, we might someday have a "Radio Rating System."

### Checkers

Although not the prestige game that chess is, checkers does have quite a large following of its own. Actually, if you've ever been whipped by an expert checker player, you realize that the game isn't as simple as many will have you believe. While it's true that the game isn't as complex as chess, it takes a pretty good eye to be

BLACK

|     |     |     |    |    |     |     |     |
|-----|-----|-----|----|----|-----|-----|-----|
| 1B0 | 1N0 | 1B0 | 1D | 1X | 1BX | 1NX | 1BX |
| QB8 | QNB | QB8 | QB | K8 | KB8 | KN8 | KR8 |
| 2B0 | 2N0 | 2B0 | 2D | 2X | 2BX | 2NX | 2BX |
| QB7 | QNT | QB7 | Q7 | K7 | KB7 | KN7 | KR7 |
| 3B0 | 3N0 | 3B0 | 3D | 3X | 3BX | 3NX | 3BX |
| QB6 | QNG | QB6 | Q6 | K6 | KB6 | KN6 | KR6 |
| 4B0 | 4N0 | 4B0 | 4D | 4X | 4BX | 4NX | 4BX |
| QB5 | QNS | QB5 | Q5 | K5 | KB5 | KN5 | KR5 |
| 5B0 | 5N0 | 5B0 | 5D | 5X | 5BX | 5NX | 5BX |
| QB4 | QNA | QB4 | Q4 | K4 | KB4 | KN4 | KR4 |
| 6B0 | 6N0 | 6B0 | 6D | 6X | 6BX | 6NX | 6BX |
| QB3 | QNS | QB3 | Q3 | K3 | KB3 | KN3 | KR3 |
| 7B0 | 7N0 | 7B0 | 7D | 7X | 7BX | 7NX | 7BX |
| QB2 | QNE | QB2 | Q2 | K2 | KB2 | KN2 | KR2 |
| 8B0 | 8N0 | 8B0 | 8D | 8X | 8BX | 8NX | 8BX |
| QB1 | QNI | QB1 | Q1 | K1 | KB1 | KN1 | KR1 |

WHITE

**Fig. 1.** The squares on a chess board are identified from the player's viewpoint. These symbols are used to identify the squares. Abbreviations for chess moves are shown in Table 1.





While not busy working DX, some hams try to blow up the world — on paper. *World War Three* is a popular strategy game that sensibly limits nuclear war to a game board.

able to line up a perfect double, triple, or even quadruple jump.

Since just about everyone knows the rules of checkers, I won't go into an explanation of them here, other than to explain how the game can be adapted for radio.

Surprising as it may seem, it's actually a bit more difficult to play checkers over the air than to play chess. The reason is that, in chess, the pieces take a variety of forms (kings, bishops, rooks, etc.); checkers are all alike.

Because of this, it's easy (especially when the players are communicating by radio) to get the checker pieces confused. But, if each player takes care to keep his notes and board in order, checkers can still be a lot of fun.

Just as in the old general store, a game of ham-radio checkers can

serve as a way of attracting the attention of casual passersby. You never know who might stop by the frequency to find out what's going on — perhaps even rare DX!

Most radio-checkers players use a modified form of chess notation to transmit their moves. That is, they use the same names for the squares that chess players use. A checker move might go something like this: QN3x Q5xQN7, for a typical double jump. If no pieces were taken, a move might be recorded: QN3-QB4. Remember, x means a piece is taken; a hyphen stands for a regular move.

It may take time to learn this system, but take heart. As you slowly decimate your opponent's pieces, it'll get easier and easier to keep track of the game.

### Strategy games

Ever feel that you could have done a better job than Napoleon at Waterloo? Do you think you could have defeated Lord Nelson at Trafalgar? Could you have repulsed the Allies on D-Day? Well, you'll never know, but at least you can have some fun matching wits with the greatest military leaders in history by playing war strategy games.

These games have a small, but intense, following over Amateur Radio. Players range from junior-high-school students all the way to retired military men. No matter what his age or experience, each player approaches his game with verve and excitement.

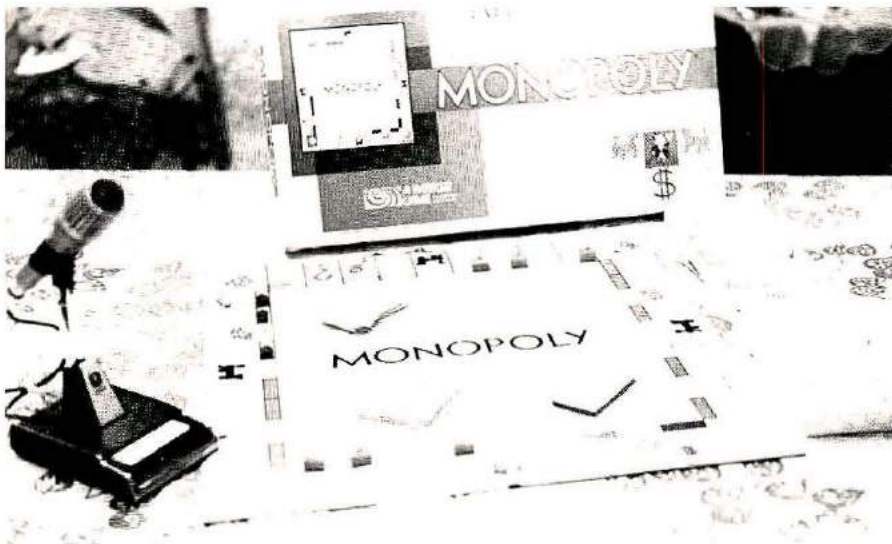

You might even get to play a game of *Monopoly* with a ham in the game's home town — Atlantic City.



**A FLEA GROWS IN HAMERICA!  
YES, A NATIONAL MARKET PLACE  
FOR DEALINGS IN USED GEAR.**

1879 POST RD., P.O. BOX 66, SOUTHPORT, CT 06490

HGM matches Buyers with Owners of used equipment. Perfectly! Register gear you want to sell or buy, nationally, for only \$3.73. At least once a week, HGM compares Buyer specifications to all available equipment registered by Owners. For each perfect match, HGM writes Buyers the particulars about the gear. Buyers contact Owners directly, and all negotiations are strictly between Owners and Buyers.

**HGM GUARANTEE:** Just \$3.73 per registration (a "sell" or a "buy"), and your Registration remains active for 17 unique matchings or 17 months. No HGM commissions! We cannot warrant nor guarantee any equipment found through HGM since everything is between Owners and Buyers. But we do guarantee unique matchings and 17 matchings or months. A fabulous service for the amateur service!

**REGISTER NOW.** Use this form or facsimile and enclose the \$3.73 fee for each Registration. OWNERS: Describe unit by Type, Brand, and Model; indicate exact Sell Price and purchase date. BUYERS: have two choices. Choice #1: Type of Gear, indicate Type and one Price Range. Example: Transceiver, \$700-899. Choice #2: Specific Unit, regardless of price. Indicate specific Brand and Model you want. Example: Transceiver, Ten-Tec, Century 21.

YES, hamgearmart, I need your help! I understand your Guarantee, and I'm enclosing \$3.73 with this Registration. Enter my Registration immediately.

Please register me as a . . .

**OWNER**  **BUYER**

|            |                   |               |
|------------|-------------------|---------------|
| SELL PRICE | TYPE OF GEAR      | PRICE RANGES  |
| GEAR YEAR  | XCVR, SCOPE, ETC. | A 40 - 99     |
| PURCHASED  | BRAND NAME        | B 100 - 199   |
| NEW/USED   | MODEL NUMBER      | C 200 - 299   |
|            |                   | D 300 - 399   |
|            |                   | E 400 - 524   |
|            |                   | F 525 - 699   |
|            |                   | G 700 - 899   |
|            |                   | H 900 - 1099  |
|            |                   | I 1100 - 1399 |
|            |                   | J 1400 AND UP |

NAME \_\_\_\_\_ CALL \_\_\_\_\_ CLASS \_\_\_\_\_

ADDRESS \_\_\_\_\_ TELEPHONE \_\_\_\_\_

CITY \_\_\_\_\_ STATE \_\_\_\_\_ ZIP \_\_\_\_\_

hamgearmart 1879 Post Road, P.O. Box 66  
Southport, Connecticut 06490

NEWCOMER OR OLD PRO . . .

## ALPHA POWER IS YOUR KEY TO A BIG SIGNAL

ALPHA/VOMAX can boost the "talk power" of any rig up to ten times or more. The new SBP-4 *spill band* speech processor uses the only system *more effective than rf clipping* — AND distortion is extremely



low so your voice sounds natural. Under tough conditions VOMAX can help as much as most linears. Combine VOMAX with a good linear and WOW! It's simple to install and operate with any rig.



ALPHA 374A is a heavy-duty "rock crusher" . . . a full kilowatt (2+KW PEP). No Time Limit, all band, NO TUNE UP desk top linear amplifier. It's a no-compromise ALPHA with a TWO YEAR FACTORY WARRANTY.

Other superb ALPHA s include the "Ultimate LINEAR" ALPHA 77Dx and the new ALPHA 78, which combines NO-TUNE-UP maximum legal power, No Time Limit, and high speed (vacuum relay) CW break-in. Call or write your dealer or ETO direct for illustrated literature on all ALPHA products.



EHRHORN TECHNOLOGICAL  
OPERATIONS, INC.  
P.O. BOX 708, CANON CITY, CO 81212  
(303) 275-1613



## EAVESDROPPER SWL ANTENNA!

Your ear to the world of  
Short Wave Listening...

RADIO ANGOLA  
RADIO MOSCOW  
VOA  
RADIO FREE EUROPE  
Deutsche Welle  
Voice of the Indies  
BBC  
Tokyo Calling

49 41 31 25 19 16 and 13 meters All the world's shortwave broadcast bands are yours with Antenna Supermarket's trap-tuned "Eavesdropper" all band antenna. Individually tuned traps make the Eavesdropper perform just as if it were seven separate antennas, each tuned to a different international broadcast band.

Its 100-foot long 72-ohm balanced feedline provides an exact match to the antenna on every band, assuring that the maximum signal possible gets to your receiver's antenna terminals while cancelling out noise picked up by the feedline.

The Eavesdropper comes completely assembled and ready to install with 50 feet of 450 pound test nylon rope. The Eavesdropper itself is 45" 10" long, made of tough #16 copper-clad steel wire to insure it'll survive those severe winter storms that bring down lesser antennas.

**BRING THE WORLD TO YOUR EARS...**

**ORDER YOUR EAVESDROPPER TODAY!**

Only \$54.40, plus \$2.50 UPS (U.S.A.), from your favorite dealer or direct

**ANTENNA SUPERMARKET**  
Box 563,  
Palatine, IL 60067  
(312) 359-7092  
call or send QSL today for our complete catalog



Anytime you have a question about your Ham Radio HORIZONS subscription, please include a mailing label to insure prompt service on your inquiry.

### CHANGE OF ADDRESS

Moving? Please let us know 4-6 weeks beforehand. Or, if anything is wrong with your current mailing label, please carefully print the updated information below and affix your present label above.

PLEASE HELP US TO SERVE YOU BETTER

**HAM RADIO HORIZONS** Greenville, NH 03048

Call \_\_\_\_\_

Name \_\_\_\_\_

Address \_\_\_\_\_

City \_\_\_\_\_

State \_\_\_\_\_ Zip \_\_\_\_\_

AFFIX  
LABEL  
HERE

The largest and most popular manufacturer of strategy games is a company called Simulations Publications, Inc., 44 East 23rd Street, New York, New York 10010. This firm produces a wide line of games recreating military confrontations, ranging from the fall of Rome to imaginary outer-space adventures.

The games are played on large maps of actual battlefields. Troops, airplanes, ships, and the like, are represented on the map by little cardboard chits, which the players place according to their own personal strategy. Since each chit has its own name or number, and since the map is broken down into numbered squares, it's very easy to transfer moves over the radio.

Nevertheless, even though the games are logically planned, there are still a few problems peculiar to playing over the air. One obvious difficulty is finding another player with the same game. Since both sides must have a copy of the game set, and since there are many games, it might be more difficult to find an opponent than to turn the course of history in the game. Therefore, most of your game-playing may be restricted to a few close friends. Naturally, you don't have this problem with checkers or chess.

Another problem is the sheer physical size of most games. Since the maps are often quite large (about 18 x 36 inches), you may not have room on the desk in front of your rig. Therefore, most players arrange their game on a nearby table and go near their rig only to transmit moves information. A loud volume setting, or external speaker, lets them hear what their opponent is saying.

The only other problem relevant to strategy games is the dice. There are two ways to get around this dilemma: Either you can play the game on the honor system and trust that your opponent isn't shading his dice rolls in his favor, or you can find a willing "referee" ham who will donate his time to roll the dice for you. Some strategy players solve the problem by holding their game sessions in groups of three. That way, the players can rotate turns as combatants and referees from week to week.

### Other games

At this point, the Amateur Radio

game picture starts spreading thin. Actually, it soon becomes evident that just about any board game can be adapted to ham radio. *Monopoly* has been played over the air. But, besides the dice problem, you also have the added complication of dealing money and cards. Still, with a little ingenuity, *Monopoly*, and most other games, can be successfully managed.

By now, you're probably wondering how to find opponents to play with. For chess, the solution is quite simple. Every Sunday at 2100Z, the International Chessplayers Net meets on 14.340 MHz. WB9ZJW, Net Control, says that newcomers are always welcome. He notes that check-ins have included stations from Israel, New Zealand, and many other countries.

For more esoteric games, you'll have to do a little hunting. You can always scan the "Strays" in QST for suitable opponents. Asking around your local radio club or even arranging a club-sponsored game net might be another solution.

Above all, don't feel embarrassed by getting on the air and calling a CQ chess, or CQ *Monopoly*. The FCC has no rule forbidding it, and you just might find yourself with some new friends. After all, mutual interests are what friendships are based on.

One last word. If you operate either SSTV or ATV you may find your game horizons considerably expanded. For instance, you can play a game with any willing ham TV buff, whether he has an identical game set or not. Just show him his moves from your board. As a matter of fact, some ATVers have done away with gameboards altogether — they play video games.

So, from chess to *Pong* — checkers to *Monopoly*, hams around the world are channeling their game-playing talents into real competition. Anyway, playing a board game is a lot more constructive than playing games with a net control. A lot more fun, too!

HRH







**Dear Horizons:**

Your fine article in the November, 1979, issue on QRP and QRP<sub>p</sub> operation fosters an incorrect concept which all the magazines of the ham world seem to adhere to; when operating QRP listen for the strong station and answer his call.

I cannot claim to be a long-time and experienced operator, but I have found that, on the crowded Novice bands, if you scan the band and find yourself a semi-quiet niche and call CQ, 50 per cent of the time you will get an answer from an alert ham.

It is just as difficult to be heard in crowded conditions answering a CQ as sending your own, perhaps more so, as most operators take the strongest signal in answer to their CQ.

Your November issue was the first I had read, and I must congratulate you and your writers on their style. It is the most readable magazine of them all, particularly for us neglected beginners.

**John R. MacKenzie, KA7FEE**  
Portland, Oregon

**Dear Horizons:**

I have two questions, one, Where is that jammer noise coming from that I hear all over 15 meters? It's hard to copy CW DX sometimes because of it! Two, Please tell me for sure, is it legal for a Novice to talk to a foreigner who's on SSB? In other words, can you use CW to SSB legally? I've heard a lot of good foreign DX in the 15-meter band in the Novice portion, and was wondering if it's legal for me to break in on CW with the foreigner answering on SSB.

Some of the area hams here said it's illegal, while some said it's legal; please tell me for sure.

**Bill Coleman, Jr., KA4DAP**  
Rocky Mount, North Carolina

*The "jammer" is apparently a Russian radar signal of some sort, and efforts to get it stopped have proved to no avail. Most of the Amateur world, as well as commercial operators, have been complaining about it for some two or three years now.*

*Sure, it's legal for you to work CW to SSB, as long as you are in your segment of the band. Not many DX stations have the time or patience to work SSB to CW, but there are some who make an effort to work and encourage Novices. Someone should award a special certificate to those who do.*

**Editor**

**Dear Horizons:**

Reflecting on your very nice December cover, I couldn't help but wonder if the folks that were responsible for it might not have been OD'd on camel patches, which they no doubt mistook for Pistachio nuts!

This profound statement is a result of reading page 2 where someone referred to the beautiful KWM-380 as a reflection that should make any red-blooded ham sit up and start checking.

I did, and, gol-darn it, a reflection is generally a reverse image.

No reflection on your image, though. Still the best ham reading here! Happy New Year.

**Norm Miller, NØAJH**  
Ft. Collins, Colorado

**Dear Horizons:**

Amateur Radio has been a stimulating and rewarding hobby for me during the past year and a half, and I was always impressed by the sense of camaraderie and friendship among our world fraternity members. Recently, this close bond was dramatically reaffirmed.

As an elementary school teacher (Intermediate Special Education), I experimented with Amateur Radio as a motivational/educational tool in the classroom and had great success; but that is not the primary reason for this letter.

In order for my "Amateur Radio Project" to succeed, it was necessary to have the cooperation of all Amateurs contacted (on 10 meters). The first phase of the project was to have the students develop their letter-writing skills, so they each wrote to a station I contacted. In each envelope

was enclosed an SWL card of the student's design.

The response was very gratifying. Not only did the stations QSLed in this manner respond by sending a QSL card, but they wrote extremely encouraging letters, and in many cases included travel brochures, post cards, and even stamps from their country. My students were tremendously excited — they couldn't wait for the next postal delivery. Finally, letter-writing had a meaning for them. It meant that people would respond. No longer was it merely a tedious skill that had to be learned. And, the gains in their language and reading skills were made at an accelerated rate. Thank you, Amateur Radio.

The prime reason for this letter is to thank all the Amateur Radio operators throughout the world for their marvelous response. To single out only a few would have to be at the expense of many others — so I won't, but, I am proud to be a member of this great fraternity. For the short project time period, my students had a glimpse of a world without boundaries, with great fellowship and exceptional warmth. Hopefully this experience will be imprinted in their memories.

**J.J. McGrand Catholic School**  
Metropolitan Separate School Board  
Toronto, Ontario, Canada

**Dear Horizons:**

Every month I look forward to receiving your magazine and I find every page full of action and I have heard of your radio, "The 50-watter," but I cannot seem to find the plans for it. I would appreciate it if you could tell me how to get these plans. The reason I want the plans is because I am thirteen, and I cannot find any radio plans that I can locate all of the parts for. If you or your readers can help me out of this situation I would be grateful!

**David C. Taylor**  
Kingwood, Texas

**David:**

Our "50-Watter" is a CW-only transmitter which was described in the July and August, 1978, issues of Ham Radio Horizons. The companion receiver was described in the February, March, and April issues. These back issues are available for \$2 each. Both the transmitter and receiver use



parts that are not too difficult to find, although you may have to shop around a bit — many items are available at Radio Shack stores. **Editor**

**Dear Horizons:**

I'd like to suggest that you carry, as a project, a cw monitor that samples the rf in a transmission line. The commercially available sensors that sample rf for counters and oscilloscopes could probably be used in the line. It should be quite small, with an enclosed speaker, and probably not require batteries or other sources of power.

In addition to monitoring cw, such a device would also monitor, audibly, the purity of the transmission: any ac would immediately be known to the operator. By contrast, a transmitter or keyer sidetone gives no indication of an undesirable or illegal tone.

**Roy B. Coleman**  
Lakeland, Florida

**Dear Horizons:**

Is it okay for a General-class ham to get on the Novice band and give a hand to the Novices? Is the allocation exclusive?

**Eugene H. French**  
Eastford, Connecticut

*Not only is it okay to do so, but it is a wonderful idea, Eugene. The only restriction is that when you operate in the Novice segment you observe the same power limit they have, 250 watts input to the final stage of your transmitter.* **Editor**

**Dear Horizons:**

Of recent date, I have been in contact with several stations on 75 meters, and heard of an antenna known as the G5RV, which they saw and built from an article in *Ham Radio Horizons*.

I am writing to ask that you send me the particulars on this antenna, and also to let you know your magazine is enjoyed.

Thanking you in advance for this info.

**Ralph S. Lees, Jr.**  
New York, NY

*That certainly is a popular antenna, Ralph. The information appeared in Ham Radio Horizons for June, 1977, on pages 36 and 37. It's an uncompli-*

*cated antenna that seems to work well on all bands, with or without an antenna tuner.* **Editor**

**Dear Horizons:**

I don't have much to say about WIHR's editorial in the November issue, except that I agree with him 100+ per cent! This won't change any of the views of the "good ole days" folks, but it does reaffirm the feelings of those of us who have had to listen to that baloney on the air! I am tired of listening to hams who think that technology is ruining Amateur Radio . . . these people can't look beyond their nose to see that they themselves are a product of continuing technology.

**Steve Baumrucker, WD4MKQ**  
Durham, North Carolina

**Dear Horizons:**

Enclosed please find a copy of a certificate being offered by SPESM (Society For The Preservation and Encouragement of Six Meters) for crossband operation between 6 and 10 meters.

The cost of the certificate is \$1.00 to cover handling and shipping.

**Armin Montavon, WB9OVC**  
Secretary & Treasurer, SPESM  
P.O. Box 268  
S. Elgin, Illinois 60177

**Dear Horizons:**

Certainly appreciated your article on interference in Focus and Comment. However I have one thing I would like to add for your thoughts.

There are many low-powered rigs on the air now, and thoughtless hams tune up on them and even send out CQs without first listening to see if the frequency is in use. This would bear mentioning, as also would the jokers who lay a book on the key and go for coffee because the band is crowded and they are inconvenienced. I am sure much of this is from many former CBers who are used to this.

*Ham Radio Horizons* is one of the finest Ham magazines I have read. I belong to ARRL only because I feel we must have a powerful voice up front where it counts.

**Clyde Stanfield, WA6HEG**  
Upland, California

**Clyde:**

*Thanks for your thoughts about in-*

*terference and operating habits. Unfortunately, the interference problem is going to get worse as the numbers of Amateurs increase. That's where better, more selective equipment comes in, as well as increased skill in copying signals during rough conditions.*

*In all fairness, I must point out that CBers cannot be blamed for all of the problems, because these things were going on long before there was a CB service. While some of the interference may be deliberate, it is also fact that inadequate shielding and grounding will allow a strong signal to radiate, even if the Amateur tuning up his transmitter is using a dummy load in the best of practice. For example, some of the "cheapie" coaxial cable on the market today has such poor braid cover that it allows 10 to 20 per cent of the signal to leak through it. If someone is tuning a 1-kW transmitter into a dummy load, but the cable is letting 100 watts of his signal leak out and radiate — he'll be heard thousands of miles away, in spite of his good intentions!*

*As for those who deliberately interfere — may a thousand fleas infest their headset, and all their final tubes turn blue.* **Editor**

**Dear Horizons:**

It would seem that someone has made a large mistake on page 13 of your November, 1979, issue. You show what is to be an economical Heathkit HW-8 receiver, but the picture is of the SB-104A Heathkit Transceiver. The one that is written about is on page 14.

Send me a huge shipment of the one shown on page 13 of your magazine!

**R. T. Nelson**  
Grantsburg, Wisconsin



*Will the real HW-8 please stand up!*

**Editor.**



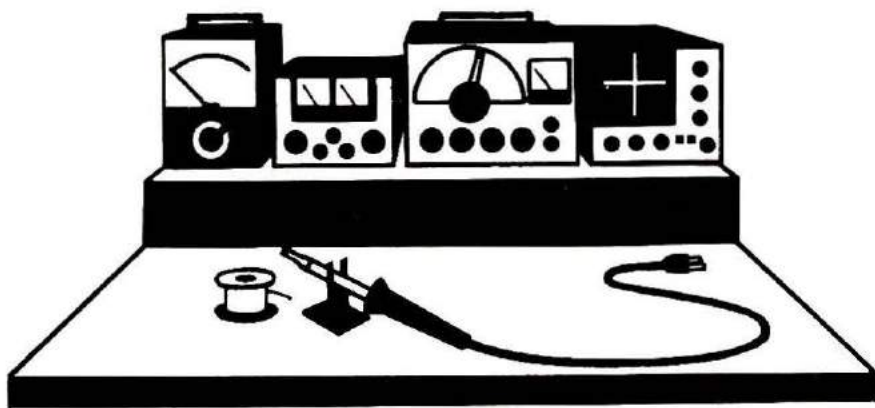

# BENCHMARKS

## PC Board Tie Points

For general bread-board-type of construction, copper-clad material is hard to beat. When its excellent grounding characteristics are combined with the use of short component-lead lengths, it is a natural for vhf construction. However, there is one problem, and that is the difficulty of providing tie points. Here is a simple way to build low-loss tie points, and, if you have some old computer-

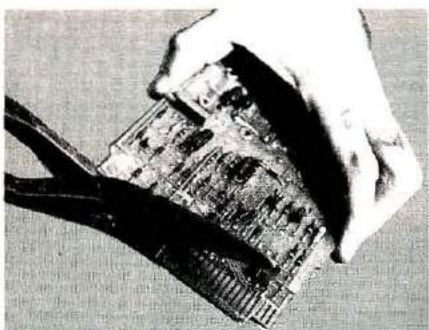
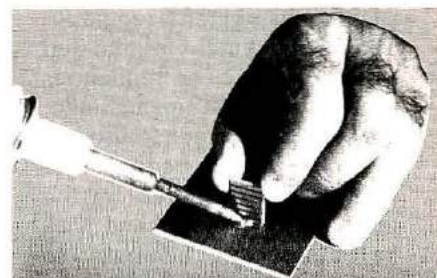
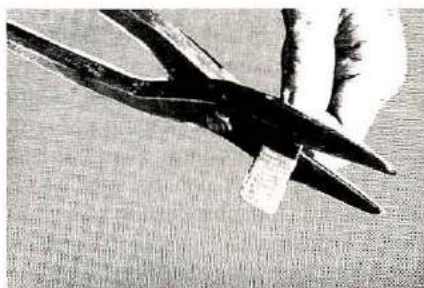

**Fig. 1.** First cut a piece of the edge connector with a pair of tin snips.

type circuit boards in your junk box, you can do it at no cost.

To make a tie point, the edge connector on a scrap circuit board is cut off and modified. The first step is to cut off a length of edge-connector from the circuit board with a pair of tin snips, **Fig. 1**. Next, cut off a short length of the strip, a half-inch or so (**Fig. 2**), and solder it to your baseboard. Finally, add components and wiring, and you will have a complete circuit, as shown in **Fig. 3**.

It is not necessary to mount the tie



**Fig. 2.** Now chop the strip down to half-inch pieces, left, and solder the lowest copper pad directly to the baseboard. Use a 35-watt, or larger, soldering iron.

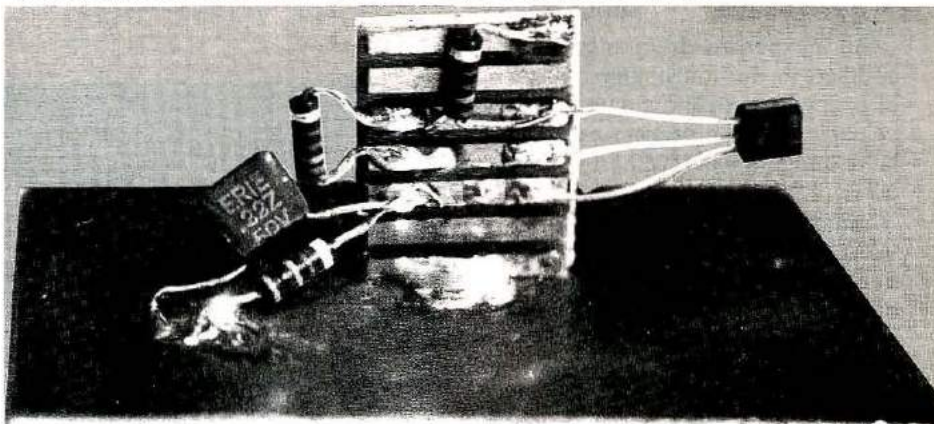

**Fig. 3.** Finally install the components. In this example, a one-transistor amplifier is shown mounted on a single tie strip.

strips perpendicular to the board as shown; they can be mounted flat against the baseboard, and held down with a couple of pieces of bare hookup wire. To do this, first solder two one-inch pieces of bare wire to the foil strips on each end of the tie strip. Then, tack-solder the ends of the wires to the copper-clad baseboard.

I have found that edge connector stock cut from G-10 type epoxy printed-circuit board makes better tie

strips. This board is able to withstand the heat of soldering better, and the copper strips seem to adhere to an epoxy circuit board better than they do phenolic board.

Try a few circuits with this technique, and see how well it works. I have used this tie-point method for circuits from dc through 2 meters, with excellent results. It will work well for you, too.

**George Hovorka, WA1PDY**



## Sampling Circuit For Digital Readout

How many times have you heard someone say something like, "I'll look for you on 80 meters. Give me a call on 3595 kHz." Unless you have an accurately calibrated dial, or digital readout system, for your transceiver, it may not be too easy to find the frequency. Of course, beyond simple convenience is the FCC requirement of Regulation Section 97.75, which states:

The licensee of an amateur station shall provide for measurement of the emitted carrier frequency or frequencies and shall establish procedures for making such measurement regularly. The measurement of emitted carrier frequency or frequencies shall be made by means independent of the means used to control the radio frequency or frequencies generated by the transmitter apparatus and shall be of sufficient accuracy to assure operation within the amateur frequency band used.

An inexpensive frequency counter coupled to the transmitter by means of a simple sampling circuit can be a valuable operating accessory and will help in complying with the regulations. I have called this system a "semi-digital readout" because it provides information on the transmitted frequency, but not the received frequency. In general, however, these are the same.

In the past few years, the cost of frequency counters has declined dramatically. It is possible to get a kit, or even a complete kit, for less than \$100. I recently started monitoring my transmissions with a counter and have learned a number of things about the subject.

The time necessary for the counter to take a reading is the "gate" time. Most of the less expensive counters are designed with 1.0 and 0.1 second gates. This means that the frequency will be displayed after a delay of either one or one-tenth second, depending on the setting of the gate control. A carrier is necessary with the system that I employ; CW gives excellent re-

sults. By keying the transmitter for a short time, I can determine my frequency.

The simplest method for taking measurements is to attach an antenna to the frequency counter. Collapsible whips are commonly used, but may present an objectionable appearance. Moreover, it may be difficult to place the counter on anything but the top shelf of the operating bench. This may create a problem for you in seeing the output. The circuit in Fig. 1 provides a solution to two difficulties, notably, location and adequate input.

This sampling circuit will work on the high-frequency amateur bands, 160 through 10 meters. Transmitted power levels of 1 to 200 watts can be sampled without damage to the counter as long as the unit is capable of accepting up to 10 volts RMS on the input terminals. All of the components are common items and are easily found. The packaging can run from simple to elegant. A metal box with circuit board can be produced, or, as I did, the unit can be wired inside a Transmatch. I installed an RCA phono jack on the rear of my Ultimate Transmatch<sup>1</sup> and used point to point wiring for the circuit. A shielded cable connects the Transmatch circuit to the

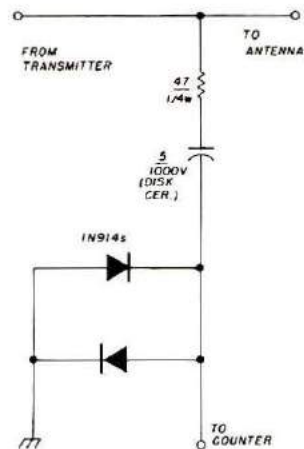

Fig. 1. Schematic diagram of the in-line rf sampling device for the counter.

frequency counter, which can be located in a convenient spot. The results have been very satisfactory, and my frequency counter has become a useful station accessory. It is not a true digital readout system, but it tells me what I need to know.

Thomas M. Hart, AD1B

### Reference

1. *The Radio Amateur's Handbook*, ARRL, Newington, Connecticut, 1979, page 19-8.

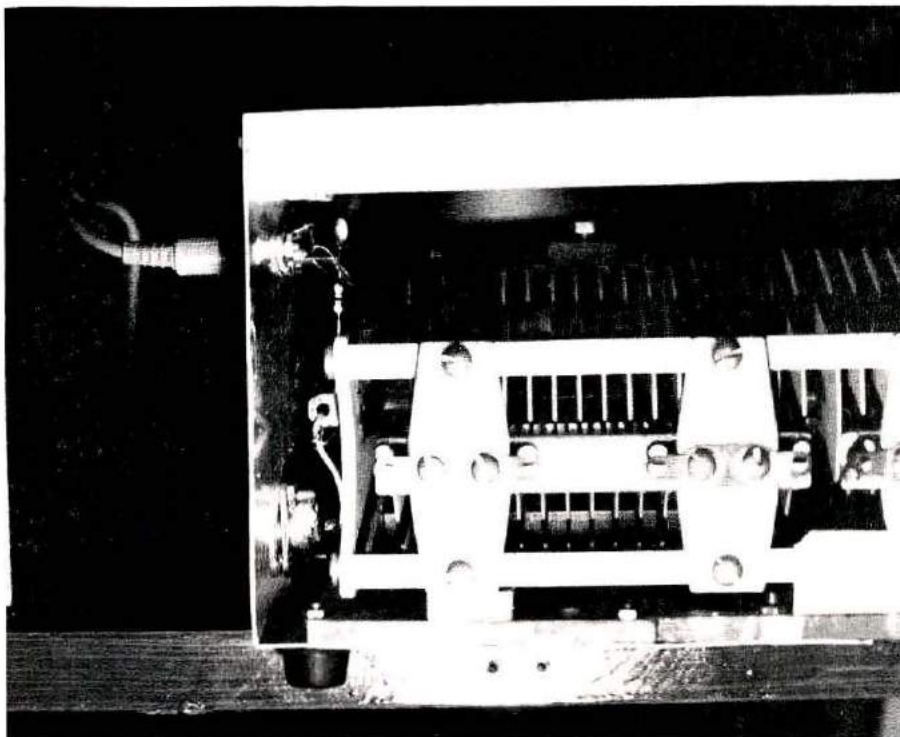

The sampling-circuit components can be mounted inside an antenna-matching device as well. Here it is in an Ultimate Transmatch used by the author.



# PRODUCT SHOWCASE

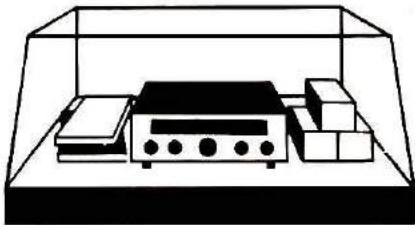

For literature on any of the Product Showcase items use our *ad-check* service on page 78.

## Bird RF Power Analyzer

A new era in rf power measurement was announced by THRU-LINE® Wattmeter designer, Bird Electronic Corp., with the introduction of the new series 4380 RF Power Analyst™. First of the series, the portable model 4381 is a multi-purpose, digital, directional rf wattmeter for power levels from 1/10 watt to 10,000 watts, and from 1/2 to 2300 MHz. CW or fm power in both forward or reflected directions is displayed in

watts or dBm at the push of a button. VSWR is calculated continuously, and indicated through a fifth button, as is dB return loss. Button seven and eight are for peak envelope power (as in SSB transmissions) in watts, and the ninth button calls up per cent modulation. The final set of three buttons make tuning a transmitter, matching an antenna or tweaking rf components a fast and simple task. A delta ( $\Delta$ ) function identifies either rise or fall in displayed values, while a minimum or maximum memory recalls optimum conditions during adjustments. Other models in the 4380 series measure to 250 kW, or are panel mounted.

This new generation of rf wattmeters with nine-mode system versatility was designed around existing Bird Plug-in Elements, which determine full-scale power and frequency range. Once a set of two elements is chosen (for incident and reflected power), the large LED display correctly places the decimal point, making mental notes of multipliers unnecessary. Overranging of up to 120 per cent in watts, and 400 per cent in dBm, often obviates changing to a higher-power element, and retains "up-scale" accuracy.

The RF Power Analyst™ is the first uniquely different directional rf wattmeter system for gauging and analyzing rf power since the Bird THRU-LINE® model 43 was designed 25 years ago. It calculates parameter products that formerly required consulting a graph or chart, reveals whether an undesirable hum is present and — if so — how much, and permits minimum/maximum power searches even with closed eyes. Accuracy of model 4381 is  $\pm 5$  per cent of nominal full scale and VSWR is a low 1.05 max to 1 GHz in 50-ohm systems.

Price of Model 4381 RF Power Analyst is \$590. Delivery is 90 days after receipt of order, from Bird Electronic Corporation, 30303 Aurora Road, Cleveland (Solon), Ohio 44139.



## Signs for Emergency and Mobile Use

Now, any Amateur Radio club can receive the recognition for public-service work it deserves. Fotografix announces the introduction of Amateur Radio public service signs for emergency and mobile use. The signs are entirely magnetic and are guaranteed safe at highway speeds. They have been wind-tested at above 70 miles per hour. Because the entire sign is made of a flexible magnetic material, it attaches securely to magnetic metallic surfaces without room for air pockets.

The signs are available with "AMATEUR RADIO Emergency Communications Unit," or "AMATEUR RADIO Public Service Volunteer" slogans, and can be personalized with club names in quantities of 25 or more sets.

Each sign carries a special logo with radio operator, headphones, and hand-held rig, with storm cloud in the background. The signs are waterproof and wash easily with mild soap and water. They will not fade, peel, or crack in hot sunlight.

The signs are sold individually for \$17.95, in 1-9 pairs for \$29.95 a pair, in 10 or more pairs for \$24.95 a pair, and can be personalized in quantities of 25 pairs or more for \$29.95 a pair. Order from Fotografix, P.O. Box 202, 522 Arizona St., Lawrence, Kansas 66044.



## Test Encoder

The new Communications Specialists TE-64 Test Encoder will provide a total of 64 audible and sub-audible tone frequencies for test purposes. Measuring 5.25 by 3.3 by 1.7 inches, it is ideal for shop or service truck use and with the addition of a 9 v transistor radio battery, it can be made completely self-contained. Mounting brackets are included if permanent installation is required.

Frequencies available include all 32 standard EIA sub-audible, and 19 burst-tone frequencies beginning with 1600 Hz and increasing in 50 Hz increments to 2550 Hz, eight touch-tone frequencies and five test frequencies including 700, 1000, 1500, 2175, and 2805 Hz.

This unit provides a low-impedance, low-distortion adjustable sine wave output at 5 v p-p and may be operated from any external dc voltage from 6 to 30 v. Although primarily designed for test purposes, this unit

may be permanently installed for mobile use as a universal encoder.

The output level is flat to within  $\pm 1.5$  dB over the entire range selected and separate level adjustment controls and output connections are provided for each tone group. There is an "OFF" position for no tone output.

No counter or other test equipment is required to set frequencies, a calibrated dial on the front panel allows selection of the desired frequency.

The TE-64 is totally immune to rf and has built-in polarity protection. External connections are made to an internal terminal block.

A full one year warranty is provided when returned to the factory for repair. Price of the TE-64 is \$79.95, wired, tested, and with complete instructions.

For more information, write Communications Specialists, 426 West Taft Avenue, Orange, California 92667.

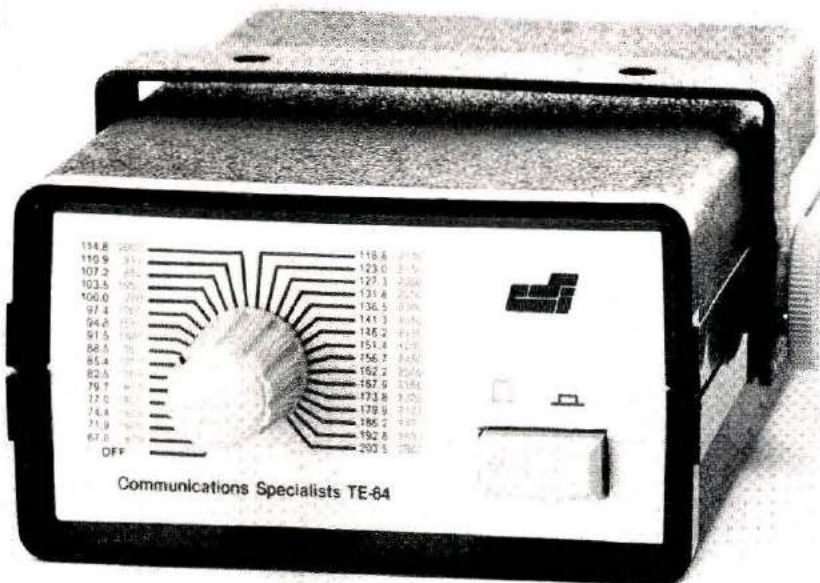

## Amateur Radio Computer Packages from Snow Micro Systems, Inc.

Snow Micro Systems, Inc., provides low-cost hardware and software for the personal-computer user. The diversified line of hardware is designed for club or group construction projects, such as the AMSAT-GOLEM-80 Project. Our expanding line of software is designed and priced for the low-budget, personal-computer user.

The bare boards are sold with schematics, layout drawings, and component lists only, so that schools, Amateur Radio or computer clubs, and other technically competent individuals can save money by assembling the boards themselves. Snow Micro Systems, Inc., warrants that the PC boards are free from physical defects and known circuit errors.

All assembled and tested boards are covered by a standard 90-day warranty.

The AMSAT Telemetry-Range Card (TM .01) contains a bi-directional synchronous/asynchronous serial port (8251A), at 400 Bauds AMSAT Phase III serial TT&C standard. Other rates are available using software-settable counter-timer (8253), audible tone output circuit for bell or CW monitor, Vector Interrupt circuitry (8214/8212), and two programmable 8 bit i/o ports (8255).

It is S-100 Bus interfaced, using standard IC's (8095, 8216 and 8131). Operation of the card is controlled by an 82S23 PROM and jumpers.

This is the S-100 card for reception of the AMSAT Phase III spacecraft telemetry, and for Synchronous Communications. Note that additional external demodulator circuitry will be required to interface this card to a 145-MHz Amateur Radio receiver for AMSAT Phase III satellite reception.

This card is suitable for interfacing most synchronous and packet-data formats to the S-100 bus, providing that any necessary software drivers and modem circuits are part of the system.

Delivery of TM .01 (assembled version), configured for AMSAT Phase III, will be approximately March-June, 1980, to ensure compatibility with the spacecraft.

## Hamtronics 1980 Catalog

Hamtronics, Inc., has announced a new 1980 catalog, which is yours for the asking. The 24-page catalog features many types of kits for the Radio Amateur or two-way shop. Exciting new products in the catalog include a 435-MHz transmitting converter, a new uhf-fm receiver, an a-m receiver for aircraft and DX warning, a weather-tone-alert receiver module, a new

low-noise vhf converter, and several new linear power amplifiers for vhf and uhf. These new products follow in the tradition of other fine Hamtronics kits, including their famous vhf and uhf converters and preamps, and fm transmitters and receivers.

For your free copy of this informative catalog, call 716-392-9430 or write Hamtronics, Inc., 65F Maul Road, Hilton, New York 14468. (For overseas airmail delivery, please send 4 IRCs.)



The Amateur Radio Logging Package (Ham .001) contains commands to allow logs to be created, examined, edited, and printed. The contents of the logs can be examined by prefix (G, G3, G3Z, G3ZC, and G3ZCZ are all valid prefixes) or by dates, or between two dates. Output can be routed to any of the seven (7) devices supported by NORTHSTAR. QSL cards can be printed on label stock, based on log entry information. A separate WAS set of commands allows WAS records to be kept for single-multiple band or modes. (Commands are written in NORTHSTAR Basic.)

The Amateur Radio Contest Package (Ham .002) contains contest programs for the ARRL Sweepstakes as well as a general contest program. The calls of stations worked (check list) are saved in memory, while the log entries are written to the disc in the same format as the log data files in the LOG package. (Commands are written in NORTHSTAR Basic.)

For more information, write Snow Micro Systems, Inc., P.O. Box 1704, Silver Spring, Maryland 20902.

## Heathkit transmitter and receiver

Heath Company introduces a new Amateur transmitter kit and matching receiver kit. The new HX-1681 CW transmitter combines solid-state technology with vacuum tube finals to give a transmitter capable of 100 watts minimum output on 80 through 15 meters, and 75 watts out on 10. It features full break-in CW operation (QSK), built-in VFO, solid-state TR switching, sidetone output with adjustable tone and level, and receiver muting. Keying is provided for the addition of an external power amplifier.

The matching solid-state HR-1680 receiver covers 80 through 10 meters plus the lower 1 MHz of the 10 meter band. It features a preselector-tuned dual-conversion front end for .05  $\mu$ V sensitivity, as well as solid-state diode bandswitching, built-in 100 kHz calibrator and switchable wide/narrow active audio circuitry for SSB or CW operation. The transmitter kit sells for \$239.95 (requires separate power supply) and the receiver is priced at \$209.95. For more information write Heath Company, Department 350-940, Benton Harbor, Michigan 49022.

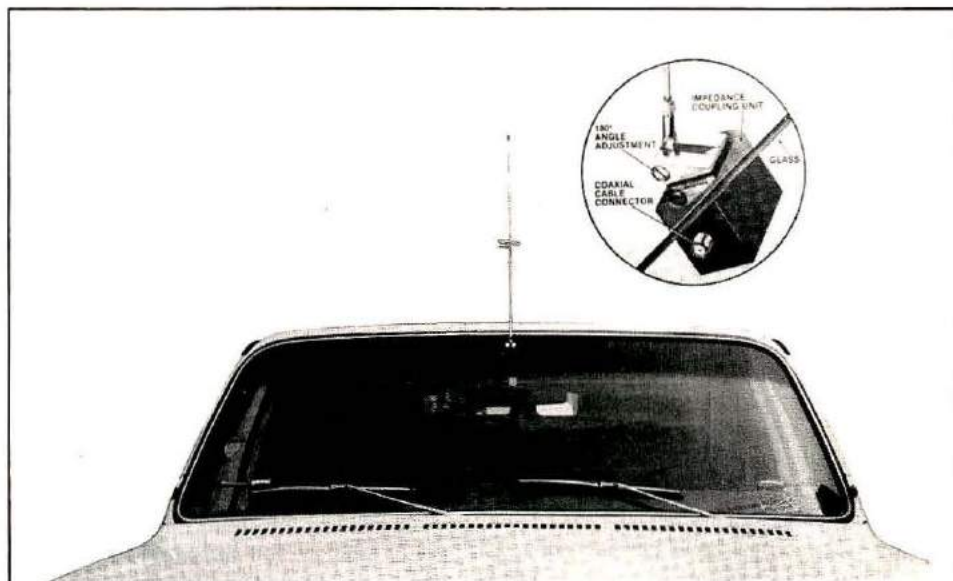

## UHF Glass-Mounted Antennas

As part of their technically advanced "on-glass" design series, Avanti Research and Development, Inc., of Addison, Illinois, is now offering Amateur Radio operators a new 5-dB gain, superior-performance uhf mobile antenna.

Called the AH450.5G, it's a 3/4-meter, 440-450 MHz (tunable 406-512 MHz) antenna that features an exclusive, dual-phased design, and is especially sensitive in fringe areas. It also has the ability to reach distant repeaters, and has a more uniform pattern than a "ground plane."

Avanti's unique on-glass design eliminates the need for external electrical connections — thus preventing coax cable deterioration caused by corrosion and water seepage.

A patented "High-Q" impedance coupling unit, with built-in Ritter noise reduction system, mounts inside the vehicle to assure maximum performance throughout the 440-450 MHz band. Because it transmits and receives through glass, there are no

holes to drill, no car patching at resale time.

AH450.5G also features an exclusive Horizontal Phasing Loop which links two separate antenna systems, creating a lower, more effective take-off angle and higher gain.

The sleek antenna mount is securely locked to the window by a new aerospace adhesive that has greater strength than a 1/4-inch bolt. The whip is easily removed for storage, car wash, or theft protection, and guaranteed to hold securely under even abnormal weather conditions and excessive vibrations.

Besides the AH450.5G, Avanti also makes 3-dB gain, on-glass antennas for Amateur Radio operators in 144-174 MHz and 220-225 MHz, plus trunk-mounted mobile antennas for 144-148 MHz and 440-450 MHz. Especially for Amateurs, Avanti also offers a 10-meter dual-polarity beam (AH-028.9B), which is the original polarity-diversity loop antenna.

For more information, contact Avanti Research and Development, Inc., 340 Stewart Avenue, Addison, Illinois 60101.





## UHF Amateur TV Transceiver From Science Workshop

Science Workshop in Bethpage, New York, has just introduced a new, compact ham TV transceiver, the SE-1. Designed to transmit and receive live, fast-scan, high-resolution black-and-white or color-TV pictures and sound. The SE-1 Transceiver measures only  $9\frac{1}{2} \times 5\frac{1}{2} \times 2\frac{1}{2}$  inches, including knobs and heatsink! Weight, less than 3 pounds.

The receiver section uses a three transistor, four-varactor tuned uhf converter which covers the Amateur 440-MHz band. Its i-f output signal is on vhf-TV channels 2 or 3. A two-stage uhf pre-amp using two high-gain, low-noise FETs, precedes the converter, providing 18-22 dB gain. A front panel RCVR GAIN control provides full rf gain control. Any TV set can be used for high-detail, black-and-white (or color) pictures. The receiver tuning control, labeled RCVR FREQ on the front panel, tunes the converter over the 420- to 450-MHz range. With the switch to left of the illuminated meter set to the RCVR position, the meter reads the varactor tuning voltage, providing an electronic tuning (logging) scale. A green LED in the upper right hand corner of the front panel is illuminated, indicating that the transceiver is in the "receive" mode.

The transmitter section delivers 10 watts (peak), wide-band (adequate for color) video power into 50 ohms. A BNC connector on the front panel accepts the standard 1- to 1.5-volt camera video signal. A 439.25-MHz transmit crystal is supplied (installed) as standard equipment. A four-pin microphone connector is supplied, which provides "push-to-talk" operation. The XMIT/PTT switch on the right hand side of the front panel overrides the "push-to-talk" switch on the microphone, allowing the transmitter to stay on for longer periods of time for testing, or long transmissions.

With the meter AMP/RCVR switch in the AMP position, the meter reads the current drawn by the transmitter. The VIDEO GAIN control adjusts the video modulation level. A toggle switch on the rear selects whether the fm audio will be carrier, or sub-carrier modulation (as in commercial TV). The transceiver is supplied with



## New MFJ Morse-Code-Teaching Computer

The MFJ-410 "Professor Morse" is a Morse-code-teaching computer. It lets you vary the level of difficulty to your ability. You can learn Morse code quicker for the ham ticket or commercial ticket that always seemed just out of reach. Now you can have it.

The MFJ-410 is a random-code generator and keyer combination. It sends alphabet characters only, or combines the alphabet with numbers and punctuation marks. It sends random code in random length groups and never repeats itself, so that it cannot be memorized.

You can learn to recognize characters sent at increased speeds by setting the speed control high, and adjusting the delay to allow longer spaces between letters and groups (i.e., letters at 13 wpm, spacing at 5 wpm).

The MFJ-410 has a speed meter which lets you set the speed of the

random code generator or the keyer to the desired level. Speed is continuously adjustable from 5-50 words per minute. The keyer section uses the proven Curtis 8044 keyer chip.

Professor Morse is excellent for the beginner learning the code, the seasoned operator wishing to reach 50 wpm, or anyone in between.

The MFJ-410 operates on 12 volts dc, from an ac adapter provided, batteries, or car battery through an optional cigarette-lighter plug.

MFJ provides a 30-day, money-back trial period. If you are not satisfied, you may return it within 30 days for a full refund (less shipping). MFJ also provides a one year unconditional warranty.

The MFJ-410 Professor Morse is available from MFJ Enterprises, Inc., for \$149.95 plus shipping and handling.

To order call toll free 800-647-1800 or mail order with check or money order to MFJ Enterprises, Inc., P.O. Box 494, Mississippi State, Mississippi 39762.

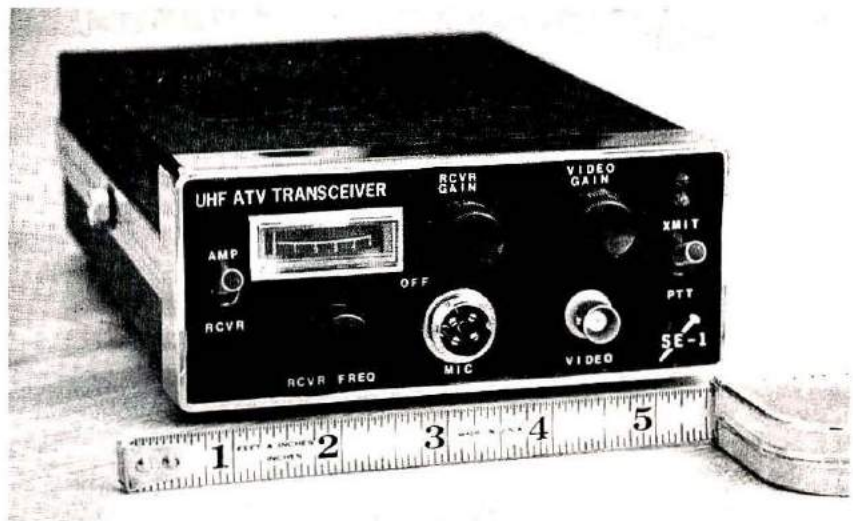

power plug and cable (to operate mobile off the 12-volt car battery or base power supply), mobile mounting bracket, and microphone connector.

It is available from Science Workshop, Box 393, Bethpage, New York 11714, for \$349.95 plus \$3.50 shipping and handling.





**WANT TO START QRP** (Low Power) Ham magazine. Anyone interested in subscriptions and/or contributing articles, write Lynn Woods, 1435 W. 25th, #6, Anchorage, Alaska 99503.

**DISTINCTIVE QSL's** — Largest selection, lowest prices, top quality photo and completely customized cards. Make your QSL's truly unique at the same cost as a standard card, and get a better return rate! Free samples, catalogue. Stamps appreciated. Stu, K2RPZ, Box 412, Rocky Point, NY 11778, (516) 744-6260.

**THE 11TH ANNUAL FM B\*A\*S\*H** will be held on the Friday night of the Dayton Hamvention, April 25, 1980 at the convention center, Main and Fifth Streets. Parking in adjacent City garage. Admission is free to all. Sandwiches, snacks and C.O.D. bar available. Live entertainment provided for a super social evening. Don't miss it. Awards include a new synthesized HT. For further information contact the Miami Valley FM Assn., P.O. Box 263, Dayton, Ohio 45401.

**HAM RADIO REPAIR**, alignment. Hassle-free from anywhere via UPS. Expert, prompt, reasonable. Modern lab. "Grid" Gridley, W4GJO, Route 2, Box 138B, Rising Fawn, GA 30738.

**VERTICAL USERS:** Which installation is best — ground, roof, or pole mount? Our non-technical, detailed, and copyrighted report explains. We've compared them on five bands. \$5. Allow three weeks. Danrick Enterprises, 213 Dayton Avenue, Clifton, New Jersey 07011.

**WISCONSIN: 3-F A.R.C. SWAPFEST**, 8 A.M. to 3 P.M. Saturday, May 3, 1980, at the Neenah Labor Temple, 157 South Green Bay Road (just off Highway 41 at the Highway 114 or 150 exits) in Neenah, Wisconsin. Large parking area, indoor/outdoor swap area, free auction, food & beverage, and much more! Advance admission \$1.50 for tickets and \$1.50 for tables. At door, \$2.00 for tickets and \$2.00 for tables. Talk-in on 146.52 simplex. Contact Mark Michel, W9OP, 339 Naymut Street, Menasha, Wisconsin 54952. Call (414) 722-4034.

**ONLY MY FRIEND'S** recent physical disability makes this top-grade equipment available; purchased new, still in as-new condition, complete with manuals/cables. Bill had literally a store full of items, \$10 to \$100 range, too costly to advertise the list, so tell me what you need. I want to move them now. Anyone having a difficult time learning code and operating CW? These like-new visual decoders and electronic typewriter keyboard: Pickering 230-D Morse Decoder, \$1500; Pickering KB-1 Electronic Keyboard keyer, \$140; Atronics CR-101 Code Reader, \$65; manuals/instructions. Collins: 51S1F, \$2050; 55G1, \$325; 30L1, \$995; 32SA/516F2, \$1775; 312B4, \$425; all Round Emblem, immaculate w/manuals. Two Hy-Gain HT-18, 10-80 meter vertical antennas, \$195 each (phasing harness available); two Murch Ultimate Transmatch UT-2000A, \$125 each; DenTron 3000A antenna tuner, \$230; KLM Multi-2700 144 MHz transceiver, \$575; KLM PA 10-140 BL linear amplifier, \$175; Vista 120 v.a.c./13.8 v.d.c. power supply for above, \$136; excellent condition w/manuals. Ralph E. Thomas, W2UK, 9 Emmons Avenue, Farmingdale, NJ 07727; telephone (201) 938-5623.

**STOP LOOKING** for a good deal on amateur radio equipment — you've found it here — at your amateur radio headquarters in the heart of the Midwest. Now more than ever where you buy is as important as what you buy! We are factory-authorized dealers for Kenwood, Drake, Yaesu, Collins, Wilson, Ten-Tec, Atlas, ICOM, DenTron, MFJ, Tempo, Regency, Hy-Gain, Mosley, Alpha, Cushcraft, Swan and many more. Write or call us today for our low quote and try our personal and friendly Hoosier service. HOOSIER ELECTRONICS, P.O. Box 2001, Terre Haute, Indiana 47802. (812) 238-1456.

**ELECTRONIC BARGAINS, CLOSEOUTS, SURPLUS!** Parts, equipment, stereo, industrial, educational. Amazing values! Fascinating items unavailable in stores or catalogs anywhere. Unusual FREE catalog. ETCO-059, Box 762, Plattsburgh, N.Y. 12901.

**"OHM SWEET OHM"** placard, conversation piece. Suitable for framing. Postpaid \$1.00 WB9YMK, Stan Patla, Route #3, Box 254A. Lake Geneva, WI 53147.

**RATES** Regular classified is available at 50¢ per word. Display classified (1 inch deep x 2 1/4 inches wide) is \$65, or at the 12x rate is \$50. All Ad Scan payable in advance. No cash discounts or agency commissions allowed.

**HAMFESTS** Sponsored by non-profit organizations receive one free regular classified ad (subject to our editing). Repeat insertions of hamfest ads pay the standard rate.

**COPY** No special layout or arrangements available. Material should be typewritten or clearly printed (not all capitals) and must include full name and address. We reserve the right to reject unsuitable copy. *HORIZONS* cannot check each advertiser and thus cannot be held responsible for claims made. Liability for correctness of material limited to corrected ad in next available issue.

**DEADLINE** 15th of third preceding month.

**SEND MATERIAL TO:** Ad Scan, Ham Radio Horizons, Greenville, N. H. 03048.

**"HAMS FOR CHRIST"** Reach other Hams with a Gospel Tract sure to please. Clyde Stanfield, WA6HEG, 1245 Sandra Ct., Upland, Calif. 91786.

**PENNSYLVANIA:** Tradefest '80 sponsored by the Penn Wireless Association, Sunday, April 13, 1980, at the National Guard Armory, Southampton Road and Roosevelt Boulevard (Route 1) 1/2 mile south of Turnpike Exit 28, Langhorne, Pa. Seller's space 6 x 8 foot — \$5. Bring tables. Limited power connections — \$3. General admission — \$3. Prizes, refreshments, rest area, displays and surprises. Talk-in on 146.715 and 146.52. Contact Robert L. Daut, Jr., WB3KRV, P.O. Box 734, Langhorne, Pennsylvania 19047.

**NOVICES:** Improve your skill with eight important operating aids on one 11" x 17" sheet; CW abbreviations, Q-signals, punctuation, U.T.C. conversion and more. \$2. postpaid. WD5KFN, Box 1296, Albany, TX 76430.

**CUSTOM EMBROIDERED EMBLEMS** — Your design, low minimum. Informational booklet. Emblems, Dept 65, Littleton, New Hampshire 03561.

**RADIO EXPO "80"** — Lake County Fair Grounds, Rt. 45 & 120. September 6 and 7. Advance tickets \$2.00, \$3.00 at gate. Write Radio Expo Tickets, P.O. Box 1532, Evanston, IL 60204. Exhibitor information call (312) BST-EXPO.

**MOBILE HF ANTENNA 3.2** — 30 MHz inclusive, 750 watts PEP, center loaded, tuned from the base, eliminating coil changing or removing from mount. Less than 1.5 to 1 VSWR thru entire coverage. 129.95 ea. plus shipping. Contact your local dealer, if none in your area order direct. Anteck, Inc., Route One, Hansen, Idaho 83334. (208) 423-4100. Master Chg. and VISA accepted. Dealer and factory rep. inquiries invited.

**ICOM 701 INTERNATIONAL USER'S CLUB.** Details s.a.s.e. Pohorence, 9600 Kickapoo Pass, Streetsboro, Ohio 44240.

**ALDA OWNERS** need repair service? Have a factory technician who has repaired hundreds on the assembly line, fix your set at the only shop authorized by ALDA when it ceased operation. An inventory of original parts and a completely equipped bench make fast dependable service possible at lowest cost. Ninety percent of repairs are less than \$35.00 including UPS shipping charges. Contact Les Bosley, 215 Via El Centro, Oceanside, CA 92054, Tel. 714-433-6124.

**QSLs SECOND TO NONE.** Same day service. Samples 50 cents. Include your call for free decal. Ray, K7HLR, Box 331, Clearfield, UT 84015.

**CODE FLASH CARDS!** Visualize code — don't try to pronounce it! Based on age-old principle for teaching math, language. Learn code easily, painlessly, in less time! Code Deck \$3.95. Gulf Press, 12 Bigelow Ctr., Ft. Myers Beach, FL 33931.

**QSL ECONOMY:** \$12 per 1000 UPS paid. S.A.S.E. for samples. W4TG, Drawer F, Gray, GA 31032.

**MOBILE IGNITION SHIELDING** provides more range with no noise. Bonding strap sale less than 50¢ each. Literature. Estes Engineering, 930 Marine Drive, Port Angeles, Wash. 98362.

**QSLs with class!** Unbeatable quality, reasonable price. Samples: 50¢ refundable. QSLs Unlimited, 1472 SW 13th Street, Boca Raton, FL 33432.

**SOUNDS OF SHORTWAVE!** 60-minute cassette by Bob Grove, WA4PYQ. Identify facsimile, jammers, telemetry, multiplex, teletype, many more! Side 2! Choosing a receiver, planning an antenna, coping with interference, more! \$5.95 postpaid. Grove Enterprises, Rt. 1, Box 156A, Brasstown, NC 28902.

**DX — YOU BET!** The DX Bulletin — Best weekly DX info in the world — send for FREE sample copy. The DX Bulletin, 306 Vernon Avenue, Vernon, Connecticut 06066.

**QSLs & RUBBER STAMPS** — Top Quality! QSLs: Glossy Inks and Cardstock. Rubber Stamps: Report forms, Call Letter, Address, State outlines — More! Stamp Catalog and Card Samples 50¢. Ebbert Graphics 5H, Box 70, Westerville, Ohio 43081.



# HRH LOCATOR

TO HELP YOU FIND YOUR LOCAL AMATEUR RADIO DEALER

## Arizona

### POWER COMMUNICATIONS

6012 N. 27 AVENUE  
PHOENIX, AZ 85017  
602-242-6030  
Arizona's #1 "Ham" Store,  
Kenwood, Yaesu, Drake, ICOM,  
& more.

## California

### C & A ELECTRONIC ENTERPRISES

22010 S. WILMINGTON AVE.  
SUITE 105  
P. O. BOX 5232  
CARSON, CA 90745  
800-421-2258  
213-834-5868 · Calif. Res.  
Not the biggest, but the best —  
since 1962.

### JUN'S ELECTRONICS

11656 W. PICO BLVD.  
LOS ANGELES, CA 90064  
213-477-1824 Trades  
714-463-1886 San Diego  
The Home of the One Year Warranty  
— Parts at Cost — Full Service.

### SHAVER RADIO, INC.

1378 S. BASCOM AVE.  
SAN JOSE, CA 95128  
408-998-1103  
Atlas, Kenwood, Yaesu, KDK, Icom,  
Tempo, Wilson, Ten-Tec, VHF  
Engineering.

### TELE-COM

15460 UNION AVENUE  
SAN JOSE, CA 95124  
408-377-4479

## Connecticut

### THOMAS COMMUNICATIONS

95 KITTS LANE  
NEWINGTON, CT 06111  
800-243-7765  
203-667-0811 - Conn. Res.  
Call Us Toll Free —  
See Our Full Page Ad in this Issue.

## Delaware

### DELAWARE AMATEUR SUPPLY

71 MEADOW ROAD  
NEW CASTLE, DE 19720  
302-328-7728  
Icom, Ten-Tec, Swan, DenTron,  
Wilson, Tempo, KDK, and more.  
One mile off I-95, no sales tax.

## Florida

### AGL ELECTRONICS, INC.

1898 DREW STREET  
CLEARWATER, FL 33515  
813-461-HAMS  
West Coast's Only Full Service  
Amateur Radio Store

### AMATEUR RADIO CENTER, INC.

2805 N.E. 2ND AVENUE  
MIAMI, FL 33137  
305-573-8383  
The Place For Great Dependable  
Names in Ham Radio

### RAY'S AMATEUR RADIO

1590 US HWY. 19 SOUTH  
CLEARWATER, FL 33516  
813-535-1416  
Atlas, B&W, Bird, Cushcraft,  
DenTron, Drake, Hustler, Hy-Gain,  
Icom, K.D.K., Kenwood, MFJ,  
Rohn, Swan, Ten-Tec, Wilson.

### SUNRISE AMATEUR RADIO

1351 STATE RD. 84  
FT. LAUDERDALE, FL 33315  
(305) 761-7676  
"Best Prices in Country.  
Try Us — We'll prove it."

## Illinois

### AUREUS ELECTRONICS INC.

1415 N. EAGLE STREET  
NAPERVILLE, IL 60540  
312-420-8629  
"Amateur Excellence"

### ERICKSON COMMUNICATIONS, INC.

5456 NORTH MILWAUKEE AVE.  
CHICAGO, IL 60630  
312-631-5181  
Outside Illinois 800-621-5802  
Hours 9:30-5:30 Mon., Tues., Wed.,  
Fri.; 9:30-9:00 Thurs.; 9:00-3:00 Sat.

### KLAUS RADIO, INC.

8400 NO. PIONEER PARKWAY  
PEORIA, IL 61614  
309-691-4840  
Let Us Quote Your Amateur Needs.

### SPECTRONICS, INC.

1009 GARFIELD STREET  
OAK PARK, IL 60304  
312-848-6777  
One of America's Largest  
Amateur and SWL Stores

## Iowa

### BOB SMITH ELECTRONICS

RFD #3, HIGHWAY 169 & 7  
FORT DODGE, IA 50501  
515-576-3886  
For an EZ deal  
800-247-2476/1793  
Iowa: 800-362-2371

## Kansas

### ASSOCIATED RADIO COMM

8012 CONSER  
OVERLAND PARK, KS 66204  
913-381-5900  
America's No. 1 Real Amateur Radio  
Store. Trade - Sell - Buy.

## Maryland

### THE COMM CENTER INC.

9624 FT. MEADE ROAD  
LAUREL PLAZA RT. 198  
LAUREL, MD 20810  
800-638-4486  
R. L. Drake, Ten-Tec, Icom, Swan,  
Tempo, Wilson, DenTron, Mosley.

## Minnesota

### PAL ELECTRONICS INC.

3452 FREMONT AVE. NO.  
MINNEAPOLIS, MN 55412  
612-521-4662  
Midwest's Fastest Growing Ham  
Store. Where Service Counts.



## Nebraska

**COMMUNICATIONS CENTER, INC.**  
443 N. 48 STREET  
LINCOLN, NE 68504  
800-228-4097  
Kenwood, Yaesu, Drake and More  
at Discount Prices.

## New Hampshire

**EVANS RADIO, INC.**  
BOX 893, RT. 3A BOW JUNCTION  
CONCORD, NH 03301  
603-224-9961  
Icom, DenTron, Yaesu, Drake.  
We service what we sell.

## New Jersey

**ATKINSON & SMITH, INC.**  
17 LEWIS STREET  
EATONTOWN, NJ 07724  
201-542-2447  
Ham supplies since "55".

**BARGAIN BROTHERS  
ELECTRONICS**  
216 SCOTCH ROAD  
GLEN ROC SHOPPING CTR.  
WEST TRENTON, NJ 06828  
609-883-2050  
A million parts — Lowest prices  
anywhere. Call us!

**BARGAIN BROTHERS II  
ELECTRONICS**  
181 HADDON AVENUE  
WEST BERLIN, NJ 08091  
609-767-5252  
Surplus Parts and Equipment  
Bought — Sold — Traded.

**METUCHEN RADIO**  
216 MAIN STREET  
METUCHEN, NJ 08840  
201-494-8350  
New and Used Ham Equipment.  
WA2AET "T" Bruno

**RADIOS UNLIMITED**  
P. O. BOX 347  
1760 EASTON AVENUE  
SOMERSET, NJ 08873  
201-469-4599  
New Jersey's Fastest  
Growing Ham Store.

**ROUTE ELECTRONICS 46**  
225 ROUTE 46 WEST  
TOTOWA, NJ 07512  
201-256-8555  
Drake, Swan, DenTron, Cushcraft,  
Hy-Gain, Hustler, Larsen and more.

**WITTIE ELECTRONICS**  
384 LAKEVIEW AVE.  
CLIFTON, NJ 07011  
201-772-2222  
Same location for 62 years.  
Full-line authorized Drake dealer.

## New York

**HAM-BONE RADIO**  
(Div. Stereo Repair Shop)  
3206 ERIE BOULEVARD EAST,  
SYRACUSE, NY 13214  
315-446-2266  
We Deal, We Trade,  
We Discount, We Please!  
2-Way Service Shop on Premises!

**HARRISON RADIO CORP.**  
20 SMITH STREET  
FARMINGDALE, NY 11735  
516-293-7990  
"Ham Headquarters USA®"  
since 1925.  
Call toll free 800-645-9187.

**RADIO WORLD**  
ONEIDA COUNTY AIRPORT  
TERMINAL BLDG.  
ORISKANY, NY 13424  
800-448-7914  
315-337-2622 } NY  
315-337-0203 } Res.  
New & Used Ham Equipment. See  
Warren K2IXN or Bob WA2MSH

## Ohio

**AMATEUR RADIO  
SALES & SERVICE INC.**  
2187 E. LIVINGSTON AVE.  
COLUMBUS, OH 43209  
614-236-1625  
Antennas and Towers  
for all services.

**UNIVERSAL AMATEUR RADIO, INC.**  
1280 AIDA DRIVE  
COLUMBUS (REYNOLDSBURG)  
OH 43068  
614-866-4267  
Complete Amateur Radio Sales and  
Service. All major brands - spacious  
store - near I-270.

## Pennsylvania

**HAMTRONICS, DIV. OF  
TREVISE ELECT.**  
4033 BROWNSVILLE RD.  
TREVISE, PA 19047  
215-357-1400  
Same Location for  
More Than 30 Years.

**LaRUE ELECTRONICS**  
1112 GRANDVIEW STREET  
SCRANTON, PENNSYLVANIA 18509  
717-343-2124  
ICOM, Bird, Cushcraft, CDE,  
Ham-Keys, VHF Engineering,  
Antenna Specialists.

## South Dakota

**BURGHARDT  
AMATEUR CENTER, INC.**  
P. O. BOX 73  
WATERTOWN, SD 57201  
605-886-7314  
"America's Most Reliable  
Amateur Radio Dealer".

## Texas

**HARDIN ELECTRONICS**  
5635 EAST ROSEDALE  
FORT WORTH, TX 76112  
817-461-9761  
You Bet Fort Worth  
Has A Ham Store!

## Dealers:

You should be  
here too! Contact  
HORIZONS today  
for complete details.

TOLL FREE **800-258-5353**



# MADISON OLYMPIC SPECIALS!

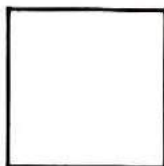

%

WRITE IN  
YOUR  
BEST QUOTE  
FROM THE  
"800 GANG."

NOW, LIST THE EQUIPMENT YOU WANT IN THE SPACES PROVIDED BELOW, CUT OUT THIS AD, AND SEND IT TO US WITH YOUR NAME, ADDRESS AND TELEPHONE NUMBER. WE WILL WRITE  OR CALL  (CHECK ONE) YOU BACK AS SOON AS POSSIBLE WITH THE **MADISON QUOTE**.

(HINT: DON'T GO BELOW OUR COST).

WE HAVE AN IN-DEPTH STOCK AND LARGE INVENTORY OF MAJOR LINES AND ACCESSORIES.

PLEASE QUOTE ON:

1. \_\_\_\_\_  
2. \_\_\_\_\_  
3. \_\_\_\_\_  
4. \_\_\_\_\_

NAME \_\_\_\_\_  
ADDRESS \_\_\_\_\_  
TELEPHONE \_\_\_\_\_  
ZIP \_\_\_\_\_

TERMS: ALL PRICES FOB HOUSTON. PRICES SUBJECT TO CHANGE WITHOUT NOTICE. ALL ITEMS GUARANTEED. SOME ITEMS SUBJECT TO PRIOR SALE. SEND LETTERHEAD FOR AMATEUR DEALER'S PRICE LIST. TEXAS RESIDENTS ADD 6% TAX. PLEASE ADD POSTAGE ESTIMATE.

## MADISON ELECTRONICS SUPPLY, INC.

1508-D MCKINNEY HOUSTON, TEXAS 77002  
713/658-0268 NITES 713/497-5683

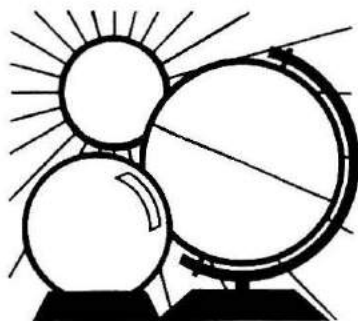

# DX FORECASTER

## Last-minute predictions

March is expected to be an uneventful month in the sense of ionospheric disturbances. You can expect a slight geomagnetic-field disturbance sometime between the 4th and 7th, and again on the 25th. A somewhat more severe upset is possible between the 11th and 14th. The upper layers will be highly ionized during most of the month because of the intense solar activity in progress, and flares could occur anytime with their adverse effects on propagation.

March DXing will be particularly good this year because the peak of cycle 21 coincides with the naturally excellent springtime propagation conditions. Grey-line DXing at dawn and sunset will be quite good, as well, because of the similar conditions north and south of the equator. Now is the time to plan those long-haul, north-south QSOs.

A penumbral (partial) eclipse of the full moon will occur on the 1st. Perigee and the new moon occur on the 16th. The vernal equinox occurs on March 21st.

## Summary

Look for openings on bands from six through one-sixty. You will be bothered slightly by increased noise levels on the lower bands, but this problem will be more than adequately compensated for by the high mufs (maximum usable frequencies) that will extend well above 50 MHz on many days of the month. The noise will be due primarily to the thunderstorms taking place in the south and southwest portions of the United States, and in the tropics.

## Band-by-band Forecast

Six meters will provide many openings during the month, and will peak during the afternoon. You may expect excellent DX between the northern and southern hemispheres. In

general, look for openings on six when ten is open strong to a particular area.

Ten, fifteen, and twenty meters provide fine inter-hemisphere DX, and will be open from sunrise until after sunset on most days. Short skip will be strong during the day. As you go lower in frequency, the bands stay open longer — into the darkness hours after sunset. Plan to work from ten, through fifteen, to twenty.

Forty and eighty meters will show good signals on many days, peaking between the northern and southern hemispheres between midnight and dawn. From sunset until midnight, expect DX into Europe. Toward daylight the Pacific areas should come through.

One-sixty meters will provide some DX during the nighttime hours, and around daybreak on those days when QRN is not too severe.

It is possible that the peak of cycle 21 has just passed, but we can look forward to several more years of excellent DX opportunities on all bands before the subsidence of solar activity takes its toll in declining mufs. Use the accompanying chart for planning your DX activities, because it gives the most probable openings with respect to direction and time for stations in the United States. Also, remember to listen to WWV for updates of solar and geophysical data on their eighteen-after-the-hour broadcasts. In general, low values of K and A indexes mean that the earth's magnetic field has been quiet, while high values of solar flux mean that ionization of the earth's upper atmosphere will support high mufs. A values below 7 or 8, K values below about 2 or 3 and a solar flux index above 200 represent conditions favorable for skip signal propagation. Enjoy, enjoy!

HRH



**WESTERN USA**

**MID USA**

**EASTERN USA**

| GMT  | WESTERN USA |    |    |    |    |    |    |    |      |          | MID USA |           |            |            |           |         |             |       |      |          | EASTERN USA |           |            |           |            |           |         |             |       |    |
|------|-------------|----|----|----|----|----|----|----|------|----------|---------|-----------|------------|------------|-----------|---------|-------------|-------|------|----------|-------------|-----------|------------|-----------|------------|-----------|---------|-------------|-------|----|
|      | PST         | NE | E  | SE | S  | SW | W  | NW | ASIA | FAR EAST | EUROPE  | S. AFRICA | S. AMERICA | ANTARCTICA | AUSTRALIA | OCEANIA | NEW ZEALAND | JAPAN | ASIA | FAR EAST | EUROPE      | S. AFRICA | S. AMERICA | CARIBBEAN | ANTARCTICA | AUSTRALIA | OCEANIA | NEW ZEALAND | JAPAN |    |
| 0000 | 4:00        | 10 | 20 | 10 | 10 | 10 | 10 | 10 | 10   | 10       | 10      | 10        | 10         | 10         | 10        | 10      | 10          | 10    | 10   | 15       | 20          | 20        | 20         | 15        | 10         | 10        | 10      | 10          | 10    | 10 |
| 0100 | 5:00        | 10 | 20 | 20 | 10 | 10 | 10 | 10 | 10   | 10       | 10      | 10        | 10         | 10         | 10        | 10      | 10          | 10    | 10   | 15       | 20          | 20        | 20         | 15        | 10         | 10        | 10      | 10          | 10    | 10 |
| 0200 | 6:00        | 10 | 20 | 20 | 15 | 10 | 10 | 10 | 10   | 10       | 10      | 10        | 10         | 10         | 10        | 10      | 10          | 10    | 10   | 15       | 40          | 20        | 20         | 20        | 15         | 10        | 10      | 10          | 10    | 10 |
| 0300 | 7:00        | 10 | 20 | 20 | 15 | 10 | 10 | 10 | 10   | 10       | 10      | 10        | 10         | 10         | 10        | 10      | 10          | 10    | 10   | 15       | 40          | 20        | 20         | 20        | 15         | 10        | 10      | 10          | 10    | 10 |
| 0400 | 8:00        | —  | —  | —  | 15 | 10 | 10 | 10 | 10   | 10       | 10      | 10        | 10         | 10         | 10        | 10      | 10          | 10    | 10   | 15       | 40*         | 20        | 20         | 20        | 20         | 20        | 20      | 20          | 20    | 20 |
| 0500 | 9:00        | —  | —  | 20 | 15 | 15 | 15 | 15 | 15   | 15       | 15      | 15        | 15         | 15         | 15        | 15      | 15          | 15    | 15   | 20       | 40*         | 20        | 20         | 20        | 20         | 20        | 20      | 20          | 20    | 20 |
| 0600 | 10:00       | —  | 20 | 20 | 20 | 15 | 15 | 15 | 15   | 15       | 15      | 15        | 15         | 15         | 15        | 15      | 15          | 15    | 15   | 20       | 40*         | 20        | 20         | 20        | 20         | 20        | 20      | 20          | 20    | 20 |
| 0700 | 11:00       | —  | 20 | 20 | 20 | 15 | 15 | 15 | 15   | 15       | 15      | 15        | 15         | 15         | 15        | 15      | 15          | 15    | 15   | 20       | 40*         | 20        | 20         | 20        | 20         | 20        | 20      | 20          | 20    | 20 |
| 0800 | 12:00       | 20 | —  | 20 | 20 | 20 | 20 | 20 | 20   | 20       | 20      | 20        | 20         | 20         | 20        | 20      | 20          | 20    | 20   | 20       | —           | 20        | 20         | 20        | 20         | 20        | 20      | 20          | 20    | 20 |
| 0900 | 1:00        | 20 | —  | —  | 20 | 20 | 20 | 20 | 20   | 20       | 20      | 20        | 20         | 20         | 20        | 20      | 20          | 20    | 20   | 20       | —           | 20        | 20         | 20        | 20         | 20        | 20      | 20          | 20    | 20 |
| 1000 | 2:00        | 20 | —  | —  | 20 | 20 | 20 | 20 | 20   | 20       | 20      | 20        | 20         | 20         | 20        | 20      | 20          | 20    | 20   | 20       | —           | 20        | 20         | 20        | 20         | 20        | 20      | 20          | 20    | 20 |
| 1100 | 3:00        | 20 | —  | —  | 20 | 20 | 20 | 20 | 20   | 20       | 20      | 20        | 20         | 20         | 20        | 20      | 20          | 20    | 20   | 20       | —           | 20        | 20         | 20        | 20         | 20        | 20      | 20          | 20    | 20 |
| 1200 | 4:00        | 20 | —  | —  | 20 | 20 | 20 | 20 | 20   | 20       | 20      | 20        | 20         | 20         | 20        | 20      | 20          | 20    | 20   | 20       | —           | 20        | 20         | 20        | 20         | 20        | 20      | 20          | 20    | 20 |
| 1300 | 5:00        | 20 | —  | —  | 20 | 20 | 20 | 20 | 20   | 20       | 20      | 20        | 20         | 20         | 20        | 20      | 20          | 20    | 20   | 20       | —           | 20        | 20         | 20        | 20         | 20        | 20      | 20          | 20    | 20 |
| 1400 | 6:00        | 20 | —  | —  | 20 | 20 | 20 | 20 | 20   | 20       | 20      | 20        | 20         | 20         | 20        | 20      | 20          | 20    | 20   | 20       | —           | 20        | 20         | 20        | 20         | 20        | 20      | 20          | 20    | 20 |
| 1500 | 7:00        | 20 | —  | —  | 10 | 20 | 20 | 20 | 20   | 20       | 20      | 20        | 20         | 20         | 20        | 20      | 20          | 20    | 20   | 20       | —           | 20        | 20         | 20        | 20         | 20        | 20      | 20          | 20    | 20 |
| 1600 | 8:00        | 15 | 15 | —  | 10 | 20 | 20 | 20 | 20   | 20       | 20      | 20        | 20         | 20         | 20        | 20      | 20          | 20    | 20   | 20       | —           | 20        | 20         | 20        | 20         | 20        | 20      | 20          | 20    | 20 |
| 1700 | 9:00        | 15 | 15 | 10 | 10 | —  | 20 | 10 | 20   | 20       | 20      | 20        | 20         | 20         | 20        | 20      | 20          | 20    | 20   | 20       | —           | 20        | 20         | 20        | 20         | 20        | 20      | 20          | 20    | 20 |
| 1800 | 10:00       | 15 | 15 | 10 | 10 | —  | —  | 10 | 20   | 20       | 20      | 20        | 20         | 20         | 20        | 20      | 20          | 20    | 20   | 20       | —           | 20        | 20         | 20        | 20         | 20        | 20      | 20          | 20    | 20 |
| 1900 | 11:00       | 15 | 15 | 10 | 10 | —  | —  | 10 | 20   | 20       | 20      | 20        | 20         | 20         | 20        | 20      | 20          | 20    | 20   | 20       | —           | 20        | 20         | 20        | 20         | 20        | 20      | 20          | 20    | 20 |
| 2000 | 12:00       | 15 | 15 | 15 | 10 | —  | —  | 10 | 15   | 10       | 10      | 10        | 10         | 10         | 10        | 10      | 10          | 10    | 10   | 15       | 15          | 15        | 10         | 10        | 10         | 10        | 10      | 10          | 10    | 10 |
| 2100 | 1:00        | —  | 20 | 15 | 10 | —  | 10 | 10 | 10   | 10       | 10      | 10        | 10         | 10         | 10        | 10      | 10          | 10    | 10   | 10       | —           | 15        | 10         | 10        | 10         | 10        | 10      | 10          | 10    | 10 |
| 2200 | 2:00        | —  | 20 | 15 | 10 | —  | 10 | 10 | 10   | 10       | 10      | 10        | 10         | 10         | 10        | 10      | 10          | 10    | 10   | 10       | —           | 15        | 10         | 10        | 10         | 10        | 10      | 10          | 10    | 10 |
| 2300 | 3:00        | 10 | 20 | 15 | 10 | 10 | 10 | 10 | 10   | 10       | 10      | 10        | 10         | 10         | 10        | 10      | 10          | 10    | 10   | 10       | —           | 15        | 10         | 10        | 10         | 10        | 10      | 10          | 10    | 10 |



| Sunday   | Monday  | Tuesday  | Wednesday | Thursday | Friday | Saturday   |
|--|---|--|-----------|----------|--------|--|
| ARRL Hamfest, New Castle, Delaware 2   | Florida Ham News — Swap Net<br>By the Broward ARC 146.31-<br>91 at 7:30 PM<br>Glenhurst Radio Society Trans-<br>mits Amateur Radio News —<br>222.66/224.26 MHz via<br>WR2APG and 21.400 MHz<br>USB<br>West Coast Bulletin Edited &<br>Transmitted by W6ZF<br>8:00 PM EST 3540<br>MHz, A-1, 22 WPM | AMSAT Eastcoast Net 3850 kHz<br>9:00 PM EDT 0100Z<br>Wednesday Morning<br>AMSAT Mid-Continent Net 3850<br>kHz 9:00 PM CDST 0200Z<br>Wednesday Morning<br>AMSAT Westcoast Net 3850 kHz<br>8:00 PM PDST 0300Z<br>Wednesday Morning |           |          |        | International DX Contest, phone 1-2<br>G-QRP-Club, West Sussex, England, GBUE 1-2  |
| 2  | 3   | 4  | 5         | 6        | 7      | 8  |
| Sterling — Rockfalls Amateur Radio Society Hamfest 80,<br>Sterling High School Field House, Sterling, Illinois, W4PFS 9  | Courses on Microcomputer<br>Interfacing and Digital Elec-<br>tronics, Virginia Polytechnic<br>Institute and State University,<br>Blacksburg, Virginia, Dr.<br>Linda Lefell, 24009 (703-<br>961-5241) 10-18  | AMSAT Eastcoast Net 3850 kHz<br>9:00 PM EDT 0100Z<br>Wednesday Morning<br>AMSAT Mid-Continent Net 3850<br>kHz 9:00 PM CDST 0200Z<br>Wednesday Morning<br>AMSAT Westcoast Net 3850 kHz<br>8:00 PM PDST 0300Z<br>Wednesday Morning |           |          |        | Auctionfest — Sheraton Wayfarer Convention Center — Man-<br>chester, New Hampshire — 7:00 AM, EST, KA1BCA 8<br>Columbus Amateur Radio Club, Hamfest, Municipal Auditori-<br>um, Columbus, Georgia, W4CVY 8 9<br>Lafayette Hamfest/Banquet, Scott Lions Club Building,<br>Lafayette, Louisiana, KSDPG 8-9                             |
| 9  | 10  | 11   | 12        | 13       | 14     | 15   |
| Tri County ARC Hamfest, Jefferson County Fair Grounds, Jef-<br>ferson, Wisconsin, W49VYL 16  | Florida Ham News — Swap Net<br>By the Broward ARC 146.31-<br>91 at 7:30 PM<br>Glenhurst Radio Society Trans-<br>mits Amateur Radio News —<br>222.66/224.26 MHz via<br>WR2APG and 21.400 MHz<br>USB<br>West Coast Bulletin Edited &<br>Transmitted by W6ZF<br>8:00 PM EST 3540<br>MHz, A-1, 22 WPM | AMSAT Eastcoast Net 3850 kHz<br>9:00 PM EDT 0100Z<br>Wednesday Morning<br>AMSAT Mid-Continent Net 3850<br>kHz 9:00 PM CDST 0200Z<br>Wednesday Morning<br>AMSAT Westcoast Net 3850 kHz<br>8:00 PM PDST 0300Z<br>Wednesday Morning |           |          |        | Michigan Crossroads Hamfest, Marshall High School, Marshall,<br>Michigan, 8:00 AM, EST, W8RWXS 15<br>Midland Amateur Radio Club Swapfest, Midland County Exhibit<br>Building, Midland, Texas, 12:00-7:00 PM, CST, W5QGG 15-16<br>Treasure Coast Hamfest, Vero Beach, Florida, W4NPS 15-16<br>ARRL Hamfest, Winchester, Indiana 15-16 |
| 16   | 17  | 18   | 19        | 20       | 21     | 22   |
| Amateur Radio Public Service Association Hamfest, Glen Oaks<br>Community College, Centerville, Michigan, 7:00 AM, EST,<br>K4REG 23<br>1980 B.A.R.T.G. RTTY Contest, 0200 GMT, 22-0200 GMT 24<br>Tennessee QSO Party, 2100Z-0500Z — 23 — 1400Z-2200Z<br>Dave Goggio, 1419 Fossil, Memphis, Tennessee, 38116 22-23<br>Toledo Mobile Radio Association Auction and Hamfest, Lucas<br>County Recreation Center, Maumee, Ohio,<br>W8BFTZ 23 | Florida Ham News — Swap Net<br>By the Broward ARC 146.31-<br>91 at 7:30 PM<br>Glenhurst Radio Society Trans-<br>mits Amateur Radio News —<br>222.66/224.26 MHz via<br>WR2APG and 21.400 MHz<br>USB<br>West Coast Bulletin Edited &<br>Transmitted by W6ZF<br>8:00 PM EST 3540<br>MHz, A-1, 22 WPM | AMSAT Eastcoast Net 3850 kHz<br>9:00 PM EDT 0100Z<br>Wednesday Morning<br>AMSAT Mid-Continent Net 3850<br>kHz 9:00 PM CDST 0200Z<br>Wednesday Morning<br>AMSAT Westcoast Net 3850 kHz<br>8:00 PM PDST 0300Z<br>Wednesday Morning |           |          |        | North Florida Swapfest, Okaloosa County Shore Fair grounds,<br>Fort Walton Beach, Florida, 8:00 AM-4:00 PM, N4PI 22<br>Honor Duty on his 60th year as a Ham, Stephenson Club,<br>Clawson, Michigan, 6:30 PM, EST, W8OU 22  |
| 23   | 24  | 25   | 26        | 27       | 28     | 29   |
| Wisconsin QSO Party, 2100Z-0300Z, N9HR 29-31<br>ARRL Hamfest, Kearney, Nebraska 29-30<br>Baltimore Amateur Radio Club, Greater Baltimore Hambores<br>and Computerfest, State Fairgrounds at Timonium, Baltimore,<br>Maryland 30<br>Worked All Britain Group (WAB), Thurnby Leicester, England,<br>G4BFY 30   | Florida Ham News — Swap Net<br>By the Broward ARC 146.31-<br>91 at 7:30 PM<br>Glenhurst Radio Society Trans-<br>mits Amateur Radio News —<br>222.66/224.26 MHz via<br>WR2APG and 21.400 MHz<br>USB<br>West Coast Bulletin Edited &<br>Transmitted by W6ZF<br>8:00 PM EST 3540<br>MHz, A-1, 22 WPM | AMSAT Eastcoast Net 3850 kHz<br>9:00 PM EDT 0100Z<br>Wednesday Morning<br>AMSAT Mid-Continent Net 3850<br>kHz 9:00 PM CDST 0200Z<br>Wednesday Morning<br>AMSAT Westcoast Net 3850 kHz<br>8:00 PM PDST 0300Z<br>Wednesday Morning |           |          |        | YL International SSBVox Inc. QSO Party 1980, CW, 0001<br>GMT, 2359 GMT, 29 30<br>ARRL Hamfest, The Oasis, Sioux City, Iowa, W8PEX 29   |
| 30   | 31  |  |           |          |        |  |



# WHEN THE KT-34 SPEAKS . . . THE WORLD LISTENS.

(JUST ASK JAY O'BRIEN, W6GO)



## 100 COUNTRIES IN 4½ MONTHS WITH KLM'S KT-34 TRIBANDER!

Congratulations, Jay, on earning the DXCC award (100 countries confirmed!)

Jay is one of those knowledgeable hams who recognized, right from the start, the KT-34's superior design and performance (maybe he was a little surprised by its strong DX capabilities). Look what the KT-34 delivers:

- ★ Phone and CW on 20, 15, and 10M with no retuning
- ★ Linear loading for reduced size, weight, and windload
- ★ 4 KW balun to eliminate matching hassles
- ★ Tough Lexan insulators and stainless steel electrical hardware
- ★ Now, booms of strong 6063-T832 aluminum alloy

And, equally important, the absence of power robbing coils puts the KT-34 in an ENERGY-EFFICIENT class all by itself . . . your signal goes out, not up in smoke. Just ask Jay!



**KLM's KT-34** VOICE OF AUTHORITY  
ON 20, 15, and 10 METERS

KLM, 17025 Laurel Rd., Morgan Hill, CA 95037 (408) 779-7363

### W6GO's SYSTEM

KLM KT-34 @ 56 ft.  
(125' Belden 8214)  
Drake TR-7  
Dentron MLA2500B



# AD CHECK

... for literature, in a hurry — we'll rush your name to the companies whose names you check.

Place your check mark in the space between name and number. **Example:** HRH  150.

|                           |                           |
|---------------------------|---------------------------|
| AR Tech. ___ 687          | Kantronics *              |
| Aluma ___ 589             | Kenwood *                 |
| ARRL ___ 780              | Larsen ___ 078            |
| Antenna Mart ___ 009      | Long's ___ 468            |
| Antenna Supermarket *     | MFJ ___ 082               |
| Avanti ___ 775            | Madison ___ 431           |
| Bencher ___ 629           | Microwave Filter ___ 637  |
| Bird Elect. ___ 018       | Oak Hill Academy A.R.S. * |
| Comm. Spec. ___ 330       | Palomar Eng. *            |
| Dayton Hamvention ___ 223 | RF Power Comp. ___ 542    |
| Digitrex ___ 823          | RSE Ham Shack ___ 607     |
| E.T.O. *                  | Callbook ___ 100          |
| Epsilon ___ 046           | Constructor *             |
| Fotografix ___ 825        | Radio World *             |
| Gem Quad *                | S-F A. R. S. ___ 640      |
| Hal *                     | Science Workshop ___ 680  |
| Ham Gear Mart *           | Snow Micro Sys. ___ 816   |
| HRB ___ 150               | Swan ___ 111              |
| HORIZONS *                | Tedco ___ 791             |
| Hamtronics ___ 246        | Telex Comm. ___ 064       |
| Heath ___ 060             | Ten-Tec *                 |
| Hy-Gain ___ 064           | Van Gorden ___ 737        |
| Icom *                    | Wilson Elec. ___ 123      |
| I. E. C. ___ 793          | Wilson Sys. ___ 787       |
| KLM ___ 073               |                           |

\*Please contact this advertiser directly.

Limit 15 inquiries per request.

MARCH 1980

Please use before April 30, 1980

Tear off and mail to  
**HAM RADIO HORIZONS — "Ad Check"**  
**Greenville, N. H. 03048**

NAME \_\_\_\_\_

CALL \_\_\_\_\_

STREET \_\_\_\_\_

CITY \_\_\_\_\_

STATE \_\_\_\_\_ ZIP \_\_\_\_\_

## A Tip from the Ad Department

*Dear Readers:*

Did you know that **ADVERTISING** pays a big share of the cost of producing each issue of **HRH**?

It's important that **YOU** tell our advertisers where you saw their ads.

Therefore, when you see an ad in **HORIZONS** — **TELL THEM WE SENT YOU!**

The result of all this is more of the kind of magazine you've overwhelmingly told us you want!

**Jim, W1XU**  
**Dottie, KA1BEB**  
**Harold, WA1WPP**

## AD INDEX

|   |                            |
|---|----------------------------|
| AR Technical Products, Inc.             | 52                         |
| Aluma Tower Co.                         | 60                         |
| American Radio Relay League             | 25                         |
| Antenna Mart                            | 55                         |
| Antenna Supermarket                     | 62                         |
| Bencher, Inc.                           | 46, 50                     |
| Dayton Hamvention                       | 30                         |
| Digitrex Electronics                    | 60                         |
| Ehrhorn Technological Operations        | 61                         |
| Epsilon Records                         | 49                         |
| Gem Quad Products                       | 52                         |
| Hal Communications Corp.                | 9                          |
| Ham Gear Mart                           | 61                         |
| Ham Radio's Bookstore                   | 42, 44, 47, 52, 60, 79, 80 |
| Ham Radio HORIZONS                      | 62, 78                     |
| Heath Company                           | Cover IV                   |
| Hy-Gain Electronics                     | 33, 35                     |
| Icom                                    | 7                          |
| International Electronic Communications | 50                         |
| KLM Electronics, Inc.                   | 77                         |
| Kantronics                              | 79                         |
| Trio-Kenwood Communications, Inc.       | Cover III                  |
| Larsen Antennas                         | 45                         |
| Long's Electronics                      | 40, 41                     |
| MFJ Enterprises                         | 3                          |
| Madison Electronic Supply               | 52, 55, 74                 |
| Microwave Filter, Inc.                  | 50                         |
| Oak Hill Academy Amateur Radio Session  | 55                         |
| Palomar Engineers                       | 47                         |
| RF Power Components                     | 52                         |
| RSE Ham Shack                           | 39                         |
| Radio Amateur Callbook                  | 51                         |
| Radio & Electronics Constructor         | 54                         |
| Radio World                             | 46                         |
| S-F Amateur Radio Services              | 46                         |
| Swan Electronics                        | 1                          |
| Tedco                                   | 54                         |
| Telex Communications, Inc.              | 37                         |
| Ten-Tec                                 | Cover II                   |
| Van Gorden Engineering                  | 49                         |
| Wilson Electronics                      | 4                          |
| Wilson Systems, Inc.                    | 56, 57, 58                 |

### Foreign Subscription Agents for Ham Radio HORIZONS

Ham Radio Austria  
 F. Basill  
 Hauptplatz 5  
 A-2700 Wiener Neustadt  
 Austria

Ham Radio Belgium  
 Stereohouse  
 Brusselsesteenweg 416  
 B-9215 Gem  
 Belgium

Ham Radio Canada  
 Box 400, Goderich  
 Ontario, Canada N7A 4C7

Ham Radio Europe  
 Box 444  
 S-194 04 Upplands Vasby  
 Sweden

Ham Radio France  
 SM Electronic  
 20 bis, Ave des Clairons  
 F-89000 Auxerre  
 France

Ham Radio Germany  
 Karin Ueber  
 Postfach 2454  
 D-7850 Loerrach  
 West Germany

Ham Radio Holland  
 MRL Electronics  
 Postbus 88  
 NL-2204 Delft  
 Holland

Ham Radio Italy  
 G. Vulpelti  
 P.O. Box 37  
 I-22063 Cantu  
 Italy

Ham Radio Switzerland  
 Karin Ueber  
 Postfach 2454  
 D-7850 Loerrach  
 West Germany

Ham Radio UK  
 P.O. Box 63, Harrow  
 Middlesex HA3 6HS  
 England

Holland Radio  
 143 Greenway  
 Greenside, Johannesburg  
 Republic of South Africa



# 1980 HANDBOOK

BRAND NEW! STEP INTO  
THE 80'S WITH THE  
LATEST HANDBOOK FROM  
THE EDITORS AT ARRL

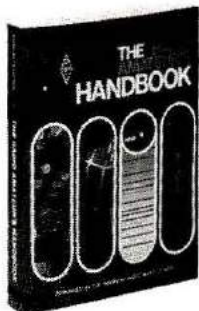

NEW FOR  
1980

Full of exciting new features for the 80's, NOW is the time to order your copy of the 1980 ARRL "RADIO AMATEUR'S HANDBOOK." Internationally recognized and universally consulted, every Amateur should have the latest edition. The new HANDBOOK covers virtually all of the state-of-the-art developments in electronics theory and design. Novices will find it to be an indispensable study guide, while the more advanced Amateur will enjoy building the many new projects.

Order AR-HB80  
Softbound \$10.00

Order AR-BB80  
Hardbound \$15.75

## HAM RADIO'S BOOKSTORE

GREENVILLE, N. H. 03048

(800) 258-5353

1980  
1980  
CALLBOOKS  
See page 44 for super value  
on 1980 Callbooks.  
1980

# Our smart machine reads sloppy copy.

New! Includes 24-hour UTC clock,  
110 and 300 baud ASCII, & tuning eye!



## Kantronics Field Day<sup>®</sup>

\$449.95

If someone tells you they offer the same features we do, check them out with the list below. Kantronics offers the finest in state-of-the-art technology through over 35 dealerships in the United States, Canada and West Germany.

- Morse copying ability
- 3 to 80 WPM Morse range
- Computer programs for improving sloppy Morse
- Radioteletype copying ability - 60, 67, 75 and 100 WPM Baudot
- ASCII radioteletype ability - 110 and 300 WPM baud
- Copies any shift of RTTY
- 24-hour UTC clock available in any mode
- Entire unit contained in one package
- Automatic code-speed tracking
- Full 10-character, large-size display
- Displays code speed
- Tuning eye for faster tuning
- Full year limited warranty
- Internal speaker
- Requires no TV set for use
- Advanced demodulator circuits
- Internal 200 Hz bandwidth filter
- All letters, numbers and punctuation plus 8 special Morse characters and 5 special RTTY characters
- 15-day trial period.

Send for our free brochure that explains the Field Day system of Morse and RTTY decoding. Or you can order from one of our dealers or our factory today. Our number is below, give us a call.

Special SWL model - \$464.95

Free

Code  
Reading  
Made  
Simple

Okay, tell me more.

Name  
Address  
City

State  
Zip

**Kantronics**  
1202 E. 23rd Street (913) 842-7745  
Lawrence, Kansas 66044

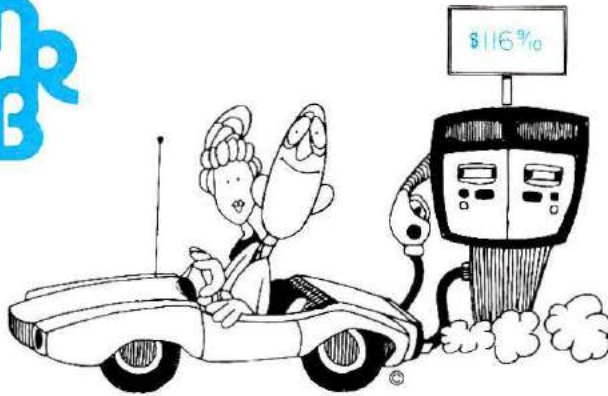

**h  
R  
B**

# SAVE TIME & MONEY!

## Shop By Mail

**NEW**

### RSGB AMATEUR RADIO OPERATING MANUAL

Edited by R. J. Eckersley

Compiled by the RSGB, this exciting new book covers just about every facet of Amateur Radio. Starting with a precise description of the Amateur Service worldwide, the Amateur Radio Operating Manual leads the Amateur through the steps to setting up a station correctly, how to operate properly, DX, contests, satellites, RTTY and Slow Scan Television. You also get 5 big appendices jam-packed with more information; call signs in use, maps, DXCC country list, time zones and international call sign assignments. 190 pages. ©1979.

□ RS-OM

Softbound \$9.95

### AMATEUR RADIO THEORY COURSE

by Martin Schwartz, W2OSH

A complete, well explained, home study course in radio theory, from elementary electronics to antennas, covering the requirements for the Novice, Technician, Conditional, and General Class Amateur License. Each of 14 lessons is followed by practice questions and "FCC Type" examination questions similar to those in the Novice and General Class exams. A complete reprint of the FCC Amateur Radio Rules and Regulations is also provided. Even if you have no prior background in electronics, you'll find this latest revised edition an excellent way to get yourself on the air. 320 pages. ©1979.

□ 102-01

Softbound \$5.95

### REFERENCE DATA FOR RADIO ENGINEERS (6th Edition)

A must for any serious Amateur. In 45 chapters it covers not only every area of basic radio theory, but also goes into such modern areas as micro-miniature electronics and space communications. Literally hundreds of charts, nomographs and tables round out what is probably the most complete reference of this type. Sales of over 350,000 testify to its wide acceptance. 1,196 pages. ©1975.

□ 21218

Hardbound \$28.00

### RADIO HANDBOOK 20th Edition

by William I. Orr

Here's an unbeatable bargain. The Twentieth Edition of the Radio Handbook features:

- A long list of HF/VHF linear amplifier designs using popular high-power tubes.
- Many of the receiver, transmitter, antenna and accessory construction projects which have made the Radio Handbook series so popular.
- A large measure of current reference material.

Lots of usable and valuable information for an unbeatably low price. 986 pages. ©1975. Hurry. Quantities limited!

□ 24032 was \$18.50

Hardbound \$8.95

SAVE over 50%

**NEW**

### GENERAL CLASS AMATEUR LICENSE STUDY GUIDE

by Phil Anderson, WØXI

This book was written in simple laymen's language with uncomplicated explanations and examples used to present electronic radio concepts and ideas. Throughout each chapter, questions and answers are used to strengthen your understanding of the terms and concepts presented. This book also covers several methods that can be used to improve code reception skills. The final chapter is a sample FCC exam which the author feels he would ask if he were to give the FCC exam. 160 pages. ©1979.

□ 21617

Softbound \$6.50

**NEW**

### RADIO PUBLICATIONS SPECTRUM CHART

Here's how to tune in the world! Organized by frequency, this big, attractive, multi-colored wall poster is a must for every ham shack. Covers 10 kHz to 30 GHz listing stations or services assigned by frequency. You also get a time chart that shows each time zone and its relation to GMT.

□ 1978

□ RP-SC

\$4.95

### NEW 1980 34th EDITION WORLD RADIO & TV HANDBOOK

The world's only complete reference guide to international radio and television. This 1980 edition has complete information on each station including address, frequency and scheduling. Much additional information such as solar activity and World Time Table is included. Unquestionably the leading book of this type. 554 pages. ©1980.

□ WR-TV

Softbound \$14.95

### BAND-AIDS

by James Dersch, WØBAJE

The author subtitled this best seller the "Radio Amateur Operator's Handiest Handbook" and for good reason. Here in one easy to use package is a collection of the Ham's most often used operating aids, tables and charts. It contains such handy items as the National Traffic System's NET times and frequencies, WWV and W1AW operating schedules, international prefixes, and time zone conversions, to name only a few. In the non-operating category, Band-Aids contains useful material on Metric conversion, resistor (and other component) color coding, schematic-diagram symbols, telephone touch-tone frequencies, nomographs, and many useful formulas. All spiral-bound in a special heavy duty edition designed to withstand many years of tough station duty. 110 pages. ©1978.

□ CC-BA

Spiralbound \$7.95

# For Even Faster Service Call Toll Free 1 (800) 258-5353

## HAM RADIO'S BOOKSTORE • GREENVILLE, NH 03048



# High quality...top performance!



## Maximum convenience with optimum features

### TS-180S

The TS-180S is Kenwood's top-of-the-line all solid-state HF SSB/CW/FSK transceiver. New circuit-design technology has been incorporated throughout the transceiver, resulting in optimum receiver and transmitter performance, as well as advanced operating features that every DXer, contest operator, and all Amateurs would desire for maximum efficiency and flexibility.

#### TS-180S FEATURES:

- Digital Frequency Control (DFC), including four memories and manual scanning. Memories are usable in transmit and/or receive modes. Memory-shift paddle switches allow any of the memory frequencies to be tuned in 20-Hz steps up or down, slow or fast, with recall of the original stored frequency. It's almost like having four remote VFOs!
- All solid-state...including the final. No dipping or loading. Just dial up the frequency, peak the drive, and operate!
- High power... 200 W PEP/160 W DC input on

160-15 meters, and 160 W PEP/140 W DC on 10 meters (entire band provided). Also covers more than 50 kHz (100 kHz with DFC) above and below each band (MARS, etc.), and receives WWV on 10 MHz.

- Adaptable to all three new bands.
- Improved dynamic range.
- Dual SSB filter (optional), with very steep shape factor to reduce out-of-passband noise on receive and to improve operation of RF speech processor on transmit.
- Single-conversion system with highly advanced PLL circuit, using only one crystal with improved stability and spurious characteristics.
- Built-in microprocessor-controlled large digital display. Shows actual VFO frequency and difference between VFO and "M1" memory frequency. Blinking decimal points indicate "out of band." Monoscale dial, too.
- IF shift... Kenwood's famous passband tuning that reduces QRM.
- Selectable wide and narrow CW bandwidth on receive (500-Hz CW filter is optional).
- Automatic selection of upper and lower sideband (SSB NORM/SSB REV switch).
- Tunable noise blanker (adjustable noise-sampling frequency).

- RF AGC ("RGC"), which activates automatically to prevent overload from strong, local signals.
- AGC (selectable fast/slow/off).
- Dual RIT (VFO and memory/fix).
- Three operating modes... SSB, CW, and FSK.
- Improved RF speech processor.
- 13.8 VDC operation.
- Also available is the TS-180S without DFC, which still shows VFO frequency and difference between VFO and "hold" frequencies on the digital display.
- Full line of matching accessories, including PS-30 base-station power supply, SP-180 external speaker with selectable audio filters, VFO-180 remote VFO, AT-180 antenna tuner/SWR and power meter, DF-180 digital frequency control, YK-88 CW filter, and YK-88 SSB filter.

All of these advanced features can be yours... and at an attractive price! Visit your local Authorized Kenwood Dealer and inquire about the exciting TS-180S with DFC!

**NOTE:** Price, specifications subject to change without notice and obligation.

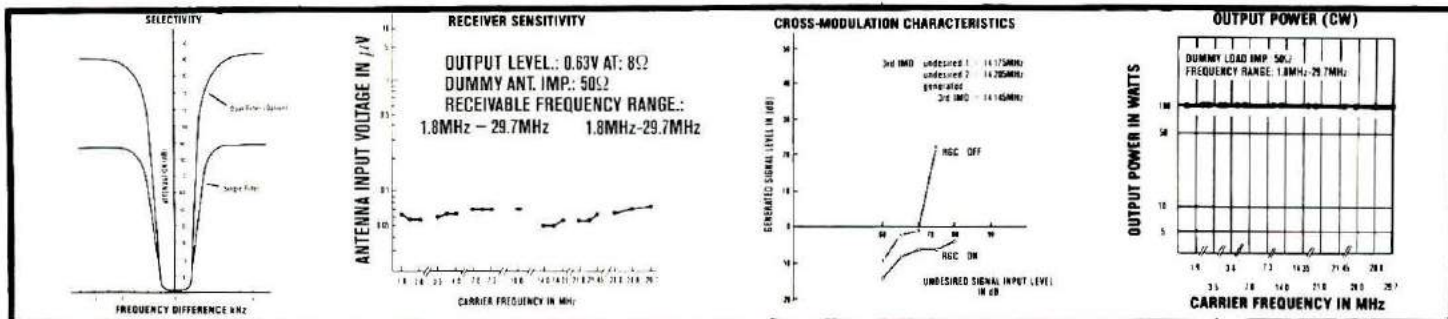



(616) 982-3296

WA8ZVO



# Heathkit<sup>®</sup> service is at the other end

Heathkit Service Techs know their stuff and you can count on them for answers on any Heathkit HAM gear. Most problems can be solved right over the phone. Those that require hands-on service can be brought to one of the 55 Heathkit Electronic Centers throughout the U.S. or sent in to the Heath factory. Either way, you'll find reliable, experienced people who know what they're doing. And that's a very good reason to consider Heath when you're considering amateur radio gear.



## Free catalog

For all the newest in Heathkit Amateur Radio, send for the latest, free Heathkit Catalog. It's loaded with nearly 400 exciting kits for your home, work or pleasure. Send for

yours today or pick one up at your Heathkit Electronic Center.

## Heathkit<sup>®</sup>

Heath Company, Dept. 348-634, Benton Harbor, MI 49022  
Heathkit Electronic Centers (Units of Veritechnology Electronics Corporation)  
are located in major cities throughout the U.S.  
See your white pages.