

75 cents

*hr*_{vr}

focus
on
communications
technology . . .

ham radio

magazine

DECEMBER 1972

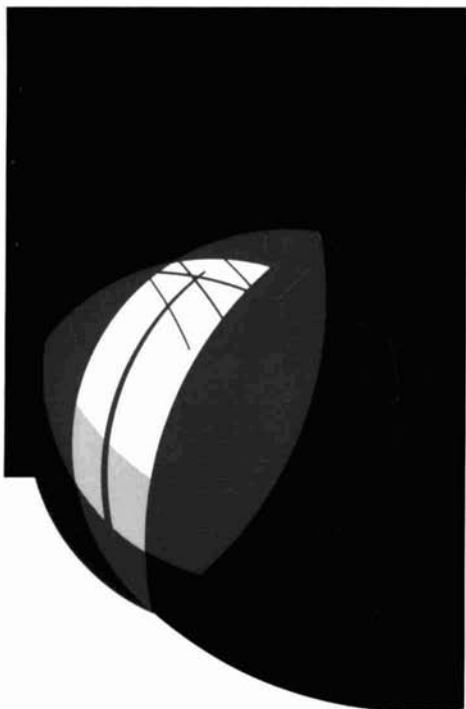

this month

- satellite communications 6
- uhf swr bridge 22
- RTTY monitor receiver 27
- fm channel elements 32
- helical mobile antenna 40

Savoy

HIGH ACCURACY CRYSTALS
FOR OVER 30 YEARS



TYPE 900A

\$3.75

Postpaid in U.S.A.



TYPE 901

Either type for amateur VHF in Regency, Swan, Standard, Drake, Varitronics, Tempo, Yaesu, Galaxy, Trio, Sonar, Clegg, SBE, transmitter or receiver. GE, Motorola, RCA or Oven use \$4.95. Quotes on others.

Specify crystal type, frequency, make of equipment and whether transmit or receive when ordering.



BASSETT VACUUM TRAP ANTENNA SYSTEM

Complete packaged multi-band antenna systems employing the famous Bassett Sealed Resonators and Balun from which air has been removed and replaced with pure helium at one atmosphere. Operating bands are indicated by model designation.

MODEL DGA-4075	...	\$59.50
MODEL DGA-204075	...	\$79.50
MODEL DGA-2040	...	\$59.50
MODEL DGA-152040	..	\$79.50

BASSETT VACUUM BALUN

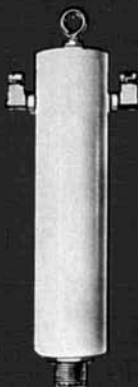

The famous sealed helium filled Balun . . . employed with the DGA Series Antenna Systems. Solderless center insulator and easily handles more than full legal power while reducing unwanted coax radiation. Equipped with a special SO-239 type coax connector and available either 1:1 or 4:1.

MODEL DGA-2000-B . . . \$12.95

Postpaid in U.S.A.

CONTACT YOUR DISTRIBUTOR OR WRITE FOR DATA

Savoy Electronics, Inc.

P.O. Box 7127 - Fort Lauderdale, Florida - 33301

Tel: 305-566-8416 or 305-947-1191



TBL-2000

LINEAR AMPLIFIER
with built-in AC power supply

\$259
complete

160-10 METERS

**BUILT-IN 1000W
RF WATTMETER**



TOP BAND SYSTEMS introduces the TBL-2000, a totally new concept linear amplifier with self-contained AC power supply and built-in RF wattmeter. Weighing but 18 pounds, the TBL-2000 packs a full kilowatt CW and 1600 watts PEP SSB on 160 through 10 meters — including MARS. Assembled in a rugged package, the TBL-2000 boasts a tube complement of five hefty 6LF6 power pentodes, each with its own easy-reach side-panel mounted bias potentiometer for peak performance.

Our team of engineers designed the ultimate in compact linear amplifiers. Loaded with features, the TBL-2000 has the competition beat. For the discriminating Amateur who demands to know what is happening in every part of the circuit, we provide a meter switch capable of monitoring eleven different functions on an illuminated, shielded meter. With a flip of the switch, you can monitor the cathodes of each tube, the total plate current, B+ voltage, RF watts, and much, much more. Our heavy-duty band-switch "snaps" with authority at your command. Our two position tilt-stand adjusts to your eye level. And the TBL-2000 remains cool, even after hours of operation.

Order now, and enjoy the thrills which only a kilowatt can give.

BANDS: 160, 80, 40, 20, 15, and 10 meters, plus MARS

INPUT POWER: 1000W CW, 1600W PEP, 700W RTTY and SSTV

DRIVING POWER: 70W min. — 150W PEP max. before saturation

AC INPUT: TBL-2000: 200VAC-250VAC @ 8 amperes 50/60Hz TBL-2000X: 100VAC-125VAC @ 15A or 200VAC-250VAC @ 8A

WEIGHT: TBL-2000: 18 lb (8Kg), TBL-2000X: 20 lb (9Kg)

SIZE: 12 3/4" W x 11" D x 6 1/2" H. (33cm x 28cm x 16.5cm)

ANTENNA: 50/70 ohms nominally. SWR not to exceed 2:1

METER FUNCTIONS: 0-200mA each tube, 0-2A total plate current, 0-2KV high voltage, 0-200mA screen current, 0-2mA grid current, 0-1000W forward & reflected power.

MODEL TBL-2000

built-in 240VAC supply **\$259**

MODEL TBL-2000X

built-in 120/240VAC supply **\$299**

Airmail shipping

anywhere in USA **\$10**

Airmail shipping anywhere

in the world **\$50 or less**

Spare set five 6LF6 tubes **\$20**

Instruction manual only **\$2**

Calif. residence add 5% sales tax

All COD orders require 20% deposit

TBS

TOP BAND SYSTEMS, INC.

1839 Redondo Ave., Dept. 3A, Long Beach, Calif. 90804 USA



RAYTHEON

**MODEL - 1230
RECEIVER**

THE NEW STANDARD OF RECEIVER EXCELLENCE

- **SYNTHESIZER STABILITY** (Better than 1 Hz/day at any freq.)
- **CONTINUOUS TUNING** (2-30 MHz)
- **TRACKED PRE-SELECTION ON ALL BANDS**
- **DIRECT DIGITAL READOUT TO NEAREST Hz**
- **PHASE LOCKED DETECTORS FOR AM, FM, FSK**
- **INDEPENDENT SIDEBAND AVAILABLE**
- **ALL SOLID STATE** including DISPLAYS

\$3930

FOR COMPLETE DATA WRITE TO:

RAYTHEON COMPANY

MARKETING DEPT. (SPI)
6380 HOLLISTER AVENUE
GOLETA, CALIFORNIA 93017
AREA CODE 805 967-5511

December 1972
volume 5, number 12

staff

James R. Fisk, W1DTY
editor

Patricia A. Hawes, WN1QJN
editorial assistant

Nicholas D. Skeer, K1PSR
vhf editor
J. Jay O'Brien, W6GDO
fm editor

Alfred Wilson, W6NIF
James A. Harvey, W6GIAK
associate editors

Wayne T. Pierce, K3SUK
cover

T.H. Tenney, Jr. W1NLB
publisher

Hilda M. Wetherbee
advertising manager

offices

Greenville, New Hampshire 03048
Telephone: 603-878-1441

ham radio magazine is
published monthly by
Communications Technology, Inc
Greenville, New Hampshire 03048

Subscription rates, world wide
one year, \$7.00, three years, \$14.00
Second class postage
paid at Greenville, N.H. 03048
and at additional mailing offices

Foreign subscription agents
United Kingdom
Radio Society of Great Britain
35 Doughty Street, London WC1, England

All European countries
Eskil Persson, SM5CJP, Frotunagrand 1
19400 Upplands Vasby, Sweden

African continent
Holland Radio, 143 Greenway
Greenside, Johannesburg
Republic of South Africa

Copyright 1972 by
Communications Technology, Inc
Title registered at U.S. Patent Office
Printed by Wellesley Press, Inc
Framingham, Massachusetts 01701, USA

ham radio is available to the blind
and physically handicapped on magnetic tape
from Science for the Blind
221 Rock Hill Road, Bala Cynwyd
Pennsylvania 19440
Microfilm copies of current
and back issues are available
from University Microfilms
Ann Arbor, Michigan 48103

Postmaster: Please send form 3579 to
ham radio magazine, Greenville
New Hampshire 03048



contents

- 6 amateur satellite communications**
Katashi Nose, KH6IJ
- 12 rf speech clipper for ssb**
Leslie A. Moxon, G6XN
- 16 simple antennas for 80 and 40 meters**
Malcolm P. Keown, W5RUB
- 22 uhf microstrip swr bridge**
Arthur R. Hall, W4CGC
- 27 monitor receiver for RTTY autostart**
A. A. Kelley, K4EEU
- 32 fm channel elements**
Thomas McLaughlin, WB4NEX
- 36 monitoring oscillator**
Robert W. Gunderson, W2JIO
- 40 helically-wound mobile antenna**
H. L. Booth, ZE6JP
- 46 autostart and antispace for the ST-5**
Joseph M. Hood, K2YAH
- 52 single-element dx antenna**
B. H. Brunemeier, W6FHM
- 58 antenna tuners**
Edward M. Noll, W3FQJ
- 4 a second look**
- 126 advertisers index**
- 121 annual index**
- 58 circuits and techniques**
- 74 comments**
- 99 flea market**
- 66 ham notebook**
- 80 new products**
- 126 reader service**
- 90 short circuits**



a second look

by **Jim
fisk**

Periodically, a story about the first ham station makes the rounds. It goes something like this: In Boston, just before 1910, there were three young wireless operators, Albert S. Hyman, Robert Almy and Reginald Murray. These young men put together a small wireless station, and since there were no licensing regulations at the time, they decided to call it the Hyman-Almy-Murray Wireless Station.

They soon found that that was quite a fist-full on CW, so they took the first two letters of each name and Station HYALMU went on the air. They used this callsign for several months, but were nearly involved in an international incident when a Mexican ship named the HYALMO almost went aground off the New Jersey coast. They decided that their HYALMU callsign was too close to HYALMO for comfort, so they took the first initials of the three names, and put Station HAM on the air. The first ham station? No. But probably the first, and possibly the only amateur radio station with the HAM callsign.

Several sources have labeled this story as outright fiction, but it has been just persistent enough to arouse my curiosity. Several years ago I decided to track it down, and to determine once and for all if the story had any grain of truth.

Since at least one of the young men was supposedly a student at Harvard University and a member of the Harvard Wireless Club, I decided to start my search in the archives at Cambridge, Massachusetts. Sure enough, deep in the yellowed files there was an entry: Dr. Albert Salisbury Hyman, A.B., 1915; M.D., 1918. Could this be the same man who gave his last initial to Wireless Station HAM?

It looked promising. The Harvard

Alumni Records Office revealed that Dr. Hyman was alive and well, and furnished me with his current address. I wrote to him, and his gracious reply confirmed that, yes, he was the same person who, with boyhood friends Robert Almy and Reginald Murray, had put Wireless Station HAM on the air. He also revealed that the "original ham" story got its start in a story written by wartime correspondent Percy Greenwood for a New York medical publication.

According to Dr. Hyman, Station HAM was not located at Harvard, as Greenwood's story indicates, but was actually at the Roxbury High School, which in the early 1900s was a prep school for the Ivy League.

A further search through the records disclosed that Dr. Hyman, before his graduation, was a shipboard wireless operator for the Eastern Steamship Line that ran ships from New York to Boston through the Cape Cod Canal. After graduation from medical school Dr. Hyman became a heart specialist and owned one of the first electrocardiograph machines in New York (in 1923). He was also the inventor of the artificial pacemaker used in resuscitating the dying heart.

So goes the saga of Wireless Station HAM. It was definitely not the first amateur radio station — that honor goes to some *unknown wireless operator* at least 20 years earlier. Nor does it have anything to do with the fact that radio amateurs are called "hams." That term goes back to the early days of wire telegraphy when unskilled, incompetent operators were called hams by their more experienced colleagues. The connotation is less than desirable.

Jim Fisk, W1DTY
editor

at \$295



it's almost a gift!

**MERRY
CHRISTMAS**
from

ROBOT

- Please send your new factory direct price list.
 Enclosed \$_____. Please send the following
equipment via AIR or SURFACE
 Model 70 Monitor \$295

Name _____ Call _____

Address _____

City _____ State _____ Zip _____

California residents add 5% sales tax. Shipping charges collect.

ROBOT RESEARCH, INC. 7591 CONVOY COURT, SAN DIEGO, CA 92111 (714) 279-9430

polarization of satellite signals

Some background
for understanding
polarization losses
with practical
antenna information
for better
satellite reception

Katashi Nose, KH6IJ, 4207 Huanui Street, Honolulu, Hawaii 96816

With the upsurge of interest in amateur satellite transmissions, amateurs are becoming aware of the problems and challenges of proper antenna polarization for optimum signal reception. The subject is vast and there is still a great deal of experimentation to be done. I hope that these few introductory notes and the reports on some of my experiments might be of interest and assistance to others.

Faraday rotation

Back in 1845, Michael Faraday, the experimental genius, discovered that when a block of glass is subjected to a strong magnetic field, it becomes optically active — it is able to polarize light and, conversely, is able to detect the plane of polarization of light. Light is an electro-magnetic wave and so are radio signals.

A linearly, polarized signal (from a dipole or equivalent) originating in space rotates as it travels through space, the amount of rotation being a function of the magnetic field and electron content of the intervening medium.

Fig. 1 shows a linear wave originating in some form of synchrotron radiation (radio signal) which is rotated as it progresses towards earth through space.

At the earth end of this ribbon, the receiving dipole or array must be rotated to match the polarization at that instant in order to get maximum pickup. A simplified relationship in the case of light is given by:

$$\theta = KHL$$

Where:

- θ = the angle of rotation,
- K = the medium through which the wave travels, sometimes called the Verdet constant,
- H = the magnetic field strength and
- L = the thickness of the medium.

A more practical simplified relationship in the case of radio frequencies is given by:

$$\phi = \frac{K}{f^2} - NH \cos \theta \, dh$$

where:

- ϕ = amount of rotation,
- K = proportionality constant,
- f = frequency,
- H = magnetic field
- θ = angle between the plane of the incident wave and the magnetic field and
- dh = differential element of the path length.

It follows that you can measure the

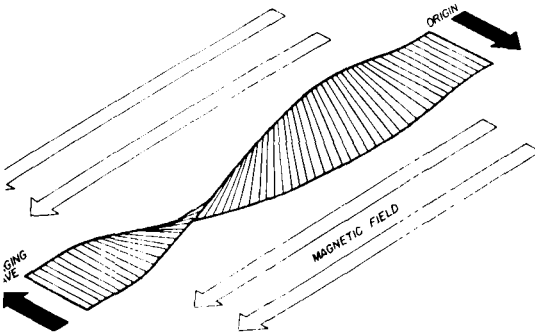

fig. 1. Rotation of wave through a magnetic field.

electron content of the intervening medium by measuring the Faraday rotation. Note that rotation is frequency sensitive.

The photograph shows the ATS-1 communications satellite which weighs 800 pounds and is spin stabilized at 100 rpm, its axis of rotation being parallel to

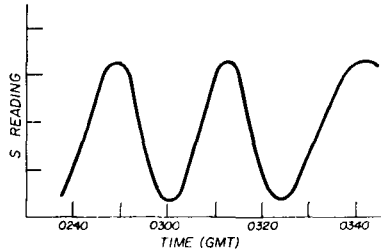
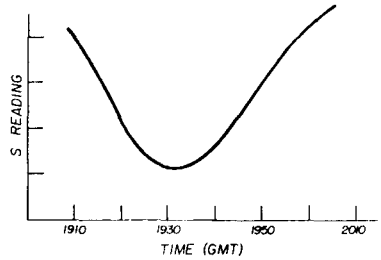

fig. 2. Signal variation due to Faraday rotation. Both readings were taken the same day — November 1, 1971.

the earth. it is geosynchronous at 149° West longitude at the equator which places it around 72° elevation from Hawaii.

The top edge of the photo shows the eight vhf antennas which are phased electronically so that the array sends a conical beam with an aperture roughly corresponding to one third the earth which it illuminates.

The signal is linearly polarized, yet when it arrives on earth, it might have undergone several rotations because of the Faraday effect.

The number of rotations varies from a few degrees per hour to as much as five turns per hour and sometimes even more. A typical rotation curve is shown in fig. 2. Depending on the type of receiving antenna used, signal differential between planes of polarization can be as much as 15 dB. The implication is obvious: you

must correctly polarize the antenna for successful reception.

If a piece of thin mica, commonly known as a quarter-wave plate, is inserted

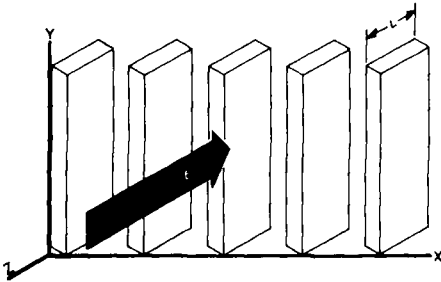

fig. 3. A wave polarizer — the E vector at 45 degrees emerges as a circular wave.

in the path of polarized light, it will introduce a 90° phase shift and a half-wave plate can cause a 180° shift.

Likewise, consider fig. 3 which shows a wave polarizer, which is merely a collection of conducting slabs. If a linearly-polarized radio wave is incident at 45° into the page (z direction), the incident electric field can be resolved into two components. The x component is unaffected since there is little interaction

page) circularly polarized. Conversely, a circularly-polarized wave originating on the back side of the page will emerge out of the page as a linearly-polarized wave.

If the slab dimension L is increased to $2L$ (180° phasing), then the emerging wave will again be linearly polarized since the x and y voltages will be opposite in phase, but the polarization will be displaced by 90°. Increasing the slab dimension to $3L$ makes the emerging wave circularly polarized again but with a counterclockwise rotation. Finally, if the slab dimension is increased to $4L$, the emerging wave is linearly polarized at 45° as in the incident wave. Now, if you are confused, think what you have to contend with when fabricating a circularly polarized antenna using linear (Yagi) elements. Sometimes, at microwave frequencies, slabs of plastic are used to introduce the proper phase delay.

Incidentally, the picket fence analog to explain polarization, so common in high school textbooks, is pedagogically wrong. Fig. 4 shows a rope being vibrated in a circular mode (unpolarized light) which when passing through a slit (polarizer) emerges as a polarized wave. This polarized wave passes through a parallel slit (analyzer) but not through a perpendicu-

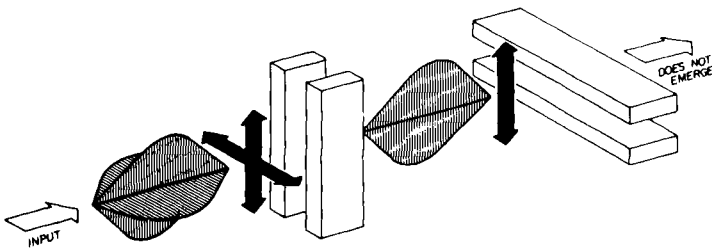

fig. 4. The erroneous picket fence analog of a polarized electromagnetic wave.

with the slabs in the x direction, but the y plane wave is reduced in velocity. If the L dimension of the slabs is sufficient to retard the voltage by 90°, the wave emerges from the back side (behind the

lar slit.

The student erroneously thinks of the plane of the opening as passing the polarized wave. Consider fig. 5 which shows an unpolarized wave from a micro-

wave generator impinging on a grid of wires held at right angles to the plane of polarization. By the picket fence analog the wave should be stopped by the

Look at what you're up against. First, each individual Yagi must produce exactly the same magnitude of voltage at its feedpoint which means that it must be

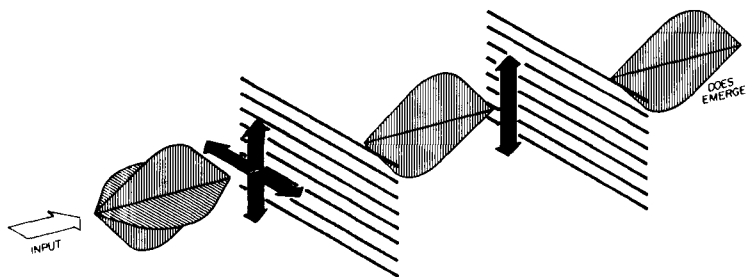

fig. 5. An electromagnetic analog of polarization.

second fence, but no, it goes right through without attenuation. But if the polarizer is held parallel to the plane of the wave, the wave does not emerge from the other side. If the grid elements are less than a half-wave long, there is no interaction with either orientation. Grid elements longer than a halfwave behave like a halfwave grid. The phenomenon is one of absorption and reradiation not of transmission as implied by the picket fence analog.

Where does all this discussion lead to? Merely, that fabricating a circularly polar-

electrically balanced — a difficult task at best.¹ The phasing sections must introduce the right quadrature voltage. Unless you have a line stretcher or some lumped circuit equivalent, this is difficult to do.

More basic than matching and phasing is that you lose a precious 3 dB by the mere act of phasing the two antennas. Depending on the phase and amplitude relations of the two antennas, the combination rejects some circularly polarized waves. Only one-half the energy is accepted.

practical antenna performance

Fig. 6 shows the non-circularity of a commercially made, inexpensive, 4-bay 80-element antenna designed to pick up either vertical or horizontal polarization. Also shown on the same graph is the performance of a home-made, 20-element crossed Yagi, and a four-element linear Yagi which was rotated to follow the Faraday rotation. Readings were taken in rapid sequence on the transponded signal from ATS-1.

Where does all this discussion lead to? Nothing more than what we already know — that the simplest is best. Unless you have access and the know-how to adjust a circular antenna configuration, better stick to a simple Yagi for amateur satellites. If you think big, you won't get there in time.

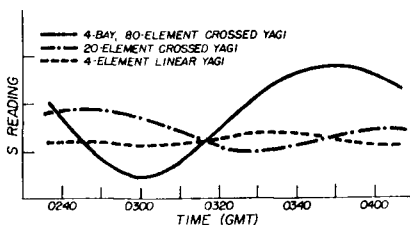
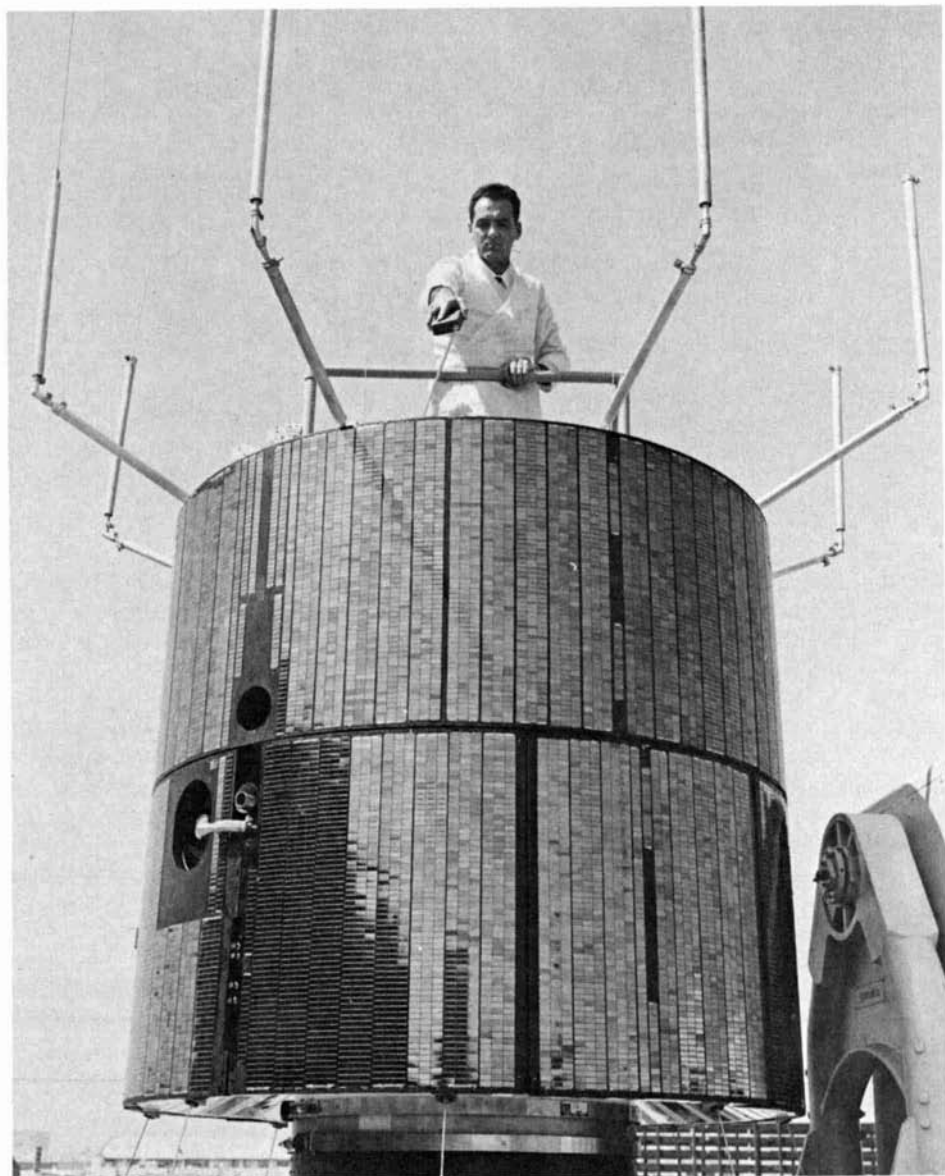

fig. 6. Comparison of different antennas during changing polarization.

ized antenna of the crossed Yagi type for picking up vertically and horizontally polarized signals is not an easy task, and that what most of us like to think of as being a circularly-polarized, crossed Yagi is wishful thinking.



The Applications Technology Satellite (ATS-1) shows antennas at top. (Photo courtesy Hughes Aircraft Company.)

transmitting antenna

Unfortunately, the solution to the uplink problem is completely different. Here we have no choice but to use a circularly-polarized antenna. The entree into the satellite (assuming a linearly polarized antenna) is contingent upon correct polarity because we have no way

of telling what the correct polarization is until we send up a transponding signal.

Fig. 7 shows the rotation necessary for entree into ATS-1 as a function of polarization. As can be expected, with high power (one kilowatt output) there is a broad entree. With low power (ten watts), however, you have to be sure the polarity is correct.

A crossed Yagi is really a turnstile antenna shown in fig. 8, but arranged so that there is axial radiation by use of directors and reflectors. Note that the two radiators must be fed equal-magnitude voltage of the right quadrature — 90° lead or lag for right or left polarization. Any unbalance, either in phase or magnitude, results in an elliptical pattern which degenerates to a linear pattern in the extreme case.

Since you have no choice, make the best of a difficult situation and attempt to tune the Yagis for equal current in the driven elements. This is discussed in a previous article.¹

The cheap and dirty method of tuning for balance is to feed considerable power into the antenna and to go around with a pencil on the end of an insulated stick and touch the various elements. By considerable juggling of element lengths as discussed in the previous article, you can get some semblance of circularity.

Meishin Electric Company of Tokyo has come up with an interesting variation. The driven elements are of turnstile configuration, but the reflectors and directors are circular discs of the proper diameter. Helix antennas are a tale in themselves.

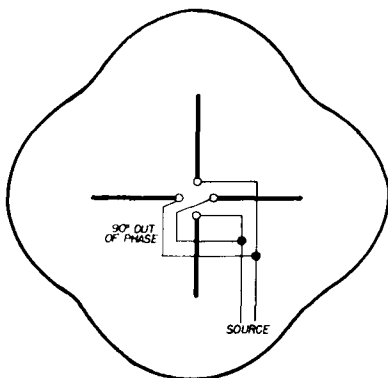

fig. 8. A turnstile antenna and the resultant pattern.

space diversity

There is little to be gained by space diversity since fading is not due to ionospheric reflection or absorption, unless you are receiving at a low elevation angle. Deep fades which occur occasionally are still unaccounted for.

acknowledgements

I wish to thank Mrs. Mary L. Burton, KH6HGO, a graduate mechanical engineer, who patiently took data for months and processed it, and to Mr. Fred Matsunaga, PhD candidate in physics, who stuck with us through the first few months when we did not know which way we were flying.

reference

1. Katashi Nose, KH6IJ, "Notes on Parasitic Beams," *QST*, 1960, page 43.

bibliography

1. "ATS VHF Experimenters Guide," Goddard Flight Center.
2. "Comsat Proposal," Hughes Aircraft Company, 1965.
3. Jenkins and White, "Fundamentals of Optics," McGraw-Hill, New York.
4. Richard L. Koehler, "Report for NASA," Stanford University.
5. John D. Kraus, "Antennas," McGraw-Hill, New York, 1950.
6. J.L. Pausey and R.N. Bracewell, "Radio Astronomy," Oxford Press, 1955.

ham radio

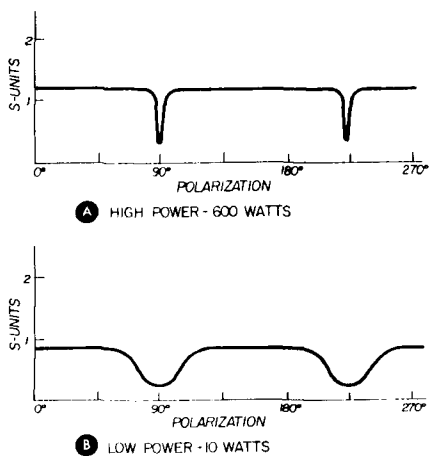

fig. 7. Results of the uplink polarization test with entree to the ATS-1 satellite. Tests were run using an 11-element linear Yagi at experimental station KB2XXK on December 13, 1971.

high-performance single sideband rf speech clipper

This solid-state
rf speech clipper
features the use
of crystal filters
to provide
maximum talk power
with minimum distortion

As I pointed out in last month's issue of *ham radio*, there is considerable confusion over the various aspects of speech processing for ssb.¹ I discussed the different processing systems that are currently being used by amateur radio operators, and tried to clear a way through some of the conflicting statements that have permeated the literature. This month I will discuss a practical ssb speech-processing system, along with some circuit details and operating advantages.

practical speech processing

The first systems I tried were based on surplus FT243 crystals built into a half-lattice filter as shown in fig. 1. Some crystal selection was necessary, particularly for the shunt crystals (Y1 and Y3) which produce the notch on the carrier side of the sideband. Inductor L1 was wound by cut and try to resonate at the desired i-f with about 200 pF at C1. The secondary of L1 consists of 5 or 6 turns wound symmetrically over the primary.

The value of resistor R2 is fairly critical, and if you have trouble obtaining proper passband response, this is the first component to change. If you are not able to obtain suitably-spaced commercial crystals, you may have to resort to grinding. However, the 2.2 to 2.5 kHz frequency separation required is fairly small, and crystals should be readily available.

Although I used an i-f of 5435 kHz, the same alignment procedure should be satisfactory for other frequencies. I have used these half-lattice crystal filters with 2N706 input and output circuits in several transceivers, but construction is simplified through the use of integrated circuits. I used ICs for an improved rf clipper design based on 5200-kHz Japanese crystal filters as shown in fig. 2. There should be no difficulty in adapting this circuit to FT243 crystal filters, although there would be some performance loss because of the lower number of crystals.

design

The first clipping stage is operated with a low value of bias to provide a large dynamic range (and relatively poor limiting). The second stage operates with a higher bias level which provides the over-all limiter characteristic plotted in fig. 3. The diodes I used in the circuit of fig. 2 were salvaged from surplus computer boards, but any switching types should be suitable (I used 1N914s in earlier designs).

The value of capacitor C1 (about 3 pF) may need to be changed to insure that the characteristics of the limiter circuits coincide. The value of C2, about

Leslie Moxon, G6XN, Hampshire, England

2 pF, is selected so that U2 is not driven too hard. With a six-volt power supply, the output voltage was 380 mV, varying with the supply voltage as indicated in fig. 3.

solid-state ssb exciter

The rf clipper is part of the solid-state ssb exciter shown in block form in fig. 4. This transceiver is based primarily on Plessey SL600 series integrated circuits, and can be detached from the main rig for portable use. When running 400 watts PEP output from the main rig, thorough shielding of the solid-state exciter, and filtering of all power-supply, microphone and audio-output leads is essential to

level. The monitor scope was also used in conjunction with the rf gain control, R3, to check the transmitter for linearity, an operation which is made easier by the relatively constant output level provided by the clipper.

It is not always convenient (or desirable) to place the rf gain control immediately after the second filter, and it is important to make sure that the intervening amplifier or mixer stage is linear. You might think that any non-linearity between the balanced modulator and clipper would simply leave the clipper with less work to do, but unfortunately, capacitors in bias and decoupling circuits have a habit of charging up so that stage

fig. 1. Half-lattice crystal filter using surplus FT243 crystals. L1-C1 and L2-C2 resonate at 5436 kHz. Crystals Y1 and Y3 are selected, as discussed in text.

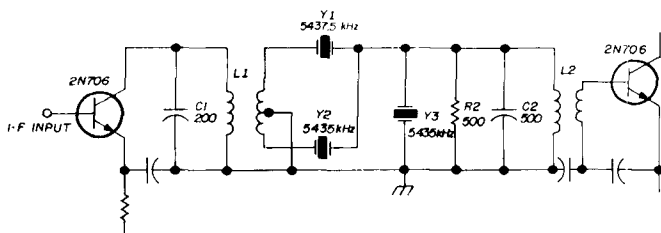

prevent rf feedback.

A calibrated gain control, R1, was included in the circuit for clipping level adjustments. This is quite straightforward since attenuation varies linearly with the voltage applied to pin 8 of the SL630 microphone amplifier, with zero attenuation at 0.8 volt, and 30-dB attenuation at 1.34 volts. The gain of the pre-amplifier was adjusted, through choice of components, to suit the sensitivity of the microphone. When completed, it was just possible to reach the maximum allowable input of 200 mV to the balanced modulator when speaking loudly.

Some pre-emphasis is provided by C1 and the 500-ohm input resistance of the SL201 speech preamp. The rf gain between the balanced modulator and clipper is preset by R2 so that normal voice peaks just reach limiting level with R1 set for 25 to 30 dB of attenuation.

A monitor scope on the output of the transmitter was used to observe limiting

gain varies with the peak or mean signal level. Therefore, it is advisable to check linearity and make sure there are no amplifier time constants exceeding about 1 millisecond.

performance

In use, this system provides a big increase in intelligibility when signals are weak or interference is bad. The operator's voice is always clearly recognizable by those familiar with it, and removal of all clipping produces an average drop of about two S-units. In general, other operators have no idea that speech clipping is in use, and are often quite surprised when they are told. However, the use of more than 20 dB of clipping tends to result in adverse reports.

surplus crystals

The carrier and unwanted sideband rejection of surplus crystal filters, although much inferior to commercial crystal filters, should be adequate for at

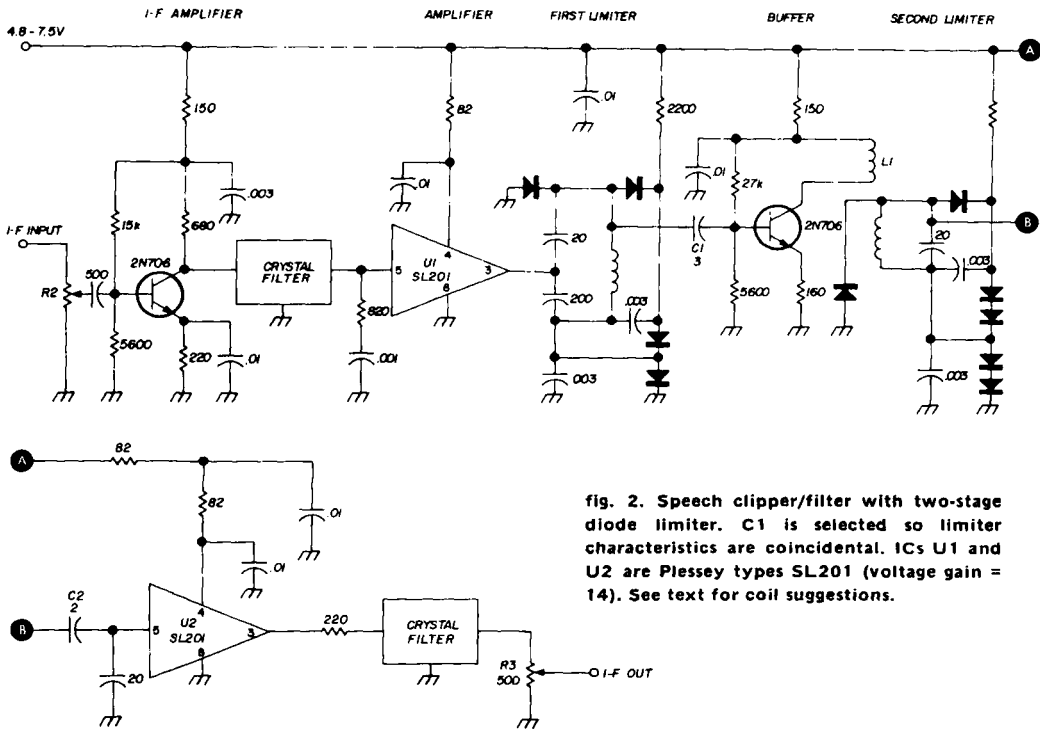

fig. 2. Speech clipper/filter with two-stage diode limiter. C1 is selected so limiter characteristics are coincidental. ICs U1 and U2 are Plessey types SL201 (voltage gain = 14). See text for coil suggestions.

least 12 dB of rf clipping. Surplus crystal filters are not normally suitable for receiving because of the high amplitude of spurious responses. However, the use of two filters for the rf speech-clipping system offered a key to the reception problem, with two separate filters. In the receiving filters the crystals were selected to stagger the spurious responses so that any unwanted frequency passing through one filter were blocked by the other.

alignment

The system shown in fig. 2 is easily checked for correct operation. A sensitive rf indicator such as that shown in fig. 4 is connected to the output of the balanced modulator. An audio tone is applied to the microphone input and the audio gain is increased until the rf signal output starts to limit. The audio gain is increased by about 20 dB (with R1) and the transmitter output is checked to make sure the output remains constant while the output of the balanced modulator

rises linearly.

Connect the rf indicator to the output of the second filter and increase the rf at this point by increasing the size of capacitor C2. The output of the final should increase proportionately, indi-

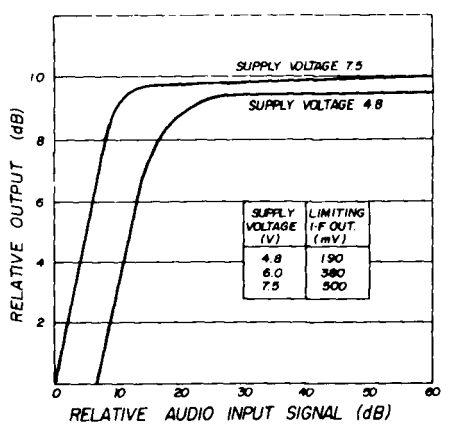

fig. 3. Limiter characteristics of the circuit of fig. 2. Curves represent extreme values of battery voltage for portable operation.

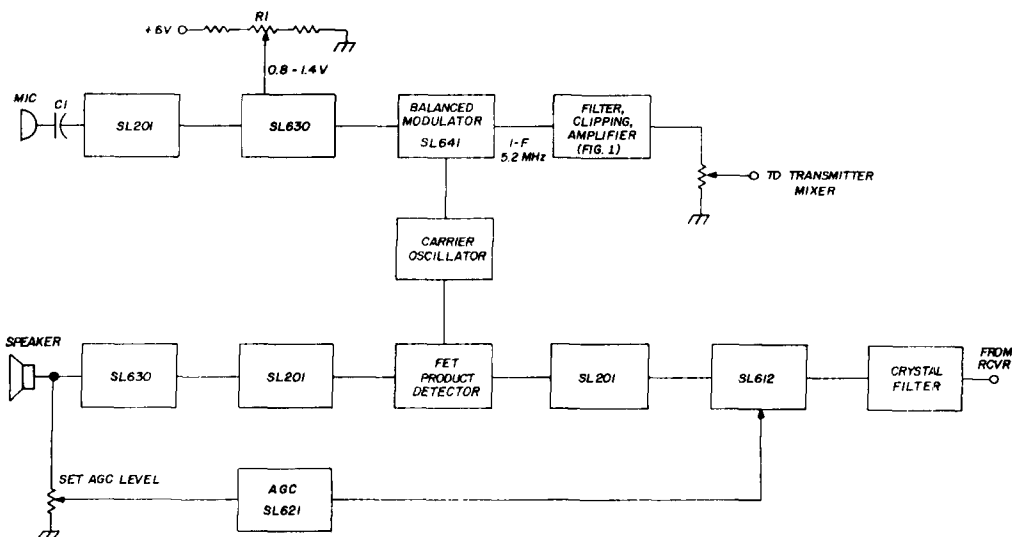

fig. 4. Solid-state ssb transceiver used by author is based on Plessey SL600 series ICs.

ating that there is no non-linearity occurring after the limiter. Alternately, if the rf gain control, R3, is not at maximum, the rf indicator may be placed after R3, and R3 varied instead of C2.

Remove modulation, place an rf short between the input and output of the second filter and check that carrier leakage remains at least 20 dB down, relative to the limiting level. Place an rf short across the input to the second filter and check that there is no rf output; repeat this test with a short across the input of the first filter.

conclusion

For the present, rf clipping is likely to appeal primarily to the serious experimenter who is looking for the ultimate in performance. There are no shortcuts to

good performance, and as I noted in last month's article, careful attention to a large number of small details is essential. However, even with simple designs, you can expect some increase in talk power.

In this context, of course, I am talking about the end product, and not the means of achieving it. The system of fig. 2 is not the only possible method. For example, by converting the clipped i-f signal back to audio, you have a device which can be plugged into the microphone lead (such as the Comdel speech processor).

Yet another approach is the modification of commercial gear along the lines used by K6JYO.² Each case presents a different problem, but some involve less difficulty than others. Although it is probably not always possible to follow all of the rules mentioned in my first article, particularly in regard to filters, the inclusion of as many points as possible is likely to prove worthwhile.

references

1. Leslie Moxon, G6XN, "Performance of RF Speech Clippers," *ham radio*, November, 1972, page 6.
2. Bruce Clarke, K6JYO, "RF Clipper for the S-Line," *ham radio*, August, 1971, page 18.

ham radio

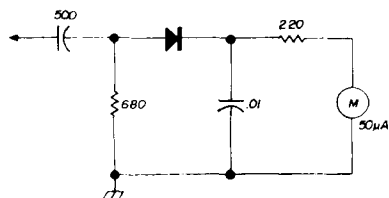

fig. 5. Sensitive rf probe for aligning rf speech clipper.

evaluation of simple dx antennas for 40 and 80 meters

DX is possible
on 40 and 80 meters
with a variety
of antennas
designed around
practical limitations

Malcolm P. Keown, W5RUB, 5816-113 SW Archer Road, Gainesville, Florida 32601

The introduction of awards by several organizations for recognition of multiple band DX capability have considerably diversified the antenna farm of the serious DX man. Working DX on 10, 15 and 20 meters is no problem using the popular three-band beam and an average station. Things get more difficult, though, as you move inland from the east or west coast. Due to the deterioration of signals as they are propagated over land at low frequencies, amateurs in the interior require antennas more elaborate than a dipole at 25 feet to compete with their colleagues in more advantageous geographical locations.

a proposed solution

A survey of available commercial low-frequency DX antennas revealed that most were an electrical compromise and were also expensive. There was also the problem of compatibility with the present tower-rotator-tribander configuration. I looked to see what could be homebrewed. The results were somewhat discouraging — I didn't have a tuner, a 100-foot tower, 20,000 feet of wire or a big lot. The only simple low-frequency antennas which were useful as DX antennas and could be considered constructionally feasible were the vertical, the horizontal wire beam and the sloped dipole. I developed the following test

plan: First, to construct simple wirebeam, ground-plane and sloped-dipole antennas for 40 meters, and to determine which antenna was the most effective for DX. Second, to extend the 40-meter ground plane to about 60 feet to act as quarter-wave radiator on 80 meters and to attempt to use the same antenna as something close to a 5/8-wave vertical on 40. Next, I wanted to determine how well the ground plane worked on 80 and if the 5/8-wave vertical is more effective on 40 than the quarter-wave ground plane. Last, I wanted to construct a sloped-dipole for 80 meters to compare with the ground plane for the same band. I did not try a wire-beam configuration on 80 because of its large size and generally unfavorable comments in the literature.¹

two element wire beam

The *ARRL Antenna Book* contains a simple two-element wire beam in the chapter on 14-, 21- and 28-MHz antennas.² Extending the concept to 40 meters was easy. The original design for the two-element folded dipole beam specified that the radiating elements should be constructed of number-12 wire, spaced 3 to 6 inches. Constructing something of this nature appeared to be a lot of work, so I used regular 300-ohm twin-lead instead. As an effective flat-top configuration required four poles of at least 60 feet, I tried an inverted-vee array using a boom for proper spacing.

The boom was assembled from an old tv mast and two sections of conduit. I installed pulleys on the boom so that the folded dipoles could be pulled out to the proper spacing from the tower. I attached the boom to the tower as follows: I mounted an eyebolt through the center of gravity of the boom and attached an 18 inch threaded rod to the tower at the 55-foot level. The rod was attached with U-bolts, with about 6 inches to the threaded rod extending from the tower. The eyebolt on the boom was then slipped over the threaded rod and secured with two bolts.

Stability of the boom was improved by installation of a wooden beam as shown in fig. 1. The length of the

wooden beam is dependent on the desired orientation of the boom. The ends of the boom drooped, of course, so I added two eyebolts five feet from either end. Cables attached to the eyebolts were connected to the tower at the 70-foot level. Axial tension was increased by turnbuckles. Once the folded dipoles were in place on the boom and the ends attached to trees, each leg of the dipoles made a 30° angle with the horizontal.

Electrically, the antenna consists of

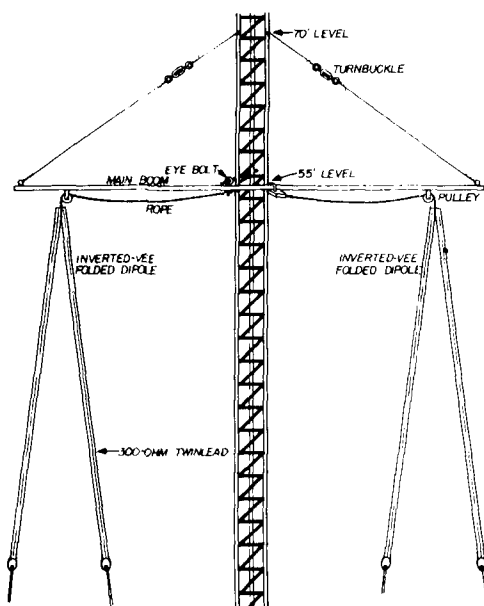
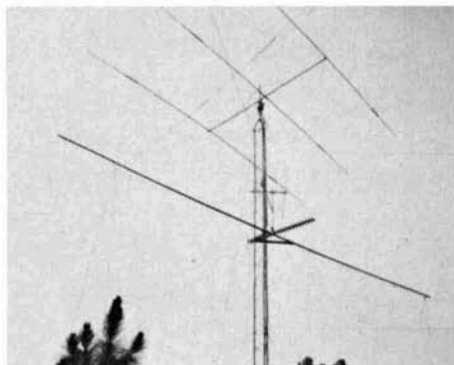

fig. 1. Wire beam for 40 meters uses two inverted-vee folded dipoles made from 300-ohm twinlead. Boom is attached to tower as shown in fig. 2.

two inverted-vee folded dipoles spaced a quarter-wave apart. The length of the feedline to the folded dipole which is the back element of the beam is a quarter-wave longer than the feedline going to the folded dipole which is the front element of the beam. The major radiation lobe is off of the front element. The feed impedance for the original flat-top configuration was 150 ohms. Since I didn't have any 150-ohm twin lead, and since I had no idea what the impedance would be for the modified array, I tried feeding

the antenna with 72-ohm twinlead. The swr was very high.

I tried 300-ohm twinlead and the swr was 1.5:1 at the resonant frequency. The dipoles were originally cut for 7150 kHz but the resonant frequency was about 6950 kHz. This was anticipated because inverted vees have lower resonant frequencies than dipoles for the same antenna length. Six inches removed from each end of each dipole moved the resonant frequency to 7050 kHz. The swr was 1.5:1 at 7050 kHz and 3:1 at 7300 kHz, which was acceptable. I speculated



Installation of the folded-dipole inverted-vee antenna at W5RUB. The two folded dipoles are suspended from a boom mounted on the side of the tower at the 55-foot level (see fig. 1).

that possibly the swr measured at the end of the 300-ohm transmission line and the feed point of the antenna were different, but an swr measurement at the feedpoint indicated that they were practically the same. A dpdt relay was installed at the feedpoint so I could reverse the direction of the major radiation lobe.

40 meter ground plane

Next, I built the ground plane. The antenna was made by topping off a 50-foot push-up tv mast with a 21-foot CB whip. The radiating element for 7 MHz is only 33 feet, but the additional height was necessary so the antenna could be used as an 80-meter ground plane in future tests. The mast was guyed only at the ten-foot level during the 7-MHz tests.

Unfortunately, the top section of the tv mast and the bottom section of the CB whip were the same diameter so they had to be joined with a section of one-inch inner diameter copper tubing.

Ground losses for vertical radiators can be significantly reduced by using artificial grounds like a ground plane. It is wise to erect an array of this nature as far above ground as possible. One common location for a ground-plane antenna is on the peak of the roof. Many people feel, however, that radials spread out on the roof detract from the house's appearance.

To avoid this problem the 40-meter quarter-wave radials were apprehensively installed on the ceiling of the attic. Not knowing the electromagnetic properties of my roof (asbestos shingles, tar paper and plywood), I anticipated assorted gremlins, but none have been observed. Ten 33-foot radials were attached to the ceiling of the attic spaced 30 to 40 degrees apart — some being bent to fit the available area of 30 x 70 feet. If an open area is available for erection of the ground plane, by all means use it, but if yard space or aesthetic arguments are a problem, the attic provides a good alternative.

Insulating the vertical radiator from the roof was another problem. After some experimentation, the best solution appeared to be a roof saddle with a U-flange and some method of insulating the U-flange from the vertical. The best solution was an ordinary automobile rear shock absorber with rubber inserts on the mounting eyes. Using the shock absorber, a quarter-inch bolt was inserted successively through one side of the U-flange, the lower rubber insert and the other side of the U-flange. A hole slightly larger than a quarter inch was then drilled in both sides of the bottom section of the 50-foot tv mast about six inches from the bottom end (see fig. 3). The bottom section was then slipped over the shock absorber and a bolt inserted through one of the previously drilled holes in the mast, through the upper rubber insert of the shock absorber and out the other side of the mast. Thus, once erected, the

vertical was insulated from the roof.

If your roof is guaranteed to be a good insulator this ritual is not necessary, and the vertical can simply be attached to the U-flange. A hole was drilled, under a shingle, through the roof and a number-ten wire was inserted to connect the vertical element with the transmission line. Plenty of plastic roof cement was applied to the modified part of the roof. The ground plane was fed with 52-ohm coax (which was also in the attic). No reflected power was observed at the calculated resonant frequency.

the sloped dipole

The sloped dipole configuration consisted of a simple folded dipole attached between one point 47 feet up the tower and another point 47 feet from the base of the tower. Hence, it made an angle of 45° with the horizontal with the major radiation lobe for the antenna in the direction of the slope.

performance comparison

The relative merits of antennas are usually evaluated in terms of field strengths at various angles and distances from the point source of the radiation. However, the major object of this exercise was to work DX with a minimum amount of blood-letting, hence, whichever antenna had the best punch was obviously the best antenna.

The sloped dipole and one major lobe of the beam were oriented towards Europe which is the major source of long-haul DX from Mississippi. Averaged reports received from Europe indicate that the sloped dipole and the ground plane are equally effective. The average report for the two antennas ran about one S-unit higher than the faithful inverted vee at 65 feet. The two-element wire beam generated average reports which were two S-units higher than the inverted vee and one S-unit higher than the sloped dipole or ground plane. Included angles of other than 45° might be tried with the sloped dipole. No optimum angle has been published for 40 meters as far as I know.

The sloped dipole is economical and easy to erect if a 50-foot support is available. This antenna provides some reduction of stateside interference and a worthwhile increase of signal strength on distant propagation paths as compared with an inverted vee or dipole at a comparable height. The ground plane requires very little erection area (if the radials are in the attic) and provides a tremendous reduction in stateside interference. This antenna is a good omnidirectional performer for the DX man who does not have much space or has no

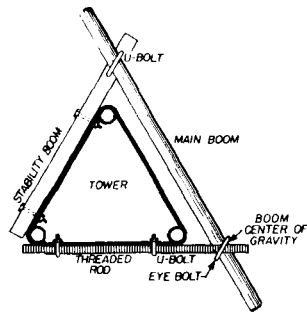

fig. 2. Boom for wire beam is attached to tower with an eyebolt and threaded rod. Short piece of wood is used for stability boom. See text for complete description.

means of raising an antenna to 50 or 60 feet.

The two-element wire beam takes up a lot of room and takes quite a bit of erection effort, but this is a good antenna to have in a pileup. Two of these antennas mounted perpendicularly to each other will provide excellent worldwide coverage on 40 meters. Rejection of signals off the side is good and fair off the back. Stateside interference, of course, increases off the front and this is sometimes a problem if the East Coast is between you and Europe. Many times I have worked Europeans who could only hear me on the wire beam, but I could hear them only on the ground plane.

On the other hand, the beam is a great contest antenna. I have often found as a stateside contest winds down on the

higher frequencies and you are forced to go to the lower frequencies in search of contacts, it is sometimes difficult to work the East Coast until a couple of hours after sunset. This is because much activity is concentrated in the 1-2-3-8 and upper 4 call areas and the signals are so strong within this area that signals from the outside are buried in the interference. The beam is a very effective aid for getting the attention of the East Coast community both in the hours near sunset and later in the evening.

dual-band antenna

As previously mentioned, the 40-meter

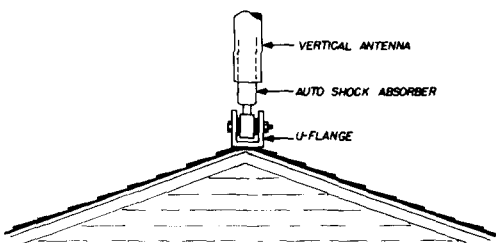

fig. 3. Vertical antenna is insulated from roof with an old automobile shock absorber with a rubber bushing.

ground plane was constructed so it could be converted to an 80-meter ground plane and something close to a 5/8-wave vertical for 40 simply by extending the push-up tv mast. The 5/8-wave on 40 is significant because at that length maximum low-angle radiation occurs.³ The vertical was raised to 60 feet and the antenna was guyed at 10 and 28 feet. The guys were attached to eyebolts in the roof some 15 feet from the base of the antenna. The eyebolts were anchored in the rafters and plastic roof cement applied around the eyebolt on the roof surface. The vertical was insulated from the guy wires by egg insulators which were placed in each guy wire about six inches from the vertical. Six feet of the fourth section and five feet of the fifth section of the tv mast and the 21-foot CB whip were left unguyed. The 32 feet of unguyed antenna have presented no sta-

bility problems and the antenna has sustained gusts to 70 mph without damage. The lower three sections of the tv mast were extended to the maximum attainable length which came to about 28 feet total, but the fourth and fifth sections were extended to only six and five feet respectively in order to keep down the number of guy wires.

A dpdt relay was installed at the base of the ground plane (in the attic) to switch between the 40- and 80-meter matching circuits. The 40-meter configuration required a simple L-network to match the 5/8-wave vertical to the 52-ohm coax.⁴ On 80 a small loading coil was necessary because the vertical was electrically short at 3.5 MHz.

Operation of the extended vertical on 40 indicated that no increased effectiveness was apparent as compared with the quarter-wave vertical. This conclusion was based on comparison with the 40-meter sloped dipole. Therefore, if you don't plan to use the vertical as a ground plane on 80, the extended vertical is not worth the effort.

ground system

Contrary to popular opinion, radials shorter than one-quarterwave can be effectively used in a ground plane antenna configuration provided the vertical radiator is at least 1/5 wavelength or longer. No problem was experienced in loading the 80-meter vertical against the 40-meter ground system using the L-network. I worked a lot of DX on 80 using this configuration. Some weeks later, fifteen quarter-wave radials were added to the system making it a true 80-meter ground plane. This made a total of fifteen 80-meter radials and ten 40-meter radials. Reports received from DX stations were somewhat better, but I am not sure whether the improvement was due to increasing the number of radials or adding longer radials. It is interesting to note in Lee's work³ that increasing the length of radials from 1/8 to 1/4 wavelength increases the unattenuated field for a vertical radiator at one mile by 5 millivolts per mile while doubling the number of

quarterwave radials from 15 to 30 provides a 12 millivolt per mile increase. Agreed, we are comparing apples and oranges, but it is conceivable that an amateur who is cramped for space may do nearly as well with thirty 1/8-wave-length radials as an amateur with fifteen quarterwave radials.

Quarterwave radials on 80 take up a lot of room. My attic, only 30 by 70 feet, necessitated placing the 80-meter radials on top of the roof. The 80-meter radial system was connected to the transmission line and the 40-meter ground system by an additional number ten wire through the roof. Fortunately, during DX season on 80 the nights are long and the days short; so if you are clever with the deployment of radials, evening guests will never be aware of the conglomeration of wire hanging above their heads. My gracious wife allows me to lay out my radials anytime after we go off of daylight savings time!

80-meter sloped dipole

Dalton recommends using a 100-foot tower to support a sloping dipole cut for 3650 kHz. This configuration yields an included angle of 52° between the antenna and ground, which he says is optimum for DX. Unfortunately, my tower is only 70 feet, and by using the same scheme, the included angle would decrease to 33° , obviously unacceptable. Practicality dictated a compromise. I decreased the included angle from 52° to 45° and raised the resonant frequency to 3800 kHz. The length of the antenna now was 123 feet. I stretched 100 feet of it from the ground to the top of the tower (at a 45 degree angle) and dangled the remaining 23 feet down the side of the tower (secured at the 47-foot level). This array worked fine at 3800 kHz but the swr was very high 100 kHz from the resonant frequency. It is well known that the bandwidth characteristics of a folded dipole can be improved by placing shorting straps at a distance from the center of the dipole which is equal to the velocity factor of the twin lead times half the length of the dipole.⁵ This worked out

to be about 7.6 feet from the ends of the antenna on 3800 kHz. Using this configuration, the swr was 2.5 to 1 at the low edge of the band.

80-meter antenna comparison

Reports received from Europe and Oceania indicated that the ground plane has an edge over the sloped dipole although I noticed no difference on the receiving end. The sloping dipole may be equal to, or more effective than, the ground plane if it were erected correctly utilizing the 100-foot tower.

recommendations

If supporting structures of 100 feet are not available, try the ground plane for an effective DX antenna. If a 100-foot structure is available, try a sloping dipole first, since the erection effort is small compared with the effort expended in putting up a ground-plane radiator with its associated radial system.

Possibly neither configuration is feasible; if this is the case, the modified sloping dipole is preferred over an inverted vee at 60 feet or less.

If 40- and 80-meter DX capability is required and only space for one antenna is available, the 80-meter ground plane/40-meter 5/8-wave vertical will deliver the DX even if there is no room for 80-meter radials. If no 80-meter radials are used, loading against earth ground may improve results. This can be accomplished by running a number 6 or 8 wire from the common junction of the 40-meter radial system and the shield of the transmission line to the nearest earth ground.

references

1. Peter J. Dalton, K2RBT, "Antennas for 80 meter DX," *QST*, January, 1970, page 33.
2. "The ARRL Antenna Book," 9th edition, page 213, American Radio Relay League, Newington, Connecticut.
3. Paul H. Lee, "Vertical Antennas, Part I," *CQ*, June, 1968, page 22.
4. "The Radio Amateur's Handbook," 45th edition (1968), page 340, American Radio Relay League, Newington, Connecticut.
5. William I. Orr, W6SA1, "The Radio Handbook," 17th edition, page 440, Editors and Engineers, New Augusta, Indiana.

ham radio

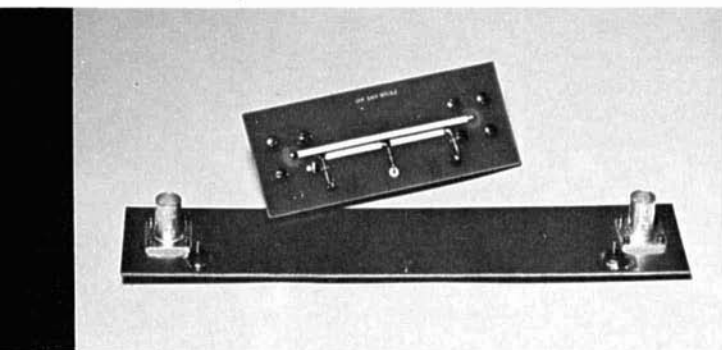

vhf and uhf micro-strip monimatch swr indicator

These two micro-strip
monimatch
swr indicators
cover the complete
frequency range
from 40 to 600 MHz

This article describes the application of the micro-strip transmission line technique to an old favorite, in-line swr indicator, the *monimatch*¹. Two models are described, a vhf model to cover the frequencies, 40 to 200 MHz, and a uhf model to cover the frequencies, 200 to 600 MHz. The original monimatch and

Arthur R. Hall, W4CGC, Fairfax, Virginia 22030

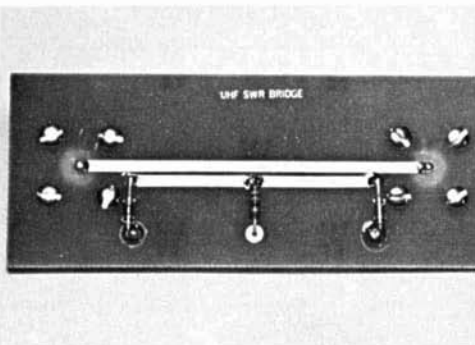

Construction details of the micro-strip uhf pickup line.

most of its decedents have been widely accepted down through the years as one of the easiest to build and most reliable of the in-line swr indicators.

As good as most of the monimatch designs are, they do have an upper frequency limit that prevents most of them from being reliable at vhf frequencies, and none seem to function reliably at uhf.

Actually, I tested the idea of adapting the micro-strip technique to the original monimatch design six years ago with a number of versions being built with good results. Since then, activity on the vhf and uhf bands has mushroomed tremendously, particularly on two-meter fm.

Most of the newer two-meter transceivers are all solid state and can be very unforgiving if they are used with an antenna that is not properly matched to the output circuit. The two micro-strip swr indicators described here will provide the means for reliably measuring swr and relative power in the region of 40 to 600 MHz.

theory of operation

Basically, a micro-strip transmission line is an unbalanced, constant impedance conductor analogous to a wire above a ground plane with a dielectric in between as depicted in fig. 1. The characteristic impedance is dependent upon the line width, the distance of the line above the ground plane and the dielectric constant of the printed circuit material. (G-10 material was chosen because of its low loss factor at these frequencies, its wide

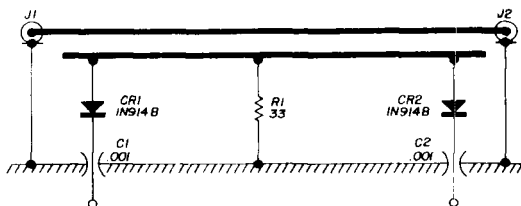

fig. 2. Circuit of the printed-circuit, micro-strip swr pickup line. C1 and C2 are Aerovox type 5601 discoidal feedthrough capacitors.

availability and its reasonable cost.)

A second line running parallel to the conductor line is center tapped to ground through a 33-ohm carbon resistor. High-frequency switching diodes rectify the induced rf voltage (on the pick-up line) which is then filtered by uhf feedthrough capacitors (see fig. 2). The pick-up line is coupled both inductively and capacitively to the main conductor line as shown in fig. 3. One half of the pick-up line samples the power flowing in the center line in one direction between one diode and the terminating resistance, the other half of the line senses the rf power flowing in the opposite direction between the other diode and the terminating resistance.

The upper frequency limit of these swr indicators is dependent not upon the microstrip center line, but upon the pick-up line. It appears that the inductance of the pick-up line from one end, to the terminating resistance and its distributed capacitance to the ground plane,

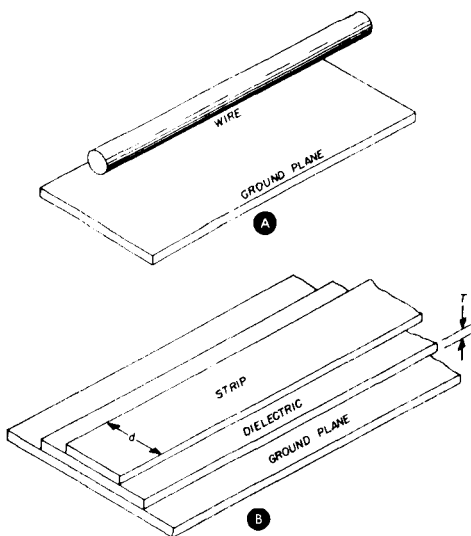
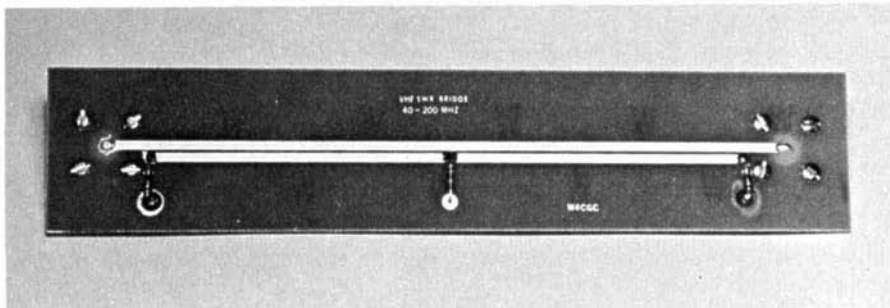

fig. 1. Cross section of the micro-strip transmission line system. Impedance is determined by the width of the strip, thickness of the dielectric and dielectric constant.

is the determining factor. One theory of limitation is that the pick-up line consists of multiple series inductances with multiple distributed capacitances to ground as illustrated in fig. 4A.

Another word of caution is in order at this point. Even though a micro-strip transmission line is designed very carefully to maintain a constant 50-ohm impedance, discontinuities may occur at



Closeup of the vhf circuit board shows the micro-strip pickup line, diodes and resistors.

Fig. 4A can be approximated as a simple pi network as in fig. 4B. Since a pi network is a low pass network, the cut-off frequency would then be a function of $L2$, $C1$ and $C2$. Laboratory measurements of these values correlate closely to the upper frequency limit of reliability of both the vhf and uhf swr indicators.

One important factor often overlooked in the design and fabrication of in-line swr indicators is that it *must* maintain a constant impedance, exactly the same as the characteristic impedance of the line it is measuring. If it does not, the in-line swr indicator can, itself, cause a mismatch even though it shows a perfect match between the generator and the load.

each end of the micro-strip line where it connects to the coaxial connectors. It is for this reason that I have chosen to mount the two coaxial connectors directly to the micro-strip line. This method of attachment will maintain a near constant 50-ohm impedance between the coaxial connector and the line.

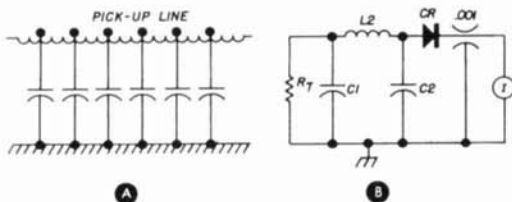

fig. 4. The distributed capacitance and inductance of the pickup line (A) limit the upper frequency limit of the swr indicator because they form the pi-network in (B).

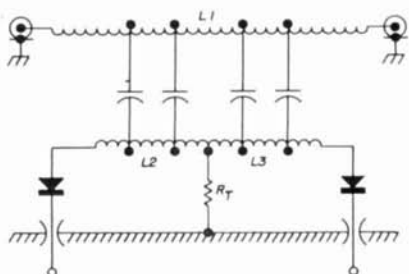

fig. 3. Upper operating frequency of swr pickup line is limited by the distributed capacitance and inductance of the line (see fig. 4).

Laboratory measurements of the inherent swr of the two micro-strips using a General Radio Model 900LB precision slotted line, is shown in fig. 5. The results are quite acceptable throughout the useful range of each indicator.

Another important factor in the design and fabrication of a reliable swr indicator is that it must be perfectly balanced between the center of both the conductor line and the pick-up line — one side must be a mirror image of the other. This is

most easily achieved using the micro-strip technique.

construction details

As was pointed out earlier, accuracy of line width, thickness of dielectric and

they are actually identical except for the line lengths.*

After the boards have been photo etched and trimmed to size they should be drilled using very sharp drills of proper size at high speed. The two holes that the

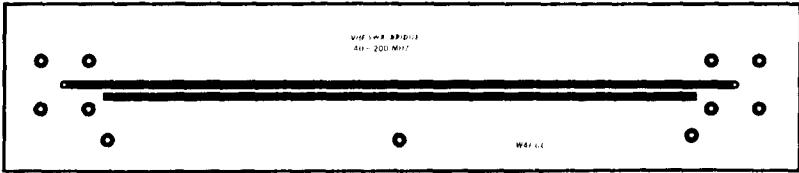

Half-size layout of the vhf printed-circuit board.

dielectric constant must be maintained to close tolerance for best results. Experiments show that when using G-10 epoxy-glass material of 1/16 inch thickness, a line width of $.094'' \pm .002''$ will provide the necessary 50-ohm characteristic impedance. The copper-clad should be no thicker than 1-ounce material to minimize undercutting during the etching process. Both the vhf and uhf indicators follow the same construction technique;

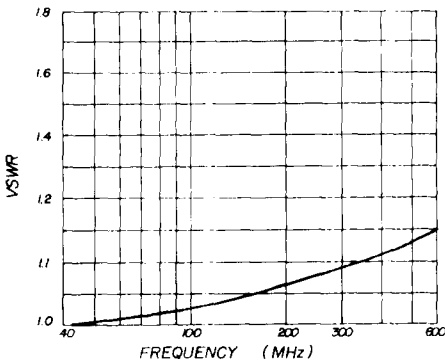

fig. 5. Insertion vswr of the two microstrip swr indicators.

*Completely cut and drilled G-10 epoxy glass boards and complete kits are available from TRI-COM, Inc., 12216 Parklawn Drive, Rockville, Maryland 20852. Either the vhf or the uhf board is \$7.00 and either complete kit is \$13.50. Both prices include air-mail first-class shipping charges. Maryland residents, please include the 4% sales tax. Rush orders can be placed by telephone to 301-770-5585.

center conductors of the connectors pass through should be beveled on the ground plane side so that a short does not occur. This beveling can be done with a counter-sink tool, or better still, a sheet metal 0.312-inch drill can be used with an appropriate pilot drill. The idea is to just go deep enough to remove the copper without cutting into the G-10 dielectric.

The two coaxial connectors are standard UG-290/U BNC units which have been modified for micro-strip use by being turned down on a lathe (see fig. 6). The face of the square flange should be faced off approximately $.010''$ to remove any imperfections that might exist in the connector. When facing off the flange, continue all the way through to the center conductor, removing the shoulder boss. Then cut off the center conductor so that $.080''$ remains. This will yield an rf connector that can be directly attached to the micro-strip printed-circuit board. Attach the modified UG-290/U connectors to the micro-strip board with $\frac{1}{4}''$ long, 3-48 machine screws.

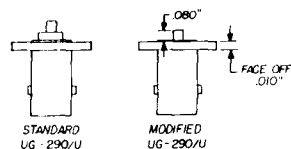
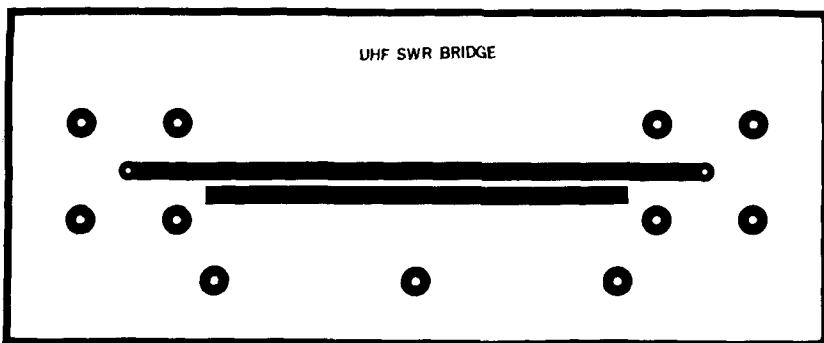

fig. 6. Modifying the UG-290/U BNC connector for use with the micro-strip line.

The next step is to sweat solder the two feedthrough capacitors in place. This operation should be done with a heavy duty soldering iron with a large tip. Make

testing and calibration

The swr indicators can be tested for accuracy by inserting each indicator between an appropriate transmitter of



Full-size layout of the uhf micro-strip swr bridge.

sure solder flows evenly all around the capacitor flange.

The soldering of the two center conductors of the modified UG290/U connectors should be done with the same heavy-duty iron. Use solder sparingly at these two points. This operation should be done quickly to reduce chances of peeling the foil from the board material. This is not a critical point but care should be exercised.

Lastly, install the two diodes and terminating resistor. No special care is needed here except to keep these components perpendicular to the pick-up line.

1-watt or more and a known 50-ohm *non-reactive* dummy load such as a Bird Terminal, etc. Most homebrew dummy loads, when used at vhf and uhf, will be reactive, thus producing a reflected reading on the indicators. In fact, these indicators should be accurate enough to indicate how good your dummy load is at these frequencies.

I have not made provision for enclosing the indicators in a mini-box, choosing to let the builder make his own decisions in this regard. The only word of caution here would be to keep at least a 1/2-inch clearance between the rear plane of the micro-strip and the enclosure. A suggested schematic including balancing resistors, forward-reflected switch, sensitivity potentiometer and meter is provided in fig. 7.

Acknowledgement goes to Mr. David W. Reynolds, W3QKR, for assisting with the circuit analysis, and to Mr. John Gregory, W3ATE, for his assistance in providing the photo-copy work.

references

1. "Monimatch," ARRL Handbook, 1958 edition, page 530.
2. "Micro-Strip - A New Transmission Technique in the Kilomegacycle Range," *Proceedings of the IRE*, December, 1952.

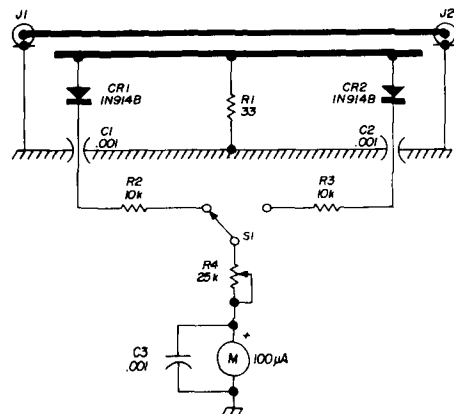

fig. 7. Complete circuit of the swr indicator, including the micro-strip pickup line and meter.

ham radio



monitor receiver for RTTY autostart

A stable receiver
for continuous
monitoring of
the RTTY
autostart nets

Bert Kelley, K4EEU, Tampa, Florida 33609

This receiver was built to monitor the fixed-frequency autostart RTTY nets on the 80-, 40- and 20-meter amateur bands. If one RTTY station wants to leave a message for another, he sends it at a time when the band is expected to be open between the two stations. All of the stations in the net usually leave their equipment on 24 hours a day, and everybody copies all the messages transmitted. Of course, the addressee of a specific message doesn't have to be in attendance to receive a message. When 14.075 MHz is open, copy is excellent and results in a nationwide intercom system linking RTTY enthusiasts. Other nets on other bands are used for shorter distances.

overview

The equipment required for this type of operation is not elaborate. Many stations use ST-4 or ST-6 autostart demodu-

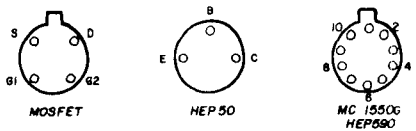
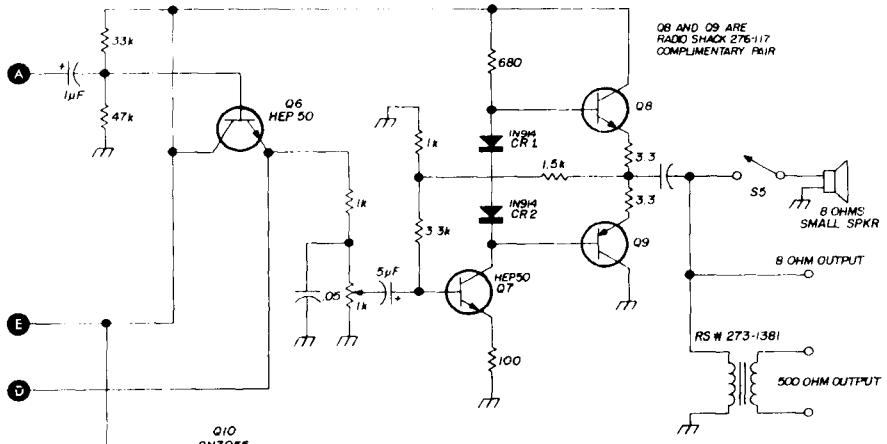
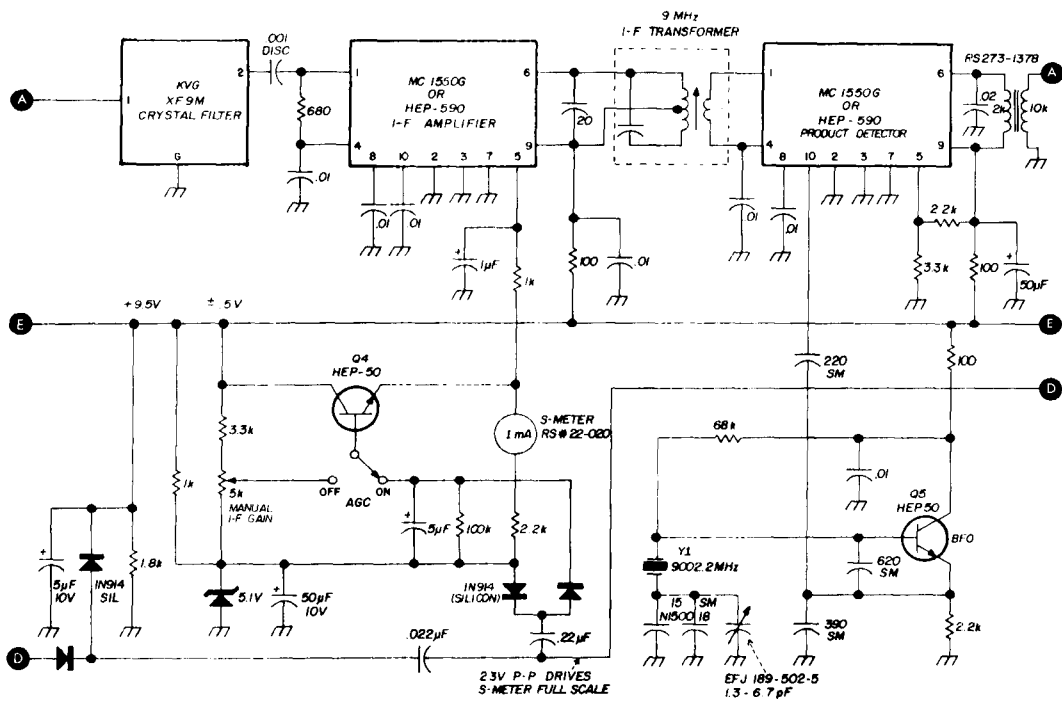

selected N750 temperature-compensating capacitors. I used an International Crystal HA type crystal in my unit.*

The oscillator is a modified Colpitts circuit, and the large silver-mica capacitors effectively disconnect the crystal from the transistor junctions. The more capacitance that is used here, the better (up to the point where oscillation ceases).

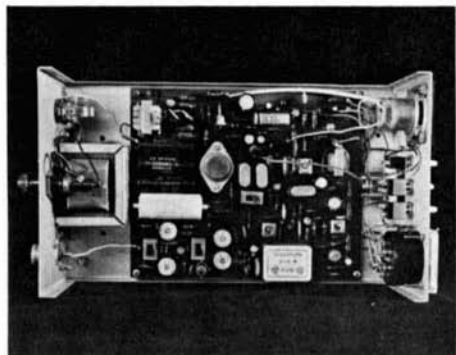

Inside of the receiver. Antenna input is at lower left, audio output is at upper left. Bfo crystal is at right center. The two crystals mounted adjacent to one another are for 80 and 20 meters.

As might be expected, the 9002.2-kHz bfo crystal is the most temperature-sensitive component. While temperature compensating various crystals, I found that the ordinary garden-variety HC-6/U crystals drifted about five times more than the International Crystal HA type recommended here.

devices

After constructing a few receiver front ends using transistors and integrated circuits, it was a pleasant surprise to find how well the mosfet performed.³ Forget the broadcast-band rejection filter and the attenuators in the antenna leads; mosfets provide plenty of gain without feedback. Toroid coils in the rf stage help, too.

The MC1550G IC is an inexpensive three-transistor array that works well as an agc controlled i-f amplifier and makes

a terrific product detector.† The HEP590 is a similar device.⁴

agc

The audio-derived automatic gain control for the mosfet front end and IC i-f requires two different voltage levels and polarities. The mosfet requires a small negative voltage for agc, but the MC1550G agc becomes effective only after voltage rises to 5.1 volts.

After the voltage gain provided by the 2k:10k transformer, and impedance matching in transistor Q6, the peak-to-peak voltage at the emitter measures about 2.3 volts maximum, and averages about 1 volt. This ac voltage is rectified and charges a 5- μ F capacitor, the ground end of which is connected to a 5.1-volt reference.

Another emitter follower, Q4, is used to give high-impedance input and low-impedance output. The emitter voltage follows the charge across the small capacitor and is used to drive the s-meter and provide agc to pin 5 of the i-f amplifier. Rf agc becomes effective after about two S-units.

audio

There is a variety of audio amplifier ICs available, but they are not recommended for this receiver because their high gain is not needed. Also, they usually will not stand sustained audio overloads. The transistor audio amplifier stages used in this receiver have the right amount of gain, are very rugged, and cost less than the IC. If 600-ohm output is not needed, no transformer is required.

construction

The 2N3055 used in the power supply is a rugged transistor often used in com-

*International Crystal Manufacturing Company, 10 North Lee, Oklahoma City, Oklahoma 73102. Write to them for their complete catalog with details on ordering high-accuracy crystals for your specific frequency and application.

†Both Hal Devices and Circuit Specialists stock them.

mercial equipment. You can find it surplus for less than \$2. I recommend that you build the power supply and check it out first. When building the receiver, work backwards from the audio stages, checking stages as you go.

The photos show the receiver built on a 6-7/8 by 5½-inch circuit board mounted on spacers and inside a 10 by 6 by

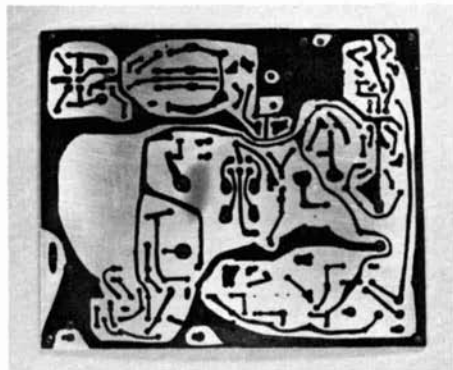

Printed-circuit board before etching. Antenna input is at top left, with mixer to right, and filter (large black area). Top to bottom on the right are the i-f, product detector and agc. Audio is at lower left.

3½-inch minibox. The board is laid out in a semicircle around the large electrolytic capacitors.

In these days of kits and commercial equipment, it takes a special breed of amateur to build his own receiver. If you are a builder, and if you need a really good monitoring receiver, build this one. You'll like it.

references

1. Irvin M. Hoff, W6FFC, "The Mainline ST-6 RTTY Demodulator," *ham radio*, January, 1971, page 6.
2. James R. Fisk, W1DTY, "Stable Transistor VFOs," *ham radio*, June, 1968, page 14.
3. John Knepler, "Cross-Modulation and Intermodulation in Receiver R. F. Amplifiers," *Electronics World*, March, 1970, page 55.
4. Motorola Application Note AN-247, Motorola Semiconductors, Phoenix, Arizona.

ham radio

INCREASE YOUR TALK POWER!

PROVEN ON-THE-AIR PERFORMANCE



MODEL ACA-1

\$49.95 KIT

ASSEMBLED
\$69.95

MODEL ACA-1 AUDIO COMPRESSOR features 45 DB compression range ■ Flat 20-20,000 Hz response ■ Extremely low distortion ■ Front panel compression meter and in/out switch ■ Accepts both high and low-impedance mikes ■ Easily installed in mike line ■ 110-volt a.c. or 12-volt d.c. operation ■ Only 5" W x 2¼" H x 4½" D.

MODEL ACP-1

\$24.95 KIT

ASSEMBLED
\$34.95



MODEL ACP-1 COMPRESSOR-PREAMP has 30 DB compression range ■ Flat 20-20,000 Hz response and low distortion ■ Designed for high-impedance mikes ■ Easily installed in mike line ■ 9-volt battery operation ■ Only 4" W x 2½" H x 3½" D.

IDEAL FOR TAPE RECORDERS!

Try one of these compressors as an automatic recording-level control. Used by recording studios, schools, and radio-tv stations. Great for p.a. systems, too!

3-CHANNEL WWV RECEIVER

(5, 10, and 15 MHz)



\$74.95 KIT

ASSEMBLED
\$99.95

0.25 microvolt sensitivity ■ Crystal controlled ■ 110-volt a.c. or 12-volt d.c. operation ■ Compact size only 4½" W x 2½" H x 5½" D.

Send check or money order, plus \$1.50 for shipping anywhere in U.S.A. California residents add 5% sales tax.

DEALER INQUIRIES INVITED



CARINGELLA ELECTRONICS, INC.

P.O. Box 327 □ Upland, California 91786
Phone 714-985-1540

building Motran and Motrac channel elements

Building simple
plug-in crystal board
replacements for
the hard-to-find
Motran and Motrac
channel elements

Thomas McLaughlin, WB4NEX, St. Petersburg, Florida 33704

Finding channel elements for Motorola's popular Motrac and Motran fm transceivers can often be a problem. Getting crystals for these rigs is relatively easy, but channel elements are both scarce and expensive. You can get around the problem, however, by building your own receiver and transmit elements.

It is fairly easy to make an oscillator unit on a perf board and press it into service as a channel element by connecting it to the proper pins on the radio circuit board. The general circuit of a receiver element, fig. 2, consists of a crystal oscillator and resistor-diode com-

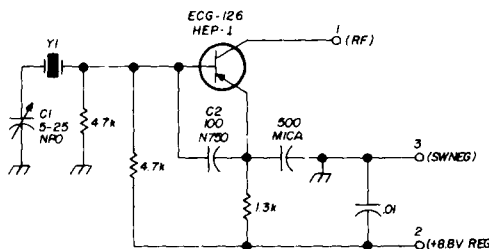

fig. 1. Simple receiver oscillator circuit. Precision grade crystals help to eliminate the need for the temperature-compensating components in fig. 1.

compensating network to correct for the effects of temperature change on the crystal. The circuitry for the transmitter element is the same except for the changes in the collector circuit as noted later. If you need a receiver element, build the circuit in **fig. 1** and order a *precision grade* crystal.

crystals

I have made several elements and ordered crystals from Sentry cut for circuit number 5 in their catalog. Each has tuned to frequency without prob-

home-brew oscillator which won't tune on frequency, pad C1 with a 10-pF 10% NPO ceramic disc. This will work if the frequency is too high. If the crystal is too low in frequency or if no amount of padding helps, change C2 from 100-pF N750 to 75-pF N750 disc ceramic. This decreases the circuit capacitance enough to raise the frequency a little. Note that the new style single oscillator elements have holes in the circuit board so you can pad C1 if necessary. The older dual oscillator elements don't have this provision, but C1 is a 5 to 25 pF NPO unit so

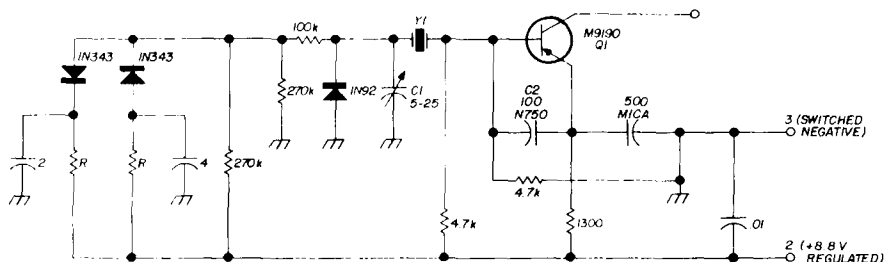

fig. 2. Basic receiver channel element circuit. The text explains about the resistors marked R.

lems. I found that a precision grade crystal will eliminate most drift problems even though the homebrew element does not have the compensating network. You will certainly stay within 0.001%, which is close enough for amateur work. This is exactly the same as buying a used element and installing the crystal in it yourself without adjusting the precision 1% resistors in the compensating network (**fig. 1**, labeled R) to eliminate oscillator drift with temperature change. These resistors may be anywhere from 9k to 15k depending on the particular characteristics of the crystal involved, and it really isn't worth the time it would take to find the correct values unless you have access to some expensive test equipment. If you need a transmitter element, build the circuit in **fig. 3**. This is exactly the same as **fig. 2** except the collector of Q1 is grounded to pin 3 and the rf is taken directly from the emitter. **Fig. 4** is a guide to finding the proper pins.

If you have a used element or

it shouldn't need padding. The new elements have a 3.5 to 14 pF N300 unit for C1 which accounts for the padding provision. Other than this slight difference, the circuitry for both the old and new types is the same.

If you have regular elements and are ordering crystals, it is best to get precision grade crystals cut for the particular model of element you are using. **Table 1** gives the proper designation for many elements. If you are ordering crystals for home-built elements, I would advise specifying them to be cut for element model

table 1. Motorola channel element designation.

New style single-frequency element

	0.0005%	0.0002%
transmitter	TLN 1083	TLN 1087
receiver	TLN 1081	TLN 1086

Old style two-frequency element (all are 0.0005%)

	single freq	dual freq
transmitter	TLN 1024	TLN 1025
receiver	TLN 1020	TLN 1021

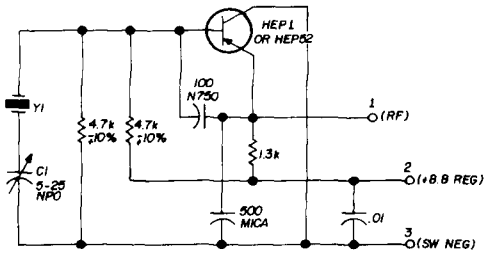

fig. 3. Transmitter oscillator circuit.

TLN1081, or if you buy from Sentry, specify circuit 5 in their catalog. The crystals should tune without any problems in the homebrew circuits.

The ersatz elements I made are all on perf boards, and I mounted them in the rigs using the pins from an old octal socket — they just fit on the male pins on the radio circuit board. If you're desperate or just don't care, you can even solder the element right into the radio.

transistors

The transistors in the standard elements are Motorola type M9190, a house number only. Since this is a PNP rf type, HEP-1 works well, but it is no longer being produced and is not available at all distributors. HEP-52 works well in transmitter elements, but the output is a little too low for use in a receiver element whose output is run right into a tripler stage, unlike the transmitter exciter. Sylvania ECG-126 is also a good bet for either receive or transmit elements because these are fairly high-output devices.

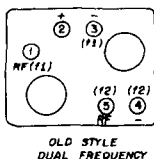
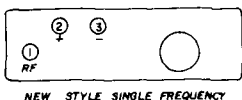

fig. 4. Bottom view of old and new Motorola channel elements shows pin designations.

There are countless other types which will work; even some audio types will have high enough output to be used.

If you have one of the older two-frequency elements which has only one oscillator board in the can, it can easily be converted into a functioning two-frequency element if you have a 5 to 25 pF NPO trimmer and oscillator board out of an unused element. Likewise, any receiver element can be changed to a transmitter element and vice versa. This only requires connecting the wire from the rf terminal to the proper transistor lead on the board and either grounding or ungrounding the collector as the situation dictates (see fig.

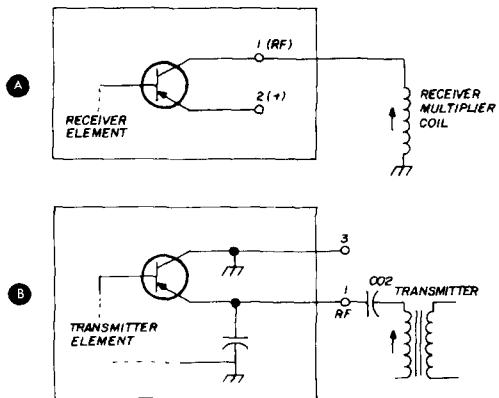

fig. 5. Difference in the hookup arrangements for a receiver element (A) and a transmitter element (B).

5.). If you haven't noticed, receiver and transmitter elements are not interchangeable.

birdies

Another characteristic of Motracs and Motrans is that the i-f crystal is usually 8.455 MHz, Motorola part G09. If the receiver is set up to receive on 146.94 MHz an intermod type birdie will appear in the receiver. This condition can easily be eliminated by changing the i-f crystal to 7.545 MHz, Motorola part G11, available either from Motorola, Sentry or International.

ham radio

HOLIDAY SPECIAL

SAVINGS UP TO 50%

ham radio magazine

What better gift for
your amateur friends
than a subscription to
HAM RADIO

• • •

With our special Holiday Gift Plan the more you buy the greater your savings.

You save at least \$1.00 on any subscription, but you can save as much as \$3.50.

Here is an opportunity to whittle your gift list down in a hurry and save a lot of money doing it.



ONE YEAR SUBSCRIPTIONS

Anywhere in the world

First Subscription	\$6.00	Save \$1.00
Second Subscription	\$5.50	Save \$1.50
Third Subscription	\$5.00	Save \$2.00
Fourth Subscription	\$4.50	Save \$2.50
Fifth Subscription	\$4.00	Save \$3.00

Additional Subscriptions \$3.50 each.

Order Today - Include your own subscription or renewal while you are at it.

Offer expires December 24, 1972

• • •

HAM RADIO MAGAZINE
GREENVILLE, NEW HAMPSHIRE 03048



AMECO Code Courses

Improve your code

Carefully prepared 12" 33 1/3 rpm records prepares the user for FCC code exams. Each record includes a code course booklet to assist your progress.

JUNIOR CODE COURSE

Preparation for the Novice and Technician code examinations from start to 8 WPM.

— \$3.95

SENIOR CODE COURSE

Everything given in the Junior Code Course, plus additional lessons to bring code speed up to 18 WPM.

2 records — \$7.50

ADVANCED CODE COURSE

It contains the last twelve lessons of the Senior Code Course, as well as the FCC-type code examinations. Speed from 8 1/2 WPM to 18 WPM.

— \$3.95

EXTRA CLASS CODE COURSE

Code speed is from 13 WPM to 22 WPM. Sample FCC-type code examinations are included.

— \$3.95

GENERAL CLASS

SUPPLEMENTARY CODE COURSE

Additional material from 12 to 15 WPM for general class exam.

— \$3.95

EXTRA CLASS

SUPPLEMENTARY CODE COURSE

Additional material from 19 to 24 WPM for extra class exam.

— \$3.95

All prices ppd. U.S.A.

comtec
BOOKS

Greenville, New Hampshire 03048

monitoring oscillator

The step-by-step
evolution
and modernization
of a very handy
station accessory

However sophisticated some of our modern transceivers may be, sometimes they can benefit from some old tricks. The monitoring oscillator, for instance, has been around for decades but it still can serve very useful functions. I feel the modernization of this handy gadget might be of interest to old-timers who used one in the 1930's, to newcomers who probably never heard of the critter and to experimenters who might enjoy sharing my adventures in adapting modern components to an old circuit.

When you operate your transceiver on CW, you have a so-called side-tone oscillator to monitor your sending. However, you can't monitor your signal as it sounds to the distant station unless you have an additional receiver. If something goes awry while you're on the air — your final takes off, your frequency shifts suddenly or the note goes sour — you will never know about the trouble until the operator at the other end of the circuit tells you that something has happened. Further, the regulations specify that the frequency of the station must be measured by external means other than the station receiver. When you speak of frequency measurements, you mean the operating frequency, of course, and the *quality* of the emitted signal — since its frequency will be shifted if ripple appears in the output or if the stage takes off due to amplifier instability or loss of excitation.

R. W. Gunderson, W2J10, 980 Waring Avenue, Bronx, New York 10469

The side-tone oscillator operates at just one frequency (usually about 1 kHz). I like to shift the frequency of the monitoring oscillator as I operate to break the monotony. Of course, this is impossible with the built-in side-tone generator. Rf-actuated monitors which derive their dc power from the radiated energy from the transmitting antenna are satisfactory. However, they do not check the quality of the emitted signal as it sounds to the distant operator.

the monitoring oscillator

In the days when amateur transmitters employed self-excited oscillators to generate the carrier frequency, a monitoring oscillator was an invaluable tuning and operating aid. The monitor is a simple oscillating detector enclosed in a shielded container. The shielding guarantees that the signals picked up on this receiver from the output of your transmitter will be weak, and will not overload the monitor. The typical instrument is made with a minimum of components and is fitted with plug-in coils to make band changing easy. My original pre-war monitor was made in a metal lunch box and it operated from 160 through 20 meters by means of four properly wound plug-in coils. The other day I dug it out of the junk box and modified it by replacing the 1G4 triode oscillating detector tube with a 3N139 field effect transistor. I've been using it ever since, and it does such a good job that I thought the monitor and its applications might make interesting reading for other amateurs, newcomer and old-timer alike.

The circuit for the original monitor as it was constructed here at W2JIO is shown in fig. 1. S1 was part of the "filament lighting" type phone jack. You will note that the earphones are in the negative (ground) lead of the detector. This is done to keep hand capacity effects to a minimum, improving the frequency stability. Pickup from the phone cord is also minimized, and the unit really performs as a weak-signal receiver.

The unit is used to set the amateur transmitter within an amateur band in the following manner: Set the station receiver inside the amateur band. This may be checked by means of the receiver's dial calibration and by listening to other stations in the particular band of frequencies. Tune the monitor to zero beat with the receiver frequency by turning on the receiver bfo and then setting the monitor to zero beat with the receiver. Disable the receiver by placing it in the stand-by position and listen to the monitoring oscillator. Then tune your transmitter to give zero beat with the signal in the oscillating monitor. The transmitter frequency is now set close to the original frequency tuned in on your station receiver.

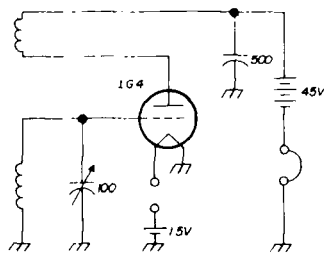

fig. 1. The original monitoring oscillator used a 1G4 triode and plug-in coils to cover 160 through 20 meters. The unit was turned on by a filament lighting type headphone jack (not shown here for clarity).

In the case of a radio-telephone transmitter operating on a-m, the quality of the carrier may be checked by listening to a beat note produced between the monitor and the carrier frequency, and then modulating the transmitter. If the pitch of the signal varies during modulation, there is frequency modulation of the a-m carrier rather than just amplitude modulation. In the case of your CW transmitter, tune the monitor to give a beat note with the transmitted signal and monitor the keying characteristics just as you might monitor them in a modern receiver. The overload characteristics of the monitor

are relatively good because the entire monitor circuitry is shielded, and the character of the signal may be judged just as it appears to the distant receiving station.

When most amateurs used regenerative receivers, the monitor was a must in the operation of a station. Today, however, the stability of the average communications receiver is good enough so that the transmitter may be set directly to the operating frequency. In the case of transceivers, there is no problem because the transmitter is automatically set to the receiver's frequency.

board to accommodate the leads for the fet, and wired it in place of the tube, just as in the original circuit. The transistor oscillated right off the bat, and I could hear the beat note from my transmitter — the job was finished — or was it?

When I pulled the coil out of the socket to try the monitor on 20 meters, I found that the transistor had gone bad. I had read that you have to be careful with these insulated gate fets, and I hadn't been careful. That gate must remain at ground potential or random charges will simply burn out the microscopically thin insulation. I simply connected a one-meg-

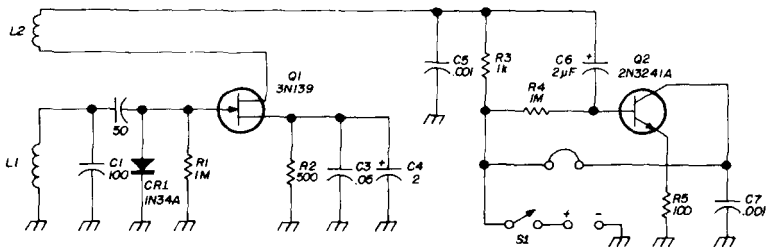

fig. 2. The modernized monitoring oscillator. Coil-winding data on the L1-L2 plug-in coils is given in table 1.

modernization

The final, updated schematic of the monitoring oscillator is shown in fig. 2. The steps to get to this point, however, were many. When I dug the old monitor out of the junk pile, I decided that the gadget would have to be transistorized. The tube filament was 1.4 volts at 50 mA, and the B supply was a 45 volt battery. Both batteries were expensive, and if I was to use the monitor as much as I expected, batteries would become costly. My first thought was simply to replace the 1G4 triode with a field effect transistor, a type 3N139 which I happened to have on hand.

I removed the tube socket and set a small piece of perforated board in its place — held with the same machine screws and nuts which held the original socket. I set four eyelet type terminals in a square through the perforations in the

ohm resistor from gate to ground, and found that I could change the coil without fear of destroying the fet.

I tried the circuit with my surplus HS33 headphones, which have an impedance of 500 ohms, and decided that perhaps high-Z phones would give me slightly more audio to make monitoring easier. However, upon plugging the 2,000-ohm phones into the unit, I found that the transistor didn't oscillate. In fact, the total current from the battery had fallen to practically zero. Somewhere back in the distant past, I had read that a source resistance would tend to make the transistors less critical as to the load, and that transistors of the same type could be plugged into the socket and the circuit performance would be more uniform. A 500-ohm resistance shunted by the usual 0.05-mF disc ceramic capacitor from source to ground did the trick. I could now use the circuit with both headsets,

and the output was even higher with the source resistor in the circuit.

audio stage

With a supply of 9 volts, I found that the output in the headphones wasn't quite what it was with the tube operating from the 45-volt B battery. Therefore, I decided that a single grounded-emitter stage as an audio amplifier following the oscillating monitor would be a worthwhile addition. This makes a very handy monitor — one which can now be used to check for harmonics as was the older circuit back in the 30's. The original

table 1. Coil-winding data for the updated monitoring oscillator. All coils are wound on standard 1¼-inch, four prong forms. Each coil has an approximate frequency ratio of three to one. Approximate frequency coverage is then: 160 meters from 1.75 to 5.10 MHz, 80 meters from 3.4 to 10.5 MHz, 40 meters from 7.0 to 21.5 MHz and 20 meters from 12 to 30 MHz.

160 meters	L1, 50 t. no. 28 enameled wire closewound; L2, 6 t. no. 28 enameled wire.
80 meters	L1, 34 t. no. 24 enameled wire, closewound; L2, 4 t. no. 24 enameled wire.
40 meters	L1, 16 t. no. 24 enameled, space wound to diameter of wire. L2, 3 t. no. 24 enameled wire.
20 meters	L1, 6 t. no. 24 enameled space wound at about twice the wire diameter. L2, 2 t. no. 24 enameled wire.

In all cases, L2 is closewound at the cold end of L1, in the same direction as L1.

phone jack with the additional filament switching leaves is still used, although it was necessary to insulate it from the chassis because the jack is now in the hot side of the circuit. As these jacks are scarce, you might prefer using a plain jack and simple SPST switch. This switch and the old bakelite vernier tuning dial are the only panel controls.

I found that the circuit starts more readily at the higher frequencies if the tank circuit is isolated from the gate of

the fet by means of a small coupling capacitor of about 50 to 100 pF. The current drain of the oscillator is about 5 mA with the circuit oscillating, and this current falls to about 2.5 mA when the circuit falls out of oscillation (as produced by placing your hand on the tuning capacitor stator). This effect is just the opposite of that occurring in a vacuum tube oscillator and I decided to look into it before completing the design of the instrument.

As the gate is completely insulated from the rest of the field effect transistor, there can be absolutely no rectified dc flowing from the gate to the source through the gate leak resistor, R1. Therefore, there will be no dc voltage developed across this resistor to provide additional operating bias during oscillation of the circuitry. I decided to furnish the necessary bias by connecting a 1N34A small-signal germanium diode with its anode to the gate and its cathode grounded.

With a supply of 9 volts applied to the oscillator drain, the negative voltage is now about minus 3 volts from gate to ground. The drain current now decreases when the circuit oscillates, just as it does with the vacuum tube oscillator, and the audio output from the monitor has increased markedly with the introduction of the diode. It is quite possible that a higher value of source resistance from the fet source to ground would enhance the weak-signal performance of the instrument. However, it is quite satisfactory with the values shown in the circuit.

The monitor performs very well all the way from 160 to 10 meters, by inserting the proper plug-in-coil. It will oscillate at frequencies higher than 30 megacycles, although the oscillator stability is rather poor at these higher frequencies. This instability is produced by the poor mechanical arrangement of components and the relatively large amount of slip in the old bakelite vernier dial. However, it is reasonably satisfactory — good enough for monitoring my CW.

ham radio

helically wound mobile antenna

Improved performance
over a manufactured
whip is claimed for
this antenna design

This article describes a helically wound whip antenna for mobile operation. The final design evolved over a period of about five years. An antenna was desired that performed better than those available on the market; tests have indicated that this objective has been achieved.*

The antenna has flat response at resonance and frequencies above resonance, with pronounced fall-off at frequencies below the design frequency.

Design data and construction details are given to enable you to duplicate the antenna, either as a single-band design (1-150 MHz) or as a 4-band amateur antenna covering 10-80 meters.

Construction procedures, dimensions, and winding instructions must be followed explicitly, otherwise the antenna may not perform as claimed. After you've built the antenna from the instructions provided here, *then* try your own variations. But it's important to "stick to the script" to start with.

*A copy of the test report is available from *ham radio* for \$1.00 and a self-addressed stamped envelope. **editor.**

During the 1964/65 period, I conceived an idea to build a single-band helically wound whip into a two-band antenna while also trying to improve the coupling to space by the production of a near-sinusoidal current and voltage distribution over a short antenna. The results have been very satisfactory.

Having made many single-band helically wound whips, I noticed that a second resonance was apparent around 18-19 MHz on most antennas, using rod about 3/8 inch in diameter for the dielectric. While developing the technique to wind single-band whips for frequencies from 3.5 to over 100 MHz, trends were noted, and an antenna for the 40- and 20-meter bands was attempted. My first attempt, which was pure luck, was a helically wound antenna similar to the present multiband antenna. After rewinding and making adjustments, the first design was born. It worked on 40 and 20 meters, so I tried it on 10. It loaded and worked, but as this was done during the quiet period of 10 meters, only local results were obtained. Finally the antenna was tried on 15. It worked on that band also. Subsequent results have been most satisfactory. Tests on 20 showed 3 dB gain over a Hustler at a distance of 14,500 miles.

The form factor was a compromise, producing a near-sinusoidal distribution of voltage and current similar to that of a 1/4-wave antenna.

single-band design

Experimentation has resulted in a formula for determining the approximate

H. L. Booth, ZE6JP, Salisbury, Rhodesia

length of wire for a helically wound antenna for one frequency. The formula is at best an approximation as shape, dielectric rod length, and wire gage affect the formula. To find the approximate length of wire for a helically wound whip for one frequency, use

$$L = \frac{840}{F}$$

where

L = wire length (ft)

F = frequency (MHz)

This formula will result in a little more wire than required providing the top third of the antenna length is close-wound. If less than one-third is close-wound, more wire will be required; conversely, if more than a third is close-wound less wire will be required.

The dielectric rod must be of constant diameter. Tapered rods will result in a different configuration than that specified, which may affect performance.

The rod length represents a quarter wavelength or 90 electrical degrees. Divide the rod length into nine sections, each of which represents 10 electrical degrees. To find the percentage of turns required at each 10-degree segment, use the data in fig. 1.

wire gage and length

Consider now one-third of the rod length. From fig. 1 note that 71 percent of the total turns, or wire length, (using a constant-diameter rod) must occupy that space. From geometry the rod circumference is πD . Therefore, dividing 71 percent of the wire length by the rod circumference will give the approximate number of turns to be closewound. From the wire

table in the Handbook, find a suitable gage of enamelled wire. The wire diameter should not be less than 0.028 inch.* If the wire table gives a size smaller than 0.028 inch, use a larger-diameter rod and recalculate.



Helically wound mobile whip for 10-80 meters used by ZE6JP.

Using the formula above, a 3/16-inch-diameter rod, 18 inches long, was used to build an antenna for 10 meters. The antenna was mounted on the car and tuned. An input of 22 watts was used. Good reports were received across town, but after one minute of operation the antenna was too hot to touch because the wire gage was too small.

winding procedure

Mark off the rod into 9 sections. It will be easy to determine the number of turns in each section as the rod circumference is known; also the total length of wire. Divide the circumference into the length to obtain the total number of turns. Divide each section into inches. Note that a change of turns per inch

*The ARRL Handbook shows this wire diameter as No. 21 B&S gage. The current-carrying capacity of No. 21 B&S gage, at 1500 circular mils/ampere, is 0.54 amp. editor.

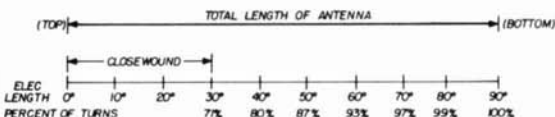

fig. 1. Diagram showing percentage of wire turns as a function of antenna length in electrical degrees. Approximately 70 percent of the total number of turns must be close-wound over the top one-third of the antenna.

exists, section-to-section. Mark each number of turns in each progressive inch to accommodate the change of turns per inch. The winding then will have a constant change in pitch, and no sudden change of pitch will be obvious. Indelibly

impedance feed conditions at resonance are not normally harmonically related; however, this antenna does have this property. The resonances occur in the ham bands, and the feed impedance allows the antenna to be loaded by the

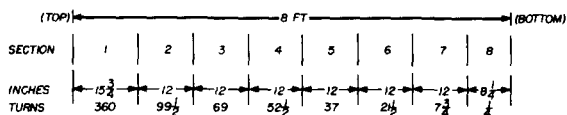

fig. 2. Winding details for a 4-band amateur antenna. No. 18 AWG enamelled wire is recommended.

mark the position of each turn. Anchor one end of the wire, then secure the other end to the "loose-wound" end of the fiberglass rod and wind on. After completing the winding lock the top end with tape, then adjust the turns to smooth out any unevenness in the winding. Secure the entire winding with epoxy.

Mount the antenna in its operational position. Make certain the car has an open space of at least 20 feet around it. Use a two-turn loop to ground the bottom end of the antenna. Couple a gdo to the two-turn loop. Check the gdo frequency with an accurately calibrated receiver. The frequency should initially be lower than that required. Remove turns from the close-wound (top) end, turn-by-turn, until the gdo dips at the low end of the band. The antenna will load over the band by adjusting the transmitter tank circuit.

multiband design

This is an extension of the single-band design, but by its size and shape it will operate satisfactorily on the 40-10 meter bands. The multiband version behaves like an hf choke. As frequency is increased, resonances occur at different frequencies. These resonances are governed by the antenna shape, wire inductance, and distributed capacity. The low-

conventional mobile pi-section tank circuit. By adding approximately 60 μH in series with the antenna base most of the 80-meter band may be covered. Similarly, the antenna will tune 160 meters with suitable inductance added at the base.

From band-to-band, the feed-point impedance at resonance varies but is generally between 15-50 ohms. No difficulty has been experienced when feeding with RG8/U about 15 feet long. Forget swr so

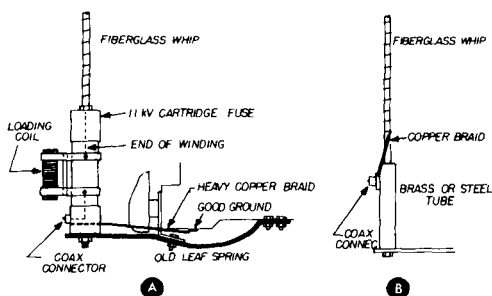

fig. 3. Suggested mounting arrangements. A shows author's mount, which includes loading inductance. A simplified version is shown in B.

long as the antenna can be loaded — improving swr adds very little to the radiation. In general, the usual pi section is adequate, unless in certain manufactured transceivers the 50-ohm termination is restricted.

The rod is of fiberglass with a diameter of $\frac{3}{4}$ inch, from 8 to 8 ft. 3 in. long. Lay the rod on a bench or table. Mark off the turn positions along the rod (fig. 2). Scratch the marks so they won't rub off when winding. Mark off from the top end as in fig. 2. Wind as previously instructed and terminate in the same way. Use only 0.040-inch enamelled wire (18 AWG). A suggested antenna mounting is given in fig. 3.

tuning

All previous instructions apply except as follows. Remove turns from the top of the antenna until it resonates in the low end of the 40-meter band. Check resonances on the other bands with the gdo. An increase or decrease in rod diameter will change the resonant frequency.

Note that after each adjustment of the antenna a check over the band, on each band, should be made. A compromise may be necessary in some cases, but this was not found to be so in my experiments. While testing, the antenna must be in its normal operating position. Changing from mobile to mobile may require some readjustments. Removing turns from the top has a profound effect on 40 and a lesser effect on 15; less still on 20 and 10.

80- and 160-meter operation

The antenna may be used for the two lower amateur bands by adding a suitable loading coil. The antenna should be

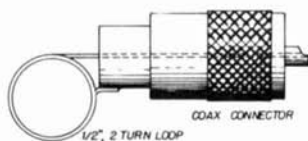

fig. 4. Loop with coax plug can be coupled to grid-dip oscillator to check resonant frequency of the antenna.

resonated, as before, at the lowest frequency of the band you intend to use. Again, check loading across the entire band. The antenna should take power if your transmitter output circuit is not too restricted.

conclusion

I am informed by ZS6U that he has designed a 40, 20 and 15-meter single section, which screws onto a Hustler in place of the loading coil. Changes of wire gage are used for this antenna, but details



Close-up of ZE6JP's mount. Details are shown in fig. 3.

are not available. Performance is at least equal to the single-band arrangements.

Additional resonances have been noted but no attempts have been made to use them. Typical resonances are (in MHz): 3.62, 7.05, 14.2, 21.1, 28.28, 31.8, 37.42, 44.5, 56, 67, etc. I don't know what the polarization really is, except it is mainly vertical by response on vhf. There is less decrease in signal strength when the antenna is moved from vertical than that measured from a base-loaded vertical antenna under the same conditions.

It's nice to change bands inside the mobile simply by reloading or by switching a relay to remove the short across the 80-meter coil.

ham radio



NEW REPEATER REPEATER

2 Meter Fixed Station

Designed for the man who demands professional standards in 2 meter equipment. *REPEATER LINE* fixed station antennas are the 2 meter HAM's dream come true. With everything you need for top fixed station performance...toughness, efficiency and the gain to gain access to distant repeaters with ease. Work many stations, fixed or mobile, without access to a repeater.

The right antennas for the new FM transceivers...or any 2 meter fixed station.

REPEATER LINE Fixed Station Antennas

Tough, high efficiency antennas with a long, low radiation. For the top signal and reception you want...and the top performance your transceiver's ready to deliver.

- 267 Standard 1/4 wave ground plane. May be precision tuned to any discrete frequency between 108 and 450 MHz. Takes maximum legal power. Accepts PL-259. Constructed of heavy gauge seamless aluminum tubing.
- 268 For repeater use. Special stacked 4 dipole configuration. 9.5 db offset gain. 6.1 db omnidirectional gain. Heavy wall commercial type construction. 144 thru 174 MHz. 1.5:1 VSWR over 15 MHz bandwidth eliminates field tuning. Extreme bandwidth great for repeater use. Center fed for best low angle radiation. DC ground. Complete with plated steel mounting clamps.
- 338 Colinear ground plane. 3.4 db gain omnidirectionally. Vertically polarized. 52 ohm match. Radiator of seamless aluminum tubing; radials of solid aluminum rod. VSWR less than 1.5:1. All steel parts iridite treated. Accepts PL-259.
- 362 SJ2S4 high performance all-driven stacked array. 4 vertically polarized dipoles. 6.2 omnidirectional gain. 52 ohm. May be mounted on mast or roof saddle. Unique phasing and matching harness for perfect parallel phase relationship. Center fed. Broad band response. DC ground.
- 340 3 element high performance beam. 9 db gain. Coaxial balun. Special VHF Beta Match configuration. Unidirectional pattern. VSWR 1.5:1. 52 ohm impedance. Heavy gauge aluminum tubing and tough aluminum rod construction.
- 341 8 element high performance beam. 14.5 db gain. Coaxial balun. VHF Beta Match. Unidirectional. Boom length 14'. VSWR 1.5:1. 52 ohm feedpoint. Heavy gauge commercial type aluminum construction.
- 231 15 element high performance beam. 17.8 db gain. Coaxial balun. Beta Match. Unidirectional. Boom length 28'. VSWR 1.5:1. 52 ohm feedpoint. Extra-strength heavy wall commercial aluminum tubing.

LINE from **Hy-gain** Antennas with real PUNCH!

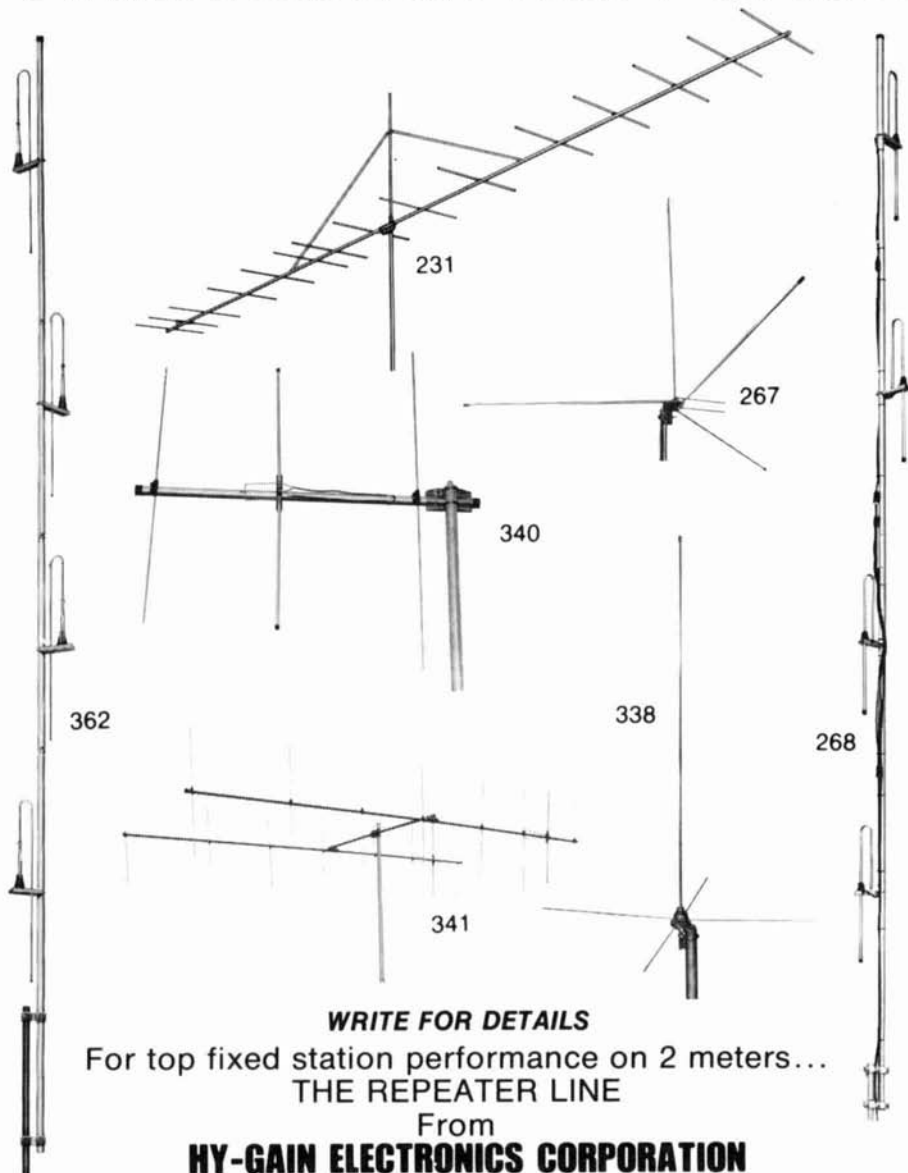

WRITE FOR DETAILS

For top fixed station performance on 2 meters...
THE REPEATER LINE

From
HY-GAIN ELECTRONICS CORPORATION

P. O. Box 5407-WL Lincoln, Nebraska 68505

simplified autostart and antispace for your ST-5

This simple circuit
can be easily added
to your ST-5
RTTY demodulator
to provide both
autostart and
antispace operation

Joseph M. Hood, K2YAH, 67 Mountain Ash Drive, Rochester, New York

It wasn't long after getting my teletype station operating that I became annoyed at having to constantly switch my teleprinter off, on and into *mark* when tuning or following a transmission. Before getting the teletype on the air the concept of autostart and antispace circuitry seemed to be a luxury that I could do without. However, after a few days of operating, it fast became a necessity. So began the search for suitable circuitry that would put an end to my switch-throwing frenzy.

I use an ST-5 terminal unit, fathered by W6FFC, which has been described sufficiently in previous articles. Autostart and antispace circuitry for the ST-5 has been also described previously, but every circuit which I happened upon seemed much too complex for the task at hand. So I decided to come up with something on my own — a simplified autostart, antispace (SAA) circuit.

Both autostart and antispace functions require a level-sensing device with a fairly high input impedance and good current handling capability in its output stage. After a short perusal through the integrated circuits catalogs I came across the Amperex TAA560 level detector Schmidt trigger. Its characteristics include

high input impedance, low power requirements and high output current control. It looked like just the thing for a start on a simple autostart and antispacer circuit.

autostart operation

The TAA560 is a four-terminal device and its operation is straightforward. A

TAA560 is used to detect the presence of a signal for the front-end portion of the autostart circuitry. However, to complete the circuit it is necessary to build a time-delay network for use in the teleprinter on-off control portion of the autostart circuit and in the antispacer circuitry. Again, the TAA560 is simple to

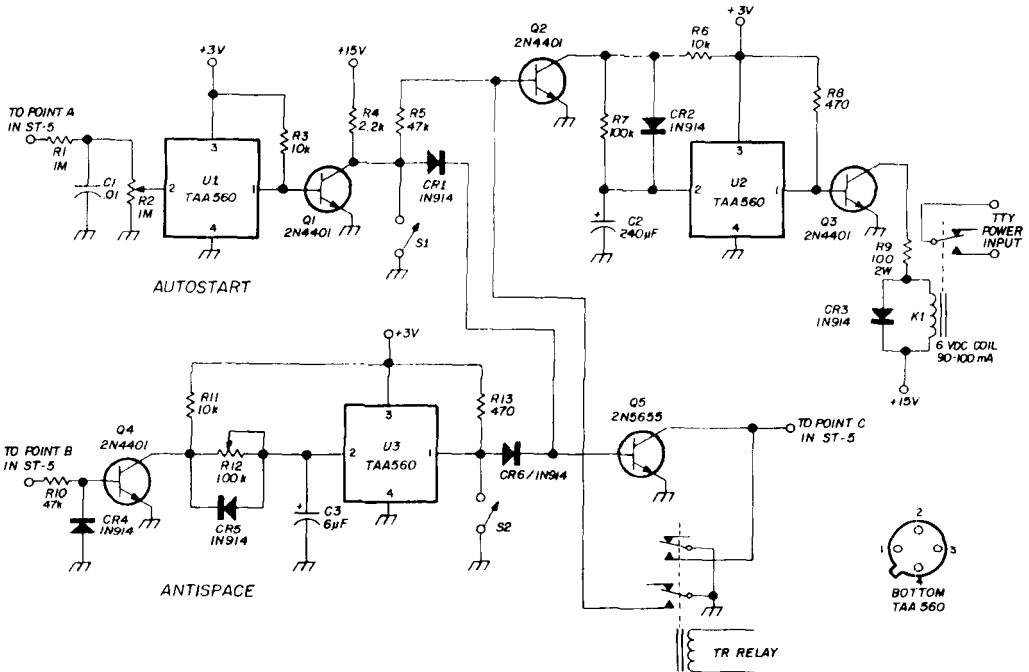

fig. 1. Complete diagram of the simple autostart, antispacer circuit for the ST-5 RTTY demodulator. K1 is a 6-Vdc relay, spst.

supply voltage of 2.5 to 4.5 volts is connected to pin 3, and pin 4 is connected to return. If the input signal applied between pins 2 and 4 is above the circuit trip point (between 1 and 1.5 volts) the output transistor will be off, and the pin 1 to pin 4 output path is open circuited. However, once the input level drops below the circuit trip point, the output transistor in the TAA560 is biased on, and the pin 1 to pin 4 path will pass up to 50 mA of current.

This level-detecting feature of the

use. A time delay may be had by using an RC network in association with the TAA560 input circuit. The capacitor is tied directly across the input of the TAA560 and is charged through a series resistor.

When a dc level is applied to the free end of the charging resistor the circuit waits until the capacitor is charged to the trip point of the TAA560 before changing state. The resistor-capacitor time constant determines the resultant delay. If a different turn-on versus turn-off delay is

required, a diode can be used to switch a resistor into or out of the charge or discharge path, as required.

With the level detector and time delay functions in mind, let's look at the total circuit operation by referring to fig. 1. Start with the autostart portion of the circuit.

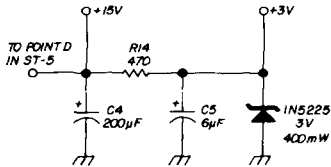

fig. 2. Power supply for the autostart, antispace circuit is connected to the ST-5 power supply (see fig. 3).

The obvious place to detect signal presence or absence is the output of the ST-5 meter amplifier at point A. The autostart input (using high impedances to minimize circuit loading) is connected here. With R2 properly adjusted, U1 will be off when a signal (+5 V or so) is present at point A and on when no signal (+2.5 V or so) is present at point A. If signal is present and U1 is off, Q1 is biased on, causing Q5 and Q2 to be biased off. When Q5 is off it allows the loop transistor in the ST-5 to control the printer magnets. When Q5 is on, the machine is locked in *mark* regardless of the ST-5 output state.

Now, back to Q2. When Q2 gets biased off by Q1 going on, capacitor C2 begins to charge through R6 and CR2. When the voltage across C2 reaches the trip point of U2 (about 3 seconds delay), U2 goes off, causing Q3 and then K1 to switch on, which turns the power on to the printer.

After loss of signal U1 goes on, causing Q1 to go off, which biases Q5 and Q2 on. With Q5 on the printer is locked in *mark*. When Q2 goes on capacitor C2 discharges through R7 and Q2. After a delay of about 30 seconds C2 is discharged below the U2 trip point, causing it to go on, which biases Q3 off, subsequently turning

K1 and the teleprinter off. Diode CR3 merely protects Q3 from the voltage spike created in switching the inductive relay coil.

antispace operation

Now, how about antispace? Here you must sense the presence of a *space* condition, and after a short time delay, cause the machine to be set to *mark* even though the *space* signal persists. If you look at the output of the slicer in the ST-5 (point B in fig. 1) you will note that in *space* it is in negative saturation or at about -12 volts. This causes transistor Q4 to go off which starts C3 charging through R11 and R12.

When the voltage across C2 reaches the trip point of U3, its output opens, causing Q5 to turn on, placing the machine in *mark*. The time delay set by the C3 charging circuit time constant (adjusted by R12) must be long enough to allow normal RTTY copy, but short enough to prevent annoying signals from causing the machine to run open.

Diode CR5 provides a low-impedance, fast discharge path for C3 to reset U3 immediately when a *mark* signal (+12V) reappears at point B. Diode CR4 merely protects the base-emitter junction of Q4 from breakdown due to the presence of the -12 volts at point B in the *space* signal condition. Diodes CR1 and CR6 allow the outputs of the autostart and antispace circuitry to be *ORed* into Q5 so that either can control Q5 without affecting the other circuits' output state. Again, since R10 is high, loading of the ST-5 circuitry is negligible.

construction

As far as construction goes, just about anything will do. I used a 3- by 5-inch perforated board with stake terminals and had room to spare. An etched board or any other construction technique is satisfactory. Circuit layout is not critical. Beware of mistakes in connections to Q5 since its base connections are different than you might expect.

After you have constructed your SAA,

some circuit setup will be required. The autostart input potentiometer should be set to produce about 1.5 to 1.6 volts at pin 2 of U1 with a *mark* or *space* signal peaked in the ST-5. Check to make sure that the circuit is operating by observing the voltage at the collector of Q1, with the antispacer circuit disabled (S2 closed).

should be set so that no spikes appear at the output when receiving a normal teletype signal. However, if you don't own an oscilloscope, merely set the delay long enough to get good printout. The adjustment is not critical once you've allowed enough time in the delay for normal teletype.

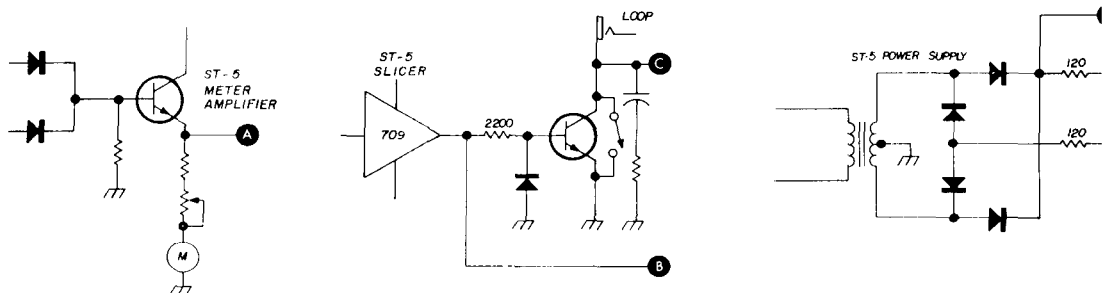

fig. 3. Connection points for the autostart, antispacer circuit in the original ST-5 demodulator circuit.

As a *space* is tuned into the ST-5 space filter the machine loop should remain in *mark* until the signal goes above the trip point of U1. When this occurs, Q1 should switch off (about 1.5 to 2.0 V at its collector), K1 should then close after about 3 seconds of delay, and the machine should start and run open.

You will note that there is a slight hysteresis in the autostart circuit — the trip point to turn on is higher than the drop-out trip point. This, however, is no disadvantage since it prevents noise from initially triggering the autostart, but, once a signal trips it, the hysteresis acts to keep the printer functioning during signal fading.

setup

Setting up the antispacer requires that the 100k potentiometer R12 be adjusted to provide a delay that will allow good copy, but is short enough to prevent an extended *space* condition from causing the machine to run open. This control is best adjusted by using an oscilloscope to look at the output of U3. The time delay

Switches S1 and S2 were added to allow the operator to disable the autostart and antispacer functions if desired. The base of Q2 is also switched to ground during transmit to keep the autostart from turning the teleprinter off while transmitting. A most embarrassing situation!

Don't try to operate the circuit from the zener-regulated, ST-5 supply. The additional loading will cause its output voltage to drop to an unacceptable level. Use the power supply connections shown in the diagram and you'll have no trouble. The ST-5 power transformer will easily handle the additional load.

That's the SAA. It has certainly made my RTTY operation less frantic and more enjoyable. Your new ST-5 and SAA may not equal an ST-6 but it comes close . . . say, an ST-5.8?

reference

1. Irv Hoff, W6FFC, "Mainline ST-5 RTTY Demodulator," *ham radio*, September, 1970, page 14.

ham radio

the Incomparable **CX7A** by

 **signal/one**



CX7A

Features:

- **RELIABILITY IS NOW** standard equipment. Every CX7A "burnt-in" and cycled more than 96 hours.
- **QUALITY-PLUS.** Every component is instrument grade. American-made, and individually tested.
- **ALL MODES** 10 thru 160 meters in full 1 MHz bands with overlaps.
- **BROAD-BAND TUNING.** Instant band changes without tuning.
- **TRUE BREAK-IN CW** with T/R switching.
- **IF SHIFT** — deluxe QRM slicer.
- **PRE-IF NOISE-BLANKER** that really works.
- **RF ENVELOPE CLIPPING** — sounds like a Kw.
- **TWO VFO'S** transceiver Plus receiver.
- **BUILT-IN:** Spotter, FSK shift, transmit offset, wattmeter, SWR meter, electronic CW Keyer.



CT-1500

Specifications:

- **SENSITIVITY:** Better than 10db signal-plus-noise-to-ratio for .25 microvolts at 28 MHZ.
- **SELECTIVITY:** 2.4 KHZ @ -6db, 1.8:1 (6:60db) shape factor. (16 pole crystal lattice Filters) optional.
- **CW-300** and 400 HZ. FSK-1200 HZ.
- **CARRIER** and unwanted sideband suppression. Minimum 60db.
- **IMAGE** and **IF REJECTION;** more than 60db.
- **POWER LEVEL:** 300 to 500 watts p.e.p. plus, continuous duty cycle.
- **POWER AMPLIFIER:** 8072 final completely broad-banded driver and final. 150 watts continuous dissipation rating.

CX7A- DELUXE INTEGRATED STATION \$2395
Still top-of-the-line. Now greater quality and reliability than ever before.



signal/one now presents the most complete

line of State-of-the-Art Equipment ever offered the Amateur. Available very soon from **PAYNE RADIO.**

CX-10 INTEGRATED STATION	\$1795
Single VFO, PS-10 required, optional plug-in Keyer.	
CR-1200 STATE-OF-THE-ART RECEIVER	\$1095
Single VFO, I.F. Shift, noise blanker, high sensitivity — selectivity.	
CT-1500 STATE-OF-THE-ART TRANSMITTER	\$1450
Single VFO, 300 watts, PS-10 required, RF clipping, broadband tuning, keyer.	
CR-1500- SPECIAL APPLICATION RECEIVER	\$1650
Two VFO'S included.	
PS-10 A/C	\$210
PS-10 D/C	\$210
EV-10 VFO for CX-10	\$225
SC-10 STATION CONSOLE	\$350
CX-2X TWO METER TRANSVERTER	\$460
CX-6X SIX METER TRANSVERTER	\$460

Phone/write **DON PAYNE, K4ID**, for a brochure, personalized service and a **KING-SIZE** trade-in on any gear you have — one piece — or the whole station. A small deposit will hold any new piece of signal/one for you until delivery. Exports are our speciality.

PAYNE RADIO

Box 525

Springfield, Tenn. 37172

Phone
Six Days (615) 384-5573

Phone
Nites-Sundays (615) 384-5643

Payne Radio Presents the Incomparable

ALPHA 77

by

ETD



The "77" is the finest Amplifier of its type ever offered for Amateur, Commercial, and Military Service. It is rated at 3000 watts PEP continuous-duty for Commercial and Military Service. It's a cool, quiet loafer at 2000 watts PEP.

- New Eimac 8877/3CX1500A7 air-cooled grounded-grid triode
- 4000 volts on plate
- 1500 watts plate dissipation
- 1500 watts continuous-duty transformer — tape-wound core of grain-oriented steel — cuts size and weight by 40%
- Vacuum-variable tuning capacitor
- 25 mfd oil-filled filter capacitor
- Vacuum relays that don't "clank" — ultra-quiet, instant T/R switching
- 6000 volt-20 Amp bandswitch
- Battleship construction — 1/4" Aluminum sides
- Electrical and mechanical safety interlocks
- Complete metering by two 3 1/2" taut-band quality meters — including 0-5000 direct reading RF wattmeter
- ALC-adjustable threshold
- 120/240 volts 50/60Hz, 3 wire, single-phase
- MIL-SPEC BLOWER — centrifugal, ball-bearing, low-speed, ultra-quiet — thermostatically controlled
- Desk-top Cabinet — completely self-contained
- 9 1/2 x 17 x 18 inches — 70 lbs. net — 90 lbs. shipping
- Grid over current relay "Kicks-out" if under loaded or overdriven. Protects tube, input circuit — a warning when "flat-topping" occurs.
- Provision for full electronic break-in with exciters.

Its perfection for \$1795. Available for immediate delivery.

**SPECIAL INTRODUCTORY OFFER
PREPAID AIR-FREIGHT SHIPMENT WORLD-WIDE**

If you want to move up to the finest, the "77", phone/write Don Payne, K4ID, for a brochure, Alpha 77 operating experience, and a top trade-in on any gear you have — one piece — or the whole station. Exports are our specialty.

manufactured by
EHRHORN TECHNOLOGICAL OPERATIONS INC.
Brooksville, Florida 33512

distributed by
PAYNE RADIO

Phone
six days
(615) 384-5573

Box 525
Springfield, Tenn. 37172

Phone
Nights-Sundays
(615) 384-5643

a single-element DX antenna

Almost unknown,
the half-wave vertical
can out-perform
the popular
ground-plane and
quarter-wave verticals

B.H. Brunemeier, VQ9N, c/o 944 East Cardinal Drive, Sunnyvale, California ■

I have spent many years in Asia. In the Asian context, DX usually means 20- to 100-watts input on CW. A rotary beam is almost a curiosity on the CW bands as the overwhelming majority of CW DX chasers here are using a single-element wire dipole or a simple ground-plane vertical. One element, properly erected and matched, however, can produce some astonishing results.

The quarter-wave vertical, or ground plane, is too well known to require an exhaustive description. It is traditionally accepted as a very simple, and yet effective, DX antenna. However, it does have some disadvantages that are worth considering. The greatest disadvantage is its characteristic inefficiency. It is fed at a low-impedance point with a relatively high rf current. For every ampere flowing in the vertical portion producing useful radiation, there is also an ampere flowing in the ground screen. This ground-current ampere produces no useful radiation, but does account for some very significant power losses.

Most amateurs using this antenna content themselves with a ground screen of four wires, little realizing how much of

their rf power is simply warming the wires and contributing nothing to the outgoing signal. The same disadvantage applies to receiving as inefficiency in the ground system saps the incoming signal to the same degree. Yet another disadvantage is that the quarter-wave antenna just isn't very tall and doesn't have nearly the receiving capture area of a full dipole which is twice as long.

half-wave advantages

From my personal observation on the air, I've noted that the full half-wave vertical is unknown around the world. I have never yet contacted another station using one. This is indeed a mystery. The half-wave vertical has several distinct advantages which make it much more attractive than the quarter-wave. Because it is a full resonant half wave, and twice as tall, it is that much better for receiving. Its base impedance is much higher than the quarter wave, and this contributes to high efficiency. A simple example will clarify this point.

Feeding 100 watts of rf into a quarter-wave vertical with a nominal base impedance of 50 ohms would produce a current of 1.4 rf amperes. A full half-wave vertical made of typical tubing would have a nominal base impedance of 900 ohms.

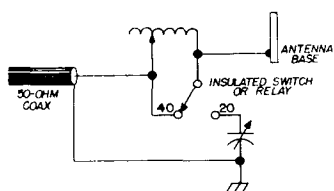

fig. 1. Switching method to use a 34-foot vertical as a half wave on 20 meters and a quarter wave on 40 meters.

Feeding 100 watts of rf into this impedance would produce a current of 0.33 rf amperes. Because the current flowing into the ground screen is the same as that which flows into the an-

tenna, the quarter wave system would have 4.25 times more ground current than the half-wave system. The losses in the ground screen are the product of $I^2 R$ (where I is rf current and R is ground losses), and assuming the same ground screen for both antennas, the power

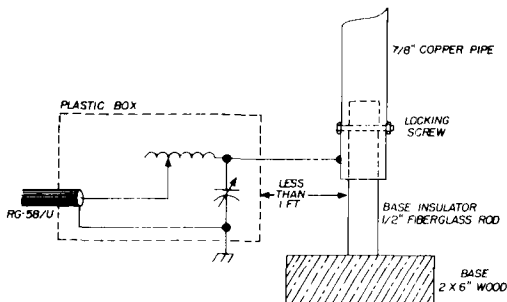

fig. 2. The antenna matching unit. The coil is 10 turns, no. 10 AWG wire, 1½-in. diameter and 1½-in. long. The capacitor is 100-pF maximum.

losses in the quarter-wave system would be eighteen times higher than in the half-wave system!

Another advantage to the half-wave system is that it has a theoretical gain of about 2 dB over the quarter wave, and concentrates that gain at a slightly lower angle above the horizon. With all these advantages to recommend the half-wave vertical, I can't help wondering why DXers around the world aren't using it. Is the 900-ohm base impedance the problem? It need not be. A simple coil and capacitor matching network takes care of that quite easily.

construction

Fig. 3 shows a half-wave vertical now in use at VQ9N. The material used is copper tubing, 7/8-inch outside diameter. It is a standard plumber's stock item on this island. Aluminum tubing is unavailable here. Note that the length is only 31 feet, rather than 34 feet, which would be a resonant half wave for 20-meter operation.

The reason for this shortage was purely economic. I bought one new 20-foot

length. It was so expensive I didn't feel like buying another whole length to cut up. A scrap 11-foot length of 5/8-inch diameter was on hand, so I spliced the two to create a 31-foot vertical. The logic was that 0.45 wavelength is so close to full resonance, that it would give essentially the same performance. This logic has proven valid in practice. Also, the supporting insulators contribute some capacitive loading, which would tend to make the antenna a little taller electrically.

The most difficult part of the project was erecting the vertical. Copper is a very soft metal and cannot support its own weight in such a length, let alone the weight of guys and insulators. During my first three attempts at erecting it, my copper column suddenly became a folded dipole in the middle. This wasn't quite what I had in mind!

On the fourth attempt I enlisted a few extra helpers. Two pulled on the upper guys, one walked up under it and the fourth pushed at the top with a long wooden pushing prop. The fourth attempt was successful, though the copper column sustained some permanent standing waves along its length, created by the earlier collapses. A vertical made of 1-inch galvanized water pipe would be much easier to set up than the copper tubing I used.

The base matching coil is made of number 10 AWG copper wire (see fig. 2). It is wound on a form and then slipped off to make an airwound coil with a 1½-inch diameter. The original coil was made with 15 turns, close spaced. The finished coil should be spread just enough so that adjacent turns don't short together. The matching capacitor is an APC air padder, 100-pF maximum. This plate spacing is adequate for rf powers up to 200 watts, which would put about 600 peak volts across the capacitor.

tuning

The matching process is a simple matter of trial and error that can be

accomplished in minutes. Insert a reflected power meter or swr bridge in the line at the transmitter end and apply enough power to give some meter deflection. Begin with the full coil in the circuit, and turn the capacitor through its range. If no dipping trend is noted on the meter, remove one coil turn and repeat the process.

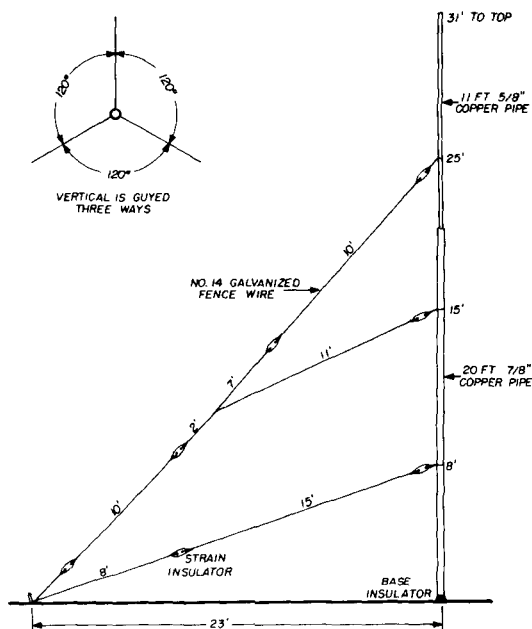

fig. 3. Overview of the 20-meter half-wave vertical. Although copper is used here, many different types of tubing could be used for the radiator.

Because the matching is quite critical, you won't see much of a meter null until you reach a point about two turns from the optimum one. Then the meter starts going down fast, and on the proper turn it can be nulled right down to zero with the capacitor. That's all there is to it.

I did my matching at 14.175 MHz, and got an swr of 1:1. The antenna response is so broad that at 14.000 and 14.350 MHz it rose to only 1.05! When the matching was finished, I had ten active turns in the circuit, which gave a coil length of 1½ inches. The unused turns were then snipped off and discarded. The

capacitor was meshed to about 60-pF.

The proof of the pudding is in the signal reports. Corrugated metal roofs are almost the standard in Asia, but I went one better. My roof is corrugated aluminum, and almost level at that. A more ideal rf ground can hardly be imagined, although galvanized iron roofing does very well too. A number of tests were run on DX paths in excess of 4,000 miles to evaluate this half-wave vertical antenna in relation to other more familiar types.

I compared the half wave with the two-element quad at VQ9R and the standard quarter-wave vertical at VQ9DM (also using an almost-level aluminum roof for a ground plane). Allowing for the difficulty of taking accurate signal readings over a long path with fading, seasoned operators at the other end of the circuit gave the quad about a 6-dB advantage over the half-wave vertical.

Some of you may find it hard to believe that a single vertical element could deliver a signal only one S-unit below the popular two-element quad. Comparing the half-wave vertical to the quarter wave vertical, it was found that the half wave was considerably better. In the case at hand, the aluminum roofing rf ground plane was practically lossless for both vertical antennas.

Finally, the half-wave vertical was compared to a regular half-wave horizontal wire dipole at about the same elevation. The vertical beat the horizontal dipole by a considerable margin in any direction. So then, low-budget DXers of the world, take heart! Now's the time to pull down those wire dipoles and start standing half waves on end. At VQ9N, I run only 35 watts input on CW, and I work the world with this antenna. Where a level metal roof is not available, a ground plane of wires can come close to the same performance. An increase of signal performance over a wire dipole is very effective. Can any one imagine a simpler way to achieve so much DX gain for so little investment?

ham radio

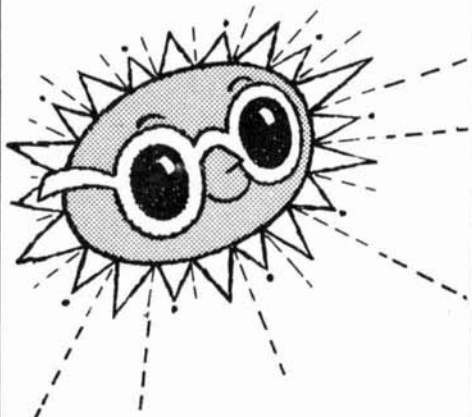

TROPICAL HAMBOREE AND SOUTHEASTERN ARRL CONVENTION

**JANUARY 20-21, 1973
MIAMI, FLORIDA**

• • •
**TAKE A BREAK FROM WINTER
FOR SOME FUN IN THE SUN!**

- • •
- Manufacturers' exhibits
 - Giant in-door flea market
 - DX and QSL Manager booth
 - ARRL Forum with late info from Board Meeting
 - YL/XYL program & much more

• • •
Combine it with a flight to VP7
for a glorious vacation!

• • •
**ADVANCED CONVENTION
REGISTRATION—\$1.00**

Convention Hotel Rates
\$14 single - \$18 double
(No advance deposit but reserve
by January 15)

More info? Write:

DADE RADIO CLUB

P. O. Box 73, B.A.
Miami, Florida 33152

EVEN SANTA SHOPS AT SPECTRONICS



especially during their 2 for 1 Sale

plus other specials also to numerous to mention



If you've wanted to try 2 meter FM, but didn't want to invest a lot of money doing it, now is the time to get your feet wet. From now until **December 30** you can do just that. During this period you can buy 2 Motorola T43 series radios for our normal single unit price of \$85.00 plus shipping. These radios are 25-30 watts output, 6/12v vibrator powered and easily convertible to 2 meters. Both units come complete with head, cable, mic, speaker and housing. You can use one unit for your mobile and convert the other to AC or find a friend who would like to get on FM with you and share the cost.

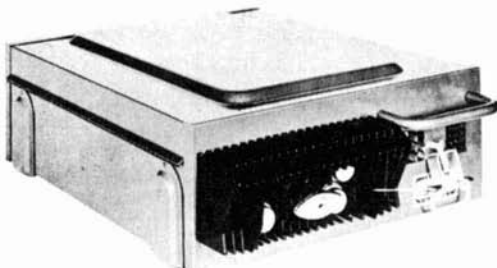

For those of you who are already on 2 meter FM our 2 for 1 sale has something in it for you also. If you've wanted to try the other popular FM bands, 6 & 10 and UHF, but were hesitant to spend big money doing it now is the time to give it a try. During this sale we will also offer 2 for 1 on all lo band and UHF completely tube type mobile radios in our 1972 catalog. You can even pick one lo band and one UHF unit and pay for the higher priced of the two plus shipping.

As usual sale limited to licensed amateurs for amateur use only. Due to fantastic discount offered, no club discounts will apply. Many units in short supply so don't wait. We will be glad to send catalog on request to help you select your radio and take advantage of such savings.

We realize that a few people will think we're crazy for making such a fantastic deal on FM equipment, but then we're not called the **FM PEOPLE** for nothing.



1009 Garfield St.
Oak Park, Ill. 60304
Area Code 312-848-6778

AMATEUR SALES ONLY / SPECTRONICS



Tues. — Thurs. 9:30-6:00 Fri. 9:30-8:00 Sat. 9:30-3:00 Closed Sun., Mon., and Holidays
INQUIRIES WITHOUT ZIP CODE OR CALL LETTERS . . . NO ANSWER

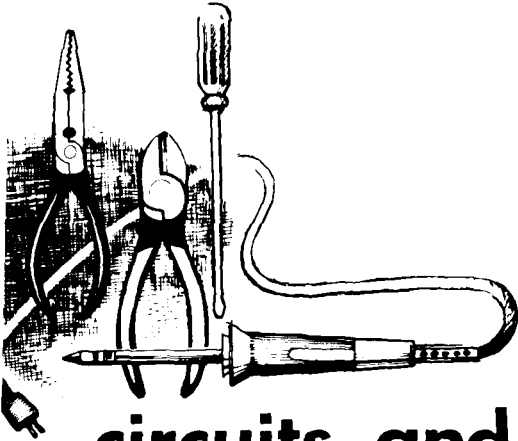

circuits and techniques ed noll, W3FQJ

antenna tuners

Radio amateurs in the United States and, in other parts of the world too, have developed a 50 to 70 ohm transmitter and 50 to 70 ohm antenna syndrome; manufacturers of amateur equipment have contracted the same ailment. Antenna experimenters, who probably dominate ham experimentation today, have complained for years about the lack of versatility in the output system of modern amateur transmitters. Their contention is, especially at exciter power levels, that a variety of output impedances could be made available economically and with little additional space at least up to 600 or 800 ohms. In fact, the transmitter with a little more versatility and a built-in swr meter and tuner might well become a very popular model.

The usual antenna experimenter prefers to work at low-power level because it is easier to obtain more conclusive results. This is not a factor that should preclude installation of more versatility in the output systems of high-powered transmitters as well, although it is true that cost and space factors are more significant for high-powered output systems.

enter the tuner

The antenna tuner unit (atu) provides the matching capability that the transmitter lacks, fig. 1. Its principal duty is to see that the transmitter output is matched regardless of the impedance conditions at the transmission line input. If the transmitter is made to see a proper load, it operates in an efficient and normal manner. A second fine advantage of most tuners is that they block harmonics and other spurious signals from the antenna system. This advantage holds up even when using an antenna system that can be matched directly to the transmitter.

It also is important to know what an antenna tuner does not do. It does not alter the standing wave ratio (swr), reduce attenuation or otherwise improve operating conditions on the transmission line connected between the tuner and the antenna proper. It does not improve the operating performance of the antenna. What it does do is permit you to match the transmitter to an antenna system regardless of the impedance conditions reflected to the input side of the transmission line and the other variables, serious or not so serious, that may be inherent in the antenna arrangement. An example demonstrates the above statements.

Let us assume a peak performance, narrow-band antenna is designed to operate over 100 kHz of the 40-meter band. This antenna system has been designed to permit a direct match to the transmitter output. Except for the reduction of spurious frequencies, an atu would be of little benefit in operating over this 100-kHz span.

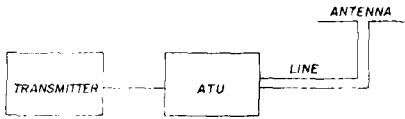

fig. 1. The antenna tuning unit on the transmitter side of the transmission line.

Off of the antenna system bandpass, impedance conditions would become unfavorable and a safe direct match would no longer be possible. Now the insertion of an atu permits the matching of the antenna system to the transmitter. Although antenna performance and line conditions are not improved by the presence of the atu, at least the antenna system can be loaded by the transmitter. In many situations the performance of the antenna system would not be noticeably different in practical communications than if the antenna were recut to this new operating resonant frequency.

Usually the impedance conditions of the above antenna resonated on 40 meters become intolerable for direct matching on 20 meters. Here again an atu of suitable design would permit you to match the transmitter to the antenna system. At least you would be able to load the antenna on 20 even though the presence of the atu does not improve the line or antenna performance on that band.

An atu is a marvel in an emergency situation and when multi-band operation is desired in a location where only a single antenna can be strung. You can at least load up the hunk of wire to obtain mediocre to good performance on a number of bands.

In summary, the atu:

- Provides proper transmitter loading.
- Provides harmonic and spurious signal rejection.
- Permits you to accommodate an antenna that has a resonant impedance other than 50-70 ohms.
- Permits you to accommodate the impedance of a broad-band, non-resonant antenna when its impedance is other than 50-70 ohms.
- Permits you to load an antenna off of its resonant frequency on a given band.
- Permits you to load an antenna on a band for which the antenna was not designed.
- Does not change line conditions and swr.
- Does not change antenna performance.

line considerations

Line factors are a consideration when using an atu at high power level. The atu does not change the line attenuation, and line attenuation does increase with the standing-wave ratio. If the line is especially long, the swr high and the attenuation per foot high, you may lose considerable power on the line even though the transmitter is matched properly.

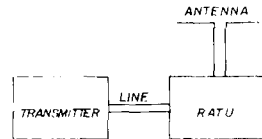

fig. 2. The remote antenna tuning unit between the antenna and the transmission line.

The power handling capability of the line is important. A high swr means voltage loops become very high on modulation crests. The rating of the line must be such that it will not break down on peaks. The higher the operating frequency the more important becomes the loss

consideration because of the increase in line attenuation with frequency.

ratu

An antenna tuning unit can be made to accommodate the transmission line as a part of a matched system by locating the tuning unit between the antenna and

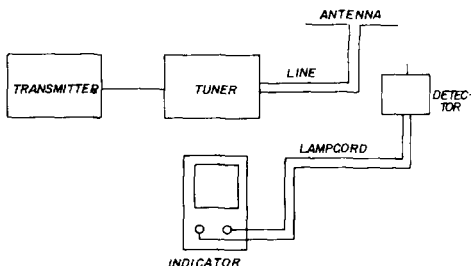

fig. 3. A remote indicator helps in adjusting the antenna tuner.

the far end of the transmission line, fig. 2. Minimum line attenuation and the lowest possible standing-wave ratio are now obtainable, provided the impedance of the transmission line matches the impedance of the transmitter. The remote antenna tuning unit (ratu) now matches the far end of the transmission line (same impedance as transmitter) to the antenna. This is the technique used by broadcast and other commercial transmitters that operate at a high power level.

Seldom necessary in amateur radio applications, it is employed to best advantage only when the transmission line is exceptionally long and high power is to be handled. However, it is sometimes a convenient way of matching the very low resistance and high reactance of a short 160-meter antenna. When you do wish to reduce line loss to a minimum and your transmission line is not the best in terms of minimum attenuation this arrangement is worthy of consideration.

how to tune a tuner

A critical transmitter can be damaged by reflecting an improper load from the

tuner. Initial adjustments must be made at low power.

Tuners come equipped with various means of band setting — plug-in coils, switched coils or switched capacitors. Regardless of the method, set the atu to the proper operating band. In adjusting a tuner try to maintain as low an swr reading as possible with the transmitter operating at low power. Usually you will have to jockey back and forth between the tuning and matching controls of the tuner to find the very least swr. In almost all practical applications this is all that is necessary in finding a true setting and minimum swr. As the power level is increased touch-up adjustments are usually necessary. Keep records of proper settings so you can return to them after changing frequencies. In most situations it is as simple as that.

false loading

False match points are found occasionally especially when using home-built tuners or trying to accommodate wide impedance differentials between input and output. Under a false condition the component values within the tuner plus the impedance conditions presented by

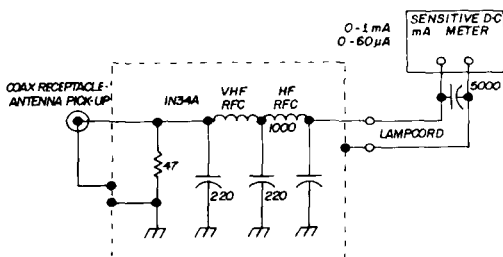

fig. 4. Simple circuit for a remote reading antenna performance indicator.

the output load are such that most of the power is absorbed by the tuner itself. What looks to be a favorable match is reflected to the transmitter. False matches can be avoided with the use of some sort of simple field-strength indicator. The pickup should be placed as near to the antenna as is possible, fig. 3. An

occasional check of the meter reading, using binoculars or by a second person on the job, would be appropriate if you suspect a false match point.

I have found the simple arrangement of fig. 4. helpful. A simple diode detector and output filter are used and the antenna can be a loaded 6-meter, 10-meter or CB quarterwave vertical. Suitable readings can be obtained over the entire hf and vhf-uhf bands.

A sensitive dc meter can be used as the indicator but it need not be a part of the detector proper. A long length of ordinary lamp cord can be run between the detector output and the meter. This permits you to place the meter at a point where it can be seen as you adjust the tuner. In fact, if you keep the line well filtered and isolated as far as possible from the transmission line, you can bring the meter right into the shack or at least to a point where you can see it as you look out the shack window. Proper tuner adjustment is indicated by minimum swr and maximum field reading. A false match will result in a very weak field reading.

how does an atu function?

The atu performs two major tasks. It cancels out the reactance of the antenna system and provides the resistive step-up

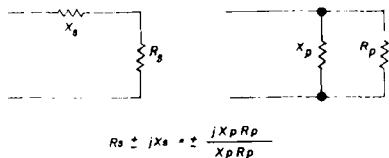

fig. 5. Equivalent series and parallel combinations.

or step-down needed to match the resistive components. It accomplishes this by utilizing a basic characteristic of a simple or complex CL network. A series network with a specific resistance and reactance also has an equivalent parallel value of shunt resistance and shunt reactance, fig. 5. Conversely, a parallel combination also

has an equivalent series value of resistance and reactance.

That such a relationship exists can be proven by setting down the expression for an equivalent parallel network of resistance and reactance as follows:

$$Z_p = \frac{-jX_p R_p}{R_p - jX_p}$$

This equation can be reworked to obtain the expressions for its real and reactive components (resistance and reactance) as follows:

$$Z_p = \frac{X_p^2 R_p}{R_p^2 + X_p^2} - j \frac{R_p^2 X_p}{R_p^2 + X_p^2}$$

Note that the above is a simple series expression (R - jX). This is a fundamental series equivalent with the following values:

$$R_s = \frac{X_p^2 R_p}{R_p^2 + X_p^2}$$

$$X_s = \frac{R_p^2 X_p}{R_p^2 + X_p^2}$$

Further mathematical procedures can be used to set up the parallel reactance and parallel resistance equivalents of a series circuit. These are:

$$R_p = \frac{R_s^2 + X_s^2}{R_s}$$

$$X_p = \frac{X_s^2 + R_s^2}{X_s}$$

In matching an antenna system to a transmitter or line, an appropriate network (atu) is inserted between the series resistance and reactance presented by the antenna to reflect an equivalent parallel impedance that matches the strictly resistive impedance of the line or transmitter. (Sometimes the load too has a reactive component that must be considered.) The parallel-connected network of fig. 6 consisting of a series inductor and parallel capacitor can serve as a

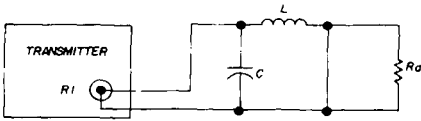

fig. 6. Simple LC matching arrangement.

simple matcher. The values of these components are determined and become of such value that an appropriate impedance match is made between the two resistive components $R1/Ra$. Let us assign a symbol of "n" to the latter ratio.

Further mathematical procedures can now be used to reduce the equivalent series and equivalent parallel reactance equations to the following simple expressions:

$$X_s = R_a \sqrt{(n-1)}$$

$$X_p = \sqrt{\frac{nR_a}{(n-1)}}$$

Let us assume we are to match a 72-ohm transmitter to an antenna with an impedance of 36 ohms resistive and -160 ohms reactive (capacitive), fig. 7. To balance out the reactive component of the antenna it will be necessary to use a series inductor with at least an inductive reactance of +160 ohms. Additional inductive reactance will be necessary to handle the impedance match. Likewise the reactance of the shunt capacitor must be selected for appropriate impedance match. The two equations are now employed. Additional series inductive reactance needed is:

$$+X_s = 36 \sqrt{2-1} = 36 \text{ ohms}$$

$$-X_p = \sqrt{\frac{2 \cdot 36}{2-1}} = 72 \text{ ohms}$$

The former is added to the previous 160 ohm value to obtain a required L value of:

$$L1 \text{ reactance} = 160 + 36 = 196 \text{ ohms}$$

The parallel reactance value becomes:

$$C1 \text{ reactance} = 72 \text{ ohms}$$

The above reactances can be converted to inductance and capacitance at the operating frequency by using the basic reactance equations:

$$L = \frac{Xl}{2\pi f} \quad C = \frac{1}{2\pi f Xc}$$

If operation is centered about 1.82 MHz, actual values are as follows:

$$L = \frac{(196) 10^{-6}}{(6.28) (1.82)} = 17.1 \mu H$$

$$C = \frac{10^{-6}}{(6.28) (1.82) (72)} = 1216 \text{ pF}$$

When antenna characteristics are not known exactly it is no great problem. You can assume very approximate values or draw from your practical knowledge of coil and capacitor sizes for a specific frequency. It is then only necessary to make one or both of the reactances adjustable. This is why antenna tuning units are indeed tunable. They permit you to adjust the matching network for an idealized match on any frequency by making adjustments and watching an swr bridge for the very best match and forward output.

counters

Thank you, Roy (R.W. Lewallen, WØETU), for sending the helpful counter data that follows:

In reference to your article in the July issue of *ham radio*, I would like to contribute a systematic method of wiring a divide-by-n counter, which besides not

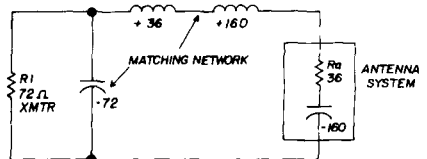

fig. 7. A typical antenna matching situation as explained in the text.

All of the above is quite understandable. However, to the uninitiated, the wiring of an integrated circuit appears to be a very complicated thing. Actually it is simple and the major complication is usually the printed-circuit board. However, this can be avoided by using straight wiring techniques as suggested in the first experimental procedures in the June column. If you use binding posts and jumpers it is also possible to change the count sequences between the combinations shown in figs. 2 and 3.

The pin-out wiring diagrams for the 7490 are given in figs. 4 and 5. Note how very simple it is. There are a number of terminals to which no connection is made and another group which are all tied to common. Of course, there are supply voltage as well as input and output connections to be made. The diagrams of fig. 4 are for using the 2-to-1 and 5-to-1 counters separately. Both the connections of fig. 5 provide the 10-to-1 count.

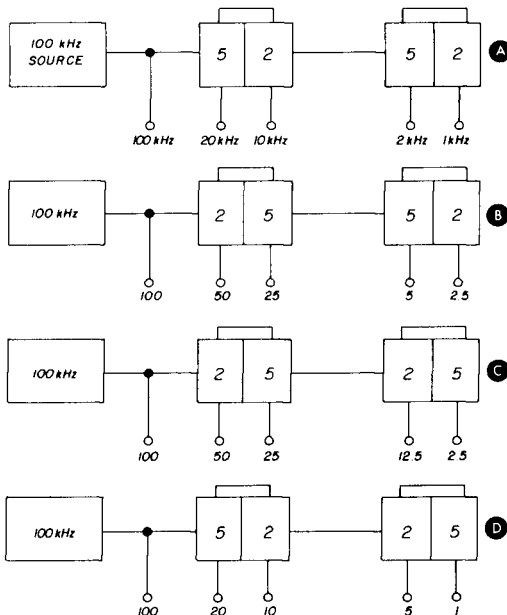

fig. 2. Some of the count possibilities using two decade dividers.

However, in the first example, the first count is 5-to-1; the second, 2-to-1. The second example is the converse, using the initial 2-to-1 count and then the 5-to-1.

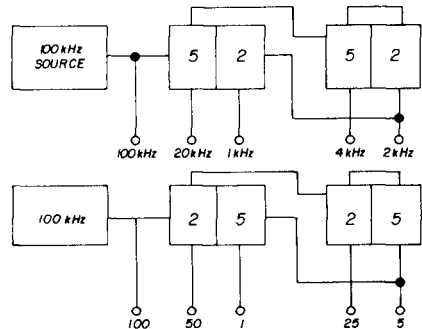

fig. 3. Two additional count possibilities using two decade dividers.

digital IC oscillators

Digital ICs of suitable design can also be used as high-frequency crystal-controlled square-wave generators. The 7400 NAND gate used initially in this series can be operated as a high-frequency oscillator. Two of the four gates are wired as a multivibrator while a third one is used as a buffer output. Doug Blakeslee, W1KLK, has used this common IC successfully with the circuit of fig. 6A.¹ Its output is followed by two 7490 decade dividers.

Ted Bensinger, W5PCX, uses the 7400 in the 3-MHz IC oscillator arrangement of fig. 6B.² Two of the NAND gates again serve as the multivibrator while the two other sections are pressed into service as buffer and calibrate outputs. Two decade dividers provide the countdown to 30 kHz. W1KLK operates his circuit at 3 MHz to get the same 30-kHz output. However, he employs a high-frequency 74H00 NAND gate. Theoretically this IC should provide steeper sides and higher harmonic output levels.



GALAXY GT550A

Only \$595

AC400 SUPPLY \$99.95
freight prepaid in the USA

BONUS COUPON

SHURE 444 MICROPHONE

Included free with every GT550A
from L. A. Electronix

A \$34.95 VALUE



Electronix Sales

23044 S. CRENSHAW BLVD., TORRANCE, CALIF. 90505

Phone: (213) 534-4456 or (213) 534-4402

CLOSED SUNDAY & MONDAY

HYGAIN TH6DXX WORLD'S BEST DXER



\$179.95

**TR-44
CDE ROTOR
\$69.95**

BONUS COUPON
ADD \$49 FOR HAM-M

*Wide space 4-element
Tilt boom to mast
Tiltable clamp*

FOB TORRANCE, CA.



Electronic Sales

23044 S. CRENSHAW BLVD., TORRANCE, CALIF. 90505

Phone: (213) 534-4456 or (213) 534-4402

CLOSED SUNDAY & MONDAY

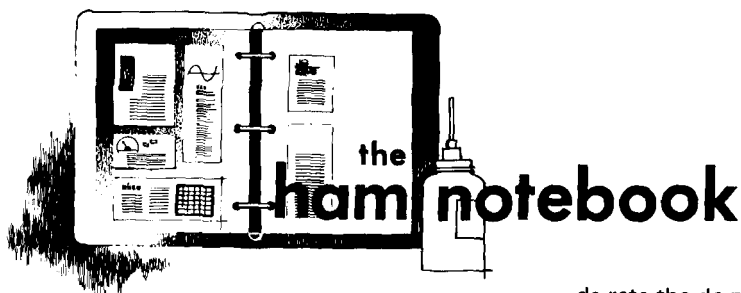

oil-filled capacitors

When it comes to dependability, you can't beat oil-filled filter capacitors. While electrolytic capacitors have the advantages of compactness and low cost, they just don't have long lives. Whenever long-term stability and dependability are important, design engineers invariably specify oil type filter capacitors. More amateurs would be inclined to use them but for the fact that they are reputed to be far beyond the amateur's price range. This is not so in all cases, for surplus oil-filled capacitors appear on the market at quite reasonable prices. Some of these first-rate capacitors are rated in "working ac volts." Lacking a direct translation for this industrial rating, the average amateur will often write off these bargains.

For oil-filled capacitors, commonly used with ac, there is a unilateral conversion table for their utilization with dc voltages (table 1). For various reasons, there is no equivalent conversion setup for dc-to-ac, but this is of no interest for the amateur constructor.

An alternate arrangement, which has served me very well over the years, is as follows: Multiply the ac voltage listed by 2.828. What this equation shows is that the maximum steady dc voltage is equal to the peak-to-peak ac voltage rating. This calculation will give you the *maximum* dc voltage rating, and for the sake of conservative engineering and trouble-free operation on rectified 60-Hz ac, it is wise to

de-rate the dc maximum voltages given by roughly one third.

The calculations listed above seem to work best for the higher ac voltages, and it roughly parallels the equivalent voltages in the higher ranges of table 1. It is worth noting that you may end up with some odd voltages, such as 2121 volts or 2750 volts. Do not allow this to confuse you, since that seemingly odd value is very close to the true rating.

In some cases, if the actual size of the oil-filled condenser in question is known, it may be possible to identify its equivalent maximum dc voltage rating by comparing its size to a dc capacitor which is catalogued and rated by the manufacturer. Armed with the foregoing knowledge, it is possible to match up the various offerings which appear from time to time. Still in doubt? Recently I picked up a 13- μ F oil-filled capacitor, rated 950 Vac, equivalent dc rating approximately 2700 volts. This is the maximum rating, and when used at roughly 2000 volts, it should last a lifetime. The cost, utilizing the above information, was only five dollars.

Neil Johnson, W2OLU

table 1. Dc working voltages of ac rated oil-filled capacitors. All dc voltages listed are the nearest standard voltage.

ac working voltage	dc working voltage
110	200
220	400
330	600
440	1000
550	1500
660	2000

NE561 as an ssb detector

I presently have on the drawing board a receiver which will use a 561B as a multimode detector (fm, a-m and ssb). Needless to say, I was somewhat dismayed to read in the March 1972 "Circuits and Techniques" column that the circuit will not work as an ssb detector. I decided it was time to do some breadboarding.

In the September 1971 issue of *ham radio* WA2IKL was close. A block diagram of his detector in the sideband mode is shown in fig. 1. The crystal oscillator locks up the PLL and the output from the vco is fed to the balanced modulator.

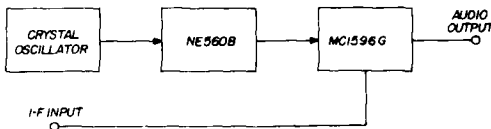

fig. 1. WA2IKL's detector circuit in ssb mode.

The NE561 is in essence an NE560 and an MC1596 combined into one package. I had assumed that the 561 would work perfectly as a multimode detector. I was given further encouragement by the Signetics applications memo on the PLL which stated, "... Its design is similar to the Signetics 560 Phase Locked Loop but it contains an additional product detector to perform the a-m detection function."

The block diagram of a 561 operated in the a-m mode is shown in fig. 2. Phase detector number one serves only to lock up the vco to the a-m carrier. This detector makes no use whatever of the

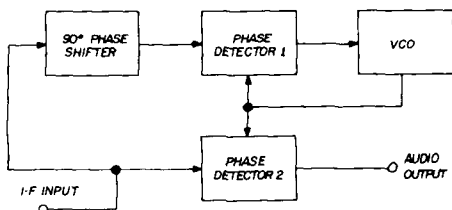

fig. 2. Phase lock loop used as a-m detector.

modulation sidebands. The vco is locked ninety degrees out of phase with the a-m carrier; therefore, when an external ninety-degree phase shift network is used the vco will be in phase with the carrier. The a-m detection occurs in phase detector number two. In the fifties, sidebanders used to call this exalted carrier detection, except for the fact that they

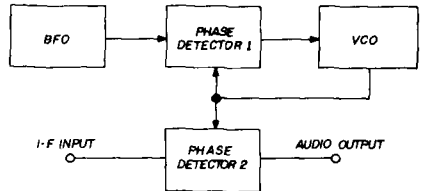

fig. 3. Phase lock loop used as ssb detector.

did not sync their bfos to the incoming signal.

Because a sideband signal is transmitted without its carrier, the missing carrier must be reinserted at the receiver. There is no point in combining the bfo with the i-f signal directly. As shown in fig. 3 the bfo signal is fed to the fm input to lock up the loop. The i-f signal is fed to the a-m input to be detected in the second phase detector. The ninety-degree phase shift network would be meaningless in this case. The vco frequency is identical to that of the bfo, and the vco becomes the reinserted carrier. Detection occurs in phase detector number two just as in any other product detector.

The circuit which I breadboarded is shown in fig. 4. The 455 kHz i-f signal was stolen from the Drake 2B through the Q-multiplier socket. The audio was fed into the receiver through an audio input I had added to the 2B earlier. The third converter tube was removed from its socket to disable the unused parts of the receiver.

While there are quite a few omissions in the design, sophisticated circuitry was skipped in the name of speed. This is not intended as a construction project. The hope is that it will give some good ideas.

The performance of the detector is

excellent. Noticeable distortion both by ear and by oscilloscope sets in at about 2.5 volts peak-to-peak output. Some high-frequency bfo hiss is heard, but a good low pass filter would probably take out most of it.

My ultimate receiver will have an NE561B as a multimode detector.

Max Robinson, K4ODS

however, had only one rf stage ahead of the mixer, which means the image response was not the best. When tuning near the low end of 20 meters, for example, the image from a strong Loran station completely wiped out the lower 5 kHz of this band. Further up the band, the image from a foreign phone station dominated another segment. The receiver

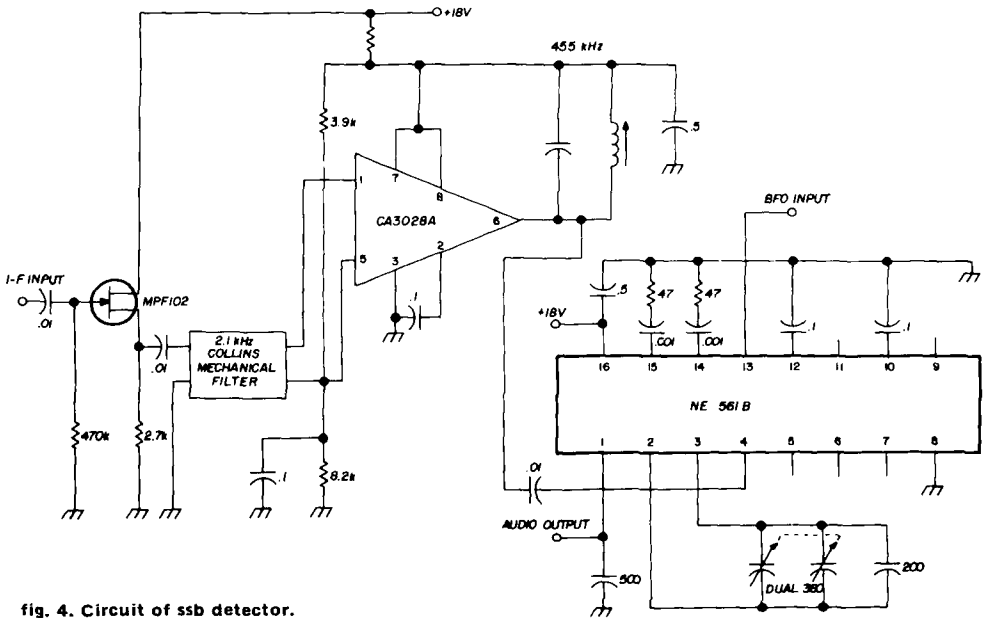

fig. 4. Circuit of ssb detector.

receiver image suppression

At a local ham swap meet I found what appeared to be a good bargain: a refurbished receiver about five years old with several interesting features, including a built-in Q multiplier. I wanted to give the set a smoke test before making the purchase, but the only source of power was being used to operate a PA system over which frustrated wives were trying to locate lost kids and husbands. Anyone who has ever been to a ham swap meet will know what I mean.

I bought the receiver anyway; it looked to be in mint condition. The set,

was practically useless for chasing weak DX signals.

Images are easy to recognize, since they appear on the dead-zone side of zero beat in receivers with good i-f selectivity. The signal-to-image ratio in superhets can be improved in several ways, including the addition of more front-end selectivity, multiple conversion, and special circuits in the mixer input. However, I didn't want to dig into the set, so an alternate solution was needed.

The outboard trap shown in fig. 5 is about the simplest means of attenuating images, without opening up the receiver. The LC circuit was built into a metal box to reduce hand capacitance, which makes

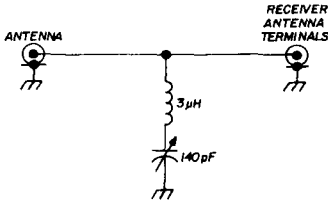

fig. 5. Series-resonant trap for improving receiver signal-to-image ratio. Circuit covers 20 and 40 meters.

tuning difficult. The trap was also effective in attenuating a strong local ssb signal that caused severe receiver overload. This device has been published in the literature many times, but I offer it again for those who may have overlooked it.

While certainly not a cure-all for receiver front-end problems, this simple circuit allowed weak cw signals to be copied that could not otherwise be heard on the 20-meter band.

Alf Wilson, W6NIF

neutralizing tip

With the tight packaging used in modern final amplifier design, it's sometimes difficult to find space for a neutralizing capacitor. The neutralizing scheme used in my mobile rig is shown in fig. 6. A one-inch strip of copper foil (shim stock) was formed around the final amplifier tube envelope and positioned so that it was level with the plate.

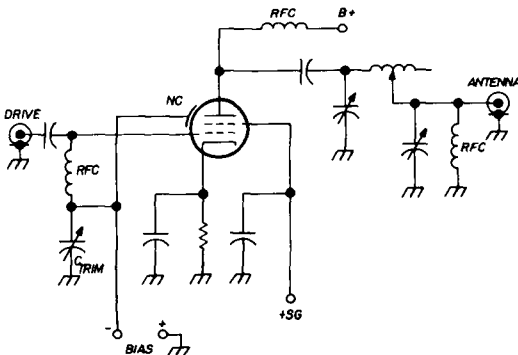

fig. 6. ZE6JP's neutralizing scheme for limited space. Neutralizing capacitor, NC, is a strip of copper foil placed around the tube envelope.

connected to a compression-type trimmer capacitor, and the amplifier was neutralized in the usual manner. A little cement on the copper prevents shifting relative to the plate.

Try the circuit first without the trimmer capacitor. It may not be needed, depending on distributed capacitance in the circuit and the interelectrode capacitance of your particular tube. Note the rf choke connected across the amplifier output. This component is sometimes omitted in pi-network amplifiers, but it's good insurance against high voltage appearing on the antenna should the plate blocking capacitor develop a short circuit.

H. L. Booth, ZE6JP

spurious signals with the Yaesu

A number of obviously spurious ssb and CW signals have been heard from the United States and Japan recently. Investigation led to writing Yaesu for help. Yaesu's president, JA1MP, was very cooperative, and should be thanked for his assistance.

One of the signals was on lsb on 14087.37 kHz. It was caused by an usb signal on 14306.85 (a mean frequency of 14197.11 kHz). JA1MP says that several trap coils are used in Yaesu equipment to reduce spurious radiation by at least 50 dB.

In this case the spurious signal was in an FTdx-400, and was probably caused by mistuning of the trap coils L17 and L19 which are located in the plate circuit of the transmitter first mixer. This spurious crosses at about 14,200 kHz and is strongest at that frequency. His suggestion for alignment is that the transmitter be tuned to 14,220 kHz and the receiver to about 14,180 kHz where the spurious is heard. Then adjust L17 and L19 for minimum S-meter reading on the receiver. When properly tuned, the spurious is down more than 50 dB—even at the worst point.

The CW spurious signals were heard on the 10-meter band, where they are caused

in Ftdx-560 transceivers by the second harmonic of the 3180 kHz i-f that is generated by the transmitter second mixer stage when the mixer is overdriven. Especially on 28 MHz, users are apt to overdrive the rig to overcome the lower efficiency due to the higher frequency. To reduce the second harmonic, Yaesu now is modifying all rigs to install a sharp suck-out crystal filter in the i-f circuit of transceivers.

JA1MP enclosed a copy of the Spec-tronics "Yaesu Information Bulletin" relating to the FTdx-560/570 equipment. It shows how to place a 6358.6 kHz crystal, XT-1, across TC-3 (the middle hole in BPF-5) which tunes a tank circuit in V-203.

Bill Conklin, K6KA

current limiting

The current list price for a 2N3054 is \$1.20, for a 2N3055 it is around \$2.00 and for a 2N3716 it is around \$6.50 (all in quantities of less than ten). For the price of a 2N1711, 75c to 85c, plus the cost of a 0.2 ohm resistor, you can save yourself many dollars in replacement costs. If you have fuses in your supply, you can save on these also. Fuses are nice, but they are just not fast enough for today's solid-state devices.

If you are using a zener-regulated supply with a series pass transistor, by merely adding a series resistor and transistor switch combination, you can have whatever range of current limiting you desire.

Fig. 7 is representative of many of today's dc supplies; however, there may or may not be a Darlington pair as I have shown here. Numerous articles have been written covering supplies for the current breed of vhf transceivers; however, some are worse than others. Some say they have current limiting, but close inspection reveals the output pass transistor is not protected as all. The November 1971 issue of *QST* had an excellent article on dc supplies. If you are building a new

supply, you may prefer to follow their guidelines if you want the latest in solid-state design. The April 1972 issue of *73 Magazine* had an article on a dc supply for the HR-2. This article had "current limiting," if you want to consider a resistor in series with the bridge rectifier

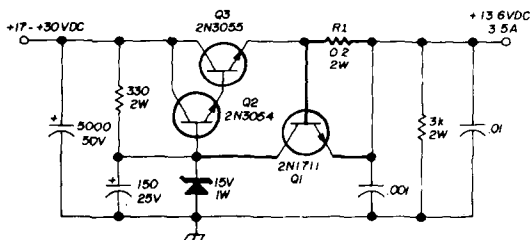

fig. 7. Adding current-limiting to an existing power supply. Q1 and R1 are new components. See text for calculating value of R1.

to collector of the pass transistor any form of limiting. This method does not prevent the pass transistor from getting extremely hot and eventually wiping itself out.

Refer back to fig. 7, with the added components Q1 and R1. If the current drawn by the load, exceeds a preset value ($I1R1$), Q1 then conducts depriving the base of Q2 of its drive voltage. The output goes to "zero" and nothing burns out. The added transistor does not need to be mounted on a heat sink, and is a TO-5 case device. The pass transistor and its Darlington driver should be mounted on heat sinks and adequately insulated with silicon grease.

If your supply does not have a Darlington driver, then connect the collector of Q1 to the pass transistor base. Just imagine that Q2 is not there.

To calculate the value for resistor R1, use the following formula: $R1=(0.7)/Isc$, where Isc is the short-circuit maximum current desired.

This addition to my supply has saved many power transistors from destruction. It is a very welcome addition. Thanks to Bill Durspek, W0BVR, for his help in solving my problem.

William P. Lambing, W0LPQ

THE ONLY 2M FM TRANSCEIVER

- WITH TOTAL COVERAGE OF 146-148 AND NOT A SINGLE CRYSTAL NEEDED
- THAT USES TEFLON WIRE THROUGHOUT
- WITH MORE THAN 25 WATTS OF OUTPUT POWER
- THAT IS EQUIPPED WITH "ANTITHEFT MOBILE MTG. BRACKET"
- THAT USES 10 INTEGRATED CIRCUITS

FM 27-B



NOW! WITH IMPROVED STABILITY

NOW! ACCESSORY POWER SUPPLY AVAILABLE

NOW! SUB-AUDIBLE TONE AVAILABLE ON TRANSMIT

NOW! AVAILABLE



Clegg DIVISION

3050 Hempland Road
Lancaster, Pennsylvania 17601

Amateur Net \$479.95

The most powerful signals under the sun!



Hy-gain

Redesigned

HAMCAT

Out-hustles them all!

The famous HAMCAT...now redesigned for greater performance...*equals* or *exceeds* the performance of any other Amateur Mobile antenna. *We guarantee it!* And you need buy only one mast...whether you mount it on fender, deck or bumper. There's just one set of coils and tip rods...and they all stand up to maximum legal power. That's performance, that's value...*THAT'S HY-GAIN!*

Original Hy-Q "quick changer" coils wound on tough fiberglass coil forms for greater heat resistance, less RF absorption / Fiberglass shielded coils can't burn up, impervious to weather / Shake-proof, rattle-proof, positive lock hinge now even stronger...eliminates radio noise / All stainless steel tip rods won't bend or break / Full 5' mast gives you 10% more radiating area than the competition / Rugged swivel-lock stainless steel base for quick band changes, easy garaging.

Get the Hamcat...from Hy-Gain

- Order No. 257 All new design 5' long heavy duty mast of high strength heavy wall tubing \$16.95
- Order No. 252 75 meter mobile coil \$19.95
- Order No. 256 40 meter mobile coil \$17.95
- Order No. 255 20 meter mobile coil \$15.95
- Order No. 254 15 meter mobile coil \$12.95
- Order No. 253 10 meter mobile coil \$10.95
- Order No. 499 Flush body mount \$ 6.50

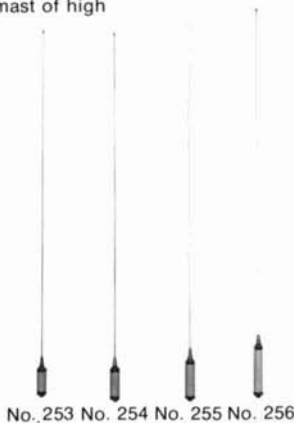

HY-GAIN ELECTRONICS CORPORATION

P. O. Box 5407-WL, Lincoln, Nebraska 68505

Digipet-60 Frequency Counter 1 KHz-60 MHz

(130-160 MHz with optional converter)

only \$299

A frequency counter with a range of 1 KHz to 60 MHz (or 130-160 MHz when used with our Digipet-160 converter). With a resolution of 1 KHz or 1 Hz (at 1 ms. or 1 s. gate times). It can be operated on either AC or DC, with complete overload protection. Plus a stability aging rate of 1 part in 10⁶/week. And the whole unit is a mere 7" deep by 2½" high! In other words, a fine piece of equipment at a terrific price: \$299. From one of the most respected names in electronics, no less. For further information, contact: Miida Electronics, a division of Marubeni America Corp., 2 Hammarskjold Plaza, New York, N.Y. 10017 Phone (212) 973-7152.

Miida



Distributorships available

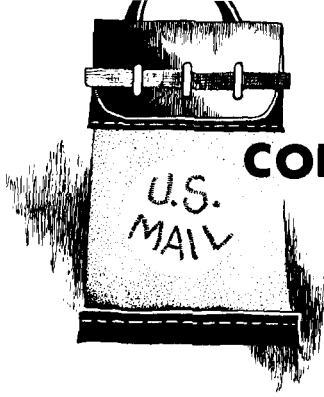

comments

quartz crystals

Dear HR:

It is commendable that amateurs are becoming aware of the intricacies of quartz crystals; it is great that two authors chose to write on the subject in *ham radio*. The subject is a clear-cut science and not the black magic which some people try to make it. As a result of the black magic aura, much misinformation exists. The prime movers in the field of crystal enlightenment are the US Army Electronics Command, Fort Monmouth, New Jersey, and Bell Telephone Laboratories. Annually, interested factions of the electronics industries are brought up to date at the Frequency Control Symposium held in Atlantic City, New Jersey. IEEE-sponsored committees are continuously at work on a national and international basis to aid in standardizing terms, measurement techniques, and manufacturing procedures so that everyone can communicate on a common basis.

It would behoove the amateur radio operator to learn the terms used in the industry as he studies crystals. Author Sondgeroth interchanges terms that have specific definitions other than the meaning he intends. Such will eventually confuse any student if it has not already. While I personally have differed with the parlance of the crystal industry, I find it is necessary to use the language understood by my converser.

The term "holder" refers to the case in which the quartz is mounted. The holder is only a minor contributor to C_0 . Static capacitance (C_0) is primarily a function

of the electrodes sandwiching the quartz. Why must the author refer to C_0 as holder capacitance? Depending on the area of the plating, and the thickness of the quartz, C_0 can range from 3.5 to 7.0 pF on crystals commonly found in surplus houses. The figure of 5 pF is only a seat-of-the-pants estimate.

Elements of the motional arm are usually designated C1, L1, and R1, although C_M , L_M , and R_M are understandable. When the subscript M is used, I can't see the reasoning behind defining the terms as "equivalent" and "effective." I believe this is misleading if not incorrect. "Equivalent Series Resistance" is the term used to define the resistance of the crystal in an oscillating circuit and it includes series resistances and parallel conductances of the holder, not shown in this equivalent circuit. Hafner* uses the term equivalent a second time as equivalent reactance (X_e) of an oscillating crystal, but this cannot be broken down into the reactances of C_M and L_M , solely. The reactance of C_0 also has an effect. The terms motional capacitance, motional inductance and motional resistance are preferred.

A point on which the reader should also be cautioned is Mr. Sondgeroth's statement that you can save money by tuning a lower accuracy crystal. Not necessarily so! Lower accuracy crystals are generally so designated because they have poorer temperature characteristics. If you operate under conditions of wide temperature variations, you may become a slave to the technique of crystal tuning.

It is not my intent to sharpshoot the article — I feel it is well written and pertinent to an amateur's problems.

*Standard Definitions and Methods of Measurement for Piezoelectric Vibrators, IEEE No. 177, May, 1966.

In G8ABR's contribution to the *ham notebook*, a statement is made that air-mounted crystals, e.g. 10X, will always oscillate at exact multiples of the fundamental. I believe in this case the crystal is vibrating in the fundamental mode and tripling electrically. Most of the air mounts (pressure types) will not operate in harmonic mode because the coupling of the plates to the quartz is poor. This would include FT-243 and older HC-6/U crystals. It is just about impossible to make any crystal with exact frequency multiplication by operating in harmonic modes.

Don Nelson, WB2EGZ
Voorhees, New Jersey

code practice

Dear HR:

The editorial in the May 1972 issue concerning building up code speed with coastal station transmission copy practice is certainly meritorious. Table 1 is part of the schedule I compiled and distributed to the fleet of off shore tankers I am connected with, for use by the Radio Officers. Data was secured from various publications and direct observations and checks.

WSL transmits about a half hour weather copy four times a day as indicated. It is tape and about 23 or so wpm. WAX is good for two daily periods at about 16 wpm, also tape. WOE sends two daily periods, about 20 or so wpm, and most of the times is good copy. WSL on the 12-MHz frequency seems to be about the best bet for the most powerful signal.

About the only maritime telegraph stations I have found that send in the 30- to 35-wpm category are the Russians. Their merchant fleet, in recent years, has expanded phenomenally. They met the need for new frequencies without trouble. They picked out low-powered coastal stations and moved on top of them. They stayed clear of the high powered ones like WSL or WCC. One example is UQK, Riga, who is parked on WLO, Mobile, Alabama, 12704.5 kHz. They are netting in as the ships use the

table 1. Weather transmissions in International Morse Code.

station location	time GMT	frequency kilohertz
WCC	0050	436 2036 4331
Chatham, Mass.	1250 1650	436 2036 6376 8630 436 2036 6376 8630
WSL	0500	418 8514
Amagansett, New York	1100 1700 2300	418 8514 13024.5 418 8514 13024.5 17021.6 418 8514 13024.5 17021.6
WSC	1418	460
Tuckerton, New Jersey	2318	460
WMH	0130	428 8686
Baltimore, Maryland	1600 1330 1930	428 8686 12952.9
WOE	0105	472 6411.35 8486 12970.5
Lantana, Florida	1605	
WAX	0135 1335	488 4295 8526 13011 488 8526 13011 17199.2
WPD	1800	420 13051.5
Tampa, Florida		
WLO	1300 1700	438 8714 12704.5
Mobile, Alabama	2300	
WNU	0430	478 4310 6495 8570
New Orleans, Louisiana	1630	478 6495 8570 12826.5
WPA	1748	416 8550 12839.5
Port Arthur, Texas		

same frequency as the coastal stations. Weather transmissions from their ships to UQK is at about 0000, 0600, 1200 and 1800 GMT. Speed is in the 30- to 35-wpm range, very good code sending addressed to *pagoda* and is in standard international code. These messages are mostly number groups with ships names and should be good practice for our high speed boys.

I would suggest stressing the matter of *regular daily* code practice to build up speed. Once or twice a week will be of not much help in building up speed. A month or so of daily practice should bring a 13 worder up to 20 plus with no strain.

Paul Szabo, WB4LXJ
Tampa, Florida

power in reflected waves

Dear HR:

Various letters have been received, commenting on my paper, "Power in Reflected Waves" (*ham radio*, October, 1971). Most writers agreed, but some disagreed with my principal conclusion that there is no power in reflected waves on a transmission line. I wish to thank all who wrote me, for their interest in my paper.

Much of the disagreement appears to be based on incredulity, rather than on reasoned technical analysis. This is understandable, because most pertinent writings which have appeared in amateur periodicals, and indeed in important handbooks written for amateurs and even for professionals, have discussed power in reflected waves as if it were a reality. Rare exceptions are "Losses in Feedlines" by Byron Goodman, *QST*, December, 1956, and "The Mismatched RF Transmission Line" by Carl C. Drumeller, *73 Magazine*, November, 1969. These writers correctly said that so-called *reflected power* is not really power at all.

The technical criticisms received can be combined and summarized as follows:

1. The voltage and current standing waves on an unmatched transmission line have a phase difference of 90 degrees only when reflection is complete, and therefore, under other circumstances they represent power.
2. The input impedance of the transmission line is not matched, and cannot be matched, to the output impedance of the transmitter unless the tube's load resistance is equal to the tube's plate resistance, which is not the case in practice; therefore, virtually complete reflection of the *power* in the reflected wave does occur at the transmitter output.
3. In the case of my **fig. 2**, there is a reflected wave on the coaxial line shown, for the reason that there is no other possible destination for the

power in the reflected wave on the open transmission line.

I will discuss briefly these three points in order.

Point 1. The fact is, the voltage and current standing waves on a mismatched transmission line have a phase angle of 90 degrees even though reflection is not complete. To avoid going into a detailed proof, the references are cited in evidence.

Point 2. This criticism is incorrect, but in any event it is irrelevant; it does not prove or demonstrate that there is power in the reflected wave.

Point 3. This is a peculiarly circular argument. It claims that I am wrong in denying that there is a reflected wave on the coaxial line in my **fig. 2**, because, contrary to my principal conclusion, there *is* power in the reflected wave on the open transmission line, and this must appear on the coaxial line. In other words, it says that I am wrong because I am wrong! This criticism, like the one above, does not prove or demonstrate that there is power in the reflected wave on the open line.

Whoever originally wrote about power in reflected waves on transmission lines as being a reality, no doubt thought that this concept would serve to simplify, for the non-professional, the manner of formation and significance of standing waves. Historically, it has served only to complicate the matter endlessly, as writer after writer, following the original lead, and unwilling to break with precedent, has grappled with reflection of *power* in rf lines and its re-reflection back and forth ad infinitum, with trying to explain how it is that a directional wattmeter can indicate, under some circumstances, more power in the line than the transmitter is putting into it, and how power at the same frequency can travel both ways simultaneously. They seem to have forgotten that the basic definition of power is, "the rate of doing work," and have failed to show where and how this work, corresponding to the assumed power in

the reflected wave, is being done. Of course, they cannot show this, because it is not power and therefore is not doing any work.

The underlying error in these misconceptions is the failure to distinguish between ac power, or volts ac times current ac, multiplied by a power factor other than zero, from volts ac times current ac, multiplied by zero power factor. The former is power; the latter is not, and it is a fundamental error to call it so. Power utility engineers know better than that.

The basic point to be recognized about power in a transmission line is simply that the power from the transmitter into the line is the sum of the power lost in and from the line and in any additional matching or other devices inserted into the line and the power delivered to the antenna. There is no other power moving in either direction. It is that simple.

**Hubert Woods
Jalisco, Mexico**

tuning toroidal inductors

Dear HR:

In his article, "Tuning Toroidal Inductors," (*ham radio*, April, 1972), author WAØJYK indicates that a grid-dip oscillator cannot be used because there is not enough flux leakage from the toroid.

The fact is that a grid-dip oscillator will give excellent readings on a tuned circuit having a toroidal inductance. Just put a loop of wire through the toroid and twist it into a link around the coil of the grid-dipper. If a precision capacitor is used, the inductance can be calculated to a degree of accuracy limited only by the care with which the resonant frequency is read.

Even rough checks by the gdo-capacitance-frequency method can give better results than those given by all but the best laboratory bridges since the measurement is usually made with the inductance excited at the frequency at which it will actually be used.

**Barry Kirkwood, ZL1BN
Auckland, New Zealand**

reciprocating detector

Dear HR:

I have received several letters regarding my "reciprocating detector" article which appeared in the March, 1972, issue of *ham radio*. Transistor Q5 is part of the reciprocating detector switch, but the questions are understandable due to the lack of a dot to show a connection in the schematic; resistors R4 and R5 should be joined with a dot where these two resistors form a junction point at the input to the diode and the base of Q5. The diode is a 1N252.

Several readers have also asked where the selectivity curve is 500-Hz wide and what is its slope. The filter I used was designed to have its 500-Hz passband at the 3-dB points on a slope which is not particularly steep for an inductive filter. Indeed, at 500 Hz, the L3 inductance is very loosely coupled to the other two sections of the transformer. The bandpass formula (f_r/Q_Q) indicates that the bandpass of the filter is actually narrower than 500 Hz — in fact, bandpass is closer to 250 Hz. The 390-ohm resistor used in series with one of the differential inputs loads the thing down so it is broader. If the bandpass is too narrow, poor lock-in range is experienced on a-m, and there is very poor "presence" in the quality of ssb signals. If the bandpass is too wide, poor impulse rejection will result.

**Stirling M. Olberg, W1SNN
Waltham, Massachusetts**

RTTY speed converter

Dear HR:

I just completed construction of the RTTY speed converter described by WA6JYJ in the December, 1971, issue of *ham radio*, and it works like a charm. I built the converter on a printed-circuit board which greatly simplified its construction. I can furnish printed-circuit boards to interested readers for \$6.00.

**Earl E. Palmer, W7POG
17510 Military Road South
Seattle, Washington 98188**

radio control

Dear HR:

I would like to remind your readers that the frequencies, 53.10, 53.20, 53.30, 53.40 and 53.50 MHz have been recognized by the FCC as *radio control frequencies* for licensed amateurs who engage in remote control of model boats or airplanes.

Interference on these radio control frequencies has been on the increase, causing loss of control. This can be disastrous to the model builder who has spent countless hours and a lot of money on his model, only to see it crash because of interference.

Considering all the frequencies available to amateurs who use six meters for communications (CW, ssb, RTTY, etc.), it seems reasonable to ask them to stay clear of the radio control frequencies noted above. In addition, since it is impossible to build fancy receivers into the very small space available in most models, it would be appreciated if a reasonable guard band, say 6 kHz, could be observed.

Pierre J. Catala
Needham, Massachusetts

pi-network inductors

Dear HR:

W6FFC's article on pi-network design is easily the best and most comprehensive treatment of the subject that has ever been published in a ham magazine. Congratulations. I believe I can add something on the matter of inductors for high-power tank circuits.

There has been a lot of theorizing on the effects of corrosion on bare copper, and the benefits of silver plating, but little actual measurement. Some time ago, out of curiosity, I resurrected an old 10-meter tank coil from my junkbox. It had been wound at least ten years previously, and consisted of several turns of 1/4-inch copper tubing, 2-inches long. It was the familiar chocolate brown color of old copper.

I measured the Q of this coil on a freshly-calibrated HP 260-A Q Meter. It measured 173. Next, I had the coil chemically cleaned and brightened. The Q increased to 176. Then the coil was silver plated .0002 inch. This raised Q to 178. All of these measurements were made during an eight-hour period.

As a final experiment, I wound a coil of number-14 tinned copper bus wire, of the same length, diameter and inductance as the copper tubing coil. The Q measured 172.

These measurements show that the benefits of silver plating are negligible at frequencies up to 30 MHz. The difference in efficiency of an amplifier using any of these coils could hardly be measured. However, I would not recommend the use of the wire coil, since, as W6FFC points out, at 30 MHz the coil dissipation may be as much as 100 watts, and the wire coil would be inadequate. Dissipation rather than Q is the real reason for using tubing or heavy strap at the high-frequency end of the range.

The experiments also demonstrated something that the textbook equations for the rf resistance of an inductor imply: the Q of a coil, over wide limits, is more dependent on the size and shape of the coil than on conductor size.

Harry R. Hyder, W7IV
Scottsdale, Arizona

laser communications

Dear HR:

In regards to W4KAE's letter in the May issue, his claim to the first two-way laser QSO is a little late. There was a two-way laser QSO on February 25th, 1971 between W8WEJ/Ø and W4UDS/Ø on a frequency of 475 THz using A3 modulation (QST, July, 1971, page 93). This precedes W4KAE's contact by almost 9 months.

Although W4KAE's two-way laser contact was not the first, it is definitely the DX record to date. Keep up the good work, Ralph.

Lee Yazell, WB9AIU
Pensacola, Florida



There's a **DRAKE DEALER** near you...

Drake Dealers are dependable and friendly.
For a good deal, see your nearby Drake Dealer:



- ALABAMA**
Birmingham (35233)
Ack Radio Supply
3101 Fourth Avenue, S.
James W. Clary Co.
1713 Second Avenue, S.
- ARIZONA**
Phoenix (85006)
Henshaw Electronics
1644 E. McDowell
- ARKANSAS**
DeWitt (72042)
Moory Electronics Co.
12th & Jefferson, Box 506
- CALIFORNIA**
Burbank (91505)
Electronic City, Inc.
4001 W. Burbank Blvd.
Burlingame (94010)
Ham Radio Outlet
999 Howard Avenue
Fresno (93710)
Dymond Electronics
46 E. Shaw
Los Angeles (90064)
Henry Radio
11240 Olympic Blvd.
Oakland (94607)
Anrad Supply
1025 Harrison Street
Pasadena (91106)
Dow Radio - Milo
1759 E. Colorado Blvd.
Riverside (92501)
Mission Ham Electronics
3316 Main Street
Sacramento (95825)
Electronics
1912 Fulton Avenue
San Diego (92101)
Western Radio & TV Supply
1415 India Street, Box 1728
San Jose (92128)
Guement Electronics
1000 S. Bascom Avenue
Torrance (90505)
L. A. Electronic
23044 Crenshaw Blvd.
- COLORADO**
Denver
Burstin Applebee
800 Lincoln (80203)
CW Electronic Systems
1401 Blake St. (80202)
- CONNECTICUT**
Hartford (06114)
Haty Electronics
500 Ladyard Street
- DELAWARE**
Wilmington (19801)
Willard S. Wilson, Inc.
403-405 Delaware Avenue
- DISTRICT OF COLUMBIA**
See Maryland & Virginia
- FLORIDA**
Ellenton (33532)
Bill Step Company
2412 Highway 301 North
Miami (33137)
Amateur Radio Center, Inc.
2805 N.E. Second Avenue
Sarasota (33579)
The Ham Shack
1966 Hillview Street
- GEORGIA**
Atlanta (30309)
Ack Radio Supply Co.
554 Deering Road
- HAWAII**
Honolulu
Honolulu Electronics
819 Keeumoku St. (96803)
- Island Electronics
1111 McCully St. (96814)
- IDAHO**
Boise (83702)
Morton Electronics
2113 North 26th Street
- ILLINOIS**
Lincoln (62656)
AAA Sales
555 Woodlawn Road
Palos Heights (60463)
Green Mill Radio Supply
12111 South 88 Court
Peoria
Klaus Radio & Electric Co.
8400 N. Pioneer Pky (61614)
Selectronics
800 S.W. Jefferson (61605)
River Forest (60305)
Trigger Electronics
7361 North Avenue
- INDIANA**
Angola (46703)
Lakeland Radio Supply
525 S. West Street
Evansville (47710)
Castrup's Radio Supplies
1014 W. Franklin Street
Indianapolis
Graham Electronic Supply
133 S. Pennsylvania (46204)
Van Sickle Radio Supply
4131 N. Keystone Ave. (46205)
South Bend (46624)
Radio Distributing Co.
1212 High Street
Terre Haute (47802)
Hoosier Electronics
Box 403, RR #25
- IOWA**
Council Bluffs (51501)
World Radio Laboratories
3415 W. Broadway
Davenport (52801)
Klaus Radio & Electric Co.
311 E. 2nd Street
Des Moines (50310)
Lafayette Radio Assoc. Store
3621 Beaver Avenue
- KANSAS**
Overland Park (66204)
Associated Radio
8012 Conser
Wichita (67211)
Amateur Radio Equipment
1203 E. Douglas
- KENTUCKY**
Morehead (40351)
Ferguson Electronics
137 E. First Street
- LOUISIANA**
New Orleans (70130)
Radio Parts, Inc.
1331 Prytania Street
- MAINE**
Leviston (04240)
Down East Ham Shack
57 Main Street
- MARYLAND**
Baltimore (21211)
Amateur Radio Center
1117-19 W. 36th Street
Wheaton (20902)
EISCO
11305 Elkin Street
- MASSACHUSETTS**
Boston (02115)
DeLambro Radio Supply
1095 Commonwealth Ave.
Reading (01867)
Graham Radio Company
505 Main Street
- MICHIGAN**
Ann Arbor (48104)
Purchase Radio & Supply
327 E. Hoover
Detroit
Radio Supply & Engineering
85 Selden Av. (48201)
Reno Radio Co.
1314 Broadway (48226)
Flint (48507)
Shand Electronics Inc.
2401 S. Dort Highway
Grand Rapids (49503)
Radio Parts, Inc.
542 Division Ave.
Marquette (49855)
Northwest Radio
1010 West Washington
Muskegon (49441)
Electronic Distributors, Inc.
1960 Peck Street
- MINNESOTA**
Duluth (55802)
Northwest Radio
123 E. First Street
Minneapolis (55401)
Electronic Center, Inc.
107-3rd Avenue N.
- MISSOURI**
Butler (64730)
Henry Radio
2111 North Main Street
Kansas City (64111)
Burstin Applebee Co.
3199 Mercier Street
St. Louis (63132)
Ham Radio Center
8342 Olive Blvd.
- MONTANA**
Great Falls (59401)
Electric City Radio Supply
2315 - 10th Avenue S.
- NEW HAMPSHIRE**
Concord (03301)
Evans Radio Inc.
Route 3A, Bow, Jct.
- NEW JERSEY**
Camden (08102)
General Radio Supply Co.
600 Penn St. at Bridge Plaza
Clifton (07011)
Wittie Electric Co., Inc.
384 Liberty Avenue
Eatontown (07724)
Atkinson & Smith Inc.
17 Lewis Street
- NEW MEXICO**
Albuquerque (87108)
Bowden Associates
730 San Mateo Blvd. S.E.
- NEW YORK**
Amsterdam (12010)
Adirondack Radio Supply
185-191 W. Main Street
Elmira (14901)
Chemung Electronics
601 E. Church Street
Farmingdale (11735)
Arrow Electronics Inc.
900 Broad Hollow Road
Harrison Radio
20 Smith Street
Lindenhurst (11757)
Delmar Electronics
280 N. Wellwood Ave.
New York
Barry Electronics
512 Broadway (10012)
Grand Central Radio Inc.
124 E. 44th St. at
Lexington Av. (10017)
- Harvey Radio Co.
2 West 45th St. (10036)
Rochester (14614)
Rochester Radio Supply
140 W. Main Street
Syosset (11791)
Lafayette Radio Corp.
111 Jericho Turnpike
Williamsville (14221)
Hirsch Sales Company
219 California Drive
- NORTH CAROLINA**
Asheville (28801)
Frecko Radio Supply
38 Baltimore Ave.
- OHIO**
Cincinnati
Queen City Electronics
1583 McKim Av. (45231)
United Radio Inc.
Summit & Reinhold Dr. (45237)
Cleveland (44112)
Amateur Electronic Supply
17929 Euclid Avenue
Columbus (43215)
Universal Service
114 N. Third Street
Dayton (45404)
Spreco Electronics
314 Leo Street
Toledo (43624)
Warren Radio Co.
1002 Adams Street
Youngstown (44507)
- OKLAHOMA**
Tulsa (74119)
Radio, Inc.
1000 S. Main Street
- OREGON**
Albany (97321)
Oregon Ham Sales
409 W. First Avenue
Portland (97205)
Portland Radio Supply Co.
1234 S. W. Stark
- PENNSYLVANIA**
Drexel Hill (19026)
Kas Electronics
2502 Township Line Road
Pittsburgh (15222)
Cameradio
2801 Liberty Avenue
Tybitts Company
933 Liberty Avenue
Treves (19047)
Treves Electronics
4033 Brownsville Road
Willow Grove (19090)
Ham Buerger, Inc.
80 N. York Road
- RHODE ISLAND**
Warwick (02888)
W. H. Edwards Co.
55 Electronics Drive
- SOUTH CAROLINA**
Columbia (29201)
Dixie Radio Supply
1900 Barnwell Street
- SOUTH DAKOTA**
Watertown (57201)
Stan Burghardt
315 Tenth Avenue N. W.
- TENNESSEE**
Memphis (38108)
Custom Builders
1566 Stacy Street
Knoxville (37901)
Bondurant Brothers
906 Sevier Avenue
- Nashville (37203)
Electra Distributing Co.
1914 W. End Avenue
- TEXAS**
Dallas (75204)
Electronic Center, Inc.
2929 N. Haskell
Fort Worth (76110)
Ed Juge Electronics
3850 South Freeway
Houston (77002)
Madison Electronics Supply
1508 McKinney
- UTAH**
Salt Lake City (84115)
Manwill Supply Co.
2511 S. State Street
- VIRGINIA**
Annandale (22003)
Arcade Electronics
7048 Columbia Pike
Norfolk (23509)
Priest Electronics
6431 Tidewater Dr.
Richmond (23225)
Electronic Equipment Co.
6540 Midlothian Turnpike
Roanoke (24016)
Radio Communications Co.
311 Shenandoah Avenue N. W.
Sandston (23150)
A. & F. Electronics
Rt. #1 La France Rd.
- WASHINGTON**
Seattle (98108)
Radio Supply Company
6213 - 13th Avenue South
Spokane (99206)
HCJ Electronics
E. 8214 Sprague
Tacoma (98402)
C & G Electronics
2502 Jefferson Avenue
- WISCONSIN**
Madison (53713)
Satterfield Electronics
1900 S. Park
Milwaukee (53216)
Amateur Electronic Supply
4828 W. Fond Du Lac Ave.
- PUERTO RICO**
Hato Rey (00918)
Jose Arturo Fernandez
208 Eleanor Roosevelt St.
- CANADA**
Alberta
Edmonton
Audiocom Electronics
10173 - 104th Street
British Columbia
Vancouver 9
Rendel Paret Electronics Ltd.
2048 W. 4th Avenue
Manitoba
Winnipeg
Cam Gard Supply Ltd.
397 William Avenue
Ontario
Toronto 590
Ray Hunter & Assoc.
7 Westrose Ave.
London
C. M. Peterson Co. Ltd.
575 Dundas Street E.
Quebec
Montreal 101
Payette Radio Ltd.
730 St. Jacques

R. L. DRAKE COMPANY



DRAKE

540 Richard St., Miamisburg, Ohio 45342
Phone: (513) 866-2421 • Telex: 288-017

new products

alpha 77 linear amplifier



The Alpha 77 Linear power amplifier has several new design features which have been added since the unit was originally released. The new Alpha 77 now uses an air-cooled Eimac 8877/3CX1500A7 ceramic-metal triode with 4000 volts on the plate. This power tube has a conservative 1500 watts of plate dissipation and requires only 65 watts drive for full legal amateur power input.

Also new in the Alpha 77 is a grid excess-current relay which will kick out if the final tube is under-loaded or over-driven. This protects the tube and the input circuit. Primary power requirements for the amplifier are now 120/240 volts at 50/60 Hz, single phase, making the unit compatible with overseas power sources.

The Alpha 77 is designed and rated at 3000 watts PEP continuous commercial

service and is available to amateurs who demand the ultimate in every respect; it loafs along at 2000 watts PEP. The Alpha 77 features a rugged bandswitch with 20-amp silver contacts, vacuum-variable tuning capacitor, silent vacuum relays, quiet forced-air cooling and metering in all circuits. The massive plate coil is silver soldered and heavily silver plated for efficiency. Husky toroid coils minimize coupling between pi-L network sections.

The Alpha 77 Power amplifier is built like a battleship with ¼-inch thick aluminum sides, and weighs in at 70 pounds. Modular assembly is used throughout so that the power supply, rf deck and control panel are easily removable. Second harmonic output is typically -50 dB, and the third-order intermodulation products are -35 dB below peak output. The Alpha 77 is manufactured by Ehrhorn Technological Operations, Inc., and distributed by Payne Radio, Box 525, Springfield, Tennessee 37172. For more information, use *check-off* on page 126.

two-meter portable antenna

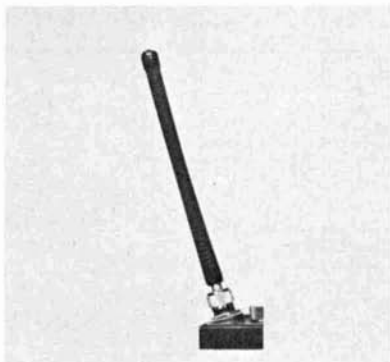

A new industrial type, continuously-loaded vhf portable antenna has been added to Antenna Specialists' high-performance amateur line. The new Antenna Specialists HM-5, designed to withstand the rough handling that makes telescopes impractical, is completely insulated and cannot accidentally be shorted out. It features a connector fitting that attaches directly to portable equipment with SO-

239 connectors. Power rating is 25 watts with nominal input impedance of 50 ohms. A companion model, the HM-4, is identical except for a standard 5/16-32 threaded-male mounting base. Both models are available from amateur distributors at a suggested ham net price of \$5.95. For additional specifications, write to Amateur Department, The Antenna Specialists Company, 12435 Euclid Avenue, Cleveland, Ohio 44106 or use *check-off* on page 126.

palomar balun

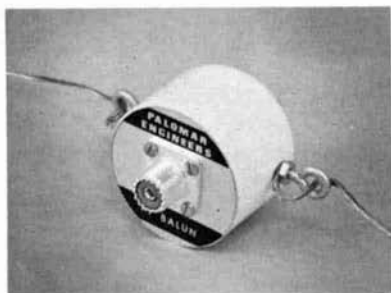

Palomar Engineers has announced a new 1:1 Balun. It matches 50- or 75-ohm coaxial cable to center-fed dipole or inverted-vee antennas. By preventing radiation from the coax, a balun improves the antenna radiation pattern, reduces noise on receive, and helps prevent tv, bci and rf feedback within the station.

The Palomar Balun transformer is wound on a large ferrite toroid core and handles a full kilowatt from 1.7 to 30 MHz. The transformer is enclosed in a white plastic housing and is completely encapsulated to prevent moisture from entering. All hardware is stainless steel.

Eye bolts on the sides allow the balun to replace the center insulator of the antenna, and an eye bolt on top can be used to support the antenna. The balun is a compact 2 1/4 inch in diameter and 2 inches high. The unit is priced at \$12.95 postpaid in the United States and Canada (plus 5% tax in California). A descriptive brochure is available. For more information, write to Palomar Engineers, Box 455, Escondido, California 92025 or use *check-off* on page 126.

DIODES

PIV	TOP-HAT		STUD-MOUNT	
	1.5 AMP	1.5 AMP	3 AMP	6 AMP
50	.04	.06	.12	.15
100	.06	.08	.16	.20
200	.08	.10	.20	.25
400	.12	.14	.28	.50
600	.14	.16	.32	.58
800		.20	.40	.65
1000		.24	.48	.75

**FACTORY NEW
COMPUTER GRADE CAPACITORS**



10,000 MFD @ 40 Volts. Size is 2" dia. x 3" high. Just right for that power supply. \$1.75 ea. or 3 for \$4.50 ppd.

1 AMP MOLDED BRIDGE RECTIFIER



200 Volt PIV Small Size — Manufactured By General Instrument. Ideal For P.C. Board. 50¢ Each, 3 For \$1.25 ppd.

18" CORD PATCH

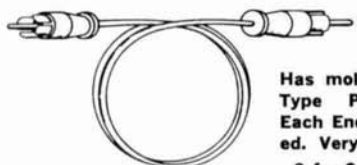

Has molded RCA Type Plug On Each End. Shielded. Very Nice. 3 for \$1.00 ppd.

TOROIDS-UNPOTTED

88 or 44 MHY

YOUR CHOICE — EITHER TYPE



5 for \$2.00 ppd.

AMERICAN MADE PILOT LIGHT

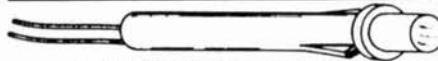

1/4 inch diameter. Made to work directly from 115 volts AC made to push fit in 5/16 inch hole, no hardware needed. 50¢ ea. ppd.

1 1/2 INCH SPEAKER



*8 Ohm V.C. Very nice. 50¢ ea. ppd.

115 VOLT AC TRANSFORMER



Secondary 12-0-12 Volts @ 800 ma. Very Nice. \$2.40 ea. ppd.

Power Transformer. 115 Volt AC Primary.

Secondary #1: 32-0-32 Volt @ 1 Amp.

Secondary #2: 6.3 Volts. Low Current For Pilot Lights. Size 2 1/2" x 2 1/2" x 3".

Price: \$2.50 Each ppd.

6.3 Volt 1 Amp Transformer. Fully Shielded

\$1.60 Each ppd.

m. weinschenker
K 3DPJ BOX 353 · IRWIN, PA. 15642



**LATEST SIGNAL/ONE CX7A
IN STOCK FOR IMMEDIATE SHIPMENT
WRITE FOR 4 PAGE BROCHURE**

DRAKE

SPR-4	new, \$579.00
TR4/C	new, \$599.95
AC4	new, \$ 99.95
MS4	new, \$ 22.00
W4	new, \$ 61.95
TR22	new, \$199.95
ML2	new, \$299.95
TV 1000 - LP	\$ 18.75
AA-10 10 Watt FM Amplifier	new, \$ 49.95
AC-10 Power Supply	\$ 39.95
SC-2 2 meter converter, SC-6 6 meter converter, CPS-1 power supply, SCC-1 calibrator all in CC-1 console.	30% off net

TEN TEC

ARGONAUT MODEL 505	new, \$288.00
210 POWER SUPPLY	new, \$ 24.95
ARGONAUT 405 LINEAR AMP. 50 watts out	new, \$149.00
250 POWER SUPPLY, powers 505 & 405	new, \$ 49.00
TX100	new, \$109.95
RX10	new, \$ 59.95
AC4	new, \$ 14.95
KR1	new, \$ 18.95
KR2	new, \$ 12.95
KR5	new, \$ 34.95
KR20	new, \$ 59.95
KR40	new, \$ 89.95
Microphone	\$ 17.00
PM2B	\$ 64.95
PM3A	\$ 79.95

COLLINS

KWM2 with 516F2	good, \$625.00
MP1 mobile supply	good, \$ 95.00
351D2 mobile mount	fair, \$ 65.00
DL1 Dummy Load	good, \$ 49.95
30L1 spare parts kit less chassis/cab. etc.	\$ 99.00
KWM-1 w/516-F1	\$395.00
51J-4 Deluxe all band revr	\$395.00
75S-3 Receiver	\$345.00
75A4 Receiver, lab certified	excel., \$350.00

HALLICRAFTERS

SX-122A	reg \$550 net, new cond., \$375.00
HT-32A	\$195.00
FPM-300	new, \$595.00

LINEAR SYSTEMS

SB-36 5 Band 500W SSB/CW Digital readout transceiver complete with AC power supply	new, \$969.95
--	---------------

INSTRUMENTS

HP 415CR SWR METER	good, \$ 65.00
HP 430CR POWER METER	good, \$ 65.00
HP 130C 200uV SCOPE	mint, \$225.00
GR 1001A SIGNAL GEN	mint, \$595.00
HEATH 10-18 SCOPE	mint, \$ 85.00
DUMONT 304H DUAL BEAM SCOPE	ok, \$125.00
HEATH IP-17 POWER SUPPLY	ok, \$ 64.95
HEATH IG-82 GENERATOR	good, \$ 40.00
HICKOK 455 VOM	good, \$ 39.00
BOONTON AM/FM GEN	good, \$250.00
HP DY5003 XBAND TEST SET	excl. \$350.00
HP 540B TRANSFER OSC	good, \$275.00
HP 685A H BAND OSC	good, \$225.00
GR 1208A UNIT OSC	good, \$ 95.00
HP 416A RATIONOMETER	good, \$195.00
HP 492A TWT AMPLIFIER	good, \$125.00
HP KS19353 TELEPHONE TEST OSC	mint, \$225.00
DIGIPET 60 with 160 scaler. Range 1 kHz - 160 MHz	\$349.00
TEKTRONIC 316-S1 3" scope same as model 317. To 15MHz with probe	\$225.00
HP ATTENUATORS, 1/2 W, 50Ω, DC 1000 MHz	Model 355C like new, \$ 75.00
Model 355D	like new, \$ 75.00
FR-114U 6 digit E-put meter, frequency .1 - 10k, .0001 to 10 sec.	like new, \$25.00

12 VOLT DC POWER SUPPLIES: 110 AC INPUT

MODEL 102, is a 4 amp overload protected power supply that automatically resets itself when the overload is removed new, \$24.95

MODEL 104R, is a regulated power supply with the same electronic overload protection as the model 102. MODEL 104R new, \$34.95

MODEL 107M is a heavier duty supply with the same features as the 10w but puts out 6 amps new, \$27.95

INVERTER/CONVERTER:

MODEL 612 is a special purpose unit to provide 12 VDC negative ground power in automobiles with either 6 volt negative ground or 12 volt positive ground. 10 amp surge, 3 amp continuous new, \$22.95

HONEYWELL

0-25 VDC Voltmeter	new, \$3.95
--------------------	-------------

MISC.

AUTRONIC KEYS	new demo, \$ 69.50
JOHNSON KW MATCHBOX	excel., \$ 90.00
without coupler (swr)	
2 METER VHF DUMMY LOAD/WATTMETER	Good up to 15 watts — w/SO-239 CONNECTOR \$19.95

CASH PAID . . . FAST! For your unused TUBES, Semiconductors, RECEIVERS, VAC. VARIABLES, Test Equipment, ETC. Write or call Now! Barry, W2LN1. We Buy!

We ship all over the World. DX Hams only. See Barry for the new Alpha 77.

Send 35¢ for 104 page catalog #20.

BARRY ELECTRONICS CORP.

DEPT. H-12 — PHONE A/C 212-925-7000
512 BROADWAY, NEW YORK, N. Y. 10012

Even more from BARRY

ANTENNAS

2M MAGNETIC MOUNT w/RG58 & PL259	\$ 9.95
AR-2 RINGO	\$ 13.50
AR-25 RINGO (KW RINGO)	\$ 17.50
DI-2 DIPLOMAT	\$ 13.35
14AVQ/WB VERTICAL	\$ 47.95
18AVT/WB VERTICAL	\$ 69.95
TH3MK3 10/15/20 Beam Super Thunderbird	\$144.95
A144-7 2 METER BEAM	\$ 13.95
All of the above antennas are in stock here. In addition, we can order any antenna made by Antenna Specialists, Cush Craft, Hy Gain, Mosley, Newtronics or Gam.	
C.D. HAM "M" ROTATORS, new, complete	\$99.95
HAM "M" CABLE @ 12c/ft.	
C.D. TR-44 ROTATORS, new, complete	\$63.95
CABLE FOR TR-44	6c/ft.
RG-8A/U 100 ft. rolls, VHF connector PL-259 one end Type "N" (UG-21E/U) other end	\$ 12.50
RG8A/U — 65 feet with PL-259	
CONNECTORS ON EACH END	\$9.50

DX ENGINEERING SPEECH COMPRESSORS

DIRECT PLUG-IN FOR COLLINS 32S	\$79.50
DIRECT PLUG-IN FOR KWM — 2	\$79.50
DIRECT PLUG-IN FOR DRAKE TR3 OR DRAKE TR4	\$98.50

BIRD

4350 80-10M 2KW Ham Mate	\$ 79.00
4351 80-10M 1KW Ham Mate	\$ 79.00
4352 6-2M 400W Ham Mate	\$ 79.00
43 Wattmeter	\$100.00
(Write for quote on slugs)	
81 50 W Dummy Load	Fair \$ 49.95
74 Coaxswitch SP6T	New Surplus \$ 37.50
72-R Reversing Switch	New Surplus \$ 37.50

Mor-Gain Antenna Distributor Write for Details

Overseas friends, Barry can demonstrate and help you with the purchase of **ROBOT SSVT Gear**. Write or drop in when you are in NYC.

500 PIV 12 Amp Diodes 75¢

BARKER & WILLIAMSON

Dummy Load - Wattmeters - 52Ω 334A DC - 300 MHz, 1000 watts int.	\$139.95
374 DC - 230 MHz, 1500 watt	\$169.95
333 DC - 300 MHz, 250 watt int.	\$ 79.95
Transistorized Little Dipper, battery operated, 2 MHz-230 MHz continuous ±3% accuracy with modulation	\$ 94.50
ARRL B & W Kits, all available from Barry	
850A, 852 Inductors	\$ 59.95
851 Inductor	\$ 29.95
FC-15A Filament choke	\$ 17.95
FC-30A Filament choke	\$ 21.95
FC-25A Filament choke	\$ 9.95
RF Plate choke 90 μ H, 2500 VDC, 500 MA	\$ 5.49

B & W PARTS — RF Filters, Plug-in Inductors, Auto Match auto antennas, Air Wound Coils, Miniductors, Toroid Inductors, Protax auto grounding coax switches.

Write for Deluxe B & W Catalog.

BUILDERS!

Barry has lots of Millen and National parts in stock.

Write for Barry's latest Green Sheet.

TAKE YOUR PICK



By far the most popular manual in the radio industry for amateurs, electronics engineers, and technicians.

LATEST HOW-TO-BUILD DATA

The Radio Handbook contains authoritative, detailed instructions for designing, building, and operating all types of radiocommunications equipment.

AN IMPORTANT REFERENCE

It provides a complete understanding of the theory and construction of all modern circuitry, semiconductors, antennas, power supplies, full data on workshop practice, test equipment, radio math, and calculations.

18th Edition Only \$7.95

19th Edition \$14.95

(Just Issued)

All prices postpaid

Here is your chance to fill an important slot in your technical library.

We have a limited supply of 18th editions at an excellent price for you bargain hunters and a good supply of 19th editions for those who wish the very latest.

Either way it's an excellent opportunity that you should not miss.

order today from

comtec

BOOKS

Greenville, New Hampshire 03048

G&G CATALOG MILITARY ELECTRONICS

24 PAGES, crammed with Gov't Surplus Electronic Gear - the Biggest Bargain Buys in America! It will pay you to **SEND 25¢** for your copy - Refunded with your first order.

BRAND NEW BC-645 TRANSCEIVER

EASILY CONVERTED FOR 420MC OPERATION
This equipment originally cost over \$1000. You get all in original factory carton.



Dependable Two Way Communication more than 15 miles.

- FREQUENCY RANGE: About 435 to 500 Megacycles.
- TRANSMITTER has 4 tubes: WE-316A, 2-6F6, 7F7.
- RECEIVER has 11 tubes: 2-955, 4-7H7, 2-7E6, 3-7F7.
- RECEIVER I. F.: 40 Megacycles.
- SIZE: 10 1/2" x 13 1/2" x 4 1/2".

Makes wonderful mobile or fixed rig for 420 to 500 Mc. Easily converted for phone or CW operation

"SPECIAL PACKAGE OFFER"

BC-645 Transceiver, Dynamotor and all accessories below, including conversion instructions for Citizens Band. **BRAND NEW, white stocks last. \$26.95**

F.O.B. NY City or Ogden, UT for Savings on Freight Charges.

Accessories for BC-645
Mounting for BC-645 transceiver
PE-101C Dynamotor, 12-24 V (easily converted to 6 volts).
Mounting for PE-101C Dyna-

motor
UHF Antenna assemblies (set of 2)
Complete set of 11 connectors
Control Box BC-646
Mounting for BC-646 ctr. box.

TRANSCEIVER ONLY \$16.95

AN/APR-4Y FM & AM RECEIVER

"FB" for Satellite Tracking!
High precision lab instrument, for monitoring and measuring frequency and relative signal strength, 38 to 4000 Mc. In 5 tuning ranges. For 110v 60 cycle AC. Built-in power supply. Original circuit diagram included. Checked out, Perfect.



LIKE NEW \$88.50
All tuning units available for above. Price upon request.

CRT AGEING & CHECKING TESTER

\$6.95



WILLARD 2-VOLT STORAGE BATTERY (Model 20-2)

Rated at 20 ampere hours. Compact, rechargeable, fine for models.

\$2.79



BC-1206-C RECEIVER Aircraft Beacon Receiver

200 to 400 Kc. Operates from 24V DC 1.5A. Continuous tuning, vol control, on-off switch and phone jack. Very sensitive. Compact. Complete with tubes, NEW..... **\$12.50**



BC-348 Radio Receiver	\$69.50
BC-312 Radio Receiver	\$69.50
AN/ARN-7 Receiver	\$19.50

ARR-1 OSCILLATOR (GOLD-PLATED SPECIAL) \$4.25

ARC-R11A Modern Q-5 Receiver 190 - 550 KHz	\$10.95
ARC-R22 540 - 1600 KHz Receiver with tuning graph	\$15.95
R-4/ARR-2 Receiver 234-258 Mhz, 11 tubes, NEW	\$8.95

BC-605 INTERPHONE AMPLIFIER, NEW \$3.45 EXC. USED \$1.95
TELEPHONE HANDSET, W.E. type. LIKE NEW \$2.95

ID-93/APG-13 INDICATOR SCOPE UNIT
Operating voltage is taken from the PO-43A power inverter. All controls are mounted on front panel. Uses a 3BP1 Cathode Ray Tube, and 5/6SN7, 2/6H6, 1/2X2, 1/5Y3. Complete, NEW \$16.50

TG-34A CODE KEYS, self-contained, automatic, reproduces code practice signals from paper tape. 5 to 12 WPM Built-in speaker. Brand new with tech manual. takeup reel and AC line cord. ... **\$24.50**
Code practice tapes for above P.U.R.



TELEGRAPH SET FOR CODE COMMUNICATIONS OR CODE PRACTICE

Portable with hinged lid. Complete with Headset. Weight 10 lbs. **New \$8.95**

SCR-274-N, ARC-5 COMMAND SET HQ!

Freq. Range	Type Complete with Tubes	Exc. Used	Like New	BRAND NEW
190-550 Kc	BC-453	\$16.95	\$23.50	
6-9.1 Mc	BC-455	—	\$18.50	
1.5-3 Mc	R-25	—	\$19.50	\$21.50
TRANSMITTERS				
4-5.3 Mc	BC-457	\$8.95	—	\$11.95
5-3.7 Mc	BC-458	\$8.95	—	\$11.95
7-9.1 Mc	BC-459	—	\$22.50	

ARC-5 VHF RECEIVER, TRANSMITTER, MODULATOR 100-156 Mhz

R-28 RECEIVER with tubes and crystal. Excellent Used..... **\$19.50**
T-23 TRANSMITTER with tubes and crystals. Brand New in Original Carton..... **\$23.50**
MD-7 MODULATOR with tubes, Excellent Used **\$10.50**
Set of Plugs for MD-7..... \$ 8.50

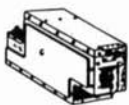

HANDMIKE

Rugged, heavy-duty carbon hand mike with press-to-talk switch. Equipped with 4-ft cord & phone plug. SPECIAL
NEW, boxed..... Each **\$1.88** 2 for \$3.25



HEADSET Low impedance. With large chamois ear cushions.

4-ft cord and plug. Reg. \$12.50. Our Special Price **\$2.95**
Less ear cushions..... \$1.95
High impedance adaptor for above... \$.69



SCR-522 TRANSMITTER/RECEIVER

Designed to operate from 100 to 156 mc. This unit makes fine 2-meter rig for 2-way mobile radio! Both units can be removed from case separately. Complete with 18 tubes.



LIKE NEW **\$36.50**

SCR-625 ARMY MINE DETECTOR \$44.50

BC-659 FM TRANSMITTER/RECEIVER

27 to 38.9 Mc. Crystal control on any 2 pre-selected channels, 80 channels. Uses FT-243 Crystal; 13 tubes: (1) LH4, (1) LC6, (4) 1LN5, (2) 1291, (4) 1299 & (1) 1291. New and complete with tubes, speaker and meter.



BRAND NEW **\$27.50**

APN-1 FM TRANSCEIVER 400-450 Mc.

Freq. modulated by moving coil transducer. Easily converted for radio control or 70 cms. Complete with 14 tubes, dyn. BRAND NEW **\$9.95**



LM FREQUENCY METER

Fine general purpose Navy unit 125 to 20,000 Hz. Operates on 12 or 24 VDC. Complete with tubes, crystal, calibration book. Checked out, Excellent Used **\$59.50**
As above, less book \$22.50



CATHODE RAY TUBES All New in Original Carton

STANDARD MAKE

5AP1 ... 3.75 ea.	5MP1 ... 2.75 ea.
	9GP7 ... 3.95 ea.
3" SHIELD 1.75	5" SHIELD 3.95



TERMS: F.O.B. NYC, 25% deposit with order, balance COD or remittance in full. MINIMUM ORDER \$5.00. Subject to prior sale and price change

G&G RADIO ELECTRONICS COMPANY

45-47 Warren St. (2nd Fl.) New York, N.Y. 10007 Ph. 212-267-4605

The Argonaut has a stalwart new companion—a Solid State Linear!



Model 505 Argonaut
A Complete Low Power Transceiver,
10-80 Meters

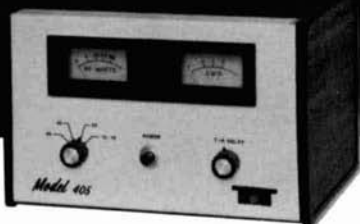

Model 405 Linear
For Medium Power,
10-80 Meters

Here is the ultimate in station flexibility—The Argonaut plus the new Model 405 solid state linear amplifier. Now, you can enjoy the fun and extreme portability of QRP yet increase power 25 times by adding the "405" amplifier — simply and easily.

The "405", with less than 2 watts RF input, produces 50 clean sine wave watts to the antenna. Yet, it retains utter simplicity in installation, operation and tuning.

With the "405" there is no "tune-up". Just select the desired band. That's all. Change bands in seconds with no danger to the final amplifier. Even with the wrong antenna.

Two meters constantly monitor the output in RF watts and SWR. No switches or controls to delay band changing.

The antenna changeover is exciter actuated with front panel time delay control. It can be set for nearly instant CW break-in or optimum hold time for SSB.

The portability of the "405" is unequaled. Weight is just 2½ pounds and the size 4½" x 7" x 8". The power supply for 115/230 VAC is about the same size and weighs 8 pounds. It is a separate unit so it need not be included in a mobile installation or where 12 VDC is available.

The "405" will retain its stamina for the years ahead. Computer estimated life of the output transistors is 25.7 years. That's a lot of QSOs, a lot of fun and excitement.

TEN-TEC products are sold by selected dealers. If one is in your trading area, by all means patronize him. It will help you and Amateur Radio. However, if it is more convenient, send your order directly to us. Include \$2.00 for shipping. (Tennessee residents include 5% sales tax.) Write for catalog and specifications.

Argonaut, Model 505	\$288.00
Linear Amplifier, Model 405	149.00
Power Supply, Model 250	
(Will supply both units)	49.00
Power Supply, Model 210 (Will	
power Argonaut only)	24.95
Microphone, Model 215	17.00
Keyer, Model KR5/605	34.95

TEN-TEC, INC.
SEVIERVILLE, TENNESSEE 37862



**RTTY
FACSIMILE SUPPLIES**

60 SPEED GEARS
for model 15-19
(74912-74913)
\$3.50 set—postpaid

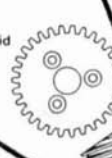

FRESH TAPE
11/16 wide / red or yellow
\$8.00 case—40 rolls



FRESH NYLON RIBBONS
for 14-15-19-28-32 mite mach.
All black or red-black
\$3.50 box—postpaid



TOROIDS
88 or 44 mhy: unpotted
30—\$10.00 postpaid
(5—\$2.50) no Canadian



MINIATURE MITE
Page Printer
Ready to use, with cables
Reconditioned—60 or 100 wpm
\$200.00



14 TYPING REPERFORATOR
Clean—reconditioned
RO \$35.00 (no KB)
KSR \$50.00 (with KB)



Reconditioned Model 32's
Excellent—Complete
KSR \$250.00 ASR \$375.00



TXC1 Facsimile Transceiver
Fun to copy weather maps, etc.
Excellent—with manual.
\$100.00



28 TYPING UNIT
Late LP6/LP9
Reconditioned \$95.00



DESKFAX 6500
(As in QST—May, 1972)
As-is, working, comp.
\$15.00—2/\$25.00



FAX PAPER
Pkg. 250 sheets, \$3.00 / case (5 pkg.) \$12.00

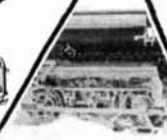

• Immediate shipment on small items. • Good work takes time . . . we recondition machines to order, allow 3-4 weeks . . . SASE for more info.



send stamp for picture catalog

VAN'S W2DLT ELECTRONICS
302H Passaic Ave., STIRLING, N.J. 07980
Phone: 201-647-3639
Div. of Teletypewriter Communication Specialists



CRYSTAL BARGAINS

Depend on . . .

We supply crystals from 16kHz to 100MHz. Over 6 million crystals in stock.

SPECIAL

Crystals for most amateur 2-Meter F.M. Transceivers:

\$3.75 Each

Inquire about quantity prices. Order direct. Send check or money order.

For first class mail add 15¢ per crystal...for airmail add 20¢ ea.

SPECIALS! CRYSTALS FOR:

Frequency Standards	
100 KHz. (HC13/U)	\$4.50
1000 KHz. (HC6/U)	4.50
Almost All CB Sets, Trans. or Rec. (CB Synthesizer Crystal on request)	2.50
Any Amateur Band in FT-243 (Except 80 meters)	4 for 5.00
80 Meter Range in FT-243	2.50
Color TV 3579.545 KHz. (wire leads)	1.60
	4 for 5.00



DIVISION OF BOB WHAN & SON ELECTRONICS, INC.

2400 Crystal Dr.
Fort Myers
Florida 33901
(813) 936-2397

Send 10¢ for new catalog with oscillator circuits and lists of thousands of frequencies in stock.



**Radio Amateurs
Reference Library
of Maps and Atlas**

WORLD PREFIX MAP — Full color, 40" x 28", shows prefixes on each country . . . DX zones, time zones, cities, cross referenced tables postpaid **\$1.25**

RADIO AMATEURS GREAT CIRCLE CHART OF THE WORLD — from the center of the United States! Full color, 30" x 25", listing Great Circle bearings in degrees for six major U.S. cities: Boston, Washington, D. C., Miami, Seattle, San Francisco & Los Angeles. postpaid **\$1.25**

RADIO AMATEURS MAP OF NORTH AMERICA! Full color, 30" x 25" — includes Central America and the Caribbean to the equator, showing call areas, zone boundaries, prefixes and time zones, FCC frequency chart, plus informative information on each of the 50 United States and other Countries. postpaid **\$1.25**

WORLD ATLAS — Only atlas compiled for radio amateurs. Packed with world-wide information — includes 11 maps, in 4 colors with zone boundaries and country prefixes on each map. Also includes a polar projection map of the world plus a map of the Antarctica — a complete set of maps of the world. 20 pages. size 8 3/4" x 12" postpaid **\$2.50**

Complete reference library of maps — set of 4 as listed above postpaid **\$3.75**

See your favorite dealer or order direct.

WRITE FOR FREE BROCHURE!

RADIO AMATEUR callbook INC.

Dept. E 925 Sherwood Drive
Lake Bluff, Ill. 60044

CW or RTTY, whichever way you go,
**HAL HAS TOP QUALITY
 YOU CAN AFFORD!**



TOP QUALITY RTTY... WITH THE HAL MAINLINE ST-6 TU. Only 7 HAL circuit boards (drilled G10 glass) for all features, plug-in IC sockets, and custom Thordarson transformer for both supplies, 115/230 V, 50-60 Hz. Kit without cabinet, only \$135.00; screened, punched cabinet with pre-drilled connector rails, \$35.00; boards and complete manual, \$19.50; wired and tested units, only \$280.00 (with AK-1, \$320.00).*



TOP QUALITY... WITH THE HAL 1550 ELECTRONIC KEYSER. Designed for easy operation; perfectly timed CW with optional automatic ID for sending call letters, great for DX and RTTY; TTL circuitry, transistor switching for grid block, cathode keying. Handsome rugged crackle cabinet with brushed aluminum panel. With ID, only \$90.00; without ID, \$65.00.*

OTHER HAL PRODUCTS INCLUDE:

- ID-1 Repeater Identifier (wired circuit board) . . . \$ 75.00*
- ID-1 (completely assembled in 1½" rack cabinet) . . . \$115.00*
- HAL ARRL FM Transmitter Kit . . . \$ 50.00*
- W3FFG SSTV Converter Kit . . . \$ 55.00*
- Mainline ST-5 TU Kit . . . \$ 50.00*
- Mainline AK-1 AFSK Kit . . . \$ 27.50*



TOP QUALITY... WITH THE HAL MKB-1 MORSE KEYBOARD.

As easy as typing a letter—you get automatic CW with variable speed and weight, internal audio oscillator with volume and tone controls, internal speaker, and audio output jack. Smooth operation; completely solid-state, TTL circuitry using G10 glass boards, regulated power supplies, and high voltage transistor switch. Optional automatic ID available. Assembled MKB-1, \$275.00. In kit form, \$175.00.*



NEW FROM HAL—TOP QUALITY RVD-1002 RTTY VIDEO DISPLAY UNIT. Revolutionary approach to amateur RTTY . . . provides visual display of received RTTY signal from any TU, at four speeds (60, 66, 75, and 100 WPM), using a TV receiver modified for video monitoring. Panasonic solid-state TV receiver/monitor, or monitor only, available. RVD-1002, \$525.00; Panasonic TV receiver/monitor, \$160.00; monitor only, \$140.00.*

TOP QUALITY... WITH THE HAL RKB-1 TTY KEYBOARD. Gives you typewriter-easy operation with automatic letter/number shift at four speeds (60, 66, 75, and 100 WPM). Use with RVD-1002 video display system, or insert in loop of any teleprinter, for fast and easy RTTY. Completely solid state, TTL circuitry using G10 glass boards, regulated power supplies, and transistor loop switch. RKB-1 assembled, only \$275.00.*

HAL provides a complete line of components, semi-conductors, and IC's to fill practically any construction need. Send 24¢ to cover postage for catalog with info and photos on all HAL products available.

*Above prices do not include shipping costs. Please add 75¢ on parts orders, \$2.00 on larger kits. Shipping via UPS whenever possible; therefore, street address required.

HAL COMMUNICATIONS CORP., Box 365 H, Urbana, Illinois 61801

KW107

It's beautiful!

\$134.95

SUPERMatch

Ppd in USA & Canada
Money back Guarantee

- * E-Z Match Tuner
- * SWR Meter
- * Power Meter
- * Dummy Load
- * Antenna Switch
- * 350 watts PEP

Clean up the unsightly tangle of wires around the shack and your wife will think it's beautiful



KW Electronics

10 Peru St. Plattsburgh, New York 12901
In Canada: 222 Newkirk Road,
Richmond Hill, Ontario

Send for FREE Literature



NEW for HR-2 SCAN-2 with search back

SCAN-2 IS DESIGNED TO PLUG INTO HR-2 CRYSTAL SOCKET. ONLY NECESSARY WIRING NEEDED IS GROUND A+ AND SQUELCH SWITCH LEAD. PARTS INCLUDE TWO UNIJUNCTION TRANSISTORS, TWO NPN SILICON TRANSISTORS, ONE I.C. AND THREE SILICON DIODES. IT IS ON A 2 1/2 X 1 1/2 PC BOARD. UNIT SCANS TWO FREQUENCIES TWENTY TIMES A SECOND. SEARCH BACK FEATURE ALLOWS OPPOSITE CHANNEL TO BE SCANNED ONCE EVERY FIVE SECONDS FROM THE ONE THAT IS LOCKED ON BY A SIGNAL. THIS FEATURE CAN BE SWITCHED IN AND OUT. WIRED.....\$19.95

6T-HR2 IS DESIGNED TO ADD SIX MORE TRANSMIT FREQUENCIES TO HR-2 OR HR-2A. KIT.....\$ 9.95
WIRED.....\$13.95

HF-144U RF PREAMPLIFIER (MOS-FET)
TYPICAL GAIN 17db with 3db NOISE
FIGURE. KIT.....\$11.95
WIRED.....\$17.95

HF-144M (MOTRAC PRE-AMP)
WIRED.....\$17.95

WAHL "ISO-TIP" CORDLESS SOLDERING
IRON COMES WITH CHARGER.....\$19.95

SPECIAL HR-2A or HR-212 WITH SCAN-2
AND PRE-AMP INCLUDED. HR-2A...\$229.95
HR-212...\$259.95

PRICES
INCLUDES
SHIPPING



400% MORE AVERAGE SSB POWER OUTPUT

USE A **MAGNUM SIX**
THE QUALITY R F SPEECH PROCESSOR



Collins, Heath \$129.95
Yaesu FT101..... \$139.95
Kenwood \$139.95

Add 5% Tax in Washington

- 4 TIMES THE SSB POWER ON ALL BANDS
- ADDED PUNCH FOR PILE-UPS
- EXCELLENT VOICE QUALITY
- SPLATTER FREE, NARROW BAND OUTPUT SIGNAL
- SOLID STATE DESIGN
- MORE ADDED POWER PER \$ THAN ANY OTHER METHOD

Send for FREE Brochure
Communication Technology Group
31218 Pacific Highway South
Federal Way, Washington 98002



A Division of Bittell Systems Inc.

Topeka FM Communications
1313 E. 18 Terr. Land Electronics
Topeka, Kansas 66607

Semiconductor Supermart

• MOTOROLA • RCA • FAIRCHILD • NATIONAL • HEP • PLESSEY •



Actual Size

DIGITAL READOUT

At a price everyone can afford **\$3.20**

- Operates from 5 VDC
- Same as TTL and DTL
- Will last 250,000 hours.

The MiniTRON readout is a miniature direct viewed incandescent filament (7-Segment) display in a 16-pin DIP with a hermetically sealed front lens. Size, and appearance are very similar to LED readouts. The big difference is in the price. Any color filter can be used.

INTRODUCING *NEW* DEVICES AT NEW LOW PRICES

LA3018 (replaces CA3018)	\$1.60
LA3046 (replaces CA3046)	\$1.60
LS370 (replaces LM370)	\$4.00
LS1496 (Improved MC1496)	\$2.00
LS3028A (replaces CA3028)	\$1.60
LP1000 (a new fun-type device to make LED flashers, audio osc, timer, etc.)	\$1.60

Coming soon the LP2000 Micro-transmitter in a 10-pin IC package.

NATIONAL DEVICES

LM370 AGC/Squelch amp	\$4.85
LM373 AM/FM/SSB IF strip/Det	\$4.85
LM309K 5V 1A regulator. If you are using TTL you need this one.	\$3.00

POPULAR IC's

MC1550 Motorola RF amp	\$1.80
CA3020 RCA 1/2 W audio	\$3.07
CA3020A RCA 1 audio	\$3.92
CA3028A RCA RF amp	\$1.77
CA3001 RCA	\$6.66
MC1306P Motorola 1/2 W audio	\$1.10
MC1350P High gain RF amp/IF amp	\$1.15
MC1357P FM IF amp Quadrature det	\$2.25
MC1496 Hard to find Bal. Mod.	\$3.25
MFC9020 Motorola 2-Watt audio	\$2.50
MFC4010 Multi-purpose wide-band amp.	\$1.25
MFC8040 Low noise preamp	\$1.50
MC1303P Dual Stereo preamp	\$2.75
MC1304P FM multiplexer stereo demod	\$4.95

FET's

MPF102 JFET	\$6.00
MPF105/2N5459 JFET	.96
MPF107/2N5486 JFET VHF/UHF	\$1.26
MPF121 Low-cost dual gate VHF RF	.85
MFE3007 Dual-gate	\$1.98
40673	\$1.75
3N140 Dual-gate	\$1.95
3N141 Dual-gate	\$1.86

MOTOROLA DIGITAL

MC724 Quad 2-input RTL Gate	\$1.00
MC788P Dual Buffer RTL	\$1.00
MC789P Hex Inverter RTL	\$1.00
MC790P Dual J-K Flip-flop	\$2.00
MC799P Dual Buffer RTL	\$1.00
MC780/880 RTL decade counter	\$3.00
MC1013P 85 MHz Flip-flop MECL	\$3.25

MOTOROLA TUNING DIODES

Silicon voltage variable capacitance diodes in TO-92 plastic case like plastic transistors. Both standard Motorola and HEP numbers are listed: devices are same. Capacitance value is typical at -4Vdc. Tuning ratio is approx. 3:1.

MV2101/R2500 6.8 pF	\$1.10
MV2103/R2501 10 pF	\$1.10
MV2105/R2502 15 pF	\$1.10
MV2109/R2503 33 pF	\$1.10
MV2112/R2504 56 pF	\$1.10
MV2115/R2505 100 pF	\$1.10

MORE RCA IC's

CA3088E AM rcvr subsystem	\$2.50
CA3089E FM IF system with circuits for IF amp., Det., AF preamp., AFC, Squelch, & tuning meter	\$3.90
CA3018 Transistor array	\$1.55

NEW FAIRCHILD ECL HIGH SPEED DIGITAL IC's

9528 Dual "D" FF toggles beyond 160MHz	\$4.65
9582 Multi-function gate & amplifier	\$3.15
95H90 300 MHz decade counter	\$16.00

A 95H90 & 9582 makes an excellent prescaler to extend low frequency counters to VHF — or use two 9528s for a 160 MHz prescaler.

Box 3047H, Scottsdale, AZ 85257

CIRCUIT SPECIALISTS CO.

Please add 35¢ for shipping

FACTORY AUTHORIZED

HEP-CIRCUIT-STIK

DISTRIBUTOR

short circuits

mobile touch-tone

In the article on mobile Touch-Tone operation in the August, 1972, issue, page 60, the capacitor and resistor across relay K1 can cause immediate failure of the transistor due to excessive current flow. When the transistor is first turned on, and the capacitor is not charged, current flow is about 500 mA since the 22-ohm resistor is the only thing that limits current. WB8NAT has suggested a modification which places the time-constant capacitor in the base circuit of the tran-

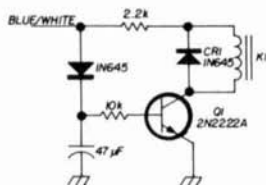

Improved time-constant circuit.

sistor. This has proved quite effective and according to several fm operators who have built it, the circuit works very well. The diode has been added to the transistor base circuit to prevent the dial from shorting out the charge on the time-constant circuit.

frequency-measuring oscillator

The frequency-measuring oscillator described in the April, 1972, issue was originally designed and built by Ben Christie, K2BF. A footnote should have been included in the article to that effect. It seems that Ben designed and built an fmo and sent it to a friend, Peter Petersen, K6MFS, in Long Beach, California. It was at K6MFS's house that author W6IEL saw the original fmo, realized it would make a good construction article and obtained full information from K2BF. The photographs in the article were taken by K6MFS, and are of the original fmo built by K2BF.

multimode i-f system

In the article on the multimode i-f system in the September, 1971, issue, several component designators were not included on the schematic. Capacitor C6 is the .001- μ F capacitor from pin 14 to pin 15 of the NE560 PLL IC. C1 and C2 are the two 100-pF capacitors across L1 and L2. R1 is the 1k resistor from pin 2 to pin 3 of the MC 1596G IC. R3 is the 3.9k resistor connected to pin 9 of the MC1596G.

frequency scaler

In the circuit of the frequency scaler, fig. 2B, page 42 of the September, 1972 issue of *ham radio*, the .01- μ F capacitor should be connected to both V_{CC} pins on the 95H90 IC. The circuit-connection dot was inadvertently left off by the draftsman.

direct-reading swr meters

The meter scale for the direct-reading swr meter (fig. 1, page 29, May, 1972) is incorrect. The author states that, "An swr of 1:1 is obtained if the reflected power is equal to zero." That would place the swr line labeled "1" directly between the zero on the *reflected* scale and the

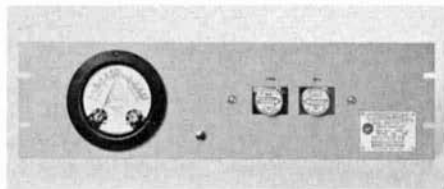

Bird Model 3122 Thru-line wattmeter.

pivot of the reflected meter pointer. In fig. 1 that line is displaced to the left, so that a reflected reading *less* than zero would be required to obtain an swr of one. In addition, ThruLine[®] is a registered trademark of Directional RF Wattmeters manufactured by Bird Electronic Corporation. Author WA4WDK's vswr meter was patterned after the Bird model 3122 ThruLine[®] Wattmeter pictured here.

logic monitor

In the logic monitor circuit described in the April, 1972, issue (page 70) the output of the first section of the MC844 should be connected to the 1k pullup resistor.

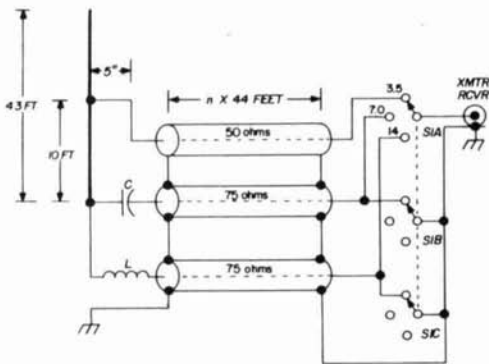

LA1EI's three-band ground-plane antenna.

three-band ground plane

Fig. 6 of LA1EI's excellent article on the three-band ground plane in the May, 1972, issue is in error. The corrected drawing is shown above.

repeater control with simple timers

In fig. 1 on page 47 of the September, 1972, issue, C1, the 400-pF capacitor, and the 33-ohm resistor should go to ground, not to Q of U1. Make the same change to fig. 2 on page 48.

power supply ics

The RCA CA3055 voltage-regulator IC specified in the article on page 50 of the November, 1970 issue of *ham radio* has been replaced by the RCA CA3085. The CA3085 is a 12-mA device, while the CA3085A is a 100-mA device which is a plug-in replacement for the old CA3055. The CA3085B, a member of the same IC family, has the same ratings as the CA3085A, but can withstand higher input voltage surges. The price, incidentally, of the CA3085A is less than the CA3055, welcome news in view of the higher costs of nearly every commodity these days.

The "STANDARD"

72' ALUMINUM Tower FOR DX'ing

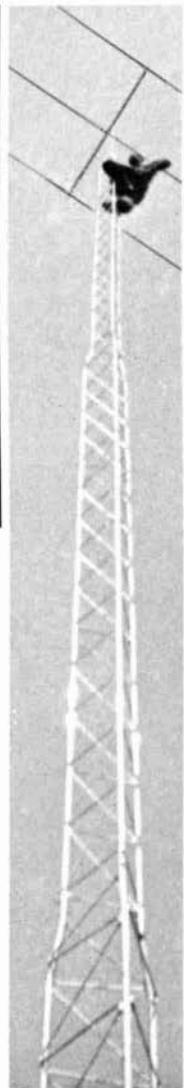

Strong, Light, No Upkeep
Self-Supporting

Easy to Assemble & Erect

All towers mounted on
hinged bases

Complete Telescoping and
Fold-Over Series available

*so light you can
put it up all by
yourself! No
climbing, no jin
poles, no heart
attacks.

And now, with motorized
options, you can crank it
up or down, or fold it over,
from the operating posi-
tion in the house.

See your local distributor, or write for 12
page brochure giving dozens of combina-
tions of height, weight and wind load.

HEIGHTS MANUFACTURING CO.

NOW In New Larger Facilities
In Almont Heights Industrial Park
Almont, Michigan 48003



CRYSTAL FILTERS and DISCRIMINATORS



by
K.V.G.

All of us at

SPECTRUM INTERNATIONAL

*wish all our customers and readers
a Very Happy Christmas
and a Successful New Year*

CRYSTAL FILTERS
DISCRIMINATORS
CONVERTERS

For further information Check-Off page 126



SPECTRUM
INTERNATIONAL
BOX 1084 CONCORD
MASSACHUSETTS 01742

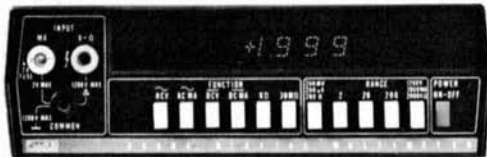

*New low cost digital multimeter \$299

• 26 ranges to measure ac/dc voltages from 100 microvolts to 1200 V, ac/dc currents from 100 nanoamperes to 2 amperes and resistance from 100 milliohms to 20 megohms.
• Guaranteed to stay within specifications for one full year.
Fluke gives you the best specs and strongest warranty on the market today for the lowest cost of ownership ever.
• Wide choice of options including rechargeable battery pack, digital printer output, deluxe test leads, high-voltage probe, RF probe, 200-amp ac current probe, carrying case, dust cover and rack mounts.
• Unique self-zero feature eliminates off-set errors.
• Rugged high-impact case with securely mounted internal electronics.
• Service centers throughout U.S., Canada, Europe and Far East for 48-hour turnaround repairs.



P. O. Box 7428,
Seattle, Washington 98133.

Get all the details from your nearest Fluke sales office. Dial toll-free 800-426-0361 for address of office nearest you.

NEW! IC KEYS

Only
\$87.50
PPD
USA



- Self completing dots and dashes.
- Dot memory for easy keying.
- Precision feather-touch key built-in.
- Sidetone oscillator and speaker built-in.
- Relay output keys 300-V @ 100-ma.
- Keyed time base. Instant start.
- 5-50 wpm. Perfect dot-dash ratio.
- Send QSL or postcard for free brochure.

PALOMAR ENGINEERS

BOX 455, ESCONDIDO, CAL. 92025

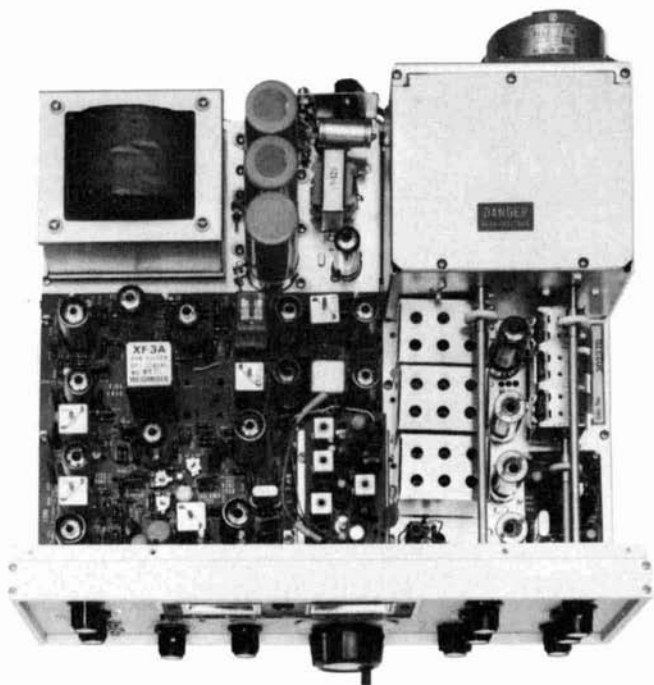

Look into the FTdx 570

You're invited to take an inside look at Yaesu's new FTdx 570 transceiver.

What you'll see inside is quality. Construction features like a heavy-gauge, compartmented steel chassis with integral outer case, and instrument quality VFO gearing. You'll see a beautifully-arranged circuit layout, with each component identified by part number. And you'll see only the highest quality components — rated well above their operating levels.

The FTdx 570 is one of the best built rigs around. Anywhere. We built it like a tank. But like a fine watch, too.

The FTdx 570 is also filled with performance features you won't find in any other rig in its price range. A noise blanker. Built-in power supply. Calibrators, WWV, VOX and a cooling fan. Not to mention 560 watts PEP SSB, 500 watts CW input power. Plus a super-sensitive receiving section. Even a built-in speaker.

For a little extra money, you can have a CW filter included.

Those are the highlights. Send us the coupon, we'll send you the details. Better yet, send us \$549.95 and we'll send you the FTdx 570, complete with a one-year warranty. Why wait to get into a Yaesu?



SPECTRONICS WEST

Dept. Q, 1491 E. 28th, Signal Hill, Ca. 90806 / (213) 426-2593

SPECTRONICS EAST

Dept. Q, Box 1457, Stow, Ohio 44224 / (216) 923-4567

Please send detailed information on all Yaesu products.

Enclosed find \$ _____

Please send model(s) _____

Name _____

Address _____

City _____ State _____ Zip _____

All prices F.O.B. Signal Hill, Ca. "H-2"
Master Charge and BankAmericard accepted.



COMPUTER KEYBOARD W/ENCODER \$35

Another shipment just received. Alpha-numeric keyboard excellent condition. Once again we expect an early sellout. Price of \$35 includes prepaid shipment in the US and shipment made within 24 hours of receipt of order.



TS 323 FREQ. METER

Similar to the familiar BC 221 except this one covers range of 20-450 mc. Accuracy .005% Used, guaranteed OK, less batteries, with schematic. TS-323 ship wt. 35 lbs. \$50.00

JOHN MESHNA JR. ELECTRONICS
P.O. Box 62 E. Lynn, Mass. 01904

NOISE ACTUATED SWITCH \$1.35

Solid state noise actuated switch fully wired, includes mike pick-up, amplifier, SCR switch. Actuates by noise or whistle. Useful for burglar alarms, lamp lighter, etc. 15 ft. range.

LIGHT EMITTING DIODES 3/\$1.00

Ruby red, gold plated leads. With mercury cell for instant testing.

POWER TUNEABLE VARACTOR \$5.00

Similar to MA-4060, used in doublers, triplers, amplifiers, etc. Fully guaranteed, with specs and some circuits. \$5 each or 6 for \$25 pp.



CHARACTER GENERATOR SETS \$50

64 bit ASC II Character Generator IC sets. Vertical scan set includes SK0002 kit, two MM502 and one NH0013C.

Horizontal scan sets includes SK0001 kit, two MM502, and one NH0013C.

Make your own CRT readout or use it for hard copy.

Either set only \$50 and includes 10 pages of info on character generators.

SOLID STATE AUDIO AMP \$1.25

Fully wired, transistorized, uses 6 volts

New 3 Digit Counter



The model fm-36 3-digit frequency meter has the same features that has made the 2 digit model so popular with Hams — low price, small size (smaller than a QSL card), 35 Mhz top frequency, simple connection to your transmitter, +0 -0.1 KHz readout — PLUS the added convenience of a third digit to provide a 6 digit capability. Kit or Assembled.

Example: 28,649,800 Hz reads 28.6 MHz or 49.8 KHz. (Add the 10 Hz module to read 9.80.)

FM-36 KIT \$134.50

NEW

300 MHz PRESCALER only \$45.00
with fm-36 order

Micro-Z Co.

Box 2426 Rolling Hills, Calif. 90274

Central New York Specialty Headquarters

FM by STANDARD COMMUNICATIONS
and CLEGG

ANTENNAS by HY-GAIN

Quality-Selected Used Ham Gear

Write for listing, updated twice monthly

CFP ENTERPRISES

866 Ridge Road

Ludlowville, N. Y. 14862

607-533-4297

FM Schematic Digest

A COLLECTION OF
MOTOROLA SCHEMATICS

Alignment, Crystal, and Technical Notes
covering 1947-1960

136 pages 11 1/2" x 17" ppd \$6.50

S. Wolf

P. O. Box 535

Lexington, Massachusetts 02173

NEW 6 METER FM

Regency

HR-6

25 Watt

12 Channels



SPECIFICATIONS

RECEIVER

Antenna Impedance 50 ohms
Frequency Range 52-54 MHz
Sensitivity 0.35 μ v (Nom.) 20db Quieting
Selectivity 6db \pm 16 KHz
Image Rejection 50db \pm 32 KHz
Spurious Rejections 60db
Modulation Acceptance \pm 15 KHz
Audio Output (3-4 ohm speaker) 3
watts @ 10% or less distortion 5 watts
maximum.

Squelch System Full "noise" operated
Channels 12 crystal controlled with
independent channel selector
I.F. Frequencies 10.7 MHz and 455 KHz
Crystal Installed 52.525 MHz Channel 1

TRANSMITTER

Antenna Impedance 50 ohms
Frequency Range 52-54 MHz
Power Output 25 watts min. @ 13.8V DC
Power Bandwidth 25 watts
from 52-54 MHz
Harmonic & Spurious Emissions 60db
or more below carrier

Modulation Phase modulation with
automatic deviation limiting
Deviation Internal adjustable from
0-15KC. Factory set to 10KC.
Microphone Preamp FET input
with internal level adjustment.
Channels 12 crystal controlled with
independent channel selector
and individual channel netting capacitors
Power Amp Protection SWR Bridge
limiting circuit
Crystal Installed 52.525 MHz Channel 1

POWER

Voltage Requirements 13.8V DC (nom.)
11.5V (min.) - 14.5V (max.)
Current Requirements At 13.8 Volts
Receive (Squelched) 280 MA.
Receive (Max. audio output) 900 MA.
Transmit 4.5 Amp.
Fuse Size 10 amp. 3AG
Size 2 $\frac{3}{8}$ x 6 $\frac{1}{2}$ x 9 $\frac{1}{2}$
Shipping Weight 6 lbs.

ALL NEW and ONLY \$239⁰⁰

FROM

COMMUNICATIONS WORLD, INC.

4788 STATE ROAD — CLEVELAND, OHIO 44109

PHONE: (216) 398-6363

THE MIDWEST NEWEST COMPLETE COMMUNICATION CENTER

Stocking A/S, Astatic, CDE, Cush Craft, Clegg, HyGain, Kenwood, Newtronics, all Regency products, Business, Ham, Marine, and CB, Standard, Rohn, SBE, Tempo and Ten-Tec.

WESTERN UNION DESK FAX

PUT ON THE AIR — OR BACK TO BACK

"PRICED TO SELL"

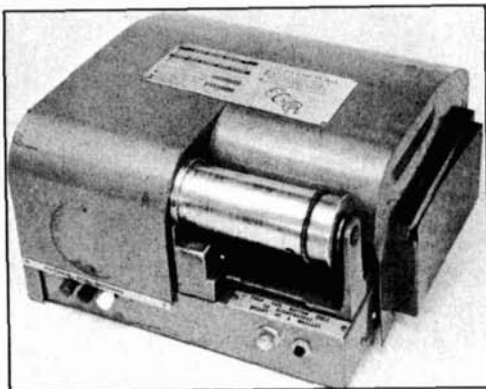

PAPER
FOR
DESK FAX
1,000
SHEETS
\$12.95

\$795 EA.

2/\$1295

COOLING FAN, 4 pole 110V. 60 cyc., Motor,
4 bladed nylon fan. 50 CFM 2 1/4" W. x 3" H.
x 2 1/4" D. \$2.25 each

ELECTROLYTIC CAPACITORS

4000 MFD at 15V 75¢ 10/\$6.00
1000 MFD at 15V 25¢ 10/\$2.00
50 MFD at 15V 20¢ 10/\$1.50

Miniature reed switch, glass enclosure 3/4"
long 25¢ ea. 10/\$2.00

88 MH Toroids, potted 10/\$3.00

IRC Trimpots #RT22C2 1K-5K-10K-20K
3/\$1.00

Pots, miniature 1/8" shaft 5K 3/\$1.00

Knobs for 1/8" shaft, brass inserts 5/\$1.00

1000 PIV 2 amp Diodes 10/\$2.95

Molex I.C. Terminals, 120 per Ft. \$1.00 per foot

Nixie Tube type National NL940
\$2.95 ea. 10/\$27.50



R & R ELECTRONICS
311 EAST SOUTH ST.
INDIANAPOLIS, IND.
46225

\$5.00 minimum order
Please add sufficient postage.

RADIO RECEIVERS R-257/U

BACK WITH AN EVEN BETTER SUPPLY

R & R has the Motorola Plug In's we sold
out of last year and more.

We now have the popular LOW BAND 25-50
MC equipment. Unit comes with these
plug-ins:

- 1st IF & 2nd Mixer
- RF & 1st Mixer
- Oscillator-Doubler unit-Amplifier
- 2nd IF & Discriminator
- Audio Squelch
- Filter Unit

SCHEMATIC Diagrams for all units supplied

COMPLETE SET \$9.95



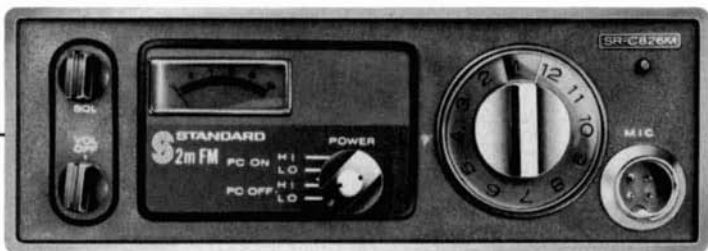

MAXIMIZE YOUR AMATEUR RADIO

What new 2M FM gives me most for my money, performance vs. price? The answer's as clear as the superb reception you'll get on the new Standard 826MA, 10 watt, 2 meter FM transceiver. You'll find such outstanding features as 12 channels — with the four most popular ones included — and a RF output meter with selection of 10 watts or 0.8 watt for battery conservation. And of course, our "Astropoint" system

MONEY.

that assures: top selectivity, great sensitivity, and rejection of unwanted signals on today's active 2M band. **Helical Resonators** & FET front end provide the performance needed for tomorrows crowded channels. Provision for **tone coded squelch** to activate modern repeaters. A radio that won't become obsolete. Occupies less than 200 cu. in. Weighs less than 5 lbs. It has all the same "Astropoints" as entire Amateur line.

NEW 22 CHANNEL BASE STATION SRC-14U

Ultimate in a 2M FM Transceiver features:

- 22 channels
- AC & DC supplies Built In
- 10W (1, 3 & 10 selectable)
- Receiver offset tuning
- VOX
- Three Front Panel Meters
- Plus many more exciting features.



For detailed information on these; the complete Standard line and the name of your nearest dealer write:



Standard
Communications Corp.

213 / 775-6284 · 639 North Marine Avenue, Wilmington, California 90744

Xmas Counter Kit Sale:

XMAS COUNTER KIT SALE

Here's how it works:

Place an order for over \$25.00 worth of merchandise at our regular low prices. Then, for each dollar worth of merchandise over \$25.00, you may buy one of the following kits:

1. One each of 7490, 7475, & 7447 for \$1.50
2. One each of 74192, 7475, & 7447 for \$2.25

OFFER EXPIRES JANUARY 15, 1973---To take advantage of this sale, please mention the name of this magazine in your order.

Catalog Number	Any Quantity Per Item (Hlx)					Catalog Number	Multiples of 10 Per Item (Hlx)					
	1	100	1000	10000	100000		1	100	1000	10000	100000	
7490	26	25	23	22	21	74160	1.89	1.79	1.68	1.58	1.47	1.37
7491	26	26	23	22	20	74161	1.89	1.79	1.68	1.58	1.47	1.37
7492	26	25	23	22	21	74166	1.98	1.87	1.76	1.65	1.54	1.43
7493	26	25	23	22	21	74176	1.62	1.53	1.45	1.36	1.28	1.19
7494	28	27	25	24	23	74182	1.62	1.53	1.45	1.36	1.28	1.19
7495	28	27	25	24	22	74181	1.20	1.13	1.07	1.01	.95	.90
7496	22	20	17	16	15	74180	5.28	5.00	4.59	4.28	3.90	3.67
7497	22	20	17	16	15	74182	1.20	1.13	1.07	1.01	.95	.90
7498	22	20	17	16	15	74182	1.98	1.87	1.76	1.65	1.54	1.43
7499	32	30	29	27	26	74191	1.98	1.87	1.76	1.65	1.54	1.43
7410	26	25	23	22	21	74190	1.98	1.87	1.76	1.65	1.54	1.43
7411	28	27	25	24	22	74197	1.98	1.87	1.76	1.65	1.54	1.43
7413	50	55	52	49	46	74198	2.01	2.65	2.50	2.34	2.18	2.03
7416	52	50	47	44	42	74199	2.01	2.65	2.50	2.34	2.18	2.03
7417	52	50	47	44	42							
7420	26	25	23	22	21							
7421	26	25	23	22	21							
7423	80	76	72	68	64							
7425	50	48	45	41	38							
7426	34	32	31	29	27							
7430	26	25	23	22	21							
7437	56	53	50	48	45							
7438	56	53	50	48	45							
7440	26	25	23	22	21							
7441	1.73	1.64	1.55	1.46	1.37	1.27						
7442	1.27	1.21	1.14	1.07	1.01	.94						
7443	1.27	1.21	1.14	1.07	1.01	.94						
7444	1.27	1.21	1.14	1.07	1.01	.94						
7445	1.71	1.62	1.53	1.44	1.35	1.26						
7446	1.24	1.17	1.11	1.04	.98	.91						
7447	1.16	1.10	1.04	.98	.92	.85						
7448	1.14	1.07	1.01	.95	.89	.86						
7449	26	25	23	22	20							
7451	26	25	23	22	21							
7453	26	25	23	22	21							
7454	26	25	23	22	21							
7459	26	25	23	22	20							
7470	42	40	38	36	34	32						
7472	38	36	34	32	30	28						
7473	50	48	45	41	38							
7474	50	48	45	41	38							
7475	50	48	45	41	38							
7476	50	48	45	41	38							
7480	76	72	68	65	61	57						
7482	99	94	88	81	77							
7483	1.63	1.55	1.46	1.38	1.29	1.20						
7485	1.43	1.35	1.28	1.20	1.13	1.05						
7486	50	48	45	41	38							
7490	80	76	72	68	64	60						
7491	1.43	1.35	1.28	1.20	1.13	1.05						
7492	80	76	72	68	64	60						
7493	80	76	72	68	64	60						
7494	1.18	1.12	1.05	.98	.93	.87						
7495	1.18	1.12	1.05	.98	.93	.87						
7496	1.18	1.12	1.05	.98	.93	.87						
74100	1.52	1.44	1.36	1.28	1.20	1.12						
74107	52	49	47	44	42	39						
74121	56	53	50	48	45	42						
74122	70	67	63	60	56	53						
74123	1.21	1.06	1.00	.94	.89	.83						
74141	1.63	1.55	1.46	1.38	1.29	1.20						
74145	1.41	1.33	1.26	1.18	1.11	1.04						
74150	1.63	1.55	1.46	1.38	1.29	1.20						
74151	1.20	1.14	1.07	1.01	.95	.90						
74153	1.63	1.55	1.46	1.38	1.29	1.20						
74154	2.43	2.30	2.16	2.03	1.89	1.76						
74155	1.40	1.39	1.31	1.23	1.16	1.08						
74156	1.40	1.39	1.31	1.23	1.16	1.08						
74157	1.56	1.48	1.39	1.31	1.23	1.15						
74158	1.56	1.48	1.39	1.31	1.23	1.15						

TRANSISTORS & DIODES

1N270	.15	.14	.13	.12	.11	.10	1N4003	.13	.12	.11	.10	.09	.08
1N274	.10	.10	.10	.10	.10	.10	1N4006	.15	.14	.13	.12	.11	.10
1N304	.10	.09	.09	.08	.08	.08	1N4151	.15	.14	.13	.12	.11	.10
1N4001	.10	.09	.09	.08	.08	.08	2N3860	.25	.23	.21	.19	.17	.15
1N4002	.11	.10	.09	.08	.07	.06							

All IC's are supplied in 8-, 14-, 16-, or 24-pin DIP (Dual in-line) plastic or ceramic package except for NE533, NE536, NE537, and NE540 which come in TO-5 packages.

We give FREE data sheets upon request, no ask for those data sheets that you NEED, even for those listed IC's that you are not buying. (No orders over \$25.00 will send you a new 270 page COMPLETE TTL IC data book FREE. Or, you may obtain a new 240-page LINEAR data book instead. Orders over \$50.00 will receive both books. Orders over \$100.00 will receive a complete LIBRARY of DIGITAL & LINEAR data & application books totaling 1,000 pages. FREE PLEASE NOTE: Data books are shipped separate from your order. Please allow two weeks for delivery.

UNIVERSAL BREAK-OUT COUNTING UNITS

1. Easy to read single pulse LED or Fluorescent-type Readout with wide angle viewing.

2. B/D Outputs, Readout Lamp Test, Flip-Flop Blanking and Counter Reset are available.

3. Plug-in Modules:

1. Molex Sockets for all IC's and Readout.
2. 1-in-plug G-10, 2oz Copper, Glass Epoxy Board.
3. Your choice of 1 to 6 displays on one P.C. Board.
4. Grouping of 2 to four readouts on the same display board.
5. Display board mounts perpendicular to counter/drivers board.
6. Top Board counting and counter preset functions available with 74192.

10. 60 MHz typical single rate with 74196.

11. Operates from 5 Volt TTL compatible single supply.

12. First in a series of Universal plug-in modules; for frequency counting, time measurements, event counting, TVM, monostable comparators, etc.

13. P.C. Board only - are available for \$3.00 per decade.

Price (Per Decade):

Basic Unit consisting of 7490, 7417, 74196, 74192, add \$1.25

7490, add \$0.50

For 74176 instead of 7490, add \$9.00

Options:

For LED Readouts instead of Fluorescent-type, add \$2.00

For 7475 Latch, add \$1.25

For 74176 instead of 7490, add \$1.00

For 74196 instead of 7490, add \$0.75

For Fully assembled and tested unit, add \$7.50



50 99 \$4.75
100 999 \$4.50
1000 \$4.25

7490
7491
7492
7493
7494
7495
7496
7497
7498
7499

7410
7411
7412
7413
7414
7415
7416
7417

7420
7421
7422
7423
7424
7425
7426
7427
7428
7429
7430
7431
7432
7433
7434
7435
7436
7437
7438
7439
7440
7441
7442
7443
7444
7445
7446
7447
7448
7449
7450
7451
7452
7453
7454
7455
7456
7457
7458
7459
7460
7461
7462
7463
7464
7465
7466
7467
7468
7469
7470
7471
7472
7473
7474
7475
7476
7477
7478
7479
7480
7481
7482
7483
7484
7485
7486
7487
7488
7489
7490
7491
7492
7493
7494
7495
7496
7497
7498
7499

74100
74101
74102
74103
74104
74105
74106
74107
74108
74109
74110
74111
74112
74113
74114
74115
74116
74117
74118
74119
74120
74121
74122
74123
74124
74125
74126
74127
74128
74129
74130
74131
74132
74133
74134
74135
74136
74137
74138
74139
74140
74141
74142
74143
74144
74145
74146
74147
74148
74149
74150
74151
74152
74153
74154
74155
74156
74157
74158
74159
74160
74161
74162
74163
74164
74165
74166
74167
74168
74169
74170
74171
74172
74173
74174
74175
74176
74177
74178
74179
74180
74181
74182
74183
74184
74185
74186
74187
74188
74189
74190
74191
74192
74193
74194
74195
74196
74197
74198
74199

74500
74501
74502
74503
74504
74505
74506
74507
74508
74509
74510
74511
74512
74513
74514
74515
74516
74517
74518
74519
74520
74521
74522
74523
74524
74525
74526
74527
74528
74529
74530
74531
74532
74533
74534
74535
74536
74537
74538
74539
74540
74541
74542
74543
74544
74545
74546
74547
74548
74549
74550
74551
74552
74553
74554
74555
74556
74557
74558
74559
74560
74561
74562
74563
74564
74565
74566
74567
74568
74569
74570
74571
74572
74573
74574
74575
74576
74577
74578
74579
74580
74581
74582
74583
74584
74585
74586
74587
74588
74589
74590
74591
74592
74593
74594
74595
74596
74597
74598
74599
74600
74601
74602
74603
74604
74605
74606
74607
74608
74609
74610
74611
74612
74613
74614
74615
74616
74617
74618
74619
74620
74621
74622
74623
74624
74625
74626
74627
74628
74629
74630
74631
74632
74633
74634
74635
74636
74637
74638
74639
74640
74641
74642
74643
74644
74645
74646
74647
74648
74649
74650
74651
74652
74653
74654
74655
74656
74657
74658
74659
74660
74661
74662
74663
74664
74665
74666
74667
74668
74669
74670
74671
74672
74673
74674
74675
74676
74677
74678
74679
74680
74681
74682
74683
74684
74685
74686
74687
74688
74689
74690
74691
74692
74693
74694
74695
74696
74697
74698
74699
74700
74701
74702
74703
74704
74705
74706

flea market



■ **RATES** Commercial Ads 25¢ per word; non-commercial ads 10¢ per word payable in advance. No cash discounts or agency commissions allowed.

■ **COPY** No special layout or arrangements available. Material should be typewritten or clearly printed and must include full name and address. We reserve the right to reject unsuitable copy. **Ham Radio** can not check out each advertiser and thus cannot be held responsible for claims made. Liability for correctness of material limited to corrected ad in next available issue. Deadline is 15th of second preceding month.

■ **SEND MATERIAL TO:** Flea Market, Ham Radio, Greenville, N. H. 03048.

SAROC EIGHTH ANNIVERSARY January 4-6, 1973. Advance Registration \$10.00 per person entitles registrant to SAROC Special room rate \$15.00 per night plus room tax, single or double occupancy, tickets for admission to technical seminars, Swan Electronics and SAROC Social Hour Friday; Hy-Gain/Galaxy Electronics and SAROC Cocktail Party Saturday, Buffet Hunt Breakfast Sunday; Ladies who register will be offered a special program on Saturday. Advance Registration with Flamingo Hotel mid-night show, two drinks, \$17.00. Advance Registration with Flamingo Hotel Dinner Show (entrees Brisket of Beef or Turkey) no drinks, \$21.00. Tax and Gratuity included except for room. SAROC Roundtrip Jet Vacation Flight Departure Cities: Baltimore/Washington, Boston, Chicago, Cleveland, Columbus, Detroit, Hartford, Milwaukee, New York/Newark, Philadelphia, Pittsburg, St. Louis, Kansas City, Denver, Omaha and Lincoln. Send for details. Sixth National FM Conference, ARRL, WCARS 7255, WPSS-3952, MARS, meetings and technical sessions scheduled. Accommodations request to Flamingo Hotel, Las Vegas, Nevada before December 15th. Advance Registration to SAROC Southern Nevada ARC, Inc., Box 73, Boulder City, Nevada 89005, Before December 31st.

WORLD QSL — See ad page 118.

SAVE MONEY on parts and transmitting-receiving tubes. Foreign-Domestic. Send 25¢ for giant catalog. Refunded first order. United Radio Company, 56-HR Ferry Street, Newark, N.J. 07105.

11TH ANNUAL MID-WINTER SWAP AND SHOP on Sunday, February 11, 1973 at the DuPage County Fairgrounds, Wheaton, Illinois. Hours: 8:00 AM to 5:00 PM. \$1.00 advance/\$1.50 at the door. We are expanding to two buildings; this year. Refreshments and unlimited parking. Bring your own tables. Free coffee and donuts 9:00 - 9:30 AM. Hams, CB'ers, electronic hobbyists, friends and commercial exhibitors are cordially invited. Write W.C.R.A., Bill Rambow, WB9AVD, P. O. Box QSL, Wheaton, Illinois 60187 for information.

VK7 GOLDEN JUBILEE AWARD RULES: Radio Amateurs outside Australia and New Zealand to contact five (5) Tasmanian stations (VK7) during the period 1st January to 31st December 1973. Any amateur band may be used. Any amateur mode may be used with cross mode being acceptable. Cross band working is not acceptable. A copy of the log showing date, time, band and other relevant details signed by the operator and two (2) other licensed amateurs or by the operator and the Secretary of his Club. Isolated operators who are unable to comply with the above may request their logs be subject to check by the organizers. A suitable certificate will be issued. Sea Mail 3 IRC Air Mail 6 IRC. Address for logs: VK7 Golden Jubilee Award, Box 851J, G.P.O., Hobart, Tasmania, 7001.

TOROIDS, iron "E" powder 80-100 meters. .500" — 8/\$1.00. .940" — 4/\$1.00, 1.437" — 75¢ each or 3/\$2.00, 2.310" — \$1.50 or 3/\$4.00. Please include 50¢ postage, slightly more on large orders. Fred Barken, WA2BLE, 274 E. Mt. Pleasant Ave., Livingston, N. J. 07039.

QSLs. Second to none. Same day service. Samples 25¢. Ray, K7HLR, Box 331, Clearfield, Utah 84015.

THE KEESLER AMATEUR RADIO CLUB at Keesler AFB, Biloxi, Mississippi has just formed a 20m net to unite departed Keesler hams and to provide a public service for all by handling interstate & international (legal third party) traffic. We would greatly appreciate a small mention in your magazine. Net info: Name, K5TYP; Net Freq. 14.330 MHz; Time, 2000 GMT, Day, Saturday. WB5FDJ.

WG3SFC WILL COMMEMORATE the flight of an Apollo Mission. Apollo 17 is to be launched on 16 Dec. 72. WG3SFC will be on the air from prior to launch until after splashdown. Contacts with WG3SFC will be confirmed by a special QSL card. All contact confirmation requests should be accompanied by a self-addressed stamped mailing label. QSL to Goddard Amateur Radio Club, P. O. Box 86, Greenbelt, Maryland 20770. Normal frequencies: SSB 3950, 7275, 14325, 21400, 28650; CW: 3560, 7060, 14060, 21060, 28060. Novice frequencies in each band will be tuned from time to time.

COMPLETE SCR-508 TANK RADIO SET. The receiver (BC-603) mod. to cover 10, CB, 15M, AM/FM, 12/115V. Trans., (BC-604) is 10-15M, FM/CW, with 12v dyno. All like new with manual. \$60. W. Roden, P. O. Box 1426, Rancho Santa Fe, Calif. 92067.

FREE "WANT" ADS! Details, plus 4 big issues \$1. HAM ADS, P. O. Box 46-653H, L. A., Calif. 90046.

"RTTY SPEED CONVERTER" A drilled, fiberglass 4" x 6½" printed circuit board now available for the WA6JYJ speed converter in the Dec. 71 issue of Ham Radio. \$6.00 post paid. Complete parts kit including PCB \$40.00, post paid. P & M Electronics, 519 South Austin, Seattle, WA 98108.

ANTIQUE COLLECTORS: Tubes for old sets, trade or sell, New UX200 (RCA) \$5, UX201A \$5, UX30 \$2, SASE for list, WA4NED, Box 468, Gainesville, Georgia 30501.

ROCHESTER, N. Y. is the place to go for the largest Hamfest, VHF meet and flea market in the northeast, May 12th. Write WNY Hamfest, Box 1388, Rochester, N. Y. 14603.

DISCOUNTS! Standard, Sonar, Clegg, Robyn, Mosley, Cush, Craft, Rohn, Gladding, others. Also Marine and CB. Arena Communications, Dept. H, 1169 N. Military Hwy., Norfolk, Va. 23502.

WANTED: QST before March 1923. All letters answered airmail. Have spare 1930/31 copies and NZART "Break-In" — Jock ZL2GX, 152 Lytton, Gisborne, New Zealand.

PILOTS or Air Communicators join International Flying Hams' Club. 1600 members worldwide. Write to Box 385, Bonita, Calif. 92002.

PRINTED CIRCUIT DRILL BITS. Trumbull, 833 Balra Drive, El Cerrito, California 94530.

TELL YOUR FRIENDS about Ham Radio Magazine.

A Christmas MESSAGE
TO ALL...

Dear Friends,

During this Christmas Season we hear so much about Peace on Earth and Good Will toward men. However, the history books and headlines declare hate and strife in our home town and around the World. Let's face the truth. Try as we will, through our own devices, man cannot achieve a true and lasting Peace in the world because there is no Peace within.

Jesus told his disciples, "I am leaving you with a gift - peace of mind and heart! And the peace I give isn't fragile like the peace the world gives. So don't be troubled or afraid."
(John 14:27 Living Bible)

Bring lasting peace into the world! As the disciples did, turn from your way and follow Jesus. Claim the gift of inner peace he gives....then share it with the world!

May this be a very Merry Christmas and the Best New Year of your life!

MATRIC

BOX 235 • SENECA, PA. 16346 • 814 648-5122

CNE

**communication/navigation electronics
MAGAZINE**

This monthly technical magazine fills a "communication gap" within the electronic communication and navigation equipment industry. Its function is to provide comprehensive and authentic information not available in any other single publication. The types of feature articles include the following:

SYSTEM DESIGN

The planning of radio communication and electronic navigation systems, as well as CCTV and electronic security systems.

EQUIPMENT DESIGN

State-of-the-art design techniques—analysis of newly developed equipment.

TECHNOLOGY

Reports on technical developments—looking into the future—measurement techniques.

FCC REPORTS

Comprehensive reports on FCC petitions, proposed rulemaking and newly adopted rules changes—long before they are published in FCC Rules and Regulations.

SERVICING

The latest techniques for maintaining equipment—troubleshooting—analysis and use of test equipment.

INSTALLATION

Solutions to unique installation problems—local and national codes—interference and interface problems.

APPLICATIONS

Utilization of system components—scope of equipment applications—interface requirements.

CASE HISTORIES

Economic and operational aspects of unique systems—examples of how problems were solved.

Subscription rate \$12 per year, \$20 for two years. When Check or Money Order accompanies subscription request, special rate is \$10 for one year or \$16 for two years. Advertising rate card sent on request.

**COMMUNICATION AND NAVIGATION, INC.
250 PARK AVE., NEW YORK, NY 10017**

WANTED: PRE-WAR COLLINS xmtr — 4A, 32B, 32G etc. Have you Handbooks? All letters answered airmail. — Jock ZL2GX, 152 Lytton, Gisborne, New Zealand.

JOIN WORLD'S LARGEST Amateur Radio Service organization. Over 12,000 members in over 750 I.T.U. Call Prefixes. Write to International Amateur Radio Society, Box 385, Bonita, Calif. 92002.

RTTY PICTURE TAPES. Stamp for list. John Sheetz, 5 Hansell, New Providence, NJ 07974.

"AFSK GENERATOR" — PCB and all components except input output jacks, power supply and chassis. \$6.60. P & M Electronics, 519 South Austin, Seattle, WA 98108.

FIGHT TVI with the RSO Low Pass Filter — p115 March 73 — write for brochure — Taylor Communications Manufacturing Company, Box 126, Agincourt, Ontario, Canada.

SURPLUS MILITARY RADIOS, Electronics, Radar Parts, tons of material for the ham, free catalogue available. Sabre Industries, 1370 Sargent Avenue, Winnipeg 21, Manitoba, Canada.

SCALERS — Complete units. 260MHz unit \$70; high sensitivity 280MHz unit \$90. Add Calif. tax and \$1.50 shipping. Guaranteed. WGPBC, Belmont Spectrum Research, 1709 Notre Dame, Belmont, Calif. 94002.

WANTED: QST magazines, 1916-1922. Paul Kluwe, Edmore, Mich. 48829.

KLEINSCHMIDT MANUALS. Mite KSR, teletypewriter machines, supplies, parts, gears, motors. SASE list. Teletype manuals wanted. Typetronics, Box 8873, Ft. Lauderdale, Fla. 33310.

WE BUY ELECTRON TUBES, diodes, transistors, integrated circuits, semiconductors. ASTRAL ELECTRONICS, 150 Miller Street, Elizabeth, N. J. 07207. (201) 354-2420.

FOR SALE: MODEL 19 TELETYPE, \$75. Ed Luck, 1710 Yahara Place, Madison, Wisconsin 53704.

"DON AND BOB" GUARANTEED GOODIES. SBE144 209.00; Gladding 25 212.50; SBE450 339.00; Standard SRC146A-write; SBE SSTV system (Monitor, camera 999.50L) 849.00; Hygain TH6DX 139.00; Hyquad 109.00; 400 Rotor (229.00L) 179.00; 204BA 129.00; Mosley CL33 124.00; Ham-M 99.00; TR44 59.95; CDE parts stock; Belden 8448 rotor cable 10¢/ft; 8214 R8BU foam 16¢/ft; Mallory 2.5A/1000PIV epoxy diode 29¢ ea.; 19¢/qty 1000UP; Leader 810GDM 49.95; MOT MC1709CG (709)T05 39¢; Sangamo DCM600MFD/450V cap. 4.95; Write quote Triax, Drake, Eimac, Leader test; CLEGG FM27A: used, clean, guaranteed: 75A4 345.00; NCX500/AC 325.00; T4XB/ACA 450.00; FTDX401/VFO/SPKR/CW 495.00; 2B/2BQ 175.00; HT41 125.00; HT32/37 175.00; NC240S 125.00; TDK C60LN cassette 1.49; Shipping charges collect. Mastercharge, BAC. Warranty guaranteed. Madison Electronics, 1508 McKinney, Houston, Texas 77002. (713) 224-2668.

QSL'S — BROWNIE W3CJI — 3111B Lehigh, Allentown, Pa. 18103. Samples 10¢. Cut catalogue 25¢.

POINT YOUR ANTENNA ACCURATELY! Send SASE for information on how to obtain bearing and distance information to over 400 world wide locations calculated specifically from your own location. W6WAH, Dean C. Hildebrand, 1461 Colonel Ave., Vallejo, Calif. 94590.

GONSET II — 2 METER TRANSCEIVER — \$55.00; Gonset III — \$75.00; Clegg 22er — \$125.00; Poly Comm IV — \$165.00; Norelco Video Tape Recorder — \$310.00; Philips Plumbicon — \$35.00. WB2GKF Stan Nazimek, Jr., 506 Mount Prospect Avenue, Clifton, New Jersey 07012.

SELL: HW-100 w/AC supply, 25 kHz calibrator, CW filter \$225. R-274 gen coverage rcvr \$100. 2m FM Motorola 140D 3T-2R \$75, U43GGT 2T-2R \$90. Both with accessories and crystals. John Boston WB4RUA, Box 354, Calhoun, Ga. 30701 (404) 629-3048.

RADIO CONSTRUCTOR Magazine

- Audio Construction Projects
- Receiver Construction Projects
- Transmitter Construction Projects
- Test Equipment Projects
- Radio Control Projects
- ... and much more

ONE YEAR SUBSCRIPTION — \$7.00

Write
RADIO CONSTRUCTOR
Greenville, N. H. 03048

USED TELETYPE® EQUIPMENT

For details on a limited amount of older Railroad Teletype equipment being disposed of in Texas, Kansas and California send S.A.S.E. #10 Envelope to:

**BOX RTTY
HAM RADIO
GREENVILLE, N. H. 03048**

1. STATE SERVICE STATEMENT OF OWNERSHIP, MANAGEMENT AND CIRCULATION (Act of October 3, 1917; Section 3682, Title 39, United States Code)		2. SEE INSTRUCTIONS ON PAGE 2 (REVERSE)									
NAME OF PUBLICATION RADIO CONSTRUCTOR		DATE OF FILING September 29, 1972									
3. ISSUE DURING PRECEDING 12 MONTHS <table border="1"> <tr> <td>NUMBER OF COPIES OF SINGLE ISSUES SOLD THROUGHOUT THE COUNTRY</td> <td>NUMBER OF COPIES OF SINGLE ISSUES SOLD OUTSIDE THE COUNTRY</td> <td>NUMBER OF COPIES OF SINGLE ISSUES NOT SOLD THROUGHOUT THE COUNTRY</td> <td>NUMBER OF COPIES OF SINGLE ISSUES NOT SOLD OUTSIDE THE COUNTRY</td> </tr> <tr> <td></td> <td></td> <td></td> <td></td> </tr> </table>				NUMBER OF COPIES OF SINGLE ISSUES SOLD THROUGHOUT THE COUNTRY	NUMBER OF COPIES OF SINGLE ISSUES SOLD OUTSIDE THE COUNTRY	NUMBER OF COPIES OF SINGLE ISSUES NOT SOLD THROUGHOUT THE COUNTRY	NUMBER OF COPIES OF SINGLE ISSUES NOT SOLD OUTSIDE THE COUNTRY				
NUMBER OF COPIES OF SINGLE ISSUES SOLD THROUGHOUT THE COUNTRY	NUMBER OF COPIES OF SINGLE ISSUES SOLD OUTSIDE THE COUNTRY	NUMBER OF COPIES OF SINGLE ISSUES NOT SOLD THROUGHOUT THE COUNTRY	NUMBER OF COPIES OF SINGLE ISSUES NOT SOLD OUTSIDE THE COUNTRY								
4. MAILING ADDRESS OF THE PUBLISHER, EDITOR AND MANAGING EDITOR <table border="1"> <tr> <td>PUBLISHER</td> <td>ADDRESS</td> </tr> <tr> <td>T. M. TENNEY, JR.</td> <td>MAIN STREET, GREENVILLE, N. H. 03048</td> </tr> <tr> <td>EDITOR</td> <td></td> </tr> <tr> <td>MANAGING EDITOR</td> <td></td> </tr> </table>				PUBLISHER	ADDRESS	T. M. TENNEY, JR.	MAIN STREET, GREENVILLE, N. H. 03048	EDITOR		MANAGING EDITOR	
PUBLISHER	ADDRESS										
T. M. TENNEY, JR.	MAIN STREET, GREENVILLE, N. H. 03048										
EDITOR											
MANAGING EDITOR											
5. OWNER (If owned by a corporation, its name and address, together with the names and addresses of all stockholders owning or holding 1 percent or more of the total amount of stock; if not owned by a corporation, the names and addresses of the individual owners; if owned by a partnership or other unincorporated firm, its name and address, together with the names and addresses of all individual owners; if the publication is published by a sole proprietor, his name and address.) <table border="1"> <tr> <td>NAME</td> <td>ADDRESS</td> </tr> <tr> <td>COMMUNICATIONS TECHNOLOGY, INC.</td> <td>MAIN STREET, GREENVILLE, N. H. 03048</td> </tr> <tr> <td>T. M. TENNEY, JR.</td> <td>MAIN STREET, GREENVILLE, N. H. 03048</td> </tr> </table>				NAME	ADDRESS	COMMUNICATIONS TECHNOLOGY, INC.	MAIN STREET, GREENVILLE, N. H. 03048	T. M. TENNEY, JR.	MAIN STREET, GREENVILLE, N. H. 03048		
NAME	ADDRESS										
COMMUNICATIONS TECHNOLOGY, INC.	MAIN STREET, GREENVILLE, N. H. 03048										
T. M. TENNEY, JR.	MAIN STREET, GREENVILLE, N. H. 03048										
6. KNOWN BONDHOLDERS, MORTGAGEES AND OTHER SECURITY HOLDERS OWNING OR HOLDING 1 PERCENT OR MORE OF THE TOTAL AMOUNT OF BONDS, MORTGAGES OR OTHER SECURITIES OF THE ISSUING ENTITY <table border="1"> <tr> <td>NAME</td> <td>ADDRESS</td> </tr> <tr> <td>T. M. TENNEY, JR.</td> <td>MAIN STREET, GREENVILLE, N. H. 03048</td> </tr> </table>				NAME	ADDRESS	T. M. TENNEY, JR.	MAIN STREET, GREENVILLE, N. H. 03048				
NAME	ADDRESS										
T. M. TENNEY, JR.	MAIN STREET, GREENVILLE, N. H. 03048										
7. FOR DOMESTIC CIRCULATION BY MAILING AT THE REGULAR RATES (Section 1103 (1), Postal Service Manual) 7a. U. S. C. 3926 provides in pertinent part: "No person who mails any publication at special rate shall be liable for the return of such matter if the rate proper for such publication charge has been collected with the Postal Service and the recipient has not notified the sender in writing to the contrary." 7b. In accordance with the provisions of this section, I hereby declare postage on this publication to have been paid by the special rate authorized by the U. S. C. 3926. (Signature and title of domestic circulation official (name in print))											
8. FOR DOMESTIC CIRCULATION BY NONPOSTAL METHODS AUTHORIZED TO MAIL AT SPECIAL RATES (Section 1113 (2), Postal Manual) (Check one) The purpose, function, and nonprofit status of this publication and the exempt status for Federal income tax purposes: <input type="checkbox"/> Have not changed during preceding 12 months. <input type="checkbox"/> Have changed during preceding 12 months. (If changed, publisher must submit a declaration of change.)											
9. EXTENT AND NATURE OF CIRCULATION		AVERAGE NO. COPIES EACH ISSUE DURING PRECEDING 12 MONTHS	ACTUAL NUMBER OF COPIES OF SINGLE ISSUES PUBLISHED NEAREST FILING DATE								
A. TOTAL NO. COPIES PRINTED (Net Press Run)		43,363	48,000								
B. DISTRIBUTION											
1. SALES THROUGH DEALERS AND CARRIER STREET VENDORS AND COUNTER SALES		3,529	3,559								
2. MAIL SUBSCRIPTIONS		37,579	38,414								
C. TOTAL PAID CIRCULATION		41,108	41,973								
D. FREE DISTRIBUTION BY MAIL, CARRIER OR OTHER means (Samples, complimentary, and other free copies)		958	1,072								
1. COPIES DISTRIBUTED TO NEWS AGENTS, BUT NOT SOLD		512	549								
2. OTHER FREE DISTRIBUTION		446	523								
E. TOTAL DISTRIBUTION (Sum of C and D)		42,066	43,045								
F. OFFICE USE, LEFT-OVER, UNACCOUNTED, SPOILED AFTER PRINTING		899	1,955								
G. TOTAL (Sum of 9B, F, and G) should equal 9A, less 9D (if it)		43,363	48,000								

I certify that the statements made by me above are correct and complete.
 T. M. TENNEY, JR. (Type name)
 70-100 (Rev. 1-71)

ECHO II

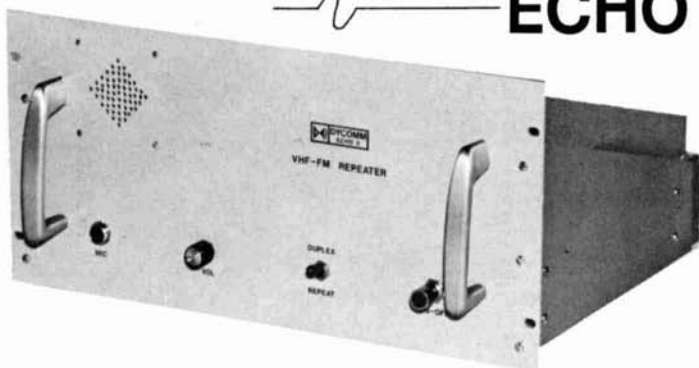

ALL
SOLID
STATE

STOCK
FREQS:
16/76
22/82
28/88
34/94

2 METER
AMATEUR REPEATER — ONLY \$600.00

PROVEN STATE OF THE ART DESIGN
INSTALLATIONS WORKING GREAT IN U.S., EUROPE AND ASIA
STOCK FREQS DELIVERED IMMEDIATELY, OTHERS 3-4 WEEKS
WRITE FOR FREE DATA SHEET — FULL MANUAL \$5.00

DYCOMM

948 AVENUE E P.O. BOX 10116
RIVIERA BEACH, FLA. 33404

MINIATURE SUB-AUDIBLE TONE ENCODER

\$14.95
Wired-
Tested



- Compatible with all sub-audible tone systems such as Private Line, Channel Guard, Quiet Channel, etc.
- Glass Epoxy PCB, silicon transistors, and tantalum electrolytics used throughout
- Any miniature dual coil contactless reed may be used (Motorola TLN6824A, TLN6709-B — Bramco RF-20)
- Powered by 12vdc @ 3ma
- Use on any tone frequency 67Hz to 250Hz
- Miniature in size 2.5 x .75 x 1.5" high
- Complete less reed (Available in 33 freqs. for \$17.50 ea)
- Output 3v RMS sinewave, low distortion

Postpaid — Calif. residents add 5% sales tax

COMMUNICATIONS SPECIALISTS

P. O. Box 153, Brea, CA 92621

SPACE-AGE TV CAMERA KITS & PLANS



BE A PIONEER IN HOME TELECASTING! Build your own TV CAMERA, Model XT-1A, Series D, \$116.95 pp. Solid-State. Step-by-step construction manual. High quality. Connects to any TV without modification. Ideal for home, experimental, education, industry, etc.

PHONE or WRITE for CATALOG.
DIAL 402-987-3771

Many other kits, parts and plans available including starter kits, focus/drift, coils, vidicon tubes, const. plans, etc.

1301 BROADWAY, N.W. **ATV Research** DAKOTA CITY, NEBR. 68731

SUPER COUNTER — \$349

TO 160 MHz (as shown with scaler) 5 digits, w/display storage very compact, 4.5 lbs, AC/DC Sens 50mV, Stbity. 1 pt 10%/wk full wrnt. immediate delivery. Order yours now or SASE for more info. 206-747-8421.



NHE COMMUNICATIONS

15112 S. E. 44TH
BELLEVUE, WA. 98006

WE PAY **HIGHEST**
PRICES FOR ELECTRON
TUBES AND SEMICONDUCTORS

H & L ASSOCIATES

ELIZABETHPORT INDUSTRIAL PARK

ELIZABETH, NEW JERSEY 07206

(201) 351-4200

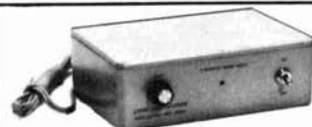

VHF UHF

Crystal Controlled CONVERTERS for DX, FM, ATV, Space and other uses. Extremely Sensitive and free from spurious responses. With AC power supply. Choice of i-f, many in stock. Upgrade your station to JANEL.

50 MHz	2.0db NF	\$74.95
144 MHz	2.5db NF	\$74.95
220 MHz	3.0db NF	\$79.95
432 MHz	5.5db NF	\$74.95

All postpaid. Write for full details. Also preamps. Ask about our OSCAR special 435 MHz converters.

JANEL
LABORATORIES

P.O. BOX 112
SUCCASUNNA, N. J. 07876
201-584-6521

HOOSIER ELECTRONICS — Your ham headquarters in the heart of the Midwest where only the finest amateur equipment is sold. Individual, personal service by experienced and active hams. Factory-authorized dealers for Drake, Regency, Standard, Ten-Tec, Hy-Gain, CushCraft, Ham-M, plus many more. Orders for in-stock merchandise shipped the same day. Write today for our quote and try our personal, friendly Hoosier service. Hoosier Electronics, R. R. 25, Box 403, Terre Haute, Indiana 47802.

WE SELL CONSTRUCTION PLANS — gold recovery unit! — silver recovery unit! — infra-red scope — x-ray fluoroscope — alternator adapter — 200 watt inverter — electronic insect trap — burglar alarm system — chemical formulary (home products) — electroplater — plans \$5.00 — plus many more! Ask for free catalog, airmailed 30¢ — Creative Products, 1551 East Loop 820, Dept. H-1172, Fort Worth, Texas 76112.

F.C.C. TYPE EXAMS GUARANTEED to prepare you for the F.C.C. 3rd., (\$7.00), 2nd. (\$12.00), and 1st (\$16.00), phone Exams; complete package, \$25.00. Research Company, Dept. D. Rt. 2, Box 448, Calera, Alabama 35040

CANADA'S MOST UNUSUAL Surplus and Parts Catalog. Jam packed with bargains and unusual items. Send \$1. ETCO-HR, Box 741, Montreal, Canada.

SELL: E.E. and other technical books. SASE for list. Roger A. Baim, WB9BDP, 2753 W. Coyle, Chicago, Illinois 60645.

ELECTRONIC CONNECTORS WANTED, unused. Air Industry, 5643 W. 63rd Place, Chicago, Ill. 60638

1973 DESK CALENDAR, 12 x 9. Name, address, call in gold, \$2.00. Henry Morgan, 883 Diana, Akron, Ohio 44307.

2 METER FM, Brand New, Inoue IC-20, 1&10 watts, 12 channels, w/mike, cable, mobile mount \$269.50. Bob Brunkow, 15112 S.E. 44th, Bellevue, Wash. 98006. Phone 206-747-8421.

NEW FROM COMTEC! Ameco books cover all grades of amateur and commercial licenses. Also code practice records. Write for full details. Comtec, Greenville, NH 03048.

MANUALS FOR GOVT. SURPLUS GEAR — \$6.50 each: R-390/URR, R-220/URR, R-389/URR, R-388/URR, ALR-5, TT-63A/FGC, RCK, LP-5, URM-25D, CV-591A/URR, TS-587B/U, BC-348JNQ, BC-779B, TS-34A/AP, W3IHD, 4905 Roanne Drive, Washington, D. C. 20021.

TEFLON WIRE #22 gauge stranded, silver plated. \$1.75/100 ft. Rich Shyer, 625-4 S. Palomares, Pomona, Ca. 91766.

VHF NOISE BLANKER — See Westcom ad in Dec. '70 and Mar. '71 Ham Radio.

PEARCE SIMPSON — Gladding 25's, \$219.95 — with 117vac Power Supply, \$264.90 — HiScan monitor incl. one xtal, \$105.00. Antenna Specialists. Bill's Radio, South Rd., Wading River, N. Y. 11792. (516) 929-6118.

RESISTORS: Carbon Composition brand new. All standard values stocked. 1/2 watt 10% 50/\$1.00; 1/4 watt 10% 40/\$1.00. 10 resistors per value please. Minimum order \$5.00. Post paid. Pace Electronic Products, Box 161-H, Ontario Center, New York 14520

FOR SALE, DRAKE 4AA, excellent condition, manual, extra crystals, prepaid, insured. First \$225. George Streit, Box 1713, McAllen, Texas 78501.

TEKTRONIX C27 SCOPE CAMERA. 0.85X and 0.7X lenses, fitted case, 5" and 8 x 10cm scope mounts, Polaroid pack base, focus plate. Almost mint. \$400. Herbert Friedman, W2ZLF, 588 Hewlett St., Franklin Sq., N. Y. 11010.

WANTED: tubes, transistors, equipment what have you? Bernard Goldstein, W2MNP, Box 257, Canal Station, New York, N. Y. 10013.

SSB CONVERTER CV-591A: Get upper or lower sidebands from any recvr. OK gtd. w/book \$137.50
SP-600(*) RECEIVER 0-54-54 MHz continuous, overhauled, aligned, grtd, w/book 250.00

BRAND NEW FREQ-SHIFT TTY MONITOR

NAVY OCT 3: FM Receiver type, freq. range 1 to 26 MHz in 4 bands, cont. tuning. Crystal calib. Reads up to 1500 Hz deviation on built-in VTVM. Cost \$1100.00 each! In original box, with instruct. book & cord. fob Mariposa, Cal. Min. signal needed: 15 mv. Shpg wt 110 lbs 49.50

HIGH-SENSITIVITY WIDE-BAND RECEIVER

COMMUNICATIONS • BUG DETECTION
 • SPECTRUM STUDIES

38-1000 MHz AN/ALR-5: Consists of brand new tuner/converter CV-253/ALR in original factory pack and an exc. used, checked OK & grtd main receiver R-444 modified for 120 v. 50/60 hz. The tuner covers the range in 4 bands: each band has its own Type N Ant. input. Packed with each tuner is the factory inspector's checkout sheet. The one we opened showed SENSITIVITY: 1.1 uv at 38.4 mhz, 0.9 at 133 mhz, 5 at 538 mhz, 4 1/2 at 778 mhz, 7 at 1 ghz. The receiver is actually a 30 mhz IF amp. with all that follows, including a diode meter for relative signal strengths: an atten. calibrated in 6 db steps to -74 db, followed by an AVC position; Pan., Video & AF outputs; switch select pass of ±200khz or ±2 mhz; and SELECT AM or FM! With Handbook & pwr. input plug, all only 375.00
 CV-253 Converter only, good used w/book 89.50

30 MHz PANADAPTER OK grtd \$137.50
 Meas. Corp. #59 Grid Dipper 2.2-420 MHz, 75.00

NEMS-CLARKE #1670 FM Rcvr 55-260 MHz like new 275.00
WVW Rcvr/Comparator 2 1/2-20 MHz, w/scope 250.00
RECEIVER/COMPARATOR FOR 60 KHz WVWL standardizes to 1 part in 10 billion with inexpensive oscillators 495.00

Attention!
Buyers, Engineers, advanced Technicians:
 We have the best test-equipment & oscilloscope inventory in the country so ask for your needs . . . don't ask for an overall catalog . . . we also buy, so tell us what you have. Price it.

R. E. GOODHEART CO. INC.
 Box 1220-HR, Beverly Hills, Calif. 90213
 Phone: Area Code 213, Office 272-5707

TYMETER® Since 1935
 "Time At A Glance"
 DIGITAL CLOCKS
 9:37
 MADE IN U.S.A.

24 HOUR CLOCK

CALL-IDENT
 10-MINUTE STATION
 CALL REMINDER

#124
23⁵⁰

Made in U.S.A.

10-minute repeating timer buzzes warning to sign in your call letters. Walnut or ebony plastic case. 4"H, 7 3/4"W, 4"D. 110V, 60 cy. One Year Guarantee. Made in U.S.A.

At Your Dealer, or DIRECT FROM

PENNWOOD NUMECHRON CO.
 DIVISION OF LCA CORPORATION
 7249 FRANKSTOWN AVE PITTSBURGH, PA 15208

LINEAR FACTORY GUARANTEED FACTORY MARKED

Op Amps

Type	Description	Price
531	Hi slow rate op-amp	\$2.50
532	Micro power 741 TO-5	3.25
533	Micro power 709	2.50
536	FET input op amp	4.50
537	Precision 741 TO-5	2.50
540	70W pwr driver amp	2.04
550	Precision 723 voltage reg.	1.17
555	Times 2 & 2 seconds to 1-hour	1.19
558	Dual 741 (mini DIP)	.88
560	Phase lock loops TO-5	3.25
565	Phase lock loops (A)	3.25
566	Function generator (Mini DIP)	3.25
567	Tone decoder (Mini DIP)	3.25
595	Four quadrant multiplier	3.10
702C	Hi-gain, DC amp, TO-5	.44
703C	RF-IF, amp, 14 ckt., TO-5	.39
709C	Operational amp (A)	.39
710C	Differential amp (A)	.39
711C	Dual diff. comp (A)	.39
723C	Voltage regulator (A)	.95
741C	Frequency compensator 709(A)	.41
741CV	Frequency comp 709 (mini DIP)	.49
747C	Dual 741C (A)	1.25
748C	Freq. adj. 741C (A)	.44
709-709	Dual 709C (DIP)	1.98
739-739	Dual 739C pramp	1.98
	(A) TO-5 or DIP dual in line pak	
75450	Relay Line Driver	.49
4250	Programmable Op Amp	2.50
741CG	Military Gold Cased DIP	.49
	(G) Military Gold Encased Pk	

100 or more, 25% discount
Buy Any 3 PAKS - Take 10% Discount

Type	Sale
SN7400	\$2.21
SN7401	.21
SN7402	.21
SN7403	.21
SN7404	.27
SN7405	.27
SN7406	.45
SN7407	.45
SN7408	.29
SN7409	.29
SN7410	.21
SN7411	.25
SN7413	.50
SN7416	.48
SN7417	.48
SN7420	.21
SN7421	.21
SN7426	.32
SN7430	.21
SN7437	.50
SN7438	.51
SN7440	1.00
SN7442	1.12
SN7443	1.21
SN7444	1.21
SN7445	1.50
SN7446	1.50
SN7447	1.10
SN7448	1.25

Factory Marked
Factory Guaranteed!

LOWEST PRICES ON

TTL IC's

Buy 3 - Take 10% Discount

100 or more, 20% discount

SN7450	.21	SN74121	.49
SN7451	.21	SN74122	.67
SN7453	.21	SN74123	.99
SN7454	.21	SN74141	1.45
SN7450	.21	SN74145	1.25
SN7470	.39	SN74150	1.25
SN7472	.32	SN74151	1.13
SN7473	.44	SN74153	1.25
SN7474	.39	SN74154	1.95
SN7475	.71	SN74155	1.39
SN7476	.44	SN74156	1.39
SN7480	.65	SN74157	1.25
SN7481	1.10	SN74158	1.48
SN7482	.88	SN74160	1.79
SN7483	1.25	SN74161	1.79
SN7486	.49	SN74162	1.79
SN7489	3.50	SN74163	1.79
SN7490	.69	SN74180	1.10
SN7491	1.10	SN74181	4.50
SN7492	.71	SN74182	1.10
SN7493	.71	SN74184	2.50
SN7494	1.10	SN74185	2.75
SN7495	.95	SN74192	1.50
SN7496	1.10	SN74193	1.75
SN74107	.49	SN74195	1.19

NIXIE \$2.50

TUBE SALE
Burrhoughs B7971, 6-to-10, A-to-Z, 2 1/2" high characters, 170V.

ALLEN BRADLEY'S 'MICRO-POTS'

Type G, 1/2" dia. x 1 1/2" high, Mounts 1 1/4" hole, with shaft, linear, immersion-proof high feet.
2 for \$1
Ohms: 2.5K, 5.0K, 25K, 100K, 750K, 7.5K, 500, 10.0K, 100K, 2.0K, 20K, 5 Meg
We stock Locknut Bushing & Screwdriver typer at same low prices.

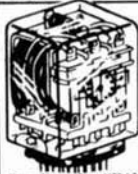

POTTER BRUMFIELD KAP RELAYS

Your choice 3 for \$7.50 **\$2.98**
115 VAC 3PDT \$2.98
12 VDC 3PDT 2.98

Excellent for "HAM" use as antenna switching, latching, transmit, receive, etc., and 100's of commercial or industrial uses. Includes plastic dust-cover with diagram and hook info, 11-pin plug-in base, Contacts movable gold flashed silver, stationary overlay, with silver cadmium oxide movables. All contacts 10 amp 3PDT. Coil data: 115VAC 2250 ohms, 17.6 ma, 12 VDC 21 ohms @ 65 ohms. Size: 2 1/4" x 1 5/16". Wt. 4 ozs. Center pin missing. Comar Mfg. type equal too.

ALLEN BRADLEY'S 'TRANSISTOR POTS'

Type F. Screwdriver adjust.

Ohms: 75, 250, 1.0K, 7.5K, 25K, 100K, 250K, 1.0M, 5.0K, 10.0K, 20.0K, 50K, 75K, 100K, 250K, 5 Meg
Any 4 for \$1

INTEGRATED CIRCUIT SOCKETS

Buy Any 3 - Take 10%
14-Pin, dual in line .545
16-Pin, dual in line .50
TO-5, 8 or 10 pins .29

Poly Paks Will Never Be Undersold!

'HAM' UHF 400 MC HIGH POWER TRANSISTORS

Only **\$3.95** 3 for \$10.
By RCA or equal 2N3632, NPN, 23 watts, 3 amps, TO-60 case, with stud mtg. VCEV max 65.

The lowest price digital clock kit (with cabinet) as far as we can see in U.S.A. Scientific Devices' engineering dept. took extra patience in designing to give you the finest digital clock kit using the latest techniques in an easy-to-understand booklet. The cabinet-making section gives it the "interior decorating" touch so that it may fit into any room at home, shop or office. Walnut laminated tapered front cabinet, with gold-line front. Tapered legs for easy viewing. Large G.E. 7-segment fluorescent "blue-green" polaroid glow for the latest easy-viewing. FEATURES: 6 display tubes, completely etched and thru plated circuit board, all IC's. Includes BCD outputs for use with timer options, may be wired for 12 or 24 hour display. Indicates HOURS, MINUTES, SECONDS. 115 VAC 60 cy. Gift packed. Wt. 3 lbs. + 8" x 5 1/2" x 3" case

ALPHA-NUMERIC 7-SEG. READOUTS 2.50

Fluorescent Blue-Green 0-9 numerals, decimals and letters.
H. x W. Characters Filament V.
MINI-7* 1.75 x 1.7" .360 x .570" 1.5V AC/DC 42 mils Socket - 50c
SLIM-7* 1.6 x 0.375" .40 x .20" 1.5V AC/DC 42 mils Socket - 50c
*Compatible to 7-segment driver IC's.

Dollar Stretchers

- 3 - "LEDS", visible, micro-miniature, axial leads \$1
- 2 - "LEDS", infrared, jumbo, TO-18 \$1
- 2 - "LEDS", visible, jumbo, red, TO-18 \$1
- 1 - "LEDS", invisible, parabolic reflector, RCA \$1
- 1 - PHOTO TRANSISTOR, with darlington amp filter, lens \$1
- 2 - PHOTO TRANSISTORS, with darlington amp, 2N5777, GE \$1
- 4 - PHOTO CELLS, Clairex, pancake, 40K-70 ohms \$1
- 5 - SOLAR CELLS, round, sq, rect., sun power circuits \$1
- 2 - SOLAR SENSORS, TEXAS, H-35, MATCHVIS, visible \$1

DIGITAL CLOCK KIT

By Scientific Devices



Only **\$57.** WITH CASE
Buy 3 - Take 10% off
* Smaller & more compact

MINI-7 3 for \$6.
SLIM-7

8-DIGIT ELECTRONIC POCKET CALCULATOR BATTERY \$110vac 79.95 LED Display

Completely wired, ready to use! Not a kit - hours saved! Most economical and advanced battery operated pocket calculator under \$100. Makes use of the smallest single chip LSI (Large Scale Integration), LED display technology and a unique snap-action keyboard. The 9V battery can be thrown away after use or recharged with the AC power charger (included). Performs Addition, Subtraction, Multiplication, Division functions, including Chain or Mixed Multiplication and Division, as well as true "credit" balance up to 10 digits. For added convenience and simplicity the decimal point is fixed to two places in the eight digit display. Additional display indicators denote overflow beyond the eight digits and negative result (minus sign). Includes simplified instruction booklet. Factory guarantee. Gift packed. Size: 3 1/4" x 5 1/2".

Buy 3 - Take 10%



EPOXY FULL WAVE SILICON BRIDGE RECTIFIERS

Code: 2 amp TO-5 case
6 Amp 1/2 x 1/2 x 3/16 sq

Terms: add postage, cod's 25%. Rated: net 30
Phone Orders: Wakefield, Mass. (617) 245-3829
Retail: 211 Albion St., Wakefield, Mass.
C.O.D.'S MAY BE PHONED IN

15¢ CATALOG on Fiber Optics, 'IC's, Semi's, Parts

POLY PAKS
P.O. BOX 942H LYNNFIELD, MASS. 01940

DRAKE ML-2 new with $\frac{3}{8}$ antenna \$250 prepaid. Trade to SSVT setup. Cline WA7TMR, Box 216, Logan, Utah 84321.

TELETYPEWRITERS — Kleinschmidt, reconditioned, reasonable. Mark/Space Systems, 3563 Conquista, Long Beach, Ca. 90808. 213-429-5821.

B. & W. 6100 FOR SALE, low mileage, factory inst. F.S.K., excellent cond. C. E. Heisler, 115 Dixie Drive, Red Lion, Pa. 17356. Phone 717-244-2212.

470 PF. BUTTON-MICA by-pass capacitors, 5 for \$1.00 postpaid. Specify bulkhead or standoff type. S.a.s.e. for list of other quality components. CPO Surplus, Box 189, Braintree, Mass. 02184.

WANTED — BIRD MODEL 43 thru line wattmeter, and signal generator with calibrated output to 175 MHz. Will pay good price. Don Wood VE7BVO, 800 Stockwell Ave., Kelowna, B. C. 763-7254.

HAVE I GOT A DEAL FOR YOU! Unusual values full reconditioned guaranteed equipment. Listed alphabetically by manufacturer. Drake 2B \$169, 2NT \$109, RV4 \$79, TR4 \$429, TR6 \$395, Galaxy 300 with supply \$149, GT550 both supplies \$395, RF 550 \$49. Gonset Communicator IV (six) \$99. Hallicrafters HT 37 \$149, SX101A \$149, Hammarlund HQ170C \$149, HQ170A/VHF \$199, Heath SB301 CW Filter \$199, Military R 390A/URR \$495, National NCX5 both supplies \$349, NC173 \$69, Swan 260 \$295, Tempo DC1A \$69, Tempo 200 Linear \$339. Lots more. Get complete listing. New Drake, Galaxy, Hallicrafters, HyGain, Kenwood, Newtronic, Regency, Tempo, Stan Burghardt, Box 73, Watertown, S. D. 57201 Phone 605-886-3767.

WANTED: SWAN MARK 6B LINEAR, and TV-2C Transverter. Russell, 19680 Mountville Drive, Maple Heights, Ohio 44137. 216-662-2175.

SELL — COLLINS KWM-1. Mint cond. with 516E-1 DC & Homebrew AC supply. Best offer. 815-725-2900. Ed Gerber WB2PWV/9, 1705 Willowbridge Rd., Joliet, Ill. 60435.

MASSILLON AMATEUR RADIO CLUB will hold its annual Auction and Flea Market in Massillon, Ohio on Dec. 1, 1972 at the Amherst Shopping Center. Flea market starts 6:30 p.m. Send a card for bulletin giving details and directions, to W8NP, Box 8711, Canton, Ohio 44711.

RECIPROCATING DETECTOR PARTS KIT. Write Peter Meacham Associates, 19 Loretta Road, Waltham, Mass. 02154.

URGENTLY NEEDED: solid state VLF receiver, RAK, AN/URM-6, Rustrak recorder and/or tape, professional weather instruments, for research programs by children. Dr. R. B. Ammons, 411 Keith, Missoula, Montana. 59801. Or call collect evenings.

FOR SALE: HW100 w. AC/DC supplies \$225. West German 500W two-meter linear 4CX250B (new) \$350. Same for 432 MHz \$375. Andrews 4' dish \$25. Semco transistor VFO (48 MHz, new) \$17.50. Henco two-meter TX module (6330, new) \$25. Ingwersen, 33 Jewett Street, Georgetown Mass. 01833, 617-352-2858.

22nd ANNUAL DAYTON HAMVENTION will be held on April 28, 1973 at Wampler's Dayton Hara Arena. Technical sessions, exhibits, hidden transmitter hunt, flea market, and special program for the XYL. For info write Dayton Hamvention, Dept. H, Box 44, Dayton, Ohio 45401.

ESTATE OF WLFIA: SB-102; SB-220; SB-600; EV-638 mike; AM-2 SWR bridge; IM-18 VTVM; brush cleve phones; Triplet tube tester; Koss stereo phones. Peter was a science teacher all his life and his assembly of these units is beautiful — like commercial work. Listed and checked over by KIRA. For prices write: Mrs. Peter Householder, RFD 1, Pawlet, Vt. 05761.

COUNTER MAN, Ham business, NYC area, Box NY, Ham Radio, Greenville, N. H. 03048.

YOUR AD belongs here too. Commercial ads 2¢ per word. Non-commercial ads 10¢ per word. Commercial advertisers write for special discounts for standing ads not changed each month.

Read about it this month in HAM RADIO Magazine

TRI-COM's newest electronic product for Ham engineers!

In an article entitled "A Micro-Strip Monimatch" in the Dec. issue of HR, TRI-COM introduced their new VHF and UHF VSWR Indicators. Features include:

Range: VHF Model 10 - 40-200 mHz
UHF Model 20 - 200-600 mHz

In-line Construction: can be left in line permanently

Insertion VSWR:
Model 10 - 1.06/1 maximum
Model 20 - 1.15/1 maximum

Power Rating: 100 watts
impedance:
50 ohms

VSWR Indicators are available in a kit which includes a high-quality G-10 PC board, schematic, parts list, assembly instructions plus all components to be mounted on the PC board.*

VHF Model 10 - \$13.50 each
UHF Model 20 - \$12.50 each

All prices 1st class postpaid USA. All items are available immediately from stock.

TRI-COM

12216 Parklawn Drive
Rockville, Maryland 20852
(301) 770-5585

*Mini-box, meter, balancing resistors, switch and pot are to be provided by user as indicated in Dec. article.

... SPECIAL SALE ... AN/PRM-10 GRID DIP METER

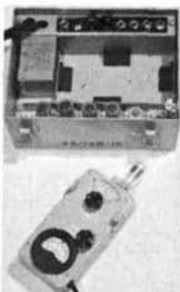

Unusual buy in best military grid dip meter. Includes wavemeter, cw and internal modulation functions. Coverage: 2-400MHz. Power supply and controls in case, RF head connected by cable—similar in operation and function to Measurements 59 Megacycle Meter. All units checked, guaranteed satisfaction or money back. Most in new or like-new condition.

Price FOB Monroe —

\$65

— OTHER TEST EQUIPMENT —

Also in stock, wide range of used test equipment, military and commercial. Signal generators, oscilloscopes, voltmeters, frequency standards, counters and more. HP, Tektronix, Fluke, Measurements, Polarad, etc. All equipment shipped same guarantee as grid dip meter above — money back (less shipping cost) if not satisfied. Send self-addressed, stamped envelope for current list.

GRAY Electronics
P. O. Box 941, Monroe, MI 48161
Specializing in used test equipment

IRON POWDER TOROIDAL CORES

CORE SIZE	41 Mix Green 'HR' 20 kc - 100 kc $\mu=75$	3 Mix Gray 'HP' 50 kc - 1 mc $\mu=30$	2 Mix Red 'E' 500 kc - 30 mc $\mu=10$	6 Mix Yellow 'SF' 10 mc - 90 mc $\mu=8$	10 Mix Black 'W' 30 mc - 150 mc $\mu=7$	12 Mix Grn-Wh '1RN-8' 60 mc - 200 mc $\mu=5$	Outer Diameter (inches)	Inner Diameter (inches)	Height (inches)
T-200	\$2.50	\$2.75	\$3.00	\$3.50			2.000	1.250	.550
T-130	1.50	1.75	2.00	2.50			1.300	.780	.437
T-106	.95	1.00	1.00	1.50			1.060	.560	.437
T-94	.70	.75	.75	.95			.942	.560	.312
T-80	.55	.60	.60	.80	.90		.795	.495	.250
T-68	.45	.50	.50	.65	.75		.690	.370	.190
T-50	.40	.45	.45	.50	.60	.85	.500	.303	.190
T-37	.30	.40	.40	.45	.45	.55	.370	.205	.128
T-25	.25	.30	.30	.35	.40	.45	.255	.120	.096
T-12	.25	.25	.25	.25	.25	.35	.125	.062	.050

Sustained Availability

Postage 50 Cents

AMIDON

Associates

12033 OTSEGO STREET
NORTH HOLLYWOOD, CALIF. 91607

FERRITE BEADS: .125" x .125", $\mu = 900$. With Spec Sheet & Application Notes Pkg of 12, \$2.00

KILOWATT TOROID BALUN KIT: Still only \$5.00

EXPERIMENTER'S 2 CORE TOROID KIT—This famous kit contains cores, wire, and charts so that you can make your own high Q modern inductors for hundreds of practical applications.: \$1.50

CAPACITOR TEST METER



1% Accuracy
5 Ranges

10-pf to .1 MFD F.S.

PRICE **\$125.00**

(Cash or check with order 5% off)
Units shipped C.O.D. unless cash with order.

ORDER FROM **MICON, INC.**

P. O. BOX 627
FARMINGDALE, NEW JERSEY 07727
201-681-7770

DIGIPET-60

Digipet-60
Frequency
Counter
1 KHz-60 MHz
(130-160 MHz with
optional converter)
only **\$299**



A frequency counter with a range of 1 KHz to 60 MHz (or 130-160 MHz when used with our Digipet-160 Converter). With a resolution of 1 KHz or 1 Hz (at 1 ms. or 1 s. gate times). It can be operated on either AC or DC, with complete overload protection. Plus a stability aging rate of 1 part in 10⁵/week. And the whole unit is a mere 7" deep by 2 1/2" high!

Superb precision quality at less than kit prices. Call or write for literature and trade in or our **LOW INTRODUCTORY PRICE 1 YEAR WARRANTY. NO ONE ANYWHERE BEATS OUR DEAL!**



AMATEUR-WHOLESALE ELECTRONICS
8817 S.W. 129 Terrace • Miami, FL 33156
Days (305) 233-3631
Nights-Weekends (305) 666-1347

WANTED WANTED

MILITARY SURPLUS ELECTRONIC EQUIPMENT, RT-463A/ARC-34B, R-750 /ARC-34C, RT-742/ARC-51BX, RT-651/ARC-95, RT-698/ARC-102, RT-823/ARC-131, RT-857/ARC-134, RT-384/ARN-52, R-1388/ARN-82, R-1391/ARN-83, APN-158, APN-171, PRS-7, PRC-74B, GRC-106, UCL-9, 618T, 860E-1 OR 2, 490T COUPLER, 807A, 51Y-4, CU-1658A/ARC, WRITE WITH DETAILS AS TO CONDITION FOR QUICK CASH QUOTE OR WILL TRADE FOR NEW HAM GEAR, SLEP ELECTRONICS COMPANY, 2412 HIGHWAY 301N, ELLENTON, FLORIDA 33532, PHONE 813-722-1843 BILL SLEP.

SLEP ELECTRONICS CO.

BOX 178H, 2412 HIGHWAY 301 N,
ELLENTON, FLORIDA 33532 - PHONE (813) 722-1843



MEMORY-MATIC 8000 DELUXE Capacity for 8000 bits in 8 Read/Write Pluggable Memories. Each memory can store either a single message or a number of sequential messages. Near-full and Overload alarms, "Message Stop" for char. insertion, "Full Control" weight ratio, message interrupt switch, var. trans. delay, 115/220 VAC, 50/60 Hz, Incl. SM-21B and MST-60 features. Sh. wt. 8 lbs. **\$398.50** (Incl. 3-500 and 1-1000 bit memories.)

Additional Memories 500 bit **\$21.50**
1000 bit **\$37.50**



MEMORY-MATIC 500-B 500 or 800 bit R/W memory. Stores either a single message or a number of sequential messages. "Message Stop" for char. insertion, Near-full and Overload alarms, remote control for Stop/Start of message. Incl. SM-21B features. Sh. Wt. 4 lbs. **\$198.50** (500-bit memory)
\$219.50 (800-bit memory)



SPACE-MATIC 21-B This SWITCHABLE keyer gives you "eight-keyers-in-one". Rear switches can delete dot or dash memories or char./word spacing. Instant start, self-completing dots, dashes and char./word spacing, Adj. weighting, sidetone/speaker, dot-dash memories lmbic, 115 VAC or 12 VDC (SM-21B only). Sh. wt. 4 lbs. **\$89.50**



CRICKET 1 The "feature-packed" moderately-priced keyer! Keyed time base, jam-proof spacing, sidetone/speaker. Rear controls for weight, speed, volume, tone, auto-semi-auto., tune. 115 VAC or 12 VDC. Sh. wt. 3 lbs. **\$49.95**



VHF FREQUENCY STANDARD — FMS-5 Cal. receive and transmit crystals in 10, 6, 2 and 1 1/4 meter FM bands. Markers for all FM channels. Check deviation. Precision 12 MHz crystal. No unwanted markers. Osc. and output buffered. Sh. wt. 2 lbs. **\$44.50** (Less Batteries)



METEORIC SCATTER TIMER — MST-60 Precision timer for meteoric scatter communications. 60 Hz time base provides 15, 20, 30, and 60 second output. Synchronized to WWV. Automatic and manual outputs. Sh. wt. 2 lbs. **\$49.50**

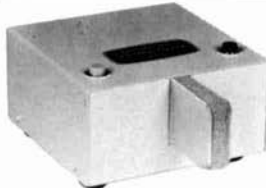

ELECTRONIC FEATHER TOUCH KEY A completely solid-state key. Detects mere touch of finger. Use as single or twin lever key. Operates with all positive or negative ground digital keys. Sh. wt. 2 lbs. **\$22.95**
\$27.95 (Remote S/S Swts. for MM-500B and MM-8000)



HF FREQUENCY STANDARD — FMS-3 Markers at 5, 10, 25, 50, 100, 200 and 400 kHz. 400 kHz crystal. No unwanted markers. Latest low-power ICs. Osc. and output buffered. Sh. wt. 2 lbs. **\$32.95** (Less Batteries)



2-METER PREAMP 20 dB Gain, 2.5 N.F., 12 VDC, Size 1 x 1 3/4 x 1/2, Diode protected MOS-FET. Major components separately shielded. 90-day guarantee. Sh. wt. 4 oz. **\$9.50** Kit
\$12.50 Wired Operation
Option for 150-250 VDC **\$2.95**

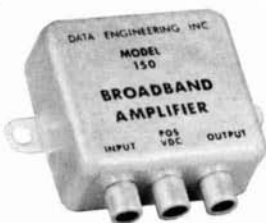

BROADBAND PREAMP 1-30 MHz, 36 dB gain dropping to 19 dB at 30 MHz. 3 dB Max. N.F., 12 VDC, metal case with mounting lugs. 2 x 1 3/4 x 3/4. 90-day guarantee. Sh. wt. 6 oz. **\$17.95**



SEND FOR CATALOG

5-YEAR GUARANTEES



DATA ENGINEERING, INC., 5554 Port Royal Road
Ravenworth Industrial Park, Springfield, Va. 22151

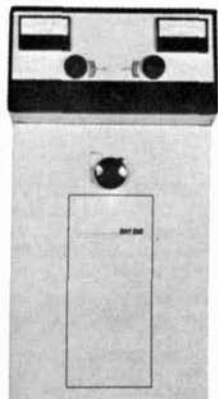

THE HENRY 3K-A

COOL AND EASY MAX. LEGAL POWER • SSB, CW, RTTY or SSTV THROUGH COMMERCIAL RATINGS • 3.5 TO 30MHz • CONTINUOUS DUTY • SILVER PLATED PI-L PLATE TANK • DC

RELAYS • ALC • BUILT IN SWR BRIDGE • OUTPUT POWER 2KW MIN. IN COMMERCIAL SERVICE • THE LINEAR FOR THE CX-7A • \$995

YOU will never know how little it costs to own THE incomparable CX-7A or Henry 3K-A until YOU write or phone us and let us know the trade in deal YOU WANT.

We usually say yes! NO ONE ANYWHERE BEATS OUR DEAL.



signal/one CX-7A

exclusive export agent for signal/one



signal/one

- 160-10 Meters — 300 Watts
- Transceiver or split frequency with two built in VFOs — CW keyer built in
- IF shift — new patented QRM remover
- IF noise blanker — digital noise frequency readout — superb computer grade construction by CMI
- AFSK keyer — adjustable output power — broadband tuning — output wattmeter and reflected power meter **\$2395**

AMATEUR-WHOLESALE ELECTRONICS
8817 S. W. 129 Terrace-Miami, FL 33156

Telephone — days (305) 233-3631
— nights and weekends call (305) 666-1347
Use your Master Charge card

JEFF-TRONICS

**SURPLUS ELECTRONICS
TUBES
PARTS
SEMICONDUCTORS
TEST EQUIPMENT**

TOP QUALITY - LOWEST PRICES

NEW CATALOG — \$.25 HANDLING

JEFF-TRONICS

4252 Pearl Rd., Cleveland, OH 44109

Just Printed!

Application Rules FOR
TTL INTEGRATED CIRCUITS
INCLUDING Operating
Instructions FOR ALL
POPULAR MODELS

Send 50¢
for your copy
FREE WITH ANY ORDER
OVER \$5.00



MINITRON 7-SEGMENT
READOUT \$3.70

Digital Clock
Semi-kit

15 IC'S & 4 MINITRONS (ONLY)
120 VAC \$35.00

SEND 25¢ FOR CATALOG



Arizona Semiconductor

PO BOX 112

GOODYEAR, ARIZONA
85338

BUILD YOUR OWN FM TRANSCEIVER

for less than \$100.00

Both 2 Meter and 220 MHz model, easily assembled solid state modules for VHF-FM construction. Kits include predrilled G-10 circuit boards. You supply the cabinet.

Complete receiver kit: \$59.95
Complete 1 watt transmitter kit: \$39.95
Ten Watt power amplifier kit: \$29.95

Be sure to specify whether for 144 MHz or 220 MHz 146.34, .52, .94; 220.98 or 224.98. Receive or transmit crystals \$4.00.

Write for brochure.

VHF ENGINEERING — W2EDN

1017 Chenango St., Binghamton, N. Y. 13901



OMEGA-T ANTENNA NOISE BRIDGES

Precision bridges with a broadband signal source permits you to measure both antenna resonant frequency and antenna impedance at the resonant frequency when used with your receiver.

- A must for the serious antenna enthusiast.
- Replace VSWR bridges or other antenna test equipment.
- Get optimum performance from all types of mobile and fixed antennas.

MPQ INDUSTRIES Model TE 7-01 1-100 MHz
P. O. Box 217 \$29.95 ppd
Hernando, MS. Model TE 7-02 1-300 MHz
38632 \$39.95 ppd

THEY SPEAK YOUR LANGUAGE

USER NOTES

User Notes is applications note series on the latest linear and digital IC's with construction projects such as the Digital Multimeter and Calculator kits. Also included is information on state-of-the-art electronic components. This series is available only on an annual subscription basis from Environmental Products and contains circuits never published elsewhere.

Thousands of beginning and advanced hobbyists have found the series informative and stimulating. The approach is nonmathematical and oriented towards actually building the circuits rather than theorizing about them. Below is a partial list of the current topics. Subscribe now and receive all the back issues FREE.

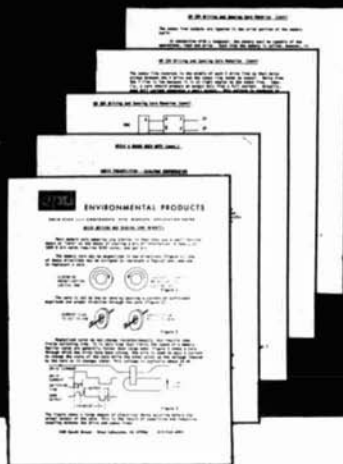

- UN312 CALCULATOR CIRCUIT - 10 DIGIT
- UN313 TTL DESIGN GUIDE
- UN316 POWER SUPPLIES FOR DIGITAL CIRCUITS
- UN317 DECIMAL COUNTING AND SEVEN-SEGMENT DISPLAYS
- UN319 THE 741 OPERATIONAL AMPLIFIER
- UN321 HIGH SPEED VOLTAGE COMPARATORS
- UN324 INTERFACING RTL WITH TTL AND DTL LOGIC
- UN326 DUAL OUTPUT TRACKING OP-AMP SUPPLY
- UN329 ELECTRONIC DICE GAME
- UN330 HIGH ACCURACY LOW COST DIGITAL MULTIMETER
- UN334 DRIVING AND SENSING CORE MEMORIES
- UN335 DECADE COUNTING AND LED DISPLAY
- UN337 LIGHT EMITTING DIODES
- UN338 DIGITAL STOP WATCH CIRCUITRY
- UN339 A 12-HOUR DIGITAL CLOCK
- UN347 AUTOMATIC TELEPHONE DIALER
- UN350 DECADE COUNTER, LATCH, DECODER/DRIVER AND LED DISPLAY IN ONE PACKAGE
- UN352 A UNIVERSAL PRECISION VOLTAGE REGULATOR

The series is mailed four times per year. Subscription rates are \$5 annually for the US except Alaska and Hawaii which are sent Air Mail at \$6. Canada and Mexico \$6. All other countries \$7.50.

KEYBOARDS



This keyboard is a must for repeater and relay applications. The recently developed elastomeric process is responsible for both the low cost and very long life. The key characters can not be rubbed or chipped off. All contacts are single pole, normally off with one side of each switch connected to a common buss.

The KB-1 will interface directly with all standard logic. Contacts are rated at 40 mA and 25 volts. The housing measures 3" x 3" and has a maximum depth of 1/2". We supply applications information including a circuit to convert each switch to a BCD output. The KB-1 comes straight from the factory at less than surplus prices.

KB-2 sixteen key calculator keyboard available—same price.

KB-1 Touch-Tone Keyboard \$7.95



ENVIRONMENTAL PRODUCTS

BOX 1014 Glenwood Springs, CO 81601

MORSETYPER

send
perfect
code

get automatic CW
with continuously
variable speed
from 5 to 55 WPM.



\$198.—

- All solid-state.
- Fully assembled and ready to plug-in and operate.
- Features built-in audio-oscillator/amplifier, monitor, and audio output jack.
- Regulated A.C. power supply suits both 115 and 220-240 Volt operation.
- Deal direct with the manufacturer and save.
- Phone or write for our free illustrated brochure.
- Send your check or money order for \$198.00 (plus Sales Tax for California residents) and we pay freight or order C.O.D. freight collect.

MARTRONICS

Post Office Box 4646
Anaheim, California 92803
Telephone (714) 628-7571

GATEWAY ELECTRONICS

8123 PAGE AVENUE
ST. LOUIS, MISSOURI 63130
314-427-6116

- 450 MHz TRANSMITTER w/tubes — 20 watts output — from Motorola T446A transceiver — with diagram — Ship wt. 7 lb. \$9.50
- 450 MHz RECEIVER w/tubes — from Motorola T446A Transceiver — with diagram — Ship wt. 7 lb. \$9.50
- 6/12 VOLT DC POWER SUPPLY STRIP — from Motorola T446A Transceiver — Ship wt. 15 lb. \$9.50
- ALL 3 OF ABOVE WITH CASE — Ship wt. 50 lb. \$25.00
- RECHARGEABLE BATTERIES 6 VOLT-Alkaline-Eveready #565 — 4 Amp — 5 1/4 x 2 3/4 x 2 3/4 w/charger (buy two for 12 volts) — Ship wt. 7 lb. \$4.00
- 2 INCH SCOPE TUBE #902A — new — w/diagram — ideal for RTTY, Oscilloscope, etc. — Ship wt. 2 lb. \$5.00
- TOUCH TONE PAD — 12 button — new — manf. by W. E. — w/diagram — Ship wt. 1 lb. \$19.50
- THUMBWHEEL SWITCHES
— 0.5 x 2.125 x 1.78 — 10 position decimal \$2.75
— 10 position BCD & Compliment \$3.75
— End Plates (per pair) \$1.00
- MINIATURE SIZE
— 0.312 x 1.3 x 1.3 — 10 position decimal \$2.00
— 10 position BCD & Compliment \$2.75
— End Plates (per pair) 50¢

\$5.00 Minimum Order
Visit us when in St. Louis

LIMITED OFFER • NEW R-390 A/URR \$1395

The finest military digital receiver available. .5 to 32 MHz unused. In the original package with manual, accessories, and spare parts. Guaranteed. F.O.B. N. J.
MILITARY ELECTRONICS CORP.
76 Brookside Dr., Upper Saddle River, N.J. 07458
(201) 327-7640

GENAVE GTX-2

FM Transceiver — 30 WATTS OUTPUT — ALL SOLID STATE (no tubes) — 10 Channels — 100% duty cycle — and mobile mounting bracket — Professional level control — distinguished Avionics Mfg. — (Amateur license not required) — price \$212.50 with AC supply (reg. \$299.95)

AMATEUR-WHOLESALE ELECTRONICS
8817 S.W. 129 TERRACE • MIAMI • FL • 33156
Phone: (305) 233-3631 • Nights-Weekends (305) 666-1347

IDENTIFIER FOR FM REPEATERS ID-403

- AUTOMATIC TIMING
- PLUG-IN MEMORY
- ALL SOLID STATE
- 117VAC POWER SUPPLY
- TONE BURST ENTRY OPTION

Complete, ready to go . . .
\$199.50
\$239.50 (with tone burst option)

WRITE FOR BROCHURE

GURTS ELECTRO DEVICES

BOX 4090 • MOUNTAIN VIEW, CALIF. 90400 • TEL. (415) 964-3130

F.C.C. EXAM MANUAL

The Original Test-Answers exam manual that prepares you at home for FCC First and Second class licenses. Includes Updated multiple choice tests and key Schematic diagrams. PLUS - "Self-Study Ability Test." -- ONLY: \$9.95 Postpaid.

Tests-Answers for
FCC First and
Second Class
Commercial
Licenses

COMMAND PRODUCTIONS P.O. BOX 26348-K
RADIO ENGINEERING DIVISION SAN FRANCISCO, CALIF. 94126

2 METER FM HEADQUARTERS

Rigs for every use . . .
for every pocketbook!

STANDARD



STANDARD SRC-146A

5 Channels — .94/.94 and .34/.94 supplied
.3V receiver — 2+W transmitter —
PL available
Compact — 8" h x 3" w x 1 1/2" d
Full line of optional accessories includes
external speaker-mike — desktop
charger — "stubby" antenna — and
more!

Available NOW! —

Only \$289.00



ALL PURPOSE STANDARD 826MA

12 channels (4 with crystals)
10 Watt output
PL available
Hot MOSFET receiver, helical resonators

Only \$369.00

NEW

- 220 — 12 Channels
- 10 Watt xmtr — .5V rx
- Xtals for 223.5 MHz supplied

Only \$329.00

- Meter for Power Out,
Signal Strength and
discriminator

Size: 2.36" x 5.9" x 7.66"

Antennas: 50W Power Amp. (TEMPO 522) Available!

TEMPO/CL 220



TEMPO SOLID-STATE POWER AMPS

MODEL	DRIVE POWER	OUTPUT POWER	PRICE
1002-3	5-25 watts	100-135 watts	\$220
1002-3B	1-2.5 watts	120-130 watts	\$235
802	5-12 watts	70-90 watts	\$180
802B	1-2.5 watts	80-90 watts	\$195
502	5-15 watts	35-55 watts	\$105
502B	1-2.5 watts	45-50 watts	\$130
242-A2	1-2.5 watts	25-30 watts	\$ 85

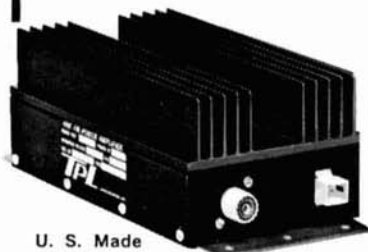

U. S. Made

And many more from SBE/Clegg/Gladding/Kenwood/Tempo/Antenna Specialists/Larsen

Make ERICKSON your headquarters for all your FM needs . . .

SEND QSL FOR COMPLETE SPECIFICATIONS

ERICKSON COMMUNICATIONS

4653 N. Ravenswood Ave., Chicago, Ill. 60640 (312) 334-3200

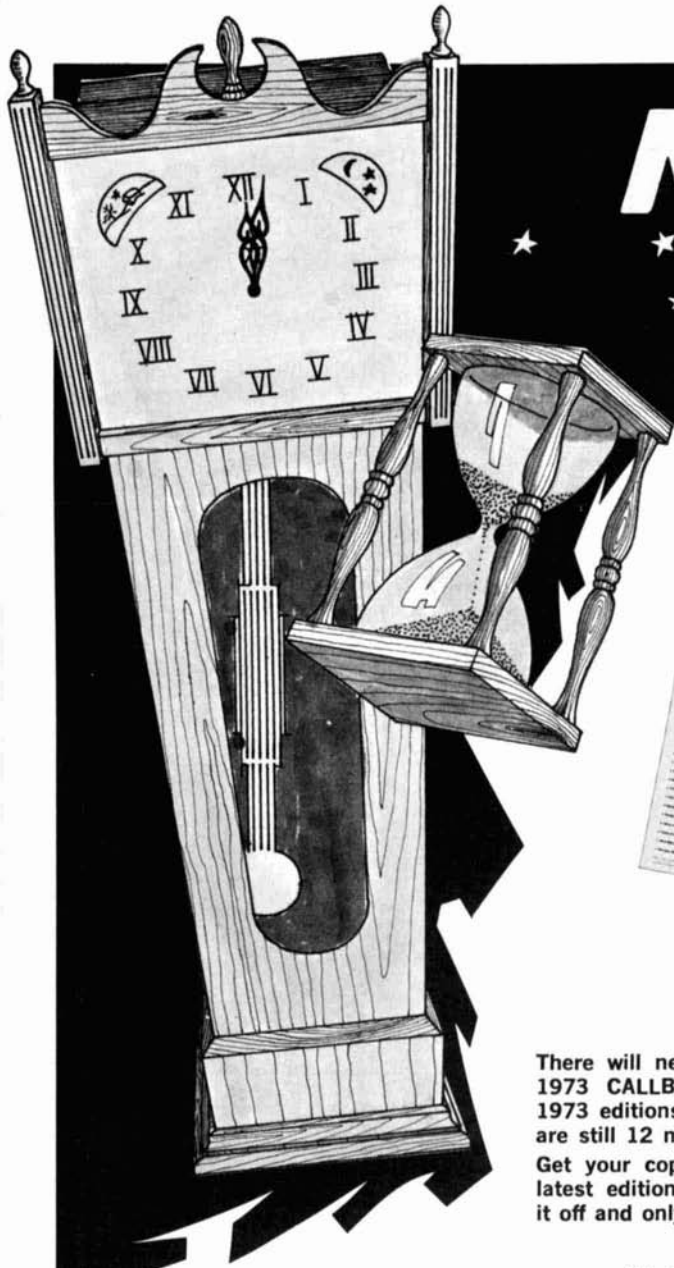

NOW

is
1973
Callbook
time

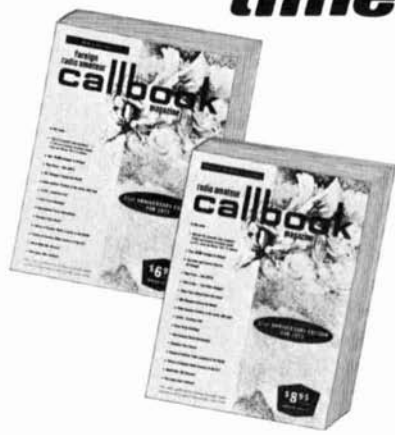

There will never be a better time to get your 1973 CALLBOOKS. Here are the brand new 1973 editions — Don't delay, the next editions are still 12 months away.

Get your copies today and you will enjoy the latest edition for the next twelve months. Put it off and only you will be the loser.

The CALLBOOK is a vital part of every amateur radio station. Over 285,000 listings in the US CALLBOOK and nearly 200,000 in the DX Edition make these two volumes an indispensable reference. Not only do the CALLBOOKS list QTH's, but they also have page after page of valuable charts, tables and maps all designed to make your operating more efficient and more fun.

To make these volumes even more valuable special service editions are issued each 3 months, but only to owners of the 1973 CALLBOOKS, which give complete cumulative updated information for the 1973 CALLBOOKS.

US CALLBOOK (less service editions) Just \$8.95	DX CALLBOOK (less service editions) Just \$6.95
--	--

US CALLBOOK (with service editions) \$14.95	DX CALLBOOK (with service editions) \$11.45
--	--

Mail orders add 50¢ per CALLBOOK postage and handling.

See your favorite dealer or send today to:

WRITE FOR FREE BROCHURE RADIO AMATEUR **callbook** INC.
 Dept. E 925 Sherwood Drive
 Lake Bluff, Ill. 60044



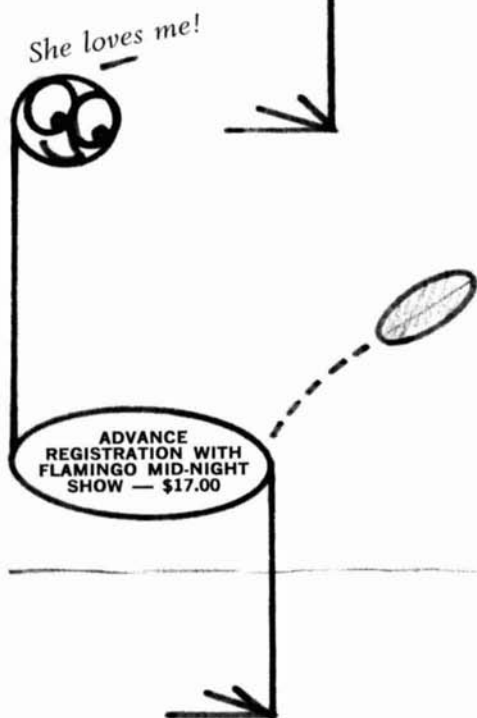
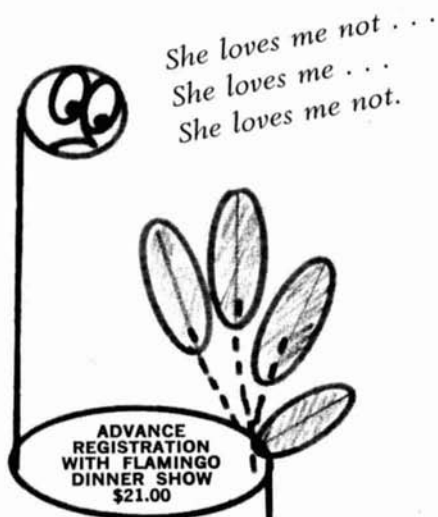
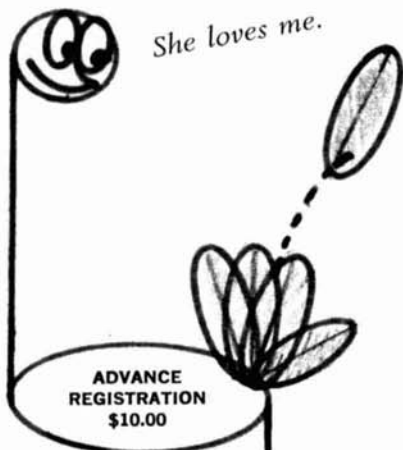

but it's easy to love
SAROC
JANUARY 4-6, 1973
sponsored by
Southern Nevada ARC, Inc.
Box 73
Boulder City, Nevada 89005



at the Flamingo
SAROC ROOM RATE
15.00 per night plus tax
Single or Double Occupancy
reservations to
FLAMINGO HILTON
LAS VEGAS, NEVADA

Send show reservations to SAROC

VISIT THE FLAMINGO'S NEW SPEAKEASY RESTAURANT & SALOON
Las Vegas' most unique dining spot

NEW! FROM MATRIC

QUALITY GEAR LOADED WITH FEATURES!



MODEL 10 • KEYSER MODEL 11 • PADDLE

No bulky batteries or awkward power cords with the Model 10 Keyer. Internal penlight cells and reed relay output produce a compact, portable, and versatile unit. Also available as a circuit board kit without case for custom installation.

Keyer Kit	\$21.90
Keyer Assembled	\$26.50
P. C. Board Kit	\$12.95
Sidetone Kit	\$ 4.95
Sidetone Assembled	\$ 6.95
Paddle Assembled	\$ 9.95



MODEL 20 DIGITAL DIAL

Tune your fixed or mobile transmitter, receiver, or transceiver with 100 Hz accuracy and no last digit jitter. The Model 20 Digital Dial connects to rigs with 5-5.5 Mhz VFO's with a single wire. It can also be used as a general purpose frequency counter.

Matching accessories coming soon.

Assembled and Tested	\$169.95
Crystal Time Base	\$ 29.95

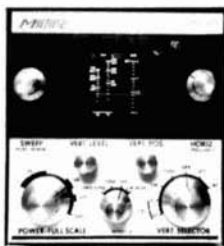

MODEL 31 MONITORSCOPE

Monitor RF output, read power output to 1500 watts, measure SWR to 3:1, and observe RTTY and trapezoid patterns all in a single instrument! The Model 31 also includes an RF actuated CW monitor, two-tone generator, and AC and DC vertical and horizontal inputs for general purpose use.

Assembled and Tested	\$169.95
----------------------------	----------



**SEE YOUR DEALER
OR ORDER DIRECT. PRICES F.O.B. SENECA, PA.**

BOX 235 • SENECA, PA. 16346 • PHONE: AREA CODE (814) 648-5122

LAST CHANCE BEFORE PRICE INCREASE

VANGUARD LABS is increasing the price of all its products by as much as 30% beginning Jan. 1, 1973. If you order now you can still buy any Vanguard product advertised anywhere within the past 15 months at the low advertised price. Pass this information on to your friends and send your order in today. You'll be glad you did.

VANGUARD LABS

196-23 JAMAICA AVE., HOLLIS, N.Y. 11423



FM TRANS. T-278/U 152-174 MHz 25 watts
2 channel xtal controlled new with schematic
\$17.95

ARC R19 RCVR (R508) 118-148 MHz
Tunable, AM 9 tube superheterodyne with
schematic like new \$14.95



Westinghouse 3 PH Full Bridge Rectifier
290 V @ 75 A. 6 IN203 diodes new
\$4.95



Headset-Microphone H-63/U 600Ω earphones 100 ohm
mike suspended on headband new \$4.95

Chest Set AN/GSA6 adapts above to GRC-VRC equipment
NEW \$2.95



Potter & Brumfield industrial control relay
New KU-4129-2 SPDT, SPST 115 VAC 60 cps
\$1.00

Teletype tape 3/8" canary 10 rolls \$1.00



Modification Kit Zener diodes, transistors, etc. \$1.50 ppd
Sprague Electrolytic 90 MFD 500 VDC 75¢

Manometer Test Set 69-100 A 18" size "U" tube pressure
or vacuum measurements, tools and hardware included \$4.95

Temperature gauge for Jeeps #15124 100-220° F \$1.00
#20 gauge shielded cable teflon coated 3¢ per foot.

Motorola 2 mtr FM transceiver, 6 volt input, 7 watt
output. Model FMTRU-5-V with schematic, \$14.95.

Large quantity electronic equip. and parts in stock. All
inquiries answered. We also buy electronic parts and equip-
ment.

FRANK ELECTRONICS, 407 Ritter Rd., Harrisburg, PA 17109

INTRODUCING: SUPER CRYSTAL —

The New DELUXE DIGITAL SYNTHESIZER from **RP**

- TRANSMIT and RECEIVE OPERATION — SIMPLEX (transceive) and REPEATER MODES
- ACCURATE FREQUENCY CONTROL — .0005% accuracy
- STABLE LOW DRIFT OUTPUT — 20 Hz per degree C typical
- FULL 2 METER BAND COVERAGE — 144.0 to 147.99 MHz
- 10 KHz CHANNEL SPACING
- FAST ACTING CIRCUIT — 0.15 second typical settling time
- LOW IMPEDANCE OUTPUTS — 50 ohm output impedance both transmit and receive
- LOW SPUROUS OUTPUT LEVEL — similar to crystal output

Also Available:

- COMPLETE STATIONS (WITH SYNTHESIZER)
- PARTS AND KITS OF PARTS

SEND FOR FREE DETAILS & PRICES TODAY

Will Work With: STANDARD, REGENCY & OTHERS

\$30.00 will HOLD YOUR PLACE IN LINE for FASTEST DELIVERY

GIFT IDEAS FROM **RP** — FAST SERVICE!

TONE BURST ENCODERS AND DECODERS

- UP to 5 fixed tones (factory set)
- ADJUSTABLE — Duration — Output
- NO BATTERIES needed.
- FULLY ADAPTABLE
- EASY INSTALLATION
- CONTINUOUS TONE POSSIBLE
- FULL 1 YEAR RP Warranty



PRICES:

TB-5 5 tone std. encoder \$37.50
(1800, 1950, 2100, 2250, 2400 Hz.)

ST-2 Single tone decoder \$37.50
(Specify 1800, 1950, 2100, 2250, or 2400 Hz.)

Special tones — Inquire

Add \$1.80/unit for shipping
(Ill. residents add 5% tax)

A SPEECH COMPRESSOR THAT REALLY WORKS



RPC-3,3U Internal Unit
(\$24.95)



RPC-3C Cabinet Model
(\$34.95)

- Low distortion circuit.
- Fully wired & tested. NOT A KIT
- Works with phone patch.
- Internal units & modules work mobile.
- FULL WARRANTY — ONE YEAR
- INTRODUCTORY LOW PRICES (Illinois residents add 5% Sales Tax)



RPC-3M Module
(ONLY \$22.50)

Add \$1.00/unit shipping (RPC-3, 3U, 3M)
Add \$2.00/unit shipping (RPC-3C)

RP ELECTRONICS

BOX 1201H
CHAMPAIGN, ILL. 61820

This Christmas The World At His Fingertips It's Portable — BARLOW-WADLEY XCR30

CRYSTAL CONTROLLED RECEIVER

\$235.00

fob San Jose



**A COMPLETELY NEW
CONCEPT IN
PORTABLE RADIO DESIGN**

1. 0.5 TO 30 MHz CONTINUOUS COVERAGE - DIRECT READOUT
2. ANTENNA TUNING FOR MAXIMUM SENSITIVITY
3. AM CW SSB. (SELECTABLE USB AND LSB)
4. SELF POWERED BY SIX UM1 DRY CELLS
5. POWER JACK FOR EXTERNAL 6-12v. DC SUPPLY
6. HEADPHONE JACK
7. DRIFT FREE RECEPTION

For Further Information Write
NOONAN ASSOCIATES

2056 ALAMEDA WAY
SAN JOSE, CALIF. 95126

ACTIVE AUDIO FILTERS

CW: IC'S FOR SUPER HIGH PERFORMANCE

Get razor sharp selectivity
No impedance matching BW
(selectable) 180 Hz and
80 Hz Center frequency . . .
F = 750 Hz Skirts 60 db
down at 1/2F and 2F 4 op
amps, 2" x 3" PC Board
\$12.95 wired, tested,
guaranteed

LOW PASS:

Resistors set cutoff .5
to 20 kHz. Factory set
for 2.5 kHz; Input imp 1M;
Load > 2K; Gain = 1
Rolloff max 48db/oct, min
40 5 op amps, 2" x 3"

PC Board \$13.95 wired, tested, guaranteed
WRITE FOR FREE SPEC SHEETS! (DEALERS INVITED)

MFJ ENTERPRISES P. O. Box 494
State College, Ms. 39762

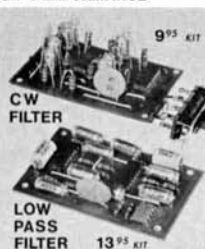

GROTH-Type

**COUNTS & DISPLAYS
YOUR TURNS**

- 99.99 Turns
- One Hole Panel Mount
- Handy Logging Area
- Spinner Handle Available



PRICES POST PAID
TC 2 — \$7.00
TC 3 — \$7.50
Spinner (-S) — \$1.00
Add \$0.75 for Air or UPS

Case: 2x4"; shaft 1/4"x3"
Model TC2: Skirt 2 1/2"; Knob 1 1/2"
Model TC3: Skirt 3"; Knob 2 3/8"

R. H. BAUMAN SALES

P.O. Box 122, Itasca, Ill. 60143

NOW

EXCLUSIVE 66 FOOT

MDR GAIN

75 THRU 10 METER DIPOLE

NO TRAPS — NO COILS — NO STUBS — NO CAPACITORS

Fully Air Tested — Thousands Already in Use

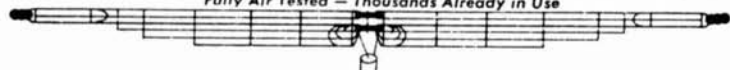

**IS
BACK**

#16 40% Copper Weld wire annealed so it handles like soft Copper wire—Rated for better than full legal power AM/CW or SSB-Coaxial or Balanced 50 to 75 ohm feed line—VSWR under 1.5 to 1 at most heights—Stainless Steel hardware—Drop Proof Insulators—Terrific Performance—No coils or traps to break down or change under weather conditions—Completely Assembled ready to put up—Guaranteed 1 year—ONE DESIGN DOES IT ALL: 75-10HD—ONLY \$12.00 A BAND!

Model 75-10HD . . . \$60.00	66 Ft. . . . 75 Thru 10 Meters	Model 75-40HD . . . \$40.00	66 Ft. . . . 75 Thru 40 Meters
Model 75-20HD . . . \$50.00	66 Ft. . . . 75 Thru 20 Meters	Model 40-20HD . . . \$33.00	35 Ft. . . . 40 Thru 20 Meters
	Model 80-40HD . . . \$42.00	69 Ft. . . . 80-40-15 Meter (CW)	

ORDER DIRECT OR WRITE FOR
FULL INFORMATION

MDR GAIN

300H Shawnee
Leavenworth, Kansas 66048

OR THRU YOUR FAVORITE
DISTRIBUTOR

VACATION

Will close Jan. 2, 1973
re-open Wed. Jan. 31

BC ELECTRONICS — c/o BEN COHN

MAILING ADDRESS

1249 W. Rosedale Ave., Chicago, Illinois 60660
Store: 5696 N. Ridge Ave., Chicago, Ill. 60660
312-784-4426 & 334-4463

EK-404 DELUXE KEYS \$124.95

ALL THE FEATURES YOU'VE ASKED FOR

- 115Vac AND -12Vdc
- READ JAN 1972 CO AND MAR. 1972 QST FOR REVIEW OF SIMILAR EK-402 PROGRAMMABLE KEYS

WRITE FOR BROCHURES

CURTIS ELECTRO DEVICES

803 X 6990 • MOUNTAIN VIEW, CALIFORNIA 94040 • TEL: (415) 964 2136

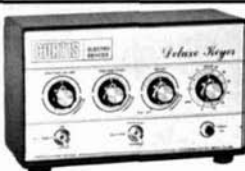

FREE CATALOG

HARD-TO-FIND PRECISION TOOLS

Lists more than 1700 items—pliers, tweezers, wire strippers, vacuum systems, relay tools, optical equipment, tool kits and cases. Also includes four pages of useful "Tool Tips" to aid in tool selection.

JENSEN TOOLS
4117 N. 44th Street, Phoenix, Ariz. 85018



Regency  **HR-212** (Reg. \$259) \$215 **HR-2A** (Reg. \$229) \$195

New! Model HR-212 12 channel 2 Meter FM Transceiver. 20 watts output power. \$259.00 Amateur Net. Latest, factory fresh, factory sealed cartons from the largest U.S. amateur FM distributor. Please see our other ads this issue.

AMATEUR-WHOLESALE ELECTRONICS
8817 S.W. 129 Terrace • Miami, FL 33156
Days (305) 233-3631
Nights-Weekends (305) 666-1347



WANTS TO BUY

All types of military electronics equipment and parts. Call collect for cash offer.

**SPACE ELECTRONICS division of
MILITARY ELECTRONICS CORP.**

76 Brookside Drive, Upper Saddle River
New Jersey 07458 • (201) 327-7640

RADIO COMMUNICATION

Many thousands of you have become familiar with the various Radio Society of Great Britain books and handbooks, but very few of you are familiar with their excellent magazine, Radio Communication.

We can now offer this fine magazine to you along with the other advantages of membership in the RSGB (such as use of their outgoing QSL Bureau) for \$9.95 a year.

order today from

comtec

BOOKS

Greenville, New Hampshire 03048

VHF-FM HEADQUARTERS FOR SOUTH FLORIDA

*Modify your Gladding 25
with our
Coincidence Detector*

- True FM Detector
- Improved Sensitivity
- Improved IF Gain
- Superior Squelch Action
- Install in just a few minutes

Complete G-10 epoxy board wired and aligned ready to install.

1 year warranty

\$19.95 ppd USA



\$349

Miida

DIGIPET 60/160

Here's the affordable professional grade counter you've been waiting for, to 160 MHz for just \$349.00 complete with scaler! And look at these features . . .

- Equiv. 8 digit display with 5 digit readout and display storage
- Overflow indicator
- Extremely compact (6.7" X 3.6" X 7.0") as shown above, with scaler, 4.5 lbs
- Both AC and DC operation (8 watts)
- Xtal stability: 1 part in 10⁶/week
- Resolution: 1 Hz
- Sensitivity 50 mV
- Full 1 year U.S. warranty
- Engineered & constructed for the professional.

In Stock: INOUE IC 20 \$259.50
INOUE IC 21 \$349.50

EMPORIUM SOUNDS OF POMPANO

51 North Federal Highway
Pompano Beach, Florida 33060
305-782-3464

Special Two Meter Transmitter kit for use through OSCAR 6

This filter type, sideband transmitter provides enough output (5-7 W. pep) to be used with the OSCAR 6 amateur communications satellite. Either a beam antenna, or a non-directional antenna with a small linear amplifier to provide about 80 watts effective radiated power should be used.

All semiconductors, PC boards, crystal filter, crystals, trimmers, coil forms, and ferrite chokes are supplied. Save money by using your own chassis, small resistors, capacitors, controls, and power supply.

Frequency control is by VXO. VXO crystals are supplied to cover the input range of the repeater. (Other frequency ranges supplied on request). All necessary construction and tune up information supplied. Order # DJ9ZR/OS.

Price, just \$101.75 Air shipped anywhere in U.S. or Canada.



VHF COMMUNICATIONS is the quarterly magazine for amateurs interested in VHF and UHF technology and equipment construction. It is the international, English edition of the well-known German publication UKW-BERICHT.

VHF COMMUNICATIONS provides sixty pages of modern, but practical construction articles in each issue. Described are transmitters, receivers, converters, transceivers, antennas, test equipment, etc. The designs reflect truly current technology. Solid state devices and printed circuits are used extensively. All mechanical construction data are included. However, for the amateur without fabrication facilities, special components, such as p.c. boards and stripline cavities are made available, readily and inexpensively.

SPECIAL OFFER

To new subscribers:

4 years (1969 through 1972) of **VHF COMMUNICATIONS** plus subscription to 1973. Supplied in Handsome, VHF Blue binders. \$20.25 (\$21.50 air mail)

Subscription rates US \$4.50 (\$5.75 air mail per calendar year). Single issues \$1.25. Sample \$5.00.



VHF COMMUNICATIONS

EAST
915 N. MAIN ST.
JAMESTOWN, N. Y. 14701

WEST
CIRCUIT SPECIALISTS
BOX 3047
SCOTTSDALE, ARIZ. 85257

CENTRAL
53 ST. ANDREW
RAPID CITY, S. D. 57701

WESTERN CANADA
1170 BASSETT CRES. NW.
MEDICINE HAT, ALB., CANADA



WALKIE TALKIE RT-196/PRC-6 RECEIVER- TRANSMITTER

47 to 55.4 MHz, 43 channels.

One (1) pre-set channel at a time, FM, Voice, range approx. 1 mile depending on conditions; one crystal used for Rec. & Trans. 13 Tubes. Battery power req.: 1.5, 45 & 90 VDC. Mic. Phone and Antenna are included. Uses BA-270 Batt. which is not included. Size 15 x 5 x 4 1/4; Wt. 3 1/4 lbs. Price: Less Batt., Used: **\$24.95**

RT-70/GRC RECEIVER-TRANSMITTER

47 to 58.4 MHz, FM continuous tuning; also 2 pre-set chan., Voice, power output 500 MW., 18 Tubes, power req.: 90 VDC @ 80 MA. 6.3 @ 360 MA. 6.3 @ 160 MA. (See available accessories below) Size 5 x 13 x 8; Wt.: 17 lbs. Price: Used **\$22.95**

AM-65/GRC AF AMPLIFIER

Three channel audio Freq. Amplifier used for interphone and radio monitoring of various types of GRC Rec.-Trans.; 7 Tubes, power req.: 135 VDC 35 MA. and 6, 12 or 24 VDC. (See below for accessories) Size: 4 1/4 x 13 x 7 3/4; Wt.: 15.5 lbs. Price: Used **\$14.95**

TECH MANUALS, including Schematics — For RT-196 or RT-70, \$7.50 Ea.; Manual, with Schematic — For AM-65, \$5.00; Schematics Only: \$1.00 Ea.

H-33/PT HANDSET — Used with above units: Used: \$5.95 — Unused: \$7.95

PP-281/GRC POWER SUPPLY — 12 Volt, used with RT-70 and AM-65. This unit plugs inside the AM-65 and supplies the voltages for both units. Price: Used \$8.95 All prices are F.O.B., Lima, Ohio. Dept. HR

FAIR RADIO SALES

P. O. Box 1105 • LIMA, OHIO • 45802

HELP WANTED! Two Way radio technicians. Must have experience with GE Tube and Solid State FM Equipment. Excellent wages. Health Insurance and Pension Plan. State experience, qualifications and previous employment in this field.

**DON COOK
COOK'S COMMUNICATIONS CORPORATION
160 N. Broadway, Fresno, Ca. 93701
209-233-8818**

WORLD QSL BUREAU

THE ONLY QSL BUREAU to handle all of your QSLs to anywhere; next door, the next state, the next country, the whole world. Just bundle them up (please arrange alphabetically) and send them to us with payment of 5¢ each.

5200 Panama Ave., Richmond, CA USA 94804

STAR-TRONICS

INDUSTRIAL AND GOVERNMENT ELECTRONIC SURPLUS

PARTS & PIECES FOR SCHOOLS, SHOPS, HAMS & HOBBYISTS
SEND FOR OUR LATEST ALL DIFFERENT
MONTHLY PICTURE CATALOG. NOW!

Box 17127, Portland, Ore. 97217

The voice of



is heard around the world



Here's why Thunderbirds outperform all other tri-banders:

- **Thunderbird's "Hy-Q" traps** provide separate traps for each band. "Hy-Q" traps are electronically tuned at the factory to perform better at any frequency in the band—either phone or CW. And you can tune the antenna, using charts supplied in the manual, to **substantially** outperform any other antennas made.
- **Thunderbird's superior construction** includes a new, cast aluminum, tilt-head universal boom-to-mast bracket that accommodates masts from 1¼" x 2½". Allows easy tilting for installation, maintenance and tuning and provides mast feed-thru for beam stacking.
Taper swaged, slotted tubing on all elements allows easy adjustment and readjustment. Taper swaged to permit larger diameter tubing where it counts! And less wind loading. Full circumference compression clamps are mechanically and electrically superior to self-tapping metal screws.
- **Thunderbird's exclusive Beta Match** achieves balanced input, optimum matching on all 3 bands and provides DC ground to eliminate precipitation static.
- 25 db front-to-back ratio.
- SWR less than 1.5 to 1 on all bands.
- 24-foot boom...none longer in the industry.
- Extra heavy gauge, machine formed, element to boom brackets, with plastic sleeves used only for insulation. Bracket design allows full mechanical support.
- Interlaced, optimum spaced elements for higher gain and better pattern control.
- 3 active elements on 20 and 15 meters. 4 active elements on 10 meters.

New 6-Element Super Thunderbird

Model 389

Suggested retail price, \$179.95

Improved 3-Element Thunderbird

Model 388

Suggested retail price, \$144.95

Fabulous 3-Element Thunderbird, Jr.

Model 221

Suggested retail price, \$99.95

Popular 2-Element Thunderbird

Model 390

Suggested retail price, \$99.95

Buy one today at your favorite Hy-Gain distributor!

HY-GAIN ELECTRONICS CORPORATION

P. O. Box 5407-WL, Lincoln, Nebraska 68505

**With Signal/One's CX7-A
you settled for the best.**



Now meet the rest of the best.

A few short years ago, Signal/One introduced the solid-state CX7-A. It was quickly recognized as the world's most advanced radio transceiver. It still is. Now, Signal/One is more than just the CX7-A. A lot more.

For openers, we've added two new receivers. One, the CR-1500, a dual-channel system is so advanced — in selectivity, sensitivity and versatility — you won't find anything like it this side of a research laboratory. The CR-1200 receiver, our other new one, features a single VFO. If it weren't for its bigger brother, it would be the finest receiver you could buy.



There's a new CT-1500 transmitter, the matching transmitter for use with the CR-1200 and CR-1500 receivers. It incorporates all modes of operation and includes the famous Signal/One RF envelope clipping, broadband tuning, full-automatic CW keying, and many other features.



We're also introducing a new transceiver, the CX-10, which contains several CX7-A features. In addition, it can be used with either our new AC or DC power supplies, an external VFO, and other accessories.

Our new accessories include a deluxe station console, speakers, 2-meter and 6-meter transverters with direct digital readout and FM capability, and custom microphones.

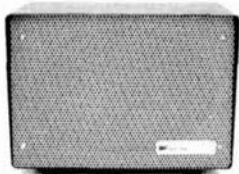

In the past years, there were one or two names in amateur radio gear that meant the finest. In their time they were.

Times have changed. Now, if you want the finest, choosing is easy. It's all at Signal/One.

13130 Yukon, Hawthorne, Ca. 90250 (213) 679-9022

 **signal/one**

ham radio

index to volume V — 1972

This index covers all articles published in *ham radio* during 1972. The articles are listed alphabetically under each category along with the author, page number and month. Categories are: antennas and transmission lines; commercial equipment; construction techniques; fm and repeaters; integrated circuits; keying and control; measurements and test equipment; miscellaneous technical; power supplies; receivers and converters; RTTY; semiconductors; single sideband; transmitters and power amplifiers; vhf and microwave. Articles followed by (HN) appeared in the *ham notebook*.

antennas and transmission lines

All-band phased-vertical W47GXO	p. 32, May
Antenna coupler for three-band beams ZS6BT	p. 42, May
Antenna potpourri W3FQJ	p. 54, May
Antenna tuner, automatic W4PAQC	p. 36, Nov.
Antenna tuners W3FQJ	p. 58, Dec.
Coaxial-line loss, measuring with reflectometer W2VC1	p. 50, May
Collinear antenna for two meters, nine-element	
W6RJO	p. 12, May
Curtain antenna (HN) W4ATE	p. 66, May
DX antenna, single-element W6FHM	p. 52, Dec.
Filters, low-pass, for 10 and 15 W2EEY	p. 42, Jan.
Grounding, safer (letter) W4SKTC	p. 59, May
Groundplane, three-band LA1EI	p. 6, May
Correction	p. 91, Dec.
Headings, beam antenna W6FFC	p. 64, April
Horizontal or vertical (HN) W71V	p. 62, June
Log-periodic, three-band W4AEO	p. 28, Sept.
Mobile antenna, helically wound ZE6JP	p. 40, Dec.
Mobile transmitter, loading W4YB	p. 46, May

Simple antennas for 40 and 80 W5RUB	p. 16, Dec.
Small-loop antennas W4YOT	p. 36, May
Triangle antennas W6KIW	p. 58, May
Uhf coax connectors (HN) W0LCP	p. 70, Sept.
Uhf microstrip swr bridge W4CGC	p. 22, Dec.
Vertical antenna, low-band W41YB	p. 70, July
Vertical dipole, gamma-loop-fed W6SA1	p. 19, May
Yagi, 1296-MHz W2CQH	p. 24, May

audio

Audio filters, aligning (HN) W4ATE	p. 72, Aug.
Audio filters, inexpensive W8YFB	p. 24, Aug.
Audio filter mod (HN) K6HILL	p. 60, Jan.
Hang agc circuit of ssb and CW W1ERJ	p. 50, Sept.
Intercom, simple (HN) W4AYV	p. 66, July
Pre-emphasis for ssb transmitters OH2CD	p. 38, Feb.
Speaker-driver module, IC W42GCF	p. 24, Sept.
Speech clippers, rf G6XN	p. 26, Nov.; p. 12, Dec.
Speech clipping (letter) W3EJD	p. 72, July
Squelch, audio-actuated K4MOG	p. 52, April
Tape head cleaners (letter) K4MSG	p. 62, May

commercial equipment

Alliance rotator improvement (HN) K6JVE	p. 68, May
Collins 75A4 hints (HN) W6VFR	p. 68, April
Collins S-line spinner knob (HN) W6VFR	p. 69, April
Collins S-line transceiver mod (HN) W6VFR	p. 71, Nov.
Drake R-4 receiver, frequency synthesizer for W6NBI	p. 6, Aug.

Hammarlund HQ215, adding 160-meter coverage W2GHHK	p. 32, Jan.
Motorola channel elements WB4NEX	p. 32, Dec.
Motorola Dispatcher, converting to 12 volts WB6HXU	p. 26, July
Swan 350 CW monitor (HN) K1KXA	p. 63, June
Yaesu spurious signals (HN) K6KA	p. 69, Dec.

construction techniques

Capacitors, oil-filled (HN) W2OLU	p. 66, Dec.
Cold galvanizing compound (HN) W5UNF	p. 70, Sept.
Color coding parts (HN) WA7BPO	p. 58, Feb.
Neutralizing tip (HN) ZE6JP	p. 69, Dec.
Noisy fans (HN) W8IUF	p. 70, Nov.
Soldering aluminum (HN) ZE6JP	p. 67, May
Toroids, plug-in (HN) K8EEG	p. 60, Jan.
Toroidal inductors, tuning WAØJYK	p. 24, April
Toroidal inductors, tuning (letter) ZL1BN	p. 77, Dec.
Vectorbord tool (HN) WA1KWJ	p. 70, April
Uhf coax connectors (HN) WØLCP	p. 70, Sept.

fm and repeaters

Carrier-operated relay KØPHF, WAØUZO	p. 58, Nov.
Collinear antenna for two meters, nine-element W6RJO	p. 12, May
Deviation measurements W3FQJ	p. 52, Feb.
Filter, 455-kHz for fm WAØJYK	p. 22, March
Fm demodulator, TTL W3FQJ	p. 66, Nov.
Interference, scanning receiver (HN) K2YAH	p. 70, Sept.
Mobile operation with the Touch-Tone pad WØLPQ	p. 58, Aug.
Correction	p. 90, Dec.
Motorola channel elements WB4NEX	p. 32, Dec.
Preamplifier, two-meter WA2GCF	p. 25, March
Receiver, modular, for two-meter fm WA2GBF	p. 42, Feb.
Added notes	p. 73, July
Receiver performance, comparison of VE7ABK	p. 68, Aug.
Receiver, vhf fm WA2GCF	p. 6, Nov.
Repeater control with simple timers W2FPP	p. 46, Sept.
Correction	p. 91, Dec.

Sequential switching for Touch-Tone repeater control W8GRG	p. 22, June
Tone-burst keyer for fm repeaters W8GRG	p. 36, Jan.
Transmitter, two-meter fm W9SEK	p. 6, April

integrated circuits

Break-in circuit, CW W8SYK	p. 40, Jan.
Digital ICs, part I W3FQJ	p. 41, March
Digital ICs, part II W3FQJ	p. 58, April
Correction	p. 66, Nov.
Digital multivibrators W3FQJ	p. 42, June
Digital oscillators and dividers W3FQJ	p. 62, Aug.
Digital readout station accessory, part I K6KA	p. 6, Feb.
Digital station accessory, part II K6KA	p. 50, March
Digital station accessory, part III K6KA	p. 36, April
Emitter-coupled logic W3FQJ	p. 62, Sept.
Flip-flops W3FQJ	p. 60, July
Flop-flip, using (HN) W3KBM	p. 60, Feb.
Frequency scaler, divide-by-ten W6PBC	p. 41, Sept.
Correction	p. 90, Dec.
Frequency synthesizer for the Drake R-4 W6NBI	p. 6, Aug.
IC power (HN) W3KBM	p. 68, April
Logic monitor (HN) WA5SAF	p. 70, April
Correction	p. 91, Dec.
Sequential switching for Touch-Tone repeater control W8GRG	p. 22, June
Phase-locked loop RTTY terminal unit W4FQM	p. 8, Jan.
Correction	p. 60, May
Speaker driver module WA2GCF	p. 24, Sept.
Ssb detector, IC (HN) K40DS	p. 67, Dec.
Sync generator for sstv WA2EWO	p. 50, June

keying and control

Break-in circuit, CW W8SYK	p. 40, Jan.
Carrier-operated relay KØPHF, WAØUZO	p. 58, Nov.
Code practice stations (letter) WB4LXJ	p. 75, Dec.
CW monitor, Swan 350 (HN) K1KXA	p. 63, June
Key and vox clicks (HN) K6KA	p. 74, Aug.
Memo-key WA7SCB	p. 58, June
Paddle, electronic keyer (HN) KL7EVD	p. 68, Sept.

Threshold-gate/limiter for CW reception
 W2ELV p. 46, Jan.
 Added notes (letter) p. 59, May

measurements and test equipment

AFSK generator, crystal-controlled
 K7BVT p. 13, July

Capacitance meter, direct-reading
 W6MUR p. 48, Aug.

Coaxial-line loss, measuring with a reflectometer
 W2VCI p. 50, May

Crystal checker
 W6GXN p. 46, Feb.

Digital readout station accessory, part I
 K6KA p. 6, Feb.

Digital station accessory, part II
 K6KA p. 50, March

Digital station accessory, part III
 K6KA p. 36, April

Fm deviation measurements
 W3FQJ p. 52, Feb.

Frequency scaler, divide-by-ten
 W6PBC p. 41, Sept.
 Correction p. 90, Dec.

Frequency standard (HN)
 WA7JIK p. 69, Sept.

Logic monitor (HN)
 WA5SAF p. 70, April
 Correction p. 91, Dec.

Monitor scope, RTTY
 W3CIX p. 36, Aug.

Noise-figure measurements for vhf
 WB6NMT p. 36, June

Oscillator, frequency measuring
 W6IEL p. 16, April
 Added notes p. 90, Dec.

Oscillator, two-tone, for ssb testing
 W6GXN p. 11, April

Oscillators, resistance-capacitance
 W6GXN p. 18, July

Oscilloscope voltage calibrator
 W6PBC p. 54, Aug.

Ssb, signals, monitoring
 W6VFR p. 36, March

Swr bridge (HN)
 WA5TFK p. 66, May

Swr meters, direct reading and expanded scale
 WA4WDK p. 28, May
 Correction p. 90, Dec.

Vacuum tubes, testing high-power (HN)
 W2OLU p. 64, March

WWV-WVVH, amateur applications for
 W3FQJ p. 53, Jan.

miscellaneous technical

Alarm, wet basement (HN)
 W2EMF p. 68, April

Bypassing, rf, at uhf
 WB6BHI p. 50, Jan.

Capacitors, oil-filled (HN)
 W2OLU p. 66, Dec.

Crystals, overtone (HN)
 G8ABR p. 72, Aug.

Detector, reciprocating
 W1SNN p. 32, March

Digital integrated circuits, part I
 W3FQJ p. 41, March

Digital integrated circuits, part II
 W3FQJ p. 58, April
 Correction p. 66, Nov.

Digital multivibrators
 W3FQJ p. 42, June

Digital oscillators and dividers
 W3FQJ p. 62, Aug.

Fet biasing
 W3FQJ p. 61, Nov.

Flip-flops, IC
 W3FQJ p. 60, July

Flop-flip, using (HN)
 W3KBM p. 60, Feb.

Infrared communications (letter)
 K20AW p. 65, Jan.

Microwaves, getting started in
 Roubal p. 53, June

Microwaves, introduction
 W1CBBY p. 20, Jan.

Oscillator, crystal, frequency adjustment
 W9ZTK p. 42, Aug.

Oscillator, Franklin (HN)
 W5JJ p. 61, Jan.

Oscillators, resistance-capacitance
 W6GXN p. 18, July

Phase-locked loop RTTY terminal unit
 W5FQM p. 8, Jan.
 Correction p. 60, May

PI network design
 W6FFC p. 6, Sept.

PI-network inductors (letter)
 W7IV p. 78, Dec.

Power dividers and hybrids
 W1DAX p. 30, Aug.

Power in reflected waves (letter)
 Woods p. 76, Dec.

Preamplifier, cooled, for vhf-uhf
 WAØRDX p. 36, July

Pulse-duration modulation
 W3FQJ p. 65, Nov.

Quartz crystals (letter)
 WB2EGZ p. 74, Dec.

Reciprocating-detector receiver
 W1SNN p. 44, Nov.
 Correction (letter) p. 77, Dec.

Satellite communications, first step to
 K1MTA p. 52, Nov.

Satellite signal polarization
 KH6IJ p. 6, Dec.

Speech clippers, rf, performance of
 G6XN p. 26, Nov.

Superregenerative detector, optimizing
 Ring p. 32, July

Sync generator for sstv
 WA2EWO p. 50, June

Toroids, calculating inductance of
 WB9FHC p. 50, Feb.

Toroids, plug-in (HN)
 KBEEG p. 60, Jan.

Vacuum tubes, using odd-ball types in linear amplifiers
 W5JJ p. 58, Sept.

Y parameters, using in rf amplifier design
 WAØTCU p. 46, July

power supplies

Current limiting (HN)
 WØLPQ p. 70, Dec.

Diode surge protection (HN)
 WA7LUJ p. 65, March
 Added note p. 77, Aug.

IC power (HN) W3KBM	p. 68, April
Meter safety (HN) W6VFR	p. 68, July
Motorola Dispatcher, converting to 12 volts WB6HXU	p. 26, July
Transformers, miniature (HN) W4ATE	p. 67, July
Vibrator replacement, solid-state (HN) K8RAY	p. 70, Aug.

receivers and converters

Audio filter mod (HN) K6HIU	p. 60, Jan.
Audio filters, inexpensive W8YFB	p. 24, Aug.
Collins 75A4 hints (HN) W6VFR	p. 68, April
Converter, hf, solid-state VE3GFN	p. 32, Feb.
Cooled preamplifier for vhf-uhf WAØRDX	p. 36, July
Detector, reciprocating W1SNN	p. 32, March
Detector, superregenerative, optimizing Ring	p. 32, July
Direct-conversion receivers, improved selectivity K6BIJ	p. 32, April
Fm receiver performance, comparison of VE7ABK	p. 68, Aug.
Fm receiver, vhf WA2GCF	p. 6, Nov.
Frequency standard (HN) WA7JIK	p. 69, Sept.
Frequency synthesizer for the Drake R-4 W6NBI	p. 6, Aug.
Hammarlund HQ215, adding 160-meter coverage W2GHK	p. 32, Jan.
Hang agc circuit for ssb and CW W1ERJ	p. 50, Sept.
Image suppression (HN) W6NIF	p. 68, Dec.
Interference, electric fence K6KA	p. 68, July
Interference, scanning receiver (HN) K2YAH	p. 70, Sept.
Monitoring oscillator W2JIO	p. 36, Dec.
Preamplifier, emitter-tuned, 21 MHz WA5SNZ	p. 20, April
Receiver, communications, five band K6SDX	p. 6, June
Receiver, modular two-meter fm WA2GFB	p. 42, Feb.
Receiver, reciprocating detector W1SNN	p. 44, Nov.
Correction (letter)	p. 77, Dec.
Rf amplifiers, selective K6BIJ	p. 58, Feb.
RTTY monitor receiver K4EEU	p. 27, Dec.
Squelch, audio-actuated K4MOG	p. 52, April
Ssb signals, monitoring W6VFR	p. 36, March
Swan 350 CW monitor (HN) K1KXA	p. 63, June

Threshold-gate/limiter for CW reception W2ELV	p. 46, Jan.
Added notes (letter) W2ELV	p. 59, May
WWV-WVH, amateur applications for W3fQJ	p. 53, Jan.
144-MHz preamplifier, improved WA2GCF	p. 25, March
Added notes	p. 73, July
2304-MHz converter, solid-state K2JNG, WA2LTM, WA2VTR	p. 16, March
2304-MHz preamplifier, solid-state WA2VTR	p. 20, Aug.

RTTY

AFSK generator, crystal-controlled K7BVT	p. 13, July
Autostart monitor receiver K4EEU	p. 27, Dec.
Monitor scope, phase-shift W3CIX	p. 36, Aug.
Ribbon re-inkers W6FFC	p. 30, June
RTTY distortion: causes and cures WB6IMP	p. 36, Sept.
RTTY for the blind (letter) VE7BRK	p. 76, Aug.
ST-5 autostart and antispac K2YAH	p. 46, Dec.
Terminal unit, phase-locked loop W4FQM	p. 8, Jan.
Correction	p. 60, May

semiconductors

Driver and final for 40 and 80 meters W3QBO	p. 20, Feb.
Fet biasing W3FQJ	p. 61, Nov.
Power transistors, paralleling (HN) WA5EKA	p. 62, Jan.
Trapatt diodes (letter) WA7NLA	p. 72, April
Y parameters in rf design, using WAØTCU	p. 46, July

single sideband

Detector, ssb, IC (HN) K4ODS	p. 67, Dec.
Hang agc circuit for ssb and CW W1ERJ	p. 50, Sept.
Linear, five-band hf W7DI	p. 6, March
Linear amplifier, five-band conduction- cooled W9KIT	p. 6, July
PI-network design, hf power amplifier W6FFC	p. 6, Sept.
PI-network inductors (letter) W7IV	p. 78, Dec.
Pre-emphasis for ssb transmitters OH2CD	p. 38, Feb.
Speech clippers, rf, performance of G6XN	p. 26, Nov.
Speech clipper, rf, construction G6XN	p. 12, Dec.

Two-tone oscillator for ssb testing W6GXN	p. 11, April
Vacuum tubes, using odd-ball types in linear amplifier service W5JJ	p. 58, Sept.
144-MHz transverter, the TR-144 K1RAK	p. 24, Feb.

transmitters and power amplifiers

Driver and final for 40 and 80 meters, solid-state W3QBO	p. 20, Feb.
Filters, low-pass for 10 and 15 meters W2EZY	p. 42, Jan.
Key and vox clicks (HN) K6KA	p. 74, Aug.
Linear, five-band hf W7DI	p. 6, March
Linear amplifier, five-band conduction- cooled W9KIT	p. 6, July
Neutralizing tip (HN) ZE6JP	p. 69, Dec.
Pi-network design, high-frequency power amplifier W6FFC	p. 6, Sept.
Pi-network inductors (letter) W7IV	p. 78, Dec.
Pre-emphasis for ssb transmitters OH2CD	p.38, Feb.
Vacuum tubes, using odd-ball types in linear amplifiers W5JJ	p. 58, Sept.
Vfo, high-stability OH2CD	p. 27, Jan.
Vfo, multiband fet K8EEG	p. 39, July
144-MHz fm transmitter W9SEK	p. 6, April

uhf and microwave

By passing, rf, at vhf WB6BH1	p. 50, Jan.
Cooled preamplifier for vhf-uhf reception WAØRDX	p. 36, July
Microstrip swr bridge, vhf and uhf W4CGC	p. 22, Dec.
Microwaves, getting started in Roubal	p. 53, June
Microwaves, introduction to W1C8Y	p. 20, Jan.
Noise figure measurements, vhf WB6NMT	p. 36, June
Power dividers and hybrids W1DAX	p. 30, Aug.
Satellite communications K1MTA	p. 52, Nov.
Satellite signal polarization KH6IJ	p. 6, Dec.
Vfo, high-stability OH2CD	p. 27, Jan.
144-MHz colinear antenna W6RJO	p. 12, May
144-MHz fm receiver WA2GBF	p. 42, Feb.
Added notes	p. 73, July
144-MHz fm receiver WA2GCF	p. 6, Nov.
144-MHz fm transmitter W9SEK	p. 6, April
144-MHz preamplifier, improved WA2GCF	p. 25, March
144-MHz transverter K1RAK	p. 24, Feb.
1296-MHz Yagi W2CQH	p. 24, May
2304-MHz converter, solid-state K2JNG, WA2LTM, WA2VTR	p. 16, March
2304-MHz preamplifier, solid-state WA2VTR	p. 20, Aug.

Advertisers check-off

... for literature, in a hurry — we'll rush your name to the companies whose names you "check-off"

INDEX

- Amateur-Wholesale
- Amidon
- Antenna Specialists
- Arizona
- BC
- Barry
- Bauman
- CFP
- CNE
- CTG Bitcil
- Caringella
- Circuit Specialists
- Clegg
- Command
- Communications Specialists
- Communications World
- Comtec
- Cook's
- Curtis
- Data
- Drake
- Dycomm
- Eimac
- Emporium
- Erickson
- Fair
- Fluke
- Frank
- Gateway
- Gray
- H & L
- HAL
- Ham Radio
- Heights
- Henry
- Hy-Gain
- International Crystal
- Jan
- Janel
- Jeff-Tronics
- Jensen
- KW
- L. A.
- MFJ
- MPQ
- Martronics
- Matrix
- Meshna
- Micon
- Micro-Z
- Miida
- Military
- Mor-Gain
- NHE
- Noonan
- Palomar
- Penwood
- Poly Paks
- R P
- R & R
- Callbook
- Radio Constructor
- Raytheon
- Robot
- SAROC
- Savoy
- Signal/One
- Slep
- Solid State
- Space-Military
- Spectronics
- Spectronics FM
- Spectrum
- Standard
- Star-Tronics
- Swan
- Ten-Tec
- Topeka
- Top Band
- Tri-Com
- Tropical Hamboree
- VHF Communications
- VHF Engineering
- Van's
- Vanguard
- Weinschenker
- Wolf
- World QSL

Limit 15 inquiries per request.

December 1972

Please use before January 31, 1973

Tear off and mail to
HAM RADIO MAGAZINE — "check off"
 Greenville, N. H. 03048

NAME.....
 CALL.....
 STREET.....
 CITY.....
 STATE..... ZIP.....

Advertisers index

ATV Research	102
Amateur-Wholesale Electronics	106, 108, 110, 117
Amidon Associates	106
Antenna Specialists	81
Arizona Semi-Conductor	108
BC Electronics	117
Barry	82, 83
Bauman, R. H. Sales	116
CFP Enterprises	94
CNE Magazine	100
CTG Bitcil	88
Caringella Electronics	31
Circuit Specialists Co.	89
Clegg Division of ISC	71
Command Productions	110
Communications Specialists	102
Communications World, Inc.	95
Comtec	83, 117
Cook's Communications Corporation	118
Curtis	110, 117
Data Engineering, Inc.	107
Drake Co. R. L.	79
Dycomm	102
Eimac, Div. of Varian Assoc.	117
Emporium Sounds of Pompano	117
Environmental Products	109
Erickson Communications	111
Fair Radio Sales	92
Fluke	94
Frank Electronics	114
G & G Radio Supply Co.	110
Gateway Electronics	103
Goodheart Co., Inc. R. E.	105
Gray Electronics	102
H & L Associates	87
HAL Communications Corp.	101, 117
Ham Radio Magazine	91
Heights Manufacturing Co.	111
Henry Radio Stores	44, 45, 72, 119
Hy-Gain Electronics Corp.	128
International Crystal Mfg. Co. Inc.	86
Jan Crystals	102
Janel Labs	108
Jeff-Tronics	117
Jensen Tools and Alloys	88
KW Electronics	64, 65, 127
L. A. Electronix Sales	116
MFJ Enterprises	108
MPQ	110
Martronics	100, 114
Matrix	94
Meshna, John, Jr.	106
Micon, Inc.	94
Micro-Z Co.	73
Miida Electronics	110
Military Electronics	116
Mor-Gain, Inc.	102
NHE Communications	116
Noonan Associates	92
Palomar Engineers	50, 51
Payne Radio	103
Penwood Numechron Co.	104
Poly Paks	115
RP Electronics	96
R & R Electronics	86, 112
Radio Amateur Callbook	101
Radio Constructor	2
Raytheon Company	5, 16b
Robot Research	113
SAROC	11
Savoy Electronics	120
Signal/One Corporation	106
Slep Electronics Co.	98
Solid State Systems, Inc.	117
Space-Military Electronics	93
Spectronics, Inc.	56, 57
Spectronics FM	92
Spectrum International	97
Standard Communications Corp.	118
Star-Tronics	112a, b
Swan Electronics	85
Ten-Tec, Inc.	88
Topeka FM Engineering	1
Top Band Systems	105
Tri-Com, Inc.	55
Tropical Hamboree	48
VHF Communications	108
VHF Engineering	86
Van's, W2DLT	114
Vanguard Labs	81
Weinschenker, M.	94
Wolf, S.	118
World QSL Bureau	118

HALLETT
ELIMINOISE
 Ignition Noise Suppression Kit

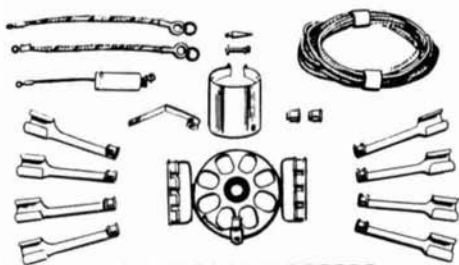

MODEL 80 - UNIVERSAL KIT FITS ALL 8 CYL. AMERICAN CARS

LIMITED

SPECIAL \$24.95

\$55.00 VALUE

Add \$2.50 for shipping & handling

LA *tronix*
 6 and 2 Meter

Sale Priced **15⁹⁵**

Gutter Mount Version \$19.95

MODEL LA 150A

Gain (2 Meters)3db
 Gain (6 Meters)Unity
 Nominal Impedance 55 ohms
 Overall Length55 in.

Add \$2.50 for shipping & handling

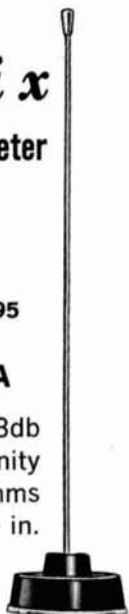

WANTED

CLEAN DRAKE GEAR

REWARD	FOR	NEW	PRICE
\$195.00	2B or 2C	R4B	\$475.00
\$220.00	R4	R4B	\$475.00
\$275.00	R4A	R4B	\$475.00
\$200.00	T4	T4XB	\$495.00
\$125.00	2NT	T4XB	\$495.00
\$285.00	T4X	T4XB	\$495.00
\$ 60.00	AC3	AC4	\$ 99.95
\$ 70.00	DC3	DC4	\$125.00
\$270.00	TR3	TR4	\$599.00

A "broadband" isn't an all girl orchestra.

ITS A BALUN FROM LA-TRONIX



Mod. LA-BN330

IMPROVE YOUR ANTENNA PATTERN AND REDUCE TVI.....FOR ONLY

\$11.77

SPECIFICATIONS

BANDWIDTH.....3 THROUGH 30 MH. CONTINUOUS
 VSWR.....1:1 WHEN TERMINATED WITH A BALANCED 52 OHM LOAD.
 POWER RATING.....1KW DC 2KW PEP
 IMPEDANCE RATIO.....1:1 AT 52 OHMS
 INPUT CONNECTOR.....SO-239
 OUTPUT CONNECTIONS.....STANDARD TERMINAL LUGS
 WEATHER PROTECTION.....INTERNALLY SEALED

Add \$1.00 for shipping & handling

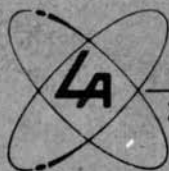

Electronix Sales

23044 S. CRENSHAW BLVD., TORRANCE, CALIF. 90505

Phone: (213) 534-4456 or (213) 534-4402

CLOSED SUNDAY & MONDAY

See LA for your SWAN needs

for the EXPERIMENTER!

INTERNATIONAL EX CRYSTAL & EX KITS
 OSCILLATOR • RF MIXER • RF AMPLIFIER • POWER AMPLIFIER



1. MXX-1 TRANSISTOR RF MIXER

A single tuned circuit intended for signal conversion in the 3 to 170 MHz range. Harmonics of the OX oscillator are used for injection in the 60 to 170 MHz range. Lo Kit 3 to 20 MHz, Hi Kit 20 to 170 MHz (Specify when ordering).....\$3.50



2. SAX-1 TRANSISTOR RF AMP

A small signal amplifier to drive MXX-1 mixer. Single tuned input and link output. Lo Kit 3 to 20 MHz, Hi Kit 20 to 170 MHz (Specify when ordering).....\$3.50



3. PAX-1 TRANSISTOR RF POWER AMP

A single tuned output amplifier designed to follow the OX oscillator. Outputs up to 200 mw, depending on the frequency and voltage. Amplifier can be amplitude modulated. Frequency 3,000 to 30,000 KHz.....\$3.75



4. BAX-1 BROADBAND AMP

General purpose unit which may be used as a tuned or untuned amplifier in RF and audio applications 20 Hz to 150 MHz. Provides 6 to 30 db gain. Ideal for SWL, Experimenter or Amateur\$3.75



5. OX OSCILLATOR

Crystal controlled transistor type. Lo Kit 3,000 to 19,999 KHz, Hi Kit 20,000 to 60,000 KHz. (Specify when ordering).....\$2.95



6. TYPE EX CRYSTAL

Available from 3,000 to 60,000 KHz. Supplied only in HC 6/U holder. Calibration is $\pm .02\%$ when operated in International OX circuit or its equivalent. (Specify frequency)\$3.95

for the COMMERCIAL user...

INTERNATIONAL PRECISION RADIO CRYSTALS

International Crystals are available from 70 KHz to 160 MHz in a wide variety of holders. Crystals for use in military equipment can be supplied to meet specifications MIL-C-3098E.

CRYSTAL TYPES:

- (GP) for "General Purpose" applications
- (CS) for "Commercial Standard"
- (HA) for "High Accuracy" close temperature tolerance requirements.



write for
CATALOG



CRYSTAL MFG. CO., INC.
 10 NO. LEE • OKLA. CITY, OKLA. 73102

ANNOUNCING...

A SUPERB NEW SOLID-STATE SSB TRANSCEIVER



KENWOOD'S TS-900

NOW THE PROMISE OF THE TRANSISTOR HAS BEEN FULFILLED.
HERE IS THE TRANSCEIVER YOU WILL WANT TO OWN AND CAN AFFORD.
FOR YEARS AMATEURS HAVE WAITED FOR THE NEW GENERATION
GENERAL PURPOSE SSB TRANSCEIVER. NOW THE WAIT IS OVER.
WHATEVER TRANSCEIVER YOU OWN GET READY TO TRADE.

FEATURES: Break-in CW with sidetone provided ★ Built-in 100 KHz and 25 KHz crystal oscillator ★ The receiver incremental tuning control can vary the receive frequency ± 2 KHz or more ★ RTTY — Built-in frequency shift circuit for FSK operation. The frequency shift is factory set at 850 Hz ★ Built-in noise blander designed to reduce impulse type (ignition) noise ★ Built-in VOX circuit with adjustable VOX gain and delay ★ All major electronic circuits are built on modular (plug-in) circuit boards

SPECIFICATIONS: Frequency range: 80 meter band — 3.5 to 4.0 MHz; 40 meter band — 7.0 to 7.5 MHz; 20 meter band — 14.0 to 14.5 MHz; 15 meter band — 21.0 to 21.5 MHz; 10 meter band — 28.0 to 28.5 MHz, 28.5 to 29.0 MHz, 29.0 to 29.5 MHz, 29.5 to 30.0 MHz; WWV — 15.0 MHz (receive only) ★ MODE: SSB, CW, or FSK ★ POWER OUTPUT: 150 watts nominal into 50 ohms for SSB, 125 watts nominal into 50 ohms for CW, 50 watts nominal into 50 ohms for FSK ★ RF INPUT IMPEDANCE: 50 ohms ★ FREQUENCY STABILITY: Within 10 Hz during any 15 minute period after warmup ★ CARRIER SUPPRESSION: Carrier better than 45 db down from output signal ★ SIDEBAND SUPPRESSION: Unwanted sideband better than 40 db down from output signal ★ HARMONIC RADIATION: Better than 40 db signal + noise/noise signal ★ RECEIVER SELECTIVITY: SSB and FSK — 2.2 KHz bandwidth (6 db down), 4.4 KHz bandwidth (60 db down). CW — 0.5 KHz bandwidth (6 db down), 1.5 KHz bandwidth (60 db down) (with optional CW filter installed) ★ TUBE & SEMICONDUCTOR COMPLEMENT: 3 tubes (6LQ6 x 2 and 6GK6), 3 IC's, 16 FET's, 57 transistors, 70 diodes ★ SIZE: 12.6"W x 5.5"H x 12.6"D

The TS-900, unquestionably the best transceiver of its kind ever offered.

PRICES: TS-900 ... \$745.00, PS-900 (AC supply) ... \$110.00, DS-900 (DC supply) ... \$130.00, VFO (External VFO) ... \$195.00

Also, Kenwood's TS-511S five band SSB & CW transceiver ... a superb value at \$415.00. If you want separate units, Kenwood's R-599 solid state receiver at \$349.00 and the T-599 transmitter at \$395.00 are the best.

Henry Radio

11240 W. Olympic Blvd., Los Angeles, Calif. 90064 213/477-6701
931 N. Euclid, Anaheim, Calif. 92801 714/772-9200
Butler, Missouri 64730 816/679-3127

15,552 EIMAC tube types power the giant AN/FPS-85 phased array radar. The cost per tube operating hour is less than $\frac{3}{10}$ ¢.

Bendix chose EIMAC tubes for the AN/FPS-85 phased array radar for two reasons: low cost and long life. Five years of successful operation in the world's largest operational, long-range, phased array radar have proven the wisdom of their choice. They've also learned that complex systems using quality vacuum tubes are easy to maintain and rather forgiving as to voltage and power transients. "Cockpit" difficulties, when they occur, are usually not costly or catastrophic to the tubes.

In the UHF output stage of this system, 5,184 EIMAC 4CPX250K tetrodes each deliver 10 kW peak power output and typically 18,000 hours of life at the bargain basement price of \$35 per tube. With this quantity of pulsed operating devices, reliability and low failure rates are *important*.

10,368 EIMAC type 8745 planar triodes are used in the driver stages of the AN/FPS-85, providing upwards of 14,000 hours of average life at a cost of only \$14 per tube.

The long life and low cost of EIMAC tubes have helped Bendix and the USAF prove that large scale phased array radars are economically feasible. No other tube manufacturer has this kind of proven experience. The AN/FPS-85 program is just one more example of EIMAC's dedication to deliver reliable, low-cost tubes.

For complete information, contact EIMAC Division of Varian, 301 Industrial Way, San Carlos, California 94070. Or any of the more than 30 Varian/EIMAC Electron Tube and Device Group Sales Offices throughout the world.

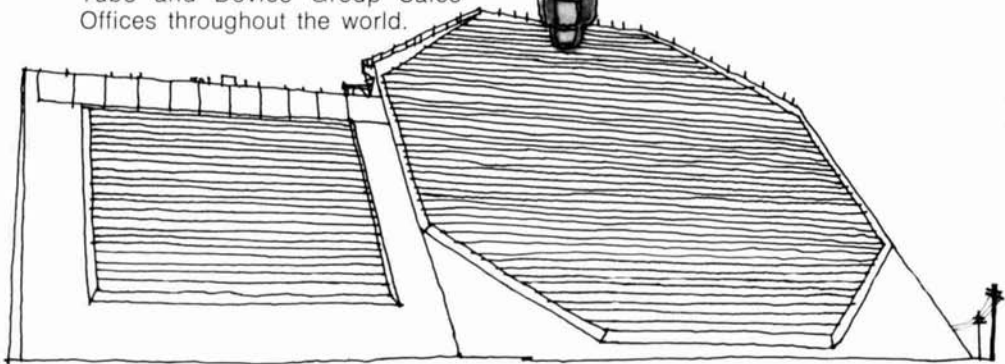



SWAN,

FIRST WITH

FULLY

**SOLID-STATE
TRANSCEIVERS**

UP TO 200 WATTS

... See you at SAROC!

Swan was the first to provide a low cost single sideband transceiver the average ham could afford. Again, Swan leads the field with "state-of-the-art" concepts!

- No Transmitter Tuning
- Infinite VSWR Protection
- Receiver uses FET's, IC's, and Operational Amplifiers
- IF Derived AGC
- Minimized Front-end Overload, Distortion and Cross-modulation
- Selectable Sideband, 80-10 Meters
- Built-in VOX
- Semi-CW Break-in and Monitor
- Noise Blanker, with Threshold Control
- 25 KC Calibrator
- 10 MHz WWV Receive

Mobile is "First Class!" Operates directly from 12 volt DC requiring less than 500 ma on receive. Ideal for net operation. No tune-up necessary, simply dial the station and talk!

Compatible AC power supplies and a host of other accessories available to provide "Top-Of-The-Line" fixed station operation. Operating ease and flexibility makes it a winner for contests or rag-chewing!

CHOICE OF 3 MODELS:

SWAN SS-15 , 15 watt P.E.P.	\$579.00
SWAN SS-100 , 100 watt P.E.P.	\$699.00
SWAN SS-200 , 200 watt P.E.P.	\$779.00

ACCESSORIES INCLUDE:

SWAN PS-10 , 115V AC power supply for SS-15/SS-100	\$ 89.00
SWAN PS-20 , 115V AC power supply for SS-200/SS-100/SS-15	\$139.00
SWAN SS-1200 , 1200 watt P.E.P. Linear Amplifier (tube type)	\$299.00
SWAN SS-208 , External VFO	\$159.00
SWAN 610X , Crystal Controlled Oscillator	\$ 53.95
SWAN SS-16B , Super Selective Filter	\$ 79.95

Detail specifications may be found in the New 1973 SWAN Catalog. Write for your FREE copy, today!

Just 10% down is all that is needed if you use your Swan Credit Service account to put an all solid-state rig in your ham shack.



**SWAN
ELECTRONICS**

A subsidiary of Cubic Corporation

305 Airport Road • Oceanside, CA 92054



Hint list for your XYL or YL

CUT ALONG DOTTED LINE—
AND MAIL TO SWAN OR BRING TO YOUR LOCAL SWAN DEALER

Dear _____

Just thought you might like to know that I still have plenty of shaving lotion and talcum left over from last Christmas. I really prefer to pick out my own shirts, socks and ties, too. What I'd really like to have is the SWAN equipment I've checked below. OK?

- SWAN 500CX** Transceiver
5 Bands—550 Watts **\$529.95**
- SWAN 600R** Receiver **\$439.95**
- SWAN 600T** Transceiver
5 Bands—600 Watts **\$589.95**
- SWAN FP-1** Telephone Patch . . **\$48.95**
- External Crystal Oscillator
SWAN 510X **\$53.95**
- VOX Accessory, **SWAN VX-2** . . **\$35.95**
- Audio Notcher/Peak,er,
SWAN ICAF/500 **\$59.00**
- IF Noise Blanker,
SWAN NB/500 **\$89.00**
- Inline Watt Meter,
SWAN WM-1500 **\$49.95**
- 117V AC Power Supply,
SWAN 117XC **\$109.95**
- 12-14V DC Power Supply,
SWAN 14-117 **\$139.95**
- DC Converter for 117XC,
SWAN 14C **\$69.95**
- 1200 Watt Linear Amplifier,
SWAN 1200X **\$259.95**
- 2000 Watt Linear Amplifier,
SWAN MARK II **\$679.95**
- SWAN 270B** Portable Transceiver
5 Bands—260 Watts **\$469.95**
- SWAN FM-2X** Transceiver
2 Meter FM—10 Watts **\$299.95**
- SWAN FM-1210A** Transceiver
144 Channel 2 Meter FM **\$359.95**
- SWAN VHF-150** Linear Amplifier
2 Meter FM—150 Watts **\$299.95**

- 5 Band Remote Control Mobile
Antenna, **SWAN 55C** **\$129.00**
- 5 Band Manual Switching Mobile
Antenna, **SWAN 45** **\$79.00**
- Trap Dipole Antenna,
SWAN 80/40 **\$29.95**
- 4 Band Trap Vertical Antenna, The famous
GOLDEN SWAN 1040V **\$69.95**
- Mobile Antenna Bumper Mount,
BMT **\$24.00**
- 2 Element 40 MTR. BEAM,
SWAN MB-40H **\$145.00**
- 2 Element **SWAN TB-2A** **\$89.95**
- 3 Element **SWAN TB-3A** **\$108.00**
- 3 Element Heavy Duty
SWAN TB-3HA **\$125.00**
- 4 Element Heavy Duty
SWAN TB-4HA **\$148.00**

This check list can be used as an order blank. Check the items you want, fill in data below and mail to Swan. But do it soon to assure delivery before Christmas. All shipping charges will be collect.

Name _____ Call _____

Street _____

City _____ State _____ Zip _____

Payment by Check Money Order C.O.D.

SWAN Finance (10% down payment enclosed)

(Calif. residents add 5% sales tax)

If Charge, check plan desired:

BankAmericard # _____

Expiration Date _____

Master Charge # _____

Expiration Date _____

4 digit Interbank # _____

SWAN Account # _____

Check here if this is an add-on order



SWAN
ELECTRONICS

A subsidiary of Cubic Corporation

305 Airport Road • Oceanside, CA 92054

Phone (714) 757-7525

revised U.S. amateur FREQUENCY ALLOCATIONS

effective November 22, 1972

from
the editors of

**ham
radio**

and



ROBOT RESEARCH, INC.

Leading the way in
Slow Scan Television

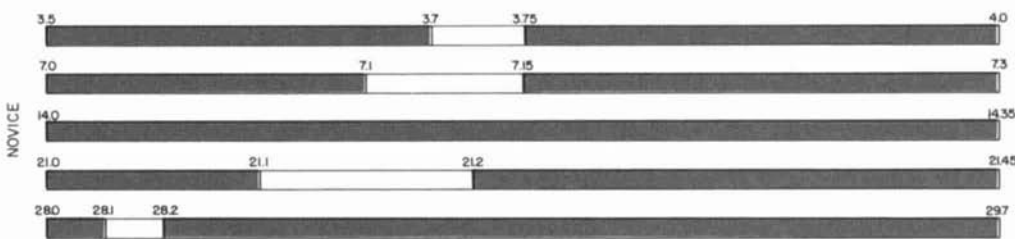
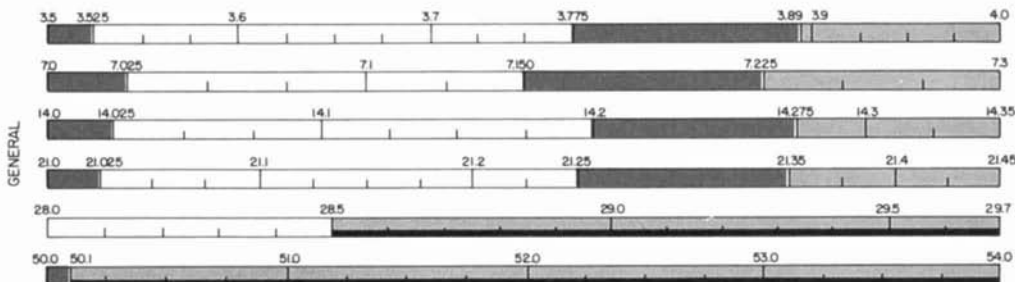
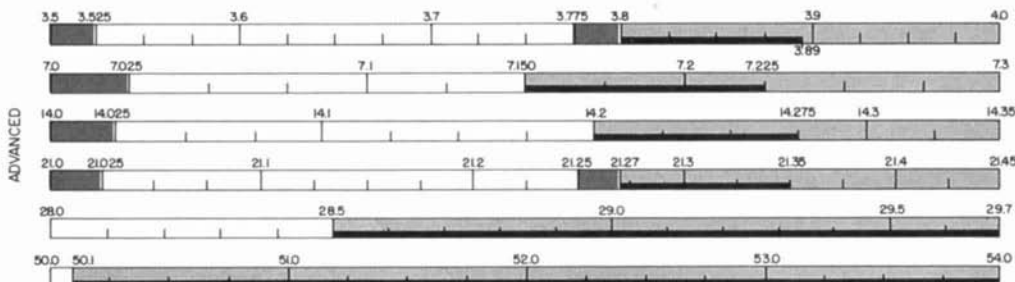
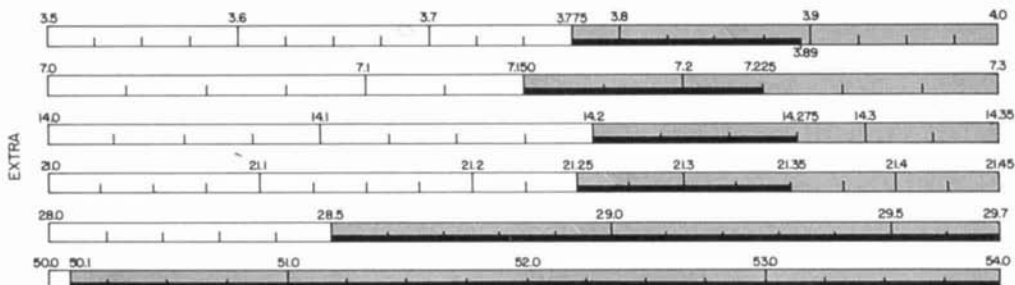
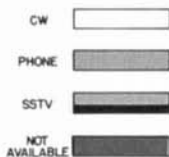

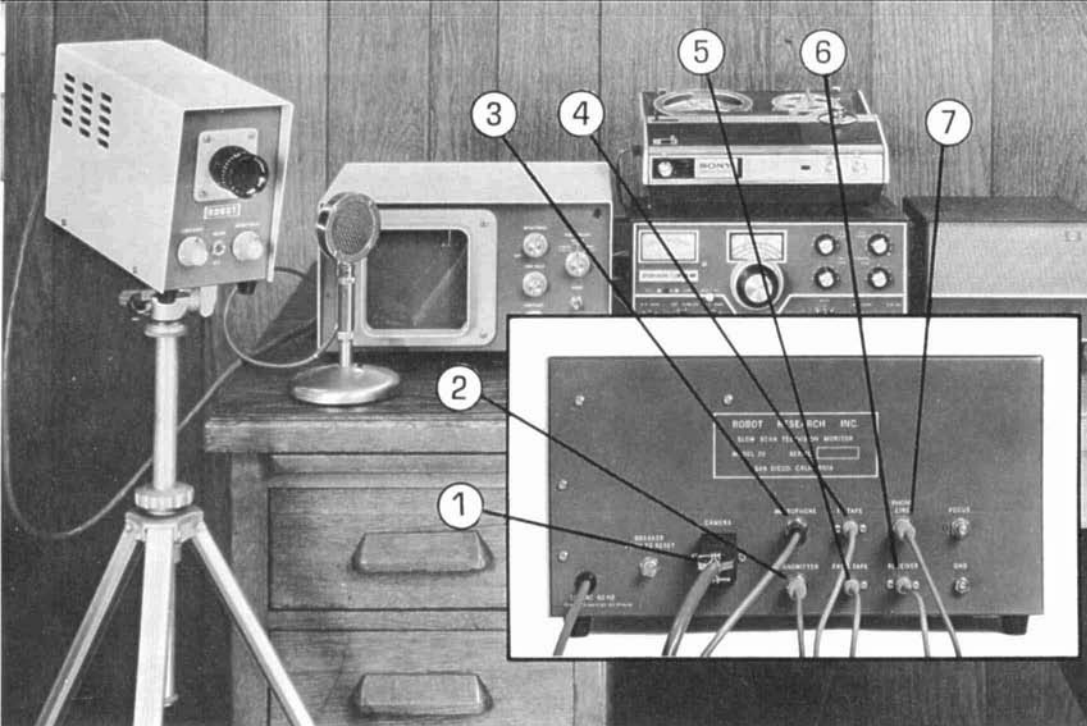

Convert your ham station to a complete SSTV station in 7 easy steps:

Just add a Robot monitor and camera and follow these simple instructions:

All popular ham radio sets may be used with the Robot SSTV equipment and absolutely no modification is required. Pictured above is a complete SSTV station. The inset photo shows the back of the Robot monitor, with all connecting cables. To convert your existing amateur station to an SSTV station:

Connect the cable supplied with the Robot Model 80 camera to the socket ① on the back of the Model 70 monitor. Power is then supplied to the camera from the monitor and the video image from your camera is displayed on the monitor.

Next, connect the transmitter connecting cable ② to the microphone jack on your transmitter or transceiver. Your microphone cable now connects to the microphone jack provided on the back of the Robot Monitor ③.

Phono jack ④ connects the signal from your camera or radio receiver to your tape recorder so that it may be recorded for later viewing or transmitting.

Phono jack ⑤ also connects to your tape recorder so SSTV signals previously recorded on audio tape may be displayed on the Robot monitor for viewing, or transmitted, whenever you wish.

SSTV signals coming from any radio receiver or transceiver are relayed to the Robot monitor for viewing and recording by means of

cable ⑥ which is connected to the receiver by means of a "Y" connector in the speaker lead.

SSTV signals are connected to the phone line ⑦ to provide two-way SSTV exchange with other Robot SSTV sets connected to the phone line.

After these connections are made, the station is operated by switches on the monitor front panel.

That's all there is to it. As you can see, absolutely no modifications of your existing equipment are required. All necessary cables are included with your Robot monitor and camera.

Write us for complete information on Robot SSTV equipment.

ROBOT