

ham radio

magazine

30 Hz

MILCOMM AND AMATEUR RADIO

Same spectrum, similar problems

30 MHz

hr
focus
on
communications
technology

a PSK demodulator for OSCAR-10 • run RTTY on your computer • DC dummy load • carrier-operated relay for VHF amplifiers • controlled vertical radiation rhombics, part 2 • a state-of-the-art electromagnetic jargon generator • plus W6SAI, W1JR, KØRYW, and the Guerri report

ICOM HF Transceiver

IC-751



Reach Out To Your Friends With The IC-751

Here's what other hams have to say about the "dream rig."

"To put it concisely, the IC-751 easily meets all of its advertised claims with regard to technical specifications."

"The filters used on the IC-751 are about the sharpest one can imagine."

"It performed flawlessly over the entire period. Particularly if the IC-751 is used with an internal power supply, it has to be regarded as the most compact, full-featured transceiver available for either fixed station or portable operation."

John J. Schultz W4FA
CQ Magazine
September 1984

"...we seriously doubt anyone finding a unit superior to ICOM's new 751 HF 'dream rig.'"

Dave Ingram K4TWJ
Computer Trader Magazine
September 1984

"The general-coverage receiver is excellent."

Mark Wilson AA2Z
QST Magazine
January 1985

"The Notch measured 55dB, and is the best ICOM Notch yet."

"The stability of the 751 deserves mention. We measured 10Hz drift in the first hour."

Robert Pohorence NBRT
International Radio, Inc.
September 1983

Now with a ONE YEAR Warranty!

 **ICOM**

First in Communications

With SMART PATCH You are in CONTROL

With CES 510SA Simplex Autopatch, there's no waiting for VOX circuits to drop. Simply key your transmitter to take control.

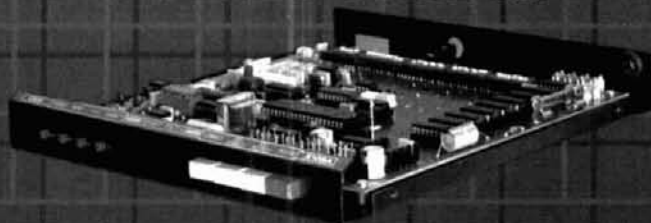

SMART PATCH is all you need to turn your base station into a personal autopatch. SMART PATCH uses the only operating system that gives the mobile complete control. Full break-in capability allows the mobile user to actually interrupt the telephone party. SMART PATCH does not interfere with the normal use of your base station. SMART PATCH works well with any FM transceiver and provides switch selectable tone or rotary dialing, toll restrict, programmable control codes, CW ID and much more.

**To Take CONTROL with Smart Patch
— Call 800-327-9956 Ext. 101 today.**

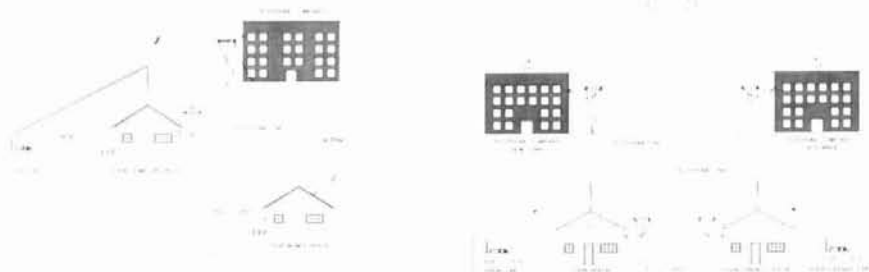

Communications Electronics Specialties, Inc.
P.O. Box 2930, Winter Park, Florida 32790
Telephone: (305) 645-0474 Or call toll-free (800)327-9956

How To Use SMART PATCH

Placing a call is simple. Send your access code from your mobile (example: *73). This brings up the Patch and you will hear dial tone transmitted from your base station. Since SMART PATCH is checking about once per second to see if you want to dial, all you have to do is key your transmitter, then dial the phone number. You will now hear the phone ring and someone answer. Since the enhanced control system of SMART PATCH is constantly checking to see if you wish to talk, you need to simply key your transmitter and then talk. That's right, you simply key your transmitter to interrupt the phone line. The base station automatically stops transmitting after you key your mic. SMART PATCH does not require any special tone equipment to control your base station. It samples very high frequency noise present at your receiver's discriminator to determine if a mobile is present. No words or syllables are ever lost.

SMART PATCH Is All You Need To Automatically Patch Your Base Station To Your Phone Line.

Use SMART PATCH for:

- Mobile (or remote base) to phone line via Simplex base. (see fig. 1.)
- Mobile to Mobile via interconnected base stations for extended range. (see fig. 2.)
- Telephone line to mobile (or remote base).
- SMART PATCH uses SIMPLEX BASE STATION EQUIPMENT. Use your ordinary base station. SMART PATCH does this without interfering with the normal use of your radio.

WARRANTY?

YES, 180 days of warranty protection. You simply can't go wrong. An FCC type accepted coupler is available for SMART PATCH.

What To Look For In A Phone Patch

The best way to decide what patch is right for you is to first decide what a patch should do. A patch should:

- Give complete control to the mobile, allowing full break in operation.
- Not interfere with the normal operation of your base station. It should not require you to connect and disconnect cables (or flip switches!) every time you wish to use your radio as a normal base station.
- Not depend on volume or squelch settings of your radio. It should work the same regardless of what you do with these controls.
- You should be able to hear your base station speaker with the patch installed. Remember, you have a base station because there are mobiles. ONE OF THEM MIGHT NEED HELP.
- The patch should have standard features at no extra cost. These should include programmable toll restrict (dip switches), tone or rotary dialing, programmable patch and activity timers, and front panel indicators of channel and patch status.

**ONLY SMART PATCH
HAS ALL OF THE
ABOVE.**

Now Mobile Operators Can Enjoy An Affordable Personal Phone Patch. . .

- Without an expensive repeater.
- Using any FM transceiver as a base station.
- The secret is a SIMPLEX autopatch, The SMART PATCH.

SMART PATCH Is Easy To Install

To install SMART PATCH, connect the multicolored computer style ribbon cable to mic audio, receiver discriminator, PTT, and power. A modular phone cord is provided for connection to your phone system. Sound simple? . . . IT IS!

KENWOOD

...pacesetter in Amateur radio

Handy Handful...

TR-2600A/3600A

Kenwood's TR-2600A and TR-3600A feature DCS (Digital Code Squelch), a new signalling concept developed by Kenwood. DCS allows each station to have its own "private call" code or to respond to a "group call" or "common call" code. There are 100,000 different DCS combinations possible.



- Simple to operate
Functional design is "user friendly." Built-in 16-key autopatch encoder, TX STOP switch, REVERSE switch, KEYBOARD LOCK switch, high efficiency speaker.
- Large LCD
Easy to read in direct sunlight or in the dark with convenient dial light that also illuminates the top panel S-meter.
- Extended frequency coverage
Allows operation on most MARS and CAP frequencies. (Receive frequency range is 140,000-159,995 MHz; transmit capability is 142,000-148,995 MHz.)
- Programmable scanning
Channel scan or band scan, search for open or busy channels.
- 10 Channels
10 memories, one for non-standard repeater offsets.
- 2.5 watts high power, 350 mW low.

The Kenwood TR-2600A and the TR-3600A pack "big rig" features into the palm of your hand. It's really a "handy handful"!!!

Optional accessories:

- TU-35B built-in programmable sub-tone encoder
- ST-2 base stand
- MS-1 mobile stand
- PB-26 Ni-Cd battery
- DC-26 DC-DC converter
- HMC-1 headset with VOX
- SMC-30 speaker microphone
- LH-3 deluxe leather case
- SC-9 soft case
- BT-3 AA manganese/alkaline battery case
- EB-3 external C manganese/alkaline battery case
- RA-3, 5 telescoping antenna
- CD-10 call sign display

More TR-2600A and TR-3600A information is available from authorized Kenwood dealers.

KENWOOD

TRIO-KENWOOD COMMUNICATIONS
1111 West Walnut Street
Compton, California 90220

TR-2600A shown. TR-3600A is available for 70 cm operation. Complete service manuals are available for all Ino-Kenwood transceivers and most accessories. Specifications and prices are subject to change without notice or obligation.



ham radio

magazine

APRIL 1985

volume 18, number 4

T. H. Tenney, Jr., W1NLB
publisher

Rich Rosen, K2RR
editor-in-chief
and associate publisher

Dorothy Rosa, KA1LBO
assistant editor

Joseph J. Schroeder, W9JUV
Alfred Wilson, W6NIF
associate editors
Susan Shorrock
editorial production

editorial review board

Peter Bertini, K1ZJH
Forrest Gehrke, K2BT
Michael Gruchalla, P.E.
Bob Lewis, W2EBS
Mason Logan, K4MT
Ed Wetherhold, W3NQN

publishing staff

J. Craig Clark, Jr., N1ACH
assistant publisher

Rally Dennis, KA1JWF
director of advertising sales

Dorothy Sargent, KA1ZK
advertising production manager

Susan Shorrock
circulation manager

Therese Bourgault
circulation

cover art:
Chris Nerlinger

ham radio magazine is published monthly by
Communications Technology, Inc.
Greenville, New Hampshire 03048-0498
Telephone: 603-878-1441

subscription rates

United States:
one year, \$19.95; two years, \$32.95; three years, \$44.95
Canada and other countries (via surface mail):
one year, \$22.95; two years, \$41.00; three years, \$58.00
Europe, Japan, Africa (via Air Forwarding Service): one year, \$28.00
All subscription orders payable in U.S. funds, via international
postal money order or check drawn on U.S. bank

international subscription agents: page 142

Microfilm copies are available from
University Microfilms, International
Ann Arbor, Michigan 48106
Order publication number 3076

Cassette tapes of selected articles from *ham radio*
are available to the blind and physically handicapped
from Recorded Periodicals,
919 Walnut Street, Philadelphia, Pennsylvania 19107

Copyright 1985 by Communications Technology, Inc.
Title registered at U.S. Patent Office

Second-class postage paid
at Greenville, New Hampshire 03048-0498
and at additional mailing offices
ISSN 0148-5989

Send change of address to *ham radio*
Greenville, New Hampshire 03048-0498

contents

18 digital HF radio: a sampling of techniques

Dr. Ulrich L. Rohde, KA2WEU/DJ2LR

45 a carrier-operated relay for VHF amplifiers

Frank M. Caimi, WB3JCC and
Edward A. Richey, KD8KZ

50 a PSK telemetry demodulator for OSCAR 10

James Miller, G3RUH

67 ham radio techniques

Bill Orr, W6SAI

75 a state-of-the-art electromagnetic jargon generator

H. Paul Shuch, N6TX

91 the weekender: a DC dummy load

George L. Thurston III, W4MLE

99 controlled vertical radiation rhombics, part 2: antenna erection and performance

Henry G. Elwell, N4UH

110 run RTTY on your Timex

Cliff Nunnery, N4UV

120 run RTTY on your VIC-20

Henry S. Keen, W5TRS

129 VHF/UHF world: stacking antennas, part 1

Joe Reisert, W1JR

157 the Guerri report

Ernie Guerri, W6MGI

160 advertisers index and reader service

12 comments

84 DX forecaster

142 flea market

144 ham mart

78 ham notes

146 new products

9 presstop

4 reflections

126 short circuits



matrix operation

It started innocently enough. First there was a single response from Europe. "Yes, K2RR, you are being heard here and your signal is 5 and 9." Then someone broke in from the States asking if he could just exchange a signal report with the G station. Before you could say "phased 4-element vertical array" five times, the size of the group on frequency had swollen to 10 Europeans, 1 African, 1 New Zealander, and 400 U.S. stations, give or take a few.

What ensued is what I like to call "matrix operation," whereby a number of stations across the Atlantic get an opportunity to talk to at least *scores* of U.S. stations in very short order. (Consider the phenomenon as a 12 by 400-term matrix and look at the large number of possible combinations and permutations — i.e. QSOs.) This is exactly what happened the other morning on 75 meter sideband during a 2-1/2 hour period in which a number of stations from Western Europe worked rare (for them) states like Nevada, Oregon, and Washington. It also provided many stations in the Western states the opportunity — possibly their first — to talk to Europe on 75 meters.

So what does this prove?

It proves that we **ARE** civilized, contrary to the impression some people might come away with after casually scanning the lower HF bands these days.

These days, more often than not, it appears that some normally decent, law-abiding Amateurs are willing to jam and curse each other out over a piece of precious modern "real estate" — our frequency spectrum — each claiming that he was there first. Others decide to make "critical" adjustments to their transmitters at full power while established QSO's are in progress. The overall result is that what was supposed to be a relaxing hour or so of operating turns into the nearest thing to bedlam, creating ill will — not only among ourselves in the States, but because of the long-distance nature of propagation on the low bands nowadays, other countries as well.

May I be so bold as to share with you some simple suggestions on how to improve low-band operation and keep the collective blood pressure down?

LISTEN *before* transmitting. A local conversation might be taking place on frequency — or a DX contact might be occurring even though you can hear only the closer station.

ASK whether the frequency is in use *after* you listen a bit. It's quite possible that even though you can't hear the stations clearly, they can hear you very well.

ADAPT your operating procedure to the conditions at hand. For example, if a rare DX station is working four stations a minute and you manage to get his attention, don't monopolize him *and* the frequency with a long soliloquy.

ADJUST your equipment for best performance (minimum distortion, spurs, chirp, drift, etc.).

USE the *minimum* power necessary to establish and maintain the contact. Save money: leave your amplifier off as much as possible.

BE CREATIVE. If conditions permit, enhance the rubber-stamp type of DX contact with information of genuine interest — but only if conditions permit (see "ADAPT").

DON'T BE CREATIVE. It is both amusing and sad to hear so many one-way conversations on frequency. The old adage, "If you can't hear them, you can't work them," still holds.

CALL the *least* number of times. Don't try to be the last one heard. Listen to how some top operators do it; sometimes they drop their call in only once — but at the appropriate moment.

DON'T BROADCAST, communicate. There are plenty of interesting people out there who have something worthwhile to say.

ENHANCE your knowledge of the band by listening, reading articles on propagation, and noting relationships between the WWV forecasted indices, geomagnetic field status and band conditions.

OBSERVE established "windows." On 75 meters, for example, 3790-3800 is still the international DX window. Your signal at 3800.0001 (LSB), even if perfectly clean, will wipe out the possibility of DX contacts from 3800 down several kilohertz.

LEARN at least a few words in another language. The joy of communicating is yours for the asking.

Though my experience is based on years of operating on 75/80 meters, in general these principles apply to other bands as well. What about your favorite bands and modes? I am very interested in learning about the operating habits, procedures and standard and anomalous propagation modes specific to your band. Drop me a line. Who knows? A cumulative set of notes from these responses could evolve into a pamphlet useful to all.

(Reader's responses to the February editorial "One Million Years of Experience," in which we asked for your suggestions about how the growth of Amateur Radio might be encouraged, continue to pour in. Many thanks to all who've written — a detailed summary of your varied ideas will appear in a forthcoming issue.)

Rich Rosen, K2RR
Editor-in-Chief

NEW FROM MFJ

MFJ'S MOST ADVANCED RTTY/ASCII/AMTOR/CW COMPUTER INTERFACE HAS FM, AM MODES, LED TUNING ARRAY, RS-232 INTERFACE, VARIABLE SHIFT TUNING, 170/850 Hz TRANSMIT, MARK-SPACE DETECTION.

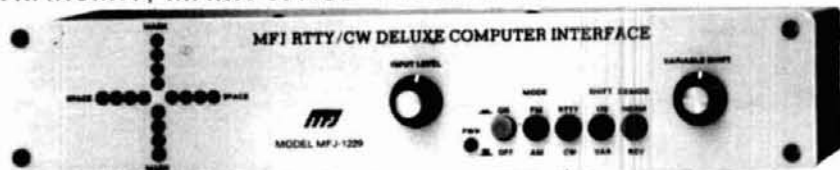

MFJ RTTY/ASCII/CW software on tape, cables for C-64/VIC-20.

MFJ-1229
\$ **179.95**

Engineering, performance, value and features sets MFJ's most advanced RTTY/ASCII/

AMTOR/CW computer interface apart from others. **FM (limiting) mode** gives easy, trouble-free operation. Best for general use, off-shift copy, drifting signals, and moderate signal and QRM levels.

AM (non-limiting) mode gives superior performance under weak signal conditions or when there are strong nearby stations.

Crosshair mark-space LED tuning array simulates scope ellipse for easy, accurate tuning even under poor signal-to-noise conditions. Mark and space outputs for true scope tuning.

Transmits on both 170 Hz and 850 Hz shift.

Built-in RS-232 interface, no extra cost.

Variable shift tuning lets you copy any shift between 100 and 1000 Hz and any speed (5-100 WPM RTTY/CW and up to 300 baud ASCII). Push button for 170 Hz shift.

Sharp multi-pole mark and space filters give true mark-space detection. Ganged pots give space passband tuning with constant bandwidth. Factory adjusted trim pots for optimum filter performance.

Multi-pole active filters are used for pre-limiter, mark, space and post detection filtering. Has automatic threshold correction. This advanced design gives good copy under QRM, weak signals and selective fading.

Has front panel sensitivity control.

Normal/Reverse switch eliminates retuning while checking for inverted RTTY. Speaker jack. +250 VDC loop output.

Exar 2206 sine wave generator gives phase continuous AFSK tones. Standard 2125 Hz mark and 2295/2975 Hz space. Microphone lines: AFSK out, AFSK ground, PTT out and PTT ground.

FSK keying for transceivers with FSK input. Has sharp 800 Hz CW filter, plus and minus CW keying and external CW key jack.

Kantronics software compatible socket.

Exclusive TTL/RS-232 general purpose socket allows interfacing to nearly any personal computer with most appropriate software. Available TTL/RS-232 lines: RTTY demod out, CW demod out (TTL only), CW-ID in, RTTY in, PTT in, key in. All signal lines are buffered and can be inverted using an internal DIP switch.

Metal cabinet. Brushed aluminum front. 12 1/2 x 2 1/2 x 6 inches. 18 VDC or 110 VAC with optional AC adapter, MFJ-1312, \$9.95.

Plugs between rig and C-64, VIC-20, Apple, TRS-80C, Atari, TI-99 and other personal computers. Use MFJ, Kantronics, AEA and other RTTY/ASCII/AMTOR/CW software.

MFJ MULTI-FUNCTION TUNING INDICATOR MFJ-1221 \$79.95



Greatly improve your RTTY copying capabilities. Add a crosshair LED Tuning Indicator that makes tuning quick, easy with pin-point accuracy. Add mark and space outputs for scope tuning. Add LEDs that indicate 170, 425, 850 Hz shifts. Great for copying RTTY outside ham bands. Add sharp mark and space filters to improve copy under crowded/weak conditions. 170, 425, 850 Hz shifts.

Add Normal/Reverse switch to check for inverted RTTY without retuning. Add output level control to adjust signal into your terminal unit. Add a limiter to even out signal variation for smoother copy.

Unit plugs between your tuner and receiver. Mark is 2125 Hz, space is 2295, 2550 or 2975 Hz. Measures 10x2x6 in. and uses floating 18 VDC or 110 VAC with AC adapter, MFJ-1312, \$9.95.

24/12 HOUR CLOCK/ID TIMER MFJ-106 \$19.95

Switch to 24 hour UTC or 12 hour format! Battery backup. ID timer alerts every 9 minutes after reset. Red .6 in. LEDs. Synchronizable to WWW. Alarm, Snooze function. PM, alarm on indicators. Gray/Black cabinet. 110 VAC, 60 Hz.



MFJ ELECTRONIC KEYS MFJ-407 \$69.95



MFJ-407 Deluxe Electronic Keyer sends iambic, automatic, semi-auto or manual. Use squeeze, single lever or straight key. Plus/minus keying. 8 to 50 WPM. Speed, weight, tone, volume controls. On/Off, Tune, Semi-auto switches. Speaker. RF proof. 7x2x6 inches. Uses 9 V battery, 6-9 VDC or 110 VAC with AC adapter, MFJ-1305, \$9.95.

MICROPHONE EQUALIZER MFJ-550 \$49.95



Greatly improves transmitted SSB speech for maximum talk power. Evens out speech peaks and valleys due to voice, microphone and room characteristics that make speech hard to understand. Produces cleaner, more intelligible speech on receiving end. Improves mobile operation by reducing bassy peaks due to acoustic resonances. Plugs between mic and rig. 4 pin mic jack, shielded output cable. High, mid, low controls provide ±12 db boost or cut at 490, 1170, 2800 Hz. Mic gain, on/off/bypass switch. "On" LED. 7x2x6 inches. 9 V battery, 12 VDC or 110 VAC with adapter, MFJ-1312, \$9.95.

MFJ ANTENNA BRIDGE MFJ-204 \$79.95

Trim your antenna for optimum performance quickly and easily. Read antenna resistance up to 500 ohms. Covers all ham bands below 30 MHz. Measure resonant frequency of antenna. Easy to use, connect antenna, set frequency, adjust bridge for meter null and read antenna resistance. Has frequency counter jack. Use as signal generator. Portable, self-contained. 4x2x2 in. 9 V battery or 110 VAC with adapter, MFJ-1312, \$9.95.



MFJ PORTABLE ANTENNA MFJ-1621 \$79.95

MFJ's Portable Antenna lets you operate 40, 30, 20, 15, 10 meters from apartments, motels, camp sites, vacation spots, nearly any electrically clear location where space for a full size antenna is a problem.

A telescoping whip (extends to 54 in.) is mounted on self-standing 5 1/2 x 6 1/2 x 2 1/4 inch Phenolic case. Built-in antenna tuner, field strength meter, 50 feet RG-58 coax. Complete multi-band portable antenna system that you can use nearly anywhere. Up to 300 watts PEP.

MFJ-1621
\$79.95



MFJ 24 HOUR LCD CLOCKS

\$19.95



MFJ-108

\$9.95



MFJ-107

Huge 5/8 inch bold black LCD numerals make these two 24 Hour clocks a must for your shack. Choose from a dual clock that features separate UTC and local time display or a single clock that displays 24 Hour time. Mounted in a brushed aluminum frame, these clocks feature huge 5/8 inch LCD numerals and a sloped face for across the room viewing. Easy set month, day, hour, minute and second function. Clocks can be operated in an alternating time-date display mode. MFJ-108, 4 1/2 x 1 x 2 inches; MFJ-107, 2 1/4 x 1 x 2 inches. Battery included.

ORDER ANY PRODUCT FROM MFJ AND TRY IT-NO OBLIGATION. IF NOT DELIGHTED, RETURN WITHIN 30 DAYS FOR PROMPT REFUND (LESS SHIPPING)

- One year unconditional guarantee • Made in USA.
- Add \$4.00 each shipping/handling • Call or write for free catalog, over 100 products.

MFJ

MFJ ENTERPRISES, INC.
Box 494, Mississippi State, MS 39762

TO ORDER OR FOR YOUR NEAREST DEALER, CALL TOLL-FREE

800-647-1800. Call 601-323-5869 in Miss. and outside continental USA
Telex 53-4590 MFJ STKV



**HAM
RADIO
OUTLET**

**YOUR
BEST
SOURCE
FOR**



ICOM

- 6 STORE BUYING POWER ASSURES TOP VALUES.
- BIG, COMPLETE STOCKS. GET WHAT YOU WANT WHEN YOU WANT IT.
- MORE SAVINGS BY FREE DELIVERY.

**HAND-HELDS
AND
ACCESSORIES**

IC-3AT* 220MHz

IC-2AT* 2-meter

Battery Charger Charges all ICOM Handhelds

IC-4AT* 440MHz

Leather Case Available for all handhelds

IC-HM9 Speaker Mic

IC-02AT 2-meter

IC-04AT 440MHz

IC-BC16U Wall Charger for BP7 and BP8 only

IC-ML1 12VDC 144MHz Booster 10W out/12 VDC (comes w/5 ft coax. BNC to extb PL-259)

IC-DC1 DC Regulator 12 VDC in/ 9.6 VDC out (comes with DC cord — will not get power from BC30)

IC-BP2 Battery Pack

IC-BP3 Battery Pack

IC-BP4 Battery Pack

IC-BP5 Battery Pack

IC-BP6 Battery Pack

IC-BP7** Battery Pack

IC-BP8 Battery Pack

IC-CP1 Cigarette Lighter Cord w/Fuse (charges BP3/powers DC1)

IC-BC25U AC Wall Charger 117 VAC in (for charging BP3 only)

H5-10 Header
H5-10SB PTT
Switchbox
H5-10SA VOX
Unit. (Not shown, works only with 02AT and 04AT)

**PRICED FOR
VALUE! CALL.**

Many accessory items qualify for free UPS Surface delivery.

* Also available without Touchtone* pad

SALE!

IC-751



Today's most advanced transceiver! The receiver section is truly competition-grade providing general coverage, continuous tuning over the 100kHz to 30MHz range. The transmitter is full-featured, is all mode, solid-state. IC-751 also covers MARS and the new WARC frequencies, is AMTOR compatible.

SALE!

IC-R71 A



A superior-grade, general coverage 100kHz to 30MHz receiver with such innovative features as keyboard frequency entry and wireless remote control (opt.). Ideal for world-wide communications listening, has 32 programmable memory channels, dual VFO's and provides SSB/AM/RTTY/CW/FM (opt.) reception.

CALL NOW FOR YOUR SALE PRICES

SIMPLEX-REPEATER-SATELLITE



IC-271H

2 METERS • 100 WATTS
• ALL-MODE



IC-471H

430-450MHz • 75 WATTS
• ALL-MODE

CALL FOR YOUR SPECIAL PRICE



IC-27A*
SUPER-COMPACT
2 METER MOBILE

An important breakthrough in compact mobile equipment! Only 1 1/2" x 5 1/2" but full-featured including internal speaker 25W of power, ten full-function tunable memories, memory and band scan, priority scan. Includes mic. with 16 button Touchtone

ALSO *IC-27H HIGH POWER VERSION AND IC-37A, 220MHz

IC-47A, 70CM LOW PRICES, CALL!

FREE SHIPMENT, ALL OF THE ABOVE ITEMS, UPS (Surface).

Store addresses/Phone numbers are given on opposite page.

You touch.

It holds.

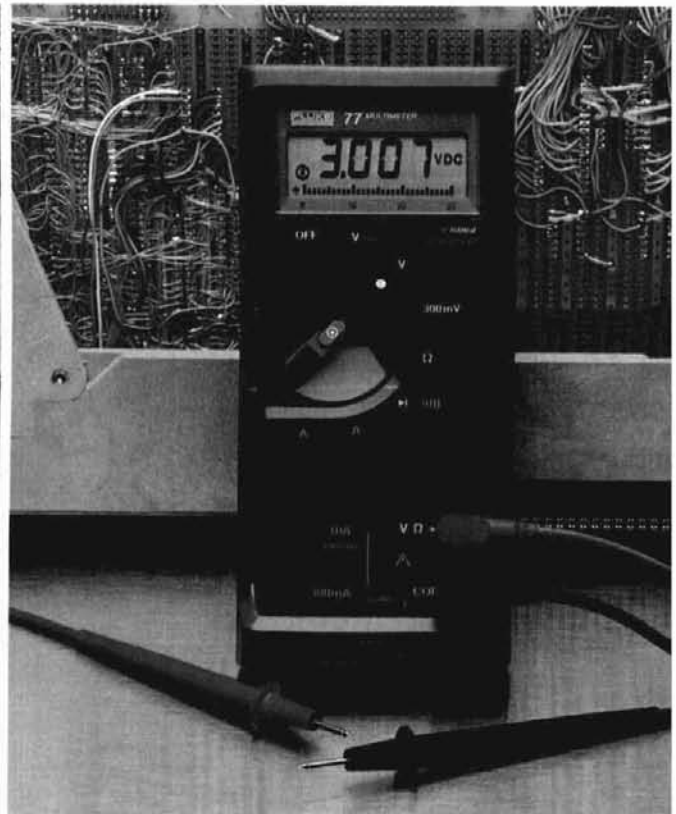
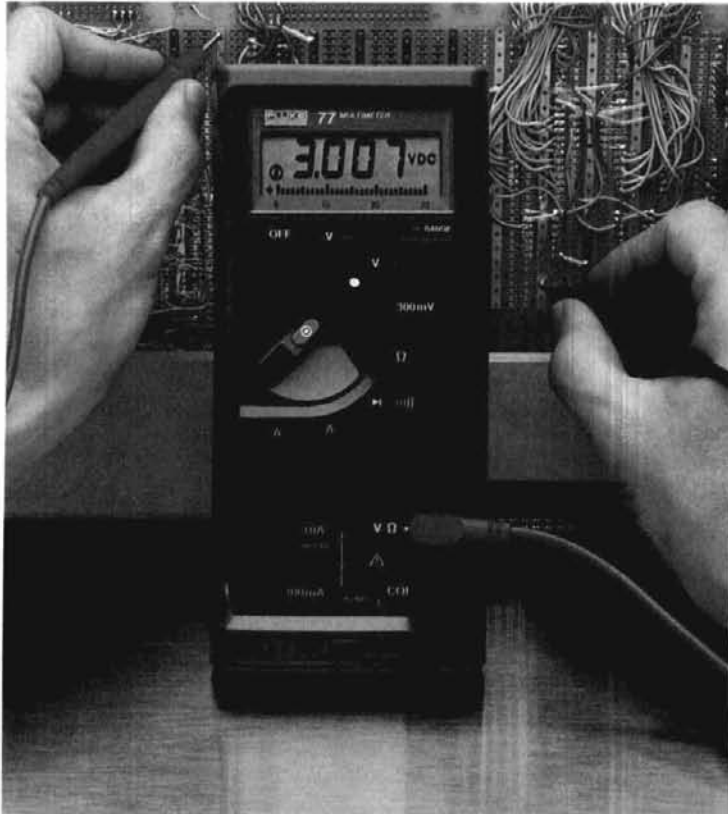

\$129* gets you the world's first handheld digital/analog multimeter with "Touch Hold."

The Fluke 77

Its unique "Touch Hold" function automatically senses and holds readings, leaving you free to concentrate on positioning test leads without having to watch the display.

Then, when you have a valid reading, it signals you with an audible beep.

The Fluke 77 is perfect for those test situations where accessibility is a problem, or when extra care is needed for critical measurements.

It's the top model in the world champion Fluke 70 Series line — the first industrial quality autoranging multimeters to combine digital and analog displays. These tough, American-made meters feature a three-year warranty and 2000+ hour battery life.

So call now for the complete story on the Fluke 77 with "Touch Hold." Because if you don't deserve the world's first, who in the world does?

For the name of your distributor or a free brochure, call our toll-free hotline anytime **1-800-227-3800, Ext. 229.**

From outside the U.S., call 1-402-496-1350, Ext. 229.

FROM THE WORLD LEADER
IN DIGITAL MULTIMETERS.



FLUKE 73

\$85*
Analog/digital display
Volts, ohms, 10A, diode test
Autorange
0.7% basic dc accuracy
2000+ hour battery life
3-year warranty



FLUKE 75

\$99*
Analog/digital display
Volts, ohms, 10A, mA, diode test
Audible continuity
Autorange/range hold
0.5% basic dc accuracy
2000+ hour battery life
3-year warranty



FLUKE 77

\$129*
Analog/digital display
Volts, ohms, 10A, mA, diode test
Audible continuity
"Touch Hold" function
Autorange/range hold
0.3% basic dc accuracy
2000+ hour battery life
3-year warranty
Multipurpose holster

* Suggested U.S. list price, effective July 1, 1984.
** Patent pending.



AMATEUR RADIO DOES HAVE A FUTURE, BUT A STRONG EFFORT MUST BE MADE to assure that future...that was the consensus of the all-day industry meeting held in Miami January 30, just prior to the Tropical Hamboree. About 40 people, representing many major manufacturers, several distributors, the principal Amateur publishers, and the ARRL attended the session, chaired by former HR Report editor Joe Schroeder, W9JUV.

Amateur Radio Does Have Some Grave Problems, those attending agreed: the static U.S. Amateur population, an uncomfortably high rate of unexpired licenses, the on-going problems of both manufacturers and dealers, and awareness that our influence in Washington seems to be waning, were just some of the symptoms that were cited. However, during the "off-the-record, no attributions" discussion, a number of really worthwhile suggestions were made.

An Aggressive Program To Attract Junior High School Youngsters was one of the key ideas — junior high science teachers can provide access to this group. Free passes to hamfests for youngsters, their teachers and/or parents was one suggestion, to be complemented by an industry-sponsored and staffed "This Is Ham Radio" booth to provide both an introduction and even "hands-on" experience for newcomers. Supplementing this effort will be an Amateur Radio "comic book" highlighting its "fun" aspects in an entertaining way. Also planned are "sales pitches" to the general public, directing a special effort toward responsible CB groups such as REACT and scanner organizations. The possibility of making the entry level more attractive, by adding limited Novice data and/or voice privileges, was also discussed. Greater dealer involvement, such as hosting training courses and club meetings, was also considered. A proposal that industry representatives sit on the ARRL board, to encourage closer ARRL-industry coordination, was broached to ARRL representatives.

Overall Attitude After The Grueling Session Was Upbeat, with those attending feeling that some very real progress had been made in overcoming Amateur Radio's current inertia. Volunteers from the group are already actively working on a number of the suggested programs, and progress reports on their efforts plus a discussion of future plans is scheduled for a Dayton meeting the Thursday evening before the Hamvention.

FCC'S REPEATER FREQUENCY COORDINATION PROPOSAL will place prime responsibility for resolving repeater conflicts squarely on operators of uncoordinated repeaters. In the case of a dispute with two coordinated machines, both operators would share responsibility for its resolution equally. In its Notice of Proposed Rule Making, the FCC cited the rapidly increasing number of repeater interference complaints it's received, and that the bulk of these problems seem to involve uncoordinated repeaters.

The FCC Asks Amateurs To Consider A Number Of Key Questions in this potentially far-reaching NPRM. For example, should coordination be mandated in major urban areas? As an alternative, should narrow-band technologies and tone squelch be required to minimize the interference problem? Should the Commission recognize a "single national frequency coordinator," either on a national basis or as an "advisor" to local coordinators?

A Blanket Moratorium On New Repeaters Initially Distracted Attention from the real issues until lifted by the FCC February 19. There had been some comment that the moratorium had simply confused the issue and was probably unenforceable anyway, and the ARRL (supported by the Tri-State Repeater Council) had petitioned the FCC to rescind the ban.

Comments On The Repeater Coordination Docket, PR Docket 85-22, are due at the FCC July 1; Reply Comments will be due September 30.

TEXAS HAS JOINED THE SHIFT TO 20 KHZ 2-METER SPACING, adopting the change by an 8:1 margin at the February 16 meeting of the Texas VHF FM Society. The decision, which makes Texas the second state east of the Rockies to make the move, has been under consideration for some time. As yet, no timetable for the move has been established.

Northern California And Minnesota Are Also Looking At The 20 kHz Plan. In California the Northern Amateur Relay Council has invited Clay Freinwald, K7CR, to its April 13 meeting at Concord to discuss the 20 kHz plan. K7CR is considered one of the fathers of the plan in the Pacific Northwest. Minnesota has 20 kHz on its April meeting agenda, too.

The Escalating Move To 20 kHz Is Causing Concern In Europe where 2-meter FM operation on their 144-146 MHz band has traditionally been on 25 kHz centers. Some Europeans are worried that the Japanese, whose domestic 2-meter band is also on 20 kHz spacing, would drop 5-kHz step capability from their rigs if the U.S. market no longer needs it.

TWO ESTABLISHED REGIONAL VECS ARE GOING NATIONAL. Both the DeVry Amateur Radio Society and Metroplex have applied for national status, based on their experience and success in operating regional programs in the Ninth and Second call areas, respectively. The DeVry proposal is particularly interesting, as DeVry has campuses in seven other call areas that could serve as nuclei for its efforts in those areas. As the FCC's experience with both organizations has been excellent, their proposals should be accepted quickly.

WARC BAND EXPANSION IS STILL HANGING FIRE, with some GMRS representatives looking into the possibility of carving a slice for personal radio from the new 902-928 MHz band.

The Commission's Recent Turndown Of A Personal Radio Service at 900 MHz has also been challenged by the same group, who've filed a Petition for Reconsideration with the FCC.

THE MOST AFFORDABLE REPEATER

ALSO HAS THE MOST IMPRESSIVE PERFORMANCE FEATURES

(AND GIVES THEM TO YOU AS STANDARD EQUIPMENT!)



JUST LOOK AT THESE PRICES!

Band	Kit	Wired/Tested
10M,6M,2M,220	\$680	\$880
440	\$780	\$980

Both kit and wired units are complete with all parts, modules, hardware, and crystals.

CALL OR WRITE FOR COMPLETE DETAILS.

Also available for remote site linking, crossband, and remote base.

FEATURES:

- SENSITIVITY SECOND TO NONE; TYPICALLY 0.15 uV ON VHF, 0.3 uV ON UHF.
- SELECTIVITY THAT CAN'T BE BEAT! BOTH 8 POLE CRYSTAL FILTER & CERAMIC FILTER FOR GREATER THAN 100 dB AT ± 12 KHZ. HELICAL RESONATOR FRONT ENDS. SEE R144, R220, AND R451 SPECS IN RECEIVER AD BELOW.
- OTHER GREAT RECEIVER FEATURES: FLUTTER-PROOF SQUELCH, AFC TO COMPENSATE FOR OFF-FREQ TRANSMITTERS, SEPARATE LOCAL SPEAKER AMPLIFIER & CONTROL.
- CLEAN, EASY TUNE TRANSMITTER; UP TO 20 WATTS OUT (UP TO 50W WITH OPTIONAL PA).

HIGH QUALITY MODULES FOR REPEATERS, LINKS, TELEMETRY, ETC.

HIGH-PERFORMANCE RECEIVER MODULES

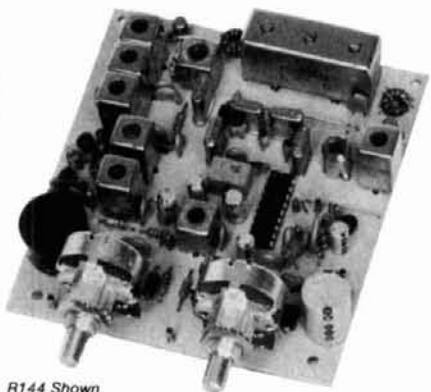

R144 Shown

- **R144/R220 FM RCVRs** for 2M or 220 MHz. 0.15uV sens.; 8 pole xtal filter & ceramic filter in-I, helical resonator front end for exceptional selectivity, more than -100 dB at ± 12 kHz, best available today. Flutter-proof squelch. AFC tracks drifting xmtrs. Xtal oven avail. Kit only \$138.
- **R451 FM RCVR** Same but for uhf. Tuned line front end, 0.3 uV sens. Kit only \$138.
- **R76 FM RCVR** for 10M, 6M, 2M, 220, or commercial bands. As above, but w/o AFC or hel. res. Kits only \$118. Also avail w/4 pole filter, only \$98/kit.
- **R110 VHF AM RECEIVER** kit for VHF aircraft band or ham bands. Only \$98.
- **R110-259 SPACE SHUTTLE RECEIVER**, kit only \$98.

TRANSMITTERS

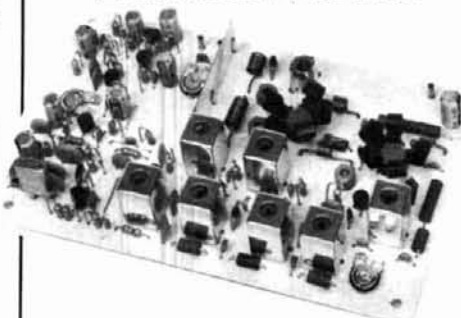

- **T51 VHF FM EXCITER** for 10M, 6M, 2M, 220 MHz or adjacent bands. 2 Watts continuous, up to 2 1/2 W intermittent. \$68/kit.



- **T451 UHF FM EXCITER** 2 to 3 Watts on 450 ham band or adjacent freq. Kit only \$78.
- **VHF & UHF LINEAR AMPLIFIERS.** Use on either FM or SSB. Power levels from 10 to 45 Watts to go with exciters & xmtg converters. Several models. Kits from \$78.
- **A16 RF TIGHT BOX** Deep drawn alum. case with tight cover and no seams. 7 x 8 x 2 inches. Designed especially for repeaters. \$20.

ACCESSORIES

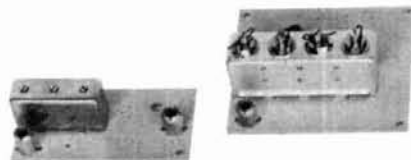

- **HELICAL RESONATOR FILTERS** available separately on pcb w/connectors.
 - HRF-144 for 143-150 MHz \$38
 - HRF-220 for 213-233 MHz \$38
 - HRF-432 for 420-450 MHz \$48
- **COR-2 KIT** With audio mixer, local speaker amplifier, tail & time-out timers. Only \$38.
- **COR-3 KIT** as above, but with "courtesy beep". Only \$58.
- **CWID KITS** 158 bits, field programmable, clean audio, rugged TTL logic. Kit only \$68.
- **DTMF DECODER/CONTROLLER KITS.** Control 2 separate on/off functions with touchtones[®], e.g., repeater and autopatch. Use with main or aux. receiver or with Autopatch. Only \$90
- **AUTOPATCH KITS.** Provide repeater autopatch, reverse patch, phone line remote control of repeater, secondary control via repeater receiver. Many other features. Only \$90. Requires DTMF Module.
- **NEW - SIMPLEX AUTOPATCH** Use with any transceiver. System includes DTMF & Autopatch modules above and new Timing module to provide simplex autopatch and reverse autopatch. Complete patch system only \$200/kit. Call or write for details.

hamtronics[®]



Hamtronics Breaks the Price Barrier!



No Need to Pay \$80 to \$125 for a GaAs FET Preamp.

FEATURES:

- Very Low Noise: 0.7 dB VHF, 0.8 dB UHF
- High Gain: 18 to 28 dB, Depending on Freq.
- Wide Dynamic Range for Overload Resistance
- Latest Dual-gate GaAs FET, Stable Over Wide Range of Conditions
- Rugged, Diode-protected Transistors
- Easy to Tune
- Operates on Standard 12 to 14 Vdc Supply
- Can be Tower Mounted

MODEL	TUNES RANGE	PRICE
LNG-28	26-30 MHz	\$49
LNG-50	46-56 MHz	\$49
LNG-144	137-150 MHz	\$49
LNG-220	210-230 MHz	\$49
LNG-432	400-470 MHz	\$49
LNG-40	30-46 MHz	\$64
LNG-160	150-172 MHz	\$64



Models to cover every practical rf & if range to listen to SSB, FM, ATV, etc. NF = 2 dB or less.

	Antenna Input Range	Receiver Output
VHF MODELS	28-32	144-148
	50-52	28-30
Kit with Case \$49	50-54	144-148
Less Case \$39	144-146	28-30
Wired \$69	145-147	28-30
	144-144.4	27-27.4
	146-148	28-30
	144-148	50-54
	220-222	28-30
	220-224	144-148
	222-226	144-148
	220-224	50-54
	222-224	28-30
UHF MODELS	432-434	28-30
	435-437	28-30
Kit with Case \$59	432-436	144-148
Less Case \$49	432-436	50-54
Wired \$75	439.25	61.25

SCANNER CONVERTERS Copy 72-76, 135-144, 240-270, 400-420, or 806-894 MHz bands on any scanner. Wired/tested Only \$88.

For SSB, CW, ATV, FM, etc. Why pay big bucks for a multi mode rig for each band? Can be linked with receive converters for transceiver. 2 Watts output vhf, 1 Watt uhf.

	Exciter Input Range	Antenna Output
For VHF, Model XV2 Kit \$79 Wired \$149 (Specify band)	28-30	144-146
	28-29	145-146
	28-30	50-52
	27-27.4	144-144.4
	28-30	220-222*
	50-54	220-224
	144-146	50-52
	50-54	144-148
	144-146	28-30

For UHF, Model XV4 Kit \$99 Wired \$169	28-30	432-434
	28-30	435-437
	50-54	432-436
	61.25	439.25
	144-148	432-436*

*Add \$20 for 2M input



VHF & UHF LINEAR AMPLIFIERS. Use with above. Power levels from 10 to 45 Watts. Several models, kits from \$78.

ECONOMY PREAMPS

Our traditional preamps, proven in years of service. Over 20,000 in use throughout the world. Tuneable over narrow range. Specify exact freq. band needed. Gain 16-20 dB. NF = 2 dB or less. VHF units available 27 to 300 MHz. UHF units available 300 to 650 MHz.

- P30K, VHF Kit less case \$18
- P30W, VHF Wired/Tested \$33
- P432K, UHF Kit less case \$21
- P432W, UHF Wired/Tested \$36

HELICAL RESONATOR PREAMPS

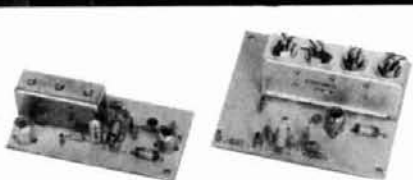

Our lab has developed a new line of low-noise receiver preamps with helical resonator filters built in. The combination of a low noise amplifier and the sharp selectivity of a 3 or 4 section helical resonator provides increased sensitivity while reducing intermod and cross-band interference in critical applications. See selectivity curves at right. Gain = approx. 12 dB.

Model	Tuning Range	Price
HRA-144	143-150 MHz	\$49
HRA-220	213-233 MHz	\$49
HRA-432	420-450 MHz	\$59
HRA-()	150-174MHz	\$69
HRA-()	450-470 MHz	\$79

SAVE A BUNDLE ON VHF FM TRANSCEIVERS!

FM-5 PC Board Kit - ONLY \$178 complete with controls, heatsink, etc. 10 Watts, 5 Channels, for 2M or 220 MHz.



Cabinet Kit, complete with speaker, knobs, connectors, hardware. Only \$60.

REPEAT OF A SELLOUT!

While supply lasts, get \$60 cabinet kit free when you buy an FM-5 Transceiver kit. Where else can you get a complete transceiver for only \$178

LOOK AT THESE ATTRACTIVE CURVES!

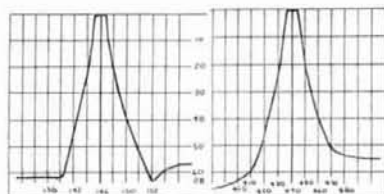

Typical Selectivity Curves of Receivers and Helical Resonators.

IMPORTANT REASONS WHY YOU SHOULD BUY FROM THE VALUE LEADER:

1. Largest selection of vhf and uhf kits in the world.
2. Exceptional quality and low prices due to large volume.
3. Fast delivery; most kits shipped same day.
4. Complete, professional instruction manuals.
5. Prompt factory service available and free phone consultation.
6. In business 21 years.
7. Sell more repeater modules than all other mfrs. and have for years. Can give quality features for much lower cost.

- Call or Write for **FREE CATALOG**
- (Send \$1.00 or 4 IRC's for overseas mailing)
- Order by phone or mail • Add \$3 S & H per order (Electronic answering service evenings & weekends) Use VISA, MASTERCARD, Check, or UPS COD.

hamtronics, inc.

65-E MOUL RD. • HILTON NY 14468

Phone: 716-392-9430

Hamtronics® is a registered trademark

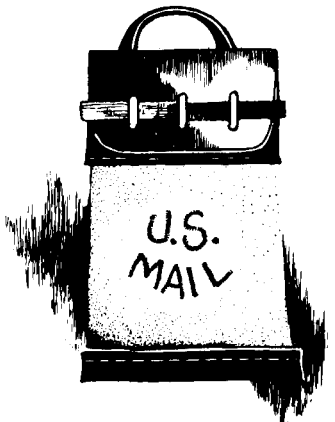

comments

Amateur Radio — not what it used to be?

Dear HR:

As a lifetime subscriber, I have a few comments about K2RR's account of his maritime experiences ("Reflections," November, 1984, page 5). I was in the Merchant Marine during World War II, but as a fireman/water tender/oiler. I was discharged the day I was to get my commercial ticket and never went to sea again.

K2RR only hinted at what is missing from Amateur Radio today. Gone is the clean language, the exchange of technical information, the invitations to visit (especially to mobiles), the hospitality we used to have, and in short, good manners on the air.

I'm glad I was born sooner and had the opportunity to enjoy Amateur Radio for the last 48 years. I had it at its best.

Albert Kaufman, W1JVO
Bridgeport, Connecticut

grid dipping

Dear HR:

Even though George A. Wilson, Jr., W1OLP, in "Matching Dipole Antennas," (May, 1984, page 129) made at least 24 separate references to GDO (Grid Dip Oscillators) and Grid Dipping, someone is certain to try substituting a solid-state dipper, (such as the Heathkit HD-1250 or one of several factory assembled versions) when exciting the RF Bridge discussed in the article. In fact, with the solid-state dip-

user group agrees on 23-cm band plan

Over 100 users of the 23-cm band (1240-1300 MHz) reached agreement on an updated regional plan to serve the needs of the southern California area for the next three years at a meeting in Orange County, California. Present and participating at the meeting, sponsored by the Southern California Repeater and Remote Base Association (SCRRBA), were representatives of all users' modes currently operational, or likely in the future to require spectrum, on 23 cm.

Each of the 23-cm band users' groups (ATV simplex, ATV repeaters, weak signal/experimental, FM voice repeaters/links, digital, satellite/AMSAT, VRAC, VUAC, and

SCRRBA) selected a representative to participate in a four-hour roundtable and negotiation session. The resulting plan — basically a modification of the existing plan — was prepared specifically for use in their region. Key stipulations provide that the plan will remain in effect for the next three years, after which time a similar meeting will again be held to review the existing band utilization patterns, and that the frequency allocations of existing users' groups will change only as new users' groups begin to operate on the band.

Because the region leads the nation in terms of 23-cm band activity, SCRRBA suggests that the band plan shown in **table 1** may be useful to other coordination councils in preparation of their own regional band plans.

— SCRRBA

table 1. A comparison of present and modified 23-cm band utilization plans (courtesy SCRRBA, P.O. Box 5967, Pasadena, California 91107).

band segment	present usage	new usage (initiated as needed)
1240 - 1246	ATV repeater (Channel 1) (1241.25 video carrier, VSB filtering required)	ATV repeat (Channel 1) (1241.25 video carrier, VSB filtering required)
1246 - 1248	narrow-band FM point-to-point links (voice)	same plus narrow-band digital (< 50 kHz BW)
1248 - 1258	ATV repeater (Channel 2) video carrier 1253.00	
1248 - 1251.5		wideband digital (> 500 kHz BW)
1251.5 - 1252		guard band
1252 - 1258		ATV repeater (Channel 2) video carrier 1253.25, VSB filtering required
1258 - 1260	narrow-band FM point-to-point links (voice)	same plus narrow-band digital (< 50 kHz BW)
1260 - 1270	satellite uplink ATV repeater (Channel 4) 1277.00 video carrier	satellite uplink, plus non-coordinated simplex: <i>experimental</i> wideband, no repeater inputs/outputs
1270 - 1272	FM (voice) repeater inputs; 1271.000 "test pair" input	FM (voice) repeater inputs; 1271.000 "test pair" input
1272 - 1282	ATV repeater (Channel 4) 1177.00 video carrier	
1272 - 1275.5		FM repeater future expansion, ACSB systems, linear translators

per far more prevalent today than the old vacuum tube grid dip oscillator (and interchangeable in most applications), no doubt a large number of

hams who build the RF bridge will end up frustrated and with no discernible "dip."

While the solid-state dippers can be

used to determine resonance, per the first part of George's article, it is not likely to provide enough excitation to obtain a reading with the RF bridge unless overcoupled, with sensitivity set at maximum, and with an extremely sensitive μA meter used as the detector. Even a 50 μA meter will probably not allow a discernible "dip" to be obtained!

A rough idea of a dipper's suitability can be obtained by connecting a germanium diode and a small 2 to 3-turn link in series across the μA meter's terminals. Coupling the link to the dipper's coil should easily produce a full-scale reading. If it does not, the dipper cannot be used to excite the RF bridge.

Robert G. Wheaton, W5XW
San Antonio, Texas

receiver input temperature

Dear HR:

Amateur Radio literature never mentions (or I've never seen) the temperature contributed by a transmission line to receiver input temperature. None of this mattered with hot, noisy amplifiers, but it could matter significantly with the low-temperature amplifiers coming into use. If someone can come up with a convincing argument that the transmission line adds no temperature of its own, I'd like to see it. Such a line would make an ideal cold-source for noise measurements.

Picture the line as a string of small attenuators generating their own thermal noise, which is sent in both directions along the line. The noise energy has an equivalent temperature at the line's Z_0 , which is some fraction of the line's ambient temperature.

I derived the temperature output for a small attenuator (0.1 dB, 6.769 degrees K) and summed the cumulative temp (with cumulative losses), generating a chart of temperatures for various losses. It closely follows the equation

$$T = 298 \left[1 - \text{antilog} \left(\frac{-\text{dB}}{10} \right) \right] \text{degrees}$$

Kantronics Interface II We Met the Demands of the Serious Amateur



Suggested Retail \$269.95

INTERFACE II

- Dual Tone Detection copies Mark & Space.
- AM/FM operation for tuning versatility.
- Stable Quartz Generated Tones give clean AFSK Output on all shifts.
- Six Pole Switched Capacitance Filters
- Unique Tuning System displays both Mark and Space Tones, shows Signal Fading. Scope Outputs available.
- RS232 or TTL level compatible.
- Two Channel Operation for simultaneous connection of HF and VHF transceivers.
- Guaranteed compatible with six computers when used with Kantronics Software.

For more information contact your Kantronics dealer or write:
KANTRONICS 1202 E. 23 St.
LAWRENCE, KS 66046

✓ 108

I deliberately ignored the possibility of any energy reflected from the antenna.

This suggests that 30 feet of RG-59B/U could add 127 degrees K at the input to a 432-MHz amplifier, and 6 feet would do the same at 1296 MHz (approximately). 15 feet of 1/2 inch hard-line could add 36 degrees to the input at 1296 MHz.

I'd like to hear if anybody has any thoughts or can suggest any references on this.

Martin Sample, WA6JTD
PO Box 1245
Tuolumne, California 95379

ham radio

RAG

ELECTRONICS, INC.

New and Used Electronic Test Equipment
Sales • Service • Rental • Leasing

■ Polaroid DS-34

Now you can get an instant picture in black & white or color from any oscilloscope screen. Includes CRT hood.
*Large hoods also available to fit computer terminals and CAD/CAM screens.

\$369.00



LEADER Instruments Corporation

Audio Sine/Square Wave Generator

- Distortion from <0.03%
- 10 Hz to 1 MHz

\$259.00



LAG-120B



BK PRECISION

FUNCTION GENERATOR

\$189.00

MODEL 3010

- Sine, square and triangle output
- Variable and fixed TTL outputs
- 0.1 Hz to 1 MHz in six ranges
- Typical distortion under 0.5% from 1 Hz to 100 KHz
- Variable DC offset
- VCO input for sweep tests

POWER SUPPLIES

GLOBAL SPECIALTIES TRIPLE OUTPUT POWER SUPPLY



MODEL 1301

\$198.00

- Fully regulated triple output
- Fixed 5VDC, 1A
- V1 +5 VDC to 18 VDC .5A
- V2 -5 VDC to 18 VDC .5A
- Fully automatic current limiting

BK PRECISION

TRIPLE OUTPUT POWER SUPPLY



MODEL 1650

\$319.00

- Functions as three separate supplies
- Exclusive tracking circuit
- Fixed output 5 VDC, 5A
- Two 0 to 25 VDC outputs at 0.5A
- Fully automatic, current-limited overload protection
- + and - terminals of each output are fully isolated, in all modes
- All three outputs may be connected in series or parallel for higher voltage or current



ELECTRO INDUSTRIES, INC.
Precision Test Instruments

DC POWER SUPPLY



\$125.00

MODEL 3002A/0-30 VDC/0-2A

VIZ

MULTI-FUNCTION COUNTER



MODEL WD-755

\$259.00

- 5 Hz to 125 MHz
- 8 Digit LED Display
- Period Measurement 5 Hz to 2 MHz
- Totalizes to 99,999,999 Plus Overflow
- Frequency Ratio Mode
- Time Interval Mode
- Switchable Attenuator & Low Pass Filter



PROBE MASTER

Oscilloscope Probes

MODEL	ATTENUATION	BAND WIDTH (MHZ)	PRICE
2904	10X	100	\$35.00
2901	10X/1X	100/5	\$39.00
2205	10X	250	\$59.00
2960	10X	60	\$30.00

STACO ENERGY PRODUCTS CO.

VARIABLE TRANSFORMER

\$145.00



MODEL 3PN1010V

RAG CARRIES THE COMPLETE STACO VARIABLE TRANSFORMER LINE
CALL US WITH YOUR REQUIREMENTS.

DIGITAL CAPACITANCE METER



- Battery operated
- 3 1/2 digit LCD display
- Range 1 PF to 2,000 UF
- 0.2% basic accuracy

GLOBAL MODEL 3000

\$139.00

CALL US TOLL FREE

1-800-732-3457

IN CALIFORNIA TOLL FREE

1-800-272-4225

- Master Charge
- VISA ■ COD
- Money Order
- Check



COD's extra (required 25% deposit) over \$1000.00 \$15.00

ADD FOR SHIPPING AND INSURANCE

\$0 to \$250.00 \$4.50

\$251.00 to \$600.00 \$6.50

\$601.00 to \$750.00 \$8.50

\$751.00 to \$1000.00 \$12.50

over \$1000.00 \$15.00

RAG ELECTRONICS, INC. / 21418 Parthenia Street / Canoga Park, CA 91304 / 1-818-998-6500

SCOPE SPECTACULAR



PORTABLE OSCILLOSCOPES

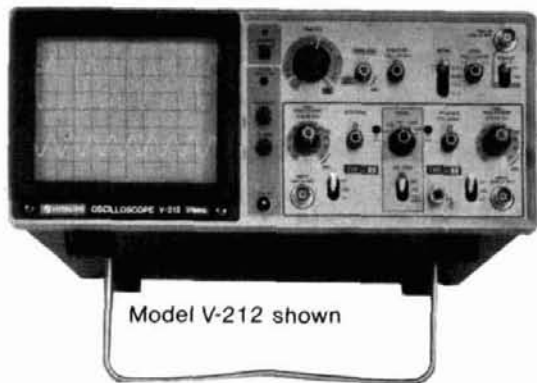

Model V-212 shown

MODEL V-212 \$461.00
DC to 20 MHz, 1 mV/div, Dual Trace
Features 6" Rectangular CRT
Full 2 year parts and labor warranty (w/two X10 probes).

MODEL V-222 \$536.00
DC to 20 MHz, 1 mV/div, Dual Trace, D.C. offset for DMM Output, Vertical Mode Trigger
6" CRT (w/two X1/X10 probes).

MODEL V-422 \$694.00
DC to 40 MHz,
other features same as V-222 (w/two X1/X10 probes)



Model V-1050F shown

MODEL V-1050F \$1276.00
DC to 100 MHz, .5 mV/div, Quad Trace, Delayed Sweep, Full T.V. Triggering, alternate time base (w/two X10 probes)

MODEL V-650 \$956.00
DC to 60 MHz, 1 mV/div, tripple trace, delayed sweep, Full T.V. Triggering, variable trigger hold-off (w/two X10 probes)



PORTABLE OSCILLOSCOPES



MODEL SS-5702 \$535.00
DC - 20MHz, 5 mV/div
Dual trace
6 inch rectangular internal graticule CRT.
Includes 2 each X1/X10 probes and full factory warranty; 2 years on parts, labor and CRT.

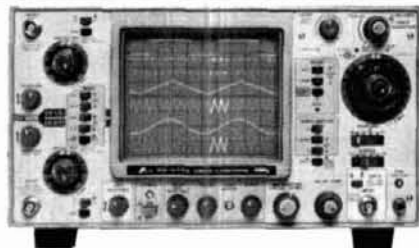

MODEL SS-5705 \$899.00
DC to 40MHz
Vertical and horizontal deflection accurate within $\pm 2\%$. CRT acceleration voltage 12KV. 3 channels, 6 traces. High precision calibrator ($\pm 1\%$). Fastest sweep rate: 10 ns.

- High sensitivity 1 mv/div
- CH1 signal output
- Beam finder
- Delayed sweep
- Alternate time base
- 2 ea. X1/X10 Probes

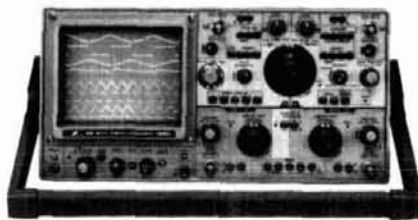

MODEL 5711 \$1695.00
DC to 100MHz (typically over 120 MHz), 5 mV/div, True 4 channel input, eight trace, Delayed sweep, alternate time base, CRT acceleration voltage 20 KV, (w/saddle bag, front cover, 2 ea. X10 probes).

MODEL 5711D \$2495.00
(5711 with counter and DMM).

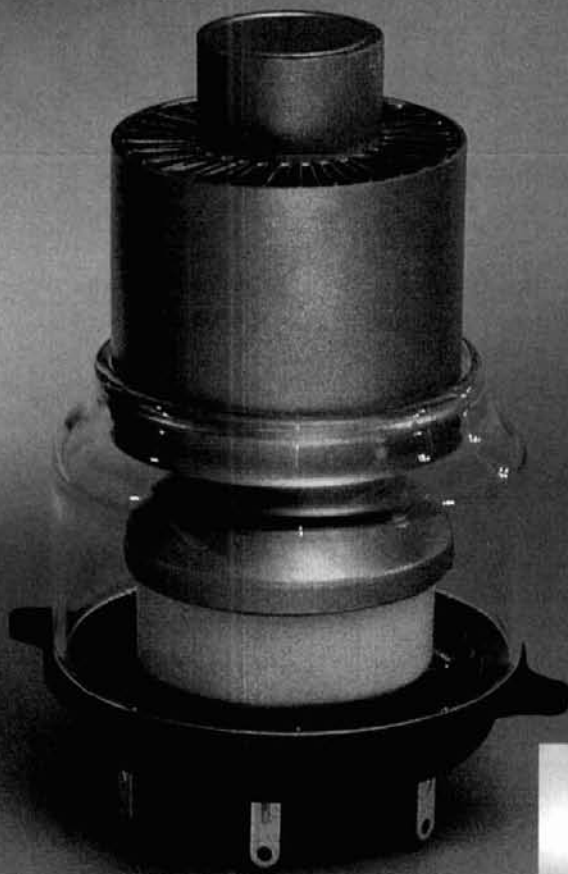

When the FCC changed the rules, EIMAC was prepared for continuing HAM operations.

The FCC changed the allowable output power for linear amplifiers in amateur radio service. Hams can now run at 1500 watts PEP into an antenna. EIMAC was right there to meet requirements with its 3CX1200A7 tube.

Low-cost replacement for small spaces.

RF cabinets of many linear amplifiers currently use the EIMAC 3-500-Z tubes. The new 3CX1200A7 for design takes size into consideration and, by design, is recommended as a single, low-cost replacement for a pair of EIMAC 3-500-Z tubes for new amplifier designs.

General Specifications

The EIMAC 3CX1200A7 is a high- μ , compact, forced air cooled triode for zero-bias class AB2 amplifiers.

- 2.9" dia. x 6.0" long
- Plate dissipation: 1200 watts
- Glass chimney SK-436 available
- Standard EIMAC SK-410 socket available

More information is available on the new EIMAC 3CX1200A7 tube from Varian EIMAC, or any Electron Device Group worldwide sales organization.

Varian EIMAC
1678 S. Pioneer Road
Salt Lake City, Utah 84104
Telephone: 801 • 972-5000

Varian AG
Steinhauserstrasse
CH-6300 Zug, Switzerland
Telephone: 042 • 23 25 75



ELECTRO-SCAN 85

The most
trouble free
Dish Positioner on
the market today.

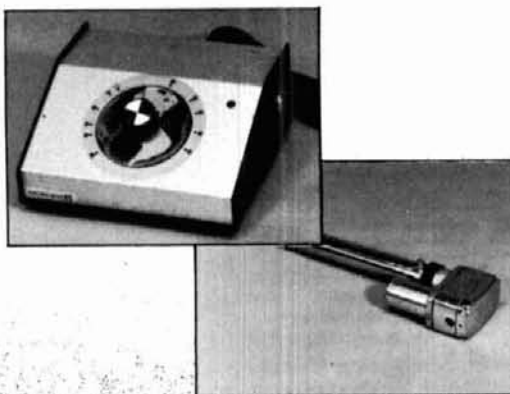

Features

- Economical
- Lock and Key
- 36 volt DC motor
- Precise positioning
- Analog Micro Systems
- 1 year limited warranty
- State-of-the-art circuitry
- LED to indicate dish movement
- Available in 18" or 24" ball actuators
- Modern, attractively styled control box
- Dial control always showing dish location
- Dial channels same as in program listings

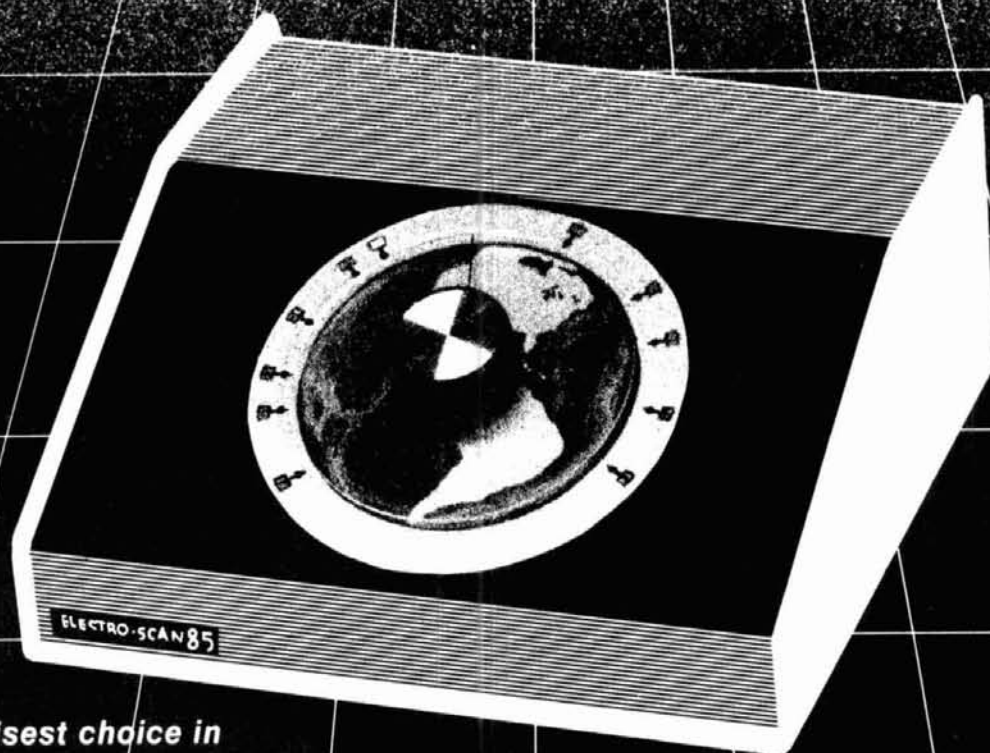

*Your wisest choice in
automatic dish positioners.*
To learn more about the finest
in low cost, high performance
dish positioners, contact...

ELECTRO-COM
DIST. SALES

8459 North Main Street • Suite 112 • Dayton, Ohio 45415 • Phone (513) 454-0232

digital HF radio: a sampling of techniques

Tomorrow's technology
is at work
in the military today

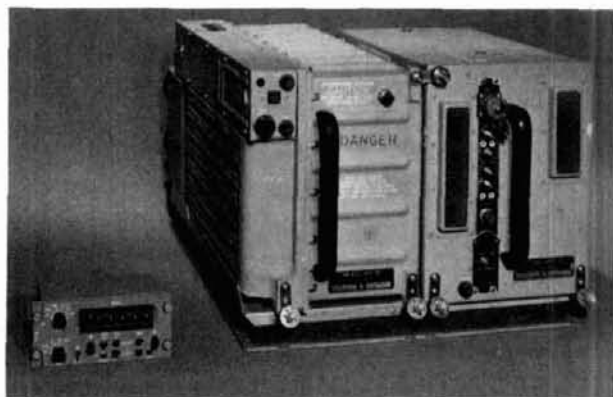

fig. 1. P-3C AN/ARC-161 HF radio set.

Thinking of military communications equipment, one conjures up the image of sturdy, olive drab-colored, compact all-inclusive designs that meet stringent operating requirements. On the other hand, when one thinks of Amateur Radio equipment, a different picture comes to mind. Instead of the predictable "military" designs, one imagines a diversity of commercial homebrew items with little uniformity of design or form.

But which spectrum environment — military or Amateur — is more congested? Which demands more stringent operating requirements? The answer is not obvious.

From his unique vantage point as president of Communications Consulting Corporation, Dr. Rohde, an experienced receiver designer and active ham provides insight into how military equipment designers solve their problems of congested spectrum using the most sophisticated techniques and materials. Some circuits will doubtless appear in Amateur Radio applications — perhaps a few may already have done so.

— Editor.

Until recently, HF radios for the military (fig. 1) have been designed and built in the traditional analog way, with selectivity obtained through the use of LC or crystal filters in the IF section and active filters in the audio frequency section. These radios have been used for point-to-point operation where only infrequent change of operating frequency was required. In addition, these point-to-point connections were used with constant output power.

In order to meet communications goals for 1985 and beyond, particularly in military applications, modern HF equipment must be adaptive, frequency agile and capable of supporting secure digital voice communications. It must be capable of operation on both a point-to-point and networked basis as well. Adaptivity is needed both to control transmitter power to a level no greater than required for the connection, and to select frequencies which provide good propagation with a minimum of interference.

Frequency agility is desirable in the event of deliberate jamming or rapid change of propagation conditions. Transceivers must have the ability to change frequency rapidly enough to adjust to changes in environment. While propagation conditions normally change relatively slowly, avoiding a jammer requires a repetitive fast change of frequency called *frequency hopping*. For a jammer to be effective in disrupting communications, it must either be extremely powerful, use a high-gain antenna, and cover a wide frequency range, or operate narrowband and try to predict or detect the frequencies on which the frequency hopper is operating and jam only those.

By Dr. Ulrich L. Rhode, KA2WEU/DJ2LR, 52 Hillcrest Drive, Upper Saddle River, New Jersey 07458

Generally, the optimum hop rate for communication is determined by a trade-off between implementation cost and a combination of operating considerations which include expected propagation delays (related to distances between jammer and communicators), capabilities of enemy direction-finding and jamming equipment, and required communications distances, bandwidths, and reliabilities. Taking all of the above into account, recent Army, Air Force, and Navy requirements have focused on hop rates in the range of several hundred to several thousand hops per second as needed to satisfy most military situations (actual rates are classified information). Frequency-hopped signals faster than 1 millisecond or so are difficult to locate with currently-deployed tactical direction-finding hardware and would require a costly "Fast-Follow" jammer to track and jam the communications on a hop-by-hop basis.

other processing techniques required

Often frequency hopping alone is insufficient to defeat deliberate jamming. Modern HF transceivers must be equipped with sophisticated signal processing techniques that provide several levels of redundancy and/or error correction capabilities. These techniques, involving more complex circuitry and larger instantaneous bandwidths, allow recovery of desired signals even in the presence of high levels of natural noise or deliberate jamming. The modern HF transceiver has an RF portion which must be "transparent" to the real brains of the transceiver, the digital signal processing circuits.

Finally, military HF radios must be designed to support the transmission of secure voice and data. Although many techniques exist for manipulating analog voice signals to provide privacy, the U.S. military has settled on the encryption of digitized voice as being both easier to accomplish and more secure. Also, to overcome frequency selective fading characteristics of HF, techniques for digitizing voice have included bandwidth compression as well. This is because narrowband signals suffer less distortion. What is sought is the lowest possible bit rate that produces acceptable speech quality when converted back to its analog form.

voice encoding technique

Linear predictive coding (LPC is the compression scheme currently favored by the U.S. military for HF links. Used at a bit rate of 2.4 kbps in the ANDVT (U.S. Navy Advanced Narrowband Digital Voice Terminal), LPC encodes the voice as numbers derived from the instantaneous spectral characteristics of the voice. The numbers themselves have no relationship

in an analog sense to the original voice signal, but they are used in an inverse process to produce an approximate analog signal resembling the original voice. The process is not unlike that used in children's toys that speak (e.g., "Speak and Spell"™).

Present military standards have settled on LPC-10, a linear predictive coding/decoding algorithm which compresses 3 kHz speech to a 2 kilobits per second data stream. The algorithm uses a linear mathematical relationship to predict the value of each successive sample it is digitizing and hence the name.

To make the compressed data secure, it is encrypted by combining it in a unique mathematical fashion with a string of numbers generated by a "key" generator. The result is a new succession of data carrying voice information encrypted by the "key" and the method of combining it with the voice data.

At the receiver, demodulation depends on synchronously detecting the transmitted bits even though they cannot yet be converted to intelligible voice. Then, by proper mathematical application of the same "key" used to encrypt the original data, the decrypted bit stream is applied to the inverse of the LPC process, and the spectrum-related numbers are converted back to analog speech.

The entire process depends heavily on maintaining good channel quality so that accurate bit timing at the receiver may be achieved; the most important aspect is to preserve timing relationships. A decision at the receiver as to whether a received symbol (character) is a "one" or a "zero" must not be made during a symbol transition period. As the data rate increases it becomes more difficult to insure that the receiver is making its decisions at the proper time. Decision errors, the result of distortion that occurs between characters (inter-symbol distortion) cause degradation in the overall system performance. Timing relationship distortions are the result of frequency selective phase shifts that arise from differences in path length as the signal component at each frequency passes through and reflects from different layers of the ionosphere. The narrower the instantaneous bandwidth of the radiated signal, the fewer the perturbations. Consequently, the best results are achieved by using the narrowest instantaneous bandwidth design.

With simple forms of modulation such as a Binary FSK, Bi-Phase FSK, or even AM, 6 kHz or more bandwidth would be needed to send the 2.4 kbps LPC signal. To fit the signal into a standard 3 kHz voice channel requires more sophisticated modulation schemes. For example, to achieve 1 Hz/bit packing density, ANDVT uses a 39-tone parallel modulation scheme. The 2.4 kbit data stream is split into a number of parallel data streams transmitted at a lower rate. According to the ANDVT algorithm, each of the slower streams modulates one or more of the 39 tones.

— For the Best —

**HF, VHF, UHF, SSB,
FM, RTTY, PACKET,
CW, ASCII & AMTOR**

★ ★ ★ ★ ★ ★ ★ ★



IC-37A 220 MHZ COMPACT MOBILE

25 Watts, 32 PL Frequencies Standard Built-in, 9 Memories with Offset and PL Storage, 10 KHz/5 KHz Dial Steps, Memory Scan, Band Scan, and Priority Scan, Dual VFO's and Standard HM-23 Touchtone.



IC-27A COMPACT MOBILE

A breakthrough in 2-meter mobile communications! Most compact on the market (5½"W × 1½"H × 7"D), contains internal speaker for easy mounting, 25 watts, 32 PL frequencies, scanning and touchtone microphone.



4' LIGHTWEIGHT FLEXIBLE
ANTENNA ADAPTOR
CABLE



IC-02AT HANDHELD

The IC-02AT 2-meter LCD readout handheld features 10 memories, 32 PL tones, scanning keyboard frequency entry, dial lock, 3W standard, 5W optional, DTMF.

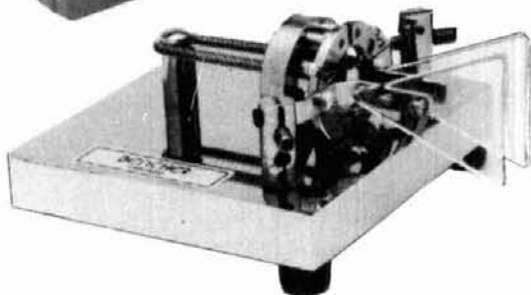

Bencher PADDLE

This is the paddle that provides the perfect interface between the CW operator and his rig. Smooth, instantly responsive and fully adjustable to suit your own touch. From the gold plated solid silver contacts to the heavy leaded steel base, it truly is the ultimate.



THE R3 NO RADIAL VERTICAL
FOR 10-15-20 METERS



8/84

C & A ROBERTS INC.

18511 HAWTHORNE BOULEVARD
TORRANCE, CALIFORNIA 90504
(213) 370-7451 (Calif.) • (800) 421-2258

REMEMBER WE SHIP
(UPS Brown - Cont. U.S.A.)

STORE HOURS: 10:00 a.m. - 5:30 p.m. MONDAY THRU SATURDAY

The resulting tones are summed in an analog summer and applied as conventional analog modulation at the exciter.

This parallel modulation approach trades complexity and transmitter efficiency for narrow bandwidth. The transmitter (at maximum power) has to be able to handle the case in which all tones add in-phase (maximum power out) and, as a result, must operate well below peak output power most other times. Complexity results from having to handle parallel channels both at the transmitter and receiver. At the receiver, careful tracking of frequency and phase is needed to insure that demodulation of each tone occurs properly. Further, for the frequency hopping case, differences in path length at each frequency must be compensated for on a hop-by-hop basis. Nevertheless, these techniques do work and are being incorporated, primarily in software-based modems into new military HF equipment.

An alternate approach under study at RCA is a serial modulation scheme which processes blocks of data taken in sequence from the data stream. Each block is encoded as one of several tones. If 6 bits of data are taken at once and the modem has 64 (2^6) available tones in a 3 kHz audio bandwidth to pick from, then each 6 bits of data determines which one of those tones is to be transmitted. The selected tone is transmitted with a duration of roughly six times the original bit duration; the transmitter operates at full output power; and the instantaneous bandwidth, once the system is synchronized, is one-sixth that of the parallel scheme. This approach has been implemented and tested at RCA. Its penalties include a complex synchronization and demodulation algorithm and a rather unique (and objectionable) on-air "signature."

key digital building blocks

Traditional analog circuit techniques are inadequate to meet the previously stated requirements. The modern HF transceiver must be based not only upon new intelligence, but on a new set of "building blocks" as well. Many of these building blocks are digital functions performed entirely by software routines; others, involving high computational rates, are better implemented by using dedicated digital hardware. Some of the more obvious building blocks include the following:

Modems. Modems, in general, are required to process voice or data and to provide the necessary waveforms, usually at IF, to the exciter and receive them from the receiver. Selection of the waveform is critical since performance of the entire link depends on the features it possesses. The waveform is said to be "robust" if it has at least two levels of redundancy in its synchronization scheme. It must also have built-in

error detection and correction as well as preambles, which allow channel quality measurements. In addition, the waveform may have to support a variety of data rates to maintain high quality information transmission as link conditions degrade.

Digital filters. For reasons of flexibility and performance, digital filtering is preferred in the IF and audio frequency sections of the transceiver. The ability to choose an appropriate filter type and time constant greatly simplifies modem design. Also, under software control, it is possible to have a digital filter assume any of the classic shapes or performance characteristics as required. Although either Chebyshev or Bessel characteristics are generally used, others can be selected. On the negative side, use of sophisticated digital filters sometimes requires correction of group delay effects of any remaining LC or crystal filters in the transceiver. Also, real time digital filters require correspondingly fast high-resolution A-to-D and D-to-A converters as well as high throughput microcomputers. Two devices ideally suited to digital filter implementation are the Texas Instrument TMS-320 and the RCA (internally developed) high performance ATMAC II CMOS/SOS Processor.

Frequency synthesizers. Sufficiently fast-switching frequency synthesizers cannot be easily implemented in the traditional analog form using multi-loop PLL synthesizers; instead, the direct digital synthesizer (DDS), to be described later, is required. The DDS features arbitrarily fine resolution and uses a cosine look-up table together with a microprocessor, a D/A converter, and a lowpass filter to generate such waveforms. The DDS can be built with switching times between 1 μ s and 50 μ s, with the actual switching time dependent on the D/A converter and the number of glitches produced by the sampling and integration process. A limiting signal-to-noise ratio of about 75 dB, which has to do with the sample rate, is the current state-of-the-art.

The direct digital frequency synthesizer output is mixed with the output of a conventional single-loop PLL synthesizer with wide loop bandwidth. This PLL then determines the settling time of the overall system.

Agile antenna couplers. Since wideband antennas aren't commonly used, the transmitter or receiver has to be matched to the antenna on a hop-by-hop basis. The switching speed of the antenna coupler is thus part of the overall system switching time. Conventional relay couplers can be built with 10 ms switching speed relays, and there are claims for future reed relays that will provide 1 ms switching times. However, if 10-100 (or more) frequency changes or hops per seconds are required, the lifetime of the mechanical devices will be soon depleted. The typical lifetime of these devices is about 2 million operations or, at 100

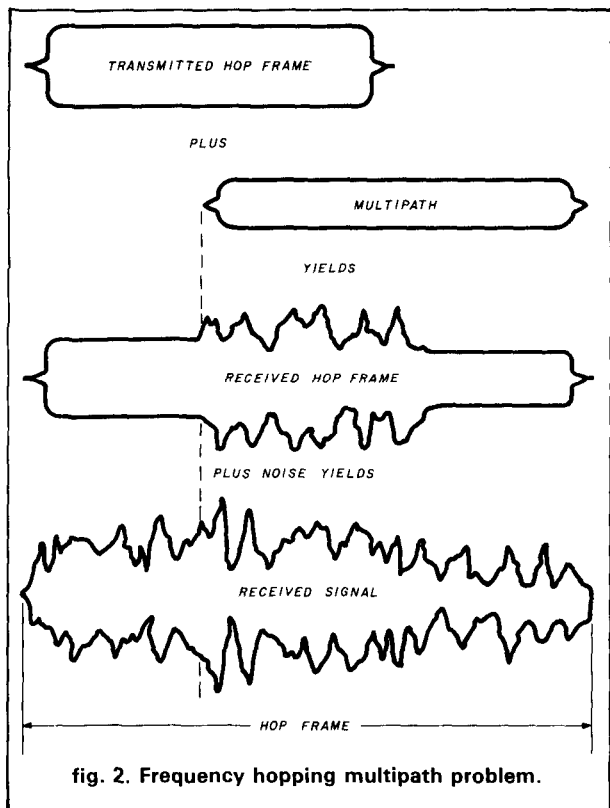

fig. 2. Frequency hopping multipath problem.

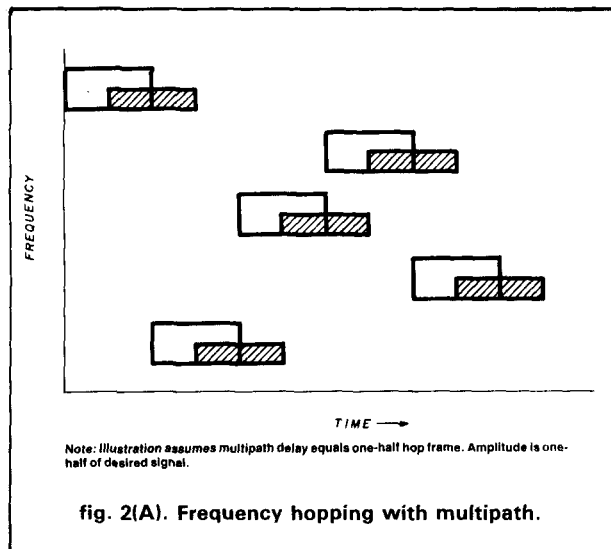

fig. 2(A). Frequency hopping with multipath.

switches per second, 20,000 seconds — only three hours of continuous use.

Modern couplers, then, must employ solid-state switching, for which the use of PIN diodes is the obvious choice.* Such a coupler uses a quasi-binary coded arrangement of inductors and capacitors that are switched in and out of the matching network by PIN diodes. Because antenna couplers have to be built to handle power levels of up to 1 kW, as much as 8,000

*See "High Power RF Switching with PIN Diodes," by J.R. Sheller, KN8Z, *ham radio*, January, 1985, page 82.

volts DC is required for reverse biasing; forward currents of up to 2 amps are necessary. In order to generate these voltages and currents, special dedicated switching power supplies have to be provided, and a mechanism is needed to bring the voltage or current to the switching diodes without introducing parasitic stray effects.

Having summarized both the basic requirements and some of the key building blocks for modern digital HF radios, we'll now examine some specific design approaches.

frequency hopping receiver design

The need to frequency-hop at HF, especially in the presence of multipath, places the most stringent requirements on the modern HF transceiver. The following section discusses frequency hopping, design considerations, and introduces the unique problems created by frequency hopping. Several means of solving these problems are considered, and a novel solution illustrating the use of digital techniques is presented.

Frequency hopping in a multipath environment.

The effect of multipath distortion is depicted in fig. 2. A transmitted hop frame represents a burst of signal energy radiated at one frequency and received by a frequency hopping receiver (synchronized to the transmitter). A multipath is a burst of identical signal energy, delayed in time and reduced in amplitude. The number of multipaths, amount of relative time delay, and attenuation of the received burst depend on link characteristics such as frequency, separation, and time of day.

What the receiver actually "sees" during its dwell time (window) is a combination of all the energy contained in all the multipath bursts on the frequency. This is illustrated in fig. 2, both with and without noise. This burst distortion will be different for each frequency while frequency hopping. The receiver must be able to correctly demodulate the transmitted information in this distorted signal.

Intersymbol interference reduction techniques.

If a transmitter is sending a succession of symbols (such as ones and zeros), the receiver's job is to identify those symbols and convert them back to intelligible information. When a signal includes additive noise, errors occur because the difference between the two levels is not as clearly defined. When multipath corruption occurs, symbols actually overlap and intersymbol distortion occurs. This is a special type of distortion which requires more sophisticated processing to overcome. Inter-symbol distortion caused by multipath is generally what limits the throughput capability (maximum data rates) of HF links. A number of techniques have been tried to reduce inter-symbol in-

table 1. Current HF signal processing techniques.

technique	concept	remarks
parallel tone differential quadriphase shift keying (DQPSK) modulation	long bauds on adjacent frequencies — nonadaptive	selective fading causes high error rates high peak-to-RMS ratio transmitter
parallel matched filters or rake processing	pulse matched filter (correlation)	good for low data rates or when $WT > 30$
linear equalization	minimize distortion by filtering the received signal	severe multipath causes high error rates requires training sequence and updating
decision feedback equalization	minimize distortion by filtering the received signal and past decisions	tracking problem, requires training sequence and continuous update
maximize likelihood estimation	message matched filter viterbi decoding algorithm	exponential growth with multipath delay tracking problem

interference, with the most common method shown in **table 1**. We will concentrate here on equalization.

Equalization techniques. **Figure 2A** illustrates a simplified model of frequency hopping with multipath. It shows a frequency-versus-time plot of a pseudo-randomly hopped signal. Each frequency is represented by a received signal component and a cross-hatched multipath signal of one-half amplitude and delayed half the hop frame. Let's look at the problem of implementing an effective equalizer in this hopping environment.

When a single frequency hop frame is examined (assuming receiver synchronization), as in **fig. 3**, the received signal is present for the entire hop frame, while the multipath signal may be observed only during part of the hop frame, identified as period *B*. During period *A*, the first part of the hop frame, the received signal is not corrupted by multipath components, and one would expect only normal atmospheric and receiver noise to be present. Trying to eliminate multipath during this period using feedback equalization would actually degrade the desired signal. In fact, *no* special processing should take place during period *A*. During period *B*, however, the signal is corrupted by multipath and some processing may be used to reduce the multipath interference.

But there is a further complication in that a single communications link or net is not necessarily the sole user of a frequency band or a family of hopped frequencies. This is especially true in the crowded HF band. Consequently, the simplified model must be extended to include a large number of users who may share the same frequencies. The shared use of frequencies by several synchronized nets is illustrated in **fig. 4**.

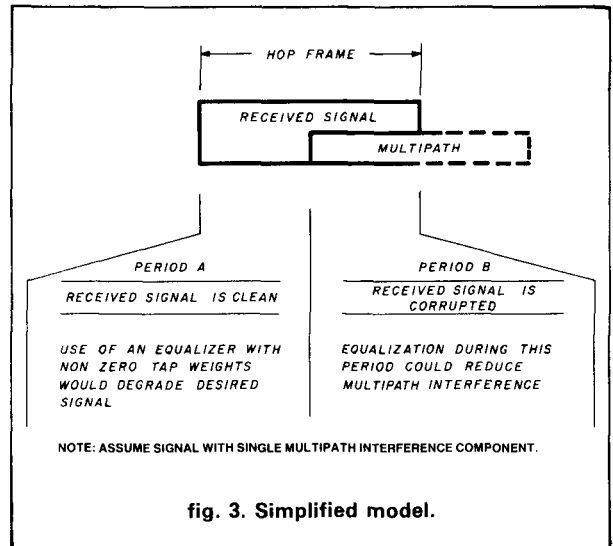
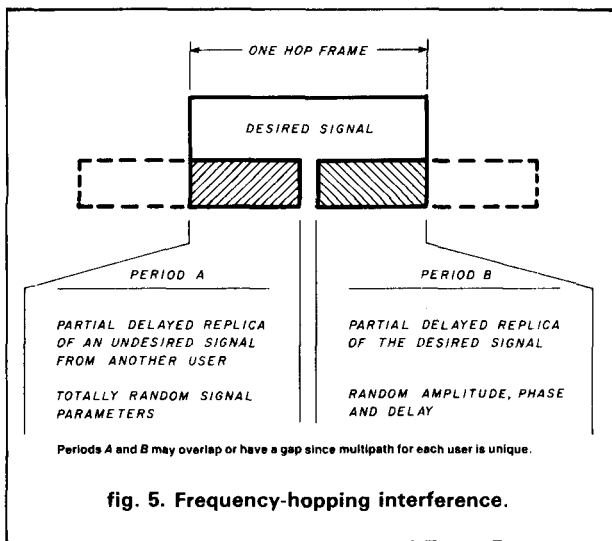
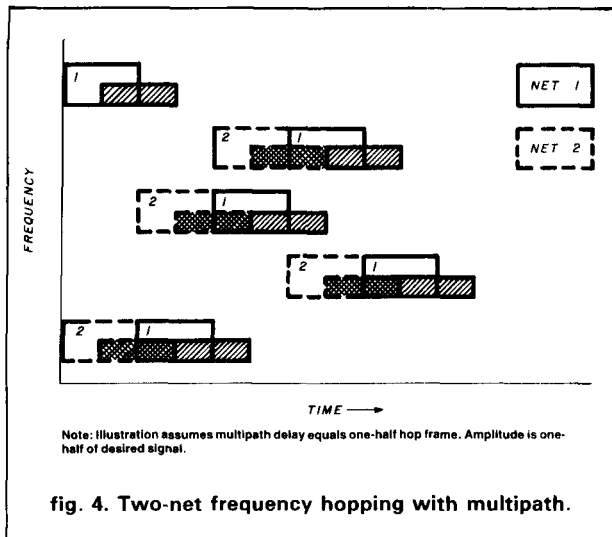

fig. 3. Simplified model.

Additional "friendly" stations cause problems. Multiple users in a network present a more complicated interference pattern at the receiver. This is illustrated in **fig. 5**. The hop frame contains the desired signal and two distinct and different interference components. During period *A* there is a new delayed replica of an undesired signal from another user or from another net. This signal has totally random parameters with respect to the desired signal.

Also if the frequency hopping rate is increased to "outrun" the multipath, interference will be present from the multipath components of other synchronous net users and from others sharing the frequency.

In **fig. 5**, each hop frame is shown as consisting of the desired signal and several different types of interference. During the first part of the hop frame, (period *A*), random interference is present which does not cor-



relate with the desired signal. The only known technique to reject this type of interference, which may have the same waveform characteristics as the desired signal, is to use correlation processing, which rejects uncorrelated random noise. This type of processing, achieved by deliberately spreading the spectrum of the original signal at the transmitter and compressing it again at the receiver, cannot be easily achieved at 2.4 kbps data rates. This is because the usable channel bandwidth is already fully occupied by the non-redundant digitized and compressed voice signal. To maintain occupied bandwidths at 3 kHz or so while transmitting data at 2.4 kbps, time-gated adaptive equalization may be used. The name time-gated is applied because it should only be active during period B, when the multi-path burst is a replica of the desired signal. During period B, even a high speed dedicated processor will be taxed. For each multipath component, the individual tap locations must be determined. When frequency hopping over a 10 percent

bandwidth, tap location variations corresponding to relative multipath delays may be small, but the amplitude and phase weights differ for each frequency hop frame. Weights may also have to be varied from hop to hop due to doppler shifts encountered on the channel — the result of ionospheric variation, as well as motion of the user. Because of these effects, amplitude and phase of the tap weights cannot be determined only once and revised each time the same frequency is revisited. They must be determined for each hop. Prior data may be helpful as an initial estimate, but cannot be relied on for adequate equalization.

sample design approach to multipath processing

An equalizer is actually a matched filter that attempts to model the corrupted channel as a function of time. The input to the equalizer is a composite waveform consisting of wanted signal, noise plus distortion components. The approach to be described is based on an RCA-developed adaptive algorithm which repeatedly calculates the ratio of desired signal to signal plus noise plus distortion. Maximizing the ratio by rapidly adjusting characteristics of the equalizer comprises the adaptive process. When the ratio is maximized, the equalizer is said to be "converged to the value best representing the inverse of the corrupted channel." Passing the corrupted input signal through the adjusted equalizer essentially removes the corruption and gives the best possible signal. The process is very much like that used to equalize trans-Atlantic telephone cables, except that in this process the equalizer characteristics must be adjusted each time the transmitter-receiver pair hops to a new frequency.

The basic operation consists of storing all signal samples received during the dwell on a particular frequency. The digital processor uses the samples to compute the equalization measure described above until a final value is found. In reality, the equalizer resembles a tapped delay line with complex weights applied to the signal developed at each tap. The taps are summed and, using an appropriate algorithm, added to the original input signal. An equalization value is computed for each set of tap weights examined. The tap weights producing the highest equalization value are then applied to the equalizer and the original set of signal samples filtered and passed on for further processing.

For binary FSK signals, the equalization value can be found from spectral energy measurements using a Fast Fourier Transform (FFT). The process consists of taking the spectral energy in the two carrier frequencies and comparing it to the energy in the remaining in-band spectral region after the carrier frequencies have been deleted. The equalizer is optimally adjusted

UNINTERRUPTED FREQUENCY COVERAGE

100 KHz ~ 1.4 GHz with RF CONVERTERS for

SX-400

SERIES

SCANNING MONITOR RECEIVER



FIRE
EMERGENCY

MARINE

AIR

SPACE INFORMATION
BUG DETECTOR

SSB (USB, LSB) CW, AM, FM



RF-8014 DOWN CONVERTER

800 MHz ~ 1.4 GHz RF converter for SX-400

● Bands: MAIN (to cover 26-520 MHz with SX-400) • 800 MHz ~ 1.0 GHz • 1.0 GHz ~ 1.2 GHz • 1.2 GHz ~ 1.4 GHz • AUTO (Automatic control of RF-8014 with an external computer, etc.) ● Frequencies shown in SX-400 display: 500 MHz lower between 800 MHz ~ 1.0 GHz, 700 MHz lower between 1 ~ 1.2 GHz, 900 MHz lower between 1.2 ~ 1.4 GHz ● Individual Band Switches and LED Indicators ● Current Drain: 250 mA (approx.) ● Accessories: 1 BNC/M adapter, 1 Cable with BNC terminal ● Dimensions: W 148 × H 51 × D 225 (mm)

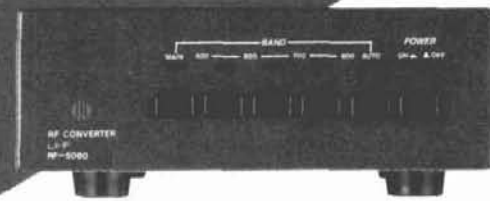

RF-5080 DOWN CONVERTER

500 ~ 800 MHz RF converter for SX-400

● Bands: MAIN (to cover 26-520 MHz with SX-400) • 500 ~ 600 MHz • 600 ~ 700 MHz • 700 ~ 800 MHz • AUTO (Automatic control of RF-5080 with an external computer, etc.) ● Frequencies shown in SX-400 display: 300 MHz lower between 500 ~ 600 MHz, 400 MHz lower between 600 ~ 700 MHz, 500 MHz lower between 700 ~ 800 MHz ● Individual Band Switches and LED Indicators ● Current Drain: 250 mA (approx.) ● Accessories: 1 BNC/M adapter, 1 Cable with BNC terminals ● Dimensions: W 148 × H 51 × D 225 (mm)

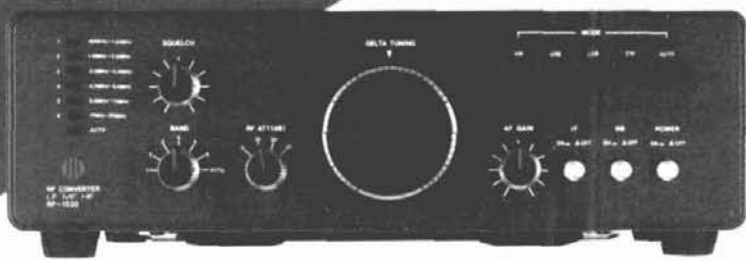

RF-1030 UP CONVERTER

100 KHz ~ 30 MHz RF converter for SX-400

● Bands: (1) 100 KHz ~ 1 MHz, (2) 1 ~ 2 MHz, (3) 2 ~ 4 MHz, (4) 4 ~ 8 MHz, (5) 8 ~ 17 MHz, (6) 17 ~ 30 MHz • AUTO (Automatic control of 6 bands of RF-1030 with an external computer, etc.) ● Frequencies shown in SX-400 display: 50 MHz higher on all bands than the frequencies received ● Individual Mode Switches and LED Indicators: AM, USB, LSB, CW, AUTO • CW filter (optional) required for CW reception • AUTO — Automatic Control of modes of RF-1030 with an external computer, etc. ● Band Switch and LED Band Indicators, Squelch Control, RF Att, AF Gain Control, Delta Tuning, IF ON/OFF Switch, NB (Noise Blanker) Switch ● Current Drain: 1 A (approx.)

* Power Supply Unit P-1A (optional) required for RF-1030 ● Accessories: 1 BNC/M adapter, 2 Cable with BNC terminals ● Dimensions: W 300 × H 90 × D 233 (mm)



ACB-300 ANTENNA CONTROL BOX

Manual and Automatic antenna control system for SX-400 series RF converters

● Individual Band Switches and LED Indicators: 1030, 5080, 8014, 1.4 GHz UP (for reception of 1.4 GHz above) AUTO (Automatic control of antennas for RF-1030, RF-5080, RF-8014 and for MAIN scanner) ● Current Drain: 50 mA (approx.) ● Accessories: 1 Cable with BNC terminals ● Dimensions: W 148 × H 51 × D 225 (mm)



SX-400

26 ~ 520 MHz General Coverage Scanner

● Wider Coverage (100 KHz ~ 1.4 GHz or above) with RF converters (optional) ● Computer controlled memory channel expansion (unlimited) High Speed reprogramming, Record of Frequencies and Time, and all functions remote controllable with RC-4000 Interface (optional) ● 20 memory channels, Momentary recall of any memory channel ● Continuous normal and limit search without interruptions by birds ● Stop Mode Switch for scan or search of modulated signals ● Quick search of the most important frequency with Priority ● Selective FM Narrow/Wide Switch for FM/TV listening ● Variable Delay Control (0 ~ 4 Sec.) ● Current Drain: 1 A (approx.) ● Dimensions: W 300 × H 90 × D 233 (mm)

RC-4000 DATA INTERFACE Control of SX-400 series Scanner and RF Converters through Computer.

● Direct system for NEC 8801A computer ● High Speed Reprogramming of 20 channels ● Scan of unlimited channels stored in computer ● Record of Frequencies and Time of signals received ● Automatic Control of Bands and Modes of RF converters and ACB-300

P-1A REGULATED POWER SUPPLY UNIT ● 1A ● AC: 120V (220V, 240V, 100V available) to DC 13.5V ● Dimensions: W 90 × H 60 × D 135 (mm)

* Design and specifications subject to change without notice

J.I.L.

J.I.C.L.-L.A. CORPORATION, A subsidiary of Japan Industries Co., Ltd. Tokyo, JAPAN
17120 Edwards Rd., Cerritos, Ca. 90701, USA Tel: (213) 936-6727 Telex: 551588

TIME FOR AN AEA BREAKTHROUGH

The high quality of AEA products is appreciated long after the price paid is forgotten.

No Antenna
No Radio
No TV!



\$179.95*

THE FANTASTIC DOCTOR DX™ CW Band Simulation That Is So Real You Won't Believe It!

- Will improve the operating skills of ANY CW operator!
- More fun than ANY Morse Code trainer yet devised.
- Use with a C-64, TV set, and key (or keyer).
- Experience the thrill of a "DXpedition" to anywhere in the world.
- Operate anytime you want, ideal for travelers.
- Impressive award certificates available for verified performance.
- On-going contests: 8-hour sprint and 24-hour marathon.

HOT ROD™

½ Wave Telescope Antenna **\$24.95***

- Fewer telescopic sections than any ½ wave whips.
 - Shorter and lighter than all ½ wave whips.
 - Special matching network designed by Professor D.K. Reynolds (co-inventor of Iso-pole™ antenna) makes Hot Rod competitively priced.
- 



- Most gain attainable for length of antenna—3 dBd (0 dBd for JR models).
- Best decoupling of any commercial VHF base station antenna available.
- More gain than many antennas claiming up to 7 dB gain—don't be fooled by misleading claims!
- Zero degree angle of radiation.
- Factory-tuned matching network.
- Greater bandwidth than any competitive product.
- DC grounded for static discharge protection.
- Documented cases of wind survival in 140+ mph hurricanes.
- Easier than any competitive antenna to assemble.

Mast
Not
Included

ISO = 144 or 220—\$59.95*
ISO = 144 JR or 220 JR—\$49.95*
ISO = 440—\$84.95*

ANTENNA™

I
S
O
P
O
L
E



PKT-1 Packet Controller **\$589.95**

- First commercially available packet controller for Amateur Radio.
- Uses TAPR circuitry and firmware.
- Digital radio communications for computer to computer.
- Easy to use—five usual commands.
- Multiple conversations on simplex channel.
- EVERY PKT-1 is a digipeater.
- Send computer files error free.
- Operates from 9–15 VDC for portable or fixed operation.

ELECTRONIC KEYS



\$109.95*
BT-1 Basic Morse Trainer

- Teaches code at 20 wpm.
- Random practice mode.
- Variable monitor tone.



\$149.95*
KT-2 Keyer/Trainer

- Proficiency Trainer.
- 01–99 WPM.
- Full-feature keyer (no memory).



\$199.95*
CK-2 Contest Keyer

- 10 soft-partioned™ memories.
- Automatic serial number.
- Stepped variable speed.
- Two speed memories.



\$229.95*
MM-2 MorseMatic™

- Memory keyer.
- Auto serial number.
- Proficiency trainer.

All AEA Keyers operate from 9–15 VDC (power supply not included) and offer many more advanced features than can be listed here. It is no accident that AEA keyers are regarded as the best in the world.

TI-1 RTTY/AMTOR Tuning Aid **\$119.95**



- Spectral display of RTTY tones.
- Instant indication of shift (THREE RANGES).
- Built-in speaker with switch for quiet monitoring.

MAP-64/2 **\$239.95***



- Plug-in hardware and firmware for C-64 computer.
- Dual channel filters.
- Ext. 12 VDC reduces load on computer (power supply not included).
- Morse-Baudot-ASCII-AMTOR.
- Most advanced software available.



CP-1 **\$239.95*** Computer Patch™ Interface

- Better performance than any competitive product
- Dual channel filtering with auto threshold correction
- Variable shift
- 117 VAC power supply included

AEA also offers Morse, Baudot, and ASCII software for the following computers: Apple II, II+, IIe; IBM-PC.

Unmatched Software For C-64 And VIC-20 Computers

MBA-TORTM—The most advanced software written for Morse-Baudot-ASCII-AMTOR including mail drop.
MARSTEXTM—A special Morse-Baudot-ASCII package written especially for MARS and other traffic operators.
SWLTEXTM—The most sophisticated software available for the shortwave listening enthusiast. Automatic data analysis; Morse, Baudot, ASCII, AMTOR, and SITOR.



VHF COMMUNICATIONS

915 N. Main St., Jamestown, New York 14701 (716) 664-6345

when the desired carrier frequency energy, less residual energy, is maximized. Thus, the adaptive process would vary the complex tap weights until that difference is maximized.

Appropriate techniques can be found for other forms of modulation and will be discussed subsequently, but in general, they all compare signal energy in a known region of the spectrum (where the desired signal should have the majority of its energy) to the remainder of the spectrum where multipath components lie.

The RCA approach is unique in that it does not require a known signal to be transmitted at the outset of each new hop frame. Such a signal (termed a "training" signal) reduces the usable throughput of the system since it occupies a portion of every hop frame.

A second attractive feature of this equalizer approach is that any arbitrary signal possessing the desired waveform characteristics (i.e. modulation type and rate) may be automatically equalized by applying the same algorithm. This allows a receiving station in a network to automatically equalize signals from any other station in the network without first having to identify which station it is or decode a special "training" signal.

A block diagram of the multipath processor is illustrated in fig. 6. Input signal samples provided by the frequency hopping receiver are stored in an input buffer. When an entire hop frame has been accumulated, the samples are transferred to a second buffer, which stores all the signal samples associated with two hop frames. While the input buffer is collecting new data from a different carrier frequency at the next hop, the *output or hop frame buffer* is used repetitively to perform the equalization. For a frequency hop rate in the low hundreds, there is sufficient time to recirculate the stored data through the equalizer and adjust the appropriate tap weights for highest channel quality.

The output hop frame buffer supplies digitized signal samples to two separate processing functions — the time-gated equalizer and the tap locator. The time-gated equalizer is controlled by the tap locator and the tap weight calculator. After an "equalization complete" signal is provided by the tap weight calculator, the signal samples stored in the receiver signal buffer are passed through the now adjusted equalizer and the corrected data is stored in the output buffer. The signal samples are supplied on demand to the next processing stage, which may be a spread spectrum despreader or data demodulator.

Time-gated feedback equalizer. A time-gated feedback equalizer is shown in fig. 7. Its structure is very similar to that of any other feedback equalizer. It has an input signal, a differencing circuit, and a weighting network. The difference is supplied as an output signal to the data demodulator. The delay line is a multilevel

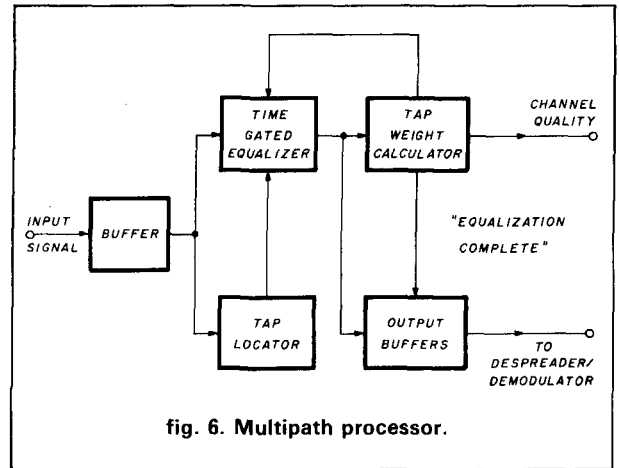

fig. 6. Multipath processor.

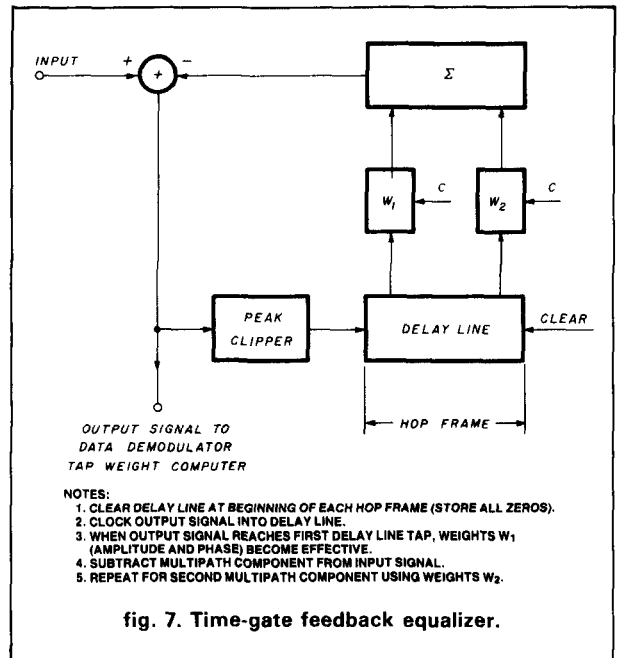

fig. 7. Time-gate feedback equalizer.

shift register equal in length to the hop frame. The tap spacings, corresponding to minimum resolvable multipath delay, are equal to the signal sampling interval, which is considerably smaller than one bit in duration.

The delay line in fig. 7 is tapped in two places. Two multiplying weights, W_1 and W_2 are shown; these are complex and represent both amplitude and phase weights. The resulting outputs are summed and fed back to the input differencing circuit. The peak clipper is incorporated to prevent positive feedback for certain data sets at high multipath levels.

Time-gating the feedback equalizer is achieved by clearing or resetting the delay line to zero at the beginning of each hop frame. Consequently, when a new hop frame starts, there is no feedback. In fact, there will be no feedback until the first samples reach the first tap. At that point, feedback of the appropriate amplitude and phase will begin cancelling the first

BIRD 43

THRULINE[®] WATTMETER

0.45-2300 MHz
0.1-10,000 watts

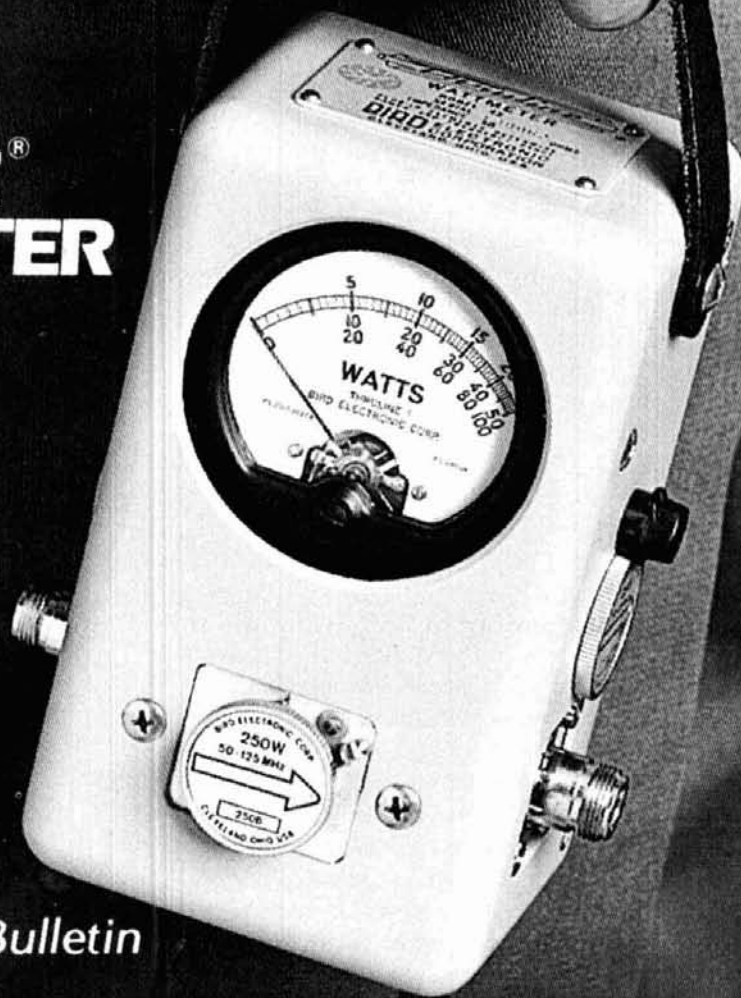

Ask for model 43 Bulletin

BIRD Electronic Corporation
30303 Aurora Rd., Cleveland (Solon), Ohio 44139
216-248-1200 TLX: 98-5298 Cable: BIRDELEC

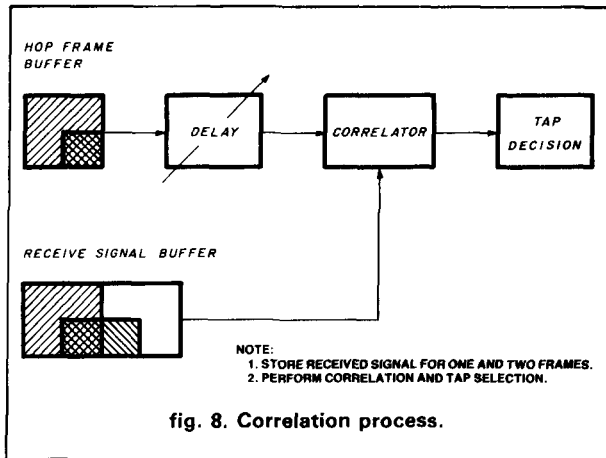

multipath component. (A second multipath component will not become bothersome until the output signal reaches the second tap with amplitude and phase weight W_2 . Up to that time the finite values of amplitude and phase weights of weight W_2 will have been multiplied by the zeros advancing in the delay line and the tap will not have been effective.) After that time, feedback cancels the second component, and so on. The impact of a large number of taps is that additional time is required to optimize the amplitude and phase weights. It is reasonably assumed from HF path predictions that only three to five multipath components will significantly affect a signal. The hardware necessary to process this data is available right now.

Tap locator. The second function in the multipath processor is the tap locator. The receiver provides two signals for use in an auto-correlation function which determines multipath tap locations. Once tap locations are known, the tap weights for the filtering function can be adjusted. This correlation is illustrated in figs. 8 and 9. The original transmitted frame is transferred to two buffers. The contents of the two buffers are then fed to a correlator.

The output of the correlator is examined for correlation peaks above a predetermined threshold, which indicates that a multipath component is present at that particular value of delay. This auto-correlation process determines the multipath delay without depending on any external timing. It is not affected by timing uncertainty or by jitter from one frequency hop to another.

Tap weight calculator. The third major function in the multipath processor is the tap weight calculator, which consists of a channel quality measurement unit and a tap weight programmer. The tap weight programmer alters the amplitude and phase of the tap weights in response to instantaneous channel quality measurement. Because hop frames are buffered, the quality of the channel can be measured repetitively as the equalizer converges and used to control the tap

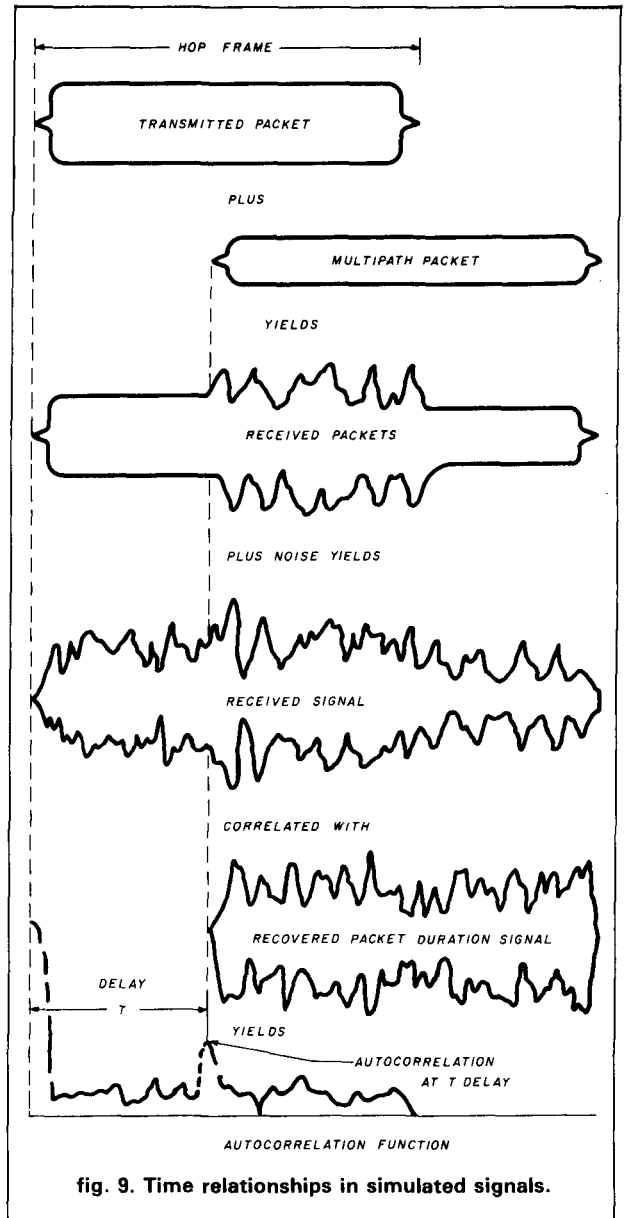

weights in a closed loop fashion. The quality measurement is based on an RCA-patented quality monitoring technique particularly applicable to a variety of angle modulated signals. It does not require any special training signals, but instead operates directly on the data signal.

The principle behind the RCA technique is illustrated in fig. 10. Spectral analysis is performed at the output of the power law device (i.e., a frequency doubler or quadrupler). The RMS value of all the distortion products (that is, all spectral lines except the desired carriers) is *directly dependent* on the multipath amplitude and phase and are independent of the data contents. Therefore, no training signal is required to determine the channel quality.

When a biphase PSK signal, for example, is received, the frequency doppler will change a 180 degree

phase shift to 360 degrees. The data now appears as 0 degrees or 360 degrees, which are equivalent angles. The data modulation has effectively been stripped off and converted to a carrier component; this is precisely how many coherent receivers track phase modulated data. However, the carrier component may not be the only spectral energy that remains after doubling. Any distortion products, including the intersymbol interference produced by the multipath delay, produce modulation sidebands. A *straight-forward measurement of carrier to sideband energy is then used to determine the amount of multipath.*

When QPSK signals are transmitted, the standard carrier recovery technique in coherent receivers quadruples the signal, thereby eliminating the data modulation leaving only an unmodulated carrier signal. Track-

ing is then accomplished on what has essentially become a reconstituted carrier.

When MSK signals are sent, the standard approach to carrier extraction is to double the frequency in the squaring circuit to produce two carriers separated by the clock frequency. This is illustrated for continuous phase FSK in **fig. 11**. In the case of MSK, after squaring, one half the power is distributed between the two carriers. It is standard practice to phaselock a loop to one of the carriers or use the data clock to collapse both carriers into a single component and then phaselock for coherent demodulation of the data. Channel distortion results in less energy in the carrier components and more in the sidebands. Again, the ratio of carrier energy to sideband energy provides an estimate of the channel quality measurement.

The tap weight calculator uses the Channel Quality (CQ) measurements to progressively reduce the uncertainty of the phase and amplitude weights applied to each delay line tap. The CQ is the ratio of the carrier power to the RMS value of all other frequency components after frequency doubling. In the case of MSK, the power in both of the reconstructed carriers is added to achieve a higher CQ and therefore a better measurement. As the tap weights are changed, the CQ value will change dramatically and reach a maximum when best equalization has been achieved.

The simulation example shown in **fig. 12** illustrates rapid tap weight convergence for an assumed multipath amplitude of 0.9 and phase angle of 169 degrees. While seven complete iterations are shown to illustrate the sequence, after the first iteration the phase error is only 11 degrees and the amplitude error 0.4 volts. For purposes of achieving minimum bit error rate performance, this represents complete equalization. Since there is no significant change in the results at the end of the second iteration, the convergence procedure would be halted. If the CQ is high enough, depending on noise and the remaining multipath level, the convergence procedure may actually be halted after the first iteration.

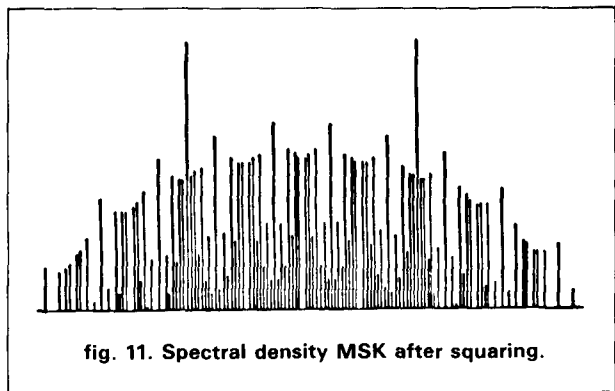
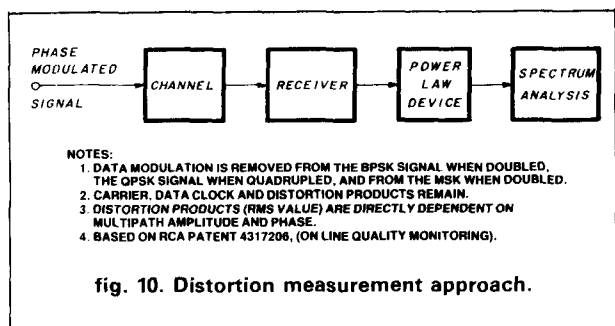

fig. 12. Simulation example of equalizer convergence.

data parameters:		multipath parameters:		equalizer parameters:			
sequence	1	delay (bits)	3.00	tap location	3.000		
frame length	64 bits	amplitude	0.90	threshold	1.000		
samples/bit	8	phase	169.00	input SNR (dB)	5		
iteration	amplitude	phase	amplitude error	phase error	channel quality	data errors	
0	0.000	0.0	-0.900	-169.0	25.6	9	
1	0.500	180.0	-0.400	11.0	16.2	0	
2	0.500	180.0	-0.400	11.0	16.2	0	
3	0.500	157.5	-0.400	-11.5	16.4	0	
4	0.830	157.5	-0.070	-11.5	212.3	0	
5	0.995	157.5	0.095	-11.5	191.5	0	

Acquisition process. Because the equalizer does not require training signals, a frequency hopping receiver can achieve initial acquisition and convergence of its equalizer without requiring a cooperative transmission. **Figure 13** shows a transmitter hopping at a normal rate. The receiver is trying to acquire and determine the tap locations, but this is not apparent to an outside observer. Initial acquisition is accomplished by letting the receiver dwell twice as long on each fre-

quency compared to the transmitter. This means that the receiver will miss alternate frequencies; but, at the same time, it will include in its output data the desired signal as well as the multipath signal. As shown in **fig. 13**, the transmitter hops through six frequencies, but the receiver only sees three of those frequencies. Once acquired, the receiver commences hopping at the same rate as the transmitter. Adding a second receiver can provide coverage of the missed alternate frequencies. The additional expense of a second receiver and a frequency synthesizer are not warranted in most applications.

multipath equalizer summary

When frequency hopping is employed to achieve protection from jamming, the problems posed by multipath distortion on HF radio links increase. The novel approach discussed here illustrates what can be done with digital processing. It is well matched to HF hopping systems and supports a very robust form of MSK modulation with efficient error correction coding and is readily implemented with today's technology.

digital SSB tuning

Another example of the successful application of digital techniques to HF radio is the problem of automating SSB tuning. **Figure 14** illustrates a block diagram of a typical digital HF radio. The digital sec-

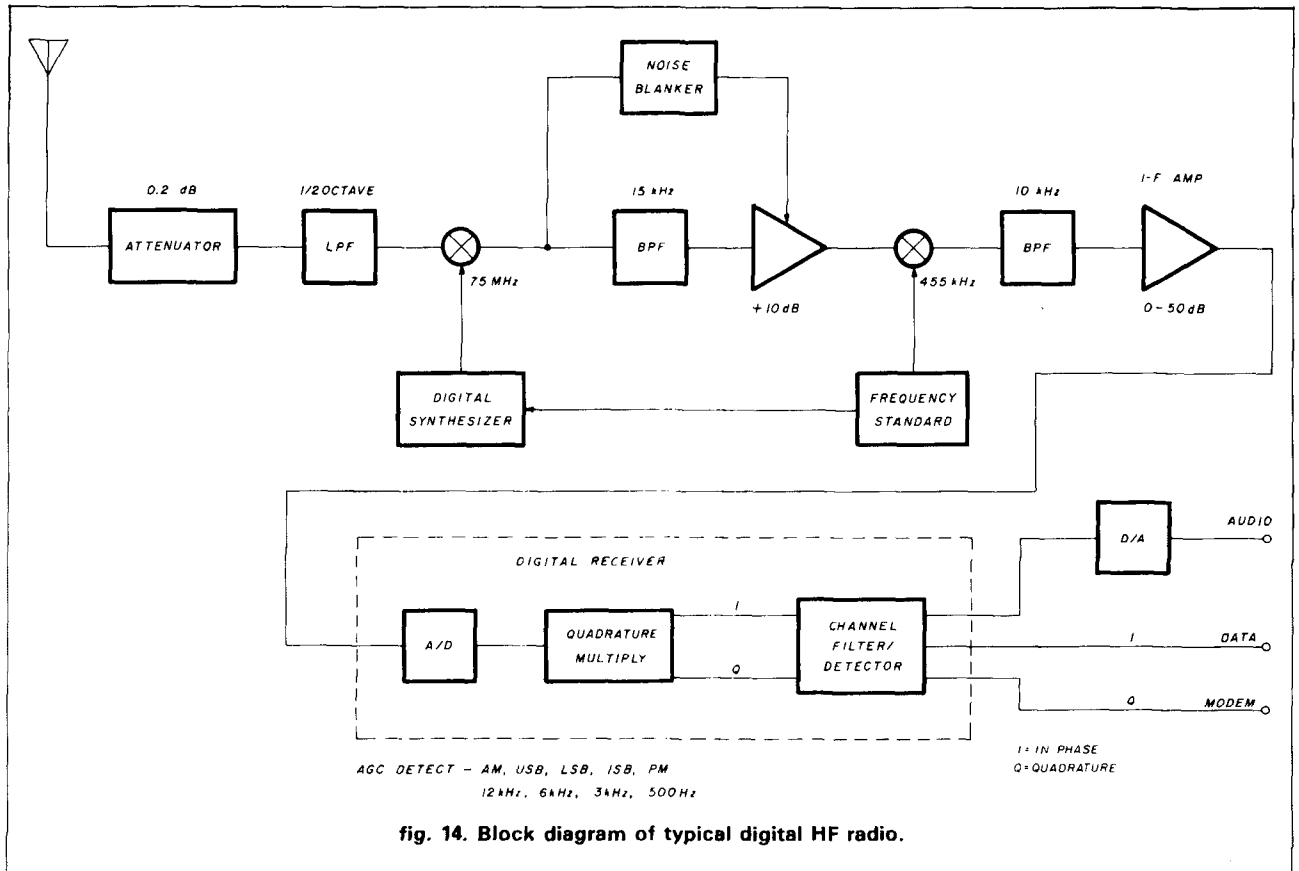
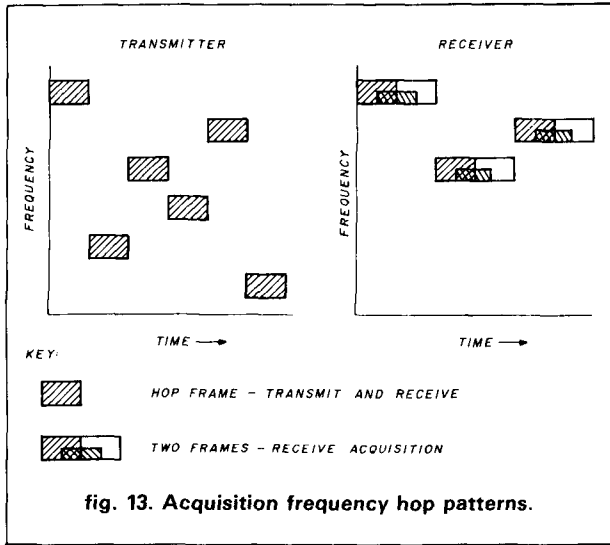

State
of the art



by
K.V.G.

9 MHz CRYSTAL FILTERS

MODEL	Appli- cation	Band- width	Poles	Price
XF-9A	SSB	2.4 kHz	5	\$53.15
XF-9B	SSB	2.4 kHz	8	72.05
XF-9B-01	LSB	2.4 kHz	8	95.90
XF-9B-02	USB	2.4 kHz	8	95.90
XF-9B-10	SSB	2.4 kHz	10	125.65
XF-9C	AM	3.75 kHz	8	77.40
XF-9D	AM	5.0 kHz	8	77.40
XF-9E	FM	12.0 kHz	8	77.40
XF-9M	CW	500 Hz	4	54.10
XF-9NB	CW	500 Hz	8	95.90
XF-9P	CW	250 Hz	8	131.20
XF910	IF noise	15 kHz	2	17.15

10.7 MHz CRYSTAL FILTERS

XF107-A	NBFM	12 kHz	8	\$67.30
XF107-B	NBFM	15 kHz	8	67.30
XF107-C	WBFM	30 kHz	8	67.30
XF107-D	WBFM	36 kHz	8	67.30
XF107-E	Pix/Data	40 kHz	8	67.30
XM107-SO4	FM	14 kHz	4	30.15

Export Inquiries Invited. Shipping \$3.75

MICROWAVE MODULES VHF & UHF EQUIPMENTS

Use your existing HF or 2M rig on other VHF or UHF bands.

LOW NOISE RECEIVE CONVERTERS

1691 MHz	MMk1691-137	\$249.95
1296 MHz GaAsFET	MMk1296-144G	149.95
432/435	MMc432-28(S)	74.95
439-ATV	MMc439-Ch x	84.95
220 MHz	MMc220-28	69.95
144 MHz	MMc144-28	54.95

Options: Low NF (2.0 dB max., 1.25 dB max.), other bands & IF's available

LINEAR TRANSVERTERS

1296 MHz	1.8 W output, 2M in	MM11296-144-G	\$299.95
432/435	10 W output, 10M in	MM1432-28(S)	259.95
144 MHz	10 W output, 10M in	MM1144-28	169.95

Other bands & IFs available.

LINEAR POWER AMPLIFIERS

1296 MHz	20 W output	UP1296-20-L	439.95
432/435	100 W output	MML432-100	369.95
	50 W output	MML432-50	199.95
	30 W output	MML432-30-LS	209.95
144 MHz	200 W output	MML144-200-S	374.95
	100 W output	MML144-100-LS	239.95
	50 W output	MML144-50-S	149.95
	30 W output	MML144-30-LS	109.95

All models include VOX T/R switching.
"L" models 1 or 3W drive, others 10W drive.

Shipping: FOB Concord, Mass.

ANTENNAS

420-450 MHz MULTIBEAMS

28 Element	70/MBM28 12 dBd	\$49.95	\$39.95
48 Element	70/MBM48 15.7 dBd	75.75	59.95
88 Element	70/MBM88 18.5 dBd	105.50	89.95

144-148 MHz J-SLOTS

8 over 8 Hor. pol	D8/2M	12.3 dBd	\$63.40
8 by 8 Vert. pol	D8/2M-vert	12.3 dBd	79.95
10 + 10 Twist	10XY/2M	11.3 dBd	69.95

UHF LOOP YAGIS

1250-1350 MHz 29 loops	1296-LY 20 dBi	47.95
1650-1750 MHz 29 loops	1691-LY 20 dBi	57.95

Order Loop-Yagi connector extra:

Type N \$14.95, SMA \$5.95

Send 40¢ (2 stamps) for full details of all your VHF & UHF equipment and KVG crystal product requirements.



si

(617) 263-2145
SPECTRUM
INTERNATIONAL, INC.
Post Office Box 1084
Concord, MA 01742, U.S.A.

J.I.L. SX-400

Uninterrupted
Frequency
Coverage
100 kHz to 1400 MHz
with Optional Converters



- A professionally created scanner for the serious listener
- Wide frequency coverage 26 to 520 MHz (with optional converters 100 kHz to 1400 MHz)
- Continuous coverage. You'll hear everything.
- Birdie-Free, no internal 'signals' to interfere with scanning
- 20 Channel memory, AM-FM Mode memory, Priority memory
- Carrier Operated Relay (COR) permits automatic start/stop of a recorder
- Four low-noise front end converters for optimum performance
- 12 Volt DC operation (120 Volt AC power supply optional)
- Check JIL's ad in this issue for further details

Sale Price \$549.95 List \$739.90

P-1A Power Supply \$34.95

Other options call

✓ 118



Electronic Equipment Bank

516 Mill Street
Vienna, Virginia 22180

800-368-3270
(703) 938-3350

Your Ham Tube Headquarters!

TUBES BOUGHT, SOLD AND TRADED
SAVE \$\$\$—HIGH \$\$\$ FOR YOUR TUBES

Call Toll Free 800-221-0860

Tubes

3-400Z	\$85.00	7360	\$10.00
3-500Z	85.00	7735A	27.50
4-400A	80.00	8122	110.00
4CX250B	50.00	8156	12.50
572B	55.00	8643	82.50
811A	12.00	8844	26.50
813	30.00	8873	175.00
6146B	6.50	8874	195.00
6360	4.25	8877	500.00
6883B	6.75	8908	12.50

MAJOR BRANDS ON RECEIVER TUBES

75% off list

Semiconductors

MRF 245/SD1416	\$30.00	SD1088	19.95
MRF 454	14.95	2N3055	75¢
MRF 455	10.95	2N6084	12.50

RF Connectors

PL259	10/\$4.95	M358	2.50 ea.
PL258	10/8.95	M359	1.75 ea.
UG 175/176	10/1.60	Type "N" Twist on	
UG255/u	2.50 ea.	(RG8/u)	\$4.75 ea.
UG273/u	2.25 ea.	Minimum Order	\$25.00

Allow \$3.00 min. for UPS charges

✓ 119

CeCo

COMMUNICATIONS, Inc.

2115 Avenue X Brooklyn, NY 11235

SERVING THE INDUSTRY SINCE 1922

Phone (212) 646-6300

Call CECo For Your CCTV Security And Color Production Requirements

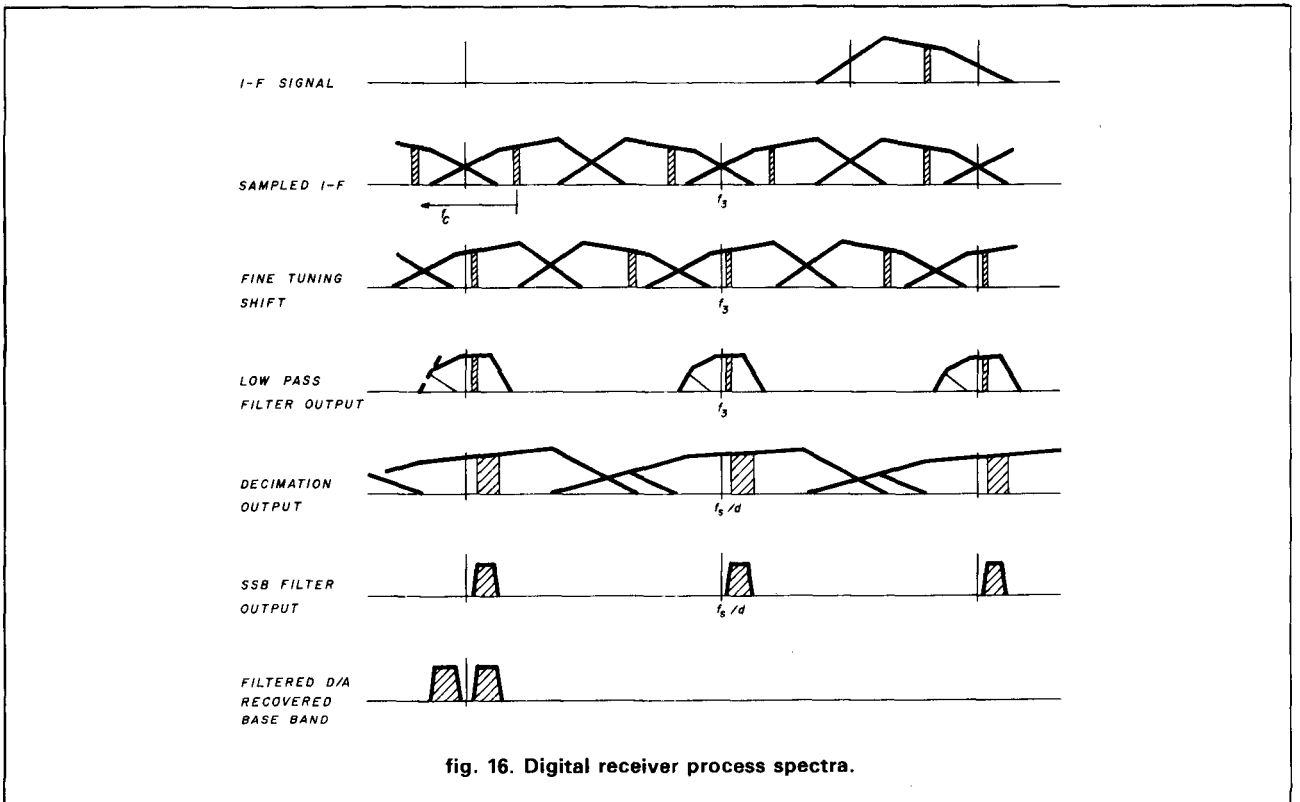
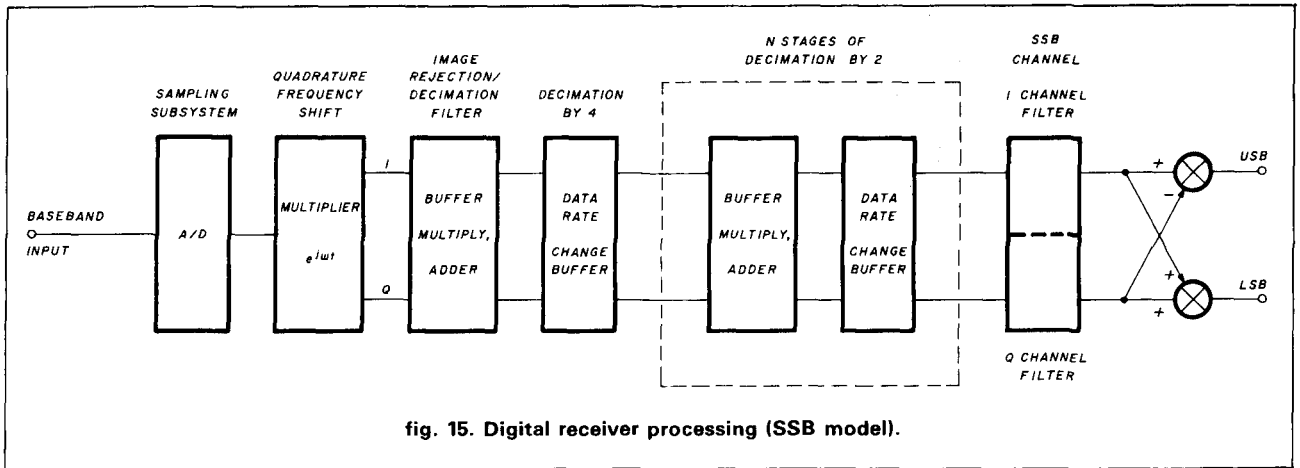

tion of the receiver is indicated within the dotted lines. **Figure 15** shows, again in block diagram format, how SSB detection is performed. **Figure 16** illustrates what signals occur during processing.

The method shown in **fig. 17** can be used to develop a software solution to automatic SSB tuning. The voice bandwidth signal is transformed into a voice power spectrum, which is analyzed to detect harmonic relations and complex correlations of the voice spectrum. Digital signal processing then determines the amount of frequency offset relative to a hypothetical center frequency, and a digital signal then tunes the

frequency synthesizer to correct any offset. This "center frequency" can then be fed to a processor and stored together with the demodulated data.

Alternatively, this process can be used to regenerate the suppressed carrier. If we look at the lowest signal line in **fig. 18**, we see what appears to be pure noise. If enough samples with sufficient bit resolution are collected, it is possible not only to discover the actual suppressed carrier, but also to find 60 cycle hum sidebands. Spectral detail is useful in uniquely identifying specific pieces of radio equipment. Such techniques are known as "fingerprinting."

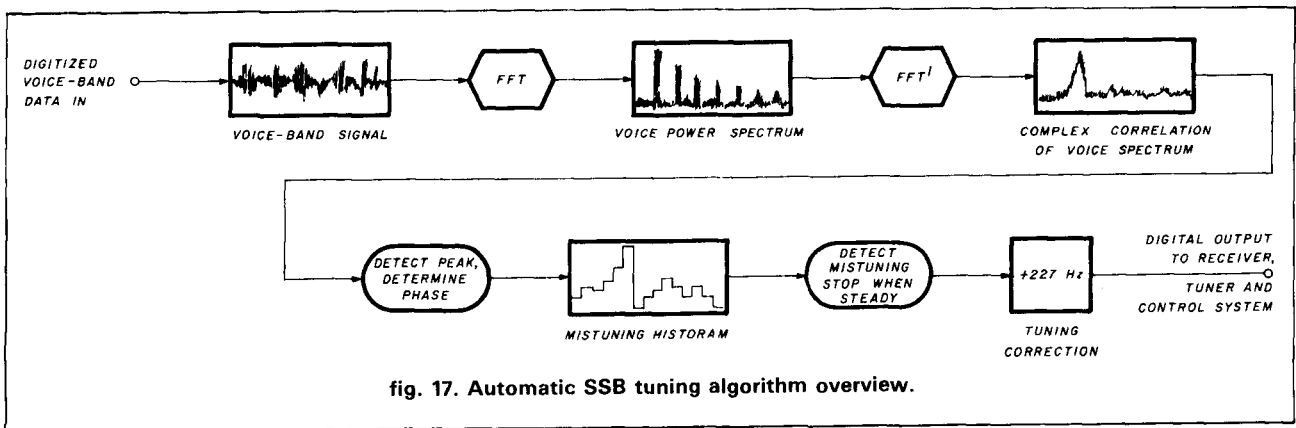

fig. 17. Automatic SSB tuning algorithm overview.

digital waveform generation

Generating analog waveforms from digital signals is another interesting application of this new technology, which allows straight-forward implementation of RCA's "Ampliphase"® system, a modulation scheme used in high-power AM broadcast transmitters.

In its analog form, Ampliphase combines outputs of two individually phased modulated carriers to produce a single AM output signal. Using efficient, non-linear solid-state amplifiers, it is possible to generate many different forms of modulations — rather than only AM — simply selecting the desired mathematical algorithm. A list of modulations appears in fig. 19. Figure 20A shows a digital arrangement that generates AM signals; for explanation, fig. 20B shows the amplitude and phase relationships between the two channels. Depending on the phase shift, different modulation and sideband levels are achieved.

The flexibility of Ampliphase is shown in fig. 21, which illustrates a method of digitally generating four-channel SSB suppressed carrier modulation. Figure 22 shows the digital implementation of constant envelope independent SSB suppressed carrier genera-

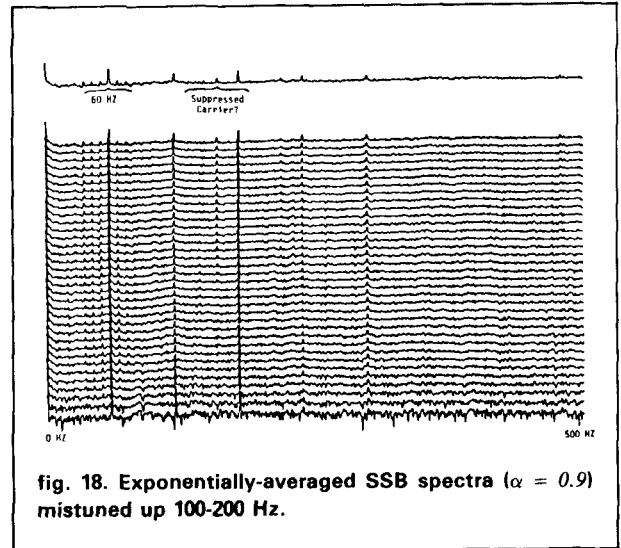

fig. 18. Exponentially-averaged SSB spectra ($\alpha = 0.9$) mistuned up 100-200 Hz.

tion. In each case, the hardware stays the same — but a different algorithm is applied.

digital filter implementation

Perhaps the most familiar application of digital

fig. 19. RCA's Ampliphase® system generates many different forms of modulation.

<i>modulation:</i>	$x(nT) = \text{Re} [Z(nT) \text{EXP} (j\omega nT)]$
DSB-AM	$Z(nT) = \frac{1}{2} + \frac{m}{2} y(nT)$
DSB-SC	$Z(nT) = y(nT)$
SSB-SC	$Z(nT) = y(nT) \pm j \hat{y}(nT)$
PM	$Z(nT) = \text{EXP} [jK y(nT)]$
FM	$Z(nT) = \text{EXP} [jK \Sigma y(nT)]$

demodulation:

DSB-AM	envelope detector $y(nT) = L + 0.3 S \approx \sqrt{I^2(nT) + Q^2(nT)}$
	synchronous detector $y(nT) = \text{Re} [(I(nT) + jQ(nT)) \text{EXP} (j\omega_c nT - \theta_o(nT))]$
DSB-SC	same synchronous detector as DSB-AM
SSB-SC	product detector $y(nT) = \text{Re} [I(nT) + jQ(nT)] \text{EXP} (j\omega_c nT)$
PM	angle detector $y(nT) = \theta(nT) = \text{ARCTAN} (Q(nT)/I(nT))$
FM	discriminator $y(nT) = \theta(nT) - \theta((n-1)T) \approx \dot{\theta}$

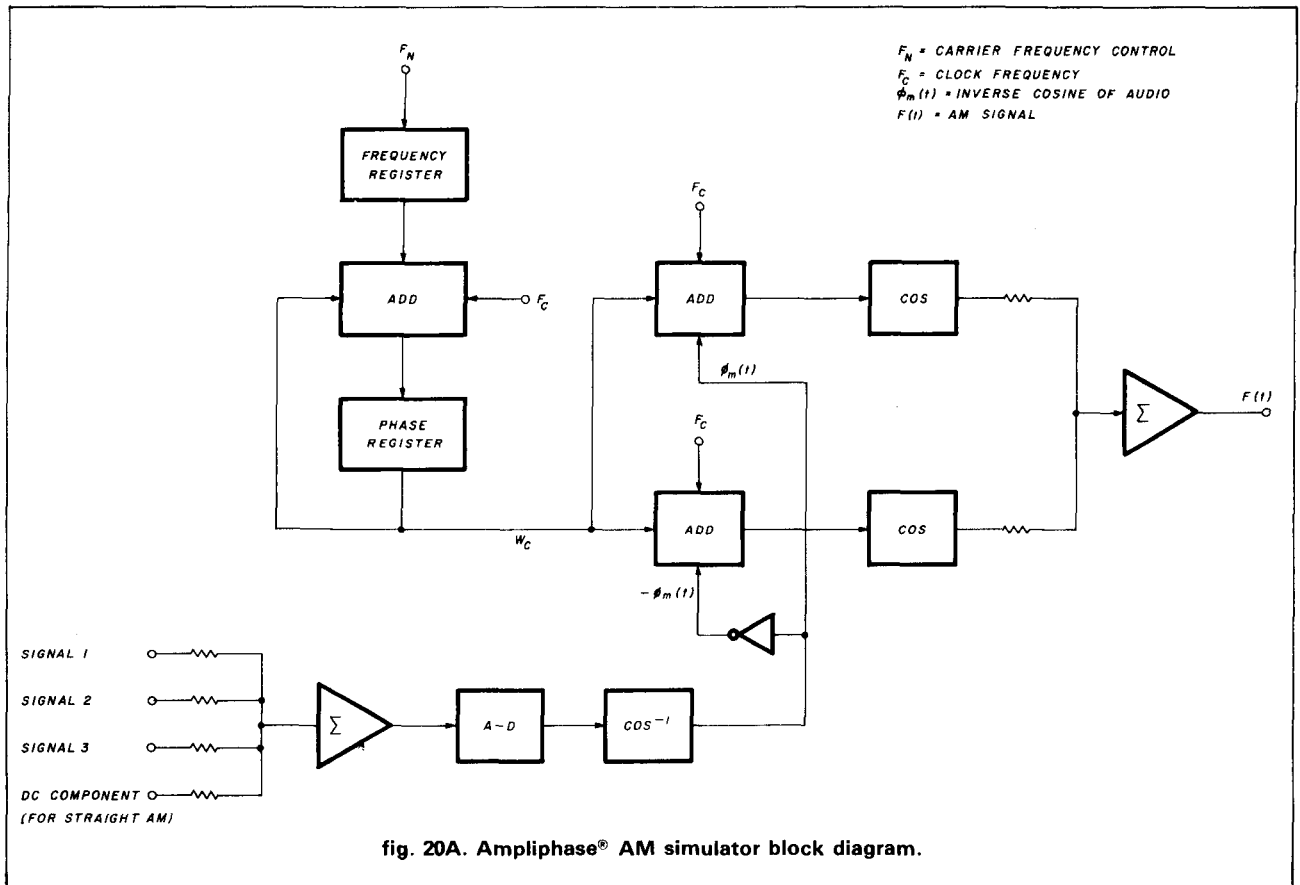

techniques today is the use of digital filters to replace analog components in audio sections of radios. Often, the selectivity of a digital receiver is determined by the quality of the implementation of its digital filters. These digital filters, typically non-recursive finite impulse response filters, are characterized by no more than sufficient performance, although this deficiency is offset by the simple hardware requirements for implementation. The impulse response of these filters can be computed by using the Parks-McClellan FIR design program. **Figure 23** shows predicted performance data for such filters. The filter algorithms are usually implemented entirely in microcomputer software when time allows, or, alternately, using high speed arithmetic processors to enhance throughput. Special arithmetic logic units can also be employed at the output of a filter to generate either the inverse or the magnitude of the output value, depending upon the filter requirements. Finally, the filter output can be either numeric (digital) or analog via a D-to-A converter.

Figure 24 illustrates the predicted amplitude response for a typical FIR filter.

frequency synthesizers

Digital frequency synthesizers, common in today's radios, typically have slow frequency switching speeds

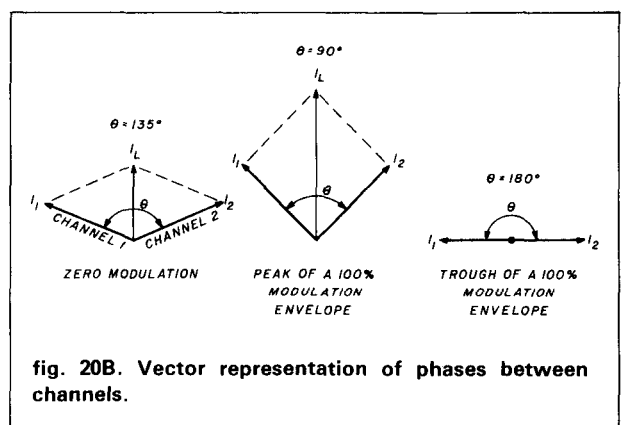

and variable noise performance. But modern frequency synthesizers can be built with almost infinite frequency resolution and very fast switching speed. (The typical design trade-off is noise sideband performance vs. switching speed.) Analog PLL frequency synthesizers are typically limited in their switching speed by the loop bandwidth of the system and hence offer only limited resolution at high speed.

The best approach to building fast frequency synthesizers with fine resolution is to combine either a wideband analog loop with a digital direct frequency synthesizer or a wideband analog loop with a fractional

ENGINEERING MAKES THE DIFFERENCE



Production Expertise And Service Integrity Form The Foundation For Your Long-Term Satisfaction

The fact that the Computer Patch Interface unit by Advanced Electronic Applications, Inc. is known as the best value on the market is no accident. The CP-1 was designed by Al Chandler, K6RFK (PHD-E.E.), an active RTTY user since 1963.

Given a cost per unit budget for the CP-1, Al designed as much performance as possible into the Computer Patch, including a unique new tuning indicator, referred to by one of our customers as the "Dead Eye Dick" tuning indicator. This indicator is ideal for RTTY and CW, in that it is both fast to tune and (within 10 Hz) as accurate as scope tuning. It also performs under poor signal to noise conditions in which other indicators provide no useful data.

Al's variable shift tuning was designed to move the space filter center frequency from 2225 Hz to 3125 Hz without changing the bandwidth (by varying the Q of the filter). All this is accomplished using a precision ganged potentiometer to assure proper tracking of the multiple filter stages. We could have used a pot costing a tenth as much by simply using a two-pole filter design, but we feel the advantage of a sharper filter reduces the noise bandwidth significantly and allows the variable shift control to be used like passband tuning for extra elimination of adjacent channel interference.

Some manufacturers are concerned that amateurs might try calibrating their own equipment and, therefore, have used non-adjustable components, which results in sub-optimal performance. Although more costly, trim pots used in AEA equipment allow factory adjustment for performance to design specifications. Competently designed active filter circuits need not be adjusted after leaving the factory; however, for specialized use the owner can easily change filter parameters.

Mindful of the fact that many of our customers are new to RTTY, Al made the CP-1 tuning as forgiving as possible, while providing the most critical operator a piece of equipment in which he could be proud. Even old "pro's" are surprised at the poor signal conditions under which the CP-1 will still provide good copy.

You can now experience the BEST RTTY, CW, and AMTOR offered. Couple the CP-1 with our new AEASOFT™ software packages designed for the MARS, SWL, or amateur radio operator, and you will feel a pride reminiscent of what "made in U.S.A." brought in years gone by. Please do not hold the low price of the CP-1 against us. This is one case where you get much more than you pay for relative to any of the competitive units. For more information send for our FREE catalog. Better yet, see your favorite dealer.



Henry Radio

2050 S. BUNDY DRIVE
LOS ANGELES, CA 90025
(213) 820-1234

TOLL FREE OUTSIDE CALIF. (800) 421-6631

931 N. Euclid, Anaheim, CA 92801 (714) 772-9200 • Butler, MO 64730 (816) 679-3127

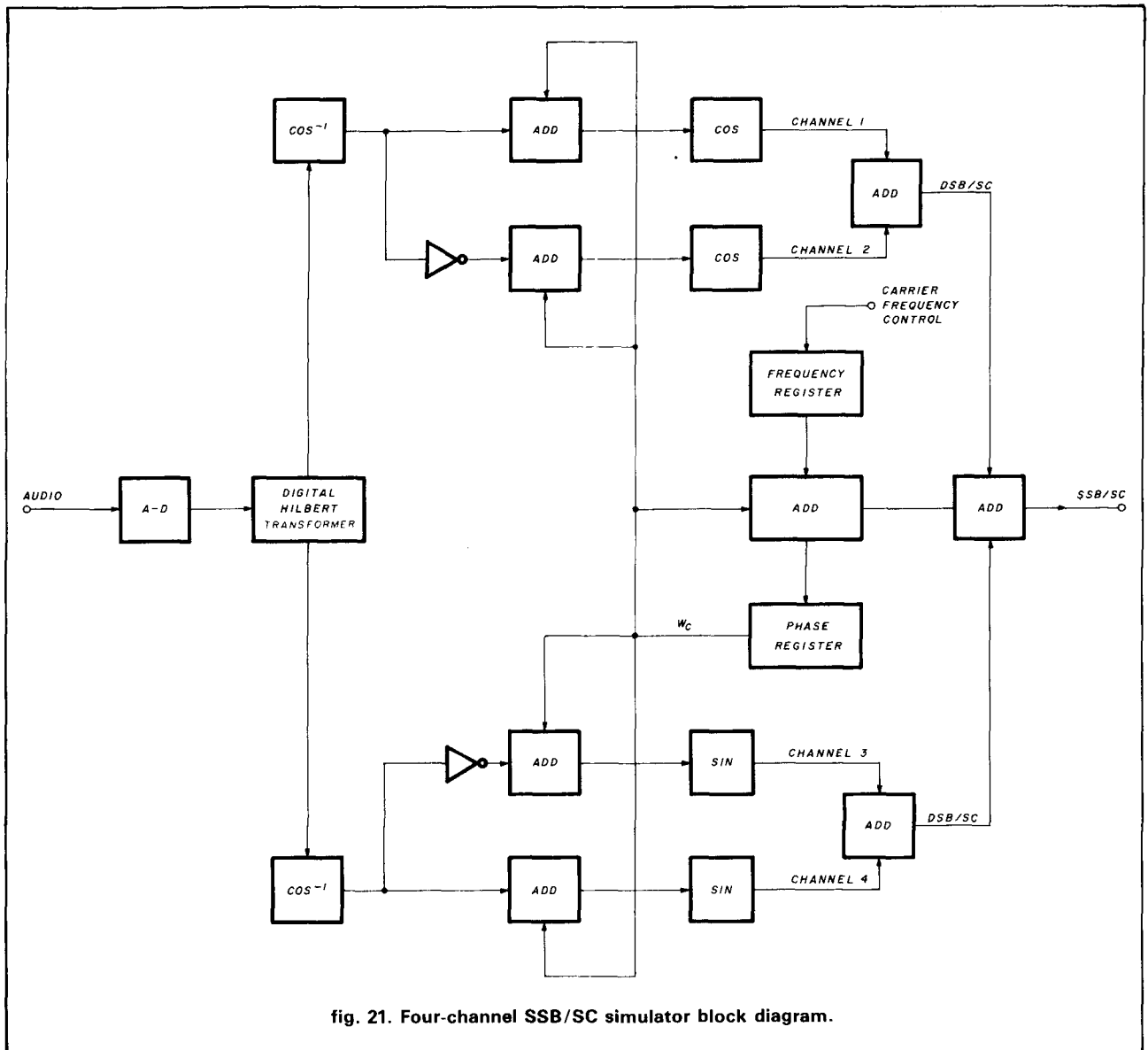

fig. 21. Four-channel SSB/SC simulator block diagram.

divider and synthesizer. **Figure 25** shows one implementation of the former. It is possible to get switching speeds of several hundred microseconds and excellent phase noise at the same time using this technique.

antenna coupler technology

One interesting item not often considered part of the radio is the antenna coupler. Antenna couplers now used provide good RF power transfer between the radios and the antenna. At a single frequency their reliability is not a serious problem. New couplers, with a capability for fast frequency hopping, require new technology to provide fast frequency changes and extended lifetimes — i.e., a predictable period of use without wear-out or breakdown. Because couplers must also be driven by the digital processing system

“brain” of the radio, they require a digital interface and, usually, their own processor and training scheme as well.

available hardware

Antenna couplers presently used on aircraft adapt to the driving point impedance peculiarities of their respective antennas. Though tuning methods may differ in detail (depending on the matching network configuration), tuning always involves the use of motor-tuned and relay-switched reactive elements driven toward 50-ohm convergence by an error signal from magnitude and phase discriminators. Tuning accuracies are quite good (VSWR 1.3:1), and coupling efficiencies range between 40 and 85 percent depending on antenna type and frequency of operation. The disadvantage of this class of antenna coupler, however,

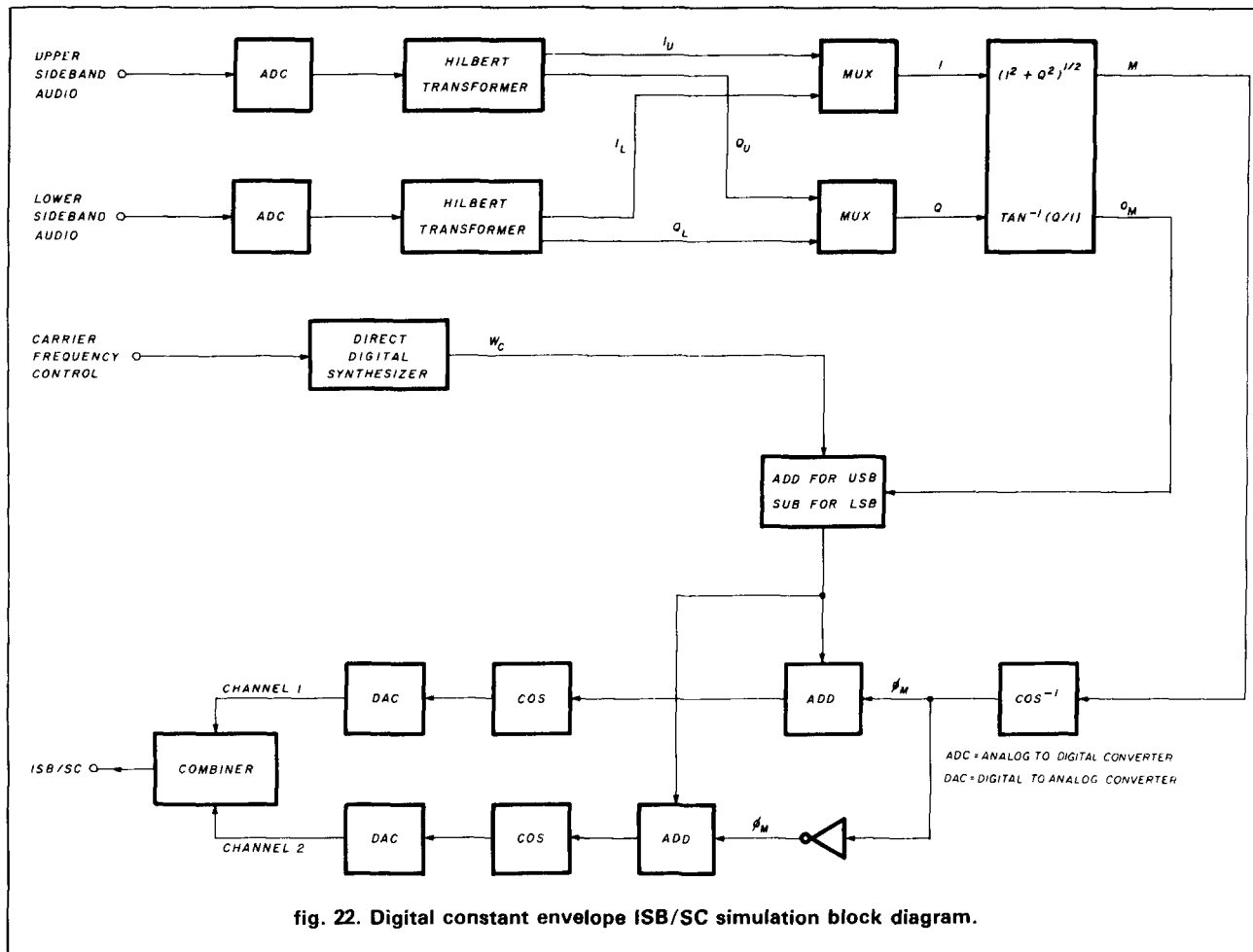

fig. 23. Predicted performance data for digital filters in audio applications.

filter function	input sample rate	output sample rate	2-sided passband bandwidth	ultimate rejection	2-sided BW at ultimate rejection	shape factor	impulse response length (μsec)
FM receive	100 KSPS	50 KSPS	25 kHz	>80 dB	36 kHz	1.4:1	62
AM receive	100 KSPS	25 KSPS	12 kHz	>80 dB	17.2 kHz	1.4:1	124
AM receive	100 KSPS	12.5 KSPS	6 kHz	>80 dB	8.8 kHz	1.5:1	248
SSB receive	100 KSPS	12.5 KSPS	2.7 kHz	>80 dB	5.4 kHz	2:1	248

is relatively long tuning time (from 3 to 15 seconds), and a limited lifetime resulting from the failure of electromechanical drives and switches.

Advanced tuning elements. Given the insufficient durability of electromechanical components, the future of tuned couplers with both fast-tuning times and operational reliability will depend on the use of electronic tuning and solid-state devices. Of the solid-state devices that could be considered for this application, two have been given varying degrees of attention: the saturable reactor and the PIN diode.

A saturable reactor is an RF inductor wound on a

suitable ferrite core whose permeability is varied by an orthogonal or parallel DC excited magnetic field. Inductance variations of 4:1 or greater have been obtained with this kind of device, which can be configured as a memory element by the inclusion of a permanent magnet bias. The main difficulties associated with the use of the saturable reactor are:

- Response time is slow due to excitation time constants.
- Large ferrite volumes are required to overcome the inherent nonlinearity and heat dissipation problems.

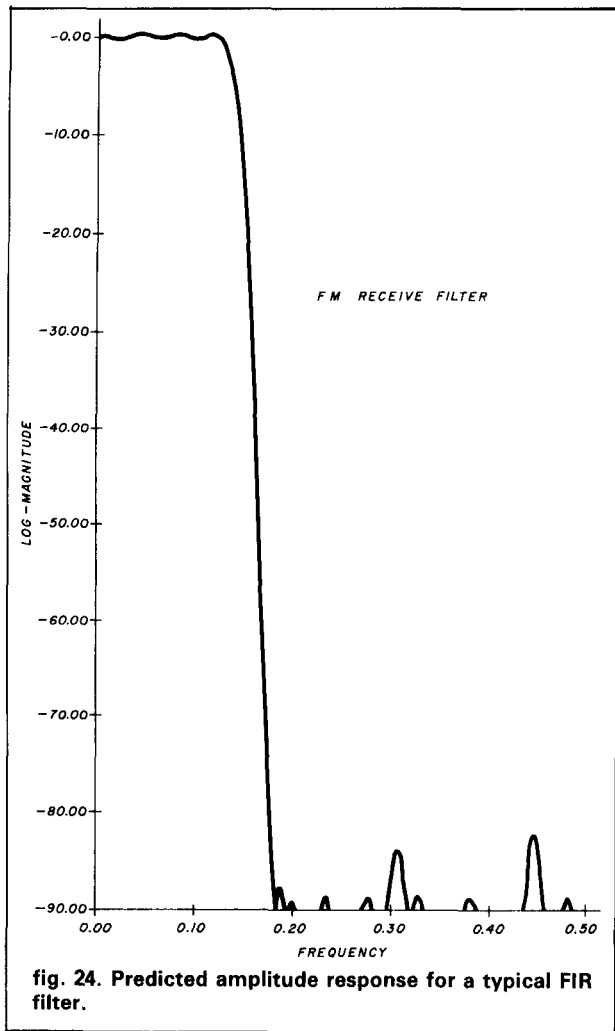

- The ferrite material is temperature-sensitive.
- Permanent (irreversible) structural changes can take place at some specific excitation levels.

The device may find application in coupler schemes where a limited degree of adaptive tuning over a narrow frequency range is desirable.

The PIN diode, a solid-state device, offers many interesting possibilities for switching if optimized for operation in the HF frequency range. The keystone of advanced HF Coupler design at RCA, its use permits reactive elements of the matching networks to be varied by switching discrete values of inductors and capacitors in a digital manner. Such a configuration is readily adaptable to a microprocessor control interface. The diode parameters most critical for this application are forward bias resistance, reverse-bias breakdown voltage, minority carrier lifetime, and power-handling capability.

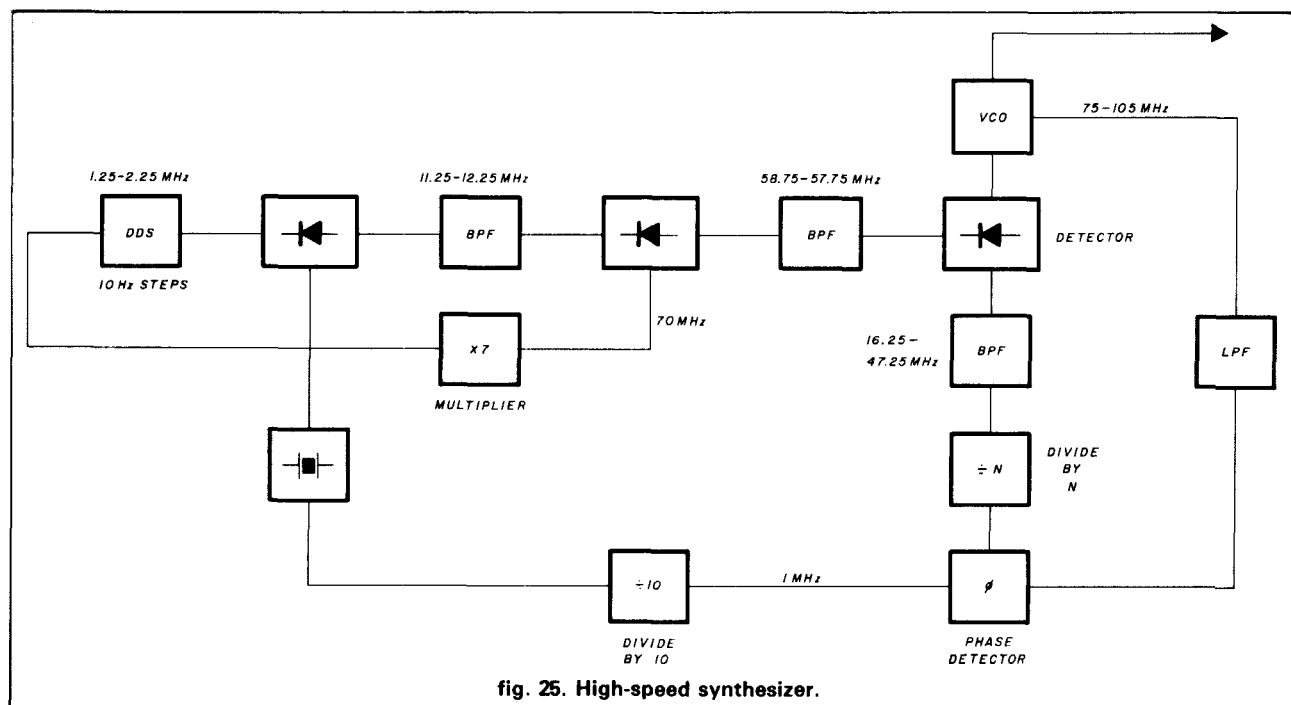

The reverse breakdown voltage of the PIN diodes in the HF frequency range must be high enough to withstand the peak RF voltages developed at the high Q end of capacitive antennas. As an example, an aircraft probe antenna with a Q of 500 at 2 MHz, when matched may develop an RF voltage at the base of 15 kV or more with 1 kW input, depending on the losses encountered in the matching network. Thus a PIN diode, or rather a PIN diode package, must be able to withstand at least half that voltage.

Agile antenna couplers using PIN diodes which quickly respond by microprocessor control can meet today's needs of high hopping rates. Frequency

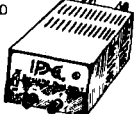

WE HAVE QUALITY PARTS. DISCOUNT PRICES AND FAST SHIPPING!

TRANSFORMERS  120 volt primaries 5.6 VOLTS @ 750 MA \$3.00 8 VOLTS @ 150 MA \$1.25 12 VCT @ 200 MA \$2.00 18 V. @ 850 MA \$3.50 18 VOLTS @ 1 AMP \$4.50 24 VOLTS @ 250 MA \$2.50 24 VCT @ 1 AMP \$4.50	LINE CORDS  TWO WIRE 6' 18ga TWO WIRE 3 FOR \$1.00 THREE WIRE 8 FOOT 18ga THREE WIRE \$2.00 EACH	MIKE CONNECTOR  5 CONDUCTOR IN-LINE PLUG AND CHASSIS MOUNT JACK. TWIST LOCK STYLE. SAME AS SWITCHCRAFT 12CL5M. \$2.50 PER SET	7 CONDUCTOR RIBBON CABLE  SPECTRA-STRIP RED MARKER STRIP. 28 GA STRANDED WIRE. \$5.00 PER ROLL (100 FT.)	REVERBERATION UNIT  \$7.50 EACH ACCUTRONICS COIL SPRING TYPE UNITS. USED IN ELECTRONIC ORGANS TO PROVIDE ACOUSTIC DELAY SOUND EFFECTS. INPUT IMPEDANCE 8 OHMS. OUTPUT IMPEDANCE 2250 OHMS. 4 1/2" x 16 1/2" x 1 1/2"
WALL TRANSFORMER  ALL ARE 115 VAC PLUG IN 4 VDC @ 70 MA \$2.00 9 VAC @ 1 AMP \$3.00 12.5 VAC @ 265 MA \$2.50 17 VAC @ 200 MA \$4.00 24 VAC @ 250 MA \$3.00	MULTI-SWITCHES 3 STATION NON-INTERLOCKING 3-2PDT SWITCHES. EACH OPERATES INDEPENDENTLY. 1 3/4" BETWEEN MOUNTING CENTERS. \$1.75 EACH 5 STATION INTERLOCKING MADE BY ALPS. 3-2PDT AND 2-6PDT SWITCHES ON FULLY INTERLOCKING ASSEMBLY. 3/4" BETWEEN MOUNTING CENTERS. \$2.50 EACH 5 STATION NON-INTERLOCKING SAME AS ABOVE, EXCEPT EACH SWITCH OPERATES INDEPENDENTLY. \$2.50 EACH	METER 0 - 15 V.D.C.  THIS 2-1/4" SQUARE METER MEASURES 0-15 VDC. \$4.50 EACH	2K 10 TURN MULTI-TURN POT SPECTROL #MOD 534-7161 \$5.00 EACH	SOUND AND VIDEO MODULATOR FOR T.I. COMPUTER  T.I. # UM1381-1. DESIGNED FOR USE WITH T.I. COMPUTERS. CAN BE USED WITH VIDEO SOURCES. BUILT-IN A/B SWITCH. CHANNEL 3 OR 4 SELECTION SWITCH. OPERATES ON 12 VDC. HOOK UP DIAGRAM INCLUDED. \$10.00 EACH
SPRING LEVER TERMINALS  TWO COLOR CODED TERMINALS ON A STURDY 2 3/4" x 3 3/4" BAKELITE PLATE. GREAT FOR SPEAKER ENCLOSURES OR POWER SUPPLIES. \$1.00 EACH 10 FOR \$9.00	35 PIN MALE USED ON "PARALLEL" DATA CABLES  \$5.50 EACH I.D.C. MALE SAME AS ABOVE.  WILL PRESS FIT ON STANDARD RIBBON CABLE. \$5.00 EACH	SUB-MINIATURE D TYPE CONNECTOR  SOLDER TYPE SUB-MINIATURE CONNECTORS USED FOR COMPUTER HOOK UPS. DB-15 PLUG \$2.75 DB-15 SOCKET \$2.40 DB-15 HOOD \$1.50 DB-25 PLUG \$2.75 DB-25 SOCKET \$3.50 DB-25 HOOD \$1.25	ROTARY SWITCH 1 POLE 6 POSITION  1 1/4" DIA x 1 1/2" HIGH 75¢ EACH 10 FOR \$6.00	48 KEY ASSEMBLY FOR T.I. COMPUTER  NEW TEXAS INSTRUMENTS KEYBOARD. UNENCODED. 48 S.P.S.T. MECHANICAL SWITCHES. TERMINATES TO 15 PIN CONNECTOR. SOLID METAL FRAME 4" x 9" \$6.50 EACH 2 FOR \$11.00
TI SWITCHING POWER SUPPLY TI # 1053214-2 COMPACT, WELL-REGULATED SWITCHING POWER SUPPLY DESIGNED TO POWER TEXAS INSTRUMENTS COMPUTER EQUIPMENT. INPUT: 14VAC-25 VAC AT 1A OUTPUT: +12VDC AT 350MA + 5VDC AT 1.2A - 5VDC AT 200MA SIZE: 4 3/4" x 4 3/4" x 1 1/4" \$5.00 EACH	"PARALLEL" PRINTER CONNECTOR  SOLDER STYLE 35 PIN MALE USED ON "PARALLEL" DATA CABLES. \$5.50 EACH I.D.C. MALE SAME AS ABOVE.  WILL PRESS FIT ON STANDARD RIBBON CABLE. \$5.00 EACH	PUSHBUTTON POWER SWITCH  DOUBLE POLE POWER SWITCH PUSH-ON, PUSH-OFF. \$1.00 EACH	SWITCHES MINI-PUSH BUTTON S.P.S.T. MOMENTARY NORMALLY OPEN 1/4" BUSHING 35¢ EACH 10 FOR \$3.25 100 FOR \$30.00 SPECIFY COLOR: RED, BLACK, WHITE, YELLOW.	EDGE CONNECTORS  ALL ARE .156" SPACING 10 PIN EDGE CONNECTOR TRW #50-10-A-20 \$2.00 EACH 22/44 TIN P.C. STYLE, NO MOUNTING EARS. \$1.50 EACH 10 FOR \$14.00 22/44 GOLD P.C. STYLE. \$2.00 EACH 10 FOR \$18.00 28/56 GOLD 28/56 GOLD PLATED CONTACTS .156 CONTACT SPACING. \$2.50 EACH 10 FOR \$22.00
FREE!	SEND FOR	NEW 1985	48 PAGE CATALOG	FREE!

13.8 VOLT REGULATED POWER SUPPLY THESE ARE SOLID STATE FULLY REGULATED 13.8 VDC POWER SUPPLIES. ALL FEATURE 100% SOLID STATE CONSTRUCTION, FUSE PROTECTION, L.E.D. POWER INDICATOR. 2 AMP CONSTANT, 4 AMP SURGE. UL LISTED \$18.00 EACH 	RELAYS SOLID STATE RELAY HEINEMANN ELECTRIC #101-5A-140-5 AMP CONTROL 3-2PDC LOAD. 140VAC 5 AMPS SIZE. 2" X 1 1/4" X 3/4" HIGH \$5.00 EACH 10 FOR \$45.00 	COMPUTER GRADE CAPACITORS  2,000 mfd. 200 VDC 13/4" DIA. x 5" HIGH \$2.00 3,600 mfd. 40 VDC 13/8" DIA. x 3 3/4" HIGH \$1.00 6,400 mfd. 60 VDC 13/8" DIA. x 4 1/4" HIGH \$2.50 31,000 mfd. 15 VDC 13/4" DIA. x 4" HIGH \$2.50 72,000 mfd. 15 VDC 2" DIA. x 4 3/8" HIGH \$3.50 185,000 mfd. 6 VDC 2 1/2" DIA. x 4 1/2" HIGH \$1.50 CLAMPS TO FIT CAPACITORS 506 66.	SLIDE & POTS  100K linear taper 2" LONG 1 5/8" TRAVEL 75¢ EACH 500K linear taper 2 7/8" LONG 1 3/4" TRAVEL 75¢ EACH DUAL 100K audio taper 3 1/2" LONG 2 1/2" TRAVEL. \$1.50 EACH CRYSTALS CASE STYLE HC33/U COLORBURST 3578,545 KC 2 MHZ \$3.50 EACH \$1.00 EACH	L.E.D.'S STANDARD JUMBO DIFFUSED RED 10 FOR \$1.50 GREEN 10 FOR \$2.00 YELLOW 10 FOR \$2.00 FLASHER LED 5 VOLT OPERATION RED JUMBO SIZE \$1.00 EACH BI POLAR LED 2 FOR \$1.70 LED HOLDERS TWO PIECE HOLDER FOR JUMBO LED 10 FOR 65¢ 200 FOR \$10.00 CLEAR CLIPLITE HOLDER MAKE LED A FANCY INDICATOR. CLEAR. 4 FOR \$1.00
DC CONVERTER  DESIGNED TO PROVIDE A STEADY ±5 VDC @ 240 MA FROM A BATTERY SUPPLY OF 3.5 TO 6.25 V. 2 1/16" X 1 1/16" X 1 1/16" HIGH. \$1.50 EACH	1N4148 SPECIAL 45" SPACING P.C. LEADS 1000 FOR \$10.00 10,000 FOR \$585.00	MINIATURE 6 VDC RELAY  SUPER SMALL SPDT RELAY; GOLD COBALT CONTACTS. RATED 1 AMP AT 30 VDC; HIGHLY SENSITIVE. TTL DIRECT DRIVE POSSIBLE. OPERATES FROM 43 TO 6 V. COIL RES. 220 OHM. 1 3/16" x 13/32" x 7/16" AROMAT # RSD-6V \$1.50 EACH 10 FOR \$13.50	MINIATURE TOGGLE SWITCHES ALL ARE RATED 5 AMPS @ 125 VAC S.P.D.T. (on-on) P.C. STYLE. NON-THREADED BUSHING. 75¢ EACH 10 FOR \$7.00 S.P.D.T. (on-off) SOLDER LUG TERMINALS \$1.00 EACH 10 FOR \$9.00 100 FOR \$80.00 S.P.D.T. (on-on) P.C. LUGS, THREADED BUSHING. \$1.00 EACH 10 FOR \$9.00 100 FOR \$80.00 D.P.D.T. (on-on) SOLDER LUG TERMINALS \$2.00 EACH 10 FOR \$19.00 100 FOR \$180.00	METAL OXIDE VARISTOR  G.E. # V82ZA12 50 VOLTS, NOMINAL D.C. VOLTAGE. 5/8" DIAMETER. 2 FOR \$1.50
TRANSISTORS 2N706 4 FOR \$1.00 2N2222A 3 FOR \$1.00 PN2222 4 FOR \$1.00 2N2904 3 FOR \$1.00 2N2905 3 FOR \$1.00 2N2907 3 FOR \$1.00	KEY ASSEMBLY 5 KEY  \$1.00 EACH CONTAINS 5 SINGLE-POLE NORMALLY OPEN SWITCHES. MEASURES 3 3/4" LONG 8 KEY  \$1.25 EACH CONTAINS 8 SINGLE-POLE NORMALLY OPEN SWITCHES. MEASURES 4 1/4" LONG.	13 VDC RELAY  CONTACT S.P.N.C. 10 AMP @ 120 VAC ENERGIZE COIL TO OPEN CONTACT... COIL: 13 VDC 650 OHM SPECIAL PRICE \$1.00 EACH	4 PDT RELAY • 14 pin style • 3 amp contacts • 24 volt d.c. or 120 volt a.c. coil • Used but fully tested \$1.70 EACH specify coil voltage LARGE QUANTITIES AVAILABLE SOCKETS FOR RELAY 504 each	3 1/2" SPEAKER  8 OHM IMPEDANCE, FULL RANGE SPEAKER. 8 OZ MAGNET. 4" DIAGONAL MOUNTING CENTERS. \$2.50 EACH 10 FOR \$20.00
POWER SUPPLY W/PRE-AMP  THIS SUPPLY WAS USED TO POWER AN 8 TRACK/CASSETTE UNIT. IT WILL SUPPLY APPROX 18 VDC AND INCLUDES A SMALL PRE-AMP TO BOOST SIGNAL LEVEL. RCA PLUGS FOR LINE IN/OUT. \$4.50 EACH	SOLID STATE BUZZER STAR #SMB-06L 6 VDC. TTL COMPATIBLE. \$1.00 EACH 10 FOR \$9.00 			

ALL ELECTRONICS CORP.

TOLL FREE ORDERS ONLY
 1-800-826-5432
 (ORDER ONLY)
 (IN CALIFORNIA 1-800-258-6666)
 ALASKA HAWAII
 OR INFORMATION
 (213) 380-8000

905 S. VERMONT AVE. P.O. BOX 20406 LOS ANGELES, CA 90006
 6228 SEPULVEDA BLVD VAN NUYS, CA 91411

QUANTITIES LIMITED
 MINIMUM ORDER \$10.00
 USA \$3.00 SHIPPING
 FOREIGN ORDERS
 INCLUDE SUFFICIENT
 SHIPPING
 CALIF RES ADD 6.12
 NO COD

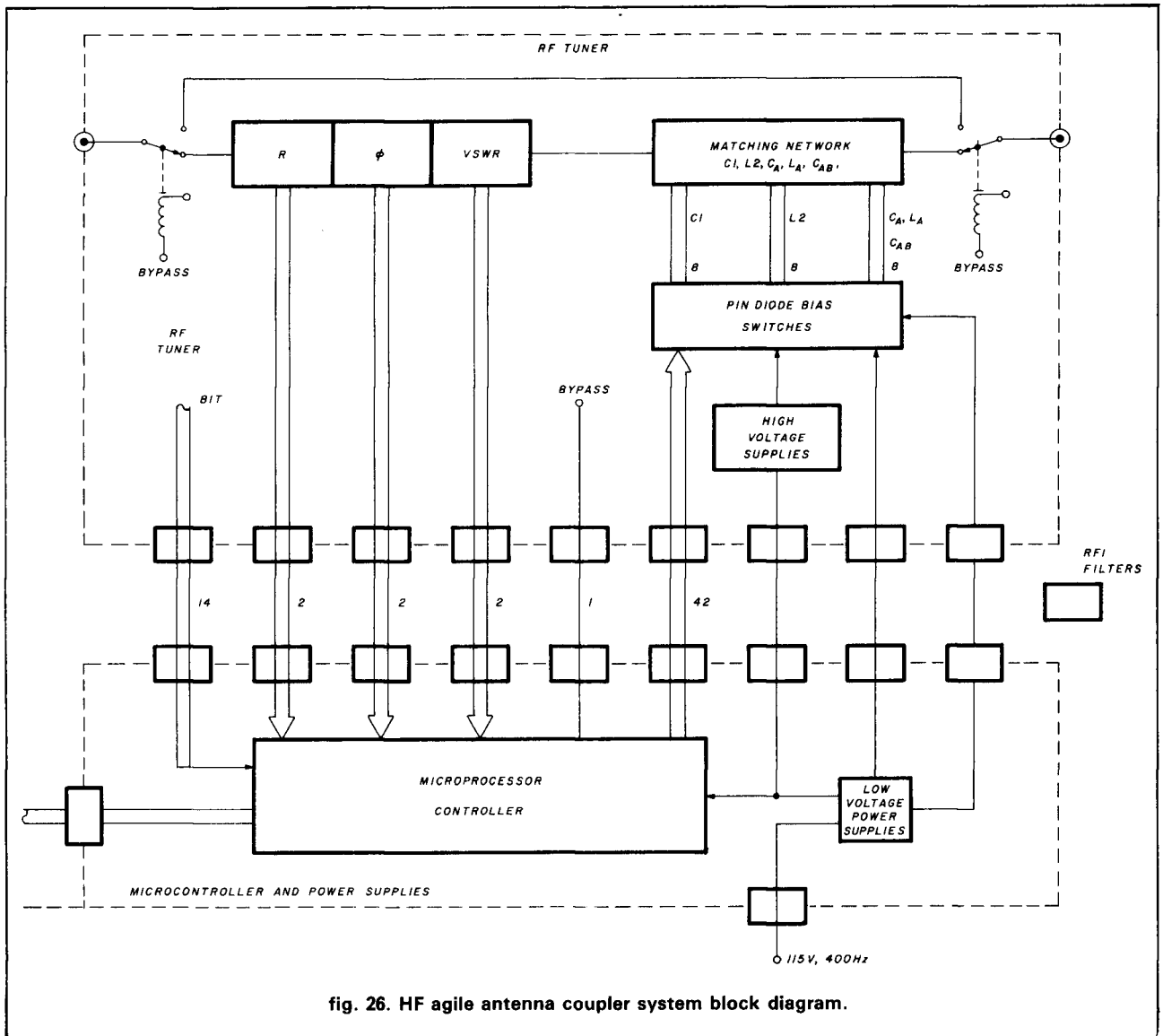

fig. 26. HF agile antenna coupler system block diagram.

changes can be made in microseconds, thus obsoleting older techniques. Advantages of agile antenna couplers with digital processing are high speed, reliability, and adaptability. Through self-test techniques and learning and storing of new antenna characteristics, the coupler can adapt to changes and continue to implement the best impedance match, resulting in good power transfer to the radiating antenna. **Figure 26** shows the system block diagram of the HF agile antenna coupler. A switching speed in the order of 200 microseconds is possible.

summary

This article describes requirements and techniques used in the design of modern digital HF radio which fulfill the needs of advanced RF communication systems. Most of the advanced techniques were developed to satisfy digital data transmission and fre-

quency hopping requirements. Digital implementation of many of the system functions, required for both hopping and non-hopping modes, avoids some of the problems analog linear devices introduce. Digital techniques may ultimately prove to be more cost effective as well. The use of microprocessing and signal processing devices provides greater flexibility of the HF transceiver and allows its use in an integrated system.

acknowledgement

Much of the work described in this article derives from the efforts of the Radio Systems' Engineering section at RCA's Government Communications Systems, Camden, New Jersey, without whose help this article could not have been completed. Among the major contributors to this article were Robert M. Lisowski, John B. McMackin, David A. Miller, Edward

CTM

The monthly magazine with a natural blending of two popular hobbies — Ham Radio and Computers

- ★ Articles on Ham Radio & Most Personal Computers
- ★ Hardware & Software Reviews
- ★ Various Computer Languages
- ★ Construction Articles
- ★ Much Much More.

"...received my moneys worth with just one issue..."

—J. Trenbick

"...always stop to read CTM, even though most other magazines I receive (and write for) only get cursory examination..."

—Fred Blechman, K6UGT

U.S.A..... \$15.00 for 1 year
 Mexico, Canada \$25.00
 Foreign \$35.00(land) - \$55.00(air)
 (U.S. funds only)
 Permanent (U.S. Subscription) \$100.00
 Sample Copy \$3.50



Circulation Manager
 1704 Sam Drive
 Birmingham, Alabama 35235
 Phone 205/854-0271

Name _____
 Call Sign _____
 Address _____
 City _____ State _____
 Zip _____ Phone _____
 Date _____
 Signature _____

123

J. Nossen, David P. O'Rourke, and Charles K. Vickers. Additional thanks go to Mr. Miller for very carefully proofing the entire manuscript and supplementing several of the more esoteric terms with examples.

bibliography

- Cook, C.E., and Marsh, H.S., "An Introduction to Spread Spectrum," IEEE, 1983.
 Cuccia, C. Louis, "Spread Spectrum Systems Serve Nearly All C² Aspects," MSN, April, 1982.
 Maksimov, M.V., Bobnew, M.P., Shustov, L.N., Krivitskiy, B.K., Gorgonov, G.I., Il'in, V.A., and Stepanov, B.M., *Radar Anti-jamming Techniques*, Artech House Books, 1979.
 Rohde, Ulrich L., *Digital PLL Frequency Synthesizers, Theory and Design*, Prentice-Hall, Inc., 1983.
 Rohde, Ulrich L., "Match Antenna Over 1.5-to-30 MHz Range with Only Two Adjustable Elements," *Electronic Design*, September 13, 1975, page 96.
 Spellman, M., "A Comparison Between Frequency Hopping and Direct Spread PN as Antijam Techniques," IEEE, 1983.
 GTE Communication Systems Division, USA CORADCOM on Contract DAAK80-80-C-0588, "Frequency Hopping Multiplexer Design Assessment," August, 1982

ham radio



Use Your Wireless Control
FROM ANY ROOM!!!

Works with most infrared remote control receivers.



LIKE HAVING A SATELLITE RECEIVER, VCR, CABLE TV, AND VIDEO DISC IN EVERY ROOM!

- Remote-control Satellite Receiver, VCR, Cable TV, and Video Disc can now be used long-distance.
- Install on any TV to access all your remote control video components.
- Makes non-remote TVs remote controllable with remote control VCR, Cable Selector, or Satellite Receiver.
- No fancy wiring needed: uses existing coaxial wiring between TVs.
- No extra controls to buy! Uses the hand-held remote controllers you already have.
- No tools required. Easily installed in minutes.

XTRALINK™

MODEL 170

XL



\$79⁹⁵

Plus \$3.00 shipping & handling

608-493-2291

DEALER INQUIRIES WELCOME.

MERRIMAC P.S.P.A.C.E.
SATELLITE

327 Palisade St. Merrimac, WI 53561

124



SAY YOU SAW IT IN *ham radio* magazine

RAMSEY

THE FIRST NAME IN ELECTRONIC TEST GEAR



20 MHz DUAL TRACE OSCILLOSCOPE

Unsurpassed quality at an unbeatable price, the Ramsey oscilloscope compares to others costing hundreds more. Features include a component testing circuit for resistor, capacitor, digital circuit and diode testing • TV video sync filter • wide bandwidth & high sensitivity • internal graticule • front panel trace rotator • Z axis • high sensitivity x-y mode • regulated power supply • built-in calibrator • rock solid triggering. *USA — add \$10.00 per unit for postage, overseas orders add 15% of total order for insured surface mail.

\$399⁹⁵*

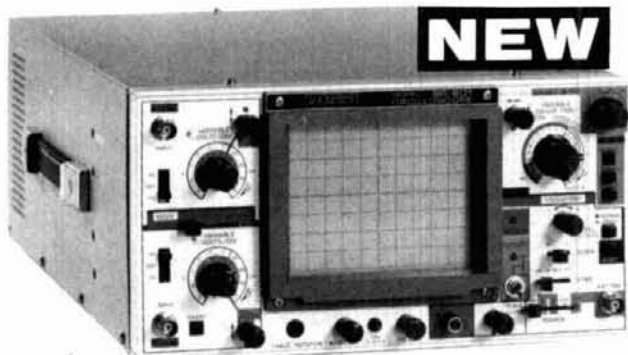

45 MHz DUAL SWEEP OSCILLOSCOPE

The Ramsey 625 is a dual time base, delayed sweep unit that includes a built-in signal delay line to permit clear viewing during very short rise times of high frequency waveforms. Other features include: variable trigger holdoff • 20 calibrated sweep time ranges from 0.5 ns/div. to 0.2 s/div. • fully adjustable sweep time • X5 sweep rate • vertical • low trigger sources, CH1, CH2, LINE, EXTERNAL and INTERNAL (V mode) • front panel x-y operation, Z axis input • sum difference of CH1 and CH2 waveforms displayed as single trace • sweep gate and sweep output • auto focus • single sweep. *USA — add \$10.00 per unit for postage, overseas orders add 15% of total order for insured surface mail.

\$799⁹⁵*



RAMSEY D-1100 VOM MULTITESTER

Compact and reliable, designed to service a wide variety of equipment. Features include • mirror back scale • double-jeweled precision moving coil • double overload protection • an ideal low cost unit for the beginner or as a spare back-up unit.

\$19⁹⁵ test leads and battery included



NEW RAMSEY 1200 VOM MULTITESTER

Check transistors, diodes and LEDs with this professional quality meter. Other features include: decibel scale • 20K volt metering system • 3 1/2" mirrored scale • polarity switch • 20 measuring ranges • safety probes • high impact plastic case.

\$24⁹⁵ test leads and battery included

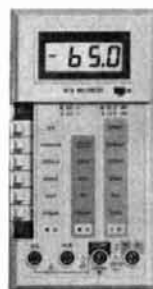

RAMSEY D-3100 DIGITAL MULTIMETER

Reliable, accurate digital measurements at an amazingly low cost • in-line color coded push buttons, speeds range selection • abs plastic tilt stand • recessed input jacks • overload protection on all ranges • 3 1/2" digit LCD display with auto zero, auto polarity & low BAT. indicator.

\$49⁹⁵ test leads and battery included



CT-70 7 DIGIT 525 MHz COUNTER

Lab quality at a breakthrough price. Features • 3 frequency ranges each with pre amp • dual selectable gate times • gate activity indicator • 50mV @ 150 MHz typical sensitivity • wide frequency range • 1 ppm accuracy.

\$119⁹⁵ wired includes AC adapter

CT-70 kit \$99.95
BP-4 nicad pack 8.95



CT-90 9 DIGIT 600 MHz COUNTER

The most versatile for less than \$300. Features 3 selectable gate times • 9 digits • gate indicator • display hold • 25mV @ 150 MHz typical sensitivity • 10 MHz timebase for WWV calibration • 1 ppm accuracy.

\$149⁹⁵ wired includes AC adapter

CT-90 kit \$129.95
OV-1 0.1 PPM oven timebase 59.95
BP-4 nicad pack 8.95



CT-125 9 DIGIT 1.2 GHz COUNTER

A 9 digit counter that will outperform units costing hundreds more. • gate indicator • 24mV @ 150 MHz typical sensitivity • 9 digit display • 1 ppm accuracy • display hold • dual inputs with preamps.

\$169⁹⁵ wired includes AC adapter

BP-4 nicad pack 8.95



CT-50 8 DIGIT 600 MHz COUNTER

A versatile lab bench counter with optional receive frequency adapter, which turns the CT-50 into a digital readout for most any receiver • 25 mV @ 150 MHz typical sensitivity • 8 digit display • 1 ppm accuracy.

\$169⁹⁵ wired

CT-50 kit \$139.95
RA-1 receiver adapter kit 14.95



DM-700 DIGITAL MULTIMETER

Professional quality at a hobbyist price. Features include 26 different ranges and 5 functions • 3 1/2" digit, 1/2" inch LED display • automatic decimal placement • automatic polarity.

\$119⁹⁵ wired includes AC adapter

DM-700 kit \$99.95
MP-1 probe set 4.95



PS-2 AUDIO MULTIPLIER

The PS-2 is handy for high resolution audio resolution measurements, multiplies LF in frequency • great for PL tone measurements • multiplies by 10 or 100 • 0.01 Hz resolution & built-in signal preamp/conditioner.

\$49⁹⁵ wired

PS-2 kit \$39.95



PR-2 COUNTER PREAMP

The PR-2 is ideal for measuring weak signals from 10 to 1,000 MHz • flat 25 db gain • BNC connectors • great for shifting RF • ideal receiver/TV preamp.

\$44⁹⁵ wired includes AC adapter

PR-2 kit \$34.95



PS-1B 600 MHz PRESCALER

Extends the range of your present counter to 600 MHz • 2 stage preamp • divide by 10 circuitry • sensitivity: 25mV @ 150 MHz • BNC connectors • drives any counter.

\$59⁹⁵ wired includes AC adapter

PS-1B kit \$49.95

ACCESSORIES FOR RAMSEY COUNTERS

Telescopic whip antenna—BNC plug \$ 8.95
High impedance probe, light loading 16.95
Low pass probe, audio use 16.95
Direct probe, general purpose use 13.95
Tilt ball, for CT-70, 90, 125 3.95



PHONE ORDERS CALL
716-586-3950

TELEX 466735 RAMSEY CI

TERMS: • satisfaction guaranteed • examine for 10 days; if not pleased, return in original form for refund • add 6% for shipping and insurance to a maximum of \$10.00 • overseas add 15% for surface mail • COD add \$2.50 (COD in USA only) • orders under \$15.00 add \$1.50 • NY residents add 7% sales tax • 90 day parts warranty on all kits • 1 year parts & labor warranty on all wired units.

RAMSEY

RAMSEY ELECTRONICS, INC.
2575 Baird Rd.
Penfield, N.Y. 14626

TOUCH TONE® CONTROL

NEVER BEFORE HAS SO MUCH CONTROL...
COST SO LITTLE!!

MODEL CS-16 \$164 Amateur net | MODEL CS-1688 \$189 Amateur net

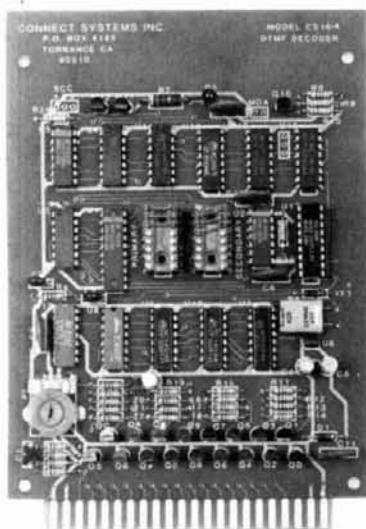

Two independent user programmable three digit passwords permit hierarchy control.

The secondary (user) password can only access 8 of the 16 latched (ON/OFF) functions.

However full 16 function control is available to control operators using the primary password. Additionally secondary password access can be enabled/disabled with a special primary password command.

Our CS-16 puts repeater control ops... IN CONTROL.

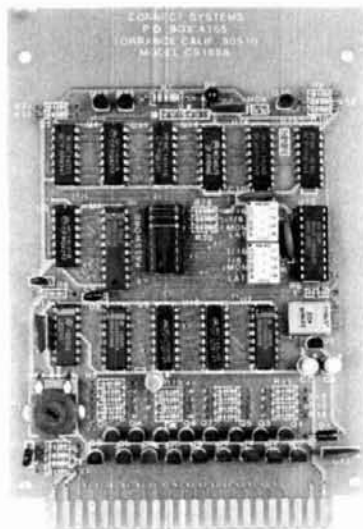

Our new CS-1688 is the most powerful touch tone controller in the industry! DIP switch programmability allows you to choose any of these ten mode/function combinations...

OUTPUT FUNCTIONS													
D	1	2	3	4	5	6	7	8	9	0	A	B	C
D-7 GROUP							8-C GROUP						
1.	8	LATCHED	and	8	MOMENTARY								
2.	8	LATCHED	and	1	OF 8	SELECT							
3.	8	MOMENTARY	and	8	LATCHED								
4.	8	MOMENTARY	and	1	OF 8	SELECT							
5.	1	OF 8	SELECT	and	8	MOMENTARY							
6.	1	OF 8	SELECT	and	1	OF 8	SELECT						
7.	1	OF 8	SELECT	and	8	LATCHED							
8.	————— 16 LATCHED —————												
9.	————— 16 MOMENTARY —————												
10.	————— 1 OF 16 SELECT —————												

COMMON FEATURES

- Open collector (can drive relays directly) and logic outputs for each of the 16 functions
- SSI-202 central office quality XTAL controlled tone decoder
- Adjustable pre-amp accommodates 10MV-2 volt input
- Retransmission of control tones can be eliminated by use of either open collector or data strobe logic outputs
- Operates from 10-25 volts DC. Reverse polarity protected
- 4 1/2" x 6 1/2" glass board with 44 pin gold plated edge connector
- Comes complete with manual and mating connector

Add \$3.00 P&H California residents add sales tax

Call or write for information on these signaling products also:

Model CS-10 DIP relay board... packages 10 DIP relays.

Model CS-100... A 19" rack mount that houses a control card and two CS-10's. All inputs and outputs available on convenient barrier strips.

TYPICAL REPEATER CONTROL APPLICATIONS

HI/LO POWER — PLICOR — TIGHT/LOOSE SQUELCH — OPEN/CLOSED SQUELCH — REPEATER ON/OFF — AUTOPATCH ON/OFF — TOLL RESTRICT ON/OFF — RINGBACK ON/OFF — LONG/SHORT HANGTIME — ANTENNA 1/ANTENNA 2 — REMOTE BASE ON/OFF — F₁/F₂ — AUX LINK ON/OFF — TONE MUTING ON/OFF — SPARE TRANSMITTER IN/OUT — ETC. ETC.

SELECTOR MODE APPLICATIONS

1 OF N FREQUENCIES — 1 OF N PHONE LINES — 1 OF N ANTENNAS — 1 OF N REPEATERS ETC.

CONNECT SYSTEMS INCORPORATED

23731 Madison St.
Torrance, CA 90505
Phone (213) 373-6803



* AT&T

1985 CALLBOOKS

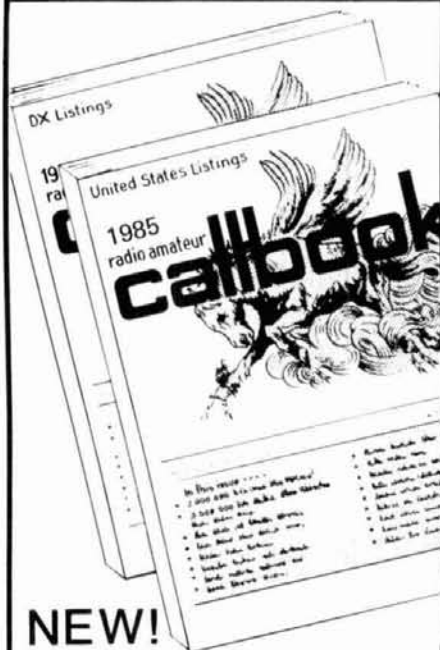

NEW! Special North American Edition

As an added bonus, the 1985 U.S. Callbook also lists the amateurs in Canada and Mexico! You get the complete and accurate U.S. listings (prepared by our own editorial staff), all the usual up-to-date Callbook charts and tables, PLUS Canada and Mexico. Now that's real value!

The best just got better!

Of course, Canadian and Mexican amateurs are also listed in the 1985 Foreign Callbook. Don't delay! The great new 1985 Callbooks were published December 1, 1984.

Order your copies now!

	Each	Shipping	Total
□ U.S. Callbook	\$21.95	\$3.05	\$25.00
□ Foreign Callbook	20.95	3.05	24.00

Order both books at the same time for \$45.00 including shipping within the USA.

Order from your dealer or directly from the publisher. Foreign residents add \$4.55 for shipping. Illinois residents add 6% sales tax.

Keep your 1985 Callbooks up to date.

The U.S. and Foreign Supplements contain all activity for the previous three months including new licenses. Available from the publisher in sets of three (March 1, June 1, and September 1) for only \$15.00 per set including shipping. Specify U.S. or Foreign Supplements when ordering. Illinois residents add 6% sales tax. Offer void after November 1, 1985.

RADIO AMATEUR **callbook** INC. 126



Dept. F
925 Sherwood Dr., Box 247
Lake Bluff, IL 60044, USA

Tel: (312) 234-6600



a carrier-operated relay for VHF amplifiers

simple switch
operates reliably
over wide
temperature range

The availability of low-cost hand-held VHF transceivers has increased the demand for external power amplifiers to overcome the inherent power limitations of these radios. In particular, many Amateurs wish to adapt their hand-held units to mobile use and take advantage of the abundance of low voltage DC power available in this application with an add-on amplifier.

Many application notes detailing the construction of such amplifiers are available.¹ A typical design appeared in past editions of the Motorola *RF Data Manual* as EB92A and is built around the MHW-252 hybrid module. The possibility of obtaining 20 dB or more of gain in a single module prompted us to build these amplifiers with the hope of developing 25 watts from the 200 mW provided by an ICOM 2A operating on low power.

The construction of these amplifiers proved to be a near-total disaster for several reasons, and we are by no means encouraging others to follow in our footsteps as far as the amplifier design is concerned. In fact, the latest edition of Motorola's *RF Data Manual* does not list the MHW-252 at all. However, one significant improvement was made in the Motorola design which will undoubtedly prove to be very useful in future power amplifier projects.

The major improvement concerns the COR circuit. In the original Motorola design, shown in fig. 1, it can be seen that a 5-pF capacitor is used to couple RF energy to a transistor that drives a mechanical relay. At 146 MHz, 5 pF represents 220 ohms of capacitive reactance. Because the transistor switch is forward

biased somewhat during reception, the 5 pF capacitive reactance is primarily the input impedance to the circuit, and thus seriously affects the receiver signal path. In addition, the transistor circuit was found to be extremely unreliable because of base-emitter threshold changes with temperature, especially bothersome in mobile operation during cold mornings. In fact, the slight variation with frequency of the power output of an IC-2A became very noticeable on some mornings, yielding operation on only part of the band.

some problems occurred

Some history of our construction experiences offers comic relief value and should therefore be expounded for completeness. We built three of these amplifiers using the suggested single-sided PC board. As described in the application note, the circuit purportedly used the lead inductance of the relay and printed circuit traces as elements of a harmonic output filter. Measured with a Bird wattmeter, each of our separately constructed units produced a whopping 17-18 watts of output power. This was about 10 watts lower than expected. After a call to the manufacturer we were certain we had erred somehow. The manufacturers' representatives verified the published performance specifications, which we were obviously not meeting. In order to rectify matters, we delved into the theory of the LPF and tried different capacitor values and types. In spite of these changes, output power remained below 20 watts even with different ICOMs, each of which provided the required 200 mW into a 50-ohm load. Suspecting some type of mismatch condition either at the input or output, we proceeded to construct new boards using 50-ohm microstrip for RF connections. Instantly, 30 watts appeared at the Bird wattmeter load upon test. We concluded that the relay lead inductance was itself not enough to mismatch the input and output circuits but that the

By Frank M. Caimi, WB3JCC, P.O. Box 650163, Vero Beach, Florida 32965, and Edward A. Richley, KD8KZ, 41 N. Highpoint Circle South, Naples, Florida 33940.

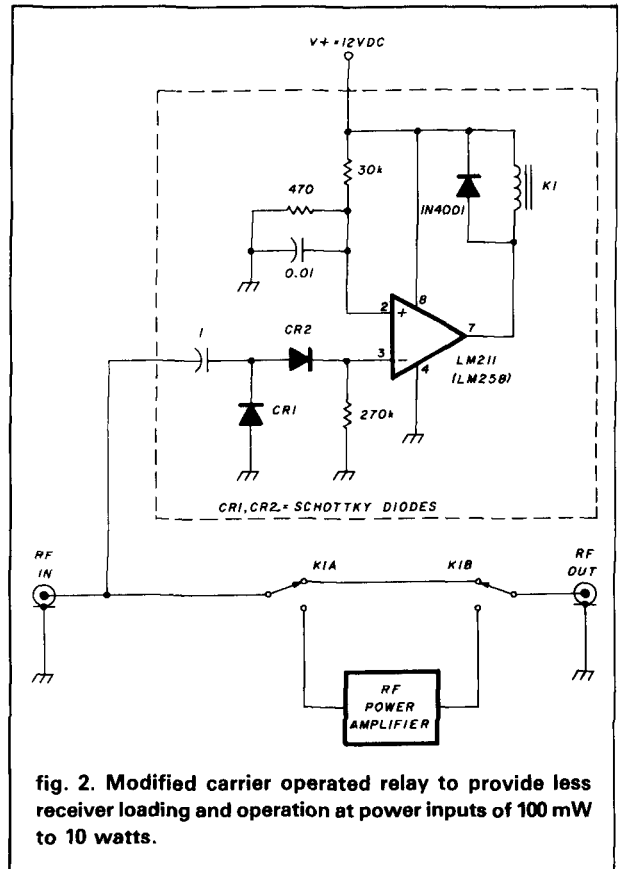
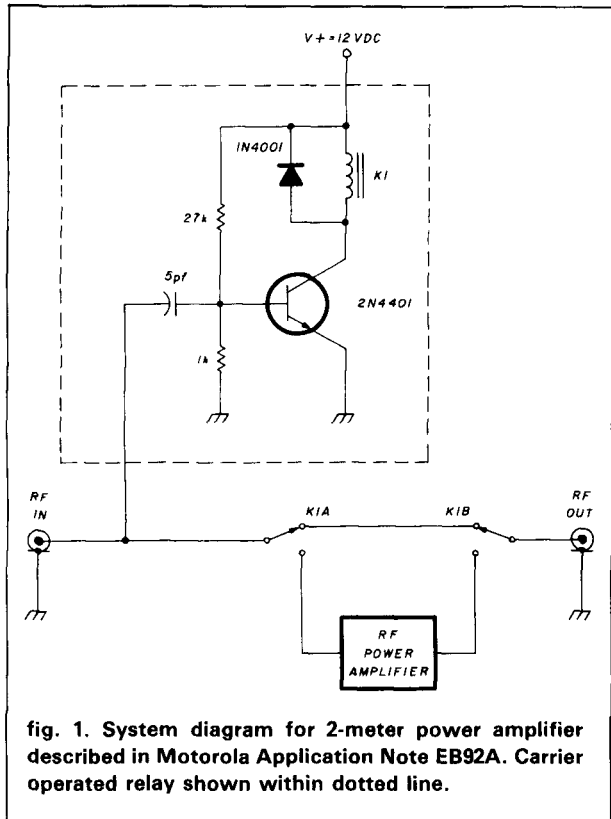

circuit traces were. The LPF was also deleted. Other harmonic filters were investigated, and although power loss was not significant, they were not used for the balance of our tests.

In addition to these problems, discussions with the manufacturer provided critical information regarding the input attenuator network. We were told that deleting the network would result in damage to either the ICOM or amplifier because of the adverse interaction between the amplifier and the ICOM resulting from improper source impedance at the ICOM output (on low power only). A 1 to 1.5 dB minimum amount of attenuation is required for the network to reduce the interaction. Fortunately we found this problem by accident before these discussions, but the ICOMs were not damaged. (Our MHW-252 modules were replaced at no charge.)

The process of changing circuit boards to the microstrip type required some work and a bit of magic which we did not possess. In the absence of magic or luck we noted that the MHW-252 leads promptly detach from the module substrate after one soldering/desoldering operation. We assumed we had defective modules, but units from different sources behaved similarly. A honed soldering iron tip and a steady hand allowed us to reattach the leads to the substrate. (We might add that because our construc-

tion and design experience is extensive, we cannot wholly be blamed for the aforementioned problems.)

While waiting to overcome some of these difficulties with the circuit, we set out to improve the COR circuit. We decided that the ideal COR circuit should have the following properties:

- as little loading of the receiver signal path as possible (1 pF at 146 MHz)
- reliable operation down to 100 mW
- simple and inexpensive
- ultra-reliable with respect to temperature

COR description

A quick calculation shows that the peak-to-peak voltage of a 100-mW RF signal on 50-ohm line is about 6 volts. This should, in a properly designed circuit, be more than sufficient to guarantee reliable operation. The trick is to make a suitably high impedance switch so as to allow a 1-pF capacitor to provide the coupling. The capacitive reactance of a 1-pF capacitor is approximately 1100 ohms, which presents little loading to the receiver even if the switch input is highly capacitive.

No problems were experienced with the configuration shown in **fig. 2**. CR1 and CR2 are inexpensive Schottky diodes configured as a voltage doubler to extract the peak-to-peak voltage of the RF signal, aside from the voltage drops of the diodes. The bias built up by the action of the diodes keeps them operating primarily in reverse bias where their capacitance is typically 1 pF. This is entirely acceptable for VHF applications and is significantly better than that of low-cost junction diodes. Furthermore, the insignificant storage time of the hot-carrier diodes makes them much more efficient as an RF level detector.

circuit description

The circuit operates as follows. Application of RF power to the input provides a rectified signal at the diode doubler as described. The input impedance of the comparator (or op-amp) and bleed-off resistor is sufficiently high to allow a significant voltage to be developed at pin 2 compared to the bias applied at pin 3 (200 mV). The comparator changes its output state from high to low at this time. Relay K1 is actuated by the near ground potential assumed at output pin 1, provided the required relay current is within the sink capabilities of the comparator output stage. Upon release of input excitation, the voltage at pin 2 decays to a value sufficiently below the bias voltage at a rate determined by circuit capacitance and the 270-kilohm resistor. Subsequently, K1 is de-energized.

The comparator chosen was an LM211 (preferable) or an LM258 (a dual device). Either can sink the 25-30 mA required to operate the OMRON relay used in the Motorola design. In addition these ICs come packaged in a TO-5 metal can package which permitted the pins to be conveniently inserted into the appropriate holes already present in our circuit boards from the Motorola design: (Incidentally the old transistor circuit was removed and tested for 60 Hz response at 120 VAC.) Although double the component count is used compared to the suggested COR circuit of **fig. 1**, the new circuit easily fits on the circuit board and has been used in other power amplifiers.

The circuit, which met all of our requirements, has been in use for several months. If anything, it is too sensitive, as nearby mobile transmitters will sometimes cause the relay to chatter furiously. We noted this effect only at the Dayton Hamfest and consider the inconvenience of minimal consequence.

references

1. *Motorola RF Data Manual*, Second edition, Motorola, Phoenix, Arizona, 1980.

ham radio

AMATEUR TELEVISION

ATV TRANSMITTER/CONVERTER

ALL YOU NEED IN ONE BOX



\$399 delivered
TC-1 plus

- **OVER 10 WATTS PEP OUTPUT.** Crystal controlled continuous duty transmitter. Specify 439.25, 434.0, 426.25 standard or other 70 cm frequency. 2 freq. option add \$26.
- **BASE, MOBILE, or PORTABLE.** Use the builtin AC supply or external 13.8 vdc. Do parades, Marathons, CAP searches, etc.
- **TWO VIDEO AND AUDIO INPUTS** for camera, TVRO, VCR, or computer. Wide bandwidth for broadcast quality color video and computer graphics. Standard broadcast subcarrier sound which is heard thru the TV speaker.
- **RECEIVE ON YOUR STANDARD TV SET** tuned to channel 3 or 4. Sensitive varicap tuned TVC-2L downconverter covers simplex and repeater freq. over the whole 420-450 MHz 70 cm amateur band.
- **ATTRACTIVE 10.5 x 3 x 9 CABINET.**

CALL OR WRITE FOR OUR CATALOG or more information on ATV antennas, transmit modules, cameras, etc. or who is on in your area. See chapter 14 1984 ARRL Handbook.

TERMS: Visa, Mastercard, or cash only UPS CODs by telephone or mail. Postal money orders and telephone orders usually shipped within 2 days. All other checks must clear before shipment. Transmitting equipment sold only to licensed amateurs, verifiable in the 1984 call book.

(818) 447-4565 m-f 8am-6pm pst.

P.C. ELECTRONICS
Tom W6ORG Maryann WB6YSS

 
2522 Paxson Lane
Arcadia CA 91006

127

coaxial R. F. antenna switches

Heavy Duty switch for true
1 Kw POWER - 2 Kw P.E.P.



Single Pole, 3 Position.

Desk or wall mount
All unused positions grounded

593 - UHF connectors / \$27.25*

596 - BNC connectors / \$36.50*

2 Pole, 2 Position, bypasses,
linears, reflectometers, antenna
tuners, etc.

#594 - UHF connectors / \$34.25*

Single Pole, 5 Position, all unused
positions grounded.

#595 - UHF connectors / \$32.00*

#597 - BNC connectors / \$46.50*

* Shipping and handling for any
item add \$2 each.

ALL OUR PRODUCTS MADE IN USA



BARKER & WILLIAMSON

Quality Communication Products Since 1932

At your Distributors write or call
10 Canal Street, Bristol PA 19007

(215) 788-5581



Telecommunications & Electronics Specialists

CIA... where a career in

COMMUNICATIONS

The environment in which you work can mean a lot to your professional success. It should be intellectually stimulating and vital, in an organization where you can assume as much responsibility as you need to challenge your talents. If this is the type of environment you seek, here is your opportunity to use your telecommunications and electronics experience in projects of national importance.

At the Central Intelligence Agency, we recognize that your experience and training are valuable assets... skills that will ensure the success of our mission and your career. When you join us, you will be a part of a select group of professional men and women who apply their talents in a variety of assignments around the world.

We have positions available for the following highly skilled, highly motivated people:

TELECOMMUNICATIONS SPECIALISTS

You should have recent experience as a telecommunications specialist, communicator, Morse intercept operator, radio or commcenter specialist. Additionally, a minimum touch typing speed of 30 wpm is required. Morse code ability at 12 GPM send/receive is preferred, but individuals with Morse aptitude will be considered. Starting salaries range from \$15,937 to \$18,851, depending on skills and qualifications.

COMSEC/TEMPEST ENGINEERS AND TECHNICIANS

Engineers must have a BSEE/BSET or equivalent training and experience; technicians must have an AAS degree or equivalent. Familiarity with COMSEC standards and TEMPEST testing in accordance with NACSIM 5100A is also required. Starting salaries range from \$20,965 to \$25,398 and up, depending on experience and qualifications.

COMMUNICATIONS OFFICER — SECURITY

You should have a BS degree in Physics, Mathematics, Computer Science, Engineering or the physical sciences. Familiarity with communications security standards, cryptography, transmission security, and computer security aspects of communications processors desired. Starting salaries range from \$17,138 to \$25,366, depending on experience and qualifications.

COMMUNICATIONS SYSTEMS ENGINEERS

You should have a BSEE/CS degree (MS desired). Additionally, experience in packet switching, message switching, data communications, local area networks, HF radio, VHF/UHF/microwave transmission, satellite communications, computer systems networking, microprocessor applications, COMSEC/TEMPEST, or project management desired. Salaries from the mid-20s and up, depending on experience and qualifications.

speaks for itself

ENGINEERING SPECIALISTS (UTILITIES)

You should have at least 2 years training in electrical power distribution systems, generators, and diesel engine maintenance from a trade school or college (or equivalent military background). Additional experience in heating, ventilation, and air conditioning systems, and machine shop practices and welding is preferred. Starting salaries range from \$17,138 to \$20,965, depending on qualifications.

COMPUTER SYSTEMS ANALYSTS/PROGRAMMERS

Positions are available at many levels for people with BS/MS degrees in Computer Science, preferably emphasizing operating systems and hardware. One to three years experience is desirable, but not necessary for new graduates (or equivalent). Higher level positions require 2-10 years experience in systems software design, development and maintenance; communications software, networking, protocols and/or message switching; and PDP-11, VAX or microprocessors desired. Starting salaries range from \$17,138 to \$36,152, depending on education and experience.

ELECTRONICS TECHNICIANS

You should have an AAS degree in electronic technology or equivalent military/commercial training and experience. Knowledge of RF theory/circuitry, solid state, and applications is also required. Starting salaries are \$17,138 to \$20,965, depending on skills and qualifications.

In addition to these requirements, you must be a U.S. citizen (both self and dependents); meet strict security and medical standards; be at least 18 years old; and be willing to work overseas.

Attention Military Personnel: Apply now if you are scheduled for separation within the next six months.

Your contributions in these positions will be rewarded with excellent career growth potential and substantial benefits. You also will be rewarded with the satisfaction that comes from providing unique and vital contributions to our nation's security.

See our representative at:

Dayton Hamvention
April 26, 27, 28
Hara Arena & Exhibition Center
Dayton, Ohio

If you cannot attend, please send your resume to:

Recruitment Activity Officer
Dept. S, Rm. 4N20 (E02)
P.O. Box 1925
Washington, D.C. 20013



Central Intelligence Agency

The CIA is an equal opportunity employer.

VECTOR SLOPER-5 . . . SUPER ANTENNA

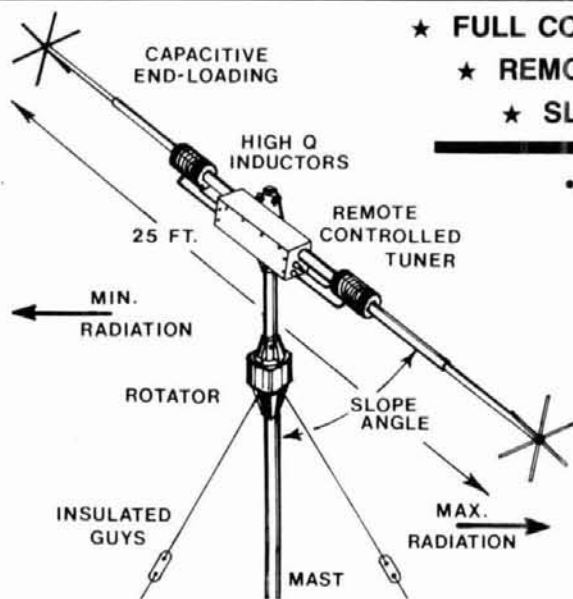

THIS POWERFUL AND VERSATILE NEW DESIGN WILL OUT PERFORM MOST HORIZONTAL, "INVERTED-V", AND VERTICAL ANTENNAS.

(73, Herb Johnson, W6QKI, Founder of Swan & Atlas)

- ★ FULL COVERAGE OF 80, 75, 40, 30, & 20 METERS
- ★ REMOTE CONTROLLED, TUNEABLE, & ROTATABLE
- ★ SLOPING DIPOLE, ONLY 25 FT. LONG

- Provides Directivity, Gain, and Front-To-Back Ratio.
- Low Angle Forward Lobe For DX, High Angle For Short Distances.
- Adjustable Slope Angle, May Be Motorized.
- Ground Independent, *No Radials*.
- High Efficiency, Capacitive End Loading, High Q Inductive Loading.
- VSWR Less Than 1.5 To 1 At all Band Edges.
- 300 Watt Power Rating, CW/PEP.
- Fingertip Control Of Resonance and Impedance Match From The Hamshack.

Deluxe Control Console
Includes R.F. Bridge
and Dummy Load



✓ 129

Suggested List Price:

With Standard Control\$420

With Deluxe Control\$460

(Does not include cable, mast, or rotator)

Write For Complete Info
or Contact Your
Vector Dealer.



VECTOR RADIO CO.

P.O. BOX 1166 CARDIFF, CA
(619) 944-1063 92007

From Texas Instruments UNDERSTANDING SERIES™

For those who want to learn easily and quickly about today's fast paced world of electronics.

Understanding Microprocessors

By Don L. Cannon and Gerald Luecke

How microprocessors work and what they can do is something that you need to know. This text starts with an overview of the world of digital electronics and covers the basic concepts of microprocessor systems, how digital ICs provide systems functions, fundamentals of microprocessors, system application with SAM (simplified architecture microprocessor), programming basics and 8 and 16 bit microprocessor applications. Written in an easy-to-read style with plenty of "hands on" projects. © 1984 Second Edition 288 pages.

□ TI-MP Softbound \$14.95

Understanding Data Communications (includes Packet Information)

By G. Friend, J.L. Fike, H.C. Baker and J.C. Bellamy

This book covers the basic concepts of data transmission and reception, asynchronous and synchronous protocols, error control and networking data communications systems. Data terminals are fully discussed as are message and transmission terminals, both synchronous and asynchronous modems and interfaces, fiber optics and satellite communications systems. Packet Networks are covered with information on X.25 switching architecture. You also get the recommended X Series standards. A wealth of information. © 1984 1st edition 272 pages.

□ TI-UDC Softbound \$14.95

Understanding Communications Systems

By Don L. Cannon and Gerald Luecke

Here's a book that will answer just about any question you have ever had about communications systems. Written in a tutorial style, this book covers basic communications concepts, conversion functions, system techniques, applications and more in 10 complete easy-to-read chapters. The following transmission methods are discussed: AM, FM, PCM, PDM, TDM, TV and Facsimile. Satellite systems are covered in detail. Great text for newcomers to Ham Radio. © 1984 2nd edition 288 pages.

□ TI-UCS Softbound \$14.95

Understanding Digital Troubleshooting

By Don L. Cannon

This book has been written to explain the mysteries of repairing digital electronic circuits. Starting with fundamentals like binary/hexadecimal conversions and Ohm's Law, this text progresses thru the most esoteric aspects of digital repair in a logical step-by-step manner. The chapter on troubleshooting fundamentals starts with a review of the most common problems that will be encountered such as opens and shorts and concludes with signal tracing techniques. You also get a full explanation of how to use logic probes and clips. 2nd Edition © 1984 272 pages.

□ TI-UDT Softbound \$14.95

Please add \$3.50 for shipping and handling
Prices US Funds Only

ham radio magazine BOOKSTORE

Greenville, NH 03048

(603) 878-1441



Free Antenna Accessories Catalog



◀ Coaxial Antenna Relays

Remotely select up to 9 antennas from your transmitter, using only *one* coaxial cable. Environmentalized, high power and low loss.

W2AU and W2DU Baluns▶

Our baluns, center insulators and inductors have been preferred for 20 years by Hams, industry, and the armed forces. Protect against TVI and lightning 1.8-200 MHz.



◀ W2VS Antenna Traps

Add these traps to your dipole and get low SWR on 2 to 6 bands, depending on how many you add. Antenna wire and custom kits also available.

Send For Yours Today▶

Don't delay. Call or write today, and we will send you free literature which fully describes our Ham antenna accessory product line.

Dealer inquiries also welcome.



UNADILLA/REYCO/INLINE
A Division of Microwave Filter Co., Inc.

6743 Kinne St., East Syracuse, NY 13057
Toll Free 1-800-448-1666 TWX 710-541-0493
NY/HI/AK/Canada (Collect) 315-437-3953

✓ 130

a PSK telemetry demodulator for OSCAR 10

Get more out of OSCAR
with this original design

OSCAR-10, launched by Ariane rocket on June 16, 1983, is the latest transponding satellite for Radio Amateurs. Its period is just under 12 hours and its orbit very elliptical ($\epsilon = 0.6$); this makes it appear quasi-stationary. Much of the time its range exceeds 21,750 miles (35,000 km), which means nearly a hemisphere is within its view, and for many hours on end. The satellite enables Amateurs with modest equipment to communicate at some time or other with stations almost anywhere on earth.¹

OSCAR-10 (fig. 1) carries two linear transponders, at UHF and in L-band. Mode B accepts 70cm uplink signals and has a 2-meter downlink; mode L is 23cm up and 70cm down.

Associated with each mode are two alternative telemetry transmissions: from a general beacon (GB) or an engineering beacon (EB). Of these, the 145.810 MHz general beacon is used predominantly, and will be a familiar sound to most users of the 2-meter

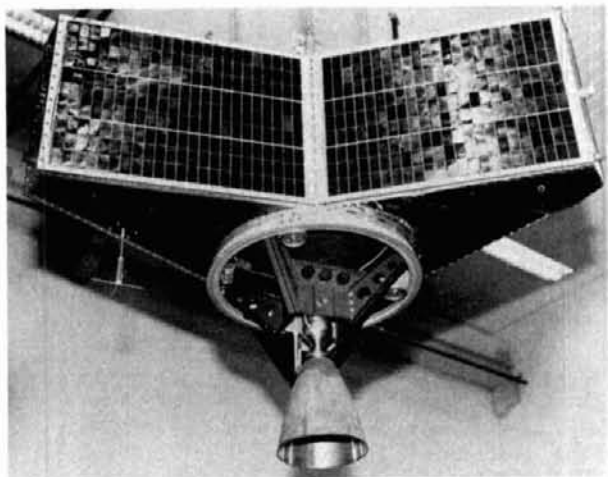

fig. 1. OSCAR 10 (courtesy AMSAT).

Amateur band. The other frequencies are 145.987 MHz (EB), 436.04 MHz (GB) and 436.02 MHz (EB).

Transmissions are continuous: on the hour and half-hour UTC there is a 5-minute Morse code bulletin, followed by 20 minutes of phase shift keying (PSK) telemetry. There are two periods of 50 baud RTTY, 5 minutes each on the odd quarter hours.

Telemetry from OSCAR-10 is transmitted in 512-byte blocks, preceded by a four-byte synchronization code (hex 39 15 ED 30) and followed by a two-byte cyclic redundancy check and then a run of about 100-200 padding bytes (hex 50). A byte consists of 8 bits and is transmitted serially, most significant bit first, at a rate of 400 bit/s. So a new block is sent every 12-14 seconds and lasts for 10.3 seconds. The interval before the next block can be used for computer processing of the telemetry.

There are several different kinds of blocks; **Q**, **Y**, and text blocks **K**, **L**, **M**, **N**, are the most common. Their first two characters are always an ASCII identifier, for example **M** <space>. Line feed and carriage return are in general not used.

K, **L**, **M**, and **N** Blocks are plaintext messages, comprising eight lines of 64 ASCII characters. They are at present used for routine communications between command stations.

Y Blocks are entirely ASCII telemetry (fig. 2). The first line contains the time (UTC) and AMSAT day number (0 = January 1, 1978). Lines 2 and 3 are command and control status information. Lines 5-8 are 64 selected telemetry values that may be converted using the equations published in the OSCAR-10 operating manual.²

As an example, columns 3, 7, 11, and 15 represent temperatures, which decode as $T = (N-127)/1.82$. The first entries in columns 3 and 7 are the mode B transponder receiver and transmitter temperatures, 16°C and 32°C, respectively.

With the exception of the letter **Q**, **Q** Blocks begin like Y blocks, but lines 5 to 8 contain the full suite of 256 hexadecimal telemetry bytes.²

By James Miller, G3RUH, 3 Benny's Way,
Coton, Cambridge, CB3 7PS, England

The schedule of transmissions interleaves ASCII blocks and Q blocks. It repeats approximately every 2¼ minutes.

modulation

The digital information stream at 400 bit/s (called the message) is first differentially encoded such that a 1 is represented by a change in the output data stream (i.e. 01 or 10) while a 0 is denoted by no change (00 or 11). This data is next exclusive-ored with a 400Hz clock, low-pass filtered to restrict its bandwidth (third order Bessel, 560 Hz) and then balance modulated on to the transmitter carrier (fig. 3). This modulation is called antipodal phase-shift keying (PSK). Carrier phase is either 0° or 180° according to the data. Because of the low pass filtering there is also some amplitude modulation at bit or clock transitions.

The signal spectrum for random data is shown in fig. 4. Note the absence (on average) of a carrier or other line components; these would waste transmitter power.

In the following sections, note the distinction between "message" and "data." The data is the stream which represents the message. Let us use the following notation:

M(n)	n th bit of the original message
D(n)	n th bit of the data, derived from message
S, S(t)	transmitted signal
A(t)	signal amplitude
CLK	the 400 Hz data clock
CAR	carrier
⊕	means EXOR; (A⊕A = 0, 0⊕1 = 1 etc.)
±A	means "either A or its inverse"

It is useful to remember that if we associate the numeric value +1 to logic 1, and the value -1 to logic 0, then the EXOR operation is equivalent to multiplication, that is: A EXOR B = A × B.

Some features of this modulation scheme that facilitate the demodulation process are the following:

- The signal can be described as $S(t) = A(t) \sin(\omega t)$
- Ignoring amplitude modulation, the signal can also be thought of as the EXOR of data, clock, and carrier: $S = D(n) \oplus \text{CLK} \oplus \text{CAR}$
- The message stream is related to the data stream by $M(n) = D(n) \oplus D(n-1)$
- Differential message encoding is used to enable a decoder to deal with the unavoidable 180° phase ambiguity in recovered carrier
- All data bits have a mid-bit transition, but not always a transition between bits

demodulation

Essentially this reverses the modulation operations.

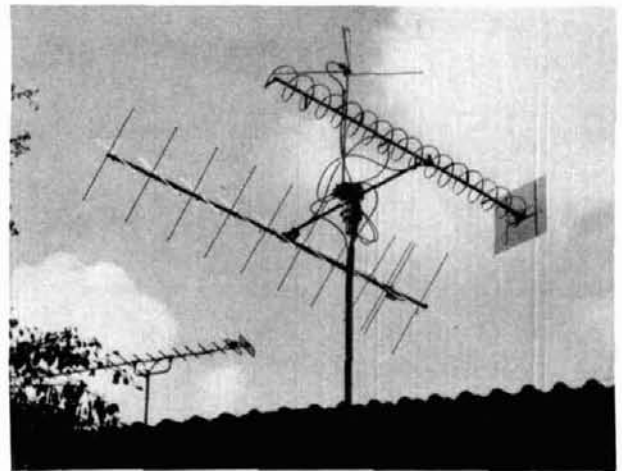

Author's helix and cross-Yagi antennas.

The receiver will be set to CW or SSB mode so that the carrier is translated down to audio frequency for input to the decoder (fig. 5).

The signal carries negligible information in its amplitude variations, so it may first be limited, which has the great advantage that all subsequent processing can be digital.

First a carrier and clock (denoted by CARR and CLKR) are recovered from the signal (S) and then EXORed with the signal, giving a product (P):

$$P = S \oplus [\text{CARR} \oplus \text{CLKR}]$$

Provided the local carrier and clock are (excepting possible inversion) replicas of the originals, i.e. $\text{CARR} = \pm \text{CAR}$ and $\text{CLKR} = \pm \text{CLK}$, this product simplifies to:

$$P = [D(n) \oplus \text{CLK} \oplus \text{CAR}] \oplus [\pm \text{CARR} \oplus \pm \text{CLKR}] = \pm D(n)$$

which is the original data. If the signal were noise-free, the data $D(n)$ would be perfectly usable at this point. Noise, however, perforates the bits so mod-bit sampling would lead to random errors. Instead, $D(n)$ is integrated over the bit interval and the resulting accumulation sampled at its end, a process called integrate-and-dump. The system as a whole is a matched filter.⁴

Note that in order to clock the data and time the integration properly, a means must be provided to resolve the CLKR 180° phase ambiguity. (The information to do this is implicit in the signal.)

The message $M(n)$ is next found from $\pm D(n)$ by differential decoding. The present data bit is EXORed with the previous data bit. The possible inversion of $D(n)$ is of no consequence, for $-D(n) \oplus -D(n-1)$ and $D(n) \oplus D(n-1)$ are both the same.

The message stream is now available for processing, by either hardware and/or software.

**KENWOOD
SPECIAL
R-11
Receiver
\$79.95**
Cash Price
& Shipping

TEL-COM★ Electronic Communications

Authorized Dealers For

KENWOOD & ICOM

Also displaying the popular accessories needed to complete a HAM STATION . . .

ARRL PUBLICATIONS • AEA PRODUCTS • AMPHENOL
• ALPHA DELTA • ASTRON • AUSTIN ANTENNAS • AVANTI
• BELDEN • BENCHER • B & W • DAIWA • HAM-KEY
• HUSTLER • KLM • LARSEN • MIRAGE • ROHN
• TELEX/HY-GAIN • VIBROPLEX • WELZ • ETC.

**SPECIAL
KENWOOD
TR 2600 A**

With extra PB-26
Battery

\$319.00

Shipping extra

OPEN SIX DAYS A WEEK

✓ 131

Telephone 617/486-3400, 3040

675 Great Rd., (Rte. 119) Littleton, MA 01460

1¼ miles from Rte. 495 (Exit 31) toward Groton, Mass.

DESIGN EVOLUTION IN RF P.A.'s



Now with
**GaAs FET
Preamp**

- Linear (all mode) RF power amp with automatic T/R switching (adjustable delay). Amplifier useable with drive powers as low as ½ watt.
- Receive preamp option, featuring GaAs FETS (lowest noise figure, better IMD). Device NF typically .5 dB.
- Thermal shutdown protection incorporated
- Remote control capability built-in
- Rugged components and construction provide for superior product quality and performance
- All models include a complete operating/service manual and carry a factory warranty on all components
- Designed to ICAS ratings, meets FCC part 97 regulations
- Approximate size is 2.8 x 5.8 x 10.5" and weight is 5 lbs.

Specifications/price subject to change

MODEL	FREQUENCY 2 (MHz)	OUTPUT POWER (W)	INPUT POWER (W)	NF	PRE-AMP GAIN
0508	50-54	170	1	-	-
0508G	50-54	170	1	6	15
0510	50-54	170	10	-	-
0510G	50-54	170	10	6	15
1410	144-148	160	10	-	-
1410G	144-148	160	10	6	15
1412	144-148	160	30	-	-
1412G	144-148	160	30	6	15
2210	220-225	130	10	-	-
2210G	220-225	130	10	7	12
2212	220-225	130	30	-	-
2212G	220-225	130	30	7	12
4410	420-450 ¹	100	10	-	-
4410G	420-450 ¹	100	10	1.1	12
4412	420-450 ¹	100	30	-	-
4412G	420-450 ¹	100	30	1.1	12

1. Models with G suffix have GaAs FET preamps. Non-G suffix units have no preamp.
2. Covers full amateur band. Specify 10 MHz Bandwidth for 420-450 MHz Amplifier.

★SEND FOR FURTHER INFORMATION★

**TE
SYSTEMS**

TE SYSTEMS
P.O. Box 25845
Los Angeles, CA 90025
(213) 478-0591

GEM-QUAD FIBRE-GLASS ANTENNA FOR 10, 15, and 20 METERS

Two Elements \$235.00
Extra Elements \$164.00
Price is F.O.B. Transcona
**INCLUDES U.S. Customs
Duty**

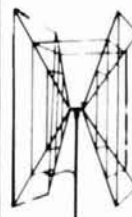

KIT COMPLETE WITH
*SPIDER
*ARMS
*WIRE
*BALUN KIT
*BOOM WHERE
NEEDED

WINNER OF MANITOBA
DESIGN INSTITUTE
AWARD OF EXCELLENCE

Buy two elements now — a third and fourth may be added later with little effort.

Enjoy up to 8 db forward gain on DX, with a 25 db back to front ratio and excellent side discrimination.

Ask for our new 2m Quad Kit when you order your Gem Quad. It's FREE for the asking!

Get maximum structural strength with low weight, using our "Tridetic" arms. Please inquire directly to:

GEM QUAD PRODUCTS LTD.

Box 53
Transcona Manitoba
Canada R2C 2Z5
Tel. (204) 866-3338

A truly optimum matched filter would take account of the sinusoidal nature of the signal and its amplitude modulation. The hardware required to do this involves deconvolution and is not trivial. The penalty for using a limiter and binary processing is less than 2dB, which in actual on-the-air practice is insignificant.

decoder operation

The receiver should be set to the SSB mode; the normal 2.4 kHz bandwidth is more than adequate, and can with advantage be reduced to around 1 kHz before decoding loss becomes apparent. Because of the decoder's limiter, unnecessarily wide bandwidths reduce performance.

If the signal is tuned in at the middle of the receiver's passband, then the carrier frequency will typically be 1500 Hz. The actual frequency is not important, but there is a lower limit caused by the onset of aliasing, when the lower sideband folds around 0 Hz and into itself. This sets in at a carrier frequency of about 500 Hz. The upper limit is set only by the performance of the logic family; if TTL were used, the carrier could well be at 455 kHz — i.e., at an intermediate frequency.

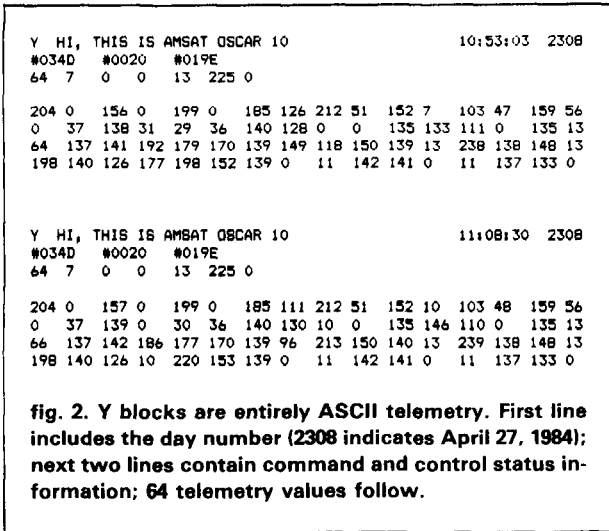

fig. 2. Y blocks are entirely ASCII telemetry. First line includes the day number (2308 indicates April 27, 1984); next two lines contain command and control status information; 64 telemetry values follow.

carrier recovery (fig. 6)

A phase locked loop (PLL) cannot be used to extract the carrier directly because there is no carrier line component in the spectrum of an $A(t) \sin(\omega t)$ signal where $A(t) = \text{random data}$.

However if the signal is subjected to a nonlinear

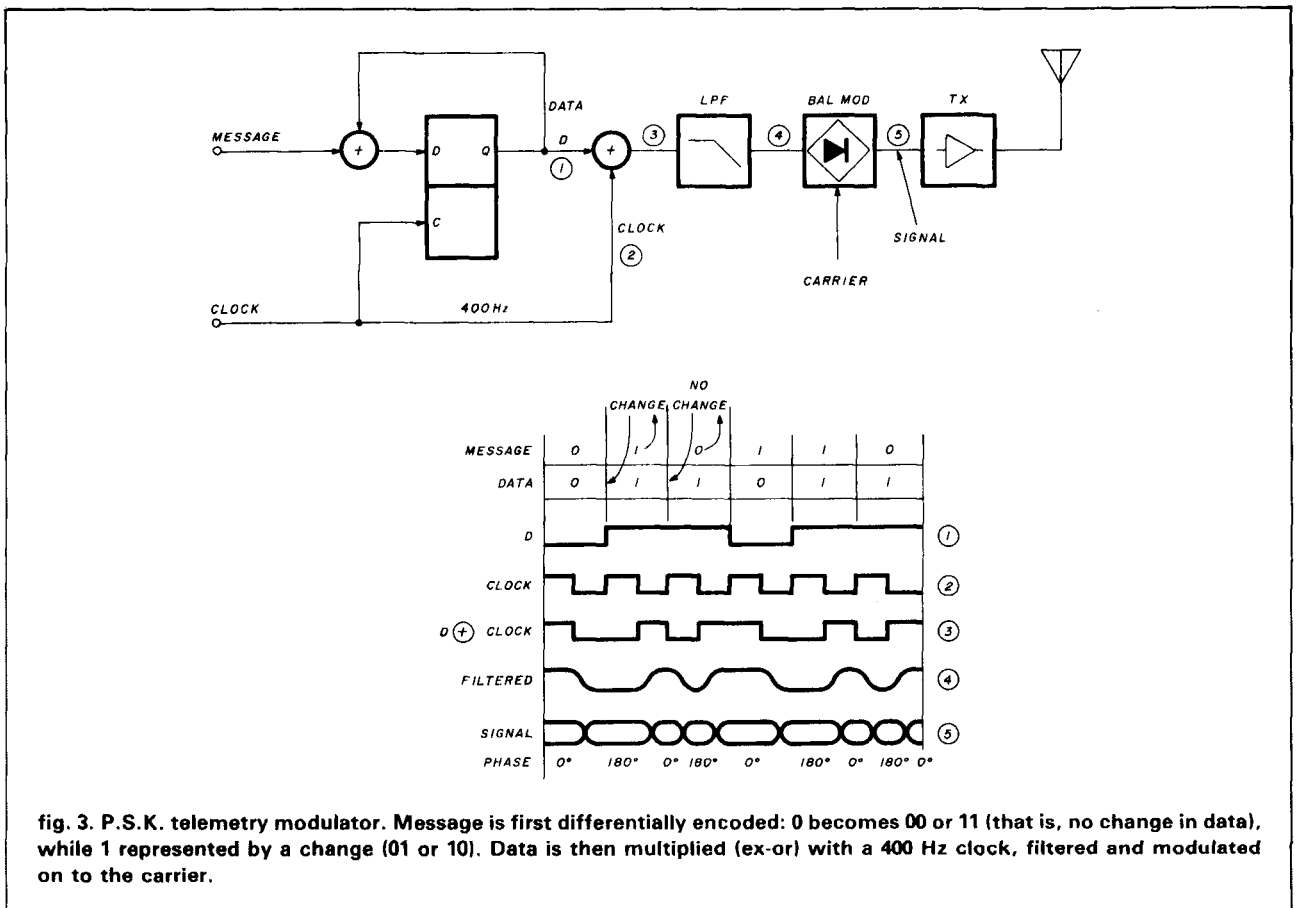

fig. 3. P.S.K. telemetry modulator. Message is first differentially encoded: 0 becomes 00 or 11 (that is, no change in data), while 1 represented by a change (01 or 10). Data is then multiplied (ex-or) with a 400 Hz clock, filtered and modulated on to the carrier.

process such as self-multiplication, the \pm is eliminated, and a line component at 2ω is generated. A simple digital way of achieving this is to EXOR the signal with itself delayed by a quarter-cycle. Every zero-crossing of the carrier creates one new cycle of twice the carrier frequency, which can be regenerated with a phase locked loop and followed by a divide-by-two circuit. This division does, however, result in the 180° phase uncertainty previously noted.

The carrier PLL must accommodate receiver frequency instability, noise and changing doppler shift (-250 Hz/hour at 145 MHz, USB. If the loop bandwidth is too small the PLL is difficult to tune in initially, has only a small tracking range, and is generally fussy. If it is wide, with little noise, the loop will hold lock over a wide tuning range, but it will constantly lose lock on noisier signals. So a fixed loop bandwidth will not suit every situation. A few experiments will show what is wanted in practice: the value will lie between 10 and 100 Hz.

clock recovery

This is accomplished in exactly the same way as carrier recovery, by multiplying the data by itself delayed by a quarter-bit. This generates an 800 Hz proto-clock, which is regenerated with PLL and then divided by two. Since the clock frequency is constant, the loop bandwidth can be 1 Hz, even with cassette tape signals. As with the carrier loop, the clock at this stage also has a 180° phase ambiguity.

clock ambiguity resolution (fig. 7)

As long as there are 01 's and 10 's in the data, which means that the inter-bit transitions will be absent, a second proto-clock of 400 Hz can be generated by EXORing the data with itself delayed by half a bit. Although somewhat sparse (trace 3) this extra clock has the virtues of correct phase, and coherence with the ambiguous clock.

If these two are now EXORed together, the smoothed result is a net high or low. This signal can then be used to invert (or not invert) the ambiguous clock to the correct sense.

In fact the second 400 Hz proto-clock could be used to excite a PLL. However, with the signals encountered in practice, the effective loop gain and bandwidth are caused to vary constantly, which makes the loop rather fragile — though it does work.

A particular feature of the clock and carrier recovery circuits is their aperiodic, digital design, involving no tuned circuits. So their operating frequency can be modified simply by changing the VCO center frequency.

block sync detection

Hex $30, 15, ED, 30$ is the pseudo-random sequence

generated by the first stage of a five stage shift register having its middle and last outputs EXNORed and fed back to its input, starting off all all 0 s.

Using such a feedback shift register, 100% sync detection can be effected by comparing the message stream bit serially with the output of the first stage. If there is a disagreement, the shift register is reset to zero; otherwise it is clock on. If the full sequence is successfully checked the register will reach its last state, which can be detected with a five-bit AND gate and used to set a start-of-block flag. The flag then inhibits the shift register.

byte counting

The block flag releases a byte-block counter. Every eighth count signals that a byte is available, and when the counter reaches 4096 (8×512), the block flag is cleared and sync code testing resumes.

outputs

Parallel data output is buffered to TTL level, and consists of an eight-bit byte, positive-going mid-bit strobe, and the block flag. These are brought out to a 20-way PCB connector. Pin-out is compatible with the BBC Acorn microcomputer 6522 user port, which will also provide a $5V$ supply for the output buffers.

The serializer gives an RS232-type output at 5 volts, 1200 baud, with one start, eight data and many stop bits (50 characters per second). This could be used to drive a printer directly, but the hexadecimal, non ASCII Q blocks will cause unpredictable results — weird characters and reams of waste paper! Using a VDU (video display unit) or the serial port of a computer is tidier.

circuit notes

The complete circuit diagram is shown in fig. 8. A printed circuit board is available.^{2,5} All other parts may be obtained from Bob Wilson at Radio Kit (Box 411, Greenville, New Hampshire 03048).

A half V_{DD} bias is incorporated to 'float' the op-amps. The $12V$ supply is not especially critical.

There is no channel filter built into the design because the receiver provides one. The simple limiter U1A* will be effective on a few millivolts of signal. The meter circuit U1B is primarily intended to aid tuning; but with an external switch S1 it can be used to monitor other signals, in particular the state of lock of the two PLL's.

The main PLL, U3, runs at 16 times the carrier frequency. This drives a four-bit shift register, U5, to give

*Note that the author's prepared printed circuit board uses the "IC" designator for integrated circuits. All other figures follow *ham radio* style, designating IC's as U1A, U1B, etc.

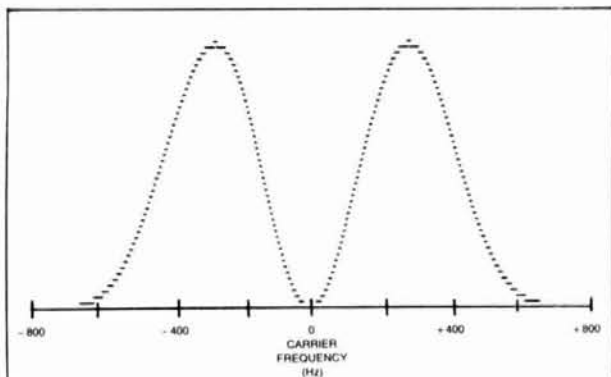

fig. 4. Telemetry power spectral density. Vertical scale is linear. Note the absence of any line components, which would waste power and also make it impossible to lock on to the carrier directly.



Front panel of decoder.

a quarter-cycle delay. The VCO, U3 is followed by a divide by 16 counter, U4, and some logic to generate the local $Q:2f$ signal and the recovered carrier CARR which translates the signal to baseband in U2A. The loop bandwidth is 10 Hz; component values for other bandwidths are shown in the table.

Extraction of the 400 Hz clock is similar to the carrier loop; the VCO, U7, runs at 6400 Hz and has a 1 Hz loop bandwidth. Note the additional quarter-bit delay, U9B, which provides the overall half-bit delay needed for the CLKR ambiguity resolution performed by U10A, U10C, and R13, C14. The clock extraction circuits were originally devised for a UOSAT data demodulator³ and the integrate-and-dump U1C, U11, and U12A is taken from that source too.

The block sync code detector consists of the feedback shift register code generator U14, U15C and final state (00001) tester, U16A, U16C. The shift register is released when the block bistable, U19A, is clear. Incoming data (bit D(0)) is tested against the code generator in EXOR gate U15A. A high state indicates a disagreement, and a CLK pulse resets the shift register. If the shift register reaches its last state, a CLK

pulse at AND gate U17D sets the block bistable, U19A, which also lights an LED. The shift register is reset and inhibited, while the bit/byte counter, U20, is released.

Every eighth count generates a positive, mid-bit byte strobe from the shaper circuit, U18C. This pulse signals external equipment to read the byte in buffer U13, via buffers U21 and U22.

The serializer works as follows. The rest condition has the start bistable, U24B, permanently clocking out "stop" which is cascading through from the shift register DS input, U25, pin 11. When the decoder has a byte ready, byte strobe sets the control bistable U24A pin 1 to "load". This prepares the start bistable U24B to go to "start" and the shift register U25 to load with bits D(0)-D(7) from the decoder buffer. This happens on the next high-going edge of the 1200 Hz clock, which also clears the load condition. Subsequent 1200 Hz clock pulses shift the data out of the serializer.

Outputs have the following conventions: the parallel data output byte is 1 high, 0 low. D(0) is the least-significant bit. "Block" is high true. Byte strobe is a high going 20 microsecond pulse, and begins mid-bit.



VDU, keyboard, and detector.



HF Equipment
IC-740* 9-band 200w PEP xcvr w/mic \$1099.00 **Regular SALE** 869⁹⁵
***FREE PS-740 Internal Power Supply & \$50 Factory Rebate - until gone!**

- PS-740 Internal power supply..... 159.00 **149⁹⁵**
- *EX-241 Marker unit..... 20.00
- *EX-242 FM unit..... 39.00
- *EX-243 Electronic keyer unit..... 50.00
- *FL-45 500 Hz CW filter (1st IF).... 59.50
- *FL-54 270 Hz CW filter (1st IF).... 47.50
- *FL-52A 500 Hz CW filter (2nd IF) 96.50 **89⁹⁵**
- *FL-53A 250 Hz CW filter (2nd IF) 96.50 **89⁹⁵**
- *FL-44A SSB filter (2nd IF)..... 159.00 **144⁹⁵**
- SM-5 8-pin electret desk microphone 39.00
- HM-10 Scanning mobile microphone 39.50
- MB-12 Mobile mount..... 19.50

- *Options also for IC-745 listed below**
- IC-730 8-band 200w PEP xcvr w/mic \$829.00 **569⁹⁵**
 - FL-30 SSB filter (passband tuning) 59.50
 - FL-44A SSB filter (2nd IF)..... 159.00 **144⁹⁵**
 - FL-45 500 Hz CW filter..... 59.50
 - EX-195 Marker unit..... 39.00
 - EX-202 LDA interface; 730/2KL/AH-1 27.50
 - EX-203 150 Hz CW audio filter..... 39.00
 - EX-205 Transverter switching unit 29.00
 - SM-5 8-pin electret desk microphone 39.00
 - HM-10 Scanning mobile microphone 39.50
 - MB-5 Mobile mount..... 19.50
 - IC-720A 9-band xcvr/.1-30 MHz rcvr \$1349.00 **869⁹⁵**
 - FL-32 500 Hz CW filter..... 59.50
 - FL-34 5.2 kHz AM filter..... 49.50
 - SM-5 8-pin electret desk microphone 39.00
 - MB-5 Mobile mount..... 19.50
 - IC-745 9-band xcvr w/.1-30 MHz rcvr \$999.00 **789⁹⁵**
 - PS-35 Internal power supply..... 160.00 **144⁹⁵**
 - CFJ-455K5 2.8 kHz wide SSB filter 4.00
 - HM-12 Hand microphone..... 39.50
 - SM-6 Desk microphone..... 39.00

See IC-740 list above for other options ()



- IC-751 9-band xcvr/.1-30 MHz rcvr \$1399.00 **1199**
- PS-35 Internal power supply..... 160.00 **144⁹⁵**
- FL-32 500 Hz CW filter (1st IF)..... 59.50
- FL-63 250 Hz CW filter (1st IF)..... 48.50
- FL-52A 500 Hz CW filter (2nd IF).... 96.50 **89⁹⁵**
- FL-53A 250 Hz CW filter (2nd IF).... 96.50 **89⁹⁵**
- FL-33 AM filter..... 31.50
- FL-70 2.8 KHz wide SSB filter..... 46.50
- HM-12 Hand microphone..... 39.50
- SM-6 Desk microphone..... 39.00
- CR-64 High stability reference xtal 56.00
- RC-10 External frequency controller 35.00
- MB-18 Mobile mount..... 19.50

- Options: 720/730/740/745/751 **Regular SALE**
- PS-15 20A external power supply..... \$149.00 **134⁹⁵**
 - EX-144 Adaptor for CF-1/PS-15..... 6.50

ICOM

- Options - continued**
- CF-1 Cooling fan for PS-15..... 45.00
 - EX-310 Voice synth for 751, R-71A 39.95
 - SP-3 External base station speaker ... 49.50
 - Speaker/Phone patch - specify radio 139.00 **129⁹⁵**
 - BC-10A Memory back-up..... 8.50
 - EX-2 Relay box with marker..... 34.00
 - AT-100 100w 8-band automatic ant tuner 349.00 **314⁹⁵**
 - AT-500 500w 9-band automatic ant tuner 449.00 **399⁹⁵**
 - AH-1 5-band mobile antenna w/tuner 289.00 **259⁹⁵**
 - PS-30 Systems p/s w/cord, 6-pin plug 259.95 **233⁹⁵**
 - OPC Optional cord, specify 2 or 4-pin 5.50
 - GC-4 World clock..... 99.95 **94⁹⁵**
- HF linear amplifier** **Regular SALE**
- IC-2KL w/ps 160-15m solid state amp 1795.00 **1299**
- VHF/UHF base multi-modes** **Regular SALE**
- IC-551D 80 Watt 6m transceiver..... \$699.00 **599⁹⁵**
 - EX-106 FM option..... 125.00 **112⁹⁵**
 - BC-10A Memory back-up..... 8.50
 - SM-2 Electret desk microphone..... 39.00
 - IC-271A 25w 2m FM/SSB/CW xcvr..... 699.00 **619⁹⁵**
 - AG-20 Internal preamplifier*..... 56.95
 - IC-271H 100w 2m FM/SSB/CW xcvr 899.00 **759⁹⁵**
 - AG-25 Mast mounted preamplifier* 84.95
 - IC-471A 25w 430-450 SSB/CW/FM xcvr 799.00 **699⁹⁵**
 - AG-1 Mast mounted preamplifier* 89.00
 - IC-471H 75w 430-450 SSB/CW/FM xcvr 1099.00 **989⁹⁵**
 - AG-35 Mast mounted preamplifier* 84.95

For a Limited time!
With the purchase of IC-271A/H or IC-471A/H get the matching Preamp* for just \$1.00 extra.

- Common accessories for 271A/H and 471A/H**
- PS-25 Internal power supply for (A)... 99.00 **89⁹⁵**
 - PS-35 Internal power supply for (H) 160.00 **144⁹⁵**
 - PS-15 External power supply..... 149.00 **134⁹⁵**
 - CF-1 Cooling fan for PS-15..... 45.00
 - EX-144 Adaptor for PS-15/CF-1 6.50
 - SM-6 Desk microphone..... 39.00
 - EX-310 Voice synthesizer..... 39.95
 - TS-32 CommSpec encode/decoder... 59.95
 - UT-15 Encoder/decoder interface... 12.50
 - UT-15S UT-15S w/TS-32 installed... 79.95

- VHF/UHF mobile multi-modes**
- IC-290H 25w 2m SSB/FM xcvr, TTP mic 549.00 **489⁹⁵**
 - IC-490A 10w 430-440 SSB/FM/CW xcvr 649.00 **579⁹⁵**
- VHF/UHF/1.2 GHz FM** **Regular SALE**
- IC-22U 10w 2m FM non-digital xcvr 299.00 **249⁹⁵**
 - EX-199 Remote frequency selector 35.00
 - IC-27A Compact 25w 2m FM w/TTP mic 369.00 **329⁹⁵**
 - IC-27H Compact 45w 2m FM w/TTP mic 409.00 **369⁹⁵**
 - IC-37A Compact 25w 220 FM, TTP mic 449.00 **299⁹⁵**
 - IC-47A Compact 25w 440 FM, TTP mic 469.00 **419⁹⁵**
 - UT-16/EX-388 Voice synthesizer... 29.95
 - IC-120 1w 1.2 GHz FM transceiver... 499.00 **449⁹⁵**
 - ML-12 10w amplifier..... 339.00 **299⁹⁵**

- 6m portable** **Regular SALE**
- IC-505 3/10w 6m port. SSB/CW xcvr \$449.00 **399⁹⁵**
 - BP-10 Internal Nicad battery pack 79.50
 - BP-15 AC charger..... 12.50
 - EX-248 FM unit..... 49.50
 - LC-10 Leather case..... 34.95
 - SP-4 Remote speaker..... 24.95



- Hand-held Transceivers**
- Deluxe models** **Regular SALE**
 - IC-02AT for 2m..... 349.00 **299⁹⁵**
 - IC-04AT for 440 MHz 379.00 **329⁹⁵**
 - Standard models** **Regular SALE**
 - IC-2A for 2m..... 239.50 **189⁹⁵**
 - IC-2AT with TTP..... 269.50 **199⁹⁵**
 - IC-3AT 220 MHz, TTP 299.95 **239⁹⁵**
 - IC-4AT 440 MHz, TTP 299.95 **239⁹⁵**

- Accessories for Deluxe models** **Regular**
- BP-7 425mah/13.2V Nicad Pak - use BC-35... 67.50
 - BP-8 800mah/8.4V Nicad Pak - use BC-35... 62.50
 - BC-35 Drop in desk charger for all batteries 69.00
 - BC-60 6-position gang charger, all batts **SALE** 359.95
 - BC-16U Wall charger for BP7/BP8..... 10.00
 - LC-11 Vinyl case..... 17.95
 - LC-14 Vinyl case for Dlx using BP-7/8..... 17.95
 - LC-02AT Leather case for Dlx models w/BP-7/8 39.95

- Accessories for both models** **Regular**
- BP-2 425mah/7.2V Nicad Pak - use BC35.... 39.50
 - BP-3 Extra Std. 250 mah/8.4V Nicad Pak.... 29.50
 - BP-4 Alkaline battery case..... 12.50
 - BP-5 425mah/10.8V Nicad Pak - use BC35 49.50
 - CA-2 Telescoping 2m antenna..... 10.00
 - CA-5 5/8-wave telescoping 2m antenna..... 18.95
 - FA-2 Extra 2m flexible antenna..... 10.00
 - CP-1 Cig. lighter plug/cord for BP3 or Dlx.... 9.50
 - DC-1 DC operation pak for standard models 17.50
 - LC-2AT Leather case for standard models.... 34.95
 - RB-1 Vinyl waterproof radio bag..... 30.00
 - HH-S Handheld shoulder strap..... 14.95
 - HM-9 Speaker microphone..... 34.50
 - HS10 Boom microphone/headset..... 19.50
 - HS-10SA Vox unit for HS-10 & Deluxe only 19.50
 - HS-10SB PTT unit for HS-10..... 19.50
 - ML-1 2m 2.3w in/10w out amplifier..... **SALE** 79.95
 - ML-25 2m 2.3w in 20w out amplifier..... **SALE** 179.95
 - SS-32M Commspec 32-tone encoder..... 29.95

- Shortwave receivers** **Regular SALE**
- R-71A 100 Khz-30 Mhz digital receiver \$799.00 **689⁹⁵**
 - FL-32 500 Hz CW filter..... 59.50
 - EX-310 Voice synthesizer..... 39.95
 - RC-11 Wireless remote controller... 59.95
 - CR-64 High stability oscillator xtal 56.00
 - R-70 100 Khz-30 Mhz digital receiver 749.00 **569⁹⁵**
 - EX-257 FM unit..... 38.00
 - IC-7072 Transceive interface, 720A 112.50
 - FL-44A SSB filter (2nd IF)..... 159.00 **144⁹⁵**
 - FL-63 250 Hz CW filter (1st IF)..... 48.50
 - SP-3 External speaker..... 49.50
 - CK-70 (EX-299) 12v DC option..... 9.95
 - MB-12 Mobile mount..... 19.50



HOURS: Mon. thru Fri. 9-5:30; Sat 9-3
 Milwaukee WATS line 1-800-558-0411 answered evenings until 8:00 pm Monday thru Thursday
Please use WATS line for Placing Orders
 For other information, etc. please use Regular line

Order Toll Free: 1-800-558-0411 *In Wisconsin (outside Milwaukee Metro Area) 1-800-242-5195*

AMATEUR ELECTRONIC SUPPLY[®] Inc.

4828 W. Fond du Lac Avenue; Milwaukee, WI 53216 - Phone (414) 442-4200

AES BRANCH STORES

- | | | | | |
|--|---|---|---|--|
| WICKLIFFE, Ohio 44092
28940 Euclid Avenue
Phone (216) 585-7388
Ohio WATS 1-800-362-0290
Outside Ohio 1-800-321-3594 | ORLANDO, Fla. 32803
621 Commonwealth Ave.
Phone (305) 894-3238
Fla. WATS 1-800-432-9424
Outside Florida 1-800-327-1917 | CLEARWATER, Fla. 33575
1898 Drew Street
Phone (813) 461-4267
No In-State WATS
No Nationwide WATS | LAS VEGAS, Nev. 89106
1072 N. Rancho Drive
Phone (702) 647-3114
No In-State WATS
Outside Nevada 1-800-634-6227 | Associate Store
CHICAGO, Illinois 60630
ERICKSON COMMUNICATIONS
5456 N. Milwaukee Avenue
Phone (312) 631-5181
Outside Illinois 1-800-621-5802 |
|--|---|---|---|--|

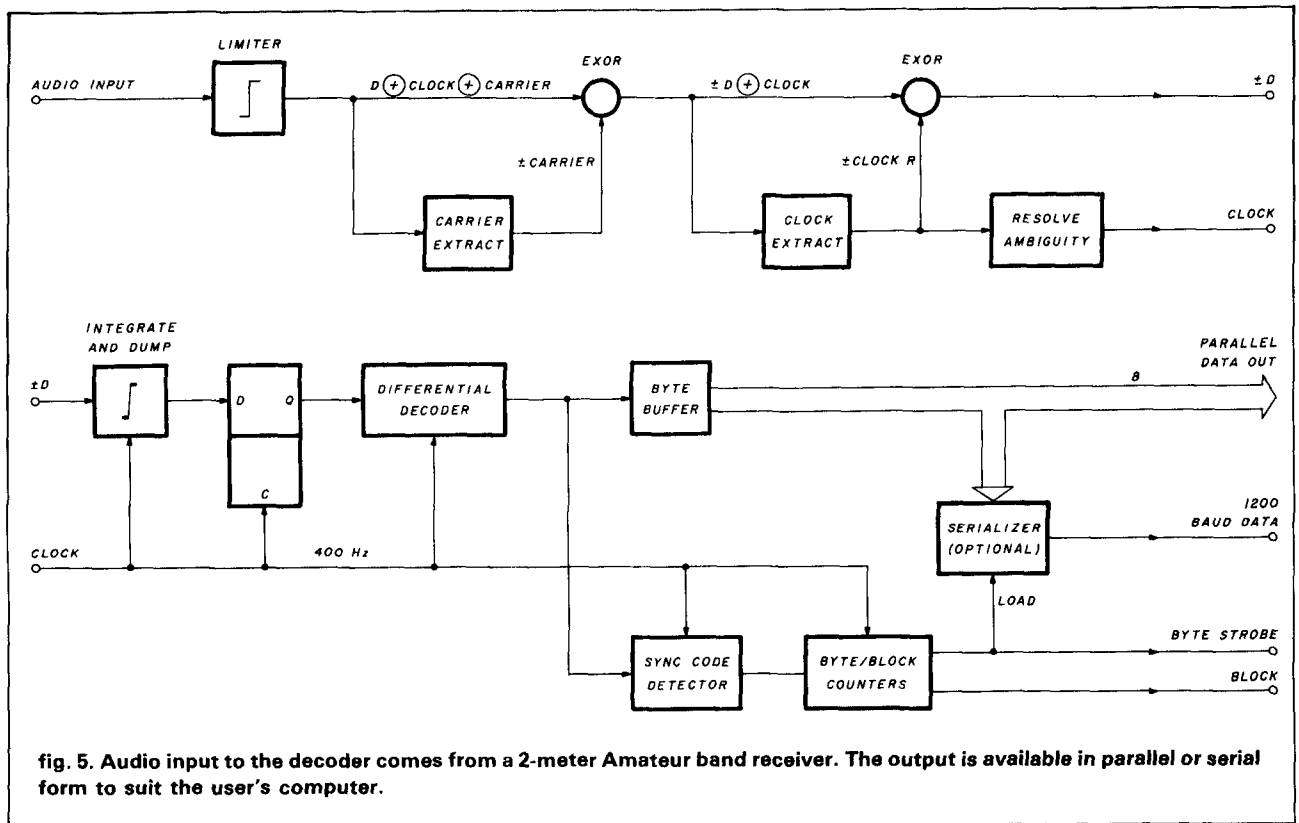

fig. 5. Audio input to the decoder comes from a 2-meter Amateur band receiver. The output is available in parallel or serial form to suit the user's computer.

The serial 1200 baud data format is Start and Data 0 high, Stop and Data 1 low, eight data bits, l.s.b. sent first. The 1200 baud square-wave clock goes low mid-bit. Note that not all data is ASCII in particular the last 256 bytes of Q blocks.

400 bit/s serial data and CLK may be selected as the serial output by changing link D and link C. Square wave CLK goes low mid-bit. The data is *not* in start/stop telegraphy format.

setting up

An audio generator, oscilloscope, and multimeter will be needed. A telemetry data test tape will be invaluable: this can be recorded off-air or obtained via AMSAT-UK². The satellite itself can be used for live testing, but is not always available when you want it. The signal is also noisy, which may confuse matters.

receiver

The first job is to decide what carrier frequency will be used. Trigger the scope at 200 Hz (or 50 Hz if available), tune the receive to OSCAR 10's beacon, and display the audio. Amplitude modulation should be discernible. Experiment with tuning and bandwidth until the signal looks healthy with the mid-bit cross-over clear and sharp. Now trigger the scope with the signal estimate and note the carrier frequency, say f_c . Any frequency exceeding 1000 Hz will be satisfactory.

carrier loop

The objective is to set the loop mid-frequency to the measured carrier frequency (f_c) and achieve a total frequency swing (f_{sw}) at the output of the divide-by-16 (TP1) of $f_{sw} = 800$ Hz. This is slightly complicated by the fact that a 4:1 spread in oscillation frequency between different samples of a 4046 VCO is quite typical.

Start with the VCO swing, nominally given by

$$f_{sw} = \frac{1}{R7 \times C10}. \text{ Apply } V_{DD} \text{ and then } 0V \text{ to pin 9}$$

of the PLL chip, U3, measure high and low frequencies at TP, and subtract. If the difference f_d , is within 25 percent of 800 Hz, then all is well. Otherwise, change C10 for the correct swing.

Calculate and note the desired VCO upper frequency, $f_u = f_c + f_d/2$. Again, connect V_{DD} to pin 9 of the 4046. With the main tuning potentiometer, VR₃, at mid-position, adjust trimmer VR₂ to give frequency f_u . If this cannot be achieved, then change C10 and R7 (in inverse proportion to each other, so as to preserve f_d) and start again.

Now inject f_c at the audio input. Check that the loop locks on this signal. The lock meter should indicate to one side. Slightly vary the input frequency and the main tuning control VR₃ and observe the tuning meter center-zero response. The loop should stay in lock over a range of $\pm f_d/2$.

clock loop

In the same way as for the carrier loop, check that the available frequency swing at TP₂ is about 100 Hz in total. If necessary, change C12 to achieve this. Then adjust VR4 so that the mid-frequency is 400 Hz.

Temporarily ground U2A pin 1. Inject 400 Hz at the audio input. The loop should lock up correctly; this will show on the lock meter. Next inject 200 Hz, which simulates data 010101 . . . (message 11111 . . .). Verify that the loop locks again. Examine the ambiguity signal at U10D pin 12. This should be either high or low and should not vary about V_{DD}/2. Now examine the CLK signal at U10D pin 10. The low-going edges should coincide with the transitions of the input signal.



Enlarged view of display.

Disturb loop lock a number of times by removing the 200 Hz input signal for a few seconds. Each time this is done the ambiguity signal will assume a random state, but CLK should always resolve itself to the correct phase.

V_{DD}/2 supply

Remove the temporary ground from U2A pin 1. Apply receiver random noise to the system input. Connect an analog meter (on VDC) across pins 1 and 2 of the bistable U12A. Adjust the half-supply control VR₁ for zero reading.

testing

Once the system has been adjusted it may be checked out live or with a test tape². The waveforms obtained should be as shown in **figs. 6, 7, and 9**. A number of features of the satellite data make this easier. The padding character hex 50 and <space> both occur in longish bursts. In addition, the sync code tester will obviously not work unless everything else is going properly, and so illumination of the "block" LED once every 14 seconds for 10 seconds provides a quick, comprehensive overall check.

decoding data

The design of the software to decode and display the data is straightforward enough, but it is outside the scope of this article to present it in full.

The computer should examine the block flag until

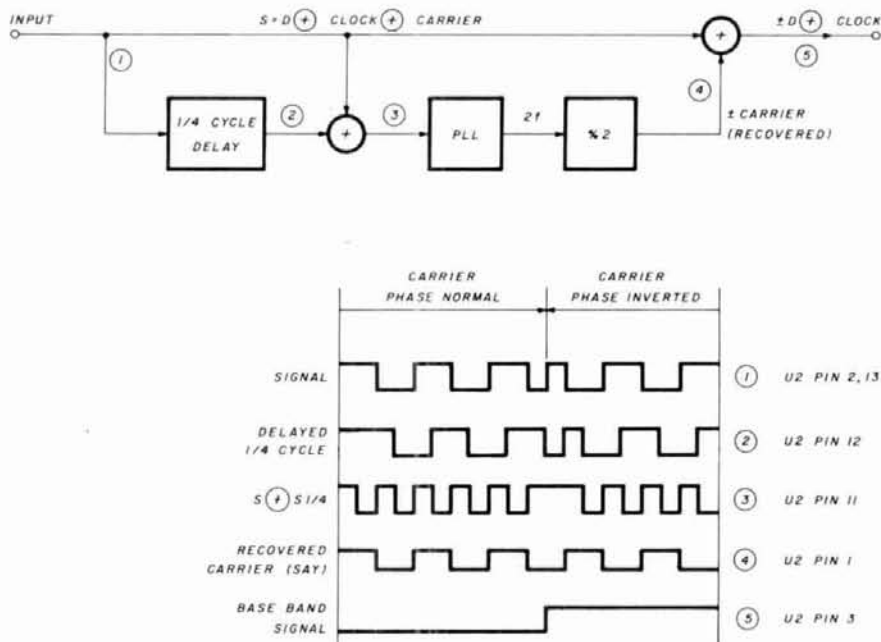
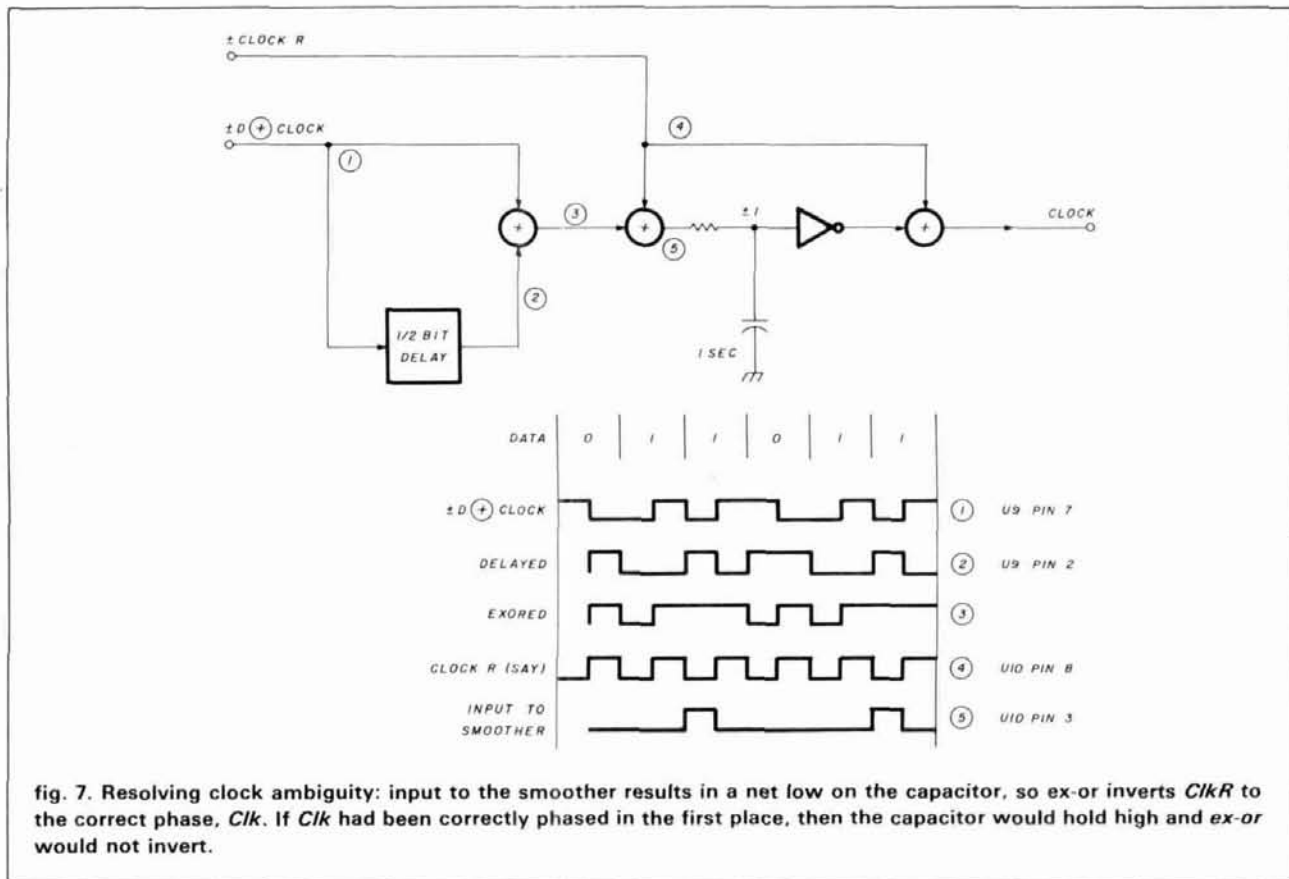

fig. 6. Carrier recovery and conversion to baseband. Clock recovery is identical: simply add 4 to each of the U numbers.



it is asserted, then wait for a byte strobe. It should then read in the byte; place it into a 512-byte buffer and await the next strobe. Alternatively, bits may read in serially and packed away.

When all 512 bytes have been read, decoding can begin. In real-time there are 4 seconds in which to do this. Check that the first two bytes are recognizable identifiers, e.g. $Q < \text{space} >$. Then all that remains is to pick out the items of interest such as volts, amperes and temperatures and to display them on a printer or screen in an appropriate format.

Alternatively it is possible to dump the lot, or selected bytes, to storage for later processing, perhaps to monitor specific parameters or to plot graphs.

performance

A useful indicator of performance is given by the bit error rate. If we define a reasonable rate as less than 1 in 10,000 bits, i.e. an average of one error every other block, the theoretical channel signal-to-noise ratio S/N should be 2.4dB in 1600 Hz bandwidth. Allowing for the signal amplitude modulation and the limiter, the practical figure is actually about 6.2dB, peak signal power to noise power, or 2:1 in voltage. With care this can be verified experimentally — the signal sounds and looks pretty ragged.

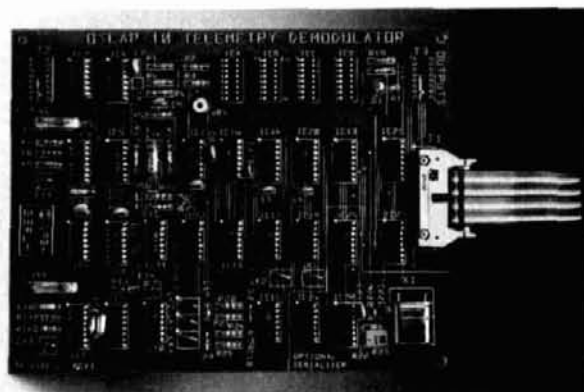

Decoder board with ribbon connector and decoder.

An S/N of 6.2dB is represented in the lab by the surprisingly small figure of 52 nanovolts (nV) (-133dBm) at the input of a receiver having a 3dB noise figure. Now, the 2m general beacon transmits about 1W ($+30\text{dBm}$); the space loss over a 24,850 mile (40,000km) path is 168dB, so the received signal at a unit gain antenna is roughly -138dBm . Thus an antenna gain of $138 - 133 = +5\text{dBi}$ is needed, plus a margin for fading, cable losses, wider bandwidth, higher receiver noise figure and so on.

In practice this means that for satisfactory recep-

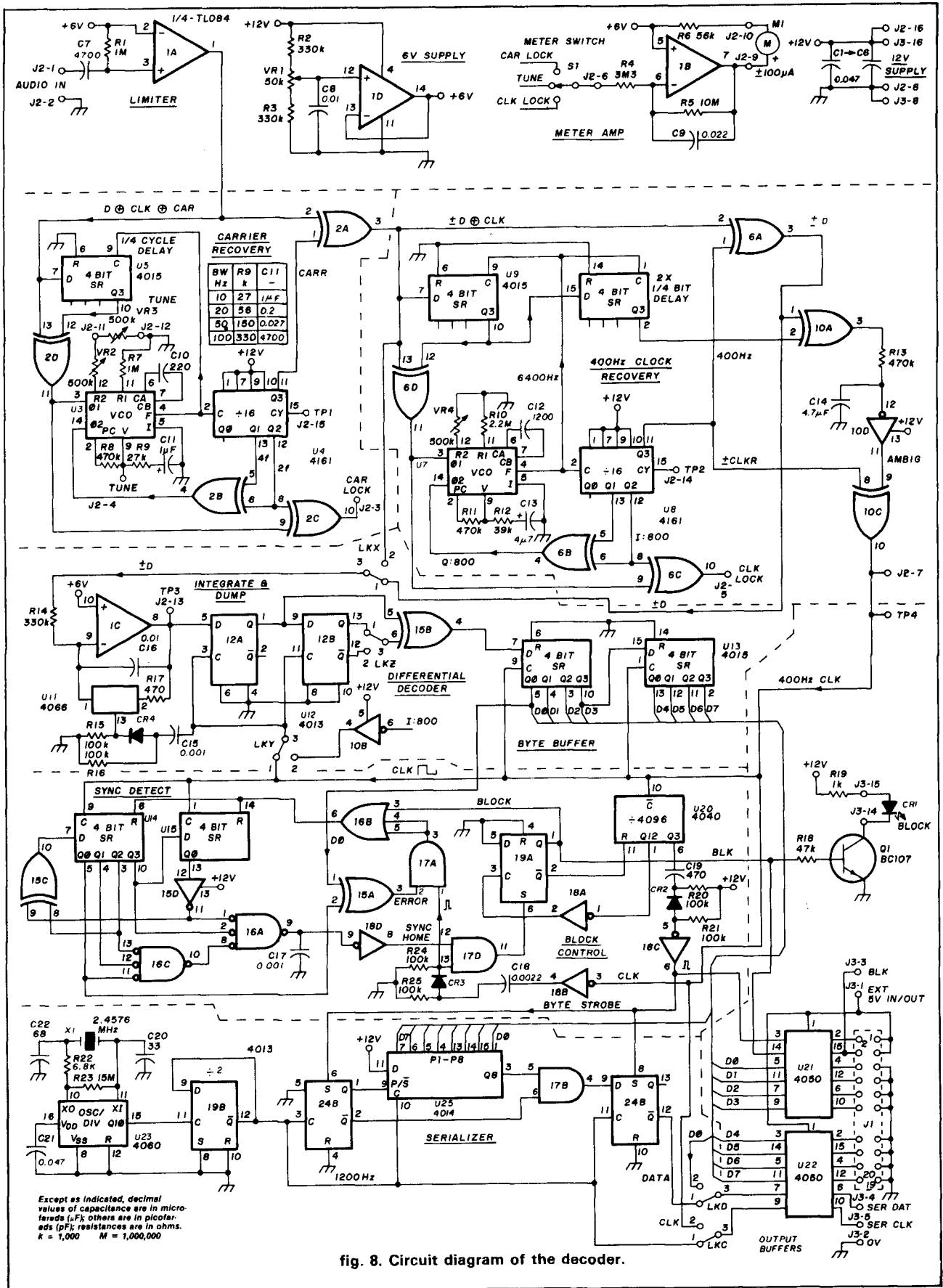

fig. 8. Circuit diagram of the decoder.

OSCAR-10 PSK demodulator parts list.

capacitors (all 16 volt rates)

C1-C6,C21	0.047 μ F
C7	4700 pF
C8	0.01 μ F
C9	0.022 μ F
C10 — see text	220 pF 5 percent,*
C11 — see text	1 μ F tantalum
C12 — see text	1200 pF 5 percent*
C13,C14	4.7 μ F tantalum
C15,C17	0.001 μ F
C16	0.01 μ F**
C18	0.0022 μ F
C19	470 pF
C20	33 pF
C22	68 pF

*polystyrene

**good polyester

CMOS integrated circuits

U1	TL084	quad op amp
U2,6,10,15	4070	quad EXOR
U3,7	4046	PLL
U4,8	4161	divide-by-16
U5,9,13,14	4015	quad-4 bit SR
U11	4066	quad switch
U12,19,24	4013	dual-D type
U16	4075	triple-3 OR
U17	4081	quad-2 AND
U18	4069	hex inverter
U20	4040	12-bit divider
U21,22	4050	hex buffer
U23	4060	Osc/14-bit divider
U25	4014	8-bit SR

potentiometers

VR1	50k preset, cermet. Spectrol 62
VR2,4	500k preset, cermet. Spectrol 43
VR3	500k linear, carbon

resistors (all 5 percent)

R1, R7	1M
R2,R3,R14	330k
R4	3.3M
R5	10M
R6	56k
R8,R11,R13	470k
R9 — see text	27k
R10	2.2M
R12	39k
R15,R16,R20 R21,R24,R25	100k
R17	470
R18	47k
R19	1k
R22	6.8k
R23	15M

semiconductors

CR1	LED 10 mA red
CR2,3,4	1N4148 (or equivalent)
Q1	BC107 (or equivalent)

miscellaneous

M1	\pm 100 μ A center zero meter
X1	2.4576 MHz crystal HC33/U size
J1	20-way PCB header for IDC connector
J2,3	16-pin DIL socket
S1	1P3T (1 pole, 3 position) switch
TP1-4	test points

Note: The meter, VR3, CR1, and the switch, S1, are not mounted on the board. Links LKC, D, X, Y, and Z are made from hook-up wire. PC board designators have been left in British style.

tion a modest Yagi or equivalent is needed, pointed at the satellite.

It is worth noting that it is typical of optimal demodulators that they exhibit a marked performance threshold effect. In our "6.2dB" example above, a reduction in the S/N of only 1dB results in a dramatic tenfold error rate increase. This is most apparent where there is a rapid fading (usually induced by the satellite's 40 rev/min spin): what appears to be a healthy signal actually results in bursts of errors at S/N minima. Spin fading occurs most strongly a few hours each side of apogee, when the spacecraft's antennas are not pointing directly towards Earth.

Because of the differential decoding scheme, a single bit error leaving the integrate-and-dump section results in two adjacent bit errors at the system output. This should be remembered if any software error checking is to be attempted.

a further decoding method

Finally, there is another method of decoding the signals. There is a distinctive relationship between the

message bits (as opposed to data bits) and the encoded stream. Each message¹ results in a $D\oplus CLK$ signal with missing inter-bit transitions, whereas a message 0 does not (see fig. 3).

So an alternative decoding method is to treat $D\oplus CLK$ as a stream of 800 bit/s half-bits, grouped in pairs. Two similar successive half-bits are decoded to a logic 1 output, and two differing half-bits to a 0.

This can be implemented most simply by feeding the integrator with $D\oplus CLK$, clocking the integrate-and-dump and differential decoder with $1/800$, and inverting the data output sense! Links X, Y and Z are provided to enable experimenters to evaluate this.

The error properties of this arrangement are interesting. Because the signal energy per dump decision has halved, the half-bits' intrinsic error rate is much higher than a whole bit's, but it is now possible for single message bits only to be corrupted.

The presence of a mid half-bit-pair transition for zeros implies that the carrier energy per bit for a 0 is about two-thirds of that of a 1. So message 0s are more easily corrupted than 1s. This contrasts with the

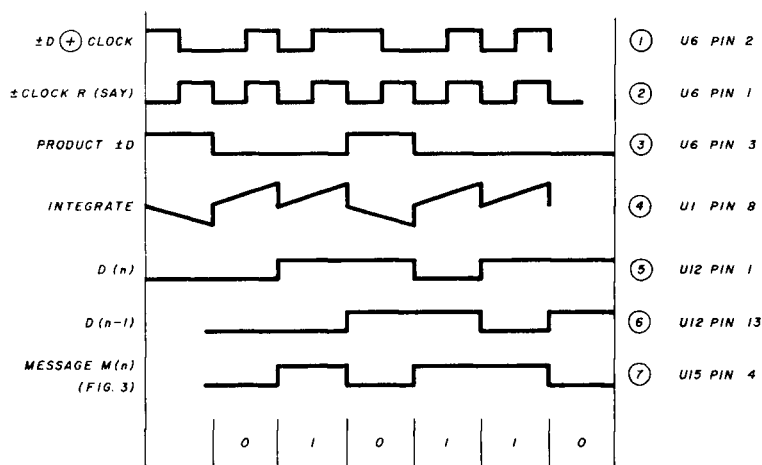
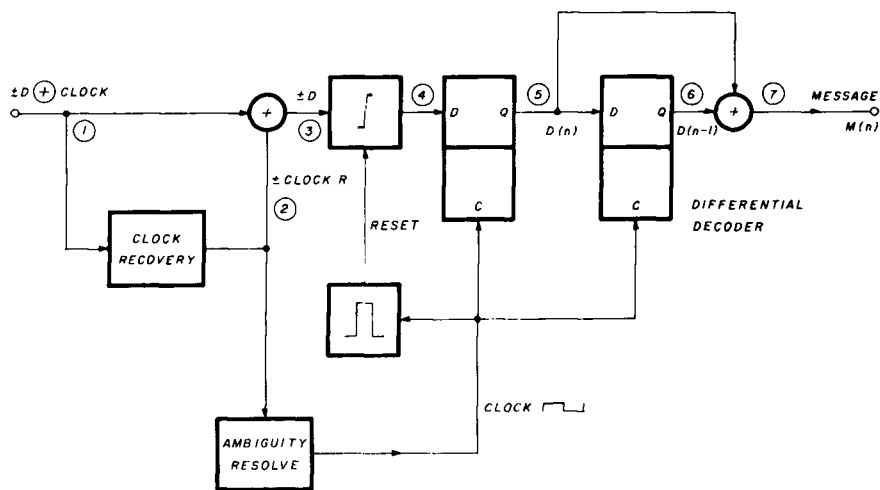

fig. 9. Message recovery: with noise present, the product $\pm D$ will be perforated and the triangles in trace 4 will become ragged. The differential decoder compares present data with the previous bit. If they are the same, the message bit is 1; if they are different, the message bit is 0. Thus the polarity of data is unimportant.

whole-bit decoder, where 0 or 1 data bit errors are equally likely but two message bits are always corrupted together, though less frequently.

acknowledgements

This article originally appeared in the British publication, *Electronics and Wireless World*, formerly *Wireless World* (October and November, 1984). Sincere thanks are due to editor Philip Darrington for permission to adapt the original text and illustrations for U.S. publication.

Many colleagues deserve mention, especially Trevor Stockill, G4GPQ, for encouragement, PCB layout facilities, and comparative testing with other decoders; Ron Broadbent, G3AAJ, of AMSAT-UK; Janet Miller, for letting me hog our home computer; and Cambridge Consultants Limited, for the free use of facilities.

A double-sided, legended, plated-through, printed circuit board is available from the author at the address indicated on page 50. The price, which includes shipping by air is £ 20.

references

1. M. R. Davidoff, *The Satellite Experimenter's Handbook*, American Radio Relay League, 1984. (Available from Ham Radio's Bookstore, Greenville, New Hampshire 03048, \$00.00 postpaid.)
2. AMSAT-UK, London, E12 5EQ, England. Decoder alignment test tape, £ 7.50; "Oscar-10 Operating Manual", £ 5; Telemetry decoding software for BBC (Acorn) microcomputer, on cassette £ 7.50; PCB £ 20. Prices include packing and postage from UK to USA. A bank draft in sterling is requested (cash at own risk). A stamped addressed envelope must accompany ALL inquiries. AMSAT-UK depends on donations.
3. J. R. Miller, "Data Decoder for UOSAT," *Wireless World*, Vol. 89, No. 1568, May, 1983, pages 28-33.
4. A. Viterbi, *Principles of Coherent Communication*, McGraw-Hill, 1966.

ham radio

SAVE \$10.00* with home delivery!

Payment enclosed

Bill me later

U. S. prices only

\$19.95

\$32.95

\$44.95

1 Year 12 issues

2 Years 24 issues

3 Years 36 issues

*(One year newsstand cost \$30.00)
Here's my address label, enter my subscription.

Name _____ State _____ Zip _____

Address _____

City _____

Check here if this is your renewal (attach label)

Subscribe to **ham radio** magazine

Please allow 4-6 weeks for delivery of first issues.
Foreign rates: Europe, Japan and Africa, \$28.00 for one year by air forwarding service. All other countries \$22.95 for one year by surface mail.

Please
enter my
subscription



BUSINESS REPLY CARD
First Class Permit No. 1 Greenville, NH

Postage Will Be Paid By Addressee

**ham
radio**
Greenville, NH 03048

NO POSTAGE
NECESSARY
IF MAILED
IN THE
UNITED STATES



ICOM 2-Meter Mobile

IC-27H



HM23
Microphone

IC-27A
25 Watt

IC-27H
45 Watt

Compact Size No Compromise

Now ICOM offers the best choices in compact 2-meter FM mobiles...the IC-27H 45-watt compact and the IC-27A 25-watt ultra compact mobile.

Size. The ICOM IC-27A and IC-27H measure only 5½"W x 1½"H x 7"D (IC-27H is 9" deep).

Easy to Operate. Even though the IC-27A and IC-27H are the smallest mobiles they have large operating knobs which are easy to use in the mobile environment.

32 PL Frequencies. The compacts come ready to go

with 32 PL frequencies.

Internal Speaker. The compacts feature an internal speaker which allows the mobiles to be mounted in a variety of compact locations.

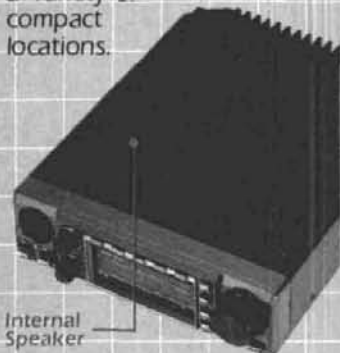

Internal
Speaker

9 Memories. The compact mobiles have 9 memories which will store the receive frequency, transmit offset, offset direction and PL tone. All memories are backed up with a lithium battery.

Speech Synthesizer. To verbally announce the receive frequency, an optional UT-16 voice synthesizer is available.

Scanning. The ICOM compacts have four scanning systems...memory scan, band scan, program scan and priority scan. Priority may be a memory or a VFO channel...and the scanning speed is adjustable.

More Features. Other standard features include a mobile mount, IC-HM23 DTMF mic with up/down scan and memory scan and internally adjustable transmit power.

An optional IC-PS45 slim-line external power supply and IC-SP10 external speaker are also available.

See the IC-27A/H compact mobile transceivers at your local ICOM dealer. For superb performance and reliability your only choice is an ICOM.

Also Available are the IC-37A 220MHz and IC-47A 440MHz 25 watt compact mobiles.



First in Communications

MISSOURI RADIO CENTER

KENWOOD



TS-430S Most Advanced, Compact HF Transceiver

- General Coverage Receiver
- USBLSB/CW/MF
- Optional FM • 10Hz Dual Step Digital VFO • Eight Memories w/Lithium Back-up • Memory and Band Scan

KENWOOD



TS-930S Top of the Line HF Transceiver

- General Coverage Receiver • Superior Dynamic Range • All Solid State—2B VDC Final • QSK CW • Optional Automatic Antenna Tuner • Dual VFO w/8 Memories • Dual Mode Noise Blanker

KENWOOD



TR-7950/7930

- Large LCD Readout • 21 Multi-Function Memory • Lithium Back-up • Automatic Offset • Built-in Encoder • Memory or Band Scan

KENWOOD



TR-2600

- 2.5W/300 mW (Switchable) 2 Meter Handheld Transceiver
- LCD Readout • Ten Memories w/Lithium Back-up • Band and Memory Scan • Built-in Sub-tone Encoder

YAESU



FT-757 GX

- Compact General-Coverage Receiver
- General Coverage Receiver
- USBLSB/CW/MF • Dual VFOs
- Memory/Band Scan • Speech Processor • CW Filter and CW Keyer included

YAESU

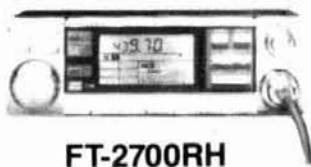

FT-2700RH

- Dual Bander
- VVHF FM
- 144430 MHZ
- 25 WATTS

YAESU



FT-209RH

- 5 Watts
- 10 Memories
- LCD
- Compact

YAESU



FT980

- CAT SYSTEM—ComputerAided Transceiver
- Wide Dynamic Range • General Coverage • Low Noise Front End • 10 Hz Digital Readout • All Mode Transceiver—CW/SSB/AM/FM/FSK

ICOM



IC-745 HF Base

- All ham band HF transceiver 16 memories 100kHz to 30 MHz general coverage receiver and adjustable noise blanker and AGC

ICOM



IC-27A Compact Mobile

- A breakthrough in 2-meter mobile communications! Most compact on the market (5" x 4" x 1 1/2" Hx7" D) contains internal speaker for easy mounting, 25 watts 32 PL frequencies, 9 memories, scanning and touchtone mic

ICOM



IC-02AT

- The IC-02AT 2-meter LCD readout handheld features 10 memories, 32 PL tones, scanning keyboard frequency entry, dial lock, 3W std 5W opt DTMF

ICOM



IC-R71A General Coverage Receiver

- The IC-R71A 100kHz 30 MHz superior-grade general coverage receiver features keyboard frequency entry, 32 memories, SSB/AM/RTTY/CW, selectable AGC and noise blanker, and wireless remote controller (optional)

NEW

OUR ASSOCIATE
STORE IN THE
ST. LOUIS AREA

FLOYD ELECTRONICS
2213 VANDALIA COLLINSVILLE, ILL 62234
CALL 618-345-6448

✓ 135

CALL FOR SPECIAL SALE PRICES

- AEA
- ASTRON
- AVANTI
- AZDEN
- B & W
- BEARCAT
- BENCHER

- BUTTERNUT
- CENTURION
- CES
- COMM SPEC
- CUSHCRAFT
- DAIWA
- HUSTLER

- HYGAIN
- ICOM
- KANTRONICS
- KENWOOD
- KLM
- LARSEN

- MFJ
- MICROLOG
- MIRAGE
- SANTEC
- VANGORDON
- WELZ
- YAESU

CALL TOLL FREE 1-800-821-7323

MASTERCARD, VISA & C.O.D.'s WELCOME

2900 N.W. VIVION RD.
KANSAS CITY, MISSOURI 64150
816-741-8118

ham radio TECHNIQUES

Bill Over
W6SAI

electron-hole theory exposed as fraud

Have you been bemused and confused by the electron-hole theory? Do charges, valence bonds, and the 3/2-power law make you nervous?

A startling discovery by Mark Persons invalidates all of this claptrap! In a recent issue of *Radio World*,¹ Mark reveals how electronic equipment really works:

For many years, young electronic technicians have been taught the "hole" theory of electronics. This theory explains how electrons move along conductors and semiconductors. The explanation has been good enough to satisfy or keep at bay anyone who might otherwise question the theory.

However, after a number of years working in the broadcast industry, I have come to realize the "hole" explanation may not be correct.

My theory, which has been proven time and again by personal observation, is that electronics works on smoke. Yes, that's right. I recently learned that every manufacturer encapsulates a certain amount of smoke in every piece of electronic component he builds. The smoke is what does the work.

You have probably noticed that a component will quit working when the smoke leaks out. I've documented this many times and it conclusively proves my theory. My theory sure beats the

"hole" theory. I've never seen holes in a wire, and why don't electrons pour out of the end of the wire, if the wire is broken?

I say Mark Persons is RIGHT. I've seen smoke many times, but I've never seen an electron. Hats off to this pioneer whose discovery will be celebrated each April in the years to come!

more on VCR RFI

The subject of video cassette recorder RFI seems to keep coming up. It's a tough problem, and will probably get worse, according to Bill Pasternak, WA6ITF, who writes:

VCR-RFI is becoming a major problem and unless the manufacturers return to a higher quality product as was the case with the earlier models, I am afraid that there is little that can be done to solve the problem.

While broadcast station VCRs are designed to be immune to relatively strong rf fields, this is not true with the consumer machines. For the past five years, the manufacturers have been concentrating on reducing size and bulk and thereby the cost of manufacture by eliminating as much of the internal metallic construction as is possible. In most cases, the modern VCR consists of one or two printed circuit boards on which are mounted all of the electronic components. The only shielding is that of "tin cover plates" soldered over individual circuits that must be shielded to operate. The

boards are, for the most part, secured to the plastic mainframe of the VCR and grounding between boards and chassis-of-transport is done with No. 18 wire. This construction technique, combined with the operating frequencies of the unit leaves it wide-open to interference.

The home VCR package is too small and confined to properly shield it without chancing damage of components on the PC boards. Today it appears to be "build them as cheaply as you can so the local discounter can sell them for under \$300."

Unlike a TV receiver which can be effectively shielded and protected, this cannot be done with the modern home VCR. Only the equipment manufacturer can solve the problem, and as long as we go to cheaper, plastic construction, the problem will worsen rather than improve.

Finally, if you are not trained on how to service a VCR, don't even open it up to see what's inside. This is one piece of consumer electronics that should only be serviced by a highly skilled technician.

I have written a book that covers the entire spectrum of video recording from the VRX-1000 to the home VHS machine. It is titled Videocassette Recorders: Buying-Using-Maintaining and it is available from TAB Books. If any reader of your column is contemplating the solution of VCR-RFI, I urge them to read this book, or any other

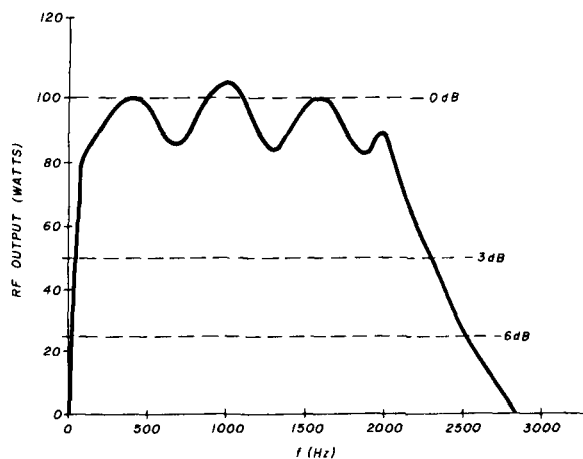

fig. 1. Representative audio response of the Yaesu FT-980 using audio generator at microphone jack and measuring RF power output. (Curve run by NE5S.)

good book on the subject, before they open up the case. Once they read it, however, they will understand why they should turn their problem over to a professional.

Hard words! But WA6ITF has been in video recording since the late 1950s, when Ampex introduced the famous VRX-1000 broadcast video recorder/reproducer. He emphasizes a serious problem that looks like it will only get worse in 1985!

transceiver frequency response

In the October, 1984, issue of *ham radio* I wrote about the audio frequency response of various SSB transceivers. I received a note from Emile, N5ES, who writes:

*I ran a test on my FT-980 (see fig. 1). While the fluctuations don't seem too bad, it is my opinion that the whole response curve seems 300 to 400 Hz too low. Of course, there are other factors to consider, such as microphone response. I use a SHURE 444 and have gotten consistently good quality reports. Wouldn't it be nice if we had some standards in this respect! (See "Microphone Calibration," by Daniel Peters, NY6U, *ham radio*, June, 1984, page 73.)*

In this regard, Steve, K6FS, says: *The point that concerns me is the apparent confusion among Amateurs be-*

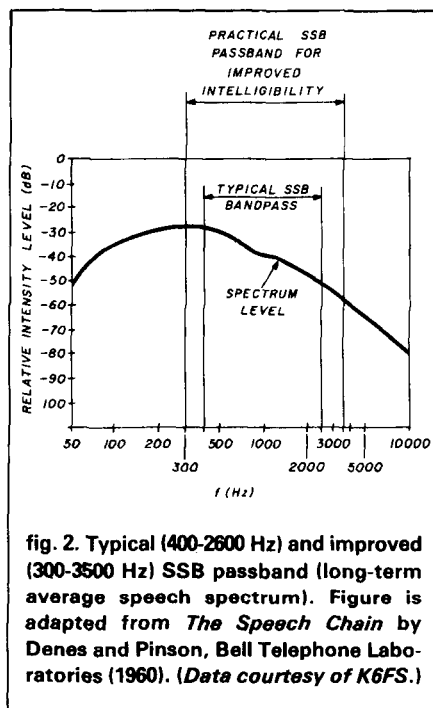

fig. 2. Typical (400-2600 Hz) and improved (300-3500 Hz) SSB passband (long-term average speech spectrum). Figure is adapted from *The Speech Chain* by Denes and Pinson, Bell Telephone Laboratories (1960). (Data courtesy of K6FS.)

tween speech "quality" and communication "intelligibility." By no stretch of the imagination can "quality" or "fidelity" be applied to the band-limited, relatively low signal-to-noise, high distortion conditions prevailing in Amateur SSB service. On the other hand, a 2800 to 3000 Hz wide passband will yield adequate intelligibility under typical Amateur conditions, if properly placed in the speech spectrum.

Results of a good amount of re-

search indicate that practical passband limits are 300 and 3000 Hz (possibly as high as 3300 Hz) with an in-band ripple of plus or minus one decibel. (See "Defining the Decibel" by Michael Gruchalla, *ham radio*, February, 1985, page 51, and "Better Sounding SSB" by Richard L. Measures, AG6K, *ham radio*, February, 1984, page 58. — Ed.)

If it is necessary to narrow the transmitted passband, then intelligibility can best be protected by raising the lower limit to as high as 1000 Hz rather than shrinking the passband symmetrically. Voice frequencies below 1000 Hz are not as important to intelligibility as are those above.

One other point of confusion seems to exist: the terms for expressing filter passband limits. Usually measured in voltage terms, filter characteristics are often expressed as Hz between the "6 dB-down" points. This is equal to the half-power points "3 dB-down," in power terms. (A dB is a dB is a dB. — Ed.)

Measurements based upon power, such as shown in your article in the October, 1984, issue of *ham radio* (see pages 109-111), were evidently based on output power measurements. If this is so, the distance between half-power points (shown on right-hand ordinates) delineate much narrower passbands than the "6 dB bandwidth" shown for each filter. Thus, by conventional terms, the IC-730 has a 2000 Hz passband (400-2400 Hz), the KWM-1 about 1600 Hz (550-2150 Hz) and the modified TS-830, 1800 Hz (400-2200 Hz). My suspicion is that all three would sound "muddy," cutting off the critical higher frequencies, as they appear to do.

I note that my TS-130 service manual directs that carrier insertion be adjusted so as to set the -6 dB points at 400 and 2600 Hz. That's 2200 Hz bandwidth — tolerable but hardly optimal.

I am enclosing a copy of the basic spectrum level curve by Denes and Pinson, published in 1960 by Bell Telephone Laboratories. I have drawn in some passbands showing typical and suggested SSB filter character-

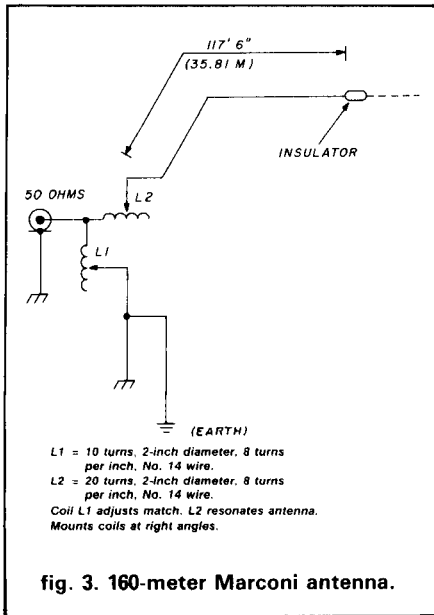

fig. 3. 160-meter Marconi antenna.

istics to illustrate the relationships discussed (see fig. 2). Note how much energy the human voice produces below 500 Hz. It's not essential to intelligible communication.

Well, it looks to me as if the passband filter in most Amateur SSB equipment cuts off too soon in the HF-voice region. Passing voice frequencies out to about 3500 Hz can improve intelligibility and not widen the spectrum of the signal appreciably. Most Amateur signals I've heard are wider than their voice passband anyway, mainly because of flat-topping in a linear amplifier stage (the "all-knobs-to-the-right" syndrome).

the 160-meter Marconi antenna revisited

My remarks on a 160-meter antenna in my July, 1984, column included a discussion of a practical Marconi antenna and matching network for 160 meters. After six months of use, I've come up with a better, simpler and even cheaper unit. The new design is shown in fig. 3.

The Marconi is matched to the 50-ohm antenna part of the transmitter through an L-network, which consists of a shunt inductor and a series capacitor. The capacitor consists of a shorter than resonance antenna —

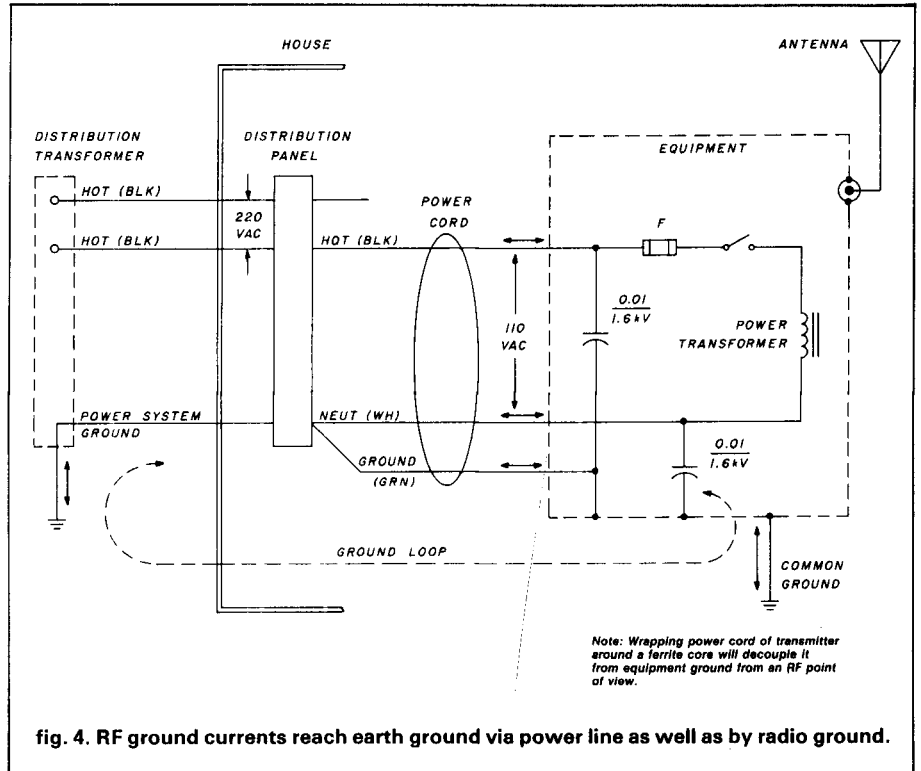

fig. 4. RF ground currents reach earth ground via power line as well as by radio ground.

thus it costs *nothing*. The inductor (L1) is quite small and can take the form of a tapped coil. This arrangement eliminates the expensive high-capacitance variable capacitor required for the popular L-network that most Amateurs use.

The antenna is cut for the high frequency end of the band (2 MHz) and has a passband of about 75 kHz between the 2:1 SWR points. A small series inductor (L2) is added to the antenna to operate it lower in frequency.

So for the price of two inexpensive inductors, it's possible to construct a Marconi antenna that will work at any point in the 160-meter band.

a few words on ground current

The "mirror image" in the ground makes up the missing portion of the Marconi antenna, and power lost in ground resistance is subtracted from the total power. One problem with 160-meter operation is that the antenna is large with respect to the residence and the electric wiring therein, and it's easy to get unwanted coupling into the power lines that

shows up as TVI and RFI in nearby entertainment equipment. (When I first went on 160 meters a few years ago, after a 40-year absence from the band, I was chagrined to find that the ceiling light in the living room lit up every time I transmitted.)

It is not easy to keep ground currents where they belong, since the transmitting equipment is connected directly to the power system ground by means of the power cord (fig. 4). If a radio ground is added to the transmitter, two ground return circuits exist and a ground loop is formed in which high levels of current can flow. This circulating current can show up as mysterious manifestations in nearby radio and TV receivers as they, in turn, may be coupled back into the power system ground.

Since utility companies demand power system grounding, there's not much that can be done about it. The correct approach, therefore, is to isolate the transmitting equipment (from an RF point of view) from the utility ground, which is often located wavelengths away at the main distribution transformer.

ROHN®

brings the top to you

ROHN brings the top to you with its patented design. For the ultimate "on the ground" service and antenna installation, a ROHN "Fold-Over" Tower is your best buy. Your safety comes first with "Fold-Over." For complete details write:

ROHN®

"FOLD-OVER" TOWERS

P.O. BOX 2000, PEORIA, IL 61656 U.S.A.
TWX: 910-652-0646 FAX: 309-697-5612

The solution is to wrap the power cord of the transmitter around a ferrite core, forming an RF choke that isolates the equipment from the utility ground and makes the RF flow to ground via the radio ground attached to the equipment.

While this technique is a *must* for a Marconi antenna, it can also be useful with other antenna types. Regardless of the antenna type you have, if you have RFI problems, try wrapping the power cord of your transmitter (and amplifier, if you use one) around a ferrite rod. Wrap the power cord of the entertainment device around another ferrite rod, too. You might be surprised at how it helps clean up interference.

In my case, I taped two rods together so that the winding form was large enough for the bulky power cord. I got nine turns of line cord around the rods and then tied the power line into position at each end of the core. A recommended rod for the job is the Amidon R-33-075-1200, 12 inches long (30.48 cm) and 3/4-inch (1.90 cm) in diameter. For bands higher than 160 meters, the Amidon R-33-075-750, 7.5 inches (19 cm) long and 1/2-inch (1.27 cm) in diameter, will suffice. (The rods have a permeability of 800.) If a toroidal core is desired, the Amidon FT 240-43 can be used. It is 2.4 inches (6.1 cm) outer diameter and has a permeability of 850.

new list of EME operators

An up-to-date list of all 2-meter EME (moonbounce) operators has been compiled by Lance, WA1JXN. If you would like to have a copy, send a business-size SASE to me at Varian EIMAC, 301 Industrial Way, San Carlos, California 94070, and ask for the "EME List." Please enclose five first-class stamps, or five IRCs, for copying and postage. The list provides calls, addresses, and equipment used at active 2-meter EME stations throughout the world.

references

1. Mark Persons, "Field Service," Radio World, November 1, 1984, page 14.

ham radio

**quality
service
price**



International Crystal Manufacturing Co., Inc.

10 North Lee, P.O. Box 26330, Oklahoma City, OK 73126-0330 (405) 236-3741

CALL US LAST!

We just might beat that "unbeatable" deal



Rudy
N9CC

Talk with everyone else. Then call us. We're hams with over 50 years of combined experience. We know communications and equipment. We also listen to what you want. And at what price. Then we work with you to put it all together.

We specialize in a total systems approach to communications. It's a concept that takes you to the top in operating performance.

Call us. We don't mind being your last chance to save.

We carry all the top names in amateur equipment.

Hours: Tuesday-Saturday, 10 am-6 pm.
Closed Mondays.

800/845-6183
803/366-7157 Inside SC

Service Department
803/366-7158



Ken
N4FYO



Morgan
KB4GFJ



Marji
KA4LPW



C.O.D.



THE
NEW!



GISMO
1039 Latham Drive
Rock Hill, SC 29730



THE ONE NAME YOU NEED TO KNOW IN SOLID STATE POWER AMPLIFIERS ANNOUNCES SEVERAL ADDITIONS TO ITS LINE

All Mode Bipolar Mobile Amplifiers

ALL NEW! Competitively priced!

5123 150 Watt 2 Meter Amplifier. 25 Watts in = 150 + out; 10 in = 90 out. Optional Rx Preamp. **List \$235**

5124 120 Watt 1 1/4 Meter Amplifier. 30 Watts in = 120 out. 10 in = 80 out. Optional Rx Preamp. **List \$240**

5125 100 Watt 70 Cm Amplifier. 30 Watts in = 100 out; 10 in = 40 out. **List \$305**

5121 150 Watt 2 Meter HT Amplifier. 2 Watts in = 150 + out; 1 in = 90 out. Optional Rx Preamp.

List \$285

5122 150 Watt 2 Meter Multi Purpose Amplifier. 10 Watts in = 150 + out; 10 in = 50 out. Optional Rx Preamp.

List \$275

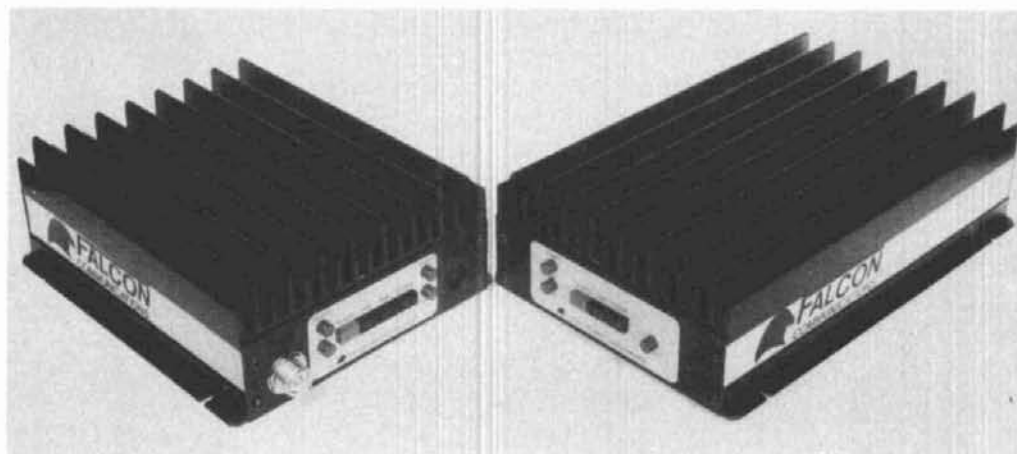

All Mode MOSFET Mobile Amplifiers

An Industry First! Power MOSFETs in American Made Amplifiers

4101 Complete 2 Meter HT Amplifier. 2 Watts in = 25 out; 6 in = 50 out. Regulated power supply, with adj. current limit, for HT power or battery charge. 4 Watt speaker amplifier. Optional Rx Preamp. **List \$215**

4102 Complete 2 Meter HT Amplifier. 2 Watts in = 100 out; 1 in = 80 out. Regulated power supply, with adj. current limit, for HT power or battery charge. 4 Watt speaker amplifier. Optional Rx Preamp. **List \$325**

4103 100 Watt 2 Meter Amplifier. 20 Watts in = 100 out; 10 in = 90 out; 2 in = 30 out. Optional Rx Preamp. **List \$245**

4104 100 Watt 1 1/4 Meter Amplifier. 25 Watts in = 100 out; 10 in = 70 out; 2 in = 25 out. Optional Rx Preamp.

List \$245

4105 100 Watt 2 Meter Amplifier. 2 Watts in = 100 out; 1 in = 80 out. Optional Rx Preamp. **List \$245**

5120 A First in the Amateur Market! 35 Watt 2 Meter Amplifier for aircraft and other 28 Volt applications. 2 Watts in = 35 out; 1 in = 20 out. **NEW! List \$215**

SEE YOUR LOCAL DEALER

MOSFET Base/Repeater Amplifiers

These all mode amplifiers, with the low noise advantages of MOSFETs, require a 13.6 Vdc power source (except as noted). Mounted on an 8 3/4" rack panel with a large heat sink, they are designed for continuous duty at full power output when cooled with a small, customer supplied, fan. Mounting provisions and control thermostat are supplied.

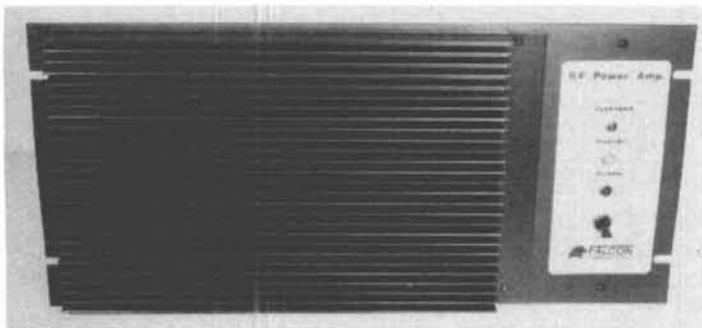

4111 100 Watt 2 Meter Amplifier. 20 Watts in = 100 out; 10 in = 90 out; 2 in = 30 out. **List \$295**

4112 100 Watt 1 1/4 Meter Amplifier. 25 Watts in = 100 out; 10 in = 70 out; 2 in = 25 out. **List \$295**

5113 50 Watt 2 Meter Amplifier. 6 Watts in = 50 out; 2 in = 25 out. No fan needed. **NEW List \$235**

4114 100 Watt 2 Meter Amplifier. 2 Watts in = 100 out; 1 in = 80 out. **List \$365**

5140 35 Watt 2 Meter Amplifier. 2 Watts in = 35 out; 1 in = 20 out. Requires a 28 Vdc supply. No fan needed. **NEW List \$255**

5141 80 Watt 2 Meter Amplifier. 5 Watts in = 80 out; 2 in = 40 out. Requires a 28 Vdc supply. **NEW List \$340**

5142 100 Watt 70 Cm Amplifier. 30 Watts in = 100 out; 10 in = 40 out. Bipolar, not MOSFET. **NEW List \$375**

"Building-Block" Amplifiers

These basic amplifiers, mounted on a 10" x 10" heat sink, are designed for incorporation as part of another piece of equipment. Many amplifiers in this advertisement are available in this form, with various features included, or deleted. Customers supply: cabinetry; cooling air flow, if needed, switches; indicators; control circuitry; etc..

Contact us with your needs.

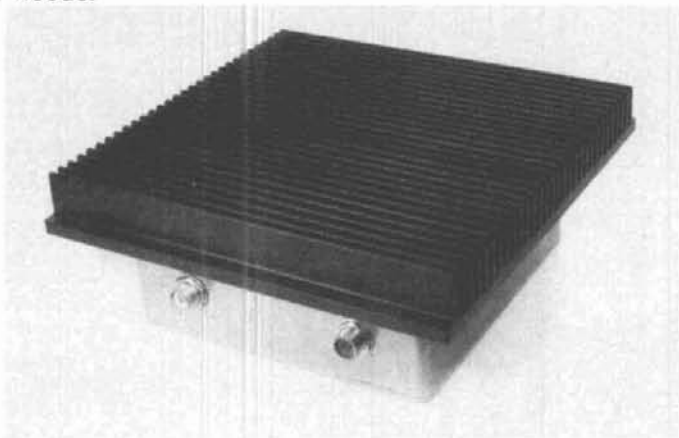

SEE YOUR LOCAL DEALER



(415) 851-8779
P.O. Box 620625
Woodside, CA 94062



the HAM STATION

220 N. Fulton Ave. Evansville, IN 47710



- AEA
- ARRL
- ALLIANCE
- AMECO
- AMERITRON
- AVANTI
- ASTRON
- B & W
- BENCHER
- BUTTERNUT
- COILCO
- CONNECT SYST
- CUSHCRAFT
- DAIWA
- ENCOMM
- HAL
- HUSTLER
- HY-GAIN
- ICOM
- KLM
- KANTRONICS
- KENPRO
- LARSEN
- MFJ
- MIRAGE
- NYE VIKING
- RADIO CALL BOOK
- SHURE
- TEN-TEC
- UNADILLA
- VALOR
- WELZ
- YAESU

Large Stock At Discount Prices—For Orders & Quotes Call 1-800-523-7731

For More Indepth Information & Service Call (812) 422-0252 • Indiana Orders (812) 422-0231

AMERICAN EXPRESS & C.O.D.S Welcome—Freight, F.O.B. Evansville—Prices & Availability Subject to Change

- AEA**
- ATU-1000—Advanced Terminal Unit CALL
- CP-100—DeLuxe Computer Patch CALL
- CP-1—Computer Interface \$189.00
- MP-20 or 64—Interface/Software 149.95
- MAP 64—Interface/Software w/Amtor 199.95
- MP-1—Micropatch CALL
- Doctor Dx Audio/Video Game 99.00
- Isopole 144—Dual Cones 45.00
- Keyers & Trainers in Stock

- ALLIANCE**
- HD-73 10.7 Sq. Ft. Rotator \$99.95
- U-110 Elevation Rotator 49.95

- AMERITRON**
- AL-84—600W Output Amp \$ 399.95
- AL-80—QSK Amp—3-500Z Tube 609.95
- AL-1200 1500W Output 1419.00
- RCS-8 Remote Coax Switch 119.95

- ANTENNA SPECIALISTS (Avanti)**
- AP-153.3G 2M on Glass \$34.00
- AP 450.5G 450 MHZ on Glass 38.00

- ASTRON**
- RS7A 5-7 Amp Power Supply \$ 49.00
- RS10A 7.5-10 Amp Power Supply 59.00
- RS12A 9-12 Amp Power Supply 69.00
- RS20-A 16-20 Amp Power Supply 89.00
- RS20M 16-20 Amp w/meter 109.00
- RS35A 25-35 Amp 135.00
- RS35M 25-35 Amp w/meter 149.00
- RS50A 37-50 Amp 199.00
- RS50M 37-50 Amp w/meter 225.00

- BENCHER**
- BY-1 Paddle/BY-2 Chrome \$39.00/\$49.00
- ZA-1A Balun 19.00

- BUTTERNUT**
- HF6V 80-10M Vertical \$125.00
- HF2V 80/40M Vertical 119.00
- TBR-160-S 160M Resonator 49.00
- RMK-1 I Roof Mount Kit 49.00
- STR-1 I Stub Tuned Radials 29.00

- B & W**
- 370-15 80-10M Folded Dipole \$135.00
- AT-110 5 Band Trap Dipole 76.00
- AT-55 4 Band Trap Dipole 58.00
- CS-3G 3 Pos. Coax Switch 27.25
- CS-6B 6 Pos. Coax Switch 32.00
- CSR-5G 5 Pos. Coax Switch 24.75

- CUSHCRAFT**
- A3 Tribander \$215.00
- A4 Tribander 279.00
- A743/A744 40 Mtr. Kit 75.00
- R3 Motor Tuned Vertical 279.00

- CUSHCRAFT**
- 215WB 2M Wide Band 79.00
- 230WB Stacked 215's 219.00
- 32-19 Boomer 19EL 2M 95.00
- Ringo Rangers 2M, 6M, 220, 450 39.95

- DAIWA**
- CN-520 1.8-60 MHZ Mtr \$ 63.00
- CN-540 50-148 Mhz Mtr 72.00
- CN-550 144-250 Mhz Mtr 81.00
- CN-620B 1.8-150 Mhz Mtr 110.00
- CN-630 140-450 Mhz Mtr 130.00
- CN-720B 1.8-150 Mhz Mtr 129.95
- CS-201 2 Pos. Switch 23.00
- CS-401 4 Pos. Switch 62.00

- DENTRON**
- Clipperton QRO 2KW Amp \$695.00
- GLA 1000C 1KW Amp 399.95
- GLT 1000C Tuner 175.00
- Dummy Load w/Oil 29.95

- ENCOMM—Handhelds in Stock**
- HAL**
- CR1 100/100 Computer Interface \$219.00/265.00

- HEIL—Products in Stock**

- HYGAIN**
- TH7 DXS 7EL Tribander \$439.00
- TH5 MK2S 5EL Tribander 389.00
- Explorer 14 3EL Tribander 309.00
- 205BAS 5EL 20Mtr 349.00
- T2X 20 Sq. Ft. Rotator 269.00
- Ham IV 15 Sq. Ft. Rotator 219.00
- CD-45 8.5 Sq. Ft. Rotator 149.00

- HUSTLER**
- G6-144 2Mtr Vertical \$89.00
- Mobile Resonators in Stock

- ICOM**
- 751 Top of the Line \$1,179.00
- 745 Gen. Cov. Xcvr 769.00
- R71-A General Coverage Rcvr 649.00
- 271A 2M All Mode 599.95
- 271H 2M 100W 749.95
- 290H Mobile All Mode 25W 479.95
- 471A 430-450Mhz 25W 699.95
- 471H 430-450Mhz 75W 949.75
- 27A 2M 25W Mobile 329.00
- 27H 2M 45W Mobile 359.00
- 37A 220Mhz Mobile 299.95
- 47A 440 Mhz Mobile 399.95
- 2AT 2 Mir H.T. 199.95
- 3AT/4AT 220/440 H.T.'s 229.95
- 02AT 2Mtr H.T. 289.95
- 04AT 4Mtz H.T. 319.95

- KDK**
- 2033 25W Mobile \$265.00
- KLM**
- 2M-14C 2Mtr Circular Ant. \$85.00
- 435-18C 440 Circular Ant. 65.00

- MFJ**
- 1229 Interface/Free Software \$159.95
- 1224 Interface/Free Software 85.00
- 1228 Interface/Free Software 62.95
- 989 3KW Roller Inductor Tuner 289.95
- 941D 300W Full Feature Tuner 89.95
- 422 Keyer/Benchler Paddle Combo 99.95
- 313 H.T. Converter 36.00

- MIRAGE**
- B 1016 10/160W—Preamp \$249.95
- B 3016 30/60W—Preamp 204.95
- D 1010N 10/100W 430-450 Mhz 279.95

- NYE**
- MB-V 3KW Deluxe Tuner \$499.00

- SHURE**
- 444D Hi-Low Z Desk Mic \$55.00

- TEN-TEC**
- 560 Corsair \$ 999.95
- 260 P.S./Spkr 170.00
- 263 Vlo 170.00
- 229 2KW Tuner 249.95
- 4229 2 KW Tuner Kit 189.00
- 525D Argosy 525.00
- 2510 Satellite Station 399.95
- Titan—Ultimate Hog 2,175.00

- TOKYO HY-POWER—Amplifiers in Stock**

- YAESU**
- FT980 Deluxe Xcvr \$1,425.00
- FT757 Gen. Cov. Xcvr CALL
- FT757 P.S. w/Fan 175.00
- FC757AT Auto Tuner 235.00
- FT726R Tri-Band Xcvr 779.00
- FT270RH 45W Mobile 379.95
- FT270RH 45W Mobile CALL
- FT203R/TT Pad 229.95
- FT209 RH 2M H.T. 5W 299.95

- WELTZ—Meters in Stock**

CALL FOR PRICES ON EQUIPMENT FOR OSCAR 10

MON-FRI 9AM-6PM • SAT 9AM-3PM

a state-of-the-art electromagnetic jargon generator

The active field discriminator circuit presented in this article operates on the principle of balanced product isolation. Signals from the electromagnetic vector multiplier and one parasitic signal coupler are combined with the output of an external harmonic amplitude detector. The resulting waveform is routed through the isotropic polarization generator for processing, before being applied at the output to drive an orthogonal distortion filter. (See block diagram, fig. 3). Possible applications include circular wave oscillator adjustment, as well as optimized linear frequency amplification.

Impressive, isn't it? The above paragraph from one of my previous articles generated considerable excitement in the technical community, inspired two doctoral dissertations, and ultimately led to the Nobel Prize in Linguistic Obfuscation. But now the secret is revealed: the text above, along with all the rest of my previous technical articles, was generated by a computer. And here, for the first time in print, I reveal the secret of my literary success.

The technique upon which the state-of-the-art electromagnetic jargon generator is based was pioneered by social scientists, perfected by government employees, and has long been the mainstay of the legal profession. It involves no more than generating lists of appropriate buzzwords and catch phrases and com-

bining them in a more or less random manner to produce a desired effect. Frequently three separate columns of words are supplied; thus, creating a ponderous technical term becomes no more complex than ordering dinner in a Chinese restaurant. Simply choose an adjective from Column A; a noun from Column B; and a noun from Column C. Add a fortune cookie ("You will meet an attractive stranger and be disappointed . . .") and a cup of hot tea, and you're ready to go. The result is the generation of phrases that sound important but mean absolutely nothing!

origin of the specious

Jim Buss, formerly KØQWI, provided the inspiration for this article. As a technical manager at the NASA Johnson Space Center in Houston, Jim generates reams of paperwork daily, including such classic phrases as: Integrated Management Options (IMO), Total Organizational Flexibility (TOF), and Systematized Policy Projection (SPP). Why not, he suggested, apply his literary technique to the fields of microwave and electronic communications?

Why not, indeed? **Table 1** contains a three-column "starter list" of words judiciously selected to meet your technical jargon requirements. Mix and match at will. By changing the suffix of the words in Column C (such as "generator" to "generation"), you can create grammatically correct terms guaranteed to fit practically anywhere in a sentence. To automate this process, I have provided, in **table 2**, a BASIC program listing designed to generate up to 1000 unique terms. How's that for Parasitic Distortion Generation?

Remember, Electromagnetic Wave Isolation requires the use of active phase detectors in combination with at least one elliptical polarization coupler to result in a harmonic vector discriminator of unparallelled quality. Now, reread all of my previous *ham radio* articles¹⁻¹⁹ and see how many of these terms you recognize!

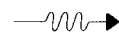

table 1. "Starter list" of technical terms selected by author for optimal obfuscation potential.

column A	column B	column C
linear	wave	amplifier
circular	frequency	oscillator
elliptical	phase	mixer
orthogonal	distortion	filter
isotropic	polarization	detector
harmonic	amplitude	coupler
parasitic	signal	generator
electromagnetic	vector	multiplier
balanced	product	isolator
active	field	discriminator

By H. Paul Shuch, N6TX, 14908 Sandy Lane, San Jose, California 95124

table 2. Microsoft™ BASIC program facilities generation of up to 1000 incomprehensible technical terms.*

```

10 -----> JARGON.BAS <-----
20     Rev. A, 13 Aug '84
30     by N6TX
40     COPYRIGHT (C) 1984 MICROCOMM
50
60     Generates totally meaningless combinations
70     of Microwave/Electronics buzzwords!
80
90 -----
100 CLR$ = CHR$(26) ' Defines Clear-Screen String
110 PRINT CLR$
120 PRINT "DO YOU WISH OUTPUT ROUTED TO:"
130 PRINT
140 PRINT "                PRINTER (P)"
150 INPUT "                or SCREEN (S)";PR$
160 IF PR$="P" OR PR$="p" OR PR$="S" OR PR$="s" GOTO 200
170 PRINT CLR$
180 PRINT "YOU MUST RESPOND WITH 'P' OR 'S' : PRINT
190 GOTO 120
200 -----
210 PRINT CLR$
220     Random Number Seed entered here
230 PRINT "JARGON.BAS generates random combinations of"
240 PRINT "Microwave/Electronics buzzwords, for inclusion"
250 PRINT "in technical manuscripts."
260 PRINT
270 PRINT "To start the randomization process, it will be"
280 PRINT "necessary to enter a Seed Number."
290 PRINT
300 INPUT "ENTER ANY NUMBER HERE: ",S
310 RANDOMIZE (S)
400 -----
410 PRINT CLR$
420 INPUT "How many technical terms do you wish to generate";N
430 IF N>0 GOTO 460
440 PRINT : PRINT "number entered must be greater than 1."
450 GOTO 420
460 IF N = INT(N) GOTO 490
470 PRINT : PRINT "number entered must be an integer."
480 GOTO 420
490 PRINT CLR$
500 -----
510     ARRAY LISTED HERE
520 DIM A$(10,3)
530 A$(0,0) = "LINEAR": A$(0,1) = "WAVE": A$(0,2) = "AMPLIFIER"
540 A$(1,0) = "CIRCULAR": A$(1,1) = "FREQUENCY": A$(1,2) = "OSCILLATOR"
550 A$(2,0) = "ELLIPTICAL": A$(2,1) = "PHASE": A$(2,2) = "MIXER"
560 A$(3,0) = "ORTHOGINAL": A$(3,1) = "DISTORTION": A$(3,2) = "FILTER"
570 A$(4,0) = "ISOTROPIC": A$(4,1) = "POLARIZATION": A$(4,2) = "DETECTOR"
580 A$(5,0) = "HARMONIC": A$(5,1) = "AMPLITUDE": A$(5,2) = "COUPLER"
590 A$(6,0) = "PARASITIC": A$(6,1) = "SIGNAL": A$(6,2) = "GENERATOR"
600 A$(7,0) = "ELECTROMAGNETIC": A$(7,1) = "VECTOR": A$(7,2) = "MULTIPLIER"
610 A$(8,0) = "BALANCED": A$(8,1) = "PRODUCT": A$(8,2) = "ISOLATOR"
620 A$(9,0) = "ACTIVE": A$(9,1) = "FIELD": A$(9,2) = "DISCRIMINATOR"
630 -----
640     PRINT HEADER
650 IF PR$ = "S" OR PR$ = "s" THEN 700
660 LPRINT "ELECTROMAGNETIC JARGON BY MICROCOMM"
670 LPRINT "-----"
680 LPRINT
700 -----
710     START LOOP HERE
715 PRINT CLR$
720 FOR I = 1 TO N
730     GENERATE RANDOM 3-DIGIT NUMBER
740 X = INT (RND * 1000)
750 A = INT (X / 100)
760 B = INT (X / 10) - (10 * A)
770 C = X - (100 * A) - (10 * B)
780 PRINT A$(A,0);TAB(17);A$(B,1);TAB(34);A$(C,2)
1000
1010 IF PR$ = "S" OR PR$ = "s" THEN 1030
1020 LPRINT A$(A,0);TAB(20);A$(B,1);TAB(40);A$(C,2)
1030 -----
1040 NEXT I
1050 PRINT : PRINT
1060 IF PR$ = "S" OR PR$ = "s" THEN 1100
1070 LPRINT : LPRINT
1080 LPRINT : LPRINT
1090
1100 INPUT "TYPE <return> TO CONTINUE, 'Q' TO QUIT ",D$
1110 IF D$ = "Q" OR D$ = "q" THEN GOTO 1130
1120 GOTO 630
1130 END

```

*This program is also available for the Apple IIE. Send SASE.

references

1. H. Paul Shuch, WA6UAM, "Easy-to-build SSB Transceiver for 1296 MHz," *ham radio*, September, 1974, page 8.
2. H. Paul Shuch, WA6UAM, "Microstripline Preampifiers for 1296 MHz," *ham radio*, April, 1975, page 12.
3. H. Paul Shuch, WA6UAM, "How to Use Double-balanced Mixers on 1296 MHz," *ham radio*, July, 1975, page 8.
4. H. Paul Shuch, WA6UAM, "Low-cost 1296 MHz Preampifier," *ham radio*, October, 1975, page 42.
5. H. Paul Shuch, WA6UAM, "Microstripline Bandpass Filters for 1296 MHz," *ham radio*, December, 1975, page 46.
6. H. Paul Shuch, WA6UAM, "Vestigial Sideband Microtransmitter for Amateur Television," *ham radio*, February, 1976, page 20.
7. H. Paul Shuch, WA6UAM, "Solid-state Microwave Amplifier Design," *ham radio*, October, 1976, page 40.
8. H. Paul Shuch, WA6UAM, "Interstage 50-ohm Terminator for VHF Converters," *ham radio*, February, 1977, page 26.
9. H. Paul Shuch, WA6UAM, "Rat-race Balanced Mixer for 1296 MHz," *ham radio*, July, 1977, page 33.
10. H. Paul Shuch, WA6UAM, "Microwave Spectrum Analyzer," *ham radio*, August, 1977, page 54.
11. H. Paul Shuch, WA6UAM, "Circuit Packaging for Double-balanced Mixers," *ham radio*, September, 1977, page 41.
12. H. Paul Shuch, N6TX, "Calculating Preampifier Gain from Noise-figure Measurements," *ham radio*, November, 1977, page 30.
13. H. Paul Shuch, N6TX, "Calculating Antenna Bearings for Geostationary Satellites," *ham radio*, May, 1978, page 67.
14. H. Paul Shuch, N6TX, "Pseudo-Logarithmic Displays for the Microwave Spectrum Analyzer," *ham radio*, July, 1978, page 34.
15. H. Paul Shuch, N6TX, "Improved Grounding for the 1296 MHz Microstrip Filter," *ham radio*, August, 1978, page 60.
16. H. Paul Shuch, N6TX, "UHF Local-oscillator Chain for the Purist" *ham radio*, July, 1979, page 27.
17. H. Paul Shuch, N6TX, "Compact and Clean L-band Local Oscillators," *ham radio*, December, 1979, page 40.
18. H. Paul Shuch, N6TX, "Quiet! Preamp at Work." *ham radio*, November, 1984, page 14.
19. H. Paul Shuch, N6TX, "Electromagnetic Jargon Generator," *ham radio*, April, 1985, page 75.

ham radio

SHORT CIRCUIT HOTLINE



Building a current *ham radio* project? Call the Short Circuit Hotline any time between 9 AM and Noon, or 1 to 3 PM — Eastern time — before you begin construction. We'll let you know of any changes or corrections that should be made to the article describing your project.
(See "Publisher's Log," April, 1984, page 6, for details.)

603-878-1441

SOFTWARE

IBM-PC COMPATIBLE	IBM PC COMPATIBLE	COMMODORE COMPUTER
ALPHA SOFTWARE Electric Desk 235.00 Electric Desk Jr. 225.00 Data Base Manager II 205.00 ESP 495.00 Executive Package 75.00 Typefaces 75.00 Apple-IBM Connection 175.00	IMSI PC Paintbrush 99.00 PC Paintbrush w/Microsoft Mouse 235.00 4 Point Graphics 150.00	All titles 20% to 30% discount DATA TRANSFORMS Fontrix 1.2 60.00 Fontpake 1-9 ea. 18.00
ARTIFICIAL INTELLIGENCE ELIZA with source code 35.00	MULTIMATE INT'L MultiMate-New Version Free Keyboard Template 319.00	PEACHTREE 25% discount all titles
BORLAND Sidekick-unprotect 68.00 Sidekick-protected 40.00 Turbo Pascal 40.00 Turbo Toolbox 40.00 Turbo Tutor 24.00 Turbo 8087 70.00 GiftPak-3pc. 80.00 GiftPak-4pc. 110.00	PAL SOFTWARE Artpak 69.00 Artpak Picture Disks 40.00	SIR TECH Wizardry-all titles 20% discount
DATA TRANSFORMS Fontrix 2.0 100.00 Fontpaks 1-9ea. 18.00	PRENTICE HALL Execuvision VCN 295.00 Execuvision Library From 64.00 Lumen Fin. Planner 155.00 Lumen Fin. Manager 155.00 Lumen Professional 499.00 General Accounting 395.00 Accounts Receivable 495.00 Accounts Payable 495.00 Business Word Processing 195.00 Neat-Info and Time Manager 99.00 Master Menu 18.00	DAYSTAR Trivia Game 20.00 Showtime Trivia 20.00 Sports Trivia 20.00 Americana Trivia 20.00 Music Trivia 20.00 States Trivia 30.00 Presidents Trivia 30.00 U.S. History Trivia 30.00
DAYSTAR Trivia Game 20.00 Showtime Trivia 20.00 Sports Trivia 20.00 Americana Trivia 20.00 Music Trivia 20.00 States Trivia 30.00 Presidents Trivia 30.00 U.S. History Trivia 30.00	SATELLITE SOFTWARE Word Perfect-New Vision 290.00 Personal Word Perfect 145.00 Word Perfect Jr. 50.00 Word Perfect Sorter 75.00 Math Plan Jr. 50.00 SSI Date Base 145.00	RANDOM HOUSE all educational Snoopy and Peanuts titles 20% discount
PEACHTREE 25% discount all titles Quint Data Base Systems Qint-SQL Call for prices	SIMON & SCHUSTER Typing Tutor III 30.00	SIMON & SCHUSTER Typing Tutor III Macintosh 40.00
PHARMACY SYSTEMS MANAGEMENT From 1250.00	SIR TECH Wizardry-Proving Grounds 40.00	RADIO SHACK COLOR COMPUTER Games Word Processing Spreadsheets Data Base Business Software Monitors Disk Drives Upgrades Repairs Educational Printers Art and Graphic
OTHER 20% discount or more on all popular titles. Special Orders taken		

HARDWARE

<p>ThinPrint® 80</p>  <p>Battery-Operated Portable Silent Thermal Printer</p> <ul style="list-style-type: none"> Built-in rechargeable batteries 40 cps bidirectional printing 2048 character buffer memory Silent thermal printing Built-in parallel interface, supports most computers High resolution graphics. Graphic Screen print routines are available for M100, Macintosh etc. <p>Reg. 319.00 199⁰⁰</p> <p>MONITORS</p> <p>12" GREEN 99⁹⁵ 13" COMPOSITE COLOR 249⁹⁵ 12" AMBER 109⁹⁵ RGB-COLOR 479⁹⁵</p>	<p>Thin Type 80</p>  <p>Battery-Operated Portable Letter Quality Impact Printer</p> <ul style="list-style-type: none"> True letter quality impact printing Compact, light-weight, versatility Internal rechargeable batteries 15 cps bidirectional printing Low cost replaceable ink roll provides over 2 million characters Internal A/C adapter/charger Auto power-down/up modes <p>Reg. 395.00 299⁰⁰</p> <p>PRINTERS</p> <p>OKIDATA 92-IBM 489⁰⁰ OKIDATA 84-IBM 779⁰⁰ OKIDATA 93-IBM 699⁰⁰ GEMINI 10X 289⁰⁰</p>
---	--



SOFTWARE CONNECTION



4301 N. State Rd. #7 • Lauderdale Lakes, FL 33319

(Oakland Shopping Plaza Near Radio Shack Computer Center)

305-484-7547

ASK ABOUT
FINANCE PLAN

Not Responsible For
Typographical Errors

HOURS

MON.-THURS., SAT. 9 A.M.-6 P.M.
FRIDAY 9 A.M.-7 P.M.

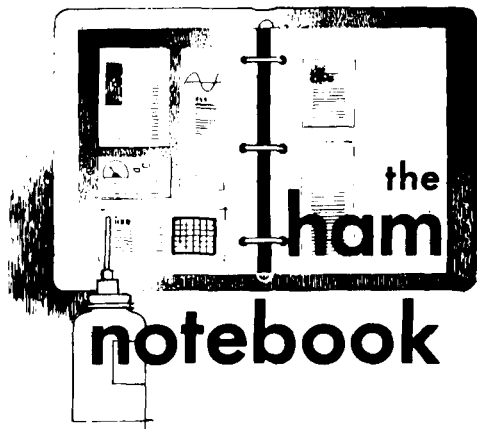

improved carrier suppression for the MC1496

The MC1496 has been around for many years and has enjoyed widespread popularity in many balanced modulator design applications. Recently, while attempting to build a 50-MHz DSB generator using this device, I came across several small circuit improvements that will increase the carrier suppression levels, especially at the higher frequencies.

The first improvement involves the use of a bifilar wound toroidal tank circuit that takes advantage of the inherent self-balance of the bifilar windings, yielding a noticeable improvement in carrier feedthrough. In addition, by feeding the signal into the center tap of the bifilar winding through a series choke arrangement, the windings are isolated from unbalanced ground effects.

Normally carrier balance is set through a DC biasing adjustment using a trim pot. The addition of two small-value trimmer capacitors from each side of the MC1496 output pins to ground substantially improves carrier suppression by allowing further balance of the RF tank circuit. If interaction occurs, some readjustments may be necessary for optimum results.

Finally, while the recommended carrier injection level is 60 mV RMS, I found that by varying the LO drive slightly above or below this level often offered improved carrier suppression levels. Any variation in drive level, at

50 MHz, will upset the circuit balance and require further carrier balance readjustments.

While these changes apply to the MC1496 at 50 MHz, one may wish to try similar modifications, at lower frequencies, to improve the expected level of performance from this device. It is likely that these techniques could be applied to the SN76514 and SL6440 IC mixer devices.

Peter Bertini, K1ZJH

bulkhead connector

The type 83 bulkhead connector (83-1F) is useful as a panel-mounted coax feedthrough; however, these fittings are expensive and are available to most hams only through mail order. The PL258 (83-1J) double-female connector is inexpensive and is carried by

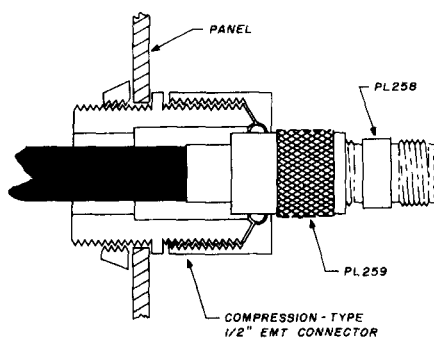

fig. 1. Cross-section of homemade bulkhead connector.

Radio Shack stores, but it has no provision for panel mounting and attempts to solder a flange to it invariably result in melted polystyrene dielectric. A weekend project can be thwarted by the lack of a suitable fitting.

A satisfactory, if not aesthetically perfect substitute for the 83-1F will provide mechanical stability and can be assembled from locally-available parts. The outside diameter of the coupling ring of a PL259 (83-1SP) is nearly the same as that of 1/2" EMT electrical conduit. Half-inch EMT fittings are available at most hardware stores. A compression-type 1/2-inch EMT junction box connector will grip a PL259/PL258 pair to form a sturdy

panel-mount coax connector, as shown in cross-section in fig. 1. It is only necessary to remember to slide the EMT connector onto the cable *before* installing the PL259.

Gary Myers, K9CZB

Midway Amateur Radio Club assumes management of North American TRN

The Midway Amateur Radio Club of Kearney, Nebraska, now sponsors the North American Teleconference Radio Net (TRN). TRN links together over 150 gateway stations (mostly VHF/UHF repeaters) across the US and Canada to present high quality technical and informational programs of interest to Radio Amateurs. Past speakers on TRN have included Vic Clark, W4KFC, and Senator Barry Goldwater, K7UGA.

The idea for TRN began with Ed Piller, W2KPO, and Charlie Kosman, WB2NQV. In the early 1980's Ed and Charlie began linking repeaters by telephone to provide technical presentations as a joint project of the Long Island Mobile Amateur Radio Corps (LIMARC) and the Long Island Chapter of IEEE. However, with the telephone bridging equipment available to them, it was difficult to provide high quality audio to and from all participating repeaters. In late 1982 Rick Whiting, W0TN, a telecommunications engineer, became net manager. Rick made arrangements with Lou Appel, K0IUQ, of Darome, Inc., to use Darome's sophisticated multipoint teleconference bridges to provide the "land line" links for repeaters. The result was superb audio quality and a rapid growth in the number and distribution of gateway stations in the net. Lou will continue to be the bridge engineer in TRNs under the new net manager.

Requests for TRN information should be sent to TRN Manager, c/o Midway Amateur Radio Club, P.O. Box 1231, Kearney, Nebraska 68847-1231. (SASE please, Canada excepted.)

ham radio

ATU-1000™ **NEW!**

Advanced Terminal Unit



More Hardware Features And Performance Than Any Other Morse, Baudot, ASCII, AMTOR, SITOR, or H.F. Packet Terminal Unit Anywhere At Any Price!

We recognize that there are few amateurs who can appreciate or afford the outstanding value of the ATU-1000, but those who can are in for some very pleasurable operating. The ATU-1000 is a commercial/military unit with all the performance and flexibility that is attainable from today's technology. Just check out the features below.

- 32 poles, active filtering
- Morse/Baudot/ASCII/AMTOR/SITOR/H.F. Packet
- Set receive filters to one Hz accuracy
- Set receive MARK & SPACE filters independently from 1000 to 3000 Hz
- All shifts, 170 Hz fixed or 0 to 2000 Hz adjustable
- Set AFSK output tones independently from 1000 to 3000 Hz to one Hz
- 5mV to 5V AGC
- Front-panel squelch control
- Built-in 4 digit counter
- CW filter adjustable 700 to 2500 Hz
- D.C. coupled automatic threshold correction
- Twin full-wave detectors
- Built-in TTL/RS-232/and loop keyer I/O
- Discriminator-type tuning indicator
- FSK, AFSK, and scope outputs
- 13 VDC operation, 110 VAC adaptor supplied
- TTL I/O logic inversion for use with virtually any software
- Optional 19 inch rack mount kit

Ask your favorite dealer for a demonstration of the world's finest RTTY/CW advanced terminal unit/computer interface—the AEA model ATU-1000. If you cannot see your dealer, send for our latest specification sheet.

*Prices & Specifications Subject To Change
Without Notice Or Obligation.*

Advanced Electronic Applications, Inc.
P.O. BOX C-2160 • LYNNWOOD, WA 98036
(206) 775-7373 • TELEX: 152571 AEA INTL



**Brings you the
Breakthrough!**

COMMUNICATIONS EQUIPMENT SALE!

ICOM



ICOM IC-751A LIST PRICE \$1399
CALL FOR SPECIAL SALE PRICE!



ICOM IC-745 LIST PRICE \$999
CALL FOR SPECIAL SALE PRICE!



IC-27A, IC-27H,
IC-37A, IC-47A
All Now Available
Call For Special Sale Prices!
Save \$\$\$!



IC-271A/H 2 mtrs
IC-471A 70 cm
Perfect Oscar Equipment
Call For Special Prices!



IC-02AT
New 2m HT

Call!
For Your
Special
Price!

KENWOOD



TS-930S LIST PRICE \$1799
CALL FOR SPECIAL SALE PRICE!



TS-430S LIST PRICE \$899.95
CALL FOR SPECIAL SALE PRICE!



TW-4000A
With FREE VSI Voice
Synthesizer and MA-4000
Dual-Band Antenna
Only \$599.95 Save \$85



TM-211A/411A
25 Watt FM Mobile
Call For Your Special Price



TR-2600
NEW!
High Tech
Compact 2mtr HT
Now In Stock!
Call For Your Very
Special Price



FT-757GX LIST PRICE \$829
CALL FOR SPECIAL SALE PRICE!



FT-726R LIST PRICE \$829
CALL FOR SPECIAL SALE PRICE!



FT-209RH
NEW High Tech
2mtr HT
5 Watt Output
NOW IN STOCK
CALL FOR YOUR
SPECIAL PRICE

TEN-TEC
SALE!



CORSAIR List \$1169
SALE PRICE \$999!

NEW 3KW Amplifier
Model 425 Titan
List \$2495
CALL FOR SPECIAL PRICE



TEN-TEC
New 2M HT
Full Featured!
List \$319
Sale \$279.95!
4229 2KW Tuner Kit \$189.95!

SANTEC



ST142 2m H.T.\$249
ST222 220 MHz H.T.\$279
ST442 440 MHz H.T.\$289
LS202 2m SSB/FM H.T.\$229

KDK FM2033
List \$339.95 Sale \$299.95



TOKYO HY-POWER AMPLIFIERS
HL30V 2m Amp 2-30 FM 59.95
HL32V 2m all-mode Amp 2-30 75.00
HL82V 2m Amp & Preamp 10-80 139.95
HL160V 2m Amp & Preamp 2/10-160 288.95
HL20U 440-450 MHz Amp 2-20 98.95
HL90U 430-440 MHz Amp 10-90 319.00

MIRAGE AMPLIFIER
SALE!



B1016
\$249

Model	Band	Pre-amp	Input	Output	DC Pwr	Sale Price
A1015	6M	Yes	10W	150W	20A	\$249
B23	2M	No	2W	30W	5A	\$79
B215	2M	Yes	2W	150W	22A	\$259
B108	2M	Yes	10W	80W	10A	\$159
B1016	2M	Yes	10W	160W	20A	\$249
B3016	2M	Yes	30W	160W	17A	\$199
C22	220	No	2W	20W	5A	\$79
C106	220	Yes	10W	50W	10A	\$179
C1072	220	Yes	10W	120W	20A	\$259
D24	440	No	2W	40W	8A	\$179
D1010N	440	No	10W	100W	20A	\$289

RC-1 Remote Control for Mirage Amplifiers \$24
MP-1 and MP-2 Peak Reading Wattmeter \$99

ASTRON POWER SUPPLIES

Heavy Duty - High Quality - Rugged - Reliable
• Input Voltage: 105-125 VAC Output: 13.8 VDC ± 0.5V
• Fully Electronically Regulated - 5mV Maximum Ripple
• Current Limiting & Crowbar Protection Circuits
• M-Series With Meter - A-Series Without Meter

Model	Cont. Amps	ICS Amps	Price
RS4A	3	4	\$39
RS7A	5	7	\$49
RS12A	9	12	\$69
RS20A	16	20	\$89
RS20M	16	20	109
RS35A	25	35	135
RS35M	25	35	149
RS50A	37	50	199
RS50M	37	50	229



MODEL RS-50A

HAL SALE!
NEW RTTY/CW COMPUTER
INTERFACES



CRI-100 List \$249 SALE \$229.95!
CRI-200 List \$299 SALE \$269.95!

CWR6850
RTTY/CW
TERMINAL



List \$999 SALE \$749.95!

Other HAL Products On Sale

CWR6700	\$269.00	DS3100ASR	\$1699.00
CT2100 Upgrade Kit	95.00	MP73100	2199.00
CT2200R/RS2100	949.00	RS2100	299.00
DSK3100	999.00	ST5000	279.00
ARG1000	849.00	ST6000	839.00



CP-1 COMPUTER PATCH
List \$239.95 SALE \$189.95!

CP1-20\$219 CP1-64\$219
MP-20\$129 MP-64\$129
VIC-20 MBA Text \$79 C-64 MBA Text...\$79
All AEA Keyers, Antennas & Accessories
In Stock!



MFJ 1224 COMPUTER INTERFACE \$89.95

202B Noise Bridge\$59.95
250 2KW Oil Load\$35.95
422 Keyer/Paddle\$89.95
901 300W Tuner\$59.95
941C 300 W Tuner\$89.95
989 Deluxe 2KW\$299.95

Kantronics

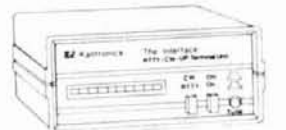

The Interface Reg. \$169.95 Sale \$129.95
The Interface II Reg. \$269.95 Sale \$239.95

Apple Amtor
Soft/Hamtext...\$139 VIC-20 Hamsoft49
VIC-20 Amtor Soft...89 Hamtext VIC-2099
Model 64 Hamtext Model-64...99
Amtor Soft89 Atari Hamsoft49
Apple Hamsoft29 TRS-80C Hamsoft...59



TEXAS TOWERS

Div. of Texas RF Distributors Inc. 1108 Summit Ave., Suite 4 • Plano, Texas 75074

Monday-Friday 9 AM - 5 PM Saturday 9 AM - 1 PM

Telephone
(214) 422-7306

here is the next generation Repeater

MARK 4CR

The **only** repeaters and controllers with REAL SPEECH!

No other repeaters or controllers match Mark 4 in capability and features. That's why Mark 4 is the performance leader at amateur and commercial repeater sites around the world. Only Mark 4 gives you Message Master™ real speech • voice readout of received signal strength, deviation, and frequency error • 4-channel receiver voting • clock time announcements and function control • 7-helical filter receiver • extensive phone patch functions. Unlike others, Mark 4 even includes power supply and a handsome cabinet.

Create messages just by talking. Speak any phrases or words in any languages or dialect and *your own voice* is stored instantly in solid-state memory. Perfect for emergency warnings, club news bulletins, and DX alerts. Create unique ID and tail messages, and the ultimate in a real speech user mailbox — only with a Mark 4.

Call or write for specifications on the repeater, controller, and receiver winners.



SEE US AT DAYTON
BOOTHS 225, 226 & 227



MICRO CONTROL SPECIALTIES

Division of Kendecom Inc.

23 Elm Park, Groveland, MA 01834 (617) 372-3442

TOWERS by ALUMA

HIGHEST QUALITY
ALUMINUM

- TELESCOPING (CRANK-UP)
- GUYED (STACK-UP)
- TILT-OVER MODELS

Easy to install. Low Prices.
Crank-ups to 100 ft.

EXCELLENT FOR
AMATEUR COMMUNICATIONS



Mobile
Trailer
Type



Mobile
Truck
Type

Over 36 types aluminum
and steel towers made—
specials designed and
made—write for details

SPECIAL
Four Section 50 Ft.
Van Mounted Crank-Up
Aluma Tower



Fixed Base

ALUMA TOWER CO.

BOX 2806HR
VERO BEACH, FLA. 32960-2806
(305) 567-3423 TELEX 80-3405

✓ 141

A.R.E. COMMUNICATIONS OF LONDON

- BUY UK HAM RADIO PRODUCTS DIRECT FROM ENGLAND
- TAKE ADVANTAGE OF DOLLAR/POUND EXCHANGE RATE
- MICROWAVE MODULES/MUTEK/DATONG ALL AVAILABLE FROM STOCK AT PRICES 50% BELOW U.S. DEALER PRICES

MUTEK TRANSVERTER

2m IN 6m OUT AT 10w **\$199**
PLUS ALL OTHER MODELS AVAILABLE

MICROWAVE MODULES — FULL RANGE AVAILABLE TRANSVERTERS

146 - 432 **\$219**
28 - 432 **\$194**
28 - 146 25w OUTPUT **\$235**
146 - 1296 **\$256**

DATONG - FULL RANGE AVAILABLE

FL3 DELUXE AUDIO FILTER **\$146**
SRB2 WOODPECKER BLANKER **\$100**

ALL PRICES INCLUDE CARRIAGE TO USA
ORDERS BY ACCESS/EUROCARD/VISA

PHONE: LONDON 992 9142

TELEX 946240 (CW EASY G)

Ref 19005275

WRITE:

A.R.E. COMMUNICATIONS LTD.

38 BRIDGE STREET, EARLESTOWN

NEWTON-LE-WILLOWS

MERSEYSIDE WA12 9BA, ENGLAND

✓ 143



July 27 thru Aug. 9, 1985

Our 26th year

TAKE A VACATION WITH A PURPOSE THIS YEAR

Join students from around the world at
OAK HILL ACADEMY
AMATEUR RADIO SESSION
Instructors CERTIFIED VE's

Over 25 years of successful teaching experience
means upgrading is as easy as 1-2-3.

Your vacation is spent in the beautiful Blue
Ridge Mountains of Virginia with expert in-
structors in friendly surroundings and with ex-
cellent accommodations.

Oak Hill also has a ham lab set up for all to use.

Courses offered are:

- Novice to General
- General or Tech to Advanced
- Advanced to Extra

Learn — don't just memorize the answers to
the exam questions.

C. L. PETERS, K4DNJ, Director
Oak Hill Academy Amateur Radio Session
Box 43
Mouth of Wilson, VA 24363

Name _____ Call _____

Address _____

City/State/Zip _____

ASTRON POWER SUPPLIES

• HEAVY DUTY • HIGH QUALITY • RUGGED • RELIABLE •

RS and VS SERIES

SPECIAL FEATURES

- SOLID STATE ELECTRONICALLY REGULATED
- FOLD-BACK CURRENT LIMITING Protects Power Supply from excessive current & continuous shorted output.
- CROWBAR OVER VOLTAGE PROTECTION on all Models except RS-4A.
- MAINTAIN REGULATION & LOW RIPPLE at low line input Voltage.
- HEAVY DUTY HEAT SINK • CHASSIS MOUNT FUSE
- THREE CONDUCTOR POWER CORD
- ONE YEAR WARRANTY • MADE IN U.S.A.

PERFORMANCE SPECIFICATIONS

- INPUT VOLTAGE: 105 - 125 VAC
- OUTPUT VOLTAGE: 13.8 VDC ± 0.05 volts (Internally Adjustable: 11-15 VDC)
- RIPPLE: Less than 5mv peak to peak (full load & low line)

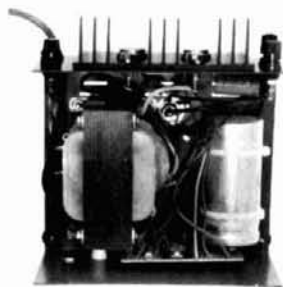

INSIDE VIEW - RS-12A



MODEL RS-50A



MODEL RS-50M



MODEL VS-50M

RM-A Series



MODEL RM-35A

19" X 5 1/2" RACK MOUNT POWER SUPPLIES

Model	Continuous Duty (AMPS)	ICS* (AMPS)	Size (IN) HxWxD	Shipping Wt. (lbs.)
RM-35A	25	35	5 1/4 x 19 x 12 1/2	38
RM-50A	37	50	5 1/4 x 19 x 12 1/2	50

RS-A SERIES



MODEL RS-7A

MODEL	Continuous Duty (Amps)	ICS* (Amps)	Size (IN) H x W x D	Shipping Wt (lbs)
RS-4A	3	4	3 3/4 x 6 1/2 x 9	5
RS-7A	5	7	3 3/4 x 6 1/2 x 9	9
RS-7B	5	7	4 x 7 1/2 x 10 3/4	10
RS-10A	7.5	10	4 x 7 1/2 x 10 3/4	11
RS-12A	9	12	4 1/2 x 8 x 9	13
RS-20A	16	20	5 x 9 x 10 1/2	18
RS-35A	25	35	5 x 11 x 11	27
RS-50A	37	50	6 x 13 3/4 x 11	46

RS-M SERIES



MODEL RS-35M

- Switchable volt and Amp meter

MODEL	Continuous Duty (Amps)	ICS* (Amps)	Size (IN) H x W x D	Shipping Wt (lbs)
RS-12M	9	12	4 1/2 x 8 x 9	13
RS-20M	16	20	5 x 9 x 10 1/2	18
RS-35M	25	35	5 x 11 x 11	27
RS-50M	37	50	6 x 13 3/4 x 11	46

VS-M SERIES



MODEL VS-20M

- Separate Volt and Amp Meters
- Output Voltage adjustable from 2-15 volts
- Current limit adjustable from 1.5 amps to Full Load

MODEL	Continuous Duty (Amps) @ 13.8VDC @ 10VDC @ 5VDC	ICS* (Amps) @ 13.8V	Size (IN) H x W x D	Shipping Wt (lbs)
VS-20M	16 9 4	20	5 x 9 x 10 1/2	20
VS-35M	25 15 7	35	5 x 11 x 11	29
VS-50M	37 22 10	50	6 x 13 3/4 x 11	46

RS-S SERIES



MODEL RS-12S

- Built in speaker

MODEL	Continous Duty (Amps)	ICS* Amps	Size (IN) H x W x D	Shipping Wt (lbs)
RS-7S	5	7	4 x 7 1/2 x 10 3/4	10
RS-10S	7.5	10	4 x 7 1/2 x 10 3/4	12
RS-10L(For LTR)	7.5	10	4 x 9 x 13	13
RS-12S	9	12	4 1/2 x 8 x 9	13
RS-20S	16	20	5 x 9 x 10 1/2	18

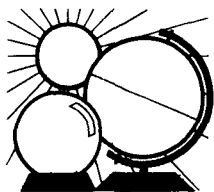

DX FORECASTER

Garth Stonehocker, KØRYW

sunspot cycle views

In the October, 1984, *DX Forecaster* we discussed the present 10.7-year sunspot cycle. How accurate were our six-month predictions?

The solar flux dropped even lower than the minimum forecast for August as a result of an almost non-existent 27-day cycle variation (i.e., a nearly spotless sun) from mid-September to mid-November. October had the year's lowest recorded monthly solar flux — 74. The minimum daily value of flux so far in sunspot cycle 21 was 69 on September 29. Since October, both flux and activity have increased, approaching the February-March annual maximum of approximately 90 flux units (36 SSN).

Expect the flux to decrease toward an annual minimum during the months of July, August, and September. Expect the *daily* flux to drop down near the previously recorded low of 67 (August 25, 1954) during the summer 1986 or 1987. The sunspot cycle decline has definitely changed during 1984, from the steep decline experienced during 1982 and 1983 at a rate of 4.5 flux units per month to a leisurely rate of about 5 per year.

What does this mean in terms of working DX over the next few months? As the solar flux decreases, the MUF can also be expected to decrease. Although this might suggest a pessimistic view of summertime DX, the opposite is often the case: F₂ layer propagation is poorer when the F₂ layer MUFs is low; however, two compensating propagation effects also occur. The first is due to the greater number of hours of daylight in the summer, which means MUF rises earlier in the day. Also, the MUF remains higher until sunset than it does in winter. This effect is mainly felt on paths in east-west and northern directions in our

hemisphere. On southern bearings, which are usually transequatorial (TE) one-long-hop in winter, the MUFs in the evening are usually lower in the summertime — i.e., not much TE propagation is available; the high electron density areas ± 20 degrees from the magnetic equator just don't build up in the summertime as they do in the winter.

The other compensating propagation factor is sporadic E, which provides short-skip conditions out to 1200 miles (2000 km), with multiple hops possible. This propagation follows the sun across the sky with maximum effect at local noon for higher band DXing and near sunrise and sunset for the lower frequency bands. More detailed information on using E_s propagation will appear in next month's column.

last-minute forecast

The higher HF bands, 10-30 MHz, are expected to be very good during the first two weeks of April, with the 27-day solar flux maximum the main determining factor. Transequatorial openings should be good the second and third weeks of the month, corresponding to disturbed geomagnetic field conditions, and during the equinoctial period. The lower frequency bands, 2-10 MHz, are expected to be best during the third and fourth weeks, at least between weather storm fronts moving by your location. Look for unusual DX on east-west paths that touch the auroral latitudes, (60 to 70 degrees north latitude) during disturbed periods in the middle of the month.

The perigee of the moon's orbit (for moonbounce DX) is on the 5th, with the moon showing full phase on the 5th. There will be a short meteor shower, the Lyrid, on April 20-22, with a rate of five per hour — hardly much help for meteor-scatter DX. But a bigger shower, the Aquarid, starts before the end of April, peaks on May 5, and ends in mid-May. Its rate is 10 to 30 per hour.

band-by-band summary

Ten meters will be open to the south

and southeast for a short period before local noon, to the south at noon, and to the southwest in the afternoon. The openings will be longer when the solar flux is at its 27-day cycle maximum. Even better transequatorial one-long-hop conditions will occur during disturbed periods. Listen to WWV at 18 minutes after the hour and note the geomagnetic field status announcement (A and K indices).

Fifteen and twenty meters, almost always open to some part of the world, will be the main daytime DX bands. Twenty should stay open on long southern paths into the night, while 15 will drop out in the late afternoon. Operate 15 first and move down to 20 meters. Contacts out to 5000 to 7000 miles (8000 to 11,200 km) are possible on these bands and one-long-hop transequatorial propagation may also occur, as it does on 10 meters.

Thirty and forty meters are both day and night bands. Intermediate distances 1000 to 1500 miles (1500 to 2200 km) in any direction, considered daytime DX, are better now than in SSN maximum years. Nighttime DX on these bands may be expected to offer greater distance paths than on 80 meters and, like 80, follow the darkness path across the sky. Reduced midday signal strengths and distances may occur on days of high solar-flux values, with 30-meter openings disappearing in the pre-dawn hours on the morning after the high radio-flux values occur.

Eighty and one-sixty meters will exhibit short skip conditions during the daylight hours and lengthen at dusk. These bands follow the darkness paths, opening to the east just before your sunset, swinging more to the south near midnight, and ending up in the Pacific areas during the hour or so before dawn. The 160-meter band opens later and ends earlier.

Coastal stations and those with good low-angle radiating systems will usually have the edge for working rare DX. QRN will be as low on some nights as that experienced during the wintertime DX season.

GMT	WESTERN USA									
	PST	N	NE	E	SE	S	SW	W	NW	
0000	4:00	20	20	15	10	15	10	10	20	
0100	5:00	20	20	15	10	15	10	10	20	
0200	6:00	20	20	20	10	15	10	10	20	
0300	7:00	20	20	20	10	20	10	10	20	
0400	8:00	20	20	20	10	20	15	10	20	
0500	9:00	20	20	20	10	20	15	10	20	
0600	10:00	20	20	20	15	20	15	15	20	
0700	11:00	20	30	20	15	20	20	15	20	
0800	12:00	20	30	20	15	30	20	15	20	
0900	1:00	20	30	20	15	30	20	20	30	
1000	2:00	20	30	20	20	30	20	20	30	
1100	3:00	20	30	20	20	30	20	20	30	
1200	4:00	20	30	20	20	30	20	20	30	
1300	5:00	30	20	15	20	30	20	20	30	
1400	6:00	30	20	15	20	20	20	20	30	
1500	7:00	30	20	15	20	20	20	20	30	
1600	8:00	30	20	15	20	20	15	20	30	
1700	9:00	30	20	15	20	20	15	20	20	
1800	10:00	30	20	10	20	20	15	15	20	
1900	11:00	30	20	10	15	20	15	15	20	
2000	12:00	30	20	10	15	20	15	15	20	
2100	1:00	20	20	10	15	15	10	15	20	
2200	2:00	20	20	15	15	15	10	15	20	
2300	3:00	20	20	15	15	15	10	10	20	
APRIL		ASIA	FAR EAST	EUROPE	S. AFRICA	S. AMERICA	ANTARCTICA	NEW ZEALAND	OCEANIA AUSTRALIA	JAPAN

GMT	MID USA									
	MST	N	NE	E	SE	S	SW	W	NW	
5:00	20	20	15	15	20*	10	10	10	20	
6:00	30	20	15	15	20*	10	10	10	20	
7:00	30	20	20	20	20	10	10	10	20	
8:00	30	20	20	20	20	15	10	10	20	
9:00	30	20	20	20	20	15	15	10	20	
10:00	30	20	20	20	20	15	15	10	20	
11:00	30	20	20	20	20	15	15	10	20	
12:00	30	30	20	20	20	20	15	10	20	
1:00	30	30	20	20	30	20	20	20	20	
2:00	20	30	20	20	30	20	20	30	30	
3:00	20	30	20	20	30	20	20	30	30	
4:00	20	30	20	20	30	20	20	30	30	
5:00	20	30	15	15	30	20	20	30	30	
6:00	20	20	15	15	30	20	20	30	30	
7:00	20	20	15	15	30	20	20	30	30	
8:00	20	20	15	15	20	20	20	30	30	
9:00	20	20	15	10	20	15	20	30	30	
10:00	20	20	10	10	20	15	20	20	20	
11:00	20	20	10	10	20	15	15	20	20	
12:00	20	20	10	10	20	15	15	20	20	
1:00	20	20	10	10	20	10	15	20	20	
2:00	20	20	10	10	20	10	15	20	20	
3:00	20	20	15	15	20*	10	15	20	20	
4:00	20	20	15	15	20*	10	10	20	20	
		ASIA	FAR EAST	EUROPE	S. AFRICA	S. AMERICA	ANTARCTICA	NEW ZEALAND	OCEANIA AUSTRALIA	JAPAN

GMT	EASTERN USA									
	EST	N	NE	E	SE	S	SW	W	NW	
7:00	20	20	15	15	20*	10	10	10	20	
8:00	30	20	15	15	20	10	10	10	20	
9:00	30	20	20	20	20	10	10	10	20	
10:00	30	20	20	20	20	15	10	10	20	
11:00	30	20	20	20	20	15	15	10	20	
12:00	30	30	20	20	20	15	15	10	20	
1:00	30	30	20	20	20	20	15	10	20	
2:00	30	30	20	20	30	20	15	10	20	
3:00	20	30	20	20	30	20	20	20	20	
4:00	20	30	20	20	30	20	20	20	30	
5:00	20	30	20	20	30	20	20	20	30	
6:00	20	30	20	15	30	20	20	20	30	
7:00	20	30	15	15	30	20	20	20	30	
8:00	20	20	15	15	30	20	20	20	30	
9:00	20	20	15	15	20	20	20	20	30	
10:00	20	20	15	15	20	20	20	20	30	
11:00	20	20	15	10	20	15	20	20	30	
12:00	20	20	10	10	20	15	20	20	20	
1:00	20	20	10	10	20	15	15	20	20	
2:00	20	20	10	10	20	15	15	20	20	
3:00	20	20	10	10	20	10	15	20	20	
4:00	20	20	10	10	20	10	15	20	20	
5:00	20	20	15	15	20*	10	15	20	20	
6:00	20	20	15	15	20*	10	10	20	20	
		ASIA	FAR EAST	EUROPE	S. AFRICA	CARIBBEAN S. AMERICA	ANTARCTICA	NEW ZEALAND	OCEANIA AUSTRALIA	JAPAN

The italicized numbers signify the bands to try during the transition and early morning hours, while the standard type provides the MUF during "normal" hours.

*Look at next higher band for possible openings.

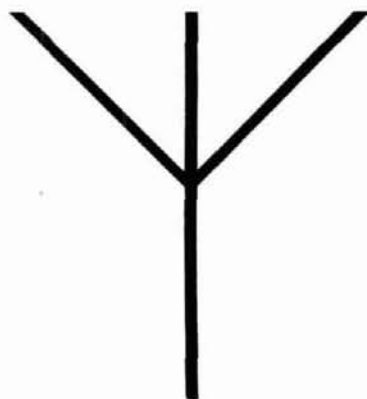

BOOKS

"A STATION IS ONLY AS EFFECTIVE AS ITS ANTENNA SYSTEM"

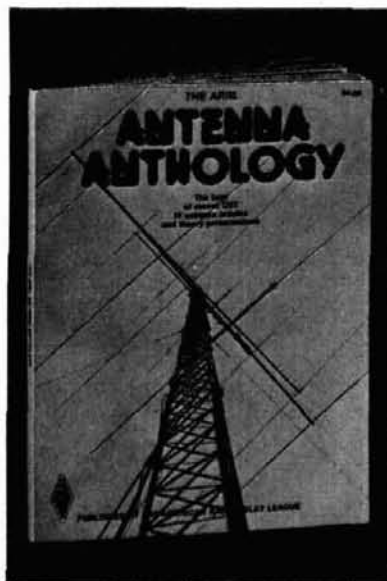
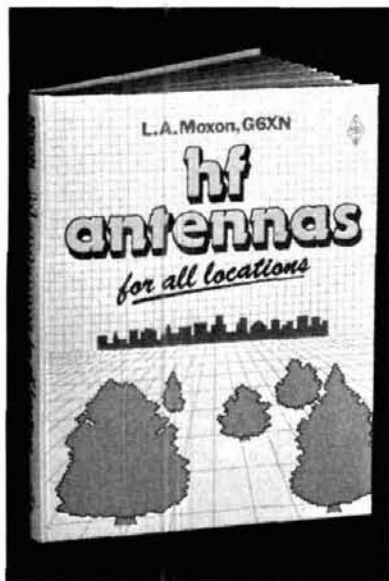
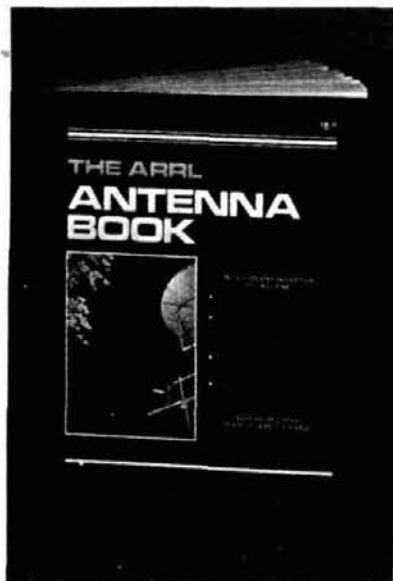

THE ARRL ANTENNA BOOK The best and most up-to-date antenna information around. The just revised 14th Edition contains in its 328 pages propagation, transmission line and antenna fundamentals. You can update your present antenna system with practical construction details of antennas for all amateur bands - 160 meters through microwaves. There are also antennas described for mobile and restricted space use. Tells how to use the Smith chart for making antenna calculations and covers test equipment for antenna and transmission line measurements. Over 600,000 copies of previous editions sold. Paperbound. Copyright 1982. \$8.00 in the U.S., \$8.50 elsewhere.

HF ANTENNAS FOR ALL LOCATIONS by L.A. Moxon, G6XN. An RSGB publication. Contains 264 pages of practical antenna information. This book is concerned primarily with small wire arrays, although construction information is also given on a small number of aluminum antennas. Chapters include: Taking a New Look at hf Antennas; Waves and Fields; Gains and Losses; Feeding the Antenna; Close-spaced beams; Arrays, Long Wires, and Ground Reflections; Multiband Antennas; Bandwidth; Antenna Design for Reception; The Antenna and Its Environment; Single-element Antennas; Horizontal Beams; Vertical Beams; Large Arrays; Invisible Antennas; Mobile and Portable Antennas; What Kind of Antenna: Making the Antenna Work; Antenna Construction and Erection. Copyright 1982, 1st Edition, Hardbound \$12.00.

ANTENNA ANTHOLOGY The best QST hf antenna articles and theory presentations. Verticals: 2 and 4 band verticals for the novice, Cheapie GP, High Performance system for 20, 40 and 80, other loaded systems. Yagis: Short antennas, and The Log-Yag Array. Quads: Wire quads for 80 and 40, 2-Element Quad for the Novice, Miscellaneous Antennas: Loops, Delta-loops, Antennas for travel trailers and campers, plus matching devices and antenna test accessories. Copyright 1978, 148 pages. \$4.00 U.S., \$4.50 elsewhere.

Enclosed in U.S. funds drawn on a U.S. bank or an international money order is \$ _____ for the books marked below:

- () ARRL Antenna Book () HF Antennas () Antenna Anthology
- \$8 U.S. \$8.50 elsewhere \$12.00 \$4 U.S. \$4.50 elsewhere
- () Hardbound \$12.50 U.S. \$13.50 elsewhere

NAME _____

ADDRESS _____

CITY, STATE OR PROVINCE, ZIP OR POSTAL CODE _____

Charge to my Master Charge Visa _____

Account number _____ expires _____ Bank number (MC) _____

A.R.R.L.
225 Main Street
Newington, CT 06111

THE STANDARD OF EXCELLENCE

The world of CW, RTTY, and new DUAL AMTOR is as close as your fingertips with the new brilliantly innovative state-of-the-art microcomputer controlled EXL-5000E.*

Automatic Sender/Receiver: Due to the most up to date computer technology, just a console and keyboard can accomplish complete automatic send/receive of Morse Code (CW), Baudot Code (RTTY), ASCII Code (RTTY) and new ARQ/FEC (AMTOR).

Code: Morse (CW includes Kana), Baudot (RTTY), ASCII (RTTY), JIS (RTTY), ARQ/FEC (AMTOR).

Characters: Alphabet, Figures, Symbols, Special Characters, Kana. **Built-in-Monitor:** 5" high resolution, delayed persistence green monitor — provides sharp clear image with no jiggle or jitter even under fluorescent lighting. Also has a provision for composite video signal output.

Time Clock: Displays Month, Date, Hour and Minute on the screen. **Time/Transmission/Receiving Feature:** The built-in timer enables completely automatic TX/RX without operator's attendance.

Select (Selective Calling) System: With this feature, the unit only receives messages following a preset code. **Built-in Demodulator for High Performance:** Newly designed high speed RTTY demodulator has receiving capability of as fast as 300 Baud. Three-step shifts select either 170Hz, 425Hz or 850Hz shift with manual fine tune control of space channel for odd shifts. **HIGH (Mark Frequency 2125Hz)/LOW (Mark Frequency 1275Hz) tone pair select.** Mark only or Space only copy capability for selective fading. ARQ/FEC features incorporated.

Crystal Controlled AFSK Modulator: A transceiver without FSK function can transmit in RTTY mode by utilizing the high stability crystal-controlled modulator controlled by the computer.

Photocoupler CW, FSK Keyer built-in: Very high voltage, high current photocoupler keyer is provided for CW, FSK keying.

Convenient ASCII Key Arrangement: The keyboard layout is ASCII arrangement with function keys. Automatic insertion of LTR/FIG code makes operation a breeze.

Battery Back-up Memory: Data in the battery back-up memory, covering 72 characters x 7 channels and 24 characters x 8 channels, is retained even when the external power source is removed. Messages can be recalled from a keyboard instruction and some particular channels can be read out continuously. You can write messages into any channel while receiving.

Large Capacity Display Memory: Covers up to 1,280 characters. Screen Format contains 40 characters x 16 lines x 2 pages.

Screen Display Type-Ahead Buffer Memory: A 160-character buffer memory is displayed on the lower part of the screen. The characters move to the left erasing one by one as soon as they are transmitted. Messages can be written during the receiving state for transmission with battery back-up memory or SEND function.

Function Display System: Each function (mode, channel number, speed, etc.) is displayed on the screen.

Printer Interface: Centronics Para Compatible interface enables easy connection of a low-cost dot printer for hard copy.

Wide Range of Transmitting and Receiving: Morse Code transmitting speed can be set from the keyboard at any rate between 5-100 WPM (every word per minute). AUTOTRACK on receive. For communication in Baudot and ASCII Codes, rate is variable by a keyboard instruction between 12-300 Baud when using RTTY Modem and between 12-600 Baud when using TTL level. The variable speed feature makes the unit ideal for amateur, business and commercial use.

Pre-load Function: The buffer memory can store the messages written from the keyboard instead of sending them immediately. The stored messages can be sent with a keyboard command.

"RUB-OUT" Function: You can correct mistakes while writing messages in the buffer memory. Misspellings can also be erased while the information is still in the buffer memory.

Automatic CR/LF: While transmitting, CR/LF automatically sent every 64, 72 or 80 characters.

WORD MODE operation: Characters can be transmitted by word groupings, not every character, from the buffer memory with keyboard instruction.

LINE MODE operation: Characters can be transmitted by line groupings from the buffer memory.

WORD-WRAP-AROUND operation: In receive mode, WORD-WRAP-AROUND prevents the last word of the line from splitting in two and makes the screen easily read.

"ECHO" Function: With a keyboard instruction, received data can be read and sent out at the same time. This function enables a cassette tape recorder to be used as a back-up memory, and a system can be created just like telex which uses paper tape.

Cursor Control Function: Full cursor control (up/down, left/right) is available from the keyboard. Test Message Function: "RY" and "QBF" test messages can be repeated with this function.

MARK-AND-BREAK (SPACE-AND-BREAK) System: Either mark or space tone can be used to copy RTTY.

Variable CW weights: For CW transmission, weights (ratio of dot to dash) can be changed within the limits of 1:3-1:6.

Audio Monitor Circuit: A built-in audio monitor circuit with an automatic transmit/receive switch enables checking of the transmitting and receiving state. In receive mode, it is possible to check the output of the mark filter, the space filter and AGC amplifier prior to the filters.

CW Practice Function: The unit reads data from the hand key and displays the characters on the screen. CW keying output circuit works according to the key operation.

CW Random Generator: Output of CW random signal can be used as CW reading practice.

Bargraph LED Meter for Tuning: Tuning of CW and RTTY is very easy with the bargraph LED meter. In addition, provision has been made for attachment of an oscilloscope to aid tuning.

Built-in AC/DC: Power supply is switchable as required; 100-120 VAC; 220-240 VAC/50/60Hz + 13.8VDC.

Color: Light grey with dark grey trim — matches most current transceivers.

Dimensions: 363(W) x 121(H) x 351(D) mm: Terminal Unit.

Warranty: One Year Limited Specifications Subject to Change



Everything built in — nothing else to buy!

EXCLUSIVE DISTRIBUTOR: DEALER INQUIRIES INVITED
AMATEUR-WHOLESALE ELECTRONICS
8817 S.W. 129th Terrace, Miami, Florida 33176

FOR YOUR NEAREST DEALER OR TO ORDER:
TOLL FREE . . . 800-327-3102
Telephone (305) 233-3631 Telex: 80-3356



MANUFACTURER:

TONO CORPORATION

98 Motosoja Machi, Maebashi-Shi, 371, Japan

*Dual Amtor: Commercial quality, the EXL-5000E incorporates two completely separate modems to fully support the amateur Amtor codes and all of the CCIR recommendations 476-2 for commercial requirements.

THE DR10

**ONLY ONE ANTENNA
ROTATION SYSTEM IS
TRULY COMPLETE AND
SIMPLE TO INSTALL: THE**

DR10 The DR10 System offers a compact, single control unit with dual scale indicator; single, eight-wire control cable interconnect*; and will easily handle a 50 pound balanced antenna array and up to 8 sq. feet of wind load.

*One Rotor,
One Controller,
One Installation*

SEE YOU AT DAYTON

The DR10 Dual Axis Antenna Rotor System
A New Concept in Drive Systems

DYNETIC SYSTEMS

*not included

Call or Write for More Information.
Dealer Inquiries Invited

19128 Industrial Blvd.
Elk River, MN 55330 (USA)
612-441-4303 Telex 756135

147

Gunnplexers & accessories 10 & 24 GHz



A. Microwave Associates 10 GHz Gunnplexer. Two of these transceivers can form the heart of a 10 GHz communication system for voice, mcw, video or data transmission, not to mention mountaintop DXing! MA87141-1 (pair of 10 mW transceivers) \$251.95. Higher power units (up to 200 mW) available. B. Microwave Associates 24 GHz Gunnplexer. Similar characteristics to 10 GHz unit. MA87820-4 (pair of 20 mW transceivers) \$739.20. C. This support module is designed for use with the MA87141 and MA87820 and provides all of the circuitry for a full duplex audio transceive system. The board contains a low-noise, 30-MHz fm receiver, modulators for voice and mcw operation, Gunn diode regulator and varactor supply. Meter outputs are provided for monitoring received signal levels, discriminator output and varactor tuning voltage. RXMR30VD assembled and tested \$119.95. D. Complete, ready to use communication system for voice or mcw operation. Ideal for repeater linking. A power supply capable of delivering 13 volts dc at 250 mA (for a 10 mW version), microphone, and headphone and/or loudspeaker are the only additional items needed for operation. The Gunnplexer can be removed for remote mounting to a tower or 2 or 4 foot parabolic antenna. TR19GA (10 GHz, 10 mW) \$399.95. Higher power units available. TR24GA (24 GHz, 20 mW) \$839.95. Also available: horn, 2 and 4 foot parabolic antennas, Gunn, varactor and detector diodes, search and lock systems, oscillator modules, waveguide, flanges, etc. Call or write for additional information. Let ARR take you higher with quality 10 and 24 GHz equipment!

**Advanced
Receiver
Research**

Box 1242 • Burlington CT 06013 • 203 582-9409



**This publication is
available in microform
from University
Microfilms
International.**



Please send information about these titles:

Name _____

Company/Institution _____

Address _____

City _____

State _____ Zip _____

Phone (____) _____

Call toll-free 800-521-3044. In Michigan, Alaska and Hawaii call collect 313-761-4700. Or mail inquiry to: University Microfilms International, 300 North Zeeb Road, Ann Arbor, MI 48106.

STEP UP TO *telrex*

**NOW
FACTORY
DIRECT!!!**

Professionally Engineered Antenna Systems

TB5EM



Only Telrex provides!

- Easy assembly (within 2 hrs)
- 100 mph wind rating.
- Heavy wall tubing.
- Stainless Steel electrical hardware.
- Exceptional Gain and F/B ratio.

YOUR PRICE
\$465.00
Value \$555.00

By the only test that means anything . . . on the air comparison . . . Telrex Tri-Bands continue to support the fact that they are designed to out-perform all competition . . . as they have for over 3 decades. Here's why . . . Telrex uses a unique trap design employing Hi-Q 7500 V ceramic condensers, 3 optimum-tuned reflectors to provide maximum gain and true F/B Tri-Band performance.

40M346
\$1675.00
Value \$2000.00

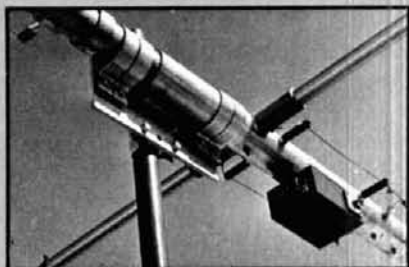

MIVD/2 frequencies
\$89.50 Post Paid (U.S.)

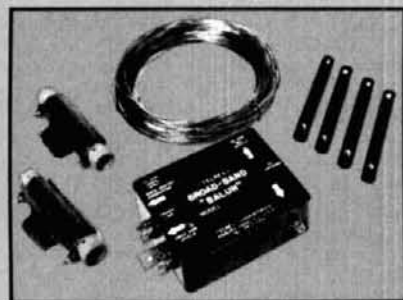

A Telrex "Balun" fed "Inverted-Vee" kit is the ideal hi-performance inexpensive and practical to install low-frequency mono or multiple band, 52 ohm antenna system.

Better than optimum full sized Dipole performance in an antenna which can be set up within the hour, needing a minimal support structure (existing tower, house, tree, etc.). The "Inverted-Vee" produces a low-angle "Balanced" Omni-Directional pattern, which increases the signal to noise, and signal to interference ratios. Complete simplified instructions are provided. NO TUNERS NEEDED!

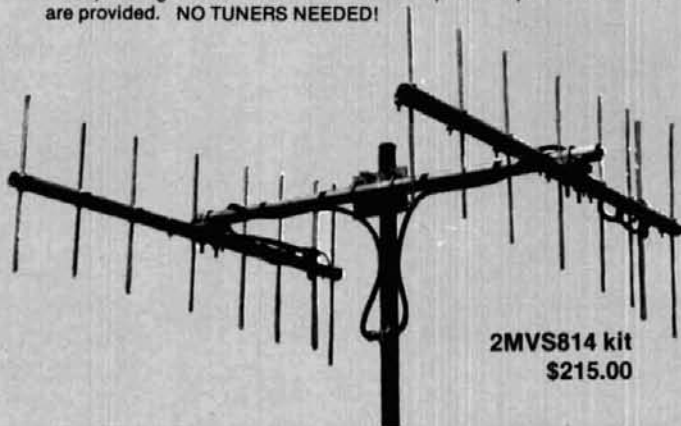

2MVS814 kit
\$215.00

Special N-type coaxial connectors, solid rod elements (driven thru the boom), tinned connecting lugs, and s/s electrical hardware provide you with peace of mind for many years!

If top 2 Meter performance is your requirement, the 2MVS814 kit consisting of 2 ea. phased 2 Meter "Balun" fed precision tuned 8 element Arrays outperform even quad stacked antennas of other makes.

A FEW OF THE WORLD'S FINEST!

MODEL	Description	GAIN	Value	PRICE
2M1528C	2 Meter 15 element	(17 DBD)	175.00	145.00
10M523	10 Meter 5 element	(13 DBD)	352.00	295.00
10M636	10 Meter 6 element	(14.6 DBD)	745.00	625.00
15M532	15 Meter 5 element	(13 DBD)	555.00	465.00
15M845	15 Meter 8 element	(15 DBD)	1120.00	925.00
20M536	20 Meter 5 element	(12 DBD)	660.00	550.00
20M646	20 Meter 6 element	(14 DBD)	1130.00	945.00
40M214	40 Meter 2 element	(5.6 DBD)	750.00	625.00
40M329	40 Meter 3 element	(8.3 DBD)	1145.00	965.00
40M346	40 Meter 3 element	(9 DBD)	2000.00	1675.00
TB4EC	10, 15, 20M Tri-Band	(5.5 DBD)	252.00	215.00
TB5ES	10, 15, 20M Tri-Band	(8.5 DBD)	408.00	340.00
TB6EM	10, 15, 20M Tri-Band	(10 DBD)	755.00	580.00

Phone . . . 201-775-7252 (nights, weekends, holidays and leave your address) or write Telrex - P.O. Box 879, Asbury Park, N.J. 07712, for your free copy of the latest Telrex UHF, VHF, HF Antenna, and Rotator Catalog.

ANTENNAS DESIGNED TO LAST!

Communications Antennas Since 1921

telrex LABORATORIES

P.O. Box 879 - Asbury Park, N.J. 07712 Phone 201-775-7252



ICOM DAY
APRIL 13

Every Bunny Goes for Our Egg-cellent Values



LOOK FOR US AT DAYTON

KENWOOD YAESU ICOM



HF TRANSCEIVERS

- TS-930S HF Transceiver CALL
With General Coverage Receiver
Optional Automatic Antenna Tuner
- TS-430S HF Transceiver SUPER SPECIAL
With General Coverage Receiver



- TS-830S Transceiver CALL
160-10 Meter With Power Supply
- TS-530SP 160-10 Meter XCVR CALL
With Power Supply & Notch Filter

RECEIVERS

- R-2000, R-600, R-1000, R-11 CALL
General Coverage Receivers

VHF/UHF



- TR-7950/7930 CALL
2-meter Mobile Units, 45 or 25 Watts
- TR-9130 CALL
2m All-mode, 25 Watts

- TS-711A/TS-811A CALL
All-mode Transceivers
2m or 70cm mobile or base station

HANDHELDS

- TR-2600A 2m FM Transceiver CALL
With memories, LCD, scan
- TH-21A, 21AT/TH-41A, 41AT CALL
2m/70cm Ultra-compact FM Transceiver

ANTENNAS

- CUSHCRAFT
A3 3-element 10-15-20m 209.95
A4 4-element 10-15-20m 275.95
R3 10-15-20m Vertical 260.95
214B SSB/214FB FM 2m Boomers 75.95
ARX-2B 2m Ring Ranger 35.50
A3219 2m Boomer 89.95

- KLM
KT344A 4-element 10-15-20m 334.95
KT34XA 6-element 10-15-20m 479.95
2m-11X 11-element 2m 59.95
2m-16L BX 16-element 2m 91.95

- MOSLEY
CL-33 3-element Triband Beam 265.95
TA-33 3-element 10-15-20m 239.95
Pro 37 7-element 10-15-20m 465.95

- HUSTLER
6-BTV 10-80m Vertical with 30m 124.95
5-BTV 10-80m Vertical 104.95
MOBILE RESONATORS Standard Super
10 and 15 meter 10.95 16.95
20 meters 14.50 20.85
30 and 40 meters 16.95 22.95
75 meters 18.95 34.95

- HY-GAIN (Limited Stock)
391S TH7DX 7-ele 10-15-20m 446.95
393S TH5DX 5-ele 10-15-20m 386.95
395S Explorer 14 10-15-20m 304.95
Order Hy-Gain tower, Hy-Gain antenna, & Hy-Gain rotor - get free shipping on all

- MORE ANTENNAS
AEA Isopoles CALL
LAVANTI HM 151 3G 2m on-glass 30.95
LARSEN LM-150 5/8 Mag Mount 38.95
MINIQUAD HQ-1 139.95
BUTTERNUT HF6V 10-80m Vert 114.95
FOR OSCAR by Cushcraft & KLM CALL

HF TRANSCEIVERS



- FT 757 HF XCVR with mic 769.95
with General Coverage RCVR
includes CW keyer, AM/FM, CW filter
- FT 77 with mic SPECIAL 510.95
Compact HF XCVR
- FT 980 CAT System 1439.00
AC Power Supply, Full Break-in CW,
SSB/AM/FM/FSK, Speech Processor

SWL RECEIVER

- NEW FRG 8800 SWL Receiver 519.95
FRG 7700 Receiver Closeout 390.00
VHF Converters, Active Antennas available

HANDHELDS

- FT 209RH 2m HT Intro Special 299.95
FT 203 2m HT with TTP, VOX 229.95
FT 203 2m HT with VOX 199.95
All accessories in stock

VHF/UHF

- NEW FT 270RH 2m, 45-watt 379.95
Very small mobile rig
- NEW FT 2700HF 25-watt 519.95
Dual-band 2m and 440



- FT 726R For 2m 779.95
(Optional modules for 6m, 430, 440 MHz)
Great for Satellite Work

HANDHELDS

- IC 02AT 2m HT, 10 Memories CALL
IC 04AT 440 HT/Touchtone 309.95
IC 2AT 2m HT/Touchtone 199.95
IC 3AT 220 MHz HT/Touchtone 229.95
IC 4AT 440 MHz HT/Touchtone 229.95

SWL RECEIVERS

- R71 100kHz-30MHz 629.95
General Coverage Receiver

VHF/UHF

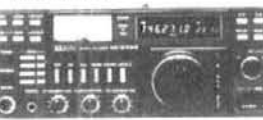

- IC 271A 599.00
All-mode 2m Transceiver
- NEW IC 3200 2m/440 CALL
IC 271H 100-watt 2m XCVR 732.95
IC 27A 2m compact mobile 319.95
IC 290H 25-wt all-mode 2m XCVR 479.95

HF TRANSCEIVERS



- IC 745 759.95
HF XCVR/Gen Cov RCVR
- IC 751 HF XCVR/Gen Cov RCVR 1179.00
With PS35 installed 1299.00

MARINE

- M12 12-ch Programmable HT 219.95
M2 76-channel Synthesized HT 261.95
M80 25-watt all-channel Scanner 387.26
M80C Commercial M80 429.95
New M5 all-channel HT 325.95

ACCESSORIES

- BENCHER PADDLES 37.95/47.95
Black/Chrome

- ASTRON POWER SUPPLY
RS7A 49.95 RS20M 104.95
RS12A 69.95 RS35M 149.95
RS20A 88.95 VS20M 124.95
RS35A 132.95 VS35M 169.95
RS50A 189.95 RS50M 209.95

- AEA KEYS
CK-2 Contest Keyer 146.95
MM-2 Morsematic Keyer 172.95

- TELEX HEADPHONES
Procom 250 Headset/Mic 99.95
Procom 450 Headset/Mic 49.95

MFJ PRODUCTS

- B & W
375 6-position Coax Switch 22.50
376 5-position Coax Switch 22.50
425 1 kW Low Pass Filter 25.50

- DAIWA/MCM/J.W. MILLER
CN-520/CN-540 Meters 59.95/69.95
CN-620B/CN-630 Meters 106.00/126.00
CN-720B 2kW HF Watt Meter 120.00
CNW-419 Antenna Tuner 500 W 174.95

- AMPHENOL
Connectors of all kinds in stock CALL

- ROTATORS
Alliance HD73 94.95
Kenpro KR500 Elevation Rotator 185.95
Hy-Gain Ham IV 231.95
Hy-Gain Tailwhister TX 278.95
Hy-Gain CD45II 145.95
Hy-Gain Heavy-duty 300 515.95
Buy an HF Beam and get an HD73 for \$89

- ST 142 Handheld 249.95
STL Leather Case with Strap 34.95
SM3 Speaker Mic 34.50

- KDK
FM 2033 2m 25-watt 259.95



- 2591 2m Synth Handheld 259.95
Century 22 CW XCVR 350.00
2510 Model B 410.95
Satellite Station for Oscar 10
CORSAIR Model 560 999.95
ARGOSY II 525D Digital 519.95
TRITON 425 HF Amp 1.5kW CALL

SCANNERS

- REGENCY
New MX4000 mobile 30-900 MHz Call
HX1000 20-ch Handheld 215.95
New HX2000 Handheld 100-900 MHz Call
R1050 10-ch 6-band Special 99.95
MX3000 30-ch 6-band mobile 189.95
MX5000 20-ch 25-112 MHz cont 357.95

- BEARCAT
260 16-ch mobile 259.95
201 16-channel/aircraft 179.95
2020 40-ch/aircraft 289.95
2100XL 199.95
300 50-ch scanner/aircraft 347.00

SONY RECEIVERS

- 2002 SWL Receiver 209.95
4800 SWL Receiver 66.00
7600A SWL Receiver 139.95

AMPLIFIERS

- TOKYO HY-POWER
VHF & UHF amps CALL for Quotes

- DAIWA
LA-2035 2m Amp, 2 in, 30 out 68.95
LA-2035R 2m Amp with preAmp 74.95

- MIRAGE
B23A 2m Amplifier 2-30 84.95
B1016 2m Amplifier 10-160 242.95
B3016 2m Amplifier 30-160 199.95
D1010N UHF Amp/N connectors 279.95
B215 2m Amp 2 in, 150 out 245.95
A1015 6m Amp 10 in, 150 out 242.95

- AMERITRON HF AMPS
AL80 1200 watt 589.95
AL84 HF Amp 160-15 389.95
AL1200 1.5 kW Amp 1399.95

KENWOOD TL922 2kW CALL

- AMP SUPPLY
LA 1000A 160-15m Amp 389.95
LK 500NT HF Amp no tune CALL
AT 1200A 1200 PEP Tuner 169.95

- VOCOM AMPLIFIERS
2 watts in, 30 watts out 2m Amp 69.95
2 watts in, 60 watts out 2m Amp 107.95
2 watts in, 120 watts out 2m Amp 169.95
200mW in, 30 watts out 2m Amp 84.95

ETO Alpha linear amps available - Call

New VHF/UHF Amps
from TE Systems
with Low Noise
GaAs FET Preamp
Call for Quotes

TOWERS



CURRENT STOCK SALE

- Self-supporting towers:
HBX40 40-foot with Base 210.95
HBX48 48-foot with Base 279.95
HBX56 56-foot with Base 359.95
HDBX40 Higher load with Base 259.95
HDBX48 Higher load with Base 349.95
Other BX, HBX, HDBX in stock

- Guyed foldover towers:
FK2558 58-foot, 25G CALL
FK4554 54-foot, 45G CALL
*Other sizes at similar savings.
Foldovers shipped freight paid
10% higher west of the Rockies.*

- Straight Sections:
20G Straight Section 33.95
25G Straight Section 47.95
45G Straight Section 109.95

Complete Tower Packages CALL



- CABLE BY SAXTON
RB213 Mil Spec 29' /ft
RGB/U Foam 95% Shield 25' /ft
8-wire Rotator 2 #18, 6 #22 17' /ft
Mini 8 95% Shield 13' /ft

CABLEWAVE HARDLINE Call



13646 Jefferson Davis Highway
Woodbridge, Virginia 22191
Information & Service: (703) 643-1063

Store Hours: M-T 10 a.m. - 6 p.m.
W-F Noon - 8 p.m.
Sat 10 a.m. - 4 p.m.

Order Hours: M-F 9 a.m. - 7 p.m.
Saturday 10 a.m. - 4 p.m.

Send 3 22¢ stamps for a flyer.

Dealer inquiries invited



Our associate store
Davis & Jackson Road, P.O. Box 293
Lacombe, Louisiana 70445
Information & Service (504) 882-5355



Terms: No personal checks accepted
Prices do not include shipping. UPS
COD fee: \$2.25 per package. Prices are
subject to change without notice or
obligation. Returns subject to a 15%
restocking fee. All items are covered by
the manufacturers' warranties.



For Orders and Quotes Call Toll Free: 800-336-4799
Virginia Orders and Quotes Call Toll Free: 800-572-4201

the weekender

a DC dummy load

Anyone who works with heavy-duty batteries or with low-voltage DC power supplies develops a keen appreciation for any handy way to test them under load. The instrument described in this article can be built inexpensively in a single evening. It can put the heaviest duty Amateur power supply to the test and reveal a great deal about it.

This instrument monitors load current and voltage while allowing smooth adjustment of the load from zero to maximum. With the addition of optional features, it can test transformers for current-handling capability, test the strength of automotive or stationary batteries, and check voltage regulation and overall performance of most low-voltage power systems. Better yet, you can build it from junk box parts or from Radio Shack parts costing less than \$25. You'll need some power transistors to absorb energy, an ammeter, a voltmeter, a control potentiometer, a couple of heat sinks, and other assorted hardware.

design requirements are flexible

The circuit for the DC load tester I built is shown in **fig. 1**. The idea for the unit was not original with me; I dimly remembered seeing something like it in an old magazine,¹ but I couldn't find the article right away, so I started from scratch.

Because I have some heavy-duty power sources around, including a 50-ampere, 14-volt power supply and a big bank of lead-acid batteries, I wanted a load that could take a lot of current and push these sources hard. With an early breadboard model, I was mystified when a pair of 2N3055 transistors failed well before they reached their rated maximum collector current of 15 amperes each. Then it dawned on me: these transistors have a maximum dissipation rating of 115 watts each, for a total of 230 watts. Their efficiency, of course, is zero, so all that power is dissipated as heat. I was asking those two transistors to dissipate 15 volts at 20 amperes — a total of 300 watts.

By George L. Thurston III, W4MLE, 2116 Gibbs Drive, Tallahassee, Florida 32303

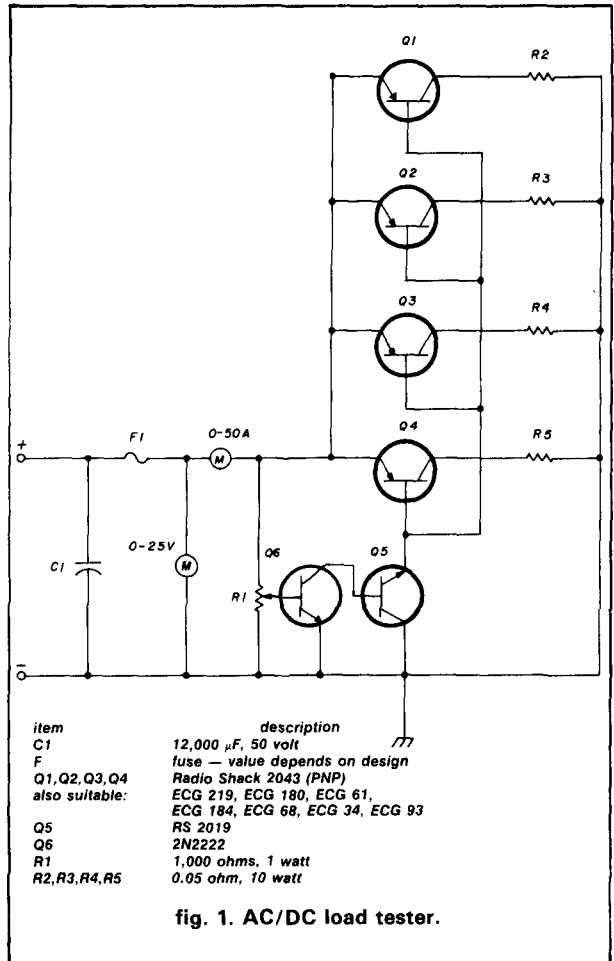

With a little figuring, I decided I could live with a unit that would dissipate 600 watts, so I chose somewhat higher power PNP transistors, Radio Shack 2043s, rated to handle 15 amperes and 150 watts dissipation for \$2.19 each.

I mounted four 2043s on large, black anodized heat sinks. The collector resistors, which serve to keep the current evenly divided among the four transistors, had to be made up from 5-watt, 0.1-ohm units bought from a local supply house at about 45 cents each. Suitable resistors can often be found at flea markets for as little as ten cents or so. The actual value of the equalizing resistors is not critical, as long as you keep them below about 0.15 ohm, but they should be the same for each of your paralleled transistors.

Any number of different types of transistors would work equally well as long as all transistors in any one project are alike and combined power dissipating ability is sufficiently large. To economize on enclosure size and on the number of heat sinks and equalizing resistors, use the fewest high-wattage, high-current transistors that will do the job. NPN or PNP units are equally suitable, though the bias control circuit must be different for each type and, of course, the emitter-

collector connections must be reversed (see **fig. 2**).

In the breadboard models a 25-watt, 50-ohm wire-wound rheostat and some fixed resistors were used to control bias on the transistor and consequently the amount of current they drew from the source. However, the wire-wound resistor did not provide smooth control, and a better method was needed. A smaller transistor could be used to regulate the base current and could itself be adjusted with an ordinary potentiometer. But what kind of base-current control transistor would work? Obviously, the control transistor would have to handle the total base current of the combined load transistors, which would be asked to deliver a maximum of 60 amperes.

The Radio Shack 2043s I used had a current-gain ratio (h_{FE} or Beta) of about 20. (The Betas of individual transistors differ quite widely sometimes, even within the same production batch.) This meant that if I wanted 60 amperes from the load transistors, I would need 60/20, or 3 amperes of base drive current.

My junk box yielded a Radio Shack No. 2019, a transistor rated to handle 10 amperes of collector current and with an h_{FE} of about 20. To deliver 3 amperes, it must have about 0.15 amperes (150 mA) of base drive. This is easily obtained from an wire-wound potentiometer hung across the input source. Even less base current would be required by a transistor with a higher Beta (or h_{FE}). The TIP 120, which can deliver 5 amperes of collector current, has a Beta of about 1,000.*

metering

I used a commercial 30-ampere meter with an external shunt. (**Figure 3** shows how to use a sensitive micro- or milliamp meter to measure current in several ranges.) The meter measures the voltage drop developed across one of the equalizing resistors. By proper selection of values for R6 and R7, you can choose any convenient current range. One range should go slightly above the maximum current for which the unit was designed.

If you plan a maximum of, say, 30 amperes, the high-range meter should read about 50 amperes full-scale. Assuming two load transistors, half the total current will flow through each resistor. If each resistor is 0.1 ohm, the drop will be 1.5 volts.

If you use a meter with 100 microampere full-scale sensitivity, the calibration potentiometer, R6, will need to be at least 1.5 volts divided by 0.0001 amperes, or 15,000 ohms. Even though the meter's internal resistance will be approximately 1000 ohms, the potentiometer will compensate for it. Use any convenient value between about 15,000 and 25,000. A little circuit board type potentiometer will work fine.

*The final model used an ordinary 1/2-watt carbon pot in the base of a 2N2222, which drives the base of the RS 2019 driver transistor.

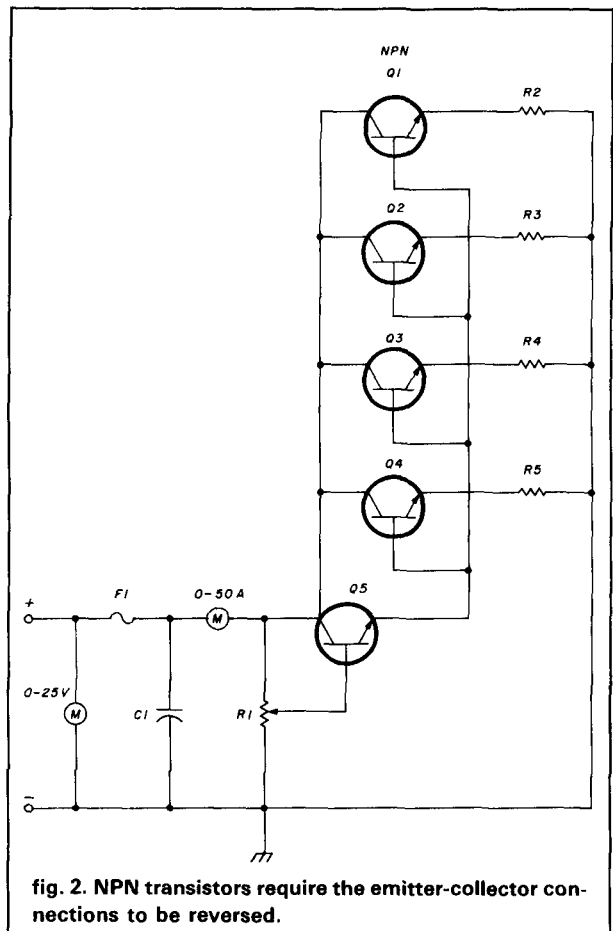

fig. 2. NPN transistors require the emitter-collector connections to be reversed.

To calibrate, use an ammeter of known accuracy in the input lead to the load tester and adjust the calibration potentiometer until the meter readings agree. If your meter has a 0-5 scale, you can read it as 0-50 amperes. A reading of 1 would indicate 10 amperes.

Another way to calibrate, if you don't have a high-range ammeter for reference, is to put a VTVM or FET-VOM across one of the equalizing resistors and increase the load current until you reach some predetermined voltage. Then, knowing the value of the resistor, you can calculate the current flowing through it and set your calibration potentiometer accordingly. In the example above, a reading of 1.5 volts would correspond to a total current of 30 amperes.

For convenience in reading light loads, a second potentiometer can be used to provide a 0-5 ampere range and a panel switch can select the desired range.

testing

Aside from meter calibration and wiring errors, there isn't much to test for except oscillations. Transistors, while capable of amplifying, will sometimes oscillate independently. To prevent this, select transistors with low Beta and low maximum frequency ratings.

If oscillations occur, they can be detected with a scope or with an RF probe on a high-impedance voltmeter. The solution is usually a matter of bypassing something; adding a 0.1 to 0.47 μ F metal film, solid tantalum or ceramic capacitor, from the transistor base to ground with the shortest possible leads, will generally solve the problem. In multiple-transistor circuits such as our AC/DC load tester, it may be necessary to bypass several transistor bases. If oscillations persist, try bypassing emitters, collectors — anything above ground potential. A last resort might be to insert very small value resistors in series with one or more base leads. In the circuit used, however, the transistor Betas are quite low and oscillations were no problem.

If you use bypass capacitors, be sure their voltage ratings are high enough to withstand the highest voltages you're likely to apply to the input terminals. And remember that when you're testing an AC source through the bridge rectifier, you will encounter voltages about 1.4 times higher than the AC RMS voltage.

applications

The most obvious use of this device is to see which goes up in smoke first — the load or the power supply. But it is capable of much more sophistication than that.

Monitor both the output voltage and current. Then plot a graph of the relationship to get a good record of the quality of regulation of your supply.

Check the fold-back current limiter that's built into many supplies. At what value of load current does it go into action? It may shut down too soon, depriving you of some output capability of the supply. Or it may not shut down soon enough, subjecting your supply to unnecessary stress. Set the load to draw whatever amount of current you think is safe for the supply, then adjust the shut-down threshold to the point at which it turns off the supply.

Monitor the output of the supply with a scope while you slowly increase the load. How much current can you draw before ripple appears in the output? That may tell you something about the design of the filter and the regulation of the rectifier output.

The scope will also tell you if the supply will tend to oscillate at certain load settings — a possible cause of poor regulation and regulator burnout, not to mention TVI or birdies in nearby broadcast radios.

As any auto mechanic knows, the health of a lead-acid battery is best tested under load. A fully-charged battery whose voltage sags to 10 or 11 volts under a load of 10 to 15 amperes is sick! Voltmeter readings across individual cells or hydrometer readings on each cell will spot the defective one and confirm your diagnosis.

Using a bridge rectifier at the input, you can check

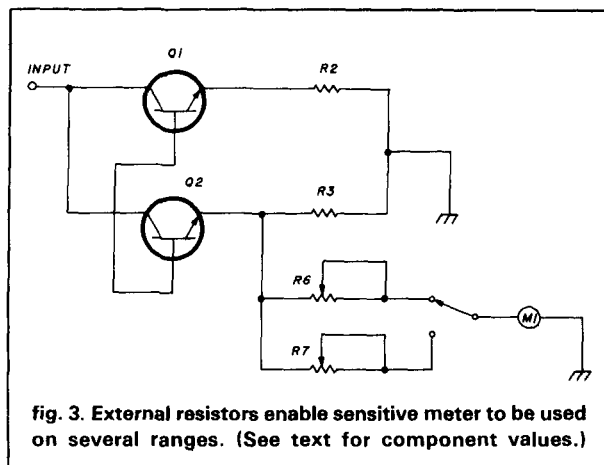

fig. 3. External resistors enable sensitive meter to be used on several ranges. (See text for component values.)

the performance of a transformer before you build it into a piece of gear. The unregulated output of any transformer, when rectified and filtered, will drop under load. Plot measurements of voltage and load current on graph paper to check performance of the filter. The voltage will fall gradually as load increases until the transformer is delivering all it is designed to provide. After that, the voltage will begin to fall faster with each additional ampere of load current because of copper losses, core saturation, hysteresis, and other problems that crop up when the transformer is overloaded. That point should appear on your graph as a slight "knee" in your curve.

rectifier bridge

To add a bridge rectifier to your dummy load, all that's necessary is to provide two additional terminals for the AC input and to hook them to a bridge (see fig. 4). The positive output of the bridge is connected directly to the positive input terminal of the dummy load. The negative bridge terminal goes to the negative load terminal. The bridge output can be left connected to the DC input terminals. It won't conduct with positive voltage applied to the positive load terminal.

Radio Shack offers a 25-ampere, 50-volt rectifier bridge for less than \$3 that will work well in this application, provided you never demand more than 25 amperes or apply more than 50 volts to it. For really heavy-duty applications, you may want to build a bridge from discrete diodes, each rated at 30 amperes or more at 10 volts or more.

With AC applied to the bridge, it will handle twice the maximum rated current of the individual diodes, since two diodes are working at once on alternate halves of the cycle. Thus, a bridge with 35 ampere diodes would safely deliver 70 amperes of current — more than adequate for testing most Amateur-service transformers.

The bridge input could be hooked directly to the DC input of the dummy load and would provide automatic

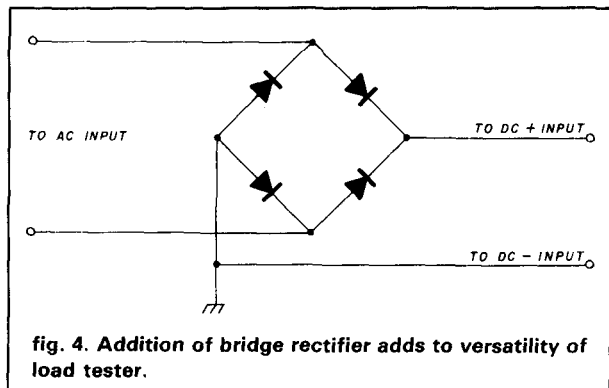

polarity correction. No matter how the DC input is connected to the AC bridge terminals, the output from the bridge will always be the same. But there's a good reason for not hooking up the bridge this way. When you put DC on the AC terminals of the bridge, two diodes in series work simultaneously, just as with AC. But they work *all* the time — not alternately, as in a 50 percent duty cycle. That means that DC input to the bridge must be limited to the current each diode will handle, or about half the AC rating. Thus, the Radio Shack bridge would be good for only 12.5 amperes when DC is applied to its input terminals.

another refinement

You will probably find that by advancing the load control potentiometer on your dummy load you can increase the load current enough to disintegrate either the load, the power supply, or both. You can protect against this in several ways:

- Install a fold-back current limiter with an adjustable threshold.
- Use a fuse low enough to blow if you exceed a safe current.
- Limit current by putting a maximum-load resistor in series with the transistors.
- Limit current by padding the control potentiometer with a fixed resistor.

The fold-back limiter may be unnecessarily fussy and complex. The fuse may not blow until the transistor junctions have gone to glory.

Although W7RXV uses fuses as equalizing resistors in his dummy load design, a hazard is involved besides their slowness compared to the junction.⁷ Fuses are seldom exactly the same. If one blows before the other, much of the load will be shunted to the other transistors, overloading them and blowing their junctions before the fuses go.

A maximum-load limiting resistor is feasible. A 0.5-ohm resistor inserted between the transistors and ground will prevent the load impedance from going

below that value. Thus, with 20 volts applied, the load current would be limited to 40 amperes, even if the transistors shorted or were turned fully on. The same resistor would limit current to 30 amperes at 15 volts and to 20 amperes at 10 volts. This would considerably reduce the range of the load or the effectiveness of the resistor. Additionally, the resistor would have to be rated at 800 watts to handle 40 amperes since $P = I^2R$. More realistically, it would have to be rated at about 450 watts to handle currents up to about 30 amperes. Such resistors are bulky and difficult to find.

The most satisfactory choice could be a resistor in series with the control potentiometer. For NPN load transistors, it would be inserted between the positive input terminal and the potentiometer. For PNP transistors, it would be inserted between the potentiometer and ground. Even this is not foolproof, because it will still be possible to exceed the dissipation rating or the current rating of the load transistors under some conditions.

reference

1. Evert Fruitman, W7RXV, "The Smoke Tester," 73, October, 1976, page 159.

bibliography

- Roos, John, K6IQL, "The Power Waster," 73, January, 1981, page 108.

ham radio

ORR BOOKS

BEAM ANTENNA HANDBOOK

by Bill Orr, W6SAI

Recommended reading. Commonly asked questions like: What is the best element spacing? Can different yagi antennas be stacked without losing performance? Do monoband beams outperform tribanders? These questions and more are fully answered. Lots of construction projects, diagrams, and photos. 198 pages. ©1983. 5th edition.

RP-BA

Softbound \$7.95

SIMPLE LOW-COST WIRE ANTENNAS

by Bill Orr, W6SAI

Learn how to build simple, economical wire antennas. Apartment dwellers take note! Fool your landlord and your neighbors with some of the "invisible" antennas found here. Well diagrammed. 192 pages. ©1972. 2nd edition.

RP-WA

Softbound \$7.95

THE RADIO AMATEUR ANTENNA HANDBOOK

by William I. Orr, W6SAI and Stuart Cowan, W2LX

Contains lots of well illustrated construction projects for vertical, long wire, and HF/VHF beam antennas. There is an honest judgment of antenna gain figures, information on the best and worst antenna locations and heights, a long look at the quad vs. the yagi antenna, information on baluns and how to use them, and new information on the popular Sloper and Delta Loop antennas. The text is based on proven data plus practical, on-the-air experience. 190 pages. ©1978. 1st edition.

RP-AH

Softbound \$7.95

ALL ABOUT CUBICAL QUAD ANTENNAS

by Bill Orr, W6SAI — New 3rd Edition

Includes NEW data for WARC bands

The cubical quad antenna is considered by many to be the best DX antenna because of its simple, lightweight design and high performance. You'll find quad designs for everything from the single element to the multi-element monster quad. There's a wealth of data on construction, feeding, tuning, and mounting quad antennas. 112 pages. ©1982. 3rd edition.

RP-CQ

Softbound \$6.95

Please add \$1.50 for one book, \$2.50 for two or more books to cover shipping and handling.

Ham Radio's Bookstore

Greenville, NH 03048

RECEIVE WEATHER CHARTS IN YOUR HOME!

SPECIAL!
While Supply Lasts.
UNIDEN CR-2021
HF General Coverage
Receiver only \$95
plus \$5 sh when
purchased with Weather
Chart Recorder Kit



You can DX and receive weather charts from around the world.

Tune in on free, worldwide government weather services. Some transmitting sites even send weather satellite cloud cover pictures!

You've heard those curious facsimile sounds while tuning through the bands—now capture these signals on paper!

Assemble ALDEN's new radiofacsimile Weather Chart Recorder Kit, hook it up to a stable HF general-coverage receiver, and you're on your way to enjoying a new hobby activity with many practical applications. Amateurs, pilots, and educators can now receive the same graphic printouts of high-quality, detailed weather charts and oceanographic data used by commercial and government personnel.

Easy to assemble—Backed by the ALDEN name.

For over 40 years, ALDEN has led the way in the design and manufacture of the finest weather facsimile recording systems delivered to customers worldwide. This recorder kit includes pre-assembled and tested circuit boards and mechanical assemblies. All fit together in a durable, attractive case that adds the finishing professional touch.

Buy in kit form and save \$1,000!

You do the final assembly. You save \$1,000. Complete, easy-to-follow illustrated instructions for assembly, checkout, and operation. And ALDEN backs these kits with a one-year limited warranty on all parts.

Easy to order.

Only \$995 for the complete ALDEN Weather Chart Recorder Kit.

To order, fill out and mail the coupon below. For cash orders enclose a check or money order for \$995. Add \$5 for shipping and handling in the U.S. and Canada, plus applicable sales tax for CA, CO, CT, IA, MA, NY, WI. (Export price is \$1250 F.O.B. Westborough, MA. Specify 50 or 60 Hz.) To use your MasterCard or Visa by phone, call (617) 366-8851.

ALDEN ELECTRONICS

Washington Street, Westborough, MA 01581

NAME: _____

CALLSIGN: _____

ADDRESS: _____

CITY: _____ STATE: _____ ZIP: _____

I've enclosed a check or money order for \$995.00 and \$5.00 for shipping and handling, plus applicable sales tax.

Charge to: MasterCard  Visa 

ACCOUNT # (ALL DIGITS)

EXPIRATION DATE

____ - ____

SIGNATURE REQUIRED
IF USING CREDIT CARD _____

Mosley.....

A BETTER ANTENNA

WHY SETTLE FOR LESS? LOOK WHAT THE MOSLEY TA-33 OFFERS

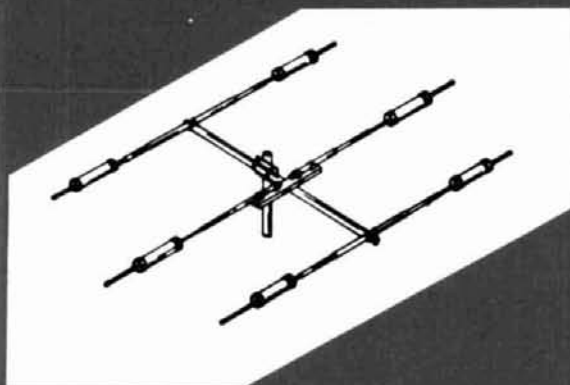

- Expandable to 30 or 40 meters
- Superb front to back ratio
- Excellent gain

- 3 Element full power
- All stainless steel hardware
- Ease of assembly
- No balun required
- Now a 2 year limited warranty
- Now a standard 2" mast adapter
- Built to last

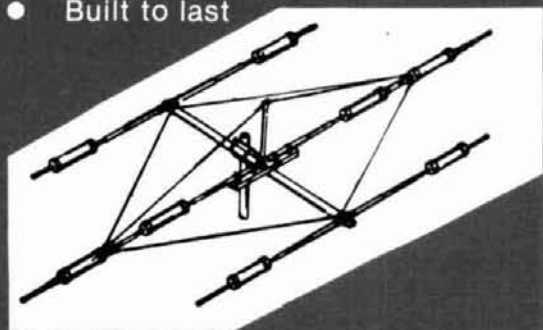

- Outstanding SWR

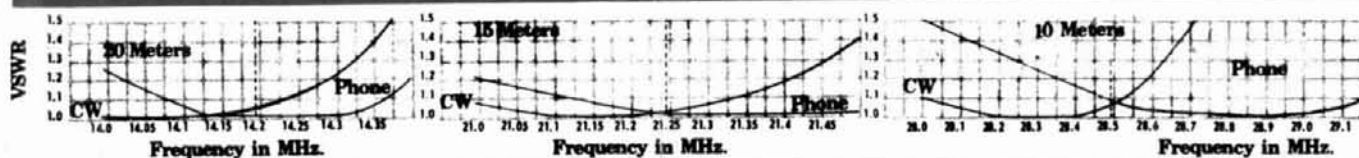

SPECIFICATIONS:

Forward gain	
Front-to-Back Ratio	
Power rating	1KW
	CW
	SSB
	2KW P.E.P.
Feedpoint Impedance	52 ohm
VSWR HT Resonance	1.5 to 1 or better
Matching System	Mosley
Number of Elements	3
Longest Element	28'
Boom Length	14'
Mast Size	1 1/2" or 2"
Turning Radius	15'6"
Wind surface area (in. sq. ft.)	5.7
Wind load (EIA standard 80 mph)	114 lbs.
Assembled Wt.	39 lbs.
Shipping Wt.	44 lbs.

- Used around the world
- Work CW or phone without tuning or adjusting antenna
- A great antenna for the new solid state rigs

ALL MOSLEY ANTENNAS
AND CATALOGS AVAILABLE
AT QUALITY DEALERS
OR CALL TOLL FREE

1-800-325-4016

This antenna is UPS shippable.

Prices and specifications
subject to change
without notice or
obligation.

REMEMBER WHETHER YOU USE TRAPS OR LINEAR LOADING, 8db GAIN IS 8db GAIN

YOUR RECEIVER CAN'T TELL THE DIFFERENCE ... MOSLEY ... TRAP MASTERS QUALITY STILL SETTING THE PACE ...

Mosley Electronics, Inc.

1344 BAUR BOULEVARD ST. LOUIS, MO. 63132 1-314-994-7872

ham radio Reader Service

For literature or more information, locate the Reader Service number at the bottom of the ad, circle the appropriate number on this card, affix postage and send to us. We'll hustle your name and address to the companies you're interested in.

101 113 125 137 149 161 173 185 197 209 221 233 245 257 269 281 293 305 317 329 341
102 114 126 138 150 162 174 186 198 210 222 234 246 258 270 282 294 306 318 330 342
103 115 127 139 151 163 175 187 199 211 223 235 247 259 271 283 295 307 319 331 343
104 116 128 140 152 164 176 188 200 212 224 236 248 260 272 284 296 308 320 332 344
105 117 129 141 153 165 177 189 201 213 225 237 249 261 273 285 297 309 321 333 345
106 118 130 142 154 166 178 190 202 214 226 238 250 262 274 286 298 310 322 334 346
107 119 131 143 155 167 179 191 203 215 227 239 251 263 275 287 299 311 323 335 347
108 120 132 144 156 168 180 192 204 216 228 240 252 264 276 288 300 312 324 336 348
109 121 133 145 157 169 181 193 205 217 229 241 253 265 277 289 301 313 325 337 349
110 122 134 146 158 170 182 194 206 218 230 242 254 266 278 290 302 314 326 338 350
111 123 135 147 159 171 183 195 207 219 231 243 255 267 279 291 303 315 327 339
112 124 136 148 160 172 184 196 208 220 232 244 256 268 280 292 304 316 328 340

Limit 15 inquiries per request.

NAME _____ CALL _____

ADDRESS _____

CITY _____ STATE _____ ZIP _____

Please use before May 31, 1985

April 1985

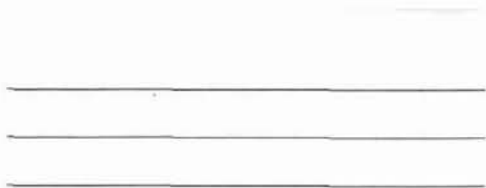

AFFIX POSTAGE
OR
POST OFFICE
WILL NOT
DELIVER

ham
radio
magazine

READER SERVICE CENTER
P.O. BOX 2558
WOBURN, MA 01888

ATTN: Reader Service Dept.

controlled vertical radiation rhombics

part 2: antenna erection and performance

Four towers, careful siting
and plenty of wire
yield topnotch results

Very few projects can be completed without compromise, and erecting a rhombic antenna is no exception. In this project, the compromise lay between tower height and low-frequency operation. An antenna height of about 65 feet was the maximum desired; this meant that 7 MHz would be the lowest design frequency. The desire to have no more than eight wavelengths on the 28-MHz band established the leg length. As pointed out in part 1 of this article, an eight-wavelength array produced an 8-degree beamwidth, and anything less was not desired. Thus two wavelengths on 7 MHz equals 277 feet. The antenna performs well on the 7, 10, 14, 18, 21, 24, and 28 MHz bands and to a lesser extent on the 1.8- and 4-MHz bands.

Based on the height and leg length, the tilt angle for the various bands was determined, with special emphasis on the lowest and highest bands — 7 and 28 MHz, respectively. These bands would determine the greatest width between the side towers and the greatest length between the end towers. **Figure 1** shows the horizontal layout of the designed rhombic, emphasizing the 7 and 28 MHz configurations. Note that a 2 A angle (see **part 1, fig. 3**) of 50 and 20 degrees are required for the 7 and 28 MHz configurations, respectively. This requires the let-out of the rhombic from the side towers of about 72 feet to go from 7 to 28 MHz (see **table 1**). The resulting takeup at the end tower is about 45 feet.

The determination of these parameters is a matter of trigonometry and is not detailed here.

geographical bearing and antenna layout

The determination of the location of the four towers is the crucial point of the design; once the towers are set in concrete, they can't be moved. Two points to consider in this regard are the desired bearing of the rhombic from true north and the allowance for a gap between pulleys and down lead. The downlead supports a counterweight, which must clear the tower as the counterweight is raised and lowered. An additional three feet between pulley and tower is advisable.

Unlike a Yagi, whose beamwidth may be anywhere from 40 to 60 degrees, the eight-wavelength rhombic will have a beamwidth of only 8 degrees. Therefore, accuracy in determining both the true bearing to the desired reception area and the physical positioning of the four towers supporting this antenna is especially important. Check all measurements and calculations carefully. (See references 1 and 2 for how to determine bearings.)

To determine the bearing of my antenna, and to set the ground posts properly, I borrowed a transit and stood where the fixed-antenna tower was to be erected. I sighted Polaris — the North Star — while KA4ECM, my wife Millie, stood about 400 feet away, shining a flashlight toward me. I lowered the transit, to a point parallel to the ground still keeping it pointed squarely in the direction of Polaris, while KA4ECM walked slowly in an east-west direction. As soon as I spotted her light in the transit viewfinder, I signaled for her to stop. She then planted a ground post at that point.

The following day we reset the transit to align on that ground post, and swung it 46.8 degrees from North, inserting a second post at the distant point. (Accuracy of ± 1 degree is recommended.)

By Henry G. Elwell, Jr., N4UH, Route 2, Box 20G, Cleveland, North Carolina 27013

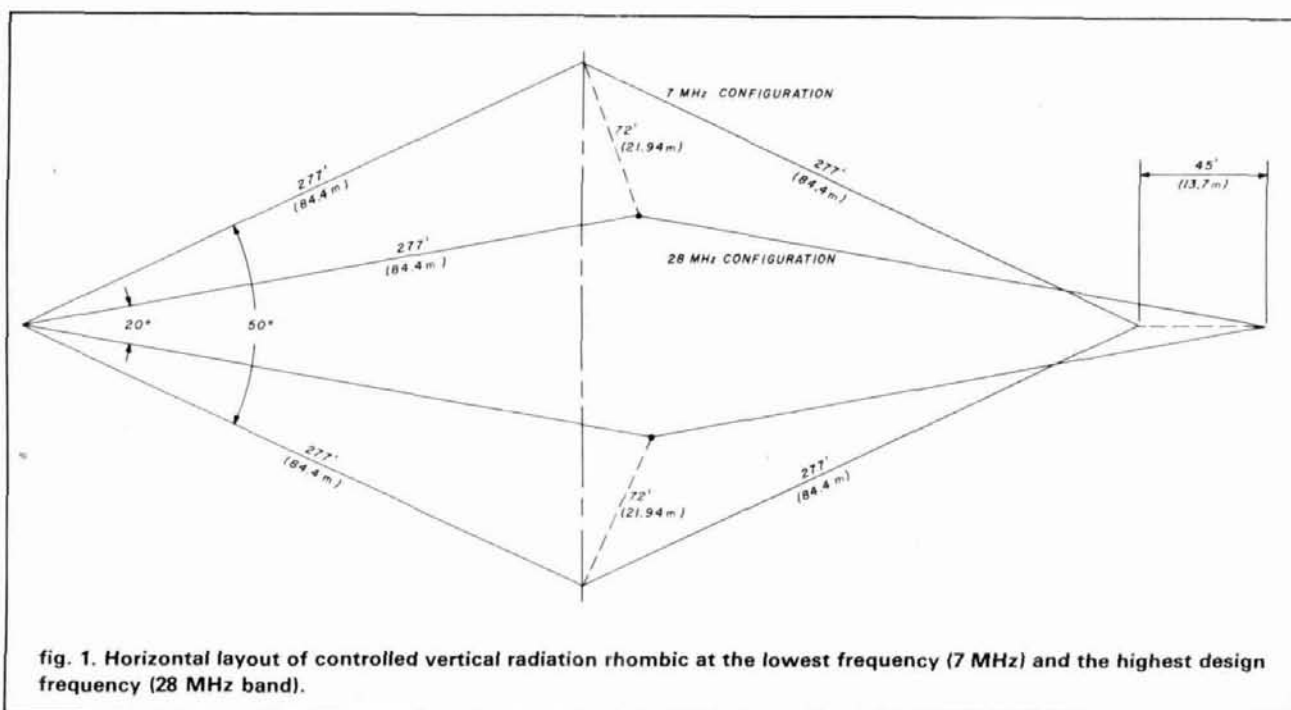
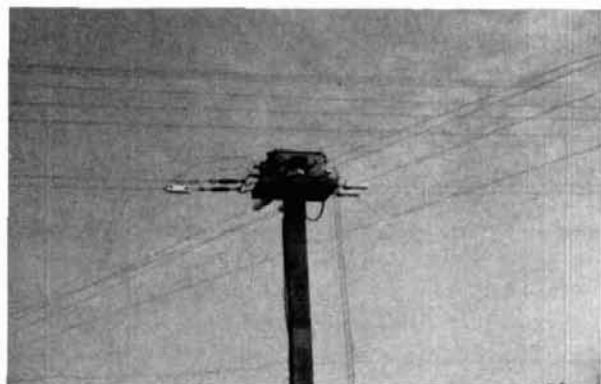

fig. 1. Horizontal layout of controlled vertical radiation rhombic at the lowest frequency (7 MHz) and the highest design frequency (28 MHz band).



Reversing switch at center of rhombic field.

table 1. Correlation between amount of "let-out" and antenna height.

side tower let-out, feet	antenna height feet
0	65.00
10	61.75
20	59.00
30	57.00
40	55.00
50	53.75
60	53.50
70	52.25

We stretched a length of nylon string between the two posts, each representing an end tower, and then took accurate measurements (using a steel tape) to (a) the point representing the center line of the side towers, and (b) the point representing the end point of the 28-MHz rhombic, corrected for the increased distance needed for pulley-tower separation. (Plan on installing a pulley on the fixed end so that the whole array can be dropped to the ground when necessary.)

We then placed the transit on the nylon string at the point representing the side tower's centerline. Ninety-degree right and left bearings were made and posts temporarily set at distances of approximately 120 feet. We strung nylon cord between these posts, took accurate measurements along the cord, and then drove stakes representing the two side towers into the ground.

Even though Polaris is easy to spot with the naked eye, it may be difficult to locate with the transit or telescope. Because of its great distance from Earth, its light reaches the telescope in parallel rays, making magnification difficult. Taking your bearings on a clear, windless — and not too cold — night minimizes the discomfort of an already difficult task.

The terrain over which my rhombic had to be erected was generally level but fell off quite sharply to the east. Various tower heights were necessary to produce an antenna that would be parallel to sea level. Two were 70 feet; a side tower had to be 80 feet; and the far end tower was 100 feet. The necessary tower heights were determined from topographical maps.

If the rhombic is to be erected on ground with a uniform slope extending for at least 1000 yards in front

table 2. Control of the vertical angle of radiation is by paying out the side tower cables.

let-out distance (feet)	angle 2A (degrees)	vertical angle of radiation — degrees				
		7.2 MHz	10.1 MHz	14.2 MHz	21.3 MHz	28.6 MHz
0	50.0	26	16.0	5	beam splits	
10	45.8	28	20.0	11	beam splits	
20	41.6	30	22.5	16	beam splits	
30	37.6	31	24.0	18	6.0 beam splits	
40	33.4	32	26.0	21	10.0	7
50	29.2	33	27.0	22	14.0	11
60	25.0	34	27.5	23	16.0	13
70	21.0	35	28.0	24	17.5	15

of the antenna, the practice is to make the front and rear poles approximately equal in height in order to bring the major axis of the antenna parallel to the average ground slope.

The erection of towers has been well covered in the literature. Substantial towers, well guyed in three directions according to the manufacturer's specifications, are necessary. One point to remember is that one guy set should be directly behind the vector force of the antenna at each tower.

In private communications, Marshall Etter, W2ER, who was chief engineer at the old RCA overseas receiving station in Riverhead, Long Island, stated that tests showed it was not necessary to interrupt the guy wires with insulators for rhombic arrays. However, if the towers are also to be used for mounting Yagis, the use of guy insulators should be considered.

As to choice of antenna wire, the military specifies high strength, 40 percent conductance, using three strands of No. 12 AWG copperweld wire, with a rated breaking point of 2433 pounds. Other wire, such as No. 6 AWG (0.162 inch), 40 percent conductance copperweld, may also be used. W2ER stated that seven-strand No. 16 AWG bronze wire was used in the RCA Rocky Point installations. He advises against the use of solid wire, which tends to vibrate in long spans. I used a special stranded steel core, wrapped with copper, used for aircraft trailing-wire antennas.*

For maximum strength, treat the rhombic as four long-wire antennas. Terminate each leg at an insulator. At the side tower, terminate both the left and right legs on the same insulator holes, connecting the two legs with a flexible jumper soldered to each leg for a good electrical circuit (see fig. 2). The flexible jumper provides slack when changing the tilt angle for different bands or propagation conditions.

The end tower antenna legs are terminated in insulators, and two insulators connected to a pear ring

*Marshall Etter, W2ER, has a limited supply of wire, insulators, and other rhombic antenna construction materials. Inquiries (enclose SASE) should be addressed to W2ER at 16 Fairline Drive, East Quogue, New York 11942.

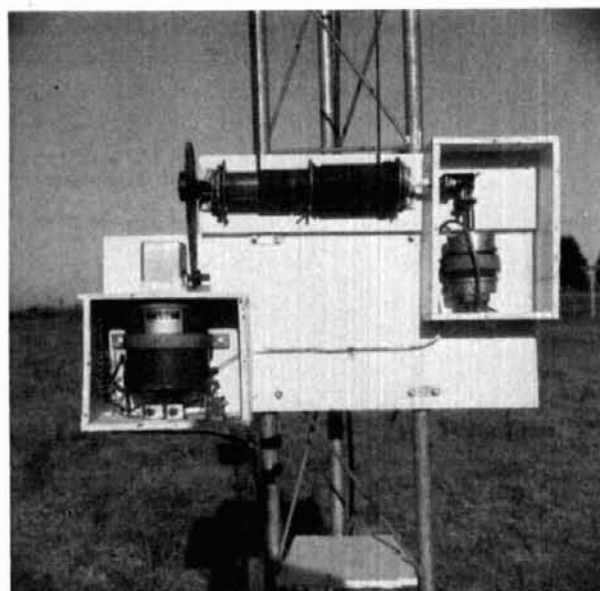

Side tower drive system. Motor drive is at left; take-up spindle, center; synchro position transmitter, right. Note the chain drive from motor to spindle to provide increased torque.

(see fig. 3). The pear ring provides a strong, easy way of connecting the three forces: two antenna legs, and the opposing force of the restraining cable.

standing wave ratio

Once the complete system was operational, SWR was measured. Figure 4 shows the average overall SWR from 160 meters through 10 meters. The increase in SWR in the 160-meter band may be expected because the exponential lines were designed for a minimum frequency of 3.5 MHz and the 4:1 balun cannot be expected to operate properly over such a wide frequency range. Although the big rise in SWR in the 21-MHz band is not understood, it is believed to be associated in some way with the balun. Operation in the 15-meter band is excellent, and with all open wire lines, losses due to a 3:1 SWR are minimal.

MICROWAVE TV ANTENNA SYSTEMS

Freq. 2.1 to 2.7 GHz . 34 db Gain +

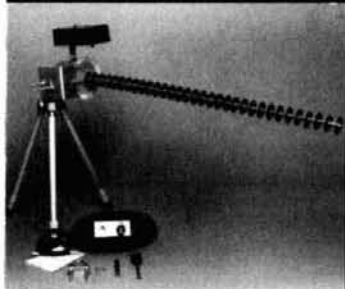

COMPLETE SYSTEMS:
(as Pictured)

Commercial 40" Rod Style \$99.95

Parabolic 20" Dish Style \$79.95

COMPONENTS

Down Converters (either style) \$34.95

Power Supplies (12V to 16V. DC+) \$24.95

Data Info (Plans) \$ 9.95

CALL OR WRITE FOR KITS, PARTS, OR MORE INFORMATION

Shipping & Handling Add \$5.00
We Repair Most Types Down Converters & Power Supplies

Phillips-Tech Electronics

P.O. Box 34772
Phoenix, AZ 85067
(602) 947-7700
Special Quantity Pricing
Dealers Wanted

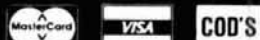

LIFETIME LIMITED WARRANTY
PARTS & LABOR

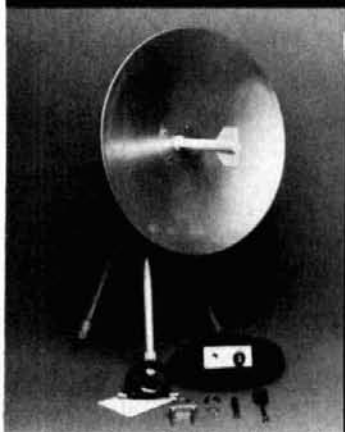

153

POCKET SIZE FAST CHARGER

Fast charge your hand held radio battery packs to full capacity in as little as 45 minutes. Example: Fully charge I-COM BP-3 in 30 to 45 minutes.

VERSATILE - Works on 115V. A.C. or 12V. to 24V. D.C. and turns itself off automatically when battery reaches full capacity. Use at home or in auto, airplane, boat, R.V. or anywhere there is house current or 12V. to 24V. D.C. available.

FEATURES -

1. New Hybrid thick film integrated circuit developed for this charger contains all measuring and control circuitry in a single chip. Laser trimmed precision resistors.
2. Small size - can be carried in your pocket.
3. High impact molded plastic case.
4. Reverse polarity protection built in.
5. Internally fused.
6. Full 1 year warranty.
7. Completely solid state circuit measures charge constantly and turns off automatically when cells reach full capacity.
8. Charges at optimum rate without any perceptible heating of cells.



Price **\$65.00**
Dealer inquires invited

19780 Temescal Canyon
Corona, Calif. 91719
(714) 734-6179

154

Mail orders to:
P.O. Box 2679
Corona, Calif. 91718

**DO YOU
KNOW
WHERE
TO FIND
REAL
BARGAINS**



on **NEW** and **USED**
ELECTRONIC Equipment?

**You'll Find Them
in the Nation's No. 1
Electronic Shopper Magazine**

NUTS & VOLTS

Now in Our 5th Year

Nuts & Volts is published MONTHLY and features:

**NEW STATE-OF-THE-ART PRODUCTS •
SURPLUS EQUIPMENT • USED BARGAINS
• LOW COST AD RATES • PRIVATE AND
COMMERCIAL CLASSIFIEDS • NATIONAL
CIRCULATION • NEW PRODUCT NEWS
SECTION • AND A FREE CLASSIFIED AD
WITH YOUR SUBSCRIPTION**

SUBSCRIPTION RATES

- One Year - 3rd Class Mail \$10.00
 One Year - 1st Class Mail \$15.00
 One Year - Canada & Mexico (in U.S. Funds) .. \$18.00
 Lifetime - 3rd Class Mail (U.S. Only) \$35.00

ORDER NOW!

SEND: CHECK MONEY ORDER
 VISA MASTERCARD

TO: **NUTS & VOLTS MAGAZINE**
P.O. BOX 1111-H
PLACENTIA, CALIFORNIA 92670
(714) 632-7721

Name _____

Address _____

City _____

State _____ Zip _____

Card No. _____

Exp. Date _____

**IF YOU'RE INTO ELECTRONICS,
THIS MAGAZINE WILL SAVE YOU MONEY!**

Dealer Inquiries Invited

155

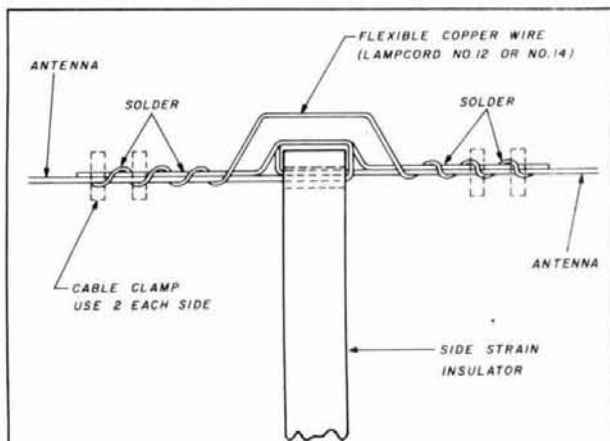
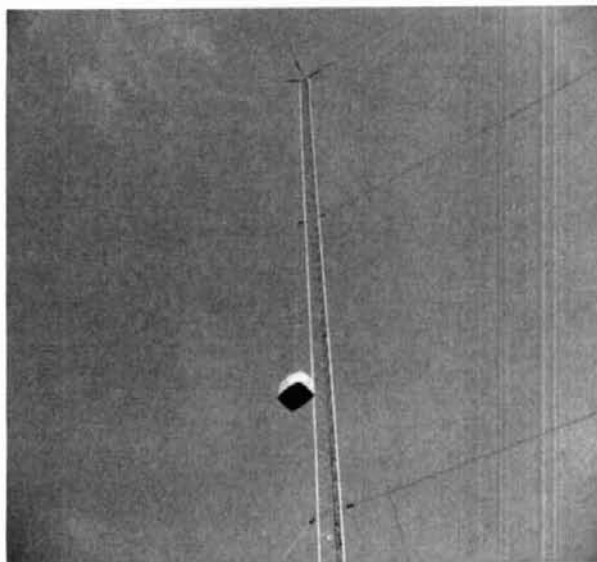

fig. 2. Connection of antenna leg at side towers to obtain antenna strength and good electrical connection between antenna legs.



End tower; 220-pound weight is shown in 40-meter position.

I have long believed in using tubes, which are very forgiving on SWR excursions, in the output amplifier stages. Use of solid-state outputs would require investigation and correction for SWRs greater than 2:1 or suffer the reduction in output levels which such transceivers automatically provide.

report on results

It will take many more months of operation and evaluation to explore fully all the capabilities of the CVR rhombic. After almost a year's operation during its development period, results can be reported in qualitative terms. Additional testing with data on the effects of changing the configuration for operation on a specific band as well as other details may be the subject of another article.

The rhombic has been used on all current Amateur bands from 160 through the 10-meter band. Foster graphs³ determined the expected results to be as shown in table 2. A report on its actual performance, band by band, follows.

- **160 meters.** The rhombic has a constant 3:1 SWR over the entire band. Using an FT102, phone contacts were made from this QTH to the Virgin Islands, to Canada, and west to Texas. Definite front-to-back response was noticed when reversing direction of fire. Comparisons were made against an 80-foot W2LL vertical with apparent advantages going to the vertical for longer distances, and to the rhombic for shorter distances.

- **80 meters.** The rhombic, 1 wavelength on a leg, has an SWR less than 2.5:1 over the entire band. It exhibits definite gain over a W2LL vertical (60-foot tower with TH7DX Tribander on top) for DX. Friends in the New York City area said the rhombic's signal was stronger than that of any other antenna I've ever used. One of the first contacts was with VK6HD, long path at 2157Z. There is about a 15-dB front-to-back difference when reversing antenna fire direction. The beamwidth is noticeable, ZL4PO/C, within the beamwidth, gave me a 58 when all other East Coast stations were getting 56 to 57. However, Australian stations, which are outside the beamwidth by 23 degrees, give me reports comparable to other East Coast stations.

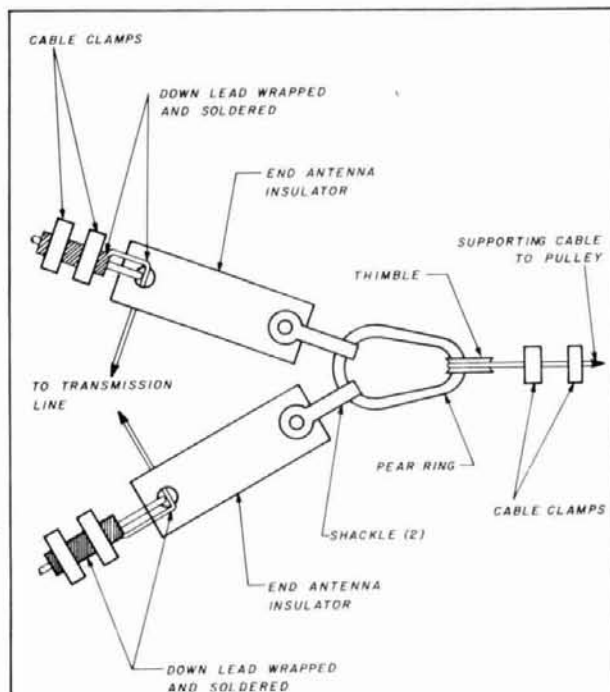

fig. 3. Pear ring used for terminating antenna and supporting cables.

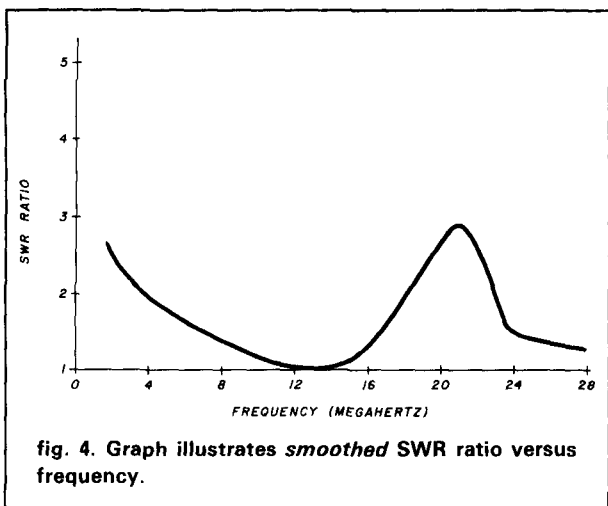

fig. 4. Graph illustrates smoothed SWR ratio versus frequency.

• **40 meters.** The rhombic exhibits a sharp change in SWR over this band: 3:1 from 7.0 MHz, dropping to 1.5:1 at 7.2 MHz and remaining there over the rest of the band. These SWR changes are peculiar to my particular setup. Being terminated, the SWR should be reasonably flat over the entire band. The rhombic is 2 wavelengths on a leg on this band. Reversing the direction of fire results in a 30 dB change in signal strength.

I've used the rhombic on this band mainly in contests, with phone results being the most informative. Because contest signal reports are meaningless, antenna effectiveness has been judged by the fact that, except for a single exception, my station received the first reply when a European stood by for Stateside calls on a stated frequency. No other 40-meter antenna was available during this evaluation period to supply comparative reports. However, the "feel" is that the rhombic, in its favored directions, is equal to or better than 3- or 4-element Yagis.

• **30 meters.** The rhombic, 3 wavelengths on a leg, has an SWR of approximately 1.5:1 across the band, and a front-to-back ratio of about 30 dB. Its signal really shines on this band because most of the antennas in competition with the rhombic are relatively simple. In the 40-meter configuration (on the 30-meter band) the rhombic's vertical angle of radiation (VAR) is at its lowest angle — 16 degrees — so ground reinforcement on this band (30-meter) has not been of major significance.

• **20 meters.** The rhombic, 4 wavelengths on a leg, has an SWR practically flat over the entire band; that is, 1.2:1 or less. Operation is with the side insulators 30 feet from the side towers for open-band operation into Europe where its vertical angle of radiation is about 18 degrees. Experience has shown that for band opening, long-path operation, and band closing operation, a 40-meter configuration with a VAR of 5 degrees

on 20 meters provides very impressive signals. My first CQ on this band with the FT102 during band-opened conditions was a sufficient reward for all the effort put into siting and construction of the rhombic.

The comparison antenna on this band is a Hy-Gain TH7DX at 60 feet; this is a tribander beam on a 24-foot boom with two driven elements, a director, and a reflector. It is an excellent antenna that puts me among the top callers in most pileups.

The results of comparisons with European stations show a 1-1/2 to 2 S-unit advantage of the rhombic over the TH7. Front-to-back ratio is about 25 dB. The narrow beamwidth of the rhombic is noticeable on this band; thus, signals into Australia are superior on the TH7, as expected, because Australia is off the 3-dB edge of the main lobe by almost 30 degrees.

• **16 meters.** No operation has been accomplished on this band, although a quick SWR check indicated an SWR of 1.7:1.

• **15 meters.** The rhombic is 6 wavelengths on a leg on this band and for some unknown reason, not investigated, the antenna system has an SWR ranging from 3:1 to 2.2:1 over the band.

Preliminary controlled vertical radiation operation was accomplished over the entire configuration change of the rhombic, — that is, with side insulators at zero feet to 70 feet. Because it takes about 30 seconds for a 10-foot increment change of the side insulators, I thought it best to take qualitative measurements on a broadcast station. Radio Berlin at 21.6 MHz was used for the test. A 25-dB change in signal strength was noted between zero feet and 40-50 feet, with a buildup of 5 dB from that point to 60 feet and 70 feet. Much more work has to be done in this area.

• **12 meters.** Again, no operation is permitted on this band, although a quick SWR check indicated a 1.2:1 SWR ratio.

• **10 meters.** On this band the rhombic is 8 wavelengths on a leg and its operation is truly awesome to someone like me, whose biggest 10-meter antenna was a 5-element Yagi at 55 feet. I first operated on this band in February, 1983, with the rhombic in a 40-meter configuration. At that time I had not yet fully explored the beamwidth of the rhombic. But I foolishly asked Roger, N4ZC, with his large antenna farm to work VKs and ZLs with me to see how our signals compared. In both countries his 6-element Yagi at 90 feet was 2 S-units better than my rhombic.

Since that time I've realized that even ZL is too far beyond the 8-degree beamwidth of the rhombic on 10 meters, and the 40-meter configuration simply does not operate properly on 10 meters.

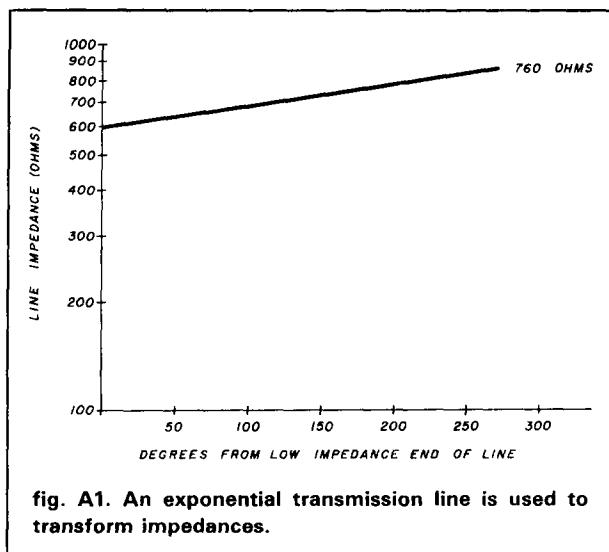

Ten meters opened again in the Fall after I had gained more experience with the rhombic and adjusted it to operate on this band. In the RSGB 10/15 meter contest in October, although not noted for my speedy contest operation, I worked 61 UK stations in 25 minutes because of the strength of the signal I was putting into Europe; "First W heard this morning," and "Loudest signal on the band," were pleasant to hear.

The general opinion appeared to be that the rhombic was 3-4 S-units stronger than the TH7. However, the narrow beamwidth is very noticeable on this band. With 45 ARRL countries within the beamwidth of the rhombic, the population density of Europe was being saturated, which was the original objective of the project.

acknowledgements

A project of this size cannot be accomplished without help and I wish to thank W2ER, WD4KJZ, WD4FFX, W2IRC, W2KXD, Alan Sielke, K1AA, W2LL, and my wife Millie, KA4ECM, whose contributions made it all possible.

references

1. Jerry Hall, K1PLP, "Bearing and Distance Calculations by Sleight of Hand," *QST*, August, 1973, page 24.
2. Chester H. Brent, WB4GVE "Aim Your Beam Right," *73*, June, 1976, page 122.
3. Donald Foster, "Radiation of FM Rhombic Antennas," *Proceedings of the I.R.E.*, Volume 25, October, 1937, page 1327.

appendix

determination of an exponential line

Exponential transmission lines are useful in transforming impedances. The values at any point along the line can be determined using graphical or mathematical approach.^{A1, A2} Since these references may not be available to everyone, a description of their method follows.

graphical method

This method uses a minimum transmission-line dimension of one-half wavelength drawn on semi-log paper.

- Mark the vertical scale with the desired impedance range. All cases will probably be from 100 to 1000 ohms.
- Mark the horizontal scale in wavelengths or electrical degrees.
- Mark a point at the 0 degree location with the desired input impedance.
- Mark a point corresponding to the desired output impedance and degrees point. The separation between these two points should be at least one-half wavelength (180 degrees).
- Draw a line between the two impedance points.
- The required characteristic impedance can now be read from the graph at all intermediate points along the line.
- Determine the necessary line configuration from each impedance point from the formula:

$$a = P \cdot 10Z^{.276} \text{ 2-wire line} \quad (\text{A1})$$

$$a = \frac{P}{\sqrt{2}} \cdot 10Z^{.138} \text{ 4-wire line side-connected} \quad (\text{A2})$$

$$a = \sqrt{2} \cdot P \cdot 10Z^{.138} \text{ 4-wire line, cross-connected} \quad (\text{A3})$$

where a = distance between wires of transmission line, in inches
 P = radius of wire, in inches
 Z = desired line impedance

Table A1 lists wire radius for various size wires. **Table A2** shows impedance variation along an exponential transmission line as a function of location and line spacing.

Example: Design an exponential 2-wire line to go from 760 ohms to 600 ohms using No. 14 bare copper wire, 3/4 wavelength (270 degrees). **Figure A1** is first drawn and then a table set up to show distance from the 600-ohm point, the impedance representing that distance, and (from the above equations) the line spacing required; see **table A2**. For greater accuracy, use the second method.

mathematical method

The impedance, Z , at any point on an exponential transmission line can be mathematically described as:

$$Z = Z_s \cdot e^{2s\theta} \quad (\text{A4})$$

where Z_s = the input or sending end impedance in ohms
 s = line length in wavelengths (1 wavelength = 360 degrees)
 θ = is a transformation function

The transformation function can be determined from the desired characteristics of the transmission line; i.e., input impedance, Z_s , and desired output impedance, Z , at the end of the line of s wavelengths. Its equation is:

$$\theta = \frac{1}{2s} \ln \frac{Z}{Z_s} \quad (\text{A5})$$

To solve, determine:

- input and output impedance; Z_s and Z .
- line length; (minimum of 1/2-wavelength at lowest operating frequency); s .
- solve for θ .
- solve for Z for each selected value of s ; let s be no greater than 20 degrees; 10 degrees preferably.
- determine the necessary line configuration for each value of Z using line spacing formulas shown in **graphical method**.

Example: Design an exponential 2-wire line to go from 600 ohms to 760 ohms using No. 14 bare copper wire, 3/4-wavelength long (270 degrees).

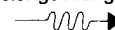

SATELLITE TELEVISION RECEIVER SEMIKIT

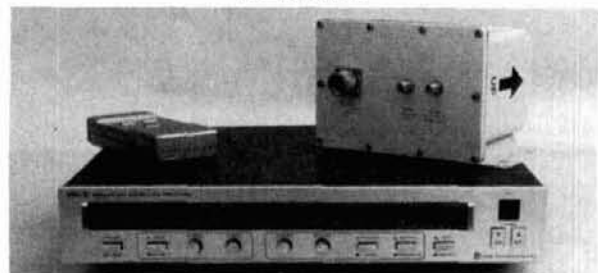

with dual conversion downconverter

FEATURES:

- Infrared remote control tuning
- AFC, SAW filter
- RF or video output
- Stereo output
- Polarizer controls
- LED channel & tuning indicators

Install six factory assembled circuit boards to complete.

SEMIKIT	\$400.00
Completed downconverter add	100.00
Completed receiver and downconverter add	150.00

JAMES WALTER SATELLITE RECEIVER

2697 Nickel, San Pablo, CA 94806 ✓ 156 Tel. 415-724-0587

table A1. Radius of common wire gauges.

wire size	radius (inches)
8	0.0642
10	0.0509
12	0.0406
14	0.0320
16	0.0254
18	0.0200

table A2. Impedance variations along an exponential transmission as a function of location and line spacing.

distance from 600-ohm point (degrees)	characteristic impedance (ohms)	line spacing (inches)
0	600	4.78
20	611	5.23
40	620	5.64
—	—	—
250	750	16.69
270	760	18.14

table A3. Mathematical and graphical method results compared.

distance from 600-ohm point (degrees)	characteristic impedance (ohms)	line spacing inches
0	600.0	4.78
20	610.6	5.22
40	621.4	5.71
—	—	—
250	747.2	16.31
270	760.0	18.14

YOU WANT IT? DAN'S GOT IT!

YAESU 



FT-209

KENWOOD



TM-211

ALL OF THESE GOODIES AND MANY MORE
AT A SUPER SAVINGS!

CALL TODAY

1 (800) 241-2027

BRITT'S 2-WAY RADIO

Sales & Service

2508 Atlanta Street
SMYRNA, GA. 30080

(404) 432-8006

✓ 157

Steps 1 and 2 have already been determined. It is then necessary to solve for θ , which will become a constant for this example; Z_s is also a constant.

$$\theta = \frac{1}{2 \cdot 0.75} \ln \frac{760}{600} = 0.158$$

Then solve for Z at 10 or 20-degree intervals and tabulate. Twenty-degree intervals are shown in table A3.

$$Z = 600 e^{(2 \cdot \frac{20}{360} \cdot 0.158)} = 610.6$$

Line spacing is then determined:

$$a = 0.032 (10^{600/276}) = 4.78 \text{ inches}$$

It will be seen that a slight discrepancy exists between the values of Z obtained from the graphical method and from the mathematical method because of difficulty in reading the curve.

For a given spacing, a four-wire line will give a much lower impedance than a two-wire line, and a cross-connected four-wire line will give an even lower impedance (than the same dimensioned side-connected four-wire line). Also the larger the wire-diameter wire, the lower the impedance for a given line separation. These factors may be used to arrive at your design of an open wire exponential line.

references

1. Edmund Laporte, *Radio Antenna Engineering*, Chapter 3, figure 3.81 and Chapter 4, page 422.
2. John D. Ryder, *Networks and Fields*, Prentice-Hall Inc., Chapter 6, Section 6-13.

ham radio

Omega Concepts, Inc.

Presents

"STATION MANAGER"

ADVANCED

Professional Software
For The Radio Amateur

Terence L. Jones (KB8OA)
Author

Stop At Our Booth At The
Hamvention, Dayton, Ohio, April 26



Omega Concepts, Inc.

P. O. Box 615 Troy, OH 45373

✓ 158

HAZER YOUR ROHN 25 G Tower

- Antenna and rotator mount on HAZER, complete system trams tower in verticle upright position.
- Safety lock system on HAZER operates while raising-lowering & normal position. Never can fall.
- Weight transferred directly to tower. Winch cable used only for raising & lowering. Easy to install and use.
- Will support most antenna arrays.
- High quality materials & workmanship.
- Safety - speed - convenience - smooth travel.
- Complete kit for 50' or less tower includes winch, cable, hardware and instructions.



Hazer 2-Heavy duty alum. 12 sq ft. load \$297.00 ppd.
Hazer 3-Standard alum. 8 sq ft. load 213.00 ppd.
Hazer 4-Heavy galv. steel, 16 sq ft. load 278.00 ppd.
Ball thrust bearing TB-25 for any of above 42.50 ppd.

As an alternative, purchase a Martin M-13 or M-18 aluminum tower engineered specifically for the HAZER system.

GLEN MARTIN ENGINEERING INC.
P.O. Box H 253 Boonville, Mo. 65233
816-882-2734



✓ 159

Satellite T.V.



\$995.00
complete

**FACTORY
DIRECT
PRICING**

**Install it yourself
and save \$\$\$**

- E-Z installation manual.
- Pricing for our name brand equipment.
- How to find the birds in your area
- Dealer-Broker program, no investment, do not miss this money making opportunity

✓ 160

For complete info
send \$9.95

PRECISION
TECHNOLOGY
P.O. Box 852
Haleyville, AL 35565

New From Butternut® HF2V DX The 80 & 40 Meter Bands



The HF2V is the perfect complement for the Ham who already has a beam antenna for 10-15-20 meters. Add 80 and 40 meters (160 meters with an optional resonator kit) with a trim-looking vertical that can be mounted almost anywhere.

With the decline in sunspot activity, the HF2V's low angle of radiation will get you DX on the low bands -- even when 10-15-20 meters are "dead."

Automatic bandswitching. No lossy traps. Double wall tubing on the bottom section. Stainless steel hardware. Full 1/4 wavelength on 40 meters.

Height: 32 ft. --Self supporting

Power rating: legal limit

VSWR: 2:1 or less

40 Meters: Full CW & Phone
band

80 Meters: 90 kHz

Add-on resonator kits available for
160-30-20 meters.

Write for our FREE CATALOG.



**BUTTERNUT
ELECTRONICS**

405 East Market Street
Lockhart, Texas 78644
(512) 398-9019

**PRICE
REDUCTION**



DX EDGE \$16.95
GRAYLINE AND LONG PATH
PREDICTOR

2nd OP
\$2.95

Price Slashed on 2nd OP

PREFIX
CALLS
TIME ZONES
BEAM HEADINGS
REGULAR \$19.90
PLUS SHIPPING

JUST \$18.95 plus \$2.50 S&H
**HAM RADIO'S
BOOKSTORE**
GREENVILLE
NH
03048

You can either buy one or buy both and save.

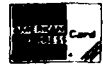

Big Computer Manufacturer Does It Again!!! DISK DRIVE BONANZA – DOUBLE SIDED 5¼" DOUBLE DENSITY FACTORY NEW DISK DRIVES

ORIGINAL
OEM COST
\$132.00

MANUFACTURED IN JAPAN BY CANON.
THESE ARE PROBABLY THE MOST BEAUTIFUL
5¼" DISK DRIVES WE HAVE EVER SEEN
ON THE SURPLUS MARKET!!

BRAND NEW: UNUSED!

\$49⁹⁵ EA.

2 FOR \$85⁰⁰

ADD \$1.50 EACH FOR POSTAGE

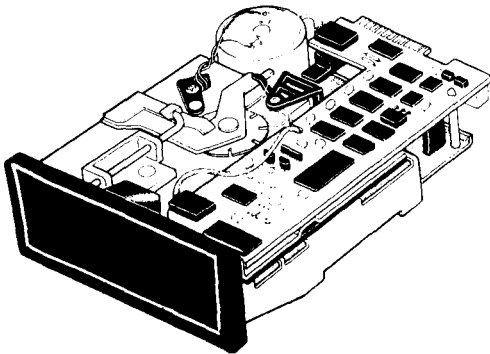

SPECS: DOUBLE SIDED
SINGLE OR DOUBLE DENSITY
TWO THIRDS HEIGHT (SPACE SAVER!!)
INDUSTRY STANDARD PIN OUT
DIRECT DRIVE — NO BELT TO BREAK!
FAST ACCESS — 6MS
LATEST HEAD & DRIVE TECHNOLOGY

The same poor purchasing agent who nearly got lynched for over buying so many D.C. switchers has gotten carried away again. The Big Boss found another hiding place crammed with a truckload of the brand new precision manufactured 5¼" disk drives. Fortunately for us, the Big Boss remembered us from the switchers deal and he gave us an opportunity to make the "Second Best" surplus buy of the decade. Even though we bought a huge quantity, please order early to avoid disappointment. Please do not confuse these sleek, 2/3 height, high quality Japanese disk drives with the flimsy domestic units sold by others.

SERIAL ASCII KEYBOARD

\$14⁹⁵
Each



4
for
\$49⁹⁵

This is no misprint!

Maxi Switch 67 Key (includes 10 function keys) qwerty serial keyboard. Number KYBD2185010 keyboard which uses a CMOS 8048 single chip microprocessor for super low power consumption. Very high quality with an exceptionally smooth feel. Originally designed for use in a portable computer. Simple serial interface — complete documentation included — Size: 12" x 5½"

These won't last long at this price!!!!

ATARI HEX KEYBOARD

\$7⁹⁵

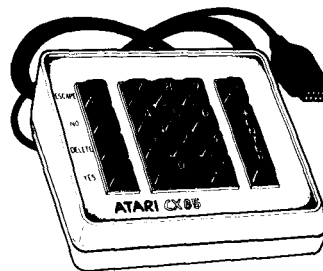

3 for \$20⁰⁰

Originally designed for use with an Atari Home Computer. Brand new in box. Encoded using the popular National Semi 74C923. Full schematic included. Originally sold for many times our price. Many applications besides computer use.

TERMS: (Unless specified elsewhere) Add \$1.50 postage, we pay balance. Orders over \$50.00 add 85¢ for insurance. No C.O.D. Texas Res. add 6-1/8% Tax. 90 Day Money Back Guarantee on all items. All items subject to prior sale. Prices subject to change without notice. Foreign order - US funds only. We cannot ship to Mexico. Countries other than Canada, add \$3.50 shipping and handling.

run RTTY on your Timex

Get on RTTY
— inexpensively

Before any computer can be used for RTTY, several problems must be solved. This article shows how these problems can be overcome in adapting this popular low-cost computer for use on this interesting mode. Although the hardware described is configured specifically for the Timex-Sinclair, the principles involved are applicable to all types of home computers.

basic requirements

A terminal unit (TU) decodes the Mark and Space tones from a receiver. An input/output (I/O) port enables the decoded signals to communicate with the computer and software tells the hardware when and how to perform.

A simple serial I/O port and a TU are described. Assembler routines are included for initializing, reading from, and writing to the port.*

RTTY is transmitted in Baudot code. Characters consist of a start bit, five data bits, and stop bits. ASCII characters contain seven data bits and an eighth bit sometimes used as a parity check bit. Each bit in each character must be checked or generated by the computer.

Communication to and from the Timex/Sinclair is most easily accomplished via the cassette port, which represents only one bit of a parallel I/O port. The com-

puter is synchronized with the data by writing precisely timed delays, called software timing loops, into the program.

UART aids data handling

The low price of the Timex/Sinclair computer has no doubt contributed significantly to its mass appeal. One cost-cutting measure in its design was the elimination of the video controller chip. The video display is generated by the microprocessor. When operating in the continuous display mode, the microprocessor devotes most of its time to creating the display with execution of the program carried out only *between* video frames. Consequently there is no time for the microprocessor to use software timing loops to process data at reasonable baud rates.

This problem can be solved by the addition of a serial I/O port. In a serial port, individual bit timing is handled by a Universal Asynchronous Receiver Transmitter (UART). The workload on the computer microprocessor is greatly reduced as data bits are assembled into complete characters during receive and characters are converted to serial bits during transmit by the UART.

I first considered using the popular AY series UART, but these devices must be furnished with a baud rate clock. A different clock frequency is required for each desired baud rate. Generation of a stable baud rate clock for the various baud rates used for RTTY and ASCII created yet another problem.

One suggested solution involved using an INS 8250 chip, a combination UART and baud rate generator.

*Circuit boards for the Terminal Unit and the I/O port, as well as a full-featured RTTY/ASCII transceiver program for Timex/Sinclair 1000 and 1500 computers are available from the author.

By Cliff Nunnery, NU4V, 313 Vaughn Street,
Fort Walton Beach, Florida 32548

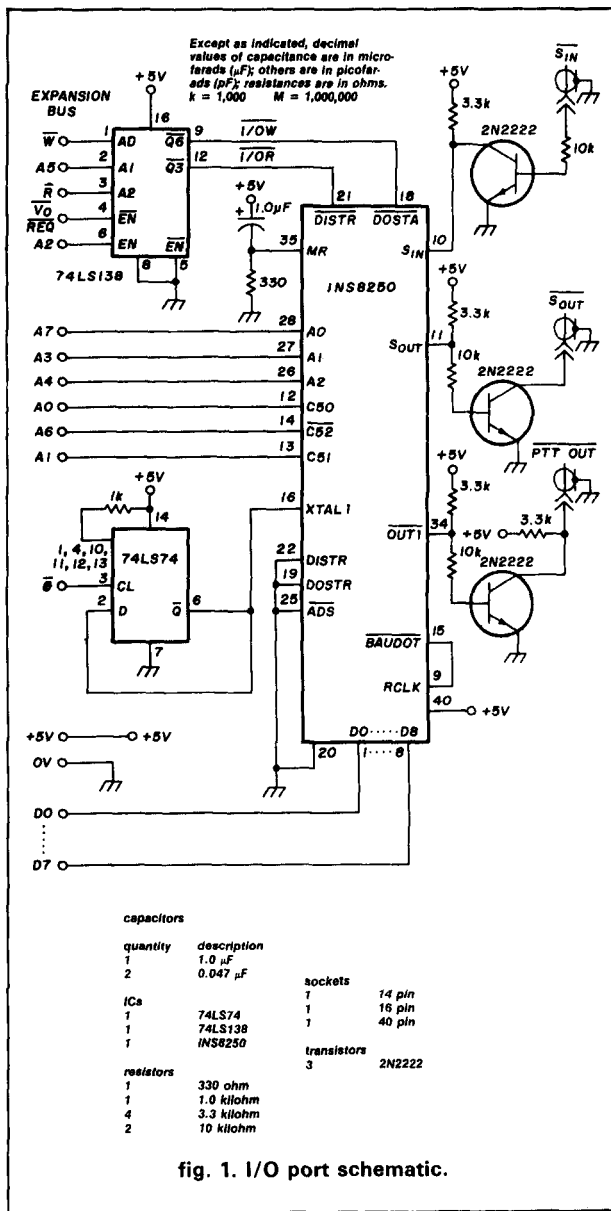

capacitors		sockets	
quantity	description		
1	1.0 µF	1	14 pin
2	0.047 µF	1	16 pin
ICs		1	40 pin
1	74LS74		
1	74LS138		
1	INS8250		
resistors		transistors	
1	330 ohm	3	2N2222
1	1.0 kilohm		
4	3.3 kilohm		
2	10 kilohm		

fig. 1. I/O port schematic.

When supplied to the INS 8250, a clock frequency of up to 3.1 MHz can be divided in frequency by any two-byte word from software to provide the baud rate clock. To implement the port it's necessary only to provide address decoding and to divide the 3.25 MHz computer clock by two.

Although the cost of the INS 8250 is about twice that of a simple UART, this is more than justified by its overall circuit simplicity: a serial port with a crystal controlled, keyboard adjustable baud rate can be built from a design using only three chips.

configuration of INS 8250

The INS 8250 is enabled by bringing pins CS0 and CS1 high and pin CS2 low. Eight internal registers are addressed by pins A0, A1, and A3. Data is strobed

table 1. Initialization and Read/Write routines. (Routines written in Z80 mnemonics.)

```

ROUTINE TO READ A CHARACTER FROM PORT
:
:
ROUTINE RETURNS WITH NEW CHARACTER IN 'A' REGISTER IF CHARACTER
READY, ELSE RETURNS WITH 'A' REGISTER = FFH
:
:
RXCHR: IN    A,(LNSTAT)    ;READ LINE STATUS REG
:           BIT    0,A      ;IS A CHAR READY? N2 = YES
:           JR    Z,NORDY  ;GO IF NOT CHAR READY
:           IN    A,(DBUFF) ;READ CHAR FROM REC BUFFER
:           RET    ;RETURN WITH CHAR IN A REG
NORDY: LD    A,(0FFH)    ;PUT FFH IN A REG
:           RET    ;RET WITH A = FFH IF NOT CHAR READY
:
:
ROUTINE TO SET PORT FOR TRANSMIT
:
XMIT:  LD    A,RTTYT    ;GET MODE CONTROL WORD IN A REG
:           OUT   (LNCIN),A ;ENTER WORD IN LINE CONTROL REG
:           LD    A,4    ;PREPARE TO SET BIT 2 IN MODEM CONT REG
:           OUT   (MCONR),A ;ACTIVATE PRESS TO TALK OUTPUT
:           RET    ;DONE: EXIT
:
:
ROUTINE TO WRITE A CHARACTER TO THE PORT
:
:
ENTER ROUTINE WITH HL REGISTER POINTING TO CHAR TO BE TRANSMITTED
:
ROUTINE CHECKS TO SEE IF THE INS8250 IS READY TO SEND ANOTHER
:
CHARACTER AND RETURNS WITHOUT TAKING ANY ACTION IF PORT NOT READY
:
CHARACTER IS SENT IF PORT READY, AND BIT 7 OF CHARACTER IN BUFFER
:
IS SET INDICATING TO CALLING PROGRAM THAT CHARACTER HAS BEEN SENT
:
:
TXCH:  IN    A,(LNSTAT)    ;READ THE LINE STATUS REGISTER
:           BIT    5,A      ;IS THE PORT READY FOR A NEW CHAR N2 = YES
:           RET    ;RETURN IF PORT NOT READY
:           LD    A,(HL)   ;GET NEW CHAR IN A REG
:           OUT   (DBUFF),A ;WRITE CHAR TO THE PORT
:           SET    7,(HL)  ;IN TIMEX/SINCLAIR THIS SETS INVERSE VIDEO
:           RET    ;DONE: EXIT
:
:

```

into or out of these registers by pins DOSTR and DISTR.

The Line Control register sets the number of data bits, stop bits, and various error checking options. This register also allows access to the Divisor latches for setting the baud clock, which runs at 16 times the actual baud rate.

The Line Status register is read during transmit to determine when the chip is ready for the next data byte to be sent to the Transmit register. It is read during receive to determine when a character is ready to be read from the Receive buffer. Various errors are also shown in this register.

The Modem Control register determines the output of four Modem Output pins. These could be used for such functions as Press-To-Talk, Keying, CW ID, or CW keying. (My program used only the Press-To-Talk function.) The status of four Modem Input pins can be read from the Modem Status register. One of these could be used to detect a decoded CW Mark (key down) signal.

active filter improves operation

The second piece of hardware required is the Terminal Unit. My first circuit used an XR 2211 phase locked loop demodulator. Receiver output was fed directly to the demodulator. It was immediately apparent that filtering of the signal before the demodulator would be necessary for satisfactory operation under normal QRM and QRN conditions. An

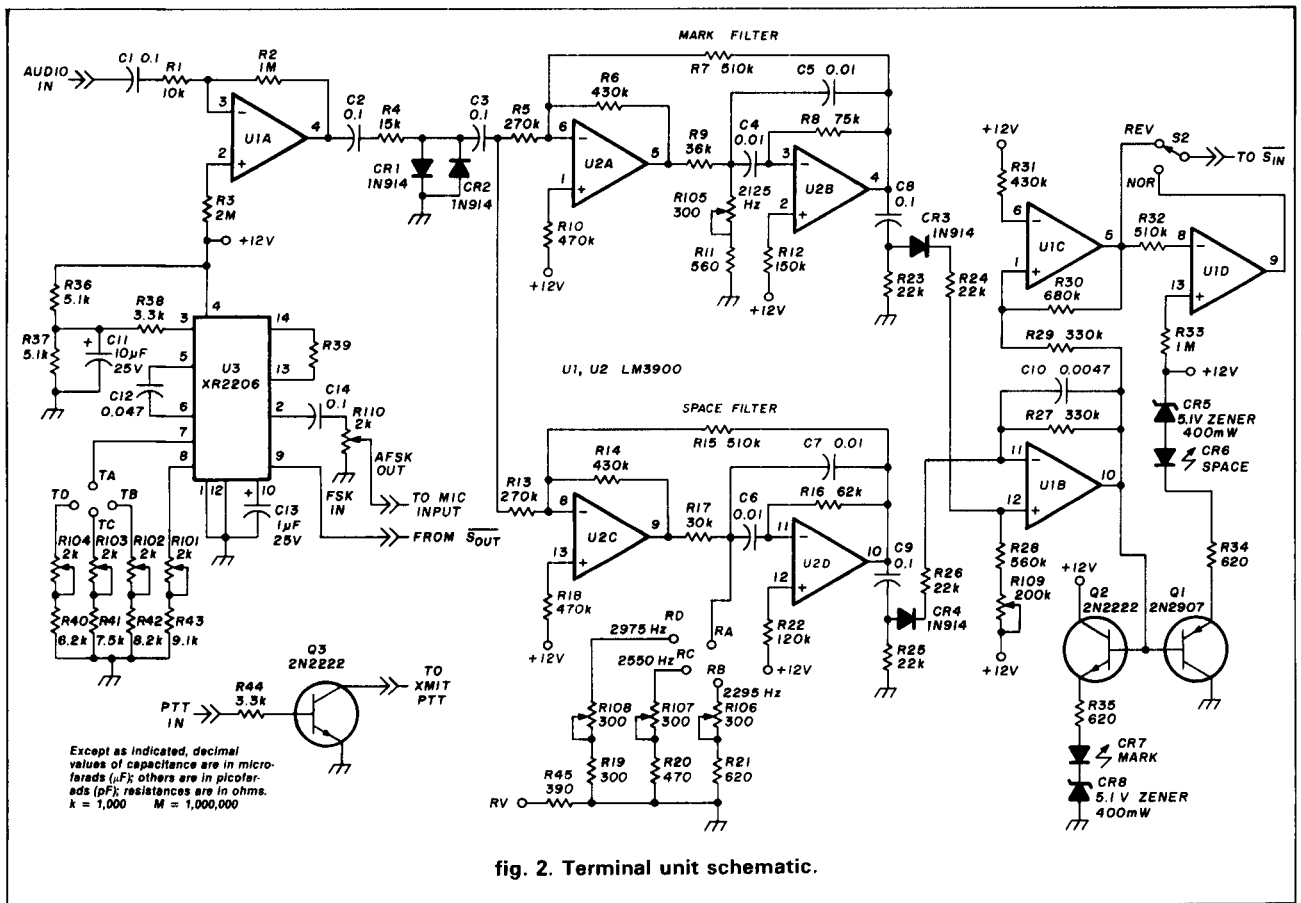

fig. 2. Terminal unit schematic.

active filter circuit for 170 Hz shift was no problem, but the circuitry became complex when provisions were added for copying signals at 425 Hz and 850 Hz shifts as well.

The design shown uses an active filter-type demodulator. It represents a reasonable compromise between performance and circuit complexity. A familiar XR 2206 circuit is used to generate the transmit AFSK tones.

operation at the I/O port

The schematic for the I/O port is shown in fig. 1. Power for the unit and signals from the computer are taken from the computer expansion bus. Charging of the 1.0 μ F capacitor connected to pin 35 of the INS 8250 provides a power-on reset function. The I/O port would normally occupy eight consecutive port addresses, but this is not possible because of the Timex/Sinclair port addressing scheme. Port addresses for the various INS 8250 registers are given in table 1.

Read, Write, I/O Request signals, and Address lines A2 and A5 are decoded by the 74LS138 to make the I/O R and I/O W signals. INS 8250 select signals are furnished by Address lines A0, A1, and A6. The remaining Address lines A3, A4, and A7 control the

register addressing. One half of the 74LS74 is used to divide the 3.25 MHz computer clock by two, to make the 1.625 MHz clock for the INS 8250. The three 2N2222 transistors should provide adequate protection for this expensive chip.

construction of the I/O port

This unit can be built on an etched circuit board or on perfboard with point-to-point wiring. The finished unit is installed between the computer and the 16K memory pack. An edge connector with wire-wrap pins should be used to attach the I/O port to the computer expansion bus.

The edge connector is installed on the foil side of the board. Allow the pins to extend through the circuit board approximately 3/16 inch (4.76 mm). Bend the pins together slightly and solder them to a small extender board; this extender board duplicates the computer expansion bus and provides connections to the 16K memory pack.

Although not shown on the schematic, at least two capacitors of about 0.047 μ F should be placed on the circuit board and connected from the +5 volt supply to ground for the purpose of filtering out switching transients. A 3.3 kilohm pull-up resistor may be required on the SOUT lead with some Terminal Units.

part of fig. 2

item	description
C1, C2, C3	
C8, C9, C14	0.1
C4, C5, C6, C7	0.01
C10	0.0047
C11	10, 25V electrolytic
C12	0.047
C13	1.0, 25V electrolytic
C15	1000, 35V electrolytic
CR1-CR4	1N914
CR5, CR8	5.1V zener
CR6, CR7	red LED
CR9	green LED
CR10-CR13	1N4002
P1	500 ohm panel-mount potentiometer
Q1	2N2907
Q2, Q3	2N2222
R1	10 kilohm
R2, R33	1.0 megohm
R3	2.0 megohm
R4	15 kilohm
R5, R13	270 kilohm
R6, R14, R31	430 kilohm
R7, R15, R32	520 kilohm
R8	75 kilohm
R9	36 kilohm
R10, R18	470 kilohm
R11	560
R12	150 kilohm
R16	62 kilohm
R17	30 kilohm
R19	300
R20	470
R21, R34, R35	620
R22	120 kilohm
R23, R24,	
R25, R26	22 kilohm
R27, R29	330 kilohm
R28	560 kilohm
R30	680 kilohm
R36, R37	5.1 kilohm
R38, R44	3.3 kilohm
R39	220 kilohm
R40	6.2 kilohm
R41	7.5 kilohm
R42	8.2 kilohm
R43	9.1 kilohm
R45	390
R46	1.5 kilohm
R101-R104, R110	2 kilohm
R105-R108	300 kilohm
R109	200 kilohm
S1	SPST switch
S2, S4	2PDT switch
S3	2P3POS wafer switch
T1	12.5V, 300 mA Radio Shack 273-1385
U1, U2	LM3900
U3	XR2206
U4	7812 volt reg (TO-220 case)
case	Radio Shack 270-252 or -272

*Denotes Mylar. Recommended these be 5 percent "V" series.
 Digi-key part No. P4513 for the 0.01 μ F
 P4521 for the 0.047 μ F
 The layout on the PC board is for the pin spacing of 5/16 inch preset variable resistors:
 Digi-key part No. K4A32 for 300 ohm
 K4A23 for 2 kilohm
 K4A25 for 200 kilohm
 All other resistors 1/4 watt, 5 percent tolerance
 Miscellaneous plugs, jacks and other hardware is necessary.
 All capacitance is in microfarads.

(Values below are for low tone operation (see text).)

R8	120 kilohm	R21	1.2 kilohm
R9	62 kilohm	R22	180 kilohm
R11	1.1 kilohm	R40	9.1 kilohm
R12	240 kilohm	R41	11 kilohm
R16	91 kilohm	R42	13 kilohm
R17	47 kilohm	R43	16 kilohm
R19	470	RV	510
R20	820	P1	1 kilohm

operation of the terminal unit

The schematic for the Terminal Unit is shown in fig. 2. Figure 3 illustrates the circuit for the TU power supply. Wiring for the associated control and switching components is shown in fig. 4. UC 2A and 2B and their associated components make up the Mark filter which is tuned by R105. U2C and 2D and associated components comprise the Space filter. R106, R107, and R108 are switched to provide tuning for the 170 Hz, 425 Hz, and 850 Hz fixed shifts. A panel mounted

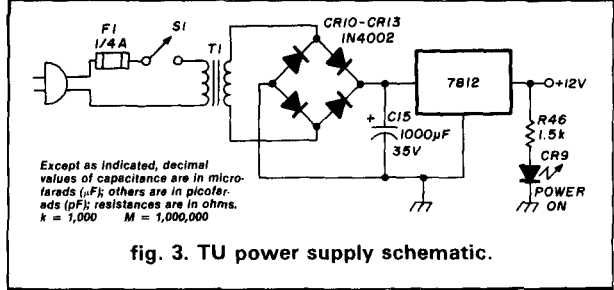

fig. 3. TU power supply schematic.

control is switched into the circuit for the variable shift tuning.

Audio from the receiver speaker is fed into amplifier U1A and limited by diodes CR1 and CR2 to minimize effects of a building or fading signal. Good limiting action occurs with about 30 mV applied to the Audio In jack.

The limiter output is coupled to both active filters by C3. The outputs of the filters are rectified and applied to differential amplifier U1B. The signal from the Mark filter is applied to the noninverting input and the signal from the Space filter is applied to the inverting input. The output of U1B will, therefore, go high for a Mark and low for a Space. Capacitor C10 filters the individual tone frequencies from U1B's output.

Positive feedback applied to U1C "squares up" the output from the differential amplifier. U1D is an inverter for copying Normal and reverse signals. Driver transistors Q1 and Q2 provide power for the Space and Mark indicator LEDs CR6 and CR7. Zener diodes CR5 and CR8 furnish bias to keep the Mark indicator turned off when the output of U1B is less than approximately 6 volts and to keep the Space indicator off when the U1B output is above the 6 volt midpoint.

Function generator U3 provides the Mark and Space tones for transmit. Timing capacitor C12, together with the resistance connected to pin 7 or pin 8 determine the tone frequency. When pin 9 is low, frequency is controlled by the resistance connected to pin 8. When pin 9 is high, frequency is controlled at pin 7.

Variable resistor R101 tunes the Mark frequency. Variable resistors R102, R103, and R104 are switched to set the Space frequency for 170, 425, or 850 Hz. With the value shown for R38, the output level at pin 2 is about 0.2 volts. The output level can be increased by increasing the value of R38. A value of 50 kilohm will give an output of about one volt.

Frequencies of 2550 and 2975 are seriously attenuated in modern HF transceivers. If your operation is primarily on the HF bands you may prefer a Mark tone of 1275 and Space tones of 1445, 1700, and 2125 Hz. Component value changes for low tone operation are noted on the parts list.

constructing the terminal unit

While prototype was constructed on perfboard,

We've Got Your Dish!

COMPLETE SYSTEMS PRICED BELOW INCLUDE A QUALITY 9' LAUX ANTENNA WITH SPECIAL TUNED FEED, POLAR MOUNT AND GROUND POLE, LAUX BETA 9 DIGITAL DISH MOVER WITH SAGINAW ACTUATOR, RECEIVER, 100° LNA, LNA COVER AND 100' OF ALL CABLE.

COMPLETE SYSTEMS

AUTO-TECH 500XL	1295.00	M/A COM T1	1895.00
BOMAN SR15000	1225.00	M/A COM H1	1975.00
DRAKE ESR324	1345.00	REGENCY SR1000	1175.00
DRAKE ESR240A	1525.00	REGENCY SR5000	1445.00
GILLASPIE 8300	1175.00	UNIDEN UST1000	1295.00
GILLASPIE 9600	1395.00	UNIDEN UST3000	1445.00

SYSTEM OPTIONS

10' DARK STAR ANTENNA	200.00	95° LNA	10.00
10' PRODELIN ANTENNA	300.00	90° LNA	30.00
10½' RAYDX ANTENNA	225.00	85° LNA	50.00
11' UNIDEN ANTENNA	225.00	TRACKER II SAGINAW B	175.00
12' CONIFER ANTENNA	300.00	TRACKER III + SAGINAW B	195.00
12' PARACLIPSE	300.00	TRACKER IV + SAGINAW B	395.00

“WRITE FOR OUR COMPLETE CATALOG”

VOLUNTEER ELECTRONICS



P. O. BOX 825 210 NORTH 22 AVE.
HUMBOLDT, TN 38343 (901) 784-3933

✓ 162

using the etched circuit board will save time and result in a neater unit. Install components, beginning with those that lie flat on the board and finishing with the power transformer. Refer to **fig. 4** for connecting the components that are not mounted on the circuit board.

I brought the 110 volt power line in from the back of the unit and mounted the fuse and jacks on the back of the case. The switches, LEDs, and the variable shift tuning control were installed on the front panel. Because it is necessary to watch both the Mark and Space LEDs when tuning in a signal, they should be mounted reasonably close together — not more than 2 inches apart.

Some older model transmitters use a tube to key the Press-To-Talk relay. In this case use a small reed relay (Radio Shack 275-233) connected between the collector of Q3 and +12 volts to key the transmitter Press-To-Talk circuit.

tuning and aligning the terminal unit

Be sure to do the following before installing the integrated circuits or applying power:

- Check for shorts or any abnormally low resistance reading across C15.
- Recheck the polarity of all diodes, electrolytic capacitors, and proper orientation of transistors.
- Turn on the power.
- Confirm that the Power On LED lights up.
- Check for 12 volts at the proper pins of each socket.

Then turn off the power and install the ICs, observing proper pin 1 orientation. Turn on the power and check the ICs, electrolytic capacitors, and the voltage regulator for heat. Although the voltage regulator may be slightly warm, nothing should feel hot.

Ground the Audio In jack and observe the Mark and Space indicators. It should be possible to turn on either LED by adjustment of R109; adjust R109 to turn them off. In darkness, it should be possible to see a faint glow in both LEDs; use R109 to balance this indication.

Remove the ground from the Audio in jack and place it on the FSK In jack to simulate a Mark. Connect a frequency counter to the AFSK Out jack. Adjust output level control R110, if necessary, for a stable reading on the counter. Adjust R101 for a frequency reading of 2125 Hz.

Remove the ground from the FSK In jack, set S3 to N (narrow shift), and adjust R102 for a reading of 2295 Hz. Set S3 to M and adjust R103 for a reading of 2550 Hz. With S3 in W, adjust R104 for a frequency reading of 2975 Hz.

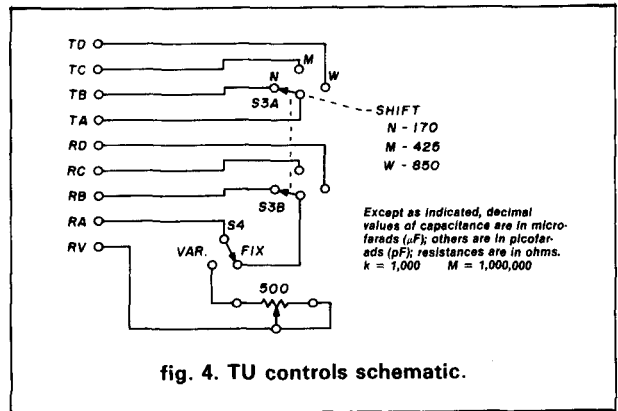

fig. 4. TU controls schematic.

Ground the FSK In jack again, and connect the AFSK Out jack to the Audio In jack. Tune the Mark filter to resonance by adjusting R105 for maximum brilliance of the Mark LED. If necessary, reduce the AFSK output level with R110 to achieve a sharp tuning peak.

Set switch S4 to FIX. Remove the ground from the FSK In jack, set S3 to N, and adjust R106 for maximum brilliance of the Space LED. With S3 set to M, adjust R107 for maximum brilliance again of the Space LED. Repeat this adjustment with S3 set to W using R108. Place S4 to VAR and S3 to M.

Adjust the variable shift tuning control for maximum brilliance of the Space LED. Repeat this check in N and in W positions. If the knob on the variable tuning control is set at the 12 o'clock position for 425 Hz shift, the 170 Hz tuning will be at about the 8:30 position and the 850 Hz tuning will be at about the 3:30 position.

Ground the FSK In jack once again. Set R110 at about its midpoint and place S2 to M. Measure the output of the Mark filter at the anode of CR3. Remove the ground from the FSK In jack and measure the output of the Space filter at the anode of CR4.

If the output of either filter is less than 8 volts peak-to-peak or 2.8 volts RMS at resonance, decrease R5 in the case of the Mark filter or R13 in the case of the Space filter, to a value of 240 kilohms. It should not be necessary to go below 240 kilohms if 5 percent or better tolerance parts have been used.

software notes

Table 1 shows example routines for initializing the port, reading data from the port, and sending data to the port. The formula for determining the Divisor is:

$$\text{Divisor} = \frac{1.625 \times 10^6}{\text{baud rate} \times 16}$$

For 60 WPM RTTY (45.45 Baud):

$$\frac{1.625 \times 10^6}{45.45 \times 16} \approx 2235$$

WHAT'S REALLY HAPPENING IN HOME SATELLITE TV?

STV SATELLITE TELEVISION MAGAZINE

A monthly of 100-plus pages, has all you need to know about where to find equipment, how it performs, how to install it, legal viewpoint, & industry insights.

- \$24.95 per yr. (12 monthly issues)
- \$ 2.00 for Sample Issue

MONEY BACK GUARANTEE if not satisfied (subscription orders only). Keep first issue with our compliments.

If you already have a dish, then you need

OnSat™

—the best in satellite TV programming.

- ★ Weekly Updated Listings
- ★ All Scheduled Channels
- ★ Complete Movie Listing
- ★ All Sports Specials
- ★ Prime Time Highlights

- \$39.00 per yr. (52 weekly issues)
- \$ 1.00 for Sample Copy

Visa® MasterCard® accepted (subscription orders only). All prices in US funds only. Write for foreign rates.

Send this ad along with your order to:

STV™/OnSat™

P.O. Box 2384 - Dept. PS
Shelby, NC 28151-2384

Subscription calls only
Toll Free **1-800-438-2020**

✓ 163

HR

The Divisor Most Significant Byte is (in BASIC):

LET DMSB = INT (DIVISOR/256)

The Divisor Least Significant Byte is:

*LET DLSB = DIVISOR - DMSB * 256*

For 45.45 Baud:

Divisor Least Significant Byte = 187

Divisor Most Significant Byte = 8

The port address for the Line Control register is AF(hex). When bit 7 of this register is set, the Divisor Latches are enabled and port address 27(hex) allows the Divisor Least Significant Byte to be entered. Address A7(hex) allows the Divisor Most Significant Byte to be entered. When bit 7 of the Line Control register is reset, port 27 (hex) addresses the Transmit and Receive buffers. Line Control register bits 0 and 1 control the number of data bits per character. Bit 2 determines the number of stop bits.

initializing the I/O port

1. Set bit 7 of Line Control register to gain access to the Divisor Latches.
2. Enter Divisor bytes.
3. Reset bit 7 of Line Control register and set up for desired mode.
4. Disable interrupts or set up for desired interrupt mode.
5. Set any desired output conditions with the Modem Control register.

reading I/O port

1. Read the Line Status register. Bit 0 will be set if a character is ready in the Receive buffer.
2. If a character is ready, read it from the Receive buffer. Bit 0 in the Line Status register will automatically be reset when the character is read.

writing to the I/O port

1. Read the Line Status register. Bit 5 will be set if the port is ready for a new character.
2. If the port is ready, write the character to the Transmit buffer.

The INS 8250 I/O port provides a simple solution for obtaining stable, software-selectable baud rates. I think the Terminal Unit design represents a reasonable compromise between circuit complexity and performance. Notes have been given on software design to help those interested gain a better understanding of Input/Output programming.

ham radio

John J. Meshna Jr., Inc.

19 Allerton Street • Lynn, MA 01904 • Tel: (617) 595-2275

DUAL FLOPPY DISC DRIVES

BRAND NEW, single sided, dual floppy disc drives made for Digital Equipment Corp. (DEC). This beautiful piece of computer hardware consists of 2 Shugart compatible TEAC 40 track, double density, 5 1/4" mini-floppy disc drives brand new in the case with their own regulated, switching power supply, cooling fan & on/off switch. Each unit also comes with a line cord & documentation. These were made for DEC, but are also compatible with other personal computers such as IBM, TRS 80 models I, II, & the Color Computer, and other Shugart compatible interfaces. Naturally, you supply the cables and disc controller card to suit your particular system. The RX-180 AB runs off of 115/230 VAC 50/60 Hz. w/out any modifications to the drives. Each system comes in the original factory box and are guaranteed functional. A blockbuster of a buy !!

Shpg. wt. 21 lb. stock no. RX 180AB \$250.00

RX 180 AB modified to run w/ the TI 99/4A \$285.00

Disc drive cable for Radio Shack Model I \$15.00 Disc drive cable for TI 99/4A \$15.00

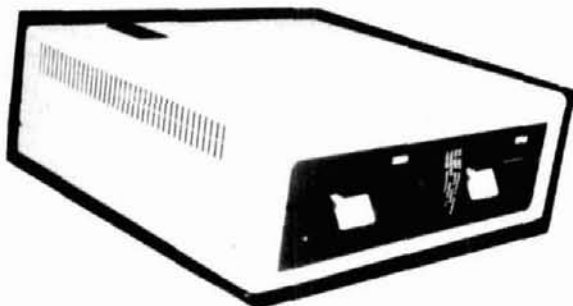

HIGH SPEED KSR PRINTER TERMINAL

World famous, high speed G. E. Terminet 1200 RS 232 KSR printer terminals are now in stock ready for shipment to you. This has to be one of the finest letter quality printers ever offered at a bargain price. These terminals can be used as an RS 232 asynchronous communications terminal or used in the local mode as a typewriter. The terminals were removed from service for upgrading. Highlights of these machines are: Standard RS 232, full duplex, asynchronous data comm., fully formed upper and lower case letters, 128 character ASCII set, selectable baud rates of 110, 300, or 1200 BPS, 80 columns on pin feed paper, and less weight & size than an ASR 35 teletype with far less racket. They are virtually electronically foolproof as every pc board is Pico fuse protected. Should your machine not work, just check the on board fuses & 9 out of 10 times that is where the problem lies. Schematics are provided w/ each machine sold. Current price of this machine new is over \$2000.00! Our meager price for this fantastic printer is only 10% of this: ~~\$200.00~~ each!!! Visually inspected prior to shipment to insure completeness. Shpd. truck freight collect. ~~\$200.00~~

NOW ONLY \$150.00

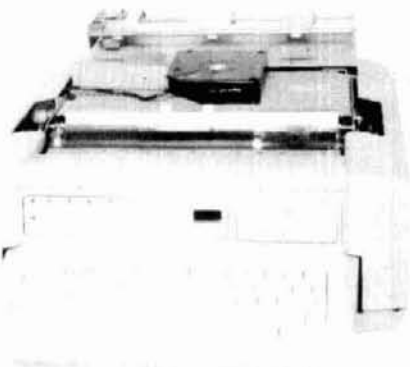

IBM 745 SELECTRIC BASED TYPEWRITER PRINTERS

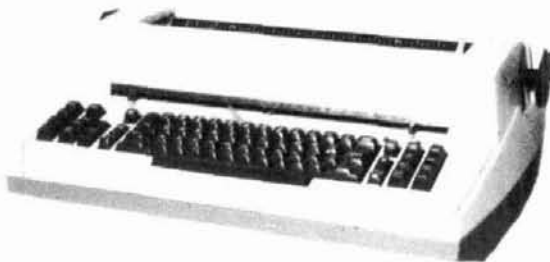

Send S.A.S.E. for free data sheet

These rugged, handsome printers were made for one of the giants of the computer industry. They can be used as a standard typewriter or as a printer in a word processing system for true letter quality printing. Solenoids were added to the selectric mechanism which disabled the manual repeat function but still allows electronic repeat functions. It uses standard IBM typing balls. The voltage requirements are standard 115 VAC, 5 VDC at 100 ma, and 24 VDC at 4 amps. All are new in factory boxes, but may require adjustments. We provide literature and schematics with 1 ribbon and cleaning tools. With the addition of our Centronics to Selectric I/O adapter, you could easily interface this printer to almost any micro computer system. Typewriter Printer stock no. RE 1000 A \$375.00, 745 manual \$30.00 Shpg wt approx. 80 Lbs, shpd by truck, collect.

CENTRONICS TO SELECTRIC INTERFACE

This interface will adapt a Redactron Selectric I/O typewriter mechanism to be used as a parallel ASCII compatible printer. The parallel input port provides compatibility to Centronics standards for both "busy" and "acknowledge" protocols. The interface requires only +5 VDC at 350 ma. This interface is fully built, less power supply, is guaranteed operational, and comes with data. Shpg wt. 15 lbs DE 201 A, \$245.00

FANTASTIC MASS STORAGE DISC DRIVE DEAL

1 MEG. quad disc drives, plus cases and power supplies for same. Listed below are the disc drives. Please call for more info. on the other components.

1/2 Height 1 Megabyte Disc Drives

Here we go with another blockbuster buy on disc drives which should make the competition's head spin. We are offering brand new, Mitsubishi no. 4853, 1/2 height, 1 megabyte, mini-floppy disc drives. These drives are beautiful. They are fully 34 pin, Shugart compatible. All are double sided, double density, 80 track /side units. Each runs on +5 vdc 0.5 amps & +12 vdc .7 amps. Just the drives to use with your IBM, Sanyo or other computer. Each order will come with schematics and pinout data Shpg. wt. 4 lb. SPL-85C-35 \$175.00 each 2/\$325.00

Buy 10 or more at \$135.00 each

Phone Orders accepted on MC, VISA, or AMEX
No COD's. Tel. 1-617-595-2275

Use with your:

- IBM
- Radio Shack
- Heath
- Xerox
- Sanyo

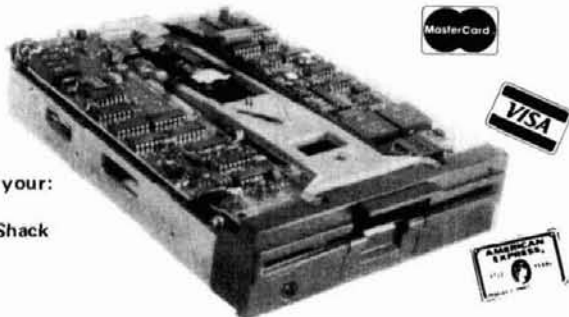

Surplus Electronic Material

Send for our free 72 page catalogue jam packed with goodies.

DoKay

COMPUTER
PRODUCTS.
Inc.

ORDER TOLL FREE

(800)
538-8800

(CALIFORNIA RESIDENTS)

(800)
848-8008



STATIC RAMS

2101	256 x 4 (450ns)	1.90
5101	256 x 4 (450ns) (cmos)	3.90
2102-1	1024 x 1 (450ns)	.79
2102L-4	1024 x 1 (450ns) (LP)	.89
2102L-2	1024 x 1 (250ns) (LP)	1.29
2111	256 x 4 (450ns)	2.29
2112	256 x 4 (450ns)	2.29
2114	1024 x 4 (450ns)	.99
2114-25	1024 x 4 (250ns)	1.10
2114L-4	1024 x 4 (450ns) (LP)	1.20
2114L-3	1024 x 4 (300ns) (LP)	1.30
2114L-2	1024 x 4 (200ns) (LP)	1.40
2147	4096 x 1 (55ns)	4.95
TMS4044-4	4096 x 1 (450ns)	2.95
TMS4044-3	4096 x 1 (300ns)	3.45
TMS4044-2	4096 x 1 (200ns)	3.95
MK4118	1024 x 8 (250ns)	8.95
TMM2016-20	2048 x 8 (200ns)	3.95
TMM2016-15	2048 x 8 (150ns)	4.45
TMM2016-10	2048 x 8 (100ns)	5.95
HMS116-4	2048 x 8 (200ns) (cmos)	4.40
HMS116-3	2048 x 8 (150ns) (cmos)	4.90
HMS116-2	2048 x 8 (120ns) (cmos)	5.90
HMS116L-4	2048 x 8 (200ns) (cmos) (LP)	4.40
HMS116L-3	2048 x 8 (150ns) (cmos) (LP)	5.90
HMS116L-2	2048 x 8 (120ns) (cmos) (LP)	7.90
Z-6132	4096 x 8 (300ns) (Qstat)	29.95
HMS264P-15	8192 x 8 (150ns) (cmos)	19.95
HMS264L-15	8192 x 8 (150ns) (cmos) (LP)	22.95
HMS264L-12	8192 x 8 (120ns) (cmos) (LP)	24.95

LP = Low Power Qstat = Quasi-Static

DYNAMIC RAMS

TMS4027	4096 x 1 (250ns)	1.45
UPD411	4096 x 1 (300ns)	1.95
MMS280	4096 x 1 (300ns)	1.95
MK4108	8192 x 1 (200ns)	.49
MMS298	8192 x 1 (250ns)	.49
4115-20	16384 x 1 (200ns)	.79
4116-15	16384 x 1 (150ns)	.99
4116-12	16384 x 1 (120ns)	1.49
2118	16384 x 1 (150ns) (5v)	3.95
4164-25	65536 x 1 (250ns) (5v)	2.00
4164-20	65536 x 1 (200ns) (5v)	2.20
4164-15	65536 x 1 (150ns) (5v)	2.52
41256-20	262144 x 1 (200ns)	12.95
41256-15	262144 x 1 (150ns)	15.95

5V = Single 5 Volt Supply

EPROMS

1702	256 x 8 (1µs)	3.95
2708	1024 x 8 (450ns)	2.49
2758	1024 x 8 (450ns)	5.90
2716	2048 x 8 (450ns) (5v)	2.95
2716-1	2048 x 8 (350ns) (5v)	3.95
TMS2516	2048 x 8 (450ns) (5v)	3.95
TMS2716	2048 x 8 (450ns) (5v)	6.95
TMS2532	4096 x 8 (450ns) (5v)	3.95
2732	4096 x 8 (450ns) (5v)	3.95
2732 A-4	4096 x 8 (450ns) (21v)	3.95
2732 A-35	4096 x 8 (350ns) (21v)	3.95
2732 A	4096 x 8 (250ns) (21v)	5.95
2732 A-2	4096 x 8 (200ns) (21v)	8.95
2764	8192 x 8 (450ns) (5v)	4.95
2764-25	8192 x 8 (250ns) (5v)	5.95
2764-20	8192 x 1 (200ns) (5v)	9.95
TMS2584	8192 x 8 (450ns) (5v)	9.95
MC680704	8192 x 8 (450ns) (5v) (24-pin)	17.95
MC680706	8192 x 8 (350ns) (5v) (24-pin)	19.95
27128-45	16384 x 8 (250ns) (5v)	14.95
27128-30	16384 x 8 (300ns) (5v)	16.95
27128-25	16384 x 8 (250ns) (5v)	18.95
27256-25	32768 x 8 (250ns) (14v)	78.95

5v = Single 5 Volt Supply

74LS00

74LS00	23	74LS125	.48	74LS260	.58
74LS01	24	74LS126	.48	74LS266	.54
74LS02	24	74LS132	.58	74LS273	1.45
74LS03	24	74LS133	.58	74LS275	3.30
74LS04	23	74LS136	.38	74LS279	.48
74LS05	24	74LS137	.98	74LS280	1.95
74LS08	27	74LS138	.54	74LS283	.88
74LS09	28	74LS139	.54	74LS290	.88
74LS10	24	74LS145	1.15	74LS293	.88
74LS11	34	74LS147	2.45	74LS295	.98
74LS12	34	74LS148	1.30	74LS298	.88
74LS13	44	74LS151	.54	74LS299	1.70
74LS14	58	74LS153	.54	74LS323	3.45
74LS15	34	74LS154	1.85	74LS324	1.70
74LS20	24	74LS155	.88	74LS352	1.25
74LS21	28	74LS156	.88	74LS353	1.25
74LS22	24	74LS157	.64	74LS363	1.30
74LS26	28	74LS158	.58	74LS364	1.90
74LS27	28	74LS160	.88	74LS365	.48
74LS28	34	74LS161	.84	74LS366	.48
74LS30	24	74LS162	.88	74LS387	.44
74LS32	28	74LS163	.84	74LS388	.44
74LS33	54	74LS164	.88	74LS373	1.35
74LS37	34	74LS165	.94	74LS374	1.35
74LS38	34	74LS166	1.90	74LS377	1.35
74LS40	24	74LS168	1.70	74LS378	1.13
74LS42	48	74LS169	1.70	74LS378	1.30
74LS47	74	74LS170	1.45	74LS385	1.85
74LS48	74	74LS173	.88	74LS386	.44
74LS49	74	74LS174	.54	74LS390	1.15
74LS51	24	74LS175	.54	74LS393	1.15
74LS54	28	74LS181	2.10	74LS395	1.15
74LS55	28	74LS189	8.90	74LS399	1.45
74LS63	120	74LS190	.88	74LS424	2.90
74LS73	38	74LS191	.88	74LS447	.38
74LS74	34	74LS192	.78	74LS490	1.90
74LS75	38	74LS193	.78	74LS824	3.95
74LS76	38	74LS194	.88	74LS840	2.15
74LS78	48	74LS195	.88	74LS845	2.15
74LS83	59	74LS196	.78	74LS868	1.65
74LS85	68	74LS197	.78	74LS869	1.85
74LS86	38	74LS221	.88	74LS870	1.45
74LS90	54	74LS240	.94	74LS874	9.80
74LS91	88	74LS241	.98	74LS882	3.15
74LS92	54	74LS242	.98	74LS883	3.15
74LS93	54	74LS243	.98	74LS884	3.15
74LS95	74	74LS244	1.25	74LS885	3.15
74LS96	88	74LS245	1.45	74LS888	2.35
74LS107	38	74LS247	.74	74LS889	3.15
74LS109	38	74LS248	.98	74LS783	23.95
74LS112	38	74LS249	.98	81LS99	1.45
74LS113	38	74LS251	.58	81LS96	1.45
74LS114	38	74LS253	.58	81LS97	1.45
74LS122	44	74LS257	.58	81LS98	1.45
74LS123	78	74LS258	.58	26LS2521	2.75
74LS124	2.85	74LS259	2.70	26LS2569	4.20

CRT CONTROLLERS

6845	11.95	8275	28.95
68845	18.95	7220	38.95
H046505sp	11.95	CRT5027	18.95
6847	10.95	CRT5032	28.95
MC1372	6.90	TMS9918A	36.95
68047	23.95	DP8350	48.95

DISC CONTROLLERS

1771	14.95	2797	54.95
1791	21.95	6843	33.95
1793	25.95	8272	18.95
1795	21.95	UPD765	18.95
1797	21.95	M88876	23.95
2791	49.95	M88877	25.95
2793	49.95	1691	6.95
2795	54.95	2143	6.95

UV ERASERS

QUV-T8/1 \$49.95
ECONOMY Model

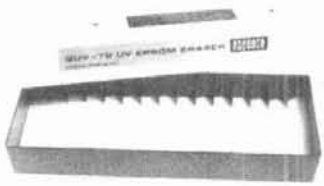

- Erases 15 EPROMS in 20 minutes
- Plastic Enclosure

6500

1 MHz		2 MHz	
65022	4.90	6502A	5.90
6504	6.90	6520A	5.90
6505	8.90	6522A	9.90
6507	9.90	6532A	10.90
6520	4.30	6545A	12.90
6522	4.90	6551A	10.90
6532	9.90		
6545	9.90		
6551	9.90	6502B	7.90

6800

1 MHz		68800	
6800	2.90	68800	2.90
6802	7.90	68800-2	9.90
6803	17.90	68802	11.90
6808	12.90	68809	11.90
6809E	8.90	68809E	11.90
6809	8.90	68810	5.90
6810	2.90	68821	5.90
6820	4.30	68840	18.90
6821	2.90	68845	18.90
6828	13.90	68850	5.90
6840	11.90		
6843	33.90		
6844	24.90		
6845	11.90		
6847	10.90		
6850	2.90		
6852	5.90		
6860	7.90		
6862	10.90		
6875	6.90		
6880	1.90		
6883	21.90		

68000

8031	14.90	8253	6.90
8035	5.90	8253-5	7.90
8039	5.90	8255	4.45
INS-8060	16.90	8255-5	4.90
INS-8073	29.90	8257	7.90
8080A	3.90	8257-5	8.90
8085	4.90	8259	5.90
8085A-2	11.90	8259-5	6.90
8086	24.90	8271	69.90
8087-3 (5 MHz)	159.90	8272	19.90
8087-2 (8 MHz)	279.90	8274	28.90
8088	19.90	8275	28.90
8089	59.90	8279	5.90
		8279-5	7.90
		8282	6.45
		8283	6.45
		8284	4.90
		8285	6.45
		8287	6.45
		8288	12.90
		8289	44.90
		8292	12.90

8100

8131	2.90	8284	4.90
8155	6.90	8285	6.45
8155-2	7.90	8287	6.45
8156	6.90	8288	12.90
8185	28.90	8289	44.90
8185-2	38.90	8292	12.90

8200

8202	23.90	8303	2.90
8203	38.90	8304	1.90
8205	2.90	8307	2.90
8212	1.75	8308	2.90
8214	3.75	8310	3

ROBOT KITS! PIPER-MOUSE



Controlled by sound sensor and 1-channel electronic circuit. Use the whistle in this kit and Piper-Mouse follows your commands, turning left or right, stopping and starting. Uses 2 AA and 1 9V battery (not included).

MV-915 \$44.95
RIBBON CABLE

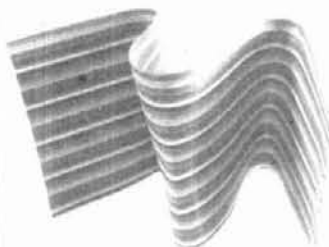

CONTACTS	SINGLE COLOR		COLOR CODED	
	1'	10'	1'	10''
10	.45	4.30	.78	7.20
16	.50	4.70	.95	8.70
20	.60	5.60	1.15	10.90
25	.70	6.50	1.22	11.50
26	.70	6.50	1.27	11.50
34	.93	8.50	1.55	14.40
40	1.27	11.50	1.82	16.70
50	1.28	12.00	2.40	21.90

RESISTORS

1/4 WATT 5% CARBON FILM
ALL STANDARD VALUES
FROM 1 OHM - 10 MEG OHM

50 PCS 1.25
100 PCS 2.00
1,000 PCS 15.00



**Checkmate
Technology,
Inc.**

**APPLE IIe Special
Extended 80-Col.
VIDEO CARD**

\$69.95

★ 64K to 128K ★
MULTIVIEW 80/160 249.00

80-160 columns with any monitor!

- Screens: 80x24, 80x32, 80x48, 96x24, 132x24, 132x30, 160x24
- On-screen **BOLD** and **Underline**
- Reverse scrolling
- Easy-to-read **Wide-angle** mode
- Apple II and IIe compatible
- Prompt lines
- Upper & lowercase letters



APPLE & IBM ACCESSORIES

- 80 Column Apple II+ ... 149.95
- 80 Column Apple IIe ... 119.95
- Z80 Apple II+ 89.00
- Z80 Apple IIe 89.00
- 16K Card 39.95
- Cooling Fan 38.95
- Power Supply 74.95
- Joystick 29.95
- RF Modulator 13.95
- Disk Drive 169.95
- Controller Card 59.95
- Paddles 7.95



VIEWMAX-80 149.95

80-Column card for Apple II series

- Video Soft Switch
- Inverse Video
- VIDEX's Videoterm compatible



VIEWMAX-80e 119.95

80-Column extended video card for Apple IIe

- 64K RAM, expandable to 128K
- Double High-resolution circuit
- Compatible with Pascal & CP/M



PRINTMAX 59.95

Parallel printer card, Apple II series

- Centronics compatible
- Variable print widths
- Up to 5000 characters/second

APPLE & IBM Compatible DISK DRIVES

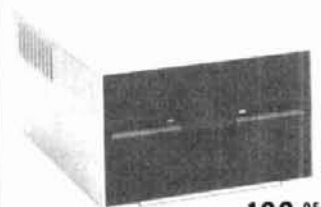

169.95

- Shugart mechanism, made in U.S.A.
- Directly replaces Apple Disk II
- Fully compatible with Apple Controller or other Apple compatible controllers
- One Year Warranty

FULL or 1/2-Height

16K RAM Card - Apple II+

- 2-Year Warranty



Assembled & Tested **39.95**

APPLE or IBM JOYSTICK

\$29.95

Compatible for either:
APPLE II and APPLE IIe
OR
IBM-PC, JR., & IBM-XT
MULTIFUNCTION CARD



- 64K to 384K RAM
- Parallel Port
- Serial Port
- Clock Calendar
- Software Included
- 1-Year Warranty

\$249.95

MEMORY CARD



- Expandable to 512K
- Fully compatible with IBM software
- Fully compatible w/IBM diagnostic utilities
- Serial Port Available
- 1-Year Warranty

\$199.95

MEMORY EXPANSION KIT



4164 200ns
9 for \$19.98

DISKETTES

5 1/4"

ATHANA: (SOFT SECTOR w/HUB RING)

25 per package

SS/DD 29.75 or 1.19 ea.

DS/DD 34.75 or 1.39 ea.

**LIFETIME WARRANTY
ON ALL ATHANA DISKETTES**

NO LABEL: (SOFT SECTOR w/HUB RING)

25 per package

SS/DD 24.75 or .99 ea.

DS/DD 29.75 or 1.19 ea.

**2-YEAR WARRANTY
ON ALL BULK DISKETTES**

ROBOT KITS! PEPPY



2-way sensor detects noise or solid objects in its path. When front sensor contacts an obstacle or hears a loud noise (hand-clap), Peppy automatically turns to the left.

Uses 2 AA and 1 9V battery (not included).

MV-916 \$24.95

Reg. Power Supply Model 4A/PS (99/4)

3 DC Outputs:

12V @ .4A, +5V @ 1.1A
-5V @ .2A Highly Filtered

6.95



KEYBOARD (99/4)

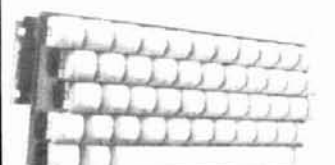

48 keys 4" x 10" 6.95

TERMS: Minimum order \$10.00. For shipping and handling, include \$2.50 for UPS ground or \$3.50 for UPS Blue (air). For each additional air pound, add \$1 for UPS Blue shipping and handling. California residents must include 6% sales tax. Bay area and LA residents include 6 1/2% sales tax. Prices are subject to change without notice. We are not responsible for typographical errors. We reserve the right to limit quantities and to substitute manufacturers. All merchandise subject to prior sale.

CALL for VOLUME Quotes

HOURS: Mon. - Fri 7:30 to 5:00
Saturdays 10:00 to 3:00

VISIT OUR RETAIL STORE

2100 De La Cruz Blvd.
Santa Clara, CA 95050
(408) 988-0697

**ALL MERCHANDISE IS
100% GUARANTEED**

Telex: 756440

DoKay

run RTTY on your VIC-20

Interface allows
VIC-20 to command
transceiver for CW
and RTTY operation

It all started at a meeting of our ham club, when KB4SM sold me a Kantronics *Hamsoft*[™] cartridge (He had just upgraded to *Hamtext*[™].) So I plugged *Hamsoft* into my VIC-20 and rigged my key to see how the unit would print my CW. I found it to be very critical of

my fist, with such aberrations as "the" coming out as "6E." After rigging a diode to rectify the receiver audio, I found that it was just as critical of the other fellow's keying, so I felt better.

Next came the RTTY, which was the main purpose of the project. I used an LM567 chip, and sure enough, it printed out some of the stuff that I tuned in. At this point it became only too obvious that extra selectivity was essential, so I looked in some back issues of *ham radio* and found an active bandpass filter design¹ using an LM3900 chip that I had picked up at the Memphis Hamfest (fig. 1). With these two units combined, reception was quite tolerable. I hooked a pair of high-impedance headphones at the output of the bandpass filter to aid in tuning in the signal.

The next consideration was transmission of RTTY and CW. National Semiconductor's *Linear Handbook* provided a circuit for the AFSK oscillator. The output was found to be a square wave of several volts, peak-to-peak. This was far too much signal to substitute for the usual microphone output, so a three-section RC filter was introduced. In order to load the RC oscillator as lightly as possible, the input resistor was chosen to be about 39 kilohms, with the others being 12 kilohms. (These may be increased if the audio output should still be somewhat high.) Capacitors were all 0.01 μF ceramic. The output was now a nice looking sine wave, necessary for a clean signal.

circuit adjustments

To vary the frequency of the AFSK oscillator, a smaller capacitor is switched in and out of the frequency-determining circuit by a 2N2222 transistor. When used in this function, no DC voltage is applied to the collector of the transistor.

The AFSK oscillator frequency is given as the reciprocal of the RC product. A capacitor of 0.068 μF was combined with a resistor of 6.8 kilohms. The smaller capacitor that is switched for frequency

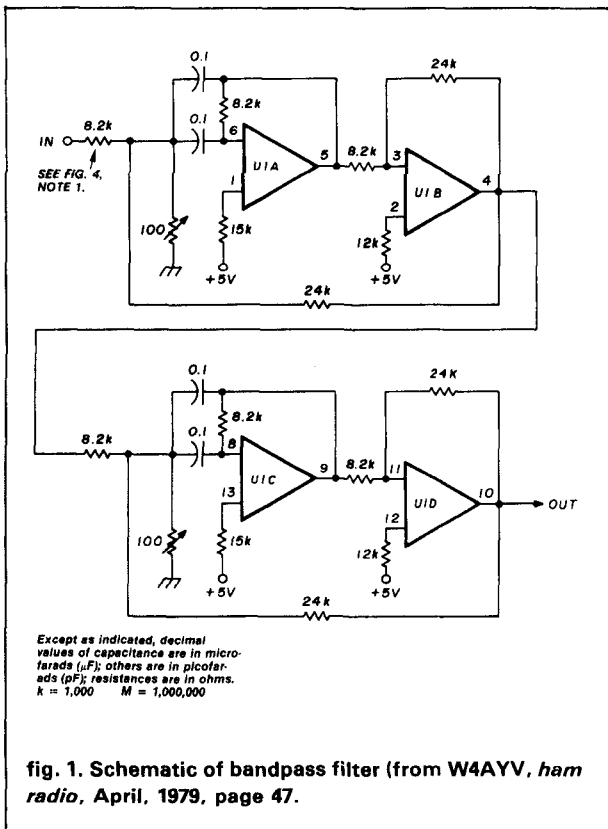

By Henry S. Keen, W5TRS, Fox, Arkansas 72051

change is 0.0056 μF . If you have a frequency counter available, the AFSK oscillator output may be established and adjusted, if necessary. It is more important to obtain a frequency shift of 170 Hz, when using an SSB transceiver, because corrections are automatic as the signal is tuned in.

The frequency of the bandpass filter is now adjusted to peak at the frequency of the AFSK oscillator by means of the two 100-ohm trim pots.

Next, the position of the potentiometer controlling the PLL frequency of the decoder, when its frequency coincides with that of the AFSK oscillator, must be determined. This is done by applying DC to both chips and either comparing the signals on a scope or combining them through a temporary resistive network, and adjusting to zero beat. This is the normal operating position. Any minor differences between your frequency and that of the other station will be compensated with this control, so that your transmitting frequency will not be affected.

For CW operation, a PNP transistor operates a reed relay that keys the transmitter directly. Although the transistor might do the job without the relay, I did not want to take a chance that some problem with the transmitter might damage the computer.

space and mark signals

The decoder chosen makes use only of the mark signal and ignores the space signal. Although marginal signals may better be handled by a decoder that makes use of both components, this is a satisfactory arrange-

table 1. Parts list.

quantity	description
1	LM3900 quad amplifier
2	LM567 tone decoders
1	14-pin socket
2	8-pin sockets
5	0.1 μF Mylar capacitors
5	0.01 μF ceramic disc capacitors
1	0.1 μF ceramic disc capacitor (can use Mylar)
2	1.0 μF tantalum capacitors
1	0.068 Mylar capacitor
1	0.0056 Mylar capacitor
2	1 kilohm 1/4-watt resistors
1	3 kilohm 1/4-watt resistor
6	8.2 kilohm 1/4-watt resistors
4	24 kilohm 1/4-watt resistors
4	12 kilohm 1/4-watt resistors
2	15 kilohm 1/4-watt resistors
1	6.8 kilohm 1/4-watt resistor
1	2N2222 transistor
1	2N3906 transistor
1	5-volt reed relay
1	LED
1	DPDT slide or toggle switch
3	miniature 2-circuit jacks
1	miniature 3-circuit jack
1	5 kilohm linear potentiometer
1	4 \times 5 inch PC board, copper on one side
1	18-pin edge connector (optional)

suitable housing box for interface

appropriate cables and connectors to mate with transceiver

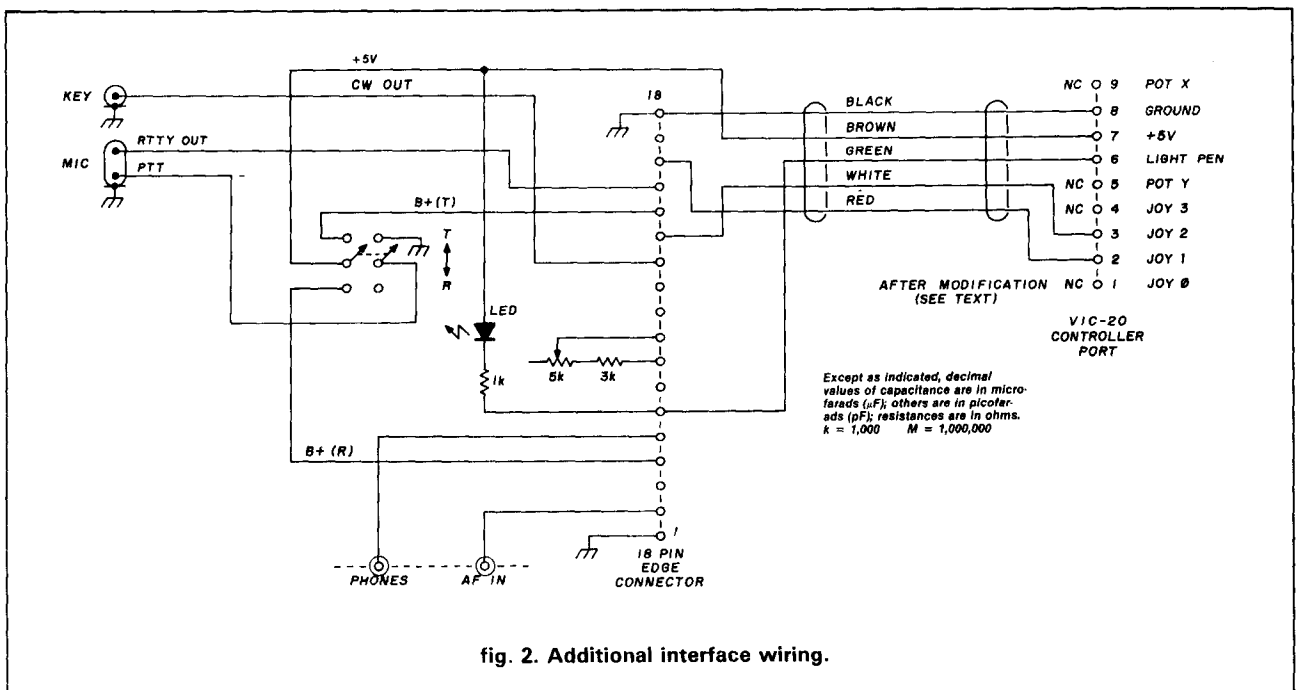

fig. 2. Additional interface wiring.

SEE YOU AT DAYTON



AT LAST!! A VERY AFFORDABLE COMPUTER
AT A VERY AFFORDABLE PRICE

POWERFUL FULLY PROGRAMMABLE WITH 2K OF MEMORY—PORTABLE—6.78" x 1.38" INCH MODULE SINGLE KEY ENTRY COMMANDS—DURABLE 40 KEY MEMBRANE TYPE KEYBOARD—280A BASED FOUR CHIP DESIGN—EDUCATIONAL—UNIQUE SYNTAX CHECK REPORT CODES FOR ERROR IDENTITY—GRAPH DRAWING AND ANIMATED DISPLAY—ACCURATE TO 9/10 DECIMAL PLACES FOR FULL RANGE MATH AND SCIENTIFIC FUNCTIONS—AT AN AFFORDABLE PRICE.

WE CANNOT TELL YOU THE MAKE OF THE COMPUTER BUT IT WAS MADE BY A FAMOUS WATCH COMPANY. THEY USED TO SELL FOR \$99.95.

WE BOUGHT OUT WHAT THE FACTORY HAD LEFT IN STOCK AND HAD TO REMOVE THE LABELS, THESE UNITS ARE UNPACKAGED LESS THE 9V WALL ADAPTER AND MANUAL BECAUSE THIS IS A DISCONTINUED ITEM THERE IS NO WARRANTY.

GET THEM WHILE THEY LAST

LIMITED SUPPLY

BUY 1st UNIT FOR \$19.95 BUY 2nd FOR \$16.95 9V DC WALL ADAPTOR \$4.95
BUY THE 3rd UNIT (NON OPERATING FOR PARTS) \$10.95 MANUAL (OVER 150 PAGES) \$2.95

See September 1984 issue of 73 for TIMEXRTTY article

CHIP BONANZA (AT THESE PRICES THEY ARE A STEAL)

2708 8K EPROMS (REG. \$4.95)	\$1.50 EA OR 10 FOR \$12.50
2716 16K EPROMS (REG. \$5.95)	\$3.00 EA OR 10 FOR \$25.00
2732 32K EPROMS	\$4.95 EA OR 10 FOR \$45.00
2764 64K EPROMS (REG. \$6.95)	\$5.50 EA OR 10 FOR \$50.00
27128 128K EPROMS	\$19.95 EA OR 10 FOR \$195.00
6502	\$4.95 EA OR 10 FOR \$45.00
6810 (REG. \$3.95)	\$1.95 EA OR 10 FOR \$18.00
68A00 (REG. \$19.95)	\$5.95 EA OR 10 FOR \$50.00
68A21 (REG. \$9.95)	\$2.95 EA OR 10 FOR \$25.00
4116 AMD 9016EPC 200 ns	\$1.25 EA OR 8 FOR \$ 8.00
TMS 99001L MICRO-P 84 PIN 8 BIT D/B x 16 BIT CPU	\$ 4.95
TMS 99014L MICRO-P PSI	\$ 2.95
TM 99049L MICRO-P CLOCK GEN. AND DRIVER	\$ 3.95
TMS 99184L MICRO-P COLOR GRAPHICS AND DISPLAY KEYBOARD (994) 48 KEYS MEASURE 4 x 10 (H-TEX)	\$ 9.95

16K RAM MODULES	NEW \$29.95
GAME CASSETTES & CORDS AVAIL.	CALL OR WRITE

SWITCHING POWER SUPPLY

MODEL 6A-PS (994) 1 DC OUTPUT VOLTAGES:
12 V AT 40 AMP
5 V AT 1 AMP
5 V AT 2 AMP
HIGHLY FILTERED
REQUIRES 24 V AT 40 WATT TRANSFORMER AS USED IN THE 1-99 SUGGESTED LIST OF \$39.95

HAL TRONIX PRICE \$12.95
OR 2 FOR \$20.00
LIMITED SUPPLY

APPLE II and APPLE II - COMPUTER MAINFRAMES (fully populated) \$150*

Power supply, case and keyboard, separately available. Call or Write

Unit as described above, fully assembled & tested \$300 plus shipping

*Typo in February Ad price should be \$150.00

(HOT ITEM) IF YOU'RE TRYING TO BUILD THE CABLE DECODER AS FEATURED IN THE FEB. ISSUE OF RADIO ELECTRONICS, WE HAVE THE HARD TO GET COILS AND MOST OF THE PARTS

FSK DEMODULATOR/TONE DECODER KH-2111 (SPECIAL) \$2.95

LIMITED QUANTITY—5 PER CUSTOMER

SHIPPING INFORMATION: ORDERS OVER \$25 WILL BE SHIPPED POST-PAID EXCEPT ON ITEMS WHERE ADDITIONAL CHARGES ARE REQUESTED. ORDERS LESS THAN \$25 PLEASE INCLUDE ADDITIONAL \$2.50 FOR HANDLING AND MAILING CHARGES. MICHIGAN RESIDENTS ADD 4% SALES TAX. SEND 20¢ STAMP OR SASE FOR FREE FLYER. CANADIAN ORDERS ADD \$5.00 POSTAGE IN U.S. FUNDS.

HAL-TRONIX, INC.
P.O. BOX 1101 - DEPT. HR
SOUTHGATE, MICH. 48195
PHONE (313) 285-1782



"HAL" HAROLD C. NOWLAND
W8ZXH

✓ 166

HOBBY KITS®

EXPERIMENT — LEARN ELECTRONICS
BUILD AND DESIGN YOUR OWN AM, FM, CW,
OR SSB RECEIVERS, TRANSMITTERS AND ETC.

WITH OUR MINI-LINEAR CIRCUIT KITS

All kits Come Complete With Etched and Drilled Circuit Boards and All Parts Needed To Function As Described

- AFA-1 AUDIO AMP, LM 380 1-2 Watts 4-16 OHM Output \$4.95
- AFP-1 AUDIO PREAMP, Dual Audio Preamp — For Mike Etc. \$3.95
- BMD-1 BAL. MIX., LM 1496 Mixer — S-B Modulator Tuned Output \$9.95
- DET-1 AM DET., Am Envelope Detector With AGC Tuned Output \$3.95
- DET-2 FM DET., LM 3065 FM Detector (455 KHZ or 4-11 MHz) \$7.95
- DET-3 SSB DET., LM 1496 SSB Detector (Needs OSC-1 or OSC-4) \$9.95
- DET-4 DETECTOR CW/SSB using a dual gate FET transistor \$4.95
- IFA-1 IF AMP, CA 3028 30 DB Gain, Optional AGC (455 KHZ or 9-11 MHz) \$6.95
- FLS-9 SSB FILTER 9 MHz/2 1 KHZ BW with USB XAL for OSC-1 \$49.95
- IFA-2 IF AMP, CA 3028 30 DB Gain 1-100 MHz Optional AGC \$6.95
- MBA-1 FREQ. MULT., Tuned Output Buffer-Mult. Amplifier To 250 MHz \$5.95
- OSC-1 CRYSTAL OSC., 100 KHZ — 20 MHz Not Tuned \$3.95
- OSC-2 CRYSTAL OSC., Ov. 18-200 MHz Tuned Output \$4.95
- PSV-1 POWER SUPPLY LM 723 With Pass Transistor, 3 amps max \$7.95
- PLL-2 TONE DETECTOR LM567 PLL Tone Detector \$5.95
- RF/MIX-1 RF-AMP/MIXER CA 3028 — Tuned RF AMP/Mixer 1-100 MHz \$7.95
- RF/MIX-2 RF-AMP/MIXER 3N204 Tuned RF AM/Mixer 1 — 250 MHz \$7.95
- VCO-3 VARIABLE HI STAB OSC., Varactor tuned, 400 to 600 KHz output \$7.95
- VCO-4 VARIABLE HI STAB OSC., Varactor tuned, 3 to 20 Mhz output \$7.95

Add \$2.00 For Shipping & Handling — Send For FREE Brochure
SEND \$2.00 FOR FULL MANUAL WITH CIRCUIT DIAGRAMS AND TYPICAL RECEIVER AND TRANSMITTER HOOKUPS
MANY OTHER MODULES AVAILABLE

MORNING DISTRIBUTING CO.

P.O. BOX 717, HIALEAH, FLA. 33011

✓ 167



C-64 + DX Edge = Fun

USE THE INEXPENSIVE COMMODORE C-64

Now generate your own Grayline display.

Now that Commodore has reduced the price of the C-64 computer to \$150, there is little reason why you don't own one for your ham station. Xantek has adapted their best selling DX Edge to the computer world and it comes at a very reasonable price. Just \$34.95 brings into your ham shack the ability to know and predict when and where DX is going to appear. The DX Edge shows you the sun's path across the earth. When you are using the program, the computer will automatically update the information as the sun progresses across the face of the Earth. To make the computerized DX Edge even easier to use, the display is keyed to the DXCC list and the 40 CQ zones. Disk and documentation are just \$34.95. This is something you've GOT to have! ©1985.

☐ XN-C64

\$34.95

Please enclose \$3.50 for shipping and handling.

Prices U.S. Funds only.

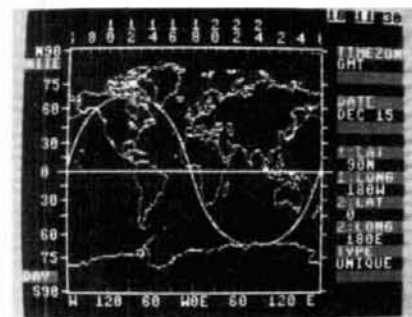

ham radio magazine
GREENVILLE, NH 03048

BOOKSTORE

(603) 878-1441

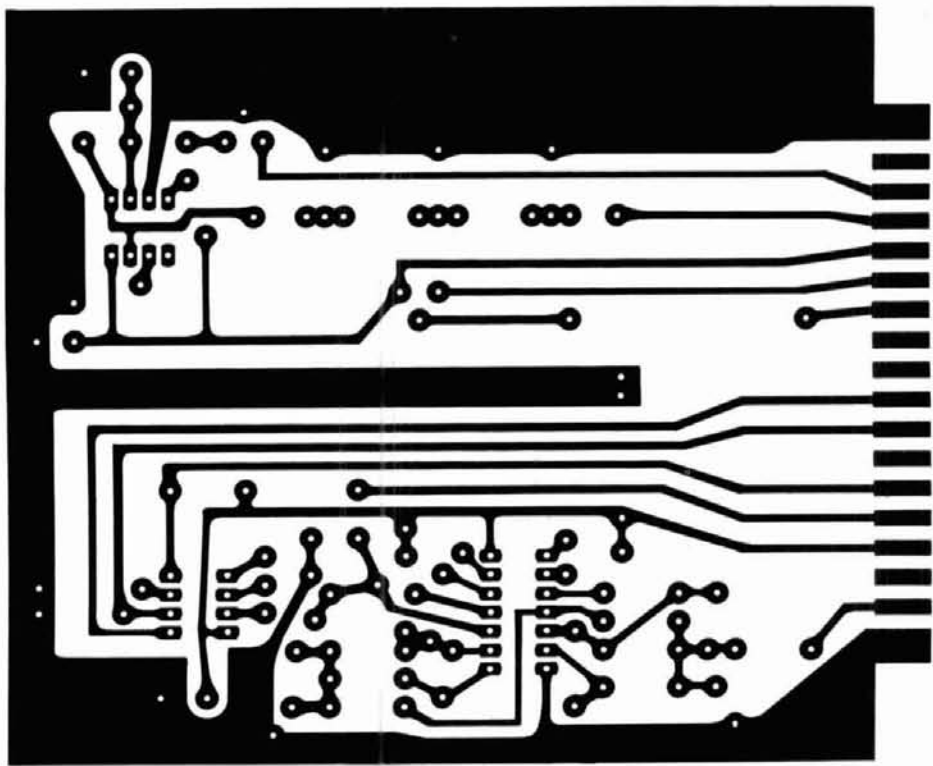

fig. 3. Foil side of PC board for the CW/RTTY.

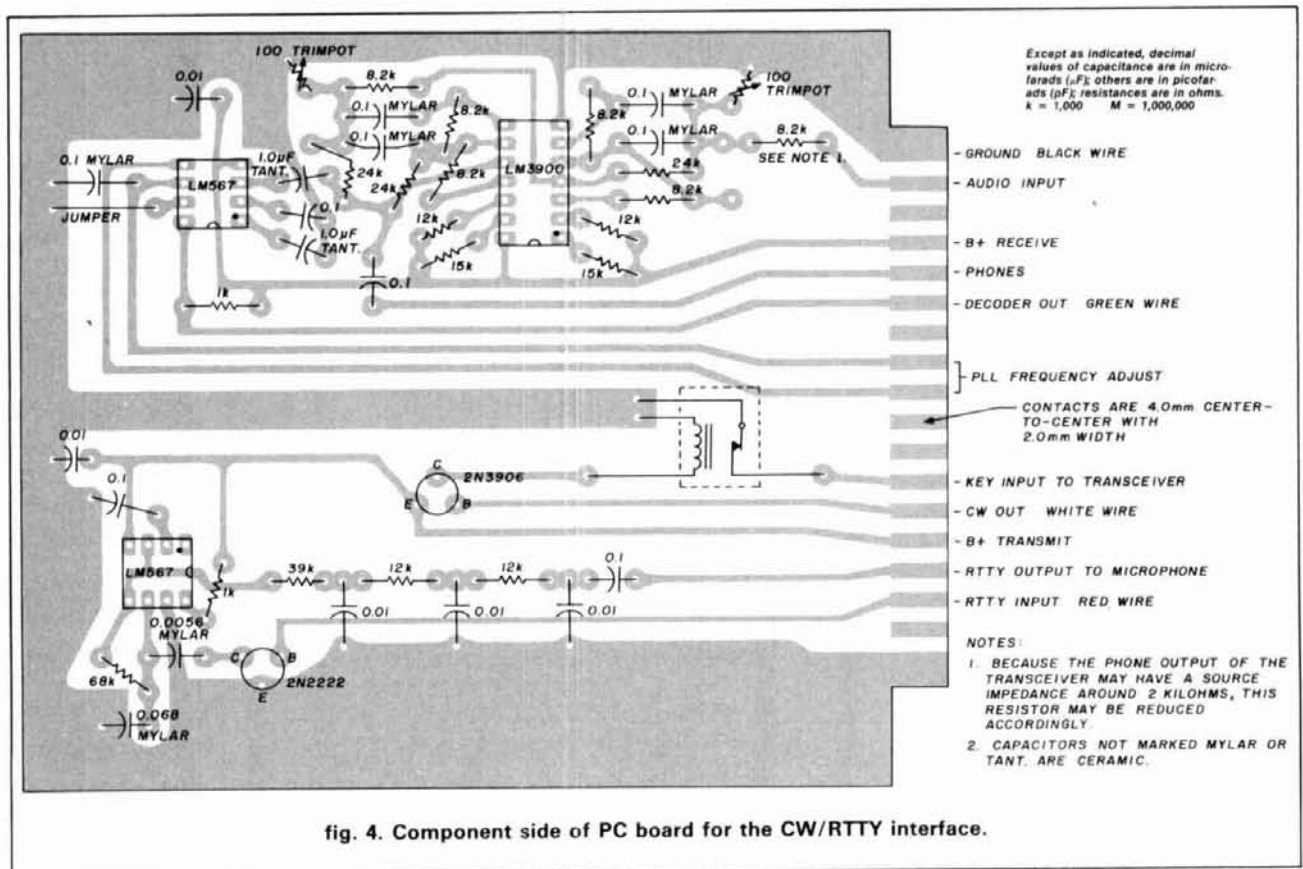

fig. 4. Component side of PC board for the CW/RTTY interface.

DAYTON Hamvention®

April 26, 27, 28, 1985
Hara Arena and Exhibition Center
Dayton, Ohio



- ★ Giant 3-Day Flea Market
Starting Noon Friday
All Day Saturday and Sunday
- ★ Technical Forums
- ★ ARRL and FCC Forums
- ★ FCC Examinations
- ★ New Products and Exhibits
- ★ Grand Banquet
- ★ Alternative Activities
- ★ Electrical Safety Forum
- ★ Special Group Meetings
- ★ YL Forum
- ★ Personal Computer Forum
- ★ Int'l. VHF/UHF Conference
- ★ CW Proficiency Awards
- ★ Amateur of Year Award
- ★ Special Achievement Awards

Meet your amateur radio friends from all over the world at the internationally famous Dayton HAMVENTION.

Seating will be limited for the Grand Banquet and Entertainment on Saturday evening so please make reservations early. Noted humorist Jean P. Sheperd, K2ORS, will return for his third appearance as Banquet Speaker. His presentation promises to be outstanding in an all new banquet program format.

If you have registered within the last 3 years you will receive a brochure in January. If not, write Box 44, Dayton, OH 45401.

Nominations are requested for Radio Amateur of the Year, Special Achievement and Technical Excellence Awards. Nomination forms are available from Award Chairman, Box 44, Dayton, Ohio 45401 and must be returned by April 1, 1985.

For special motel rates and reservations write to Hamvention Housing, 1980 Kettering Tower, Dayton, OH 45423-1980. **NO RESERVATIONS WILL BE ACCEPTED BY TELEPHONE.**

FCC EXAMS

All elements to be administered. Advanced registration only. **DEADLINE TO REGISTER: March 27, 1985.**

- \$4.00 check or money order made payable to ARRL/VEC
- Completed 610 form with copy of license
- Indicate preferred sitting time: Sat. 9 a.m., Sat. 1 p.m., Sun. 9 a.m.

Mail registration to: FCC Exams, 203 Bellewood St.
Dayton, OH 45406

All other inquiries write Box 44, Dayton, OH 45401 or phone (513) 433-7720.

Flea Market spaces will be sold in advance ONLY. NO spaces sold at gate. Entrance for set-up available starting Thursday. Special Flea Market telephone (513) 223-0923.

Bring your family and enjoy a great weekend in Dayton.

Sponsored by
The Dayton Amateur Radio Association, Inc.

ADMISSION
\$8 in advance, \$10 at door.
(Valid for all 3 days)

BANQUET
\$14 in advance, \$16 at door.

FLEA MARKET SPACE
\$17 in advance.
(Valid for all 3 days)

Checks for advance registration to
Dayton HAMVENTION
Box 2205, Dayton, Ohio 45401

**Registration processing
starts Jan. 1, 1985.**

Piedmont Airlines Hamvention Special Fares — Call 1-800-334-8644 for details and reservations.

ment; signals that read R1 on the meter will usually give good print. A minor advantage appears with this decoder when widely different frequency shifts are encountered, because they present no problem to the mark-only decoder.

Most RTTY transmission and reception is on the LSB mode of the transceiver. In transceivers with provisions in the IF channel for a CW filter, this filter will usually be found to be tied into the USB mode. A number of stations operate this way, with inverted signals. Reception is easily corrected by adjusting the PLL frequency.

Accommodating transmission to the USB mode may be done in several ways. A friend assures me that if I press the K button instead of T, when activating the system, the transmission will not be inverted when on the USB mode. I haven't tried it, so I'm not sure. Another way would be to locate a transistor inverter stage between the decoder output and the computer light pen input terminal, and another in front of the NPN keyer transistor.

power supply notes

A separate power supply was originally used for the interface, but one day the bandpass filter as well as the decoder and AFSK oscillator were run from a 5-volt common supply. Because little if any difference could be detected, 5 volts was used for the entire interface. The importance of this finding was that now the power to the interface could be supplied by the computer eliminating a separate DC source. The VIC-20 can supply +5 volts at up to 100 mA; the interface requires about 20 mA.

The cable that comes with the *Hamsoft* cartridge has five wires: black for ground, green for demodulator input, white for CW output, red for RTTY output, and brown for RTTY output (inverted). This last capability was exchanged for +5 volts supply, by removing the pin from hole No. 1 and moving it to hole No. 7. This probably eliminates the previously mentioned possibility of inverting the signal with the K for T change. However, the elimination of a separate power supply is well worth the effort.

additional wiring

Additional wiring included a DPDT slide switch for transmit or receive. The +5 volts is switched from the bandpass filter and decoder on receive to the AFSK oscillator on transmit. Also, the other section of the switch grounds the PTT line to the microphone connector of the transceiver. An LED is connected from the decoder output to the +5 volts, through a limiting 1 kilohm resistor. All of this extra wiring is shown in fig. 2.

The system also receives ASCII quite well. PLL adjustment on ASCII seems a bit more critical than on

RTTY, but copy seems every bit as good. I have not tried ASCII on transmit because the slowest RTTY speed is still too fast for my typing ability.

The resistors used in the system are 5 percent. Any frequency determining capacitors should be Mylar or the equivalent. Ceramics are OK for bandpass, but I used the little Tantalum type wherever possible.

The system was mounted on a PC board, arranged to plug into an 18-pin edge connector, mounted in a 4 x 6-inch (10 x 15 cm) console-type box. Any PC board arrangement should do; perf board would be a bit messy.

The PC board as seen from both sides is shown in figs. 3 and 4. A parts list is provided in table 1. The reed relay as mounted on the PC board is shown in schematic form because these items vary considerably, and because I believe some freedom should be left to the individual builder.

Hamsoft[™] and *Hamtext*[™] are manufactured by Kantronics, Inc., 1202 E. 23rd Street, Lawrence, Kansas 66044.

references

1. *Linear Handbook*, National Semiconductor, 2900 Semiconductor Drive, Santa Clara, California 95051.
2. Nat Stinnetee, W4AYV, "Active Bandpass Filter for RTTY," *ham radio*, April, 1979, page 46.

ham radio

GLB PACKET RADIO CONTROLLER

Now you can get in on the fun on packet radio!

- Ready to operate — wired & tested — **LOW COST**
- Easy to learn, easy to use
- Built-in packet Modem
- Use with computers, terminals teletype machines
- RS232 serial interface — 45 to 9600 baud
- Uses both ASCII and Baudot
- Programmed for both **AX.25** & **VADC** at 1200, 600 or 300 baud
- Automatically recognizes protocol of incoming messages
- Over 60 commands
- Custom call sign option
- Stores received messages until requested at a later time
- "Block" and "Transparent" modes for transferring data
- Operates as an unattended repeater
- Activates teletype motor to print messages
- Board accepts up to 14K of RAM
- Can be customized for **LANS** and up to 56K RAM



MODEL PK1
(shown with 14K RAM and 8K ROM)

MODEL PK-1 wired & tested w/4K RAM	\$149.95
Additional memory (up to 14K total)	10.00/2K
Manual only—credited with purchase (add \$2.00 for shipping)	9.95
RTTY adapter board	17.95
Custom cabinet kit — includes on/off switch, LED power indicator, reset button & power jack	34.95
Dimensions: 4.5 x 9.5 x 1.5 inches	
Pwr required: +12 VDC, approx. 200 ma.	

Contact GLB for additional info and available options.

We offer a complete line of transmitters and receivers, strips, preselector preamps, CWID's & synthesizers for amateur & commercial use. Request our FREE catalog. MC & Visa welcome.

GLB ELECTRONICS

Dept. H, 151 Commerce Parkway, Buffalo, NY 14224
716-824-7936, 9 to 4

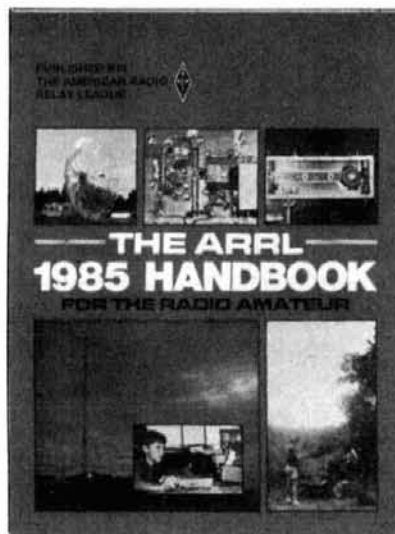

AVAILABLE
NOW

**THE 1985
ARRL
HANDBOOK**

\$15.00

(plus \$3.50 shipping)

1. It's BRAND NEW
2. It's BIGGER. Over 1024 pages.
3. It's EXPANDED. Covers everything from basic electronics to esoteric radio gear.
4. It's chockfull of NEW PROJECTS.
5. It's the MOST COMPLETE reference text available
6. Get your copy TODAY.

ORDER YOURS TODAY

ham radio magazine **BOOKSTORE**

Greenville, NH 03048

Prices US funds only

April 1985
short circuit

"smart" frequency counter

The parts list for fig. 2 of WA5VQK's "Smart Frequency Counter" (October, 1984, page 41), omitted from the text of that article, reads as follows:

quantity	value/number	approximate cost
2	10k resistors	.02
3	470 resistors	.03
1	560 resistors	.01
8	75 resistors	.08
4	0.1 μ F capacitors	.24
1	0.01 μ F capacitor	.02
1	10 μ F capacitor	.15
1	2 μ F capacitor	.12
1	15-35 pF variable capacitor	1.00
6	2N3904 transistors	.36
1	SN74LS00 IC	.20
2	SN74LS390 ICs	3.00
1	MC14499P IC	3.32 *
1	MC68705P35 IC	27.26 **
1	4.0 MHz crystal	4.00
4	common cathode 7-segment displays	2.00
		\$41.81

*May be ordered through any Motorola Semi-conductor Sales office

**Available from Motorola distributors

Join AMSAT...Today

Amateur Radio Satellite OSCAR 10 provides:

- A New Worldwide DX Ham Band open 10 hours a day.
- Rag Chew With Rare DX Stations in an uncrowded, gentlemanly fashion.

• **Popular Modes In Use:**
SSB, CW, RTTY, SSTV, Packet

• **Full Operating Privileges**
open to Technician Class licensee or higher.

Other AMSAT Membership Benefits:

ORBIT Magazine Subscription:
Dependable technical articles, satellite news, orbital elements, product reviews, DX news, and more.

Satellite Tracking Software
Available for most popular PCs.

QSL Bureau, AMSAT Nets, Area Coordinator Support, Forum Talks

Construction of Future Satellites For Your Enjoyment!

AMSAT Membership is \$24 a year, \$26 outside North America. VISA and MC accepted.

AMSAT
P.O. Box 27
Washington, DC 20044

301 589-6062

NEMAL ELECTRONICS INTL., INC.

SEE US AT DAYTON BOOTH #104

your one stop coax supplier!

Exclusive

SATELLITE CONTROL CABLE

5 TYPES AVAILABLE!

NEW!!! Lowest Loss

AVAILABLE IN
250-500-1000
FT. ROLLS
OR BY
THE FOOT



Designed for easy, one-step installation, providing the required cables for most earth station equipment all in a direct burial jacket

TYPE 1 (General Purpose)	TYPE 2 (M/F)	TYPE 3 (Interstat)	TYPE 4	TYPE 5
1 - RG59/U 96% Copper Braid	1 - RG59/U 96% Copper Braid	2 - RG59/U 96% Copper Braid	1 - RG6/U 18 Gauge, 96% Copper Shield	2 - RG6/U 18 Gauge, 96% Copper Shield
2 - 16 Gauge	2 - 12 Gauge	2 - 12 Gauge	2 - 12 Gauge	3 - 12 Gauge
3 - 18 Gauge	3 - 18 Gauge	3 - 18 Gauge	3 - 18 Gauge	3 - 18 Gauge
3 - 20 Gauge	3 - 20 Gauge	3 - 20 Gauge	3 - 20 Gauge	3 - 20 Gauge
Shielded plus Tinned Copper Drain Wire	Shielded plus Tinned Copper Drain Wire	Shielded plus Tinned Copper Drain Wire	Shielded plus Tinned Copper Drain Wire	Shielded plus Tinned Copper Drain Wire
3 - 22 Gauge Shielded plus Tinned Copper Drain Wire	3 - 22 Gauge Shielded plus Tinned Copper Drain Wire	3 - 22 Gauge Shielded plus Tinned Copper Drain Wire	3 - 22 Gauge Shielded plus Tinned Copper Drain Wire	3 - 22 Gauge Shielded plus Tinned Copper Drain Wire
55¢ FT	75¢ FT	79¢ FT	89¢ FT	89¢ FT

Call for 1000 FT pricing

Only Nemal offers the quality construction RG59/U copper shielding made to mil spec JAN C-17, 12-gauge conductors, tinned copper drain wires, and a true direct burial polyethylene jacket

HARDLINE

Two styles, two sizes for all installation needs

- Aluminum Outer Conductor with Polyethylene Jacket**
 - 1/2 inch loss .48 dB/100 ft. @ 30 MHz
 - 3.68 dB/100 ft. @ 1000 MHz\$1.25/ft.
 - 7/8 inch loss .28 dB/100 ft. @ 30 MHz
 - 2.54 dB/100 ft. @ 1000 MHz\$3.25/ft.
 - Corrugated Copper Outer Conductor with Polyethylene Jacket**
 - 1/2 inch loss .38 dB/100 ft. @ 30 MHz (FLC12-50J) 2.78 dB/100 ft. @ 1000 MHz\$1.59/ft.
 - 7/8 inch loss .13 dB/100 ft. @ 30 MHz (FLC12-78J) 1.3 dB/100 ft. @ 1000 MHz\$3.92/ft.
- COMPARE RG 213 1.25 dB/100 @ 30 MHz
8.5 dB/100 @ 1000 MHz!

HARDLINE CONNECTORS

- 1/2 inch aluminum UHF M/F \$19.00 Type N M/F \$22.00
- 7/8 inch aluminum UHF M/F \$49.00 Type N M/F \$49.00
- 1/2 inch copper UHF M/F \$22.00 Type N M/F \$22.00
- 7/8 inch copper UHF M/F \$49.00 Type N M/F \$49.00

shipping Cable — \$6.00 per 100 ft. Connectors — \$3.00 per order. Orders under \$20 add \$2 additional plus shipping. Charge card — orders over \$30 only. COD add \$2.00. Florida Residents add 5%.

FACTORY AUTHORIZED DISTRIBUTOR AMPHENOL, CABLEWAVE, COLUMBIA, KINGS BLONDER-TONGUE, TYTON, B&K

- COAXIAL CABLE
- MULTICONDUCTOR CABLE
- CONNECTORS-ADAPTERS
- HARDLINE
- CABLE TIES
- SMATV PRODUCTS
- COAX-SEAL
- COMPUTER CABLE
- CRIMP TOOLS
- FIELD STRENGTH METER

COAXIAL CABLE SALE POLYETHYLENE DIELECTRIC

- RG-8/U 96% shield Mil Spec. (\$29.00/100) or 31%/ft.
- RG11U 96% shield 75 ohm mil spec. 25%/ft.
- RG-55B/U double shield (RG-58 size) 50 ohm 45%/ft.
- RG58U mil spec 96% shield (\$10.00/100) or 11%/ft.
- RG62A/U 96% shield mil spec 93 ohm 12%* /ft.
- RG174/U min. 50 Ω mil spec 10%* /ft.
- RG213 noncontaminating 96% shield mil spec 36%* /ft.
- RG214/U double silver shield 50 ohm \$1.65/ft.
- RG214/U tinned copper 65%* /ft.
- RG217/U double shield 50Ω 5/8" OD 85%* /ft.

LOW LOSS FOAM DIELECTRIC

- RG-8X (Mini 8) 95% shield (\$15.00/100) or 17%* /ft.
 - RG8U 80% shield (\$19.00/100) or 22%* /ft.
 - RG-8/U 97% shield 11 ga. (eq. Belden 8214) 31%* /ft.
 - RG58U 80% shield 07%* /ft.
 - RG58U 95% shield 10%* /ft.
 - RG59/U 100% foil shield TV type 10%* /ft.
 - RG59/U 70% copper shield 09%* /ft.
 - HEAVY DUTY ROTOR CABLE 2-16 ga 6-20 ga 36%* /ft.
 - Rotor cable 2-18 ga 6-22 ga Poly burial Jkt. 19%* /ft.
- Complete line of multiconductor cables available

CONNECTORS MADE IN USA

- Amphenol PL 259 89¢
- PL-259 and/or SO-239 65¢ ea. or 10/\$5.99
- Double Male Connector \$1.79
- PL-258 Double Female Connector 98¢
- PL-259 Silver-Teflon Kings \$1.59 ea.
- Reducer UG-175 or 176 22¢ or 10/\$2.00
- UG-255 (PL-259 to BNC) \$2.95
- Elbow (M359) UHF Elbow \$1.79
- F59A (TV type) 24¢ or 10/\$2.00
- UG 21 DJU Type N Male for RG8, Amphenol \$3.00
- UG-88C/U BNC Male for RG-58, Amphenol \$1.25
- UG 273 BNC-PL259 Amphenol \$3.00
- 3/16 inch Mike Plug for Collins etc. (cutoff) \$1.25

shipping Cable — \$3.00 per 100 ft. Connectors — add 10%, \$3.00 minimum. Orders under \$20 add \$2 additional plus shipping. Charge card — orders over \$30 only. COD add \$2.00. Florida Residents add 5%.



12240 N.E. 14th Ave.
No. Miami, FL 33161
Telephone: (305) 893-3924

IN STOCK
— OVER 500 ITEMS —
COMPLETE LINES
✓ 170

The DX EDGE®: Now for your COMMODORE 64™

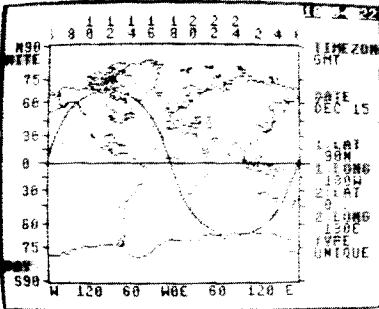

- Fabulous graphics for the great DX aid
- Long path/Gray Line/Sunrise/Sunset on a fine map
- Automatic Gray Line updating simulates earth's rotation
- Keyed to DXCC list and 40 Zones

It's fantastic! Daylight and darkness paths in real time on your computer. As simple as can be.
Price: \$34.95, on a disk, ppd. in U.S. and Canada. Add \$2.45 tax in N.Y.S. Add \$4.00 elsewhere, air mail. U.S. funds only. The original plastic DX EDGE, in large slide rule format, is still only \$16.95 (plus \$4.00 outside U.S. and Canada). Great Circle Slides are \$3.00 with DX EDGE, \$5.00 without. Specify your Latitude. ✓ 171

Please make check or M.O. payable to the DX EDGE and mail to:
The DX EDGE, P.O. Box 834, Madison Square Stn., New York, N.Y. 10159

An information flyer is available free of charge. A product of Xantek, Inc. / Xantek, Inc. 1985 Commodore 64 is a trademark of Commodore Electronics Ltd.

RF TRANSISTORS

FRESH STOCK - NOT SURPLUS
TESTED — FULLY GUARANTEED

2-30MHz 12V (* = 28V)				
P/N	Rating	Ea.	Match Pr	
MRF406	20W	\$14.50	\$32.00	
MRF412	80W	18.00	40.00	
MRF412A	80W	18.00	40.00	
MRF421	100W	25.00	54.00	
MRF421C	110W	27.00	58.00	
MRF422*	150W	38.00	82.00	
MRF426*	25W	17.00	40.00	
MRF426A*	25W	17.00	40.00	
MRF433	13W	14.50	32.00	
MRF435*	150W	42.00	90.00	
MRF449	30W	12.00	27.00	
MRF449A	30W	11.00	25.00	
MRF450	50W	12.00	27.00	
MRF450A	50W	12.00	27.00	
MRF453	60W	15.00	33.00	
MRF453A	60W	15.00	33.00	
MRF454	80W	16.00	35.00	
MRF454A	80W	16.00	35.00	
MRF455	60W	12.00	27.00	
MRF455A	60W	12.00	27.00	
MRF458	80W	18.00	40.00	
MRF460	60W	16.50	36.00	
MRF475	12W	3.00	9.00	
MRF476	3W	2.50	8.00	
MRF477	40W	13.00	29.00	
MRF479	15W	10.00	23.00	
MRF485*	15W	6.00	15.00	
MRF492	90W	18.00	39.00	
SRF2072	75W	15.00	33.00	
CD2545	50W	24.00	55.00	

Selected High Gain Matched Quads Available

VHF TRANSISTORS

Type	Rating	Ea.	Match/Pr
MRF221	15W	\$10.00	—
MRF222	12W	12.00	—
MRF224	40W	13.50	\$32.00
MRF231	3.5W	10.00	—
MRF234	25W	15.00	39.00
MRF237	1W	2.50	—
MRF238	30W	12.00	—
MRF239	30W	15.00	—
MRF240	40W	16.00	—
MRF245	80W	25.00	59.00
MRF247	80W	25.00	59.00
MRF260	5W	6.00	—
MRF264	30W	13.00	—
MRF492	70W	18.00	39.00
MRF607	1.8W	2.60	—
MRF627	0.5W	9.00	—
MRF641	15W	18.00	—
MRF644	25W	23.00	—
MRF646	40W	24.00	59.00
MRF648	60W	29.50	69.00
SD1416	80W	29.50	—
SD1477	125W	37.00	—
2N4427	1W	1.25	—
2N5945	4W	10.00	—
2N5946	10W	12.00	—
2N6080	4W	6.00	—
2N6081	15W	7.00	—
2N6082	25W	9.00	—
2N6083	30W	9.50	—
2N6084	40W	12.00	29.00

TMOS FET

MRF137	30W	\$22.50	—
MRF138	30W	35.00	—
MRF140	150W	92.00	—
MRF150	150W	80.00	—
MRF172	80W	65.00	—
MRF174	125W	88.00	—

Technical Assistance & cross-reference information on CD, PT, RF, SRF, SD P/Ns Call Engineering Dept. (619) 744-0728

RF Parts Catalog Available ✓ 172
OEM & Quantity Discounts

Minimum Order \$20 Add \$3.50 Shipping
WE SHIP SAME DAY C.O.D./VISA/MC

ORDERS ONLY: 800-854-1927



WESTCOM

1320 Grand Ave. San Marcos
California 92069 (619) 744-0728

NCG Co. NEW-TECHNOLOGY HIGH-QUALITY

AFFORDABLE TRANSCEIVERS FOR ALL. WINNERS IN COMPARISON HANDS DOWN!

10/160 M HF TRANSCEIVER



4 MEMORIES - 3 WAY AUTO SCAN, DUAL VFO, IF SHIFT, CW-W, 400 Hz CW-N 200 Hz. ALL 9 BANDS PLUS MARS. BUILT IN AC/DC POWER. SSB. CW OR RTTY. I.F. TUNE 3-STEP TUNING SPEED. 200 WATT PEP. MICROPHONE IMPEDANCE 600-50K OHM HAND MIC. INCLUDED.

SPECIAL

40-15-6 M NEW TRI-BANDER



40, 15 AND 6 METERS ARE YOUR BASE STATION OR MOBILE WITH AC/DC BUILT IN POWER SUPPLY CW-N 200 Hz OR USB, 2.S0239 ANTENNA CONNECTORS, HAND MIC. BUILT IN TVI FILTER LITTLE TO NO TV INTERFERENCE, 20 WATTS PEP, MARS ON 40 AND 6 METERS.

SPECIAL

15 M 15 METER MOBILE



A GREAT QRP RIG WITH THE BIG RIG SIGNAL, 2 WATTS OR 10 WATTS OUT, BUILT IN CW SIDE TONE, DIGITAL DISPLAY, HAND MIC, TOP MOUNTED SPEAKER, MOBILE BRACKET, RIT OR FINE TUNE TX&RX ± 4 KHz, 21 TO 21.450 MHz SIGNAL TO NOISE MORE THAN 10dB DOWN.

SPECIAL

JUST SLIGHTLY AHEAD! WITH THE QUALITY YOU HAVE ALWAYS LOOKED FOR!



90 DAY WARRANTY ON ALL TRANSCEIVERS - DIRECT FROM NCG OR YOUR DEALER

WE HAVE 1.2 GHz BASE/REPEATER & MOBILE ANTENNAS

1275 N. Grove Street, Anaheim, CA 92806 (714) 630-4541

✓ 173

NOTE: PRICES AND SPECIFICATIONS SUBJECT TO CHANGE WITHOUT NOTICE OR OBLIGATION

ENGINEERING CONSULTING INTRODUCES

'REMOTE A PAD' MODEL RAP-1

2 FOUR DIGIT DTMF DECODERS, PLUS 16 DIGIT KEYPAD CONTROL

TUNE THE WORLD FROM YOUR HANDHELD VHF/UHF RADIO

- Audio tones from any source are converted to solid state switches which control any 16 digit keypad of a radio or other device.
- Some examples you can control include the Pro Search[®] Rotator (rotate beam remotely), ICOM IC-201 or ICOM IC-211 when using the RM-2 controller (ICOM 7160 & 751 Aiden PCS 4000) handhelds such as Yaesu FT-20B, FT-70B, ICOM IC-20AT, and many more.
- Anything you can do manually with your 16 digit keypad, the RAP-1 will do remotely using audio touch tones from any source.
- Two four digit programmable access codes are used to operate relays or other on-off functions.
- LED decoder status indicators and momentary plus steady state decoder outputs are provided.
- 22 gold pin card edge connector, 16 pin dip socket and ribbon cable are supplied.
- An CMOS low power drain (30ma) 555 201 Decoder.
- Has a eight wires (4 rows and 2 columns) in parallel with the existing keypad of the radio you wish to control remotely. Connect audio from any source to 16 audio D.C. and you are in control.
- The dual 3 digit decoders will turn your look-in and off using your programmable access code.
- Detailed inter-face diagrams and instructions included with purchase. Interface cable for Pro Search[®] \$3.95 (plugs in act. socket).

Model RAP-1
\$149.95

'Remote A Pad' Remote control interface board and DTMF decoder

TOUCH TONE™ DTMF DECODER KIT

DTMF Receiver Kit

- Complete DTMF Receiver (SSI 201)
- Receive all 16 standard DTMF digits
- No front end filters needed
- Output either hex or BCD format
- CMOS low power (29ma @ 12 V D.C.)
- Excellent speech immunity
- Includes 3.58MHz crystal, 22 pin IC socket, resistor and capacitors, data sheet, schematics
- 'Digit Valid' detection, 'DV' goes high after a valid tone pair is sensed
- Make your own 'SELLCALL', repeater decoder, etc
- Quantity discounts available.

\$22.95 (Includes shipping USA [Add 6% CA address])

SEND CHECK OR MONEY ORDER TO:
ENGINEERING CONSULTING
583 CANDLEWOOD ST., BREA, CA 92621
714/671-2009

ENGINEERING CONSULTING INTRODUCES

TOUCHTONE™ DTMF to RS-232-C 300 BAUD INTERFACE

107

TOUCH TONE REPEATER TOUCH TONE DAP-1 COMPUTER

- Use your computer to decode DTMF touchtones.
- Receive all 16 digits as fast as they can be transmitted
- Easily program your computer in BASIC to decode multi-digit strings, display digits, sound alarms, observe secret codes, control relays, remote base
- Simple to use, just provide +12 VDC and audio hook two wires to the RS-232-C serial input on your computer, enter a simple BASIC program and begin to decode
- Sample BASIC program and instructions included
- LED indicator

Model DAP-1
Wired and Tested
\$89.95

Includes shipping USA. Cal. addresses add 6%. VISA and MasterCard accepted, or send check/M.O. to

ENGINEERING CONSULTING
583 CANDLEWOOD ST., BREA, CA 92621
714/671-2009

ICOM IC-20AT USER'S "AUDIO BLASTER"™ MODULE

Now Available for IC-20AT

- Module installs inside the radio in 10 minutes
- Boosts audio to nearly 1 watt
- Low power drain (4ma stand by)
- Complete step by step instructions included
- Corrects the LOU audio problem
- Drive external speakers to full volume even signals with low deviation

Model AB-1
\$19.95

Price includes postage and handling. U.S.A. CA res. add 6%

Send check or money order to
ENGINEERING CONSULTING
583 CANDLEWOOD ST., BREA, CA 92621
(714) 671-2009

NEW!

THE RADIO AMATEUR'S LICENSE MANUAL

NOW INCLUDES ANSWERS TO FCC/VEC EXAM QUESTIONS

ARRL LICENSE MANUAL

Here's the latest up-to-date licensing guide from the ARRL. Plenty of theory and detailed explanations take most of the pain out of studying to upgrade your license.

© 1984 80th edition 216 pages

Softbound **\$4.00**
Please add \$2 shipping & handling

☐ AR-LG

HAM RADIO'S BOOKSTORE
Greenville, NH 03048

stacking antennas: part 1

There are two basic ways to obtain high antenna gain in the VHF/UHF spectrum. Either you build a high-gain antenna with a single feed (such as a parabolic dish or long Yagi), or you build a number of single-feed devices and array or stack them for higher gain. Parabolic dishes, which require only a single feed system, have been built with gains exceeding 60 dBi (dB above an isotropic radiator). (To convert dB over a dipole to dBi, add 2.15 dB.) Hence they are especially popular on EME, where high gain is necessary.

However, high gain dish type antennas can get quite large. For example, let's see what size dish would be necessary for EME. The minimum recommended antenna gain for 2-meter EME is 20 dBi. This would require a dish approximately 33 feet (10 meters) in diameter. The minimum recommended gain for 70 cm EME is 25 dBi, which would require an 18-foot (5.5 meter) diameter dish.¹ Furthermore, parabolic dishes are usually only 50 to 60 percent efficient and can present structural problems, especially for those locations where wind and snow are prevalent.

Yagis are replacing dishes

In recent years, the Yagi antenna has become very popular, particularly on 70 cm and lower frequencies. Its popularity is justly deserved because if properly designed, it can exceed 70 to 80 percent efficiency with only moderate wind load. A properly

designed 20 dBi-gain Yagi would, however, require a boom length of about 13 wavelengths — 89 feet (27 meters) at 2 meters! A 30-foot (9 meter) 4.4 wavelength boom design is about the longest practical 2-meter Yagi, but it would have a gain of only about 16 to 17 dBi, 3 to 4 dB lower than desired for EME. Therefore, when high gains are required, two or more Yagi antennas are arrayed or stacked to obtain the required gain.

general principles in stacking

It is often said that every time you double the number of Yagis, you double (add 3 dB) the overall gain. It is also common to hear that the proper stacking distance for a Yagi is two thirds of the boom length. Are these statements true? *No.*

But don't lose heart. Since I'm all too often asked about proper stacking distance, I decided that it's time to update the material I've been distributing since my first talk on the subject (at the Central States VHF Conference in Kansas City in 1977) and present it here along with additional data.

This subject deserves more than just a set of charts or tables that quickly become obsolete as new designs appear. Also, there are many practical aspects of stacking that are often ignored. Therefore, I've decided to first discuss stacking concepts in depth.

Since the material required to thoroughly cover the subject of stacking is extensive, I've decided to devote two monthly columns to this topic. In **part 1** (this month), I'll discuss the

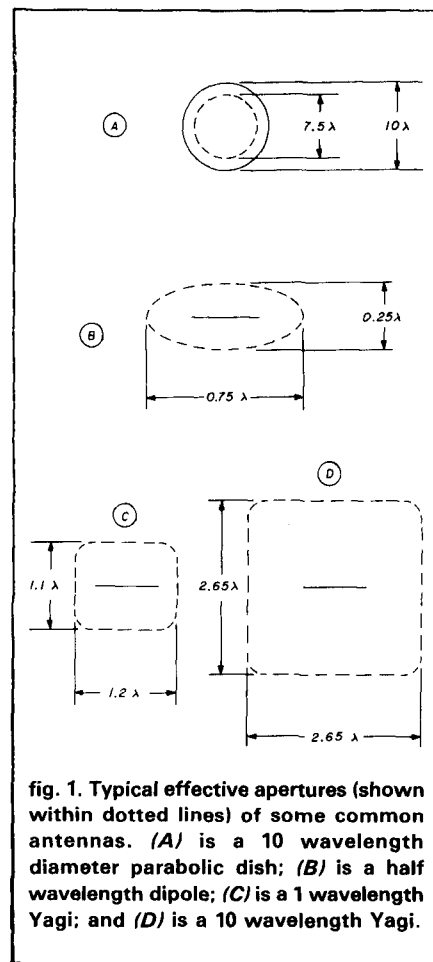

fig. 1. Typical effective apertures (shown within dotted lines) of some common antennas. (A) is a 10 wavelength diameter parabolic dish; (B) is a half wavelength dipole; (C) is a 1 wavelength Yagi; and (D) is a 10 wavelength Yagi.

theory of stacking and provide the examples, tables, and charts required for a first cut. **Part 2** (next month), will discuss the practical aspects of stacking and provide suggestions on how to properly use the material presented in part 1. At the conclusion of part 2, you should have all the necessary material to determine the proper stacking for any Yagi antenna of your choosing, even designs that are not yet available!

table 1. Data on typical popular 2-meter through 23-cm Yagi designs including gain, boomlength, E and H beamwidths, E and H side lobe levels and recommended stacking distances. Data is believed to be accurate and has been gleaned from tests, data sheets, etc.

general designs:

Yagi description	gain (dBi)	boom length (λ)	E B.W. degrees	H B.W. degrees	E S.L. (dB)	H S.L. (dB)	recommended stacking distance in E & H planes (λ)
NBS 3 element	9.25	0.4	57	72	23	12	1.00 × 0.60
NBS 5 element	11.35	0.8	48	56	22	13	1.20 × 0.90
NBS 6 element	12.35	1.2	40	42	19	12	1.40 × 1.10
NBS 12 element	14.40	2.2	34	36	17	13	1.55 × 1.40
NBS 17 element	15.55	3.2	28	33	16	12	1.80 × 1.35
NBS 15 element	16.35	4.2	26	29	17	13	1.95 × 1.75
2-meter designs:							
Cushcraft Jr. Boomer	14.40	2.2	34	36	17	13	1.55 × 1.40 (note 1)
Lunar 11 element	14.50*	2.6	31	34	17*	13*	1.65 × 1.50
F9FT 16 element	14.80	3.0	32	34	22	18*	1.80 × 1.50 (note 1)
KLM 2M-13LBA	15.00	3.1	28	33	18	15*	1.80 × 1.60 (note 1)
Cue Dee 15 element	15.15	3.1	30	32	16*	12*	1.70 × 1.40
Cushcraft Boomer	15.55	3.2	28	33	16	13	1.80 × 1.55
KLM 2M-16LBX	16.50	4.1	26	29	18*	15*	2.00 × 1.75 (note 1)
135 cm designs:							
Lunar 11 element	14.50	2.60	31	34	17*	13*	1.65 × 1.50
Cushcraft Boomer	16.35	4.2	26	29	17	13	1.95 × 1.75 (note 1)
KLM 220-22LBX	17.75	6.65	22	25	17	14	2.45 × 2.00 (note 1)
70-cm designs:							
KLM 432-16LB	15.20	5.3	30.0	33.0	17*	14*	1.70 × 1.55
K2RIW 13 element	15.40	5.3	29.5	29.5	10	7	1.50 × 1.50
K2RIW 19 element	17.35	5.6	24.0	26.0	18	15	2.10 × 1.80 (note 1)
F9FT 21 element	17.40	6.6	24.0	26.0	13	10*	2.10 × 1.75 (note 1)
FLEXA-YAGI 23 el.	17.95	7.2	24.0	25.0	17	15*	2.40 × 2.00
Cushcraft 424B	18.00	7.6	19.0	22.0	14	12	2.20 × 1.80 (note 1)
KLM 432-30LBX	19.40	9.6	19.0	20.0	17	14	2.70 × 2.40 (note 1)
W1JR 31 element	19.60	10.5	18.0	20.0	17	14*	2.70 × 2.40 (note 1)
23-cm designs:							
Tonna 23 element	17.00	7.5	19.0	19.0	12	10	2.40 × 2.40 (note 1)
W1JR 45 EL LPY	20.7	15.7	18.0	20.0	15	13*	2.85 × 2.65 (note 1)

*Estimated

Note 1. In this case actual tests have shown that a specific optimum is preferred (see text).

fundamental aperture concepts

Let us first examine some different antennas, each with its specific "effective aperture" or capture area. Some typical examples are shown in **fig. 1**. Other examples are contained in reference 2.

A 10 wavelength diameter parabolic antenna is shown in **fig. 1A**. It is easy to see how it has collection properties similar to that of the human ear. Note,

*Additional recommended reading: *Significant Phased Array Papers*, edited by R.C. Hansen, PN 0-89006-019-3, Artech House, Inc., 610 Washington Street, Dedham, Massachusetts 02026 (\$13.00 plus \$2.50 postage and handling).

however, that a dish antenna is not 100 percent efficient because it does not collect signals very well near its edge. Using simple geometry, the physical aperture of a 10 wavelength diameter dish is 78.5 square wavelengths, but its effective aperture is only approximately 44 square wavelengths.

A half-wave dipole antenna is shown in **fig. 1B**. Its aperture is more difficult to visualize. Note that its aperture extends out horizontally about 0.75 wavelength in the E plane and vertically about 0.25 wavelength in the H plane, bulging near the center and forming an ellipse. It has an effective

aperture of approximately 0.13 square wavelength.

A Yagi has a slightly differently shaped aperture. A short (1 wavelength) conventional Yagi (one whose elements all lie completely in the same plane) is shown in **fig. 1C** and has a somewhat rectangular aperture, being wider in the E (horizontal) plane than in the H (vertical) plane. Its aperture is approximately 1.3 square wavelengths. A properly designed conventional 10 wavelength long Yagi as seen in **fig. 1D** has an almost square aperture of approximately 7 square wavelengths.

Some of you may want to research this subject further to see how I determined the apertures. If you know the individual antenna directivity gain³ you can calculate the effective aperture using the following equation:

$$\text{effective aperture} = \frac{\text{gain}}{12.5} \quad (1)$$

where effective aperture is in square wavelengths and gain is over isotropic as a numeric. For example, a ½ wavelength dipole has a gain of 1.64 (2.15 dBi). Therefore it has an effective aperture of 0.13 square wavelengths. A 1 wavelength Yagi has a directivity gain of approximately 16.5 (12.2 dBi) and an aperture of approximately 1.32 square wavelengths. Likewise, if we have a 10 wavelength Yagi with a gain of 87.5 (19.4 dBi), the aperture will be approximately 7 square wavelengths, quite an aperture increase over the 1 wavelength Yagi.

The above equation does not reveal the width or height of the aperture. In the case of the 10 wavelength Yagi the aperture is approximately square (fig. 1D). Therefore the horizontal and vertical dimensions are approximately the square root of the aperture ($\sqrt{7}$) or 2.65 wavelengths. Since the 1 wavelength Yagi is slightly rectangular (per fig. 1C), the aperture will be slightly wider than it is high or approximately 1.2 by 1.1 wavelengths, respectively.

Once the concept of aperture is understood, it is easy to see what happens when we try to stack two identical antennas. When they are in close proximity, their apertures overlap, as shown in fig. 2A. Hence the capture area will not be doubled. Also the gain will not be double (3 dB increase) that of the single antenna. Furthermore, when identical antennas are too closely spaced, they introduce mutual impedance effects that can play strange games with the pattern, power distribution, and VSWR.

If we move the antennas apart until their apertures just touch, as shown in fig. 2B, we should produce almost twice the capture area (more on this later). Separating the two antennas

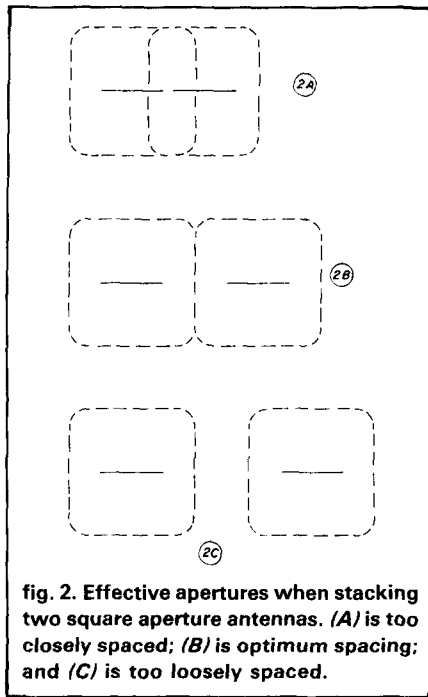

fig. 2. Effective apertures when stacking two square aperture antennas. (A) is too closely spaced; (B) is optimum spacing; and (C) is too loosely spaced.

further as shown in fig. 2C, will definitely double the capture area but is not desirable for reasons to be discussed shortly. Similarly, stacking in the vertical plane is also possible and yields a similar increase in gain.

stacking patterns

"So," you ask, "how does this relate to my Yagi?" First let us see what happens by looking at some typical antenna patterns. Figure 3A illustrates a typical antenna pattern for a 3-element Yagi.⁴ Note that the half-power beamwidth is approximately 80 degrees and that this antenna pattern has very low side lobes.

We will stack two identical 3-element Yagis close together as shown in fig. 2A. The resultant antenna pattern is shown in fig. 3B. Note that the main beam narrows to about 50 degrees and the pattern is still very clean.

Next, let's separate the antennas further apart as shown in fig. 2B. The resultant antenna pattern is shown in fig. 3C. Note that the pattern beamwidth has become even narrower, 40 degrees, half the beamwidth of the original antenna. Also note that significant new lobes appear. These are properly referred to as "grating lobes"

to differentiate them from the original single antenna's side lobes. The grating lobes in fig. 3C are only about 13 dB below the main beam. This separation is considered the optimum stacking distance.⁵

In fig. 2C, the antennas are spaced much further apart. The resulting antenna pattern is shown in fig. 3D. Note that in this case the main beam is approximately 20 degrees wide, or 25 percent that of the original antenna being stacked. Also note that the number of the grating lobes has increased to four, with maximum amplitude only 2 dB below the main beam. This is a technique often used by radio astronomers in interferometry. It allows very narrow beamwidths for greater accuracy in determining the position of extra-terrestrial objects. However, it is not usually desirable for Amateurs!

The patterns just shown all came from a "clean" Yagi. If you look closely you will see that all the grating lobes and nulls were formed from within the area of the original antenna pattern. This point is stressed because most Yagi antennas, especially those that are 1 wavelength or longer, usually have many side lobes before being stacked. The more side lobes you start with, the greater the chances are that the resulting pattern will be much "dirtier" and more complex than desired. Suppression of grating lobes is a difficult, if not impossible, task. Therefore, the real limitations when stacking antennas are the beamwidth, the side lobes in the antenna to be stacked, and the allowable level of the grating lobes. Despite the appearance that grating lobes are "robbing power" from the main beam, in actuality they are not since each grating lobe is very narrow. However, grating lobes are sources of extraneous noise or extra signal pickup, a killer on EME, and when there is lots of QRM. Incidentally, if you have many strong grating lobes, it is easy to accidentally peak your antenna on one of them instead of on the main beam!

To review, the optimum stacking distance for two identical antennas oc-

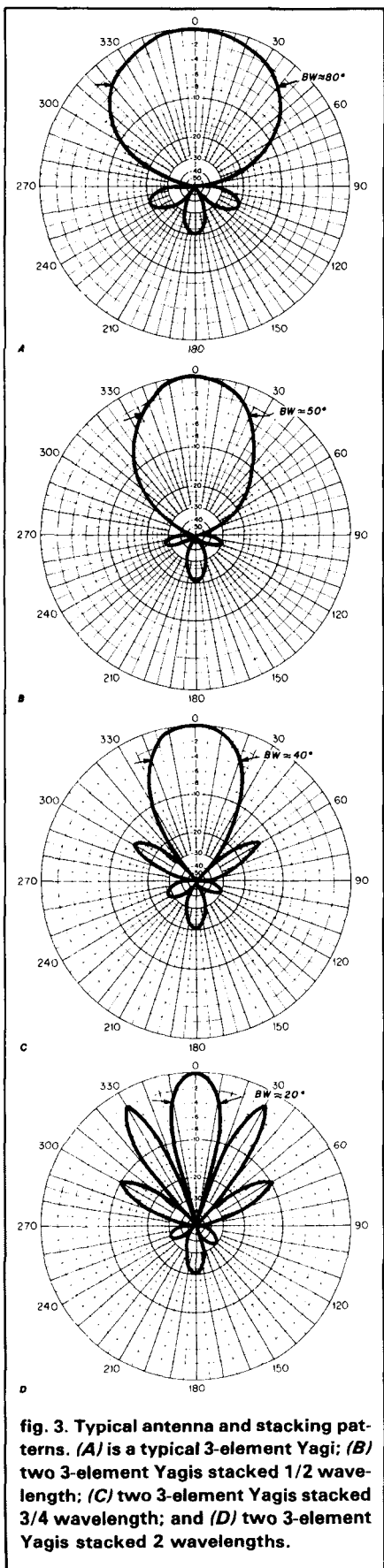
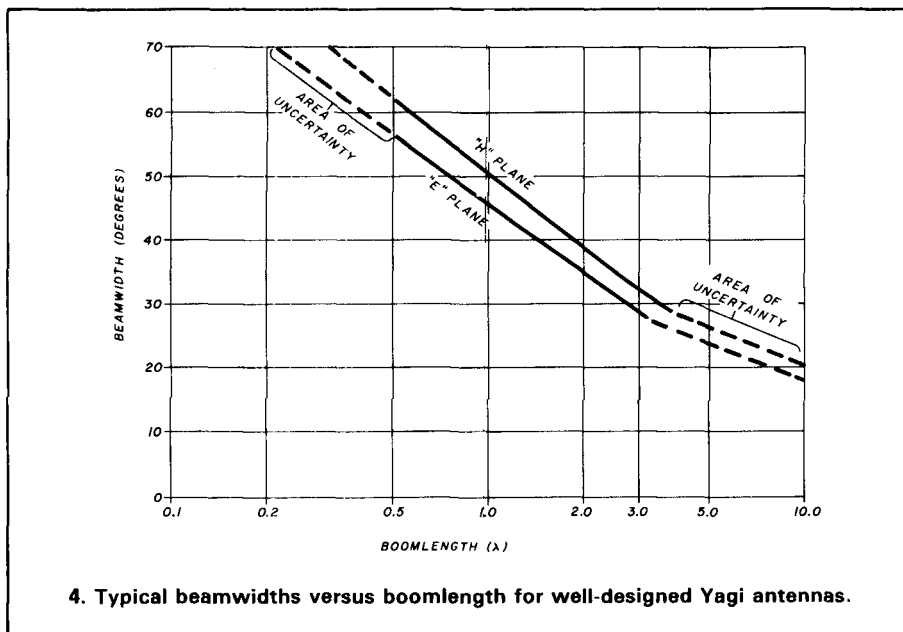

fig. 3. Typical antenna and stacking patterns. (A) is a typical 3-element Yagi; (B) two 3-element Yagis stacked 1/2 wavelength; (C) two 3-element Yagis stacked 3/4 wavelength; and (D) two 3-element Yagis stacked 2 wavelengths.



4. Typical beamwidths versus boomlength for well-designed Yagi antennas.

cur when the beamwidth of the array has been narrowed to about 50 percent and the grating lobes are approximately 13 dB below the main beam (more on this later). If four antennas are stacked in the same plane, optimum stacking would yield about 25 percent of the beamwidth of the original antenna while the grating lobes should still be 13 dB below the main beam.

actual stacking

There are two basic stacking methods: uniformly illuminated and shaped. Uniformly illuminated means that the antennas are all spaced the same distance apart in each plane and each is fed with the same amount of power. This method yields the maximum gain for its size and is the method most often used by Amateurs.

The shaped method is often used by professional antenna designers, especially in phased-array radars, where very low grating lobes are necessary. The individual antennas may be unequally spaced (sometimes one is completely left out!) and often are fed with different amounts of power. Since these techniques yield lower gain and are quite complex, they are usually not desired by Amateurs.

The subject that I have been discussing is called "pattern multipli-

cation."⁶ For more information on these techniques (pattern multiplication), see references 5 through 10.*

The most important parameters needed to determine optimum stacking distance are the beamwidths in the E and H plane of the antenna to be stacked. Also, the level of the first side lobe on the antennas to be stacked is important.

Most antenna manufacturers and antenna designers know the E plane beamwidth of their antenna very accurately since it is not difficult to measure. As discussed in reference 3, the beamwidths are often specified and accurate (in contrast to the gain claims). If the beamwidths are not known, they can be estimated from the "true" antenna gain. Several gain determining methods were described in detail in last May's column.³ To save you even further time, I have prepared **table 1**, which lists many parameters of some of the most popular Yagi antennas.

The beamwidths of a Yagi antenna can be estimated if the boomlength is known. To assist you in this exercise, I have prepared a graph of E and H beamwidths versus boomlength for typical Yagi antennas (see fig. 4). All you need to know is the boomlength in wavelengths. For example, the E and H plane beamwidths of a typical



NAMPA SATELLITE SYSTEMS, INC.

TWO LOCATIONS

312 12th Ave. So.
Nampa, Idaho 83651
(208) 466-6727

6012 W. 34th St.
Houston, Texas 77092
(713) 957-5140

1-800-654-0795

For Service ONLY (208) 467-3204

NEW LOW, LOW PRICES!

**100% NATIONAL FINANCING AVAILABLE THROUGH NAMPA SATELLITE
FOR MORE INFORMATION CALL 208-466-6727**

EACH OF THE FOLLOWING SYSTEMS CONSIST OF: Receiver, 100° LNA, LNB, or LNC, Wilson MD-9 Dish, 100 Ft. Cable Pack, LNA Cover, Polarmatic I Feedhorn, NSS Dish Drive, All Connectors & Instructions.

Wilson YM1000 System \$1433



Wilson YM400 System \$1242



Drake ESR 240 System \$1542

Drake ESR 324 System \$1392

Luxor Mark II System \$1908

Maspro SRS System \$1692

Dexcel 1300-01 System \$1543

Dexcel 1200-01 System \$1293

Dexcel 900-01 System \$1178

Uniden UST 3000 Sys. \$1472

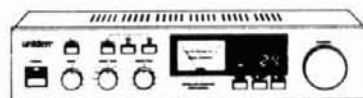

Little Wil by Wilson \$ 899

Boman SR1500 System \$1133

Boman SR2500 System \$1833

M/A Com H1 System \$2082

M/A Com T1 System \$1982

Sigma Mark 2A Sys. \$1133

Sigma Mark 3 BL Sys. \$1362

Sigma Mark 5 BL Sys. \$1433

STS MBS-SR System \$1512

OPTIONS with system

PM 9' Dish	\$ 60
PM 10' Dish	\$140
Prodelin 10' Dish	\$400
Ranger 11' Mesh Dish	\$300
Magnum 12' Dish	\$400

85° LNA	\$ 80
NSS Memory Tracker	\$100
MTI 2100	\$225
MTI 4100	\$345
Houston Tracker IV	\$325
Houston Tracker IV +	\$425

2 wavelength Yagi are approximately 35 and 39 degrees, respectively.

Also note in **fig. 4** that in a conventional Yagi the E plane is typically narrower than the H plane. While the E plane beamwidth is often available on data sheets, the H plane beamwidth is seldom shown (it is slightly more difficult to accurately measure). However, it can usually be "guesstimated" to be 10 percent greater than the E plane. For example, a Yagi with a 30-degree E plane beamwidth has a typical H plane beamwidth of 33 degrees.

Also, many Yagi antennas have side lobes that are so strong that they are equal to or greater than the idealized grating lobe desired after stacking! Therefore, it should be obvious that if the sidelobes on an antenna to be stacked are equal to or less than 13 dB below the main beam peak, they can't be optimally stacked. In this case the antennas must be placed closer together than optimum and consequently will yield lower stacking gain (more on this later)!

As a rule of thumb, the H plane side lobe level on a conventional Yagi is typically 3 dB stronger than the E plane lobe. Therefore, a Yagi with an 18 dB down sidelobe in the E plane probably has an H plane side lobe approximately 15 dB down from the main beam.

Now that we have determined the beamwidth and side lobe levels of our antenna, how do we determine the optimum stacking distance? For antennas with very low side lobes (at least 18 dB below the main beam):

$$\text{stacking distance} \approx \frac{57}{\text{beamwidth}} \quad (2)$$

where stacking distance is in wavelength and beamwidth is in degrees.¹⁰

If the side lobes are typically 13-17 dB down, the usual situation, my tests have verified that:

$$\text{stacking distance} \approx \frac{51}{\text{beamwidth}} \quad (3)$$

If the side lobes are only 12 dB down (or less) (typical of the H plane of many Yagis):

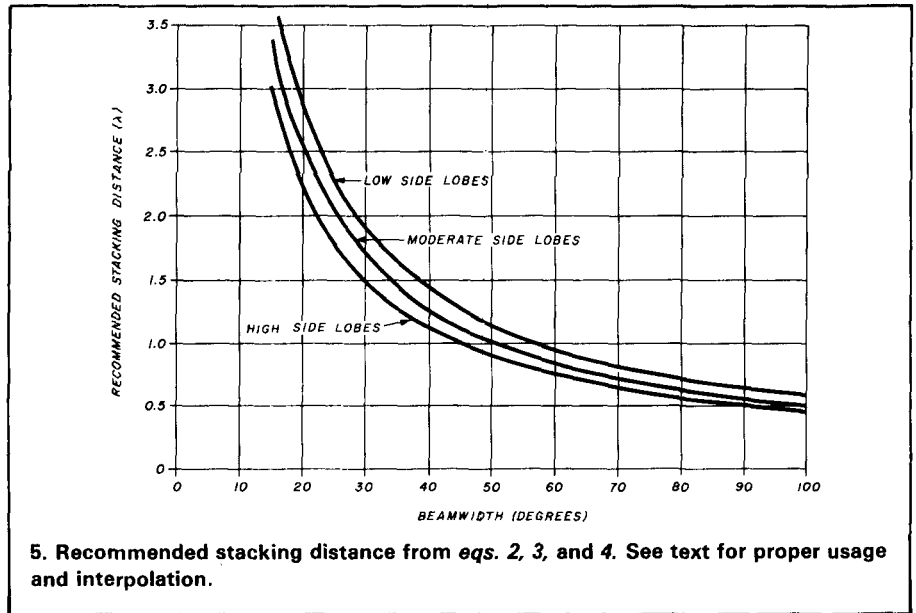

5. Recommended stacking distance from eqs. 2, 3, and 4. See text for proper usage and interpolation.

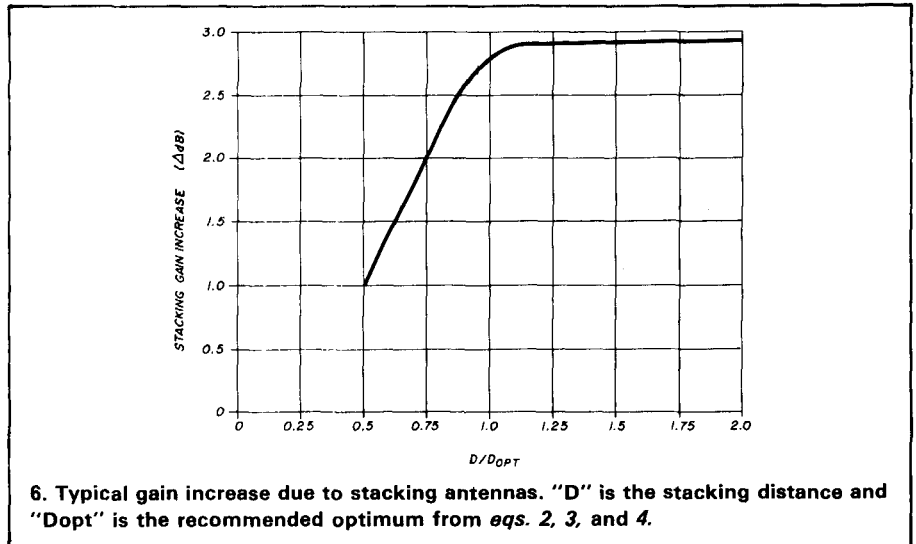

6. Typical gain increase due to stacking antennas. "D" is the stacking distance and "Dopt" is the recommended optimum from eqs. 2, 3, and 4.

$$\text{stacking distance} \approx \frac{45}{\text{beamwidth}} \quad (4)$$

For simplicity, I have incorporated these formulas into a graph **fig. 5**), which is an updated version of the graph discussed earlier. It incorporates the recommended stacking for antennas with different levels of side lobes.

It can also be seen that there is room for interpolation using **eqs. 2, 3, and 4** if desired.

For example, the NBS 17 element 3.2 wavelength Yagi has an E plane beamwidth of 28 degrees and a 16 dB down side lobe. Therefore use **eq. 3** (or the graph). Hence, the recom-

mended E plane stacking distance is approximately 1.8 wavelength. The H plane beamwidth is 33 degrees but the side lobe is only 12 dB down. Using **eq. 4**, the recommended H plane stacking distance is approximately 1.35 wavelengths, quite a bit less than expected.

For those who do not want to make the required calculations, **table 1** also includes the recommended stacking distance for the antennas listed. In some cases, actual test measurements have been taken to determine the optimum spacing. Therefore, if the recommended stacking distance is different from that which you calculate

(signified by note 1), it is the preferred value since actual tests have verified its validity.

stacking gain

So how much gain do you get if you use the recommended stacking distance? Günther Hoch, DL6WU, has carried out tests and presented some answers to this question.¹⁰ I have incorporated his information in **fig. 6**. It can be seen that the gain approaches 3 dB, but only at very wide spacing as discussed earlier. A typical optimum value is about 2.8 dB. If you under-stack (i.e., position too closely) by about 25 percent (as illustrated in **fig. 2A**), the gain increase (from a single antenna to the array) will be reduced to about 2 dB and there will be almost no grating lobes! Obviously there is not a great degree of freedom when optimum gain and pattern are concerned.

Finally when an antenna has high side lobes, it must be stacked closer to control the grating lobes as shown by **eq. 3** or **4**. This represents a form of understacking and lower gain. When this situation, plus feedline losses and mutual coupling, are considered, you are probably lucky to attain 2.5 dB even when the optimum stacking distance is used (more on this subject next month).

After studying this subject and reference 3, it will become obvious that the level of the first side lobe is a very important antenna parameter. Unfortunately, most antenna designers rarely list this parameter, but instead often list the worthless front-to-side ratio! A change in the literature indicating the level of the first side lobe would be an improvement.

final evaluation

You should be able to test your pattern using the information just given, especially if your antennas are stacked in the horizontal plane. The test methods described in reference 3 should be sufficient. For those on EME, the sun can be used as a rough check. Always remember that if the antenna beamwidth is narrower than originally calculated and/or the grating

lobes are less than 13 dB down from the main lobe, you have probably overstacked (i.e., positioned your antennas too far apart).

summary

Part 1 of this two-part series has been written to give you a feel for what happens when two or more antennas are stacked. Typical examples have been provided along with the equations and graphs necessary for determining optimum stacking distance. New or improved Yagi antennas or those I may have failed to mention can be quickly evaluated using the information provided in this article. Exact stacking distance is not critical since there are many compromises, as discussed.

Part 2 of this article will delve a little deeper into the subject, emphasizing the practical aspects of the subject with recommendations on how to obtain optimal performance in your particular situation.

acknowledgements

I would particularly like to thank Günther Hoch, DL6WU, Dave Olean, K1WHS, and Steve Powlshen, K1FO, for the test data they shared with me while I was preparing this article.

references

1. Joe Reisert, W1JR, "Requirements and Recommendations for 70-cm EME," *ham radio*, June, 1982 page 12.
2. Jim Kennedy, K6MIO, "Antennas and Capture Area," *ham radio*, November, 1969, page 42.
3. Joe Reisert, W1JR, "VHF/UHF World: Determining VHF/UHF Antenna Performance," *ham radio*, May, 1984, page 110.
4. Carl Greenblum, "Notes on the Development of Yagi Arrays, Part II: Stacking Yagis," *QST*, September, 1956, page 23.
5. Samuel Silver, "Microwave Antenna Theory and Design," *MIT Rad. Lab Series* No. 12.
6. John D. Kraus, Ph.D., *Antennas*, McGraw Hill Book Co., page 66.
7. H.W. Kasper, K2GAL, "Optimum Stacking Spacing in Antenna Arrays," *QST*, April, 1958, page 40.
8. H.W. Kasper, K2GAL, "Array Design with Optimum Antenna Spacing," *QST*, November, 1960, page 23.
9. Tony Dorbeck, W1YNC, "Calculating Vertical Pattern of Repeater Antennas," *QST*, April, 1973, page 24.
10. Günther Hoch, DL6WU, "Optimum Spacing of Directional Antennas," *VHF Communications*, issue No. 3, 1979.

upcoming VHF/UHF events

- April 5: *EME Perigee*
- April 15: *ARRL 2-meter Sprint Contest*
- April 21: *1400 UTC: predicted peak of Lyrids meteor shower*
- April 21: *ARRL 135-cm Sprint Contest*
- April 26-28: *Dayton Hamvention VHF/UHF Program (contact WA8ONQ)*
- May 1: *ARRL 70-cm Sprint Contest*
- May 4: *EME Perigee*
- May 4: *1300 UTC: predicted peak of Eta Aquarids meteor shower*
- May 3-5: *West Coast VHF Conference (contact W6RXQ)*
- May 9: *ARRL 23-cm Sprint Contest*
- May 18,19: *Eastern VHF/UHF Conference (contact W1EJ)*
- May 19: *ARRL 6-meter Sprint Contest (tentative)*

ham radio

CRYSTAL FILTER SALE

Top-quality 8-pole CW/SSB/AM FOX TANGO filters

For most

KENWOOD · YAESU · HEATHKIT

Also DRAKE R-4C/7-Line, COLLINS 75S-3B/C, and ICOM (FL44A Type)

All Regular \$60 filters NOW Only **\$49.50**

All Regular \$110 filters NOW Only **\$99.50**

All Regular \$170 Matched-Pair

Filter Kits NOW Only **\$139 pair**

All Filter-Cascading Kits NOW Only **\$75 each**

Quantity discounts when sent to one address (excluding matched-pair kits)

Any two units (filters, cascading kits, or combos) **10% OFF**

Any three units or more (as above) **15% OFF**

HURRY! SALE ENDS MAY 1, 1985

FOX TANGO filter bandwidths range from 125 to 6000

Hz with center frequencies to match your rig. Most

filters are drop-in or plug-in type; some patch-in.

Matched-pair filter kits are available for R820, TS830/

930 and FT-980; filter cascading kits for TS430/520/

820, FT-101/101ZD/107/901-2, Heath SB-104A. For complete

details send us a business-size SASE marked "FT Filter Sale"

and your rig's Make and Model Number. Or to save time, phone for information and

order directly. We accept VISA/MC or ship C.O.D. in US.

FOX TANGO FILTERS contain eight specially treated

and aged discrete crystals, unlike ceramic or monolithic

corner-cutting designs. An implant or transplant

with a time-tested FT filter or cascading kit will give

your rig new life. Our best advertisements are

thousands of satisfied users — check out our claims

over the air — you'll learn that FOX TANGO is best!

Our filters cost less and are guaranteed longer — ONE

YEAR — order with confidence. Why risk disappointment

with some unknown or unproven brand?

GO FOX TANGO-TO BE SURE!



FOX TANGO CORP.

P.O. Box 15944, Dept. H

W. Palm Beach, FL 33416

Telephone: **(305) 683-9587**

**SAY YOU SAW IT
IN
HAM RADIO**

TUBES

TYPE	PRICE	TYPE	PRICE	TYPE	PRICE
2C39/7289	\$ 34.00	1182/4600A	\$500.00	ML7815AL	\$ 60.00
2E26	7.95	4600A	500.00	7843	107.00
2K28	200.00	4624	310.00	7854	130.00
3-500Z	102.00	4657	84.00	ML7855KAL	125.00
3-1000Z/8164	400.00	4662	100.00	7984	14.95
3B28/866A	9.50	4665	500.00	8072	84.00
3CX400U7/8961	255.00	4687	P.O.R.	8106	5.00
3CX1000A7/8283	526.00	5675	42.00	8117A	225.00
3CX3000F1/8239	567.00	5721	250.00	8121	110.00
3CW30000H7	1700.00	5768	125.00	8122	110.00
3X2500A3	473.00	5819	119.00	8134	470.00
3X3000F1	567.00	5836	232.50	8156	12.00
4-65A/8165	69.00	5837	232.50	8233	60.00
4-125A/4D21	79.00	5861	140.00	8236	35.00
4-250A/5D22	98.00	5867A	185.00	8295/PL172	500.00
4-400A/8438	98.00	5868/AX9902	270.00	8458	35.00
4-400B/7527	110.00	5876/A	42.00	8462	130.00
4-400C/6775	110.00	5881/6L6	8.00	8505A	95.00
4-1000A/8166	444.00	5893	60.00	8533W	136.00
4CX250B/7203	54.00	5894/A	54.00	8560/A	75.00
4CX250FG/8621	75.00	5894E/8737	54.00	8560AS	100.00
4CX250K/8245	125.00	5946	395.00	8608	38.00
4CX250R/7580W	90.00	6083/AZ9909	95.00	8624	100.00
4CX300A/8167	170.00	6146/6146A	8.50	8637	70.00
4CX350A/8321	110.00	6146B/8298	10.50	8643	83.00
4CX350F/8322	115.00	6146W/7212	17.95	8647	168.00
4CX350FJ/8904	140.00	6156	110.00	8683	95.00
4CX600J/8809	835.00	6159	13.85	8877	465.00
4CX1000A/8168	242.50*	6159B	23.50	8908	13.00
4CX1000A/8168	485.00	6161	325.00	8950	13.00
4CX1500B/8660	555.00	6280	42.50	8930	137.00
4CX5000A/8170	1100.00	6291	180.00	6L6 Metal	25.00
4CX10000/8171	1255.00	6293	24.00	6L6GC	5.03
4CX15000A/8281	1500.00	6326	P.O.R.	6CA7/EL34	5.38
4CW800F	710.00	6360/A	5.75	6CL6	3.50
4D32	240.00	6399	540.00	6DJ8	2.50
4E27A/5-125B	240.00	6550A	10.00	6DQ5	6.58
4PR60A	200.00	6883B/8032A/8552	10.00	6GF5	5.85
4PR60B	345.00	6897	160.00	6GJ5A	6.20
4PR65A/8187	175.00	6907	79.00	6GK6	6.00
4PR1000A/8189	590.00	6922/6DJ8	5.00	6HB5	6.00
4X150A/7034	60.00	6939	22.00	6HF5	8.73
4X150D/7609	95.00	7094	250.00	6JG6A	6.28
4X250B	45.00	7117	38.50	6JM6	6.00
4X250F	45.00	7203	P.O.R.	6JN6	6.00
4X500A	412.00	7211	100.00	6JS6C	7.25
5CX1500A	660.00	7213	300.00*	6KN6	5.05
KT88	27.50	7214	300.00*	6KD6	8.25
416B	45.00	7271	135.00	6LF6	7.00
416C	62.50	7289/2C39	34.00	6LQ6 G.E.	7.00
572B/T160L	49.95	7325	P.O.R.	6LQ6/6MJ6 Sylvania	9.00
592/3-200A3	211.00	7360	13.50	6ME6	8.90
807	8.50	7377	85.00	12AT7	3.50
811A	15.00	7408	2.50	12AX7	3.00
812A	29.00	7609	95.00	12BY7	5.00
813	50.00	7735	36.00	12JB6A	6.50

NOTE * = USED TUBE

NOTE P.O.R. = PRICE ON REQUEST

"ALL PARTS MAY BE NEW, USED, OR SURPLUS. PARTS MAY BE SUBSTITUTED WITH COMPARABLE PARTS IF WE ARE OUT OF STOCK OF AN ITEM.

NOTICE: ALL PRICES ARE SUBJECT TO CHANGE WITHOUT NOTICE.

For information call: 602-265-0731

Toll Free Number
800-528-0180
(For orders only)

"All parts may be new or surplus, and parts may be substituted with comparable parts if we are out of stock of an item."

MHz electronics

3802 North 27th Ave., Phoenix, AZ 85017

PRICES SUBJECT TO CHANGE WITHOUT NOTICE

"FILTERS"

COLLINS Mechanical Filter #526-9724-010 MODEL F455Z32F

455KHZ at 3.2KHz wide. May be other models but equivalent. May be used or new, \$15.99

ATLAS Crystal Filters

5.595-2.7/8/LSB, 5.595-2.7/LSB
8 pole 2.7KHz wide Upper sideband. Impedance 800ohms 15pf In/800ohms 0pf out. 19.99

5.595-2.7/8/U, 5.595-2.7/USB
8 pole 2.7KHz wide Upper sideband. Impedance 800ohms 15pf In/800ohms 0pf out. 19.99

5.595-.500/4, 5.595-.500/4/CW
4 pole 500 cycles wide CW. Impedance 800ohms 15pf In/800ohms 0pf out. 19.99

9.0USB/CW
6 pole 2.7KHz wide at 6dB. Impedance 680ohms 7pf In/300ohms 8pf out. CW-1599Hz 19.99

KOKUSAI ELECTRIC CO. Mechanical Filter #MF-455-ZL/ZU-21H

455KHz at Center Frequency of 453.5KC. Carrier Frequency of 455KHz 2.36K Bandwidth.
Upper sideband. (ZU) 19.99
Lower sideband. (ZL) 19.99

CRYSTAL FILTERS

NIKKO	FX-07800C	7.8MHz	\$10.00
TEW	FEC-103-2	10.6935MHz	10.00
SDK	SCH-113A	11.2735MHz	10.00
TAMA	TF-31H250	CF 3179.3KHz	19.99
TYCO/CD	001019880	10.7MHz 2pole 15KHz bandwidth	5.00
MOTOROLA	4884863B01	11.7MHz 2pole 15KHz bandwidth	5.00
PTI	5350C	12MHz 2pole 15KHz bandwidth	5.00
PTI	5426C	21.4MHz 2pole 15KHz bandwidth	5.00
PTI	1479	10.7MHz 8pole bandwidth 7.5KHz at 3dB, 5KHz at 6dB	20.00
COMITECH	A10300	45MHz 2pole 15KHz bandwidth	6.00
FRC	ERXF-15700	20.6MHz 36KHz wide	10.00
FILTECH	2131	CF 7.825MHz	10.00

CERAMIC FILTERS

AXEL	4F449	12.6KC Bandpass Filter 3dB bandwidth 1.6KHz from 11.8-13.4KHz	10.00
CLEVITE	TO-01A	455KHz+-2KHz bandwidth 4-7% at 3dB	5.00
	TCF4-12D36A	455KHz+-1KHz bandwidth 6dB min 12KHz, 60dB max 36KHz	10.00
MURATA	BFB455B	455KHz	2.50
	BFB455L	455KHz	3.50
	CFM455E	455KHz +-5.5KHz at 3dB, +-8KHz at 6dB, +-16KHz at 50dB	6.65
	CFM455D	455KHz +-7KHz at 3dB, +-10KHz at 6dB, +-20KHz at 50dB	6.65
	CFR455E	455KHz +-5.5KHz at 3dB, +-8KHz at 6dB, +-16KHz at 60dB	8.00
	CFU455B	455KHz +-2KHz bandwidth +-15KHz at 6dB, +-30KHz at 40dB	2.90
	CFU455C	455KHz +-2KHz bandwidth +-12.5KHz at 6dB, +-24KHz at 40dB	2.90
	CFU455G	455KHz +-1KHz bandwidth +-4.5KHz at 6dB, +-10KHz at 40dB	2.90
	CFU455H	455KHz +-1KHz bandwidth +-3KHz at 6dB, +-9KHz at 40dB	2.90
	CFU455I	455KHz +-1KHz bandwidth +-2KHz at 6dB, +-6KHz at 40dB	2.90
	CFW455D	455KHz +-10KHz at 6dB, +-20KHz at 40dB	2.90
	CFW455H	455KHz +-3KHz at 6dB, +-9KHz at 40dB	2.90
	SFB455D	455KHz	2.50
	SFD455D	455KHz +-2KHz, 3dB bandwidth 4.5KHz +-1KHz	5.00
	SFE10.7MA	10.7MHz 280KHz +-50KHz at 3dB, 650KHz at 20dB	2.50
	SFE10.7MS	10.7MHz 230KHz +-50KHz at 3dB, 570KHz at 20dB	2.50
	SFG10.7MA	10.7MHz	10.00
NIPPON	LF-B4/CFU455I	455KHz +-1KHz	2.90
	LF-B6/CFU455H	455KHz +-1KHz	2.90
	LF-B8	455KHz	2.90
	LF-C18	455KHz	10.00
TOKIN	CF455A/BFU455K	455KHz +-2KHz	5.00
MATSUSHIRA	EFC-L455K	455KHz	7.00

SPECTRA PHYSICS INC. Model 088 HeNe LASER TUBES

POWER OUTPUT 1.6MW.	BEAM DIA. .75MM	BEAM DIR. 2.7MR	SKV STARTING VOLTAGE DC
68K OHM 1WATT BALLAST	1000VDC +-100VDC	At 3.7MA	\$59.99

ROTRON MUFFIN FANS Model MARK4/MU2A1

115 VAC	14WATTS	50/60CPS	IMPEDENCE PROTECTED-F	88CFM at 50CPS	\$ 7.99
105CFM at 60CPS		THESE ARE NEW			

MHz electronics

Toll Free Number
800-528-0180
(For orders only)

"All parts may be new or surplus, and parts may be substituted with comparable parts if we are out of stock of an item."

3802 North 27th Ave., Phoenix, AZ 85017

PRICES SUBJECT TO CHANGE WITHOUT NOTICE For information call: 602-265-0731

RF TRANSISTORS

TYPE	PRICE	TYPE	PRICE	TYPE	PRICE	TYPE	PRICE
2N1561	\$25.00	2N5920	\$ 70.00	40608 RCA	\$ 2.48	BFY90	\$ 1.50
2N1562	25.00	2N5921	80.00	40673 RCA	2.50	BLW60C5	15.00
2N1692	25.00	2N5922	10.00	40894 RCA	1.00	BLX67	12.25
2N2857	1.55	2N5923	25.00	60247 RCA	25.00	BLX67C3	12.25
2N2857JAN	4.10	2N5941	23.00	61206 RCA	100.00	BLX93C3	22.21
2N2857JANTX	4.50	2N5942	40.00	62800A RCA	60.00	BLY87A	7.50
2N2876	13.50	2N5944	10.35	62803 RCA	100.00	BLY88C3	13.08
2N2947	18.35	2N5945	10.00	430414/3990RCA	50.00	BLY89C	13.00
2N2948	13.00	2N5946	12.00	3457159 RCA	20.00	BLY90	45.00
2N2949	15.50	2N5947	9.20	3729685-2 RCA	75.00	BLY92	13.30
2N3118	5.00	2N6080	6.00	3729701-2 RCA	50.00	BLY94C	45.00
2N3119	4.00	2N6081	7.00	3753883 RCA	50.00	BLY351	10.00
2N3134	1.15	2N6082	9.00	615467-902	25.00	BLY568C/CF	30.00
2N3287	4.90	2N6083	9.50	615467-903	40.00	C2M70-28R	92.70
2N3288	4.40	2N6084	12.00	2SC568	2.50	C25-28	57.00
2N3309	4.85	2N6094	11.00	2SC703	36.00	C4005	2.50
2N3375	17.10	2N6095	12.00	2SC756A	7.50	CD1659	20.00
2N3478	2.13	2N6096	16.10	2SC781	2.80	CD1899	20.00
2N3553	1.55	2N6097	20.70	2SC1018	1.00	CD1920	10.00
2N3553JAN	2.90	2N6105	21.00	2SC1042	24.00	CD2188	18.00
2N3632	15.50	2N6136	21.85	2SC1070	2.50	CD2545	24.00
2N3733	11.00	2N6166	40.24	2SC1216	2.50	CD2664A	16.00
2N3818	5.00	2N6267	142.00	2SC1239	2.50	CD3167	92.70
2N3866	1.30	2N6304	1.50	2SC1251	24.00	CD3353	95.00
2N3866JAN	2.20	2N6368	30.00	2SC1306	2.90	CD3435	26.30
2N3866JANTX	3.80	2N6439	55.31	2SC1307	5.50	CD3900	152.95
2N3866JANTXV	4.70	2N6459	18.00	2SC1424	2.80	CM25-12	20.00
2N3866AJANTXV	5.30	2N6567	10.06	2SC1600	5.00	CM40-12	27.90
2N3924	3.35	2N6603	13.50	2SC1678	2.00	CM40-28	56.90
2N3926	16.10	2N6604	13.50	2SC1729	32.40	CME50-12	30.00
2N3927	17.25	2N6679	44.00	2SC1760	1.50	CTC2001	42.00
2N3948	1.75	2N6680	80.00	2SC1909	4.00	CTC2005	55.00
2N3950	25.00	021-1	15.00	2SC1945	10.00	CTC3005	70.00
2N3959	3.85	01-80703T4	65.00	2SC1946	40.00	CTC3460	20.00
2N4012	11.00	35C05	15.00	2SC1947	10.00	DV2820S	25.00
2N4037	2.00	102-1	28.00	2SC1970	2.50	DXL1003P70	22.00
2N4041	14.00	103-1	28.00	2SC1974	4.00	DXL2001P70	19.00
2N4072	1.80	103-2	28.00	2SC2166	5.50	DXL2002P70	14.00
2N4080	4.53	104P1	18.00	2SC2237	32.00	DXL3501AP100F	47.00
2N4127	21.00	163P1	10.00	2SC2695	47.00	EFJ4015	12.00
2N4416	2.25	181-3	15.00	A2X1698	POR	EFJ4017	24.00
2N4427	1.25	210-2	10.00	A3-12	14.45	EFJ4021	24.00
2N4428	1.85	269-1	18.00	A50-12	24.00	EFJ4026	35.00
2N4430	11.80	281-1	15.00	A209	10.00	EN15745	20.00
2N4927	3.90	282-1	30.00	A283	6.00	FJ9540	16.00
2N4957	3.45	482	7.50	A283B	6.00	FSX52WF	58.00
2N4959	2.30	564-1	25.00	A1610	19.00	G65739	25.00
2N5016	18.40	698-3	15.00	AF102	2.50	G65386	25.00
2N5026	15.00	703-1	15.00	AFY12	2.50	GMO290A	2.50
2N5070	18.40	704	4.00	AR7115	20.00	HEP76	4.95
2N5090	13.80	709-2	11.00	AT41435-5	6.35	HEPS3002	11.40
2N5108	3.45	711	4.00	B2-8Z	10.70	HEPS3003	30.00
2N5109	1.70	733-2	15.00	B3-12	10.85	HEPS3005	10.00
2N5160	3.45	798-2	25.00	B12-12	15.70	HEPS3006	19.90
2N5177	21.62	3421	28.00	BAL0204125	152.95	HEPS3007	25.00
2N5179	1.04	3683P1	15.00	BF25-35	56.25	HEPS3010	11.34
2N5216	56.00	3992	25.00	B40-12	19.25	HF8003	10.00
2N5470	75.00	4164P1	15.00	B70-12	55.00	HFET2204	112.00
2N5583	3.45	4243P1	28.00	BF272A	2.50	HP35821	38.00
2N5589	9.77	4340P3	18.00	BFQ85	2.50	HP35826B	32.00
2N5590	10.92	4387P1	27.50	BFR21	2.50	HP35826E	32.00
2N5591	13.80	7104-1	28.00	BFR90	1.00	HP35831E	30.00
2N5596	99.00	7249-2	10.50	BFR91	1.65	HP35832E	50.00
2N5636	12.00	7283-1	37.50	BFR99	2.50	HP35833E	50.00
2N5637	15.50	7536-1	30.00	BFT12	2.50	HP35859E	75.00
2N5641	12.42	7794-1	10.50	BFW16A	2.50	HP35866E	44.00
2N5642	14.03	7795	15.00	BFW17	2.50	HXTR2101	44.00
2N5643	25.50	7795-1	15.00	BFW92	1.50	HXTR3101	7.00
2N5645	13.80	7796-1	24.00	BFX44	2.50	HXTR5101	31.00
2N5646	20.70	7797-1	36.00	BFX48	2.50	HXTR6104	68.00
2N5651	11.05	40081 RCA	5.00	BFX65	2.50	HXTR6105	31.00
2N5691	18.00	40279 RCA	10.00	BFX84	2.50	HXTR6106	33.00
2N5764	27.00	40280 RCA	4.62	BFX85	2.50	J310	1.00
2N5836	3.45	40281 RCA	10.00	BFX86	2.50	Jo2000	10.00
2N5842	8.45	40282 RCA	20.00	BFX89	1.00	Jo2001	25.00
2N5847	19.90	40290 RCA	2.80	BFY11	2.50	Jo4045	24.00
2N5849	20.00	40292 RCA	13.05	BFY18	2.50	KD5522	25.00
2N5913	3.25	40294 RCA	2.50	BFY19	2.50	KJ5522	25.00
2N5916	36.00	40341 RCA	21.00	BFY39	2.50	M1106	13.75

Toll Free Number
800-528-0180
(For orders only)

"All parts may be new or surplus, and parts may be substituted with comparable parts if we are out of stock of an item."

For information call: 602-265-0731

PRICES SUBJECT TO CHANGE WITHOUT NOTICE

MHz electronics

3802 North 27th Ave., Phoenix, AZ 85017

RF TRANSISTORS (CONTINUED)

M1107	\$16.75	MRF458	\$20.70	NEO2160ER	\$100.00	SD1009	\$15.00
M1131	5.15	MRF464	25.30	NEO21350	5.30	SD1009-2	15.00
M1132	7.25	MRF466	18.97	NE13783	61.00	SD1012	10.00
M1134	13.40	MRF472	1.50	NE21889	43.00	SD1012-3	10.00
M9116	29.10	MRF475	3.10	NE57835	5.70	SD1012-5	10.00
M9579	6.00	MRF476	3.16	NE64360ER-A	100.00	SD1013	10.00
M9580	7.95	MRF477	20.00	NE64480 (B)	94.00	SD1013-3	10.00
M9587	7.00	MRF479	8.05	NE73436	2.50	SD1013-7	10.00
M9588	5.20	MRF492	23.00	NE77362ER	100.00	SD1016	15.00
M9622	5.95	MRF502	1.04	NE98260ER	100.00	SD1016-5	15.00
M9623	7.95	MRF503	6.00	PRT8637	25.00	SD1018-4	13.00
M9624	9.95	MRF504	7.00	PT3127A	5.00	SD1018-6	13.00
M9625	15.95	MRF509	5.00	PT3127B	5.00	SD1018-7	13.00
M9630	14.00	MRF511	10.69	PT3127C	20.00	SD1018-15	13.00
M9740	27.90	MRF515	2.00	PT3127D	20.00	SD1020-5	10.00
M9741	27.90	MRF517	2.00	PT3127E	20.00	SD1028	15.00
M9755	16.00	MRF525	3.45	PT3190	20.00	SD1030	12.00
M9780	5.50	MRF559	1.76	PT3194	20.00	SD1030-2	12.00
M9827	11.00	MRF587	11.00	PT3195	20.00	SD1040	5.00
M9848	35.00	MRF605	20.00	PT3537	7.80	SD1040-2	20.00
M9850	13.50	MRF618	25.00	PT4166E	20.00	SD1040-4	10.00
M9851	20.00	MRF626	12.00	PT4176D	25.00	SD1040-6	5.00
M9860	8.25	MRF628	8.65	PT4186B	5.00	SD1043	12.00
M9887	2.80	MRF629	3.45	PT4209	25.00	SD1043-1	10.00
M9908	6.95	MRF641	25.30	PT4209C/5645	25.00	SD1045	3.75
M9965	12.00	MRF644	27.60	PT4556	24.60	SD1049-1	2.00
MM1500	25.00	MRF646	29.90	PT4570	7.50	SD1053	4.00
MM1550	10.00	MRF648	33.35	PT4577	20.00	SD1057	10.00
MM1552	50.00	MRF816	15.00	PT4590	5.00	SD1065	4.75
MM1553	50.00	MRF823	20.00	PT4612	20.00	SD1068	15.00
MM1607	8.45	MRF846	44.85	PT4628	20.00	SD1074-2	18.00
MM1614	10.00	MRF892	35.50	PT4640	20.00	SD1074-4	28.00
MM1810	15.00	MRF894	46.00	PT4642	20.00	SD1074-5	28.00
MM1810	15.00	MRF901 3 Lead	1.00	PT5632	4.70	SD1076	18.50
MM1943	1.80	MRF901 4 Lead	2.00	PT5749	25.00	SD1077	4.00
MM2608	5.00	MRF902/2N6603JAN	15.00	PT6612	25.00	SD1077-4	4.00
MM3375A	17.10	MRF902B	18.40	PT6619	20.00	SD1077-6	4.00
MM4429	10.00	MRF904	2.30	PT6708	25.00	SD1078-6	24.00
MM8000	1.15	MRF905	2.55	PT6709	25.00	SD1080-7	7.50
MM8006	2.30	MRF911	2.50	PT6720	25.00	SD1080-8	6.00
MM8011	25.00	MRF965	2.55	PT8510	15.00	SD1080-9	3.00
MPSU31	1.01	MRF966	3.55	PT8524	25.00	SD1084	8.00
MRA2023-1.5	42.50	MRF1000MA	32.77	PT8609	25.00	SD1087	15.00
MRF134	10.50	MRF1004M	31.05	PT8633	25.00	SD1088	22.00
MRF136	16.00	MRF2001	41.74	PT8639	25.00	SD1088-8	22.00
MRF171	35.00	MRF2005	54.97	PT8659	25.00	SD1089-5	15.00
MRF208	11.50	MRF5176	24.00	PT8679	25.00	SD1090	15.00
MRF212	16.10	MRF8004	2.10	PT8708	20.00	SD1094	15.00
MRF221	10.00	MSC1720-12	225.00	PT8709	20.00	SD1095	15.00
MRF223	13.00	MSC1821-3	125.00	PT8727	29.00	SD1098-1	30.00
MRF224	13.50	MSC1821-10	225.00	PT8731	25.00	SD1100	5.00
MRF227	3.45	MSC2001	30.00	PT8742	19.10	SD1109	18.00
MRF230	2.00	MSC2010	93.00	PT8787	25.00	SD1115-2	7.50
MRF231	10.00	MSC2223-10	245.00	PT8828	25.00	SD1115-3	7.50
MRF232	12.07	MSC2302	POR	PT9700	25.00	SD1115-7	2.10
MRF237	3.15	MSC3000	35.00	PT9702	25.00	SD1116	5.00
MRF238	13.80	MSC3001	38.00	PT9783	16.50	SD1118	22.00
MRF239	17.25	MSC72002	POR	PT9784	32.70	SD1119	5.00
MRF245	35.65	MSC73001	POR	PT9790	56.00	SD1124	50.00
MRF247	31.00	MSC80064	35.00	PT31083	20.00	SD1132-1	15.00
MRF304	36.00	MSC80091	10.00	PT31962	20.00	SD1132-4	12.00
MRF306	50.00	MSC80099	3.00	PTX6680	20.00	SD1133	9.50
MRF313	11.15	MSC80593	POR	RE3754	25.00	SD1133-1	10.00
MRF314	29.21	MSC80758	POR	RE3789	25.00	SD1134-1	2.50
MRF315	28.86	MSC82001	33.00	RF35	16.00	SD1134-4	12.00
MRF316	55.43	MSC82014	33.00	RF85	17.50	SD1134-17	12.00
MRF317	63.94	MSC82020M	130.00	RF110	21.00	SD1135	10.25
MRF412	18.00	MSC82030	33.00	S50-12	23.80	SD1135-3	12.00
MRF420	20.12	MSC83001	40.00	S3006	15.00	SD1136	12.50
MRF421	25.00	MSC83003	82.00	S3007	10.00	SD1136-2	12.50
MRF422	38.00	MSC83005	70.00	S3031	22.00	SD1143-1	10.00
MRF427	17.25	MSC83026	POR	SCA3522	5.00	SD1143-3	17.00
MRF428	63.00	MSC83303	POR	SCA3523	5.00	SD1144	4.00
MRF433	12.07	MSC84900	60.00	SD345	5.00	SD1145-5	15.00
MRF449/A	12.65	MT4150	14.40	SD445	5.00	SD1146	15.00
MRF450/A	14.37	MT5126	25.00	SD1004	15.00	SD1147	15.00
MRF452/A	17.00	MT5596(2N)	99.00	SD1007	15.00	SD1188	10.00
MRF453/A	18.40	MT5768(2N)	95.00	SD1007-2	15.00	SD1189	24.00
MRF454/A	20.12	MT8762	25.00	SD1007-4	15.00	SD1200	1.50
MRF455/A	16.00	NEO2136	2.00	SD1007-5	15.00	SD1201-2	15.00

Toll Free Number
800-528-0180
(For orders only)

"All parts may be new or surplus, and parts may be substituted with comparable parts if we are out of stock of an item."
For information call: 602-265-0731

MHz electronics

3802 North 27th Ave., Phoenix, AZ 85017

PRICES SUBJECT TO CHANGE WITHOUT NOTICE

E.F. JOHNSON ROLLER INDUCTORS

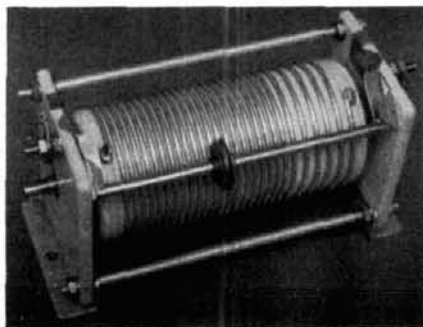
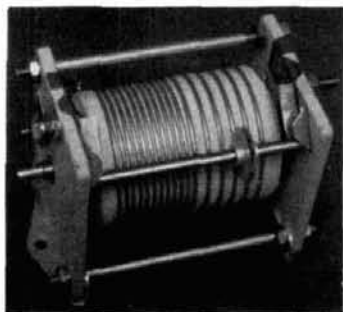

MODEL 229-0201-01 10UH at 3AMPS MAX. \$36.99 MODEL 229-0202-01 18UH at 5AMPS MAX. \$44.99

UNELCO, SEMCO, ARCO METAL CLAD MICA CAPACITORS

Standard Size					Micro Size	
3.9	14	33	62	175	5	25
4.7	15	34	68	180	6	27
5	18	36	75	200	7	33
5.1	20	38	80	220	8	36
6.8	22	39	82	240	9	51
7	24	40	100	250	12	62
8.2	25	43	110	300	15	
9.1	27	44	120	360	16	
10	27.5	47	123	470	18	
11	28	50	125	500	20	
12	30	51	140	820	22	
13	32	56	150	1000	24	

*****NOTE ALL VALUES LISTED IN PICO FARAD*****

PRICE INFORMATION

1 to 10 \$.90ea. 11 to 51 \$.80ea. 52 to 102 \$.70ea.
103 and up call

GOULD NI-CAD BATTERIES

AA size 1.25v at 500mahr new a \$ 1.99
D size 1.25v at 4 AMPHR new h 7.49

GENERAL ELECTRIC NI-CAD BATTERIES

AA size 1.25v at 500mahr new a 2.99
195194 3.75v at 100mahr new 1.99
AA size 3.75v at 100mahr new a 2.99
AA size pack of 10 12.5v at 450mahr used a 5.99
Sub C Pack of 10 12.5v at 2.5Amphr new c 9.99

UNION CARBIDE NI-CAD BATTERIES

193817 3.75v at 225mahr new a 2.99

GLOBE GEL-CELL BATTERIES

2v at 8AMPHR GC280 new g 5.99
12v at 20AMPHR GC12200 new g 49.99
12v at 23AMPHR GC12300 new g 54.99

EAGLE PICHER GEL-CELL BATTERIES

12v at 1.5AMPHR CF12V1.5 new d 11.99

GATES SEALED RECHARGEABLE LEAD ACID BATTERIES AND PACKS

2v at 2.5AMPHR D Cell new b 5.99
8v at 5AMPHR 4 X Cell used f 14.99
12v at 2.5AMPHR 6 D Cells new f 24.99
18v at 2.5AMPHR 9 D Cells new f 29.99

GENERAL ELECTRIC SEALED REACHARABLE LEAD ACID BATTERIES AND PACKS

6v at 2.5AMPHR 3 D Cells used e 10.00
12v at 2.5AMPHR 6 D Cells used e 19.99
12v at 5AMPHR 6 X Cells used e 24.99

Toll Free Number
800-528-0180
(For orders only)

"All parts may be new or surplus, and parts may be substituted with comparable parts if we are out of stock of an item."

For information call: 602-265-0731

MHz electronics

3802 North 27th Ave., Phoenix, AZ 85017

PRICES SUBJECT TO CHANGE WITHOUT NOTICE

NI-CAD BATTERY CHARGERS



UNIVERSAL CHARGER \$19.99



MALLORY CHARGER \$23.99

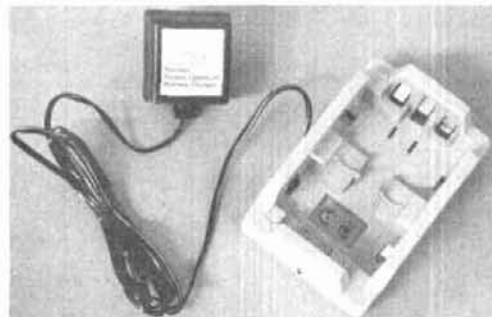

EVEREADY CHARGER \$9.99



RF Transistors (continued)

SD1202	\$10.00	SD1304-8	\$ 2.50	SD1531-2	\$15.00	SRF1427	\$50.00	SD1244H12	25.00	SD1410-8	21.00	SD1536-1	41.00	SRF2917	15.00
SD1212-8	4.95	SD1305	3.00	SD1452	20.00	SRF1431	40.00	SD1262	15.00	SD1413-1	18.00	SD1539H	100.00	SRF2918	15.00
SD1212-11	4.95	SD1307	3.00	SD1452-4	24.00	SRF1834	40.00	SD1263	15.00	SD1416	28.00	SD1542H1	170.00	SRF2919	15.00
SD1212-16	4.95	SD1308	3.00	SD1453H1	20.00	SRF2033-3	60.00	SD1263-1	15.00	SD1422-2	24.00	SD1544	26.00	SRF3011FF	50.00
SD1214-7	5.00	SD1311	1.00	SD1454-1	48.00	SRF2092	50.00	SD1272	10.95	SD1428	24.00	SD1545	33.00	SR4006	25.00
SD1214-11	5.00	SD1317	8.00	SD1477	35.00	SRF2147	22.00	SD1272-1	10.95	SD1428-6084	12.00	SD1546H1	55.00	SR4132	15.00
SD1216	12.00	SD1319	2.50	SD1478	21.00	SRF2225	15.00	SD1272-2	10.95	SD1429-2	15.00	SD1561	28.00	TA7686	15.00
SD1219-4	15.00	SD1345-4	5.00	SD1480	53.00	SRF2264	25.00	SD1272-4	10.95	SD1429-3	14.90	SD1574-1	6.95	TAR559	15.00
SD1219-5	15.00	SD1347-1	1.00	SD1484	1.50	SRF2285	100.00	SD1278	13.75	SD1429-5	15.00	SD1575	6.95	TAR561	15.00
SD1219-8	15.00	SD1345-1	2.50	SD1484-5	1.50	SRF2281	5.00	SD1278-1	13.75	SD1430	12.00	SR4557	23.00	TAR562	15.00
SD1220	8.00	SD1365-5	2.50	SD1484-6	1.50	SRF2371	15.00	SD1278-5	13.75	SD1430-2	18.00	SR3048	5.00	TAR563	15.00
SD1220-1	9.50	SD1375	7.50	SD1486-7	1.50	SRF2347	50.00	SD1278-1	18.00	SD1434	28.00	SL301-39	13.00	TAR564	15.00
SD1220-9	8.00	SD1375-6	7.50	SD1488	22.85	SRF2336	18.00	SD1279-3	18.00	SD1434-5	28.00	SL301-171	15.00	TAR894	15.00
SD1222-8	16.00	SD1379	5.00	SD1488-1	28.00	SRF2378	16.00	SD1281-2	8.00	SD1434-9	28.00	SRF112	5.00	TP1189	3.55
SD1222-11	7.50	SD1380-1	1.00	SD1488-7	27.00	SRF2572	25.00	SD1283	10.00	SD1438	26.00	SRF112	15.00	TP312	2.50
SD1224-10	18.00	SD1380-3	1.00	SD1488-8	28.00	SRF2584	40.00	SD1283-2	10.60	SD1441	56.00	SRF395	50.00	TP1014	5.00
SD1225	18.00	SD1380-7	1.00	SD1499-1	36.00	SRF2597	25.00	SD1283-3	10.00	SD1442	15.00	SRF750	16.00	TP1028	15.00
SD1225-1	15.00	SD1405	21.00	SD1511H1	75.00	SRF2741	40.00	SD1283-4	10.00	SD1444	3.25	SRF769H	20.00	TR93	5.00
SD1229-7	10.95	SD1408	25.00	SD1520-2	18.00	SRF2747	60.00	SD1289-1	15.00	SD1444-8	3.25	SRF88763	2.50	TXVF2201/HP	450.00
SD1229-16	10.95	SD1409	18.00	SD1522-4	33.00	SRF2747H	40.00	SD1290-4	15.00	SD1444-9	3.25	SRF989K	15.00	V222-2	25.00
SD1232	4.00	SD1410	18.00	SD1528-1	24.00	SRF2821	25.00	SD1290-7	15.00	SD1446	4.01	SRF1005	30.00	V4101E	20.00
SD1240-8	15.00	SD1410-3	21.00	SD1528-3	34.00	SRF2822/286601	13.50	SD1300	1.25	SD1450-1	28.00	SRF1016	5.00	V415	5.00
SD1244-1	14.00	SD1410-6	21.00	SD1530-2	38.00	SRF2857	20.00	SD1301-7	3.00	SD1451	15.00	SRF1074	30.00		

Relays

BNC To Banana Plug Coax Cable RG-58 36 inch or BNC to N Coax Cable RG-58 36 inch.

\$7.99 or 2 For \$13.99 or 10 For \$50.00

\$8.99 or 2 For \$15.99 or 10 For \$60.00

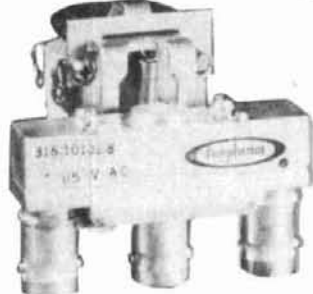

Amphenol
Part # 316-10102-8
115Vac Type BNC DC to 3 GHz.

\$29.99



COAXIAL RELAY SWITCHES SPDT

FXR
Part # 300-11182
120Vac Type BNC DC to 4 GHz.
FSN 5985-543-1225

\$39.99

FXR
Part # 300-11173
120Vac Type BNC Same
FSN 5985-543-1850

\$39.99

TERMS: DOMESTIC: Prepaid, C.O.D. or Credit Card
FOREIGN: Prepaid only, U.S. Funds, Money Order, or Cashier's Check Only

C.O.D.: Acceptable by telephone or mail. Payment from customer will be by Cash, Money Order, or Cashier's Check. We are sorry but we cannot accept personal checks for C.O.D.'s. C.O.D.'s are shipped by air only and thru United Parcel Service.

CONFIRMING ORDERS: We would prefer that confirming orders not be sent after a telephone order has been placed. If company policy necessitates a confirming order, please mark "CONFIRMING" boldly on the order. If problems or duplicate shipments occur due to an order which is not properly marked, the customer will be held responsible for any charges incurred, plus a 15% restock charge on the returned parts.

CREDIT CARDS: We are now accepting MASTERCARD, VISA, AND AMERICAN EXPRESS

DATA SHEETS: When we have data sheets in stock on devices we will supply them with the order.

DEFECTIVE MATERIALS: All claims for defective materials must be made within 30 DAYS after receipt of the parcel. All claims must include the defective material (for testing purposes), a copy of our invoice, and a return authorization number which must be obtained prior to shipping the merchandise back to us. This can be obtained by calling (602) 242-8916 or sending us a postcard. Due to Manufacturer warranties we are unable to replace or issue credit on items which have been soldered to or have been altered in any way. All return items must be packed properly or it will void all warranties. We do not assume responsibility for shipping and handling charges incurred.

DELIVERY: Orders are usually shipped the same day they are placed or the next business day, unless we are out of stock on an item. The customer will be notified by post card if we are going to backorder the item. Our normal shipping method is UPS or U.S. Mail depending on size or weight of the package. Test Equipment is shipped only by air and is freight collect, unless prior arrangements have been made and approved.

FOREIGN ORDERS: All foreign orders must be prepaid with a Cashier's Check, or Money Order made out in U.S. FUNDS ONLY. We are sorry but C.O.D. is not available to foreign countries and letters of credit are unacceptable as a form of payment. Further information is available on request.

HOURS: Monday thru Friday 8:30 a.m. to 5:00 p.m. Saturdays 8:30 a.m. to 4:00 p.m.

INSURANCE: Please include 25¢ for each additional \$100.00 over \$100.00, UPS ONLY. All insured packages are shipped thru UPS only. If you wish to have it shipped through the post office there is a \$5.00 fee which is additional to the shipping, handling and insurance.

OPEN ACCOUNTS: We regret that we do not issue open accounts.

ORDER FORMS: New order forms are included with each order for your convenience. Additional order forms are available on request.

PARTS: We reserve the right to substitute or replace any item with a part of equal or comparable specification.

POSTAGE: Minimum shipping and handling in the U.S., Canada, and Mexico is \$3.00 for ground shipments, all other countries is \$5.50. Air rates are available at the time of your order. All foreign orders please include 25% of the ordered amount for shipping and handling. C.O.D.'s are shipped AIR ONLY.

PREPAID ORDERS: Orders must be accompanied by a check.

PRICES: Prices are subject to change without notice.

PURCHASE ORDERS: We accept purchase orders only when they are accompanied by a check.

RESTOCK CHARGES: If parts are returned to MHZ ELECTRONICS, INC. due to customer error, the customer will be held responsible for all fees incurred and will be charged a 15% RESTOCK CHARGE with the remainder in CREDIT ONLY. The following must accompany any return: A copy of our invoice, return authorization number which must be obtained prior to shipping the merchandise back. Returns must be done within 10 DAYS of receipt of parcel. Return authorization numbers can be obtained by calling (602) 242-8916 or notifying us by post card. Return authorizations will not be given out on our 800 number.

SALES TAX: ARIZONA residents must add 6% sales tax, unless a signed ARIZONA resale tax card is currently on file with us. All orders placed by persons outside of ARIZONA, but delivered to persons in ARIZONA are subject to the 6% sales tax.

SHORTAGE OR DAMAGE: All claims for shortages or damages must be made within 5 DAYS of receipt of parcel. Claims must include a copy of our invoice, along with a return authorization number which can be obtained by contacting us at (602) 242-8916 or sending a post card. Authorizations cannot be on our 800 number. All items must be properly packed. If items are not properly packed make sure to contact the carrier so that they can come out and inspect the package before it is returned to us. Customers which do not notify us within this time period will be held responsible for the entire order as we will consider the order complete.

OUR 800 NUMBER IS STRICTLY FOR ORDERS ONLY (800) 528-0180. INFORMATION CALLS ARE TAKEN ON (602) 242-8916 or (602) 242-3037.

MHZ

electronics

3802 North 27th Ave., Phoenix, AZ 85017



For information call: 602-265-0731

Toll Free Number
800-528-0180
(For orders only)

PRICES SUBJECT TO CHANGE WITHOUT NOTICE

flea market



RATES Noncommercial ads 10¢ per word; commercial ads 60¢ per word **both payable in advance.** No cash discounts or agency commissions allowed.

HAMFESTS Sponsored by non-profit organizations receive one free Flea Market ad (subject to our editing) on a space available basis only. Repeat insertions of hamfest ads pay the non-commercial rate.

COPY No special layout or arrangements available. Material should be typewritten or clearly printed (not all capitals) and must include full name and address. We reserve the right to reject unsuitable copy. **Ham Radio** cannot check each advertiser and thus cannot be held responsible for claims made. Liability for correctness of material limited to corrected ad in next available issue.

DEADLINE 15th of second preceding month.

SEND MATERIAL TO: Flea Market, Ham Radio, Greenville, N. H. 03048.

WANTED: Circuit diagram/Gladding Islander — Pearce Simpson. Harvey Gilbert, VP9AN, Box MA124, Somerset, Bermuda. Call collect (809) 29-40112 weekends.

WANTED: SCR 274N/BC — ARC5/R-27 RCVRs only. Complete or parts. Send description, cost. Will pay shipping. W8KSW, Walt Evanyk, 3200 Sherry Drive, Plano, Texas 75074.

LETTERING and text for QSL pasteup and label usage. Stamp brings circular. Labelcraft, PO Box 412, W. Sand Lake, NY 12196.

QSL Announcement: I regret to inform you I have sold the SAMCO Travel-Pak QSL Kit Co. Thank you for your QSL patronage. 73, "SAM" A. Moles, PO Box 412, W. Sand Lake, NY 12196.

ELECTRONIC CMOS keyer kit pcb & parts only \$9.95 plus \$1.50 shipping. WI res. add 5% tax. Send for free information. Bel-Tek, PO Box 125SH, Beloit, WI 53511.

CUSTOM MADE embroidered patches. Any size, shape, colors. Five patch minimum. Free sample, prices and ordering information. Hein Specialties, Inc., Dept. 301, 4202 N. Drake, Chicago, IL 60618.

WANTED: Old Crosley Radio Model 50, 51, 52, & "Pup". K4NBN "No Bad News".

SSB Crystal Filter, 9.0 MHz, 2.4 kHz bandwidth, 6 pole, \$17.50; two for \$30.00. 4CX250B chimneys, \$5.00, three for \$12.00. ICL7117 LED DVM chips, \$9.00; three for \$20.00. Dentron C.A.P. transceiver, 100 watts, solid state, \$275.00. ACPS, \$85.00. GLA1000-C linear, 160-15-10, \$285.00. All items new, postpaid, data. National receiver collection, SASE list. Wanted, automobile radio vibrators, new. W.E. Delage, PO Box 493, Northfield, Ohio 44067. (216) 274-2012.

CUSTOM EMBROIDERED Emblems — Cloisonne' enameled pins, your design, low minimum, excellent quality, free booklet. A.T. Patch Co., Dept. 65, Littleton, NH 03561. (603) 444-3423.

TI 99/4A random, text, keyboard, send, receive code practice programs. Dr. Code "General" sends International Morse code and prints on screen; you choose: speed, tone, which characters to be send, spacing, and more! Dr. Code "Speech" same as "General" with speech; you choose how many characters before speech check. For cassette of both copyrighted programs and conditional copying privileges, send \$10.00 plus \$3.00 shipping and handling to N5ESF, Rt. 1, Box 1326, Lake Charles, LA 70601. Phone (318) 436-2048, no collect calls please. Satisfaction or money back.

SPECTACULAR Savings. ICOM, Kenwood, Yaesu, Panasonic, Regency, Bearcat, MFJ, antennas, coax, CW/RTTY, much more! Free UPS shipping and insurance to 48 states. 25 page picture catalog \$1.00 (refundable). Galaxy Electronics, Box 1202HR, 67 Eber Ave., Akron, Ohio 44309. (216) 376-2402 9-5 PM EST.

RUBBER STAMPS: 3 lines \$4.50 PPD. Send check or MO to G.L. Pierce, 5521 Birkdale Way, San Diego, CA 92117. SASE brings information.

NEW President Grant AM-SSB CB. With power mic \$125.00 plus \$5.00 UPS. MO only. R.D. Carter, Box 418, Vass, NC 28394.

REPAIR, ALIGNMENT, calibration. Collins written estimates \$25; non Collins \$50. K1MAN. (207) 495-2215.

ATLAS 350XL owners group. Send QSL card with s/n your rig. Know anyone who repairs them? Have any technical information to share? Any questions? Rod, N5NM, Box 2169, Santa Fe, NM 87504.

CHASSIS and cabinet kits. SASE K3IWK.

HELP. Need schematic Atronic KB105MP CW keyboard. Company disappeared. Cavett, 8570 Herbert, Pennsauken, NJ 08109.

U.S. and FOREIGN Callbook, Radio Handbook and other ARRL books, 1950 to 1975 edition. Ham Radio, QST, 73, CQ magazines, second-hand for my private collection. Send price list to: Vittorio Bruni, Poste Succ. 8 — 05100 Terni Succ. 8, Italy.

IMRA, International Mission Radio Association, helps missionaries. Equipment loaned. Weekday net, 14.280 MHz, 2-3 PM Eastern. Eight hundred Amateurs in 40 countries. Brother Frey, 1 Pryer Manor Road, Larchmont, NY 10538.

ANTIQUÉ RADIO Classified — The National Publication for Buyers and Sellers of old radios — published monthly. Sample copy \$1.50. A.R.C., 9951-9 Sunrise, Cleveland, Ohio 44133.

WANTED: Old microphones, remote mixers other misc related items. All pre-1935. Box Paquette, 107 E. National Avenue, Milwaukee, WI 53204.

AMATEUR RADIO CLASSES: Sponsored by the Hampden County Radio Association starting February 26, Agawam High School, 7 PM. Novice, Tech, General, Advanced or Extra. There is no charge for the classes. Text books must be purchased but are less than \$10. Classes meet weekly for 10 weeks. For more information or to sign up contact Art Zavarella (413) 786-9115.

VE TEST SESSION: Sponsored by the Hampden County Radio Association, Saturday, May 18, 9 AM, Hampden-Wilbraham Regional High School, 621 Main Street, Wilbraham, Mass. Exams for all license grades will be offered. Send completed FCC Form 610, a copy of current license and check for \$4.00 payable to ARRL-VEC to: Yorke Phillips, K1BXE, 235 Ames Road, Hampden, MA 01036 prior to April 18, 1985.

ELECTRON TUBES: Receiving, transmitting, microwave ... all types available. Large stock. Next day delivery, most cases. Daily Electronics, PO Box 5029, Compton, CA 09224 (213) 774-1255.

RTTY-EXCLUSIVELY for the Amateur Teleprinter. One year \$7.00. Beginners RTTY Handbook \$8.00 includes journal index. P.O. Box RY, Cardiff, CA 92007.

AMATEUR RADIO CLASSES: Sponsored by the 19-79 Amateur Radio Association. Evening classes start March 19 at the Chelsea (Mass) High School. Open to anyone interested

in becoming a ham. Classes are free with a small cost for materials only. For information: 19-79 Amateur Radio Association, PO Box 171, Chelsea, MA 02150 include phone number.

TENNATEST — Antenna noise bridge — out-performs others, accurate, costs less, satisfaction guaranteed, \$41.00. Send stamp for details. W8UUR, 1025 Wildwood Road, Quincy, MI 49082.

DIGITAL AUTOMATIC DISPLAYS. All transceivers. Six 1/2" digits. 5" wide by 1-1/2" by 9" cabinet! Send \$1.00 for information. Grand Systems, POB 2171, Blaine, Washington 98230. Canadians VE7LB.

Coming Events ACTIVITIES "Places to go..."

OHIO: Dayton Hamvention, April 26, 27, 28, Hara Arena and Exhibition Center, Dayton. Admission \$8 advance, \$10 at door. Good for all three days. Banquet \$14 advance, \$16 at door. Flea market space \$17 in advance for all three days. Technical, ARRL and FCC forums. New products and exhibits. Special group meetings. YL forum. International VHF/UHF conference. Amateur of the Year Award. Special achievement awards. Pre-registration starts January 1, 1985. For further information; Dayton Amateur Radio Association, Box 44, Dayton, OH 45401 or phone (513) 433-7720.

OHIO: The 16th annual B*A*S*H will be held on the Friday night of the Dayton Hamvention, April 26 at the Convention Center, Main and Fifth Streets. Parking in adjacent city garage. Admission free to all. Sandwiches, snacks and COD bar available. Live entertainment. Two exciting awards and many others. For further information contact the Miami Valley FM Association, PO Box 263, Dayton, Ohio 45401.

ARIZONA: The Cochise Amateur Radio Association (CARA) invites you to the inauguration of the CARA Training Facility and Range, a 40 acre complex in Cochise County, 5 miles east of Sierra Vista on Mason Road. The dedication will be our annual Hamfest, May 4 and 5. A flea market is planned and all tailgaters are welcome. For information: The Cochise ARA, PO Box 1855, Sierra Vista, AZ 85636. Att: KB7HB.

WISCONSIN: The Madison Area Repeater Association (MARA) announces its 13th annual Madison Swapfest, Sunday, April 21, Dane County Exposition Center Forum Building in Madison. Doors open for commercial exhibitors and flea market sellers at 8 AM. General admission 9 AM. Everything for hams, computer hobbyists and experimenters. All-you-can-eat pancake breakfast and Bar-B-Q lunch will be available. Admission \$2.50/advance; \$3.00/door. Children 12 and under admitted free. Flea market tables \$4.00 each/advance; \$5.00/door. Reserve early. Talk in on WB9AER/R, 146 161/76. For reservations or information: M.A.R.A., PO Box 3403, Madison WI 53704.

CALIFORNIA: The 43rd annual Fresno Hamfest, May 3, 4 and 5, Tropicana Lodge of Fresno, 1406 N. Blackstone. Program includes tech talks, swap tables and flea market, transmitter hunts, CW contest, ARRL forum, commercial exhibits, eyeball QSO's, buffet dinner and more. Registration \$24.00 before April 19, 1985. \$26.00 after that date. For information: Jane Price, WA6HSW, 2353 W. Simpson, Fresno, CA 93705.

ILLINOIS: The Kishwaukee Amateur Radio Club's annual Hamfest, May 5, DeKalb County Fairgrounds, Suydam Road, Sandwich. Donation \$2.00 advance; \$3.00 gate. Inside tables \$5.00 each. Free parking. Outside areas for tailgaters. Overnight camping, no hookups. Coffee and donuts available for early birds. Food wagon thereafter. Talk in on 94, 13-73. For tickets write: K.A.R.C., Box 334, Sycamore, IL 60178. Our 30th Year!

COLORADO: The Grand Mesa Repeater Society's 6th annual Western Slope Amateur Radio and Computer Swapfest, Saturday, April 20, 10 AM to 4 PM. Location TBA in Grand Junction. Free admission. Swap tables \$5.00 each. Indoor Swapfest. Amateur Radio exams, auction and refreshments. Talk in on 146.82 and 449.200. For tables or information: SASE to Larry Brooks, WBØECV, 3185 Bunting Avenue, Grand Junction, CO 81504 or call (303) 434-5603.

SOUTH CAROLINA: The Blue Ridge Amateur Radio Society is sponsoring the 46th annual Hamfest and Electronic Flea Market, American Legion Fairgrounds in Greenville. Saturday, May 4 8 AM to 5 PM. Sunday, May 5 8 AM to 3 PM. Admission \$3.00 advance and \$4.00 at gate. VEC walk in exams, Wouff Hong ceremony, ARRL State Convention, Saturday night banquet, ARES, CQWA, indoor dealer displays, indoor/outdoor flea market, food, beverages, snacks and camping. Early dealer/flea market setup with advance registration. For advance tickets and VEC exam info; Sue Chism, N4ENX, PO

Foreign Subscription Agents for Ham Radio Magazine

Ham Radio Austria
Karin Lieber
Postfach 2454
D-7850 Loerrach
West Germany

Ham Radio Belgium
Stereohouse
Brusselssteenweg 116
B-9216 Gant
Belgium

Ham Radio Holland
Postbus 413
NL-7800 Ar Emmen
Holland

Ham Radio Europe
Box 2084
S-194 02 Upplands Vasby
Sweden

Ham Radio France
SM Electronic
20 bis, Ave des Clairons
F-89000 Auxerre
France

Ham Radio Germany
Karin Lieber
Postfach 2454
D-7850 Loerrach
West Germany

Canada
Send orders to
Ham Radio Magazine
Greenville, NH 03048 USA
Prices in Canadian funds
1 yr \$29.95, 2 yrs \$53.90
3 yrs \$75.40

Ham Radio Italy
Via Pordenone 17
I-20132 Milano
Italy

Ham Radio Switzerland
Karin Lieber
Postfach 2454
D-7850 Loerrach
West Germany

Ham Radio England
c/o R.S.G.B.
Alma House
Cambridge Road
Potters Bar
Herts EN6 3JW
England

Holland Radio
143 Greenway
Greenside, Johannesburg
Republic of South Africa

Box 6751, Greenville, SC 29606. For additional information: Nancy Rice, WD4ADK, 1401 W. Parker Rd., Greenville, SC 29611.

OKLAHOMA: The Great Plains ARC will sponsor its 4th annual N.W. Oklahoma Eyeball & Swapmeet, Sunday, April 14, starting 9 AM in Mooreland. Admission \$2.00. Dealer and swap tables available at no charge. VE tests given. Campsites available. Local airport. Covered dish dinner at noon. For further information: Gordon Richmond, NR5L, Rt. 1, Box 12, Mooreland, OK 73852 or Gerald Bowman, Box 356, Mooreland, OK 73852 or call (405) 994-5394. (405) 994-5453.

NORTH CAROLINA: The Raleigh Amateur Radio Society's 13th annual Hamfest, Sunday, April 14, 8 AM to 4 PM. NEW LOCATION Jim Graham Building, NC State Fairgrounds, Hillsborough Street, Raleigh. Pre-registration \$3.50. \$5.00 at the door. One flea market space, table, two chairs \$5.00 (ours only please). Vendor setup Saturday 4-10 PM, Sunday 6-8 AM. Hamfest social Saturday night. Special interest meetings. Amateur FCC exams. Send Form 610 with copy of current license and check or MO for \$4.00 to: W.C.A.R.S./V.E.C., Mr. John Johnson, WM4P, 2118 Lyndhurst Drive, Raleigh, NC 27610. CW and homebrew contests. Talk in on W4DW (146.04/146.64) and K4ITL (146.28/146.88). For further information: RARS Hamfest, PO Box 17124, Raleigh, NC 27619.

MICHIGAN: 1985 Blossomland Blast, Sunday, October 6, 1985. Write "Blast", PO Box 175, St. Joseph, MI 49085.

INDIANA: The Putnam County Amateur Radio Club's third Auction and Flea Market, April 6, Putnam County Fairgrounds, north of Greencastle on US 231. Doors open for setup at 0600. Flea Market 0800. Flea market tables \$2.00 each. Admission \$3.00. Children under 12 free. Auction starts 1300. Food and beverages available. Commercial exhibitors welcome. For information SASE to John S. Underwood, K9IB, RFD 1, Box 10, Fillmore, IN 46128 or call (317) 246-6335.

NEW YORK: Indoor/outdoor Flea Market sponsored by the Suffolk County Radio Club, Sunday, May 5, 8 AM to 3 PM, Republic Lodge No. 1987, 585 Broadhollow Road (Rt. 110), Melville. Refreshments available. Free parking. Admission \$2.00. (Spouse and kids free). Indoor tables \$7.00, outdoor space \$5.00, includes one admission. Talk in on 144.61/145.21 and 146.52. For information: Richard Tygar, AC2P, (516) 643-5956 evenings.

MISSOURI: The PHD Amateur Radio Association is sponsoring the State ARRL Convention, Saturday and Sunday, April 13 and 14, Trade Mart Building II, Kansas City Downtown Airport. Doors open 9:30-5:30 both days. Admission seating 7-9 PM Friday, 7-9 AM Saturday. Saturday evening banquet. Special guest: Dale Clift, WA3NLO, ARRL General Manager. Forums include ARRL computer, FCC, VE, DX, PR, CW contest, homebrew contest and much more. Exams by PHDVEC Friday 5 to 7 PM, Saturday and Sunday, 8 AM. Send application with \$1.00 and SASE to PHDVEC, PO Box 11, Liberty, MO 64068-0011 by April 8, 1985. Registration \$4.00 for both days. Banquet \$10.50. Swap tables \$10.00 for both days, includes one registration per table. Free parking. RV's welcome but no hookups. Talk in on 146.34/94. Send registrations to: PHD ARA, PO Box 11, Liberty, MO 64068-0011. Phone (816) 781-7313 or 452-9321.

ARKANSAS: The Northwest Arkansas ARC will hold its 5th annual Hamfest/Swapfest, Saturday, May 4, Rogers Youth Center, 315 West Olive, Rogers. 8 AM to 4 PM. Setup 7 AM. Commercial/flea market tables \$2.00. Admission free. Walk in FCC exams given 10 AM and 1:30 PM. Talk in on 167/6 and 52 simplex. For information SASE to: Ray Watson, N5HAP, 714 Maple Drive, Springdale, AR 72765 or Dave Perry, KE5QZ, 3201 N. 13th, Rogers, AR 72756.

CALIFORNIA: The 13th annual Sacramento Valley Amateur Radio Hamswap, Sunday, May 5, Placer County Fairgrounds, Roseville. 9 AM to 3 PM. Talk in on 145.190 and 224.78, K6IS repeaters. Free parking. For advance tables, tickets, information: Carl Schultz, KA6KWB, 2942 Gwendolyn Way, Rancho Cordova, CA 95670. (916) 336-9111.

MASSACHUSETTS: The Hampden County Radio Association Flea Market, Sunday, May 5, rain or shine, West Springfield Lodge of Elks, Morgan Road, West Springfield. 9 AM to 3 PM. Admission \$1.00 per person. Tables \$3.00 each. Dealers \$3.00 per vehicle display. Food/refreshments available. Talk in on 147.105 up 600. For information: Paul Kress, WA1ZKT (413) 568-8291 or Steve Nelson, WA1EYF (413) 596-8216.

NEVADA: The Ziegfeld Showroom of the MGM Grand Hotel will host the first 1985 earth station industry Banquet, held in conjunction with the SPACE/STTI Las Vegas show, Monday evening, April 1 at 6 PM. Festivities include dinner, special guest speakers and presentations. All topped off with Jubilee, the MGM's musical extravaganza. Tickets \$50.00 per person. Call SPACE (703) 549-8900. Credit cards accepted or mail check to 709 Pendleton Street, Alexandria, VA 22314 before March 15. Banquet tickets are not refundable.

OHIO: The Medina Two Meter Group is sponsoring a Hamfest, May 12, Medina County Community Center Building, Lafayette Rd., State Rt. 42 SW. 8 AM to 2 PM. Setup 7 AM. Refreshments and free parking. Tickets \$3.00 advance, \$3.50 at door. Tables \$6.00. Flea market space \$2.00. Talk in on 147.63/03, K8TVR. For table reservations and tickets: PO Box 452, Medina, Ohio 44258 or (216) 725-5021.

LOUISIANA: BRARC Hamfest, May 11 and 12, Baton Rouge. Free admission. VE exams Saturday and Sunday, 30 day advance registration only. Send SASE, 610 and check for \$4.00 to ARRL/VEC, George Perry, W5LVX, 17424 Lady Constance, Greenwell Springs, LA 70739. For further information SASE to Rick Pourciau, N5HHF, 879 Castle Kirk, Baton Rouge, LA 70808.

GEORGIA: The Athens Amateur Radio Club (formerly the N.E. Georgia ARC) will sponsor a Hamfest, April 21, 8:30 AM to 3:30 PM, Athens Vocational-Technical School, Highway 29, Athens. Registration is free. Talk in on 147.285. For information: Norman Archibald, KB4IIA, PO Box 225, Athens, GA 30603.

NEW MEXICO: The UNM and Westside ARC's are co-sponsoring a tailgate swapfest, April 20, 10 AM to 2 PM MST, UNM North Campus parking lot, Tucker Avenue and University Blvd., Albuquerque. There is no charge but bring your own tables. Talk in on 147.75/147.15 and 449.3/444.3 repeaters. For information SASE to Robert A. Scupp, WB5YYX, 648 Marquis Drive NE, Albuquerque, NM 87123. (505) 296-6546.

CALIFORNIA: Flea Market and FCC examinations. April 13, May 11, June 8, July 13, August 10 and September 14. Novice thru Extra exams given. Information call (408) 255-9000. Foothill College, Los Altos, CA. 73 Gordon, W6NLG VEC.

ILLINOIS: The Moultrie Amateur Radio Klub (MARK) Hamfest, Sunday, May 5, 8 AM to 3 PM, Moultrie County 4-H Center Fairgrounds, Cadwell Rd., 5 miles east of Sullivan. Heated indoor/large covered outdoor Flea Market. No charge to vendors. Vendors setup Saturday. No overnight hookups. Talk in on 655/055 and 52. For information: MARK, PO Box 79, Sullivan, IL 61951 or call Vernon Jack, K9SWY (217) 728-7596.

NEW HAMPSHIRE: Springfest '85, the 5th annual Flea Market/Hamfest, sponsored by the Great Bay Radio Association. Saturday, April 20, 9 AM to 3 PM, Somersworth Armory, Blackwater Road, Somersworth. Admission \$1.00. Tables \$8.00 includes one admission. Free parking. Food and refreshments available. Talk in on 146.40/147.00. For information/table reservations: Great Bay Radio Association, PO Box 911, Dover, NH 03820.

ILLINOIS: The Centralia Wireless Association's annual Hamfest, Sunday, May, Kaskaskia College Gymnasium, 3 miles NW of Centralia. Doors open 7 AM to setups. No charge for flea market and exhibit space. Some tables available. Admission to Hamfest is free. Food and refreshments available. Exams for all license classes except Novice will be given at 9 AM. Send completed Form 610, copy of current license and check for \$4.00 payable to ARRL/VEC to Lou Hodges, W9IL, Route 1, Box 62A, Centralia, IL 62801 by April 5, 1985. For further information: David Conder, KA9QPC (618) 532-2772 or Lou Hodges, W9IL (618) 533-4724.

MASSACHUSETTS: The Framingham Amateur Radio Association's Annual Spring Flea Market, Sunday, April 14, Framingham Civic League Bldg., 214 Concord St. (Rt. 126) downtown Framingham. Doors open 10 AM. Sellers setup begins 8:30. Admission \$2.00. Tables \$10.00 includes one free admission. Pre-registration required. Bargains galore! Contact Jon Weir, K1VVC, 52 Overlook Drive, Framingham, MA 01701. (617) 877-7166.

MASSACHUSETTS: The Montachusett Amateur Radio Association's Flea Market, Saturday, April 27, Knights of Columbus Hall, Electric Avenue, Fitchburg. Doors open 9 AM to 3 PM. Dealer setup 8 AM. Admission \$1.00. Tables \$8.00 each. Refreshments available. Free parking. Talk in on 144.85/145.45 and 146.52 simplex. For tables send check payable to M.A.R.A., Jim Beauregard, KB1AY, 7 Mountain Avenue, Fitchburg, MA 01424.

MINNESOTA: The Arrowhead Radio Amateur Club announces "Swapfest '85", Saturday, May 11, Holiday Inn, 207 West Superior Street, downtown Duluth. Doors open 8 AM for vendors. General admission 10 AM. Admission \$4.00. 4' tables \$5.00. Plenty of food. Free parking. Talk in on 146.34/94 repeater. For information: Bill Cossette, N0BKL, 15 Manitou Street, Duluth, MN 55808.

MINNESOTA: The Rochester Amateur Radio Club's 8th annual Hamfest, Saturday, April 20, John Adams Junior High School, 1525 NW 31st Street, Rochester. Doors open 8:30 AM. Large indoor flea market for radio and electronics items, refreshments and plenty of free parking. Talk in on 146.22/82. For further information: RARC, c/o WB0YEE, 2253 Nordic Ct., NW, Rochester, MN 55901.

OPERATING EVENTS

"Things to do..."

APRIL 13: Connecticut QSO Party sponsored by the Candlewood ARA, 1100Z 13 Apr to 1100Z 14 Apr, rest period 0500 to 1000Z. Send signal report, QSO number, ARRL section or Ct. County for stations worked inside CT. Club station W1QI counts 5 points per band/mode. Mail by 5 May 1985 (SASE for results) to CARA c/o R. Dillon, N2EFA, Box 143, Bethel, CT 06801.

MAY 18: ARMED FORCES DAY. The annual Armed Forces Day Communication Test. CW, SSB, RTTY and SSTV. Cross band contacts — military to Amateur cross band operations 18/1300 UTC to 19/0245 UTC May 1985. Military stations participating in cross band operations: Air, NMH, NPL, NAM, NMN, NZJ, NAV, NPG, WAR. Military stations will transmit on select frequencies and announce the specific Amateur band frequency being monitored. The CW and RTTY broadcasts will be a special Armed Forces Day message from the Secretary of Defense. Transcriptions of CW and/or RTTY receiving tests should be submitted "as received". Time, frequency and call sign of military station copied and name, call sign and address of individual submitting entry must be indicated. Entries must be postmarked no later than 25 May 1985. Send to following military commands: AIR — AFD Test, 2045CG/DONJW, Andrews AFB, DC 20331-5000. NAM, NAV, NPG — AFD Test, 4401 Massachusetts Ave., Washington, DC 20390-5290. WAR-AFD Test, Commander, USAISAC, Att: AS-OPS-CM, Ft. Huachuca, AZ 85613-5000.

APRIL 10, 11, 17, 18: All licensed women operators throughout the world are invited to participate in the DX-YL North American YL contest. DX YLs call "CQ North American YL" and NA YLs call "CQ DX YL". All bands may be used. Stations may be worked and counted once on each band and mode. Exchange station worked, QSO number, RS(T) state or country. For more information: Marty Silver, NY4H, 3118 Eton Road, Raleigh, NC 27608.

MAY 1, 2: Indiana Month of May Contest: Be the first to work 500 Indiana contacts. Exchange RST, state, province, or country, name and county (Indiana stations). Send copy of log, dup sheet and score sheet by June 30, 1985 to Russ Ryle, N9DHX, Southern Indiana QRP Group, PO Box 2466, Bloomington, IN 47402.

APRIL 30: Amateur Radio operators will have a rare opportunity to work an English Renaissance sailing ship when the Godspeed sails on a 10 week voyage from London, England to Jamestown, Virginia. The original Godspeed was one of three square-rigged vessels which brought the first permanent English settlers to the New World in the winter of 1606-7. Rigging the ship's radio systems has been coordinated by Neil Tanner, WA4CHQ. The Captain of the Godspeed is George Salley, KA4FVB. Special QSL cards have been designed. For more information contact Jamestown/Yorktown Fdn., PO Drawer JF, Williamsburg, VA 23187.

APRIL 20: Spring SSB Contest, 1200 UTC Saturday, to 2400 UTC Sunday. May operate a maximum of 24 hours. Exchanges: Members give RS, state/province/country and QRP ARCI membership number. Non-members give RS, state/province/country and power output. Stations may be worked once per band. Separate log sheets for each band must be received by May 21, 1985. Send logs to QRP ARCI Contest Chairman Eugene Smith, KA5NLY, PO Box 55010, Little Rock, AR 72225.

DRAKE R-4/T-4X OWNERS AVOID OBSOLESCENCE

PLUG-IN SOLID STATE TUBES!

Get state-of-the-art performance.
Most types available

INSTALL KITS TO UPGRADE PERFORMANCE!

- BASIC Improvement
- Audio Bandpass Filter
- Audio IC Amplifier

TUBES \$23 PPD KITS \$25 PPD

OVERSEAS AIR \$7

SARTORI ASSOCIATES, W5DA
BOX 832085
RICHARDSON, TX 75083
214-494-3093

✓ 178

HAM MART

Ham Radio's guide to help you find your local

California

C & A ROBERTS, INC.
18511 HAWTHORN BLVD.
TORRANCE, CA 90504
213-370-7451
24 Hour: 800-421-2258
Not The Biggest, But The Best —
Since 1962.

FONTANA ELECTRONICS
8628 SIERRA AVENUE
FONTANA, CA 92335
714-822-7710
714-822-7725

The Largest Electronics Dealer in San Bernardino County.

JUN'S ELECTRONICS
3919 SEPULVEDA BLVD.
CULVER CITY, CA 90230
213-390-8003
800-882-1343 Trades
Habla Espanol

Connecticut

HATRY ELECTRONICS
500 LEDYARD ST. (SOUTH)
HARTFORD, CT 06114
203-527-1881
Call today. Friendly one-stop shopping
at prices you can afford.

Delaware

**AMATEUR & ADVANCED
COMMUNICATIONS**
3208 CONCORD PIKE
WILMINGTON, DE 19803
(302) 478-2757
Delaware's Friendliest Ham Store.

DELAWARE AMATEUR SUPPLY
71 MEADOW ROAD
NEW CASTLE, DE 19720
302-328-7728
800-441-7008
Icom, Ten-Tec, Microlog, Yaesu,
Kenwood, Santec, KDK, and more.
One milé off I-95, no sales tax.

Florida

AMATEUR ELECTRONIC SUPPLY
1898 DREW STREET
CLEARWATER, FL 33575
813-461-4267
Clearwater Branch
West Coast's only full service
Amateur Radio Store.
Hours M-F 9-5:30, Sat. 9-3

AMATEUR ELECTRONIC SUPPLY
621 COMMONWEALTH AVE.
ORLANDO, FL 32803
305-894-3238
Fla. Wats: 1 (800) 432-9424
Outside Fla: 1 (800) 327-1917
Hours M-F 9-5:30, Sat. 9-3

AMATEUR RADIO CENTER, INC.
2805 N. E. 2ND AVENUE
MIAMI, FL 33137
305-573-8383
The place for great dependable
names in Ham Radio.

Hawaii

HONOLULU ELECTRONICS
819 KEEAUMOKU STREET
HONOLULU, HI 96814
(808) 949-5564
Serving Hawaii & Pacific area for 51
years. Complete lines of Amateur equip-
ment, accessories and parts.

Illinois

ERICKSON COMMUNICATIONS, INC.
5456 N. MILWAUKEE AVE.
CHICAGO, IL 60630
312-631-5181
Hours: 9:30-5:30 Mon, Tu, Wed & Fri;
9:30-8:00 Thurs; 9:00-3:00 Sat.

Indiana

THE HAM STATION
808 NORTH MAIN STREET
EVANSVILLE, IN 47710
812-422-0231
Discount prices on Ten-Tec, Cubic,
Hy-Gain, MFJ, Azden, Kantronics,
Santec and others.

Massachusetts

James Millen Components by
ANTENNAS ETC.
16 HANSOM ROAD
ANDOVER, MA 01810
617-475-7831
Bezels, binding posts, capacitors, con-
densers, chokes, coils, ceramics, H.V.
connectors, plate caps, hardware
knobs, dials, scopes and grid dippers.
Inquire SASE or visit.

TEL-COM, INC.
675 GREAT ROAD, RTE. 119
LITTLETON, MA 01460
617-486-3400
617-486-3040
The Ham Store of New England
You Can Rely On.

Michigan

ENCON PHOTOVOLTAICS
Complete Photovoltaic Systems
27600 Schoolcraft Rd.
Livonia, Michigan 48150
313-523-1850
Amateur Radio, Repeaters, Satellite,
Computer applications.
Call Paul WD8AHO

Nevada

AMATEUR ELECTRONIC SUPPLY
1072 N. RANCHO DRIVE
LAS VEGAS, NV 89106
702-647-3114
Dale Porray "Squeak," AD7K
Outside Nev: 1 (800) 634-6227
Hours M-F 9-5:30, Sat. 9-3

JUN'S ELECTRONICS
460 E. PLUMB LANE — 107
RENO, NV 89502
702-827-5732
Outside Nev: 1 (800) 648-3962
Icom — Yaesu Dealer

NEW YORK

ADIRONDACK ELECTRONICS, INC.
1991 CENTRAL AVENUE
ALBANY, NY 12205
518-456-0203
Amateur Radio for the Northeast since
1943.

BARRY ELECTRONICS
512 BROADWAY
NEW YORK, NY 10012
212-925-7000
New York City's Largest Full Service
Ham and Commercial Radio Store.

VHF COMMUNICATIONS
915 NORTH MAIN STREET
JAMESTOWN, NY 14701
716-664-6345
Call after 7 PM and save! Supplying all
of your Amateur needs. Featuring ICOM
"The World System." Western New
York's finest Amateur dealer.

Dealers: YOU SHOULD BE HERE TOO!
Contact Ham Radio now for complete details.

Amateur Radio Dealer

Ohio

AMATEUR ELECTRONIC SUPPLY
28940 EUCLID AVE.
WICKLIFFE, OH (CLEVELAND AREA)
44092

216-585-7388
Ohio Wats: 1 (800) 362-0290
Outside Ohio: 1 (800) 321-3594
Hours M-F 9-5:30, Sat. 9-3

UNIVERSAL AMATEUR RADIO, INC.
1280 AIDA DRIVE
REYNOLDSBURG (COLUMBUS), OH
43068

614-866-4267
Featuring Kenwood, Yaesu, Icom,
and other fine gear. Factory author-
ized sales and service. Shortwave
specialists. Near I-270 and airport.

Pennsylvania

HAMTRONICS,
DIV. OF TREVOSE ELECTRONICS
4033 BROWNSVILLE ROAD
TREVOSE, PA 19047
215-357-1400
Same Location for 30 Years.

LaRUE ELECTRONICS
1112 GRANDVIEW STREET
SCRANTON, PENNSYLVANIA 18509
717-343-2124
Icom, Bird, Cushcraft, Beckman,
Larsen, Hustler, Astron, Belden,
Antenna Specialists, W2AU/W2VS,
AEA, B&W, Amphenol, Saxton, J.W.
Miller/Daiwa, Vibroplex.

THE VHF SHOP
BOX 349 RD 4
MOUNTAINTOP, PA 18707
717-868-6565
Lunar, Microwave Modules, ARCOS,
Astron, KLM, Tama, Tonna-F9FT,
UHF Units/Parabolic, Santec, Tokyo
Hy-Power, Dentron, Mirage,
Amphenol, Belden

Texas

MADISON ELECTRONICS SUPPLY
1508 MCKINNEY
HOUSTON, TX 77010
713-658-0268
Christmas?? Now??

Wisconsin

AMATEUR ELECTRONIC SUPPLY
4828 W. FOND DU LAC AVE.
MILWAUKEE, WI 53216
414-442-4200
Wisc. Wats: 1 (800) 242-5195
Outside Wisc: 1 (800) 558-0411
M-F 9-5:30
Sat 9-3

⊖-777 THE MOST ADVANCED COMPUTER INTERFACE EVER DESIGNED FOR COMMERCIAL AND AMATEUR USE.

RTTY, BIT INVERSION (RTTY), ASCII, AMTOR (MODE A (ARQ), MODE B (FEC AND
SEL-FEC), MODE L), CW, ANY SPEED ANY SHIFT (ASCII AND BAUDOT)*

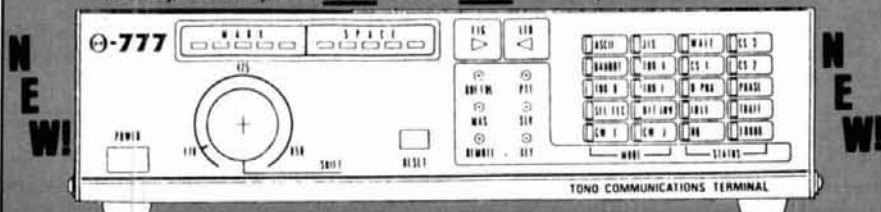

- **AUTO DECODING:** Automatically decodes signal and displays mode, speed and polarity on the CRT.
- **28 BAR-LED'S** and **LED'S** plus a Bar-Graph Tuning Indicator indicate function, mode, and status.
- The awesome power of the ⊖-777 is limited only by the imagination of the user and the terminal program of the computer.
- Use with **Any** computer that has RS232 or TTL I/O, IBM, Apple, Commodore, TRS80, etc.

Everything Built In - Including Software - Nothing Else To Buy!

- **SPEEDS:** CW 5-100 WPM (AUTOTRACK), 12-200 BAUD (ASCII AND BAUDOT), 12-600 BAUD TTL, AND RS232 OR TTL LEVEL DATA CONNECTION - 100-2400 BAUD (ASCII) OR 45-5-200 BAUD (BAUDOT) • SELCAL • MEMORY: 15 CHANNELS • 768 CHARACTER INPUT BUFFER • AUTO PTT • CW ID • DIDDLE • ECHO • AUTO CR/LF • RUB-OUT • CW PRACTICE GENERATOR • VARIABLE CW WEIGHTS • TEST MESSAGE (RY AND QBF) • FULL CRT FUNCTION DISPLAY • MARK - AND - BREAK (SPACE - AND - BREAK) SYSTEM • XTAL AFSK • AUDIO MONITOR • POWER SUPPLY REQUIREMENTS: 13.8 V DC, 700MA • SIZE 9W x 10D x 21H

AMATEUR-WHOLESALE ELECTRONICS TOLL FREE 800-327-3102
8817 S.W. 129th Terrace Miami, Florida 33176 Telephone (305) 233-3631 Telex 80-3356



✓ 146

HAM-TAGS \$1295 pr.
Amateur Radio standard for mobiles!
Your call on each vehicle. Call at top or bottom of frame, and frame front plate. No-nonsense, full refund, guarantee. \$1.50 shipping (First Class Mail).
BMC 1716 Woodland, Houston, TX 77019 (713) 522-5755

Custom Mailing Lists on Labels! Amateur Radio Operator NAMES

- Custom lists compiled to your specifications
- Geographic by ZIP and/or State
 - By License Issue or Expiration Date
- Self stick 1x3 labels

Total List 453,000 Price: \$25/Thousand
Buckmaster Publishing ✓ 180

Whitehall
Mineral, VA 23117 U.S.A. (703) 894-5777

WARNING SAVE YOUR LIFE OR AN INJURY

Base plates, flat roof mounts, hinged bases, hinged sections, etc., are not intended to support the weight of a single man. Accidents have occurred because individuals assume situations are safe when they are not.

Installation and dismantling of towers is dangerous and temporary guys of sufficient strength and size should be used at all times when individuals are climbing towers during all types of installations or dismantlings. Temporary guys should be used on the first 10' or tower during erection or dismantling. Dismantling can even be more dangerous since the condition of the tower, guys, anchors, and/or roof in many cases is unknown.

The dismantling of some towers should be done with the use of a crane in order to minimize the possibility of member, guy wire, anchor, or base failures. Used towers in many cases are not as inexpensive as you may think if you are injured or killed.

Get professional, experienced help and read your Rohn catalog or other tower manufacturers' catalogs before erecting or dismantling any tower. A consultation with your local, professional tower erector would be very inexpensive insurance.

Paid for
By the
Following:

ROHN®
P.O. Box 2000
Peoria, IL 61656



antenna bridge

The new MFJ-204 Antenna Bridge lets you trim your antenna quickly and easily for its best performance.

The antenna bridge will give an accurate reading of your antenna resistance up to 500 ohms and will cover all the ham bands up to 30 MHz. When used to measure the resonant frequency of your antenna, it allows checking to see if the resonant frequency is higher or lower than desired. You can then lengthen or shorten your antenna based on the information gathered.



Priced at \$79.95, plus \$4.00 shipping, the MFJ-204 Antenna Bridge has a frequency counter jack for precise frequency measurement and can also be used as a signal generator. Housed in a sturdy black aluminum cabinet, the unit is very compact (4 x 2 x 2 inches) and operates on a single 9-volt battery or 110 VAC using MFJ's AC adapter (MFJ-1312, \$9.95).

For further information, contact MFJ Enterprises, Inc., P.O. Box 494, Mississippi State, Mississippi 39762.

Circle #312 on Reader Service Card.

low/medium power coax attenuators

A series of 33 broadband, high-performance attenuators with six continuous-power ratings from 2 to 75 watts is now available from Bird Electronic Corporation. The 8300 series of 50-ohm fixed attenuators covers a frequency range from DC-4 GHz with a VSWR below 1.25,

except for the 75-watt and the 2-watt units, which cover DC-2GHz. Models 8308 (75 watts), 8306 (25 watts), 8305 (15 watts), 8304 (10 watts), and 8303 (5 watts) are rated at a peak power of 3 kW with pulses to 5 microseconds wide, are available with attenuation levels of 3, 6, 10, 20, or 30 dB and have male N input/female N output connectors.



The 8300 series attenuators can be used in tandem for odd dB values, or in connection with Bird's TENULINE® high power attenuator (to 4000 watts) for additional attenuation.

For details, contact Bird Electronic Corporation, 30303 Aurora Road, Cleveland (Solon), Ohio 44139.

Circle #313 on Reader Service Card.

low noise amplifier

The R.L. Drake Company has announced the introduction of a new low-noise amplifier for consumer satellite television and other applications. The new Model 2574 provides a noise temperature better than 100 degrees Kelvin and utilizes a 15-volt DC power supply with an output of 3.7 to 4.2 GHz.

The price of the Model 2574 LNA is \$195.00 (retail).

For further information, contact R.L. Drake, 540 Richard Street, Miamisburg, Ohio 45342.

STV filtering

Phantom Engineering, Inc. has introduced an improved version of their popular variable bandwidth filter, the IFP-1. The new IFP-1X replaces the IFP-1. It still features the fingertip IF bandwidth selection and IF gain control. The 70-MHz filter allows the bandwidth on the user's receiver to be progressively narrowed with the IFP-1X's four-position signal selector which, in cases of small dishes and/or terrestrial interference, has shown remarkable results.

The improvement comes from the ability of the IFP-1X to pass all control signals below 10 MHz that are used on quartz synthesized type receivers. Another improvement is the addition of the power supply with each unit at no additional cost.

For more information, contact Phantom Engineering, Inc., 16840 Joleen Way, Bldg. E, Morgan Hill, California 95037.

Circle #304 on Reader Service Card.

STV receiver

Luxor North America Corp.'s new Mark 2 remote-control STV receiver is a single integrated satellite component. With a built-in stereo processor and Dolby noise reduction, its advanced "block conversion" technology allows several TV sets in home, building, or neighborhood to share one STV antenna while enjoying independent channel selection.

Designed for use with regular, component TV, VCR, home or studio stereo, signal descrambler, dish positioning systems, and other audio-video equipment, Mark 2 is easily preprogrammed and



operated by the infrared hand-held Remote Commander. An optional Remote Infrared Sensor allows use of the Commander in a room different from the receiver. An antenna positioning system can be remote-controlled. Digital channel and LED tuning indicators, and a signal strength meter, monitor receiver performance.

For details, contact Luxor North America Corp., P.O. Box 32, Bellevue, Washington 98009-0032.

Circle #315 on Reader Service Card.

tuning indicator kit

Heath Company has expanded its Amateur Radio line to include the HD-3006 Crossfire Tuning Indicator for quick and easy tuning of RTTY transmissions. Sixteen LEDs make up the HD-3006's visual display: eight vertical LEDs identify mark signal strength; eight horizontal LEDs indicate space signal strength. Tuning the HD-3006 for maximum vertical and horizontal display provides a strong signal for computers or RTTY printers. Each LED bar requires approximately 14 dB no-signal to signal voltage ratio for full operation. Minimum input signal is 0.3 VAC RMS or 0.5 VDC. Maximum signal is 15 VAC RMS or 15 VDC.

The HD-3006 Crossfire Tuning Indicator has a wide voltage range and is compatible with almost any interface/terminal unit that has oscilloscope outputs for tuning. The AC/DC cube-type power supply is included in the kit.

For information and a free catalog, contact Heath Company, Dept. 150-435, Benton Harbor,

Michigan 49022. In Canada, write Heath Company, 1020 Islington Avenue, Dept. 3100, Toronto, Ontario, M8Z 5Z3.

Circle #314 on Reader Service Card.

FCC/VE test guides

Test guides for every Amateur Radio class of license are now available from Gordon West's Radio School.



The test guides list all 500 test questions plus the multiple-choice answers in an attractive 8-1/2 x 11 inch manual. The questions, the distractors (wrong answers) and the right answers are listed exactly as they will be found on ARRI or W5YI volunteer examinations. The General and Advanced class test guides list 500 questions; the Extra class test guide, 400; and the Novice class test guide, 100.

Each test guide also includes study notes listing reference material from which the questions were derived and sources of further information about the answers. Formulas for solving the problems are also incorporated into each test guide.

Also included are several pages of instructions to the applicant on locating a Volunteer Exam Coordinator and how to sign up for a local volunteer-administered examination. Also included are the necessary test forms that applicants must fill out ahead of time, including the new FCC Form 610 (revised).

All test guides have been updated to reflect recent rewordings of FCC test questions. This will allow students to spot any format change in any of the FCC-approved questions.

Study guides are priced at \$19.95 plus \$3.00 postage. (Be sure to specify the license class you want.) Exclusive stereo Radio School 4-set cassette theory tapes are also available at \$39.95; each set of four theory tapes includes Amateur Radio "sounds" that help illustrate specific questions on the examinations. (Be sure to specify the license class covered by the theory course you are requesting.)

For more information on study guides, code and theory training tapes, and a colorful catalog on instructional materials for volunteers who give the Amateur Radio exams, contact Gordon West, RADIO SCHOOL, 2414 College Drive, Costa Mesa, California 92626.

Circle #302 on Reader Service Card.

ASK ANY HAM... THEN ASK FOR HUSTLER.

AMATEUR ANTENNA PRODUCTS

STILL THE STANDARD OF PERFORMANCE

HUSTLER

3275 North Avenue B
Kissimmee, Florida 32758
(305) 933-0500

An **AMATEUR** Company

181

THE CHAMP

BIRD MODEL 4304

NO ELEMENTS
25-1000 MHZ
RF SAMPLING PORT

AUTHORIZED **BIRD** DISTRIBUTOR

Webster

WEBSTER COMMUNICATIONS INC.
115 BELLARMINA
ROCHESTER, MI 48063
313-375-0420

CALL TOLL FREE
800-521-2333
800-482-3610

CADDELL COIL CORP.

35 Main Street
Poultney, VT 05764
802-287-4055

BALUNS

Get POWER to your antenna! Our Baluns are already wound and ready for installation in your transmatch or you may enclose them in a weatherproof box and connect them directly at the antenna. They are designed for 3-30 MHz operation. (See ARRL Handbook pages 19-9 or 6-20 for construction details.)

100 Watt (4:1, 6:1, 9:1, or 1:1 impedance - select one)	\$ 8.50
Universal Transmatch 1 KW (4:1 impedance)	12.50
Universal Transmatch 2 KW (4:1 impedance)	15.00
Universal Transmatch 1 KW (6:1, 9:1 or 1:1 - select one)	14.00
Universal Transmatch 2 KW (6:1, 9:1 or 1:1 - select one)	16.50

Please send all reader inquiries directly.

SAY YOU SAW IT IN HAM RADIO

QUICK WEATHER PROTECTION PRODUCTS & ANTENNA ACCESSORIES



SEE US AT THE DAYTON HAMVENTION
 Use covers with "Flo Thru" air vents for humidity control.



PRODUCT & DESCRIPTION		MODEL
QIK-ON Polarator, LNA, Wire Terminal and also Down Converter Weather Boots with "Flo Thru" air vents for humidity control. Pat. Pending		(White) LNA-S LNA-A LNA-DCB LNA-DCP LNA-DCI (Interstat Wadapter) (Black) deduct \$1.00
QIK-MOUNT (Universal) Down Converter Plate & Boot with "Flo Thru" air vents		Black
QIK-COVER Motor Boots with "Flo Thru" air vents Pat. Pending		(Black) MB MBO
QIK-PRO Actuator Boots with "Flo Thru" air vents Pat. Pending		Regular 18" Drive 24" " 36" " 48" " 54" " 60" " Basic Systems 18" Small
QIK-LIMIT Universal Limit Switch		Boxed
QIK-ALIGN Feed Horn Alignment Tool Pat. Pending		Extends 25" to 47" Boxed

Terms: Cash, Certified check, Money order, Money transfer Prices effective 6-1-84
 Freight: UPS, COD, FOB. Paullin Industries, 1446 State Rtes. 60, Ashland, Ohio 44805

Designing and developing new products for growing industries.



new Hamtronics® 800 MHz receiver preamplifier

A new 800-960 MHz version of its popular GaAs FET preamp is now available from Hamtronics, Inc. The LNG-800 preamp features a dual-gate GaAs MESFET with built-in diode protection against static discharge damage. The

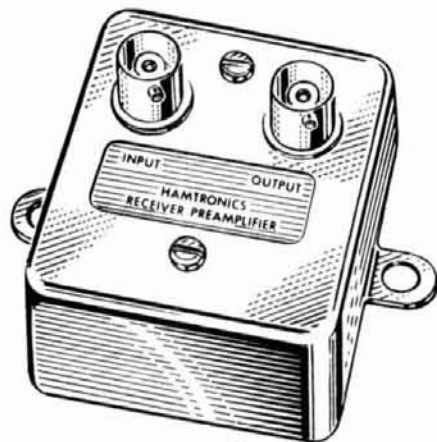

unit has 11 dB of gain with a 1.5 dB noise figure. It is easy to install, operates on 13.6 VDC, and measures only 2x2x1-1/2 inches. The LNG series of GaAs FET preamps is available also for the high band and UHF band. Preamps in the LNG series, including the LNG-800, cost \$49 plus \$3 shipping.

For complete information on the LNG preamps, and other Hamtronics products for VHF and UHF, contact Hamtronics, Inc., 65-F Moul Road, Hilton, New York 14468-9535.

Circle #107 on Reader Service Card.

184

ALL BAND TRAP "SLOPER" ANTENNAS!

FULL 1/4 wave - ALL BANDS! AUTOMATIC SELECTION with PROVEN Weatherproof sealed Traps - 18 Ga Copperweld Wire! GROUND MOUNT SLOPERS - No Radials needed! Instant "Drive In" Mount rod furnished. Connect Top to Trees, Buildings, Poles, etc at ANY angle from Straightup to 60 degrees for excellent "SLOPER" DX Antenna Gain or bend it anywhere you need to! 2000 Watt PEP input, max. Permanent or portable Use. Installs in 10 minutes. SMALL - NEAT - ALMOST INVISIBLE - No one will know you have a Hi-Power DX Antenna. Ideal For COND'Os APARTMENTS - RESTRICTED AREAS - Pre-tuned for 2-1 or less SWR over ALL bands (except 80-160-300kc). No adjustments needed - EVER. COMPLETELY ASSEMBLED, with 50 ft RG-58U Coax feeding and PL-259 connector - ready to hookup! FULL INSTRUCTIONS!

No. 1610S - 160-80-40-20-15-10 - 5 traps 83 ft. - \$149.95
 No. 8010S - 80-40-20-15-10 - 4 traps 39 1/2 ft. - \$129.95
 No. 4010S - 40-20-15-10 - 3 traps 21 1/2 ft. - \$99.95
 No. 2010S - 20-15-10 - 2 traps 12 ft. - \$79.95
 30 meters added to any model \$24.00 extra.

SEND FULL PRICE FOR PPDEL IN USA (Canada is \$10.00 extra for postage etc) or order using VISA, MASCARD - AMER EXP. Give Number Ex Date. Ph 1-308-236-5333 weekdays. We ship in 2-3 days (Per Cxs 14 days) Guaranteed 1 yr - 10 day money back trial.

WESTERN ELECTRONICS 185
 Dept. AH-4 Kearney, Nebraska 68847

GROTH-Type COUNTS & DISPLAYS YOUR TURNS

● 99.99 Turns
 ● One Hole Panel Mount
 ● Handy Logging Area
 ● Spinner Handle Available

Case: 2x4"; shaft 1/8"x3"

TC2 \$12.50 Model TC2: Skirt 2-1/8";
 TC3 \$13.50 Model TC3: Skirt 3";
 Spinner Handle Add \$1.50 Knob 1-5/8"
 Knob 2-3/8"

Prices include UPS or Parcel Post in US

R. H. BAUMAN SALES
 P.O. Box 122, Itasca, Ill. 60143

J.I.L. SX-400 general coverage scanning monitor receiver

The new SX-400 general coverage scanning monitor receiver from J.I.L. Corporation is designed to cover AM/FM signals in the 26-520 MHz region. This frequency range should be of interest because of the unit's complete coverage of the FM/TV and the 220-MHz band as well as military frequencies above 225 MHz. A complete line of converters for expanding the SX-400's range from 100 kHz to 1.4 GHz - making this unit one of the most versatile scanners on the market - is also available.

Barry Electronics Corp.

WORLD WIDE AMATEUR RADIO SINCE 1950
Your one source for all Radio Equipment!

For the best buys in town call:
212-925-7000
Los Precios Mas Bajos en Nueva York...

The SX-400 has a 20-channel computer controlled memory. Sensitivity is 0.5 μ V FM/1 μ V AM in the 26-300-MHz range and 0.5 μ V FM/2 μ V AM in the 300-520-MHz range. The unit has both a fast (8 characters per second) and slow (4 characters per second) scan rate and has a variable 0 to 4-second delay rate. An automatic noise limiter has been added to reduce pulse noise interference on AM and FM if a filter is used to facilitate the reception of TV and FM broadcast services. For high fidelity reception of signals, channels can be spaced in either 5 or 6.25 kHz steps on VHF and 10 or 12.5 kHz steps on UHF.

An easy-to-use keypad is included for programming frequencies. The unit weighs approximately 7-3/4 pounds (3.5 kg), measures 11.8 x 3.5 x 8.3 inches (30 x 9 x 21 cm) and runs on 13.8 VDC.

The SX-400 is directly interfaceable through the RC-4000 data interface to the NEC-8801A computer. This capability allows both high speed reprogramming of the scanner's channels and an almost unlimited number of channels to be contained in the computer's memory. The computer also provides a complete record of which frequencies were received and the time at which they were received.

Other accessories for the SX-400 include an 800-1400 MHz downconverter for AM/FM (RF-8014); a 500-800 MHz downconverter for AM/FM (RF-5080); a 100 kHz-30 MHz upconverter for AM/SSB/CW (RF-1030); RF attenuators, AF gain control, Delta tuning, IF noise blanker, provision for three external antennas, and squelch. When using the RF-1030 in conjunction with the other converters CW/SSB and AM/FM in the 100 kHz-1.4 GHz range can be received. The suggested retail price is \$574.90.

For more information on the SX-400 and its accessories, contact J.I.L. Industries, 17120 Edwards Road, Cerritos, California 90701.

Circle 1303 on Reader Service Card.

Butternut Electronics HF2V

Butternut Electronics has just released a new two-band vertical antenna, the HF2V. Designed for 80 and 40 meters, the HF2V can be modified to operate on 160, 30, and 20 meters. The overall height is 32 feet (9.75 meters) and the antenna weighs 13 pounds (5.9 kg). The HF2V is designed to match 50-ohm cable and will give a 2:1 or less VSWR bandwidth of approximately 65 kHz on 80/75 and full-band coverage on 40 meters. Its power rating is 2 kW PEP/1 kW CW (slightly less when using the 160-meter base resonator). The HF2V is designed to operate as a 1/4-wave vertical on 40 meters and a loaded antenna on 80 meters.

For more information, contact Butternut Electronics, 405 E. Market Street, Lockhart, Texas 78644.



We Give You the Best in Amateur and Commercial Radios Call Us. It's Jan K2RVR, Kitty WA2BAP, Mark K2CON See you at Flemington, N.J. Hamfest April 20th

KITTY SAYS: WE ARE NOW OPEN 7 DAYS A WEEK.
Saturday & Sunday 10 to 5 P.M.
Monday-Friday 9 to 6:30 PM Thurs. to 8 PM
Come to Barry's for the best buys in town.

KENWOOD

R-600, R-1000, R-2000, TS-930S/AT, TS 430S, TR2600A/3500, TR 7950, TW-4000A, Kenwood Service/Repair, TH-21AT, TH-41AT, TM-211A/411A & TS-711A/811A

TELEX PRO-COM

ROCKWELL/COLLINS KWM-380

VoCom/Mirage/Daiwa Tokyo Hy-Power Amplifiers & 5/8" HT Gain Antennas IN STOCK



MICROLOG AIR I, Air Disk

KANTRONICS UTU, Interface II, Challenger

EIMAC 3-500Z 572B, 6JS6C 12BY7A & 4400A

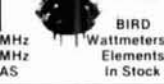

AEA 144 MHz AEA 440 MHz ANTENNAS

BIRD Wattmeters & Elements IN Stock

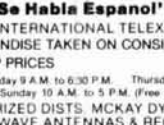

Antennas

A-5 Cushcraft Hustler N.M. Mini-Products Mosley

NGC 7-2150 Transceiver

Large inventory of Saxton Wire & Cable

AMERITRON AMPLIFIER AUTHORIZED DEALER

Yaesu FTR-2410, Wilson ICOM IC-RP 3010 (440 MHz) ICOM IC-RP 1210 (1.2 GHz)

Computer interfaces stocked: MFJ-1224 AEA CP-1, PKT-1, DR-DX CP-100, ATU, Dr. OSO

ALPHA AMPLIFIERS

Complete Butternut Antenna Inventory IN Stock!

DIGITAL FREQUENCY COUNTERS

Trinity Pro-Com Engineering Model TR 1000 0-1 GHz 0-500 MHz

Long-range Wireless Telephone for export in stock

BENCHER PADDLES, BALUNS, AUDIO FILTERS, IN STOCK

MIRAGE AMPLIFIERS ASTRON POWER SUPPLIES DENTRON IS BACK IN STOCK!

MAIL ALL ORDERS TO BARRY ELECTRONICS CORP., 512 BROADWAY, NEW YORK CITY, NY 10012.

New York City's LARGEST STOCKING HAM DEALER COMPLETE REPAIR LAB ON PREMISES

"Aquí Se Habla Español"

BARRY INTERNATIONAL TELEX 12-7670 MERCHANDISE TAKEN ON CONSIGNMENT FOR TOP PRICES

Monday-Friday 9 A.M. to 6:30 P.M. Thursday to 8 P.M. Saturday & Sunday 10 A.M. to 5 P.M. (Free Parking)

AUTHORIZED DIST. MCKAY DYMEK FOR SHORTWAVE ANTENNAS & RECEIVERS

Subways: BMT-"Spring St. Station" IND-"F" Train-Bwy. Station"

Bus: Broadway #6 to Spring St. Path--9th St. 6th Ave. Station.

We Stock: AEA, ARRL, Alpha, Ameco, Antenna Specialists, Astac, Astron, B & K, B & W, Bash, Bencher, Bird, Butternut, CDE, CES, Collins, Communications Spec. Connectors, Covercraft, Cushcraft, Daiwa, Dentron, Digimax, Drake, ETO (Alpha), Eimac, Ecom, Hell Sound, Henry, Hustler (Newtronics), Hy-Gain, Icom, KLM, Kantronics, Larsen, MCM (Daiwa), MFJ, J.W. Miller, Mini-Products, Mirage, Newtronics, Nye Viking, Palomar, RF Products, Radio Amateur Callbook, Robot, Rockwell Collins, Saxton, Shure, Telex, Tempo, Ten-Tec, Tokyo Hi Power, Trinity TUBES, WZAJ, Waber, Wilson, Yaesu Ham and Commercial Radios, Vocom, Vibroplex, Curtis, Tri-Ex, Wacom Duplexers, Repeaters, Phelps Dodge, Fanon Intercoms, Scanners, Crystals, Radio Publications.

WE NOW STOCK COMMERCIAL COMMUNICATIONS SYSTEMS DEALER INQUIRIES INVITED. PHONE IN YOUR ORDER & BE REIMBURSED. COMMERCIAL RADIOS stocked & serviced on premises. Amateur Radio Courses Given On Our Premises, Call Export Orders Shipped Immediately. TELEX 12-7670



ICOM IC-R71A, IC-751, IC745, IC-27A/H, IC-37A IC-47A, IC-271A/H, IC-3200A, IC-4714A/H, IC-735



SMART PATCH C&S Simpson Autopatch 510 SA VHF Patch FM Transceiver. To Your Telephone. Great For Telephone Calls From Mobile To Base. Sample To Use \$319.95



WELZ FLUKE 77 Multimeter



Nye-M85 3 Kilowatt Tuner

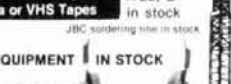

SANTEC ST-222UP ST-142UP ST-442UP HT-17



MURCH Model 2000 A, A-LS, B, IN stock JBC soldering iron in stock

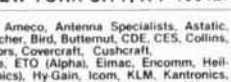

HEIL EQUIPMENT IN STOCK

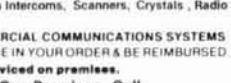

New TEN-TEC 2591 HT, Corsairs stocked

SEMICONDUCTORS:		P.C. BOARDS FOR MOTOROLA BULLETINS	
MRF-208.....	12.00	MHW-252.....	53.00
MRF-240.....	18.40	MHW-710-1.....	61.00
MRF-247.....	34.80	MPSH-81.....	50
MRF-309.....	33.80	MV2205.....	58
MRF-422.....	41.40	78L08CP.....	50
MRF-454.....	20.00	2N4401.....	75
MRF-901.....	1.75	2N5190.....	1.50
SBL-1 Double-Balance Mixer.....	6.50	AN-762.....	14.00
		EB-27A.....	14.00
		EB-63.....	14.00
		AN-791.....	10.00
		EB-67.....	14.00
		KEMET CHIP CAPACITORS: 56 pf, 82 pf,	
		100 pf, 390 pf, 470 pf.....50 ea.	
		680 pf, 1000 pf.....55 ea.	
		5600 pf, 6800 pf, 1 μ1.00 ea.	
		33 μ1.90 ea. .68 μ3.90 ea.	

CAMBION RF CHOKES: 15 μ , 22 μ , 33 μ , 4.7 μ , 10 μ1.20 ea.
BROADBAND TRANSFORMERS PER MOTOROLA BULLETINS: AN-762, EB-27A, EB-63
UNDERWOOD/SEMCO METAL-CLAD MICA CAPACITORS: 5pf, 10pf, 15pf, 25pf, 30pf, 40pf, 56pf, 60pf, 68pf, 80pf, 91pf, 100pf, 200pf, 250pf, 390pf, 470pf, 1000pf

We also carry a line of VHF, UHF amplifiers and ATV equipment.
Call or write for our free catalog.



2648 North Aragon Ave. • Dayton, Ohio 45420 • (513) 296-1411

Need A Storage Scope?



The Model 601 Scope Memory converts your oscilloscope into a storage scope. With the Scope Memory you can capture & display transients, pulses and low frequency signals. Stores both analog & digital signals in a single sweep. Features a 1.4 MHz sample rate, 2K memory, pre and post trigger capabilities. Price \$515

Sibex, Inc.

2340 State Road 580 Suite 241
Clearwater, FL 33515
(813) 797-9589

✓ 188

8 POLE CRYSTAL FILTERS FOR

KENWOOD, ICOM, AND YAESU RADIOS

KENWOOD
2.1 kHz SSB for TS-930 or TS-830 matched set\$149.99
400 Hz CW for TS-930 or TS-830 matched set\$149.99
2.1 kHz SSB tail end IF cascade kit (8 extra poles) for the TS-430, TS-120 and TS-130 \$79.00
2.1 kHz 8 pole xtal filter for the R-1000\$129.00
2.1 kHz 8 pole xtal filter for the R-2000\$139.00
400 Hz CW (8 pole) xtal filter for the R-2000\$99.00
TS-930 NEW FM KIT True fm, xmit & rcv. 30 watts, rx better than 2 uv sensitivity. Wired and tested\$139.00

ICOM
2.1 kHz SSB and 400 Hz CW 8 pole xtal filter for the IC-730, 740, 745, R70 and R71 radios\$99.00

YAESU
2.1 kHz SSB 8 pole xtal filter for the FT-980 Filter for FT-757 available soon\$99.00

ICOM, Kenwood newsletters 1 year \$10.00 US (\$12 first class mail) \$14 elsewhere. SASE for details. ✓ 189

When ordering please specify radio and crystal filter ordered. Please add \$3 for shipping and handling USA, \$5 air mail, COD add \$1.75, \$10 overseas. FL residents add 5% sales tax.

SEE US AT BOOTH 382 at DAYTON

INTERNATIONAL RADIO, INC.

1532 SE Village Green Dr.
Port St. Lucie, FL 33452
(305) 335-5545

COMMODORE

-USER WRITTEN SOFTWARE-

Supporting all COMMODORE computers

Written by users, for users

★ GAMES ★ UTILITIES ★ EDUCATIONAL ★

Our Latest Releases

C-64 Best Of Games	Vic 20 Best Of Games
C-64 Best Of Educational	Vic 20 Best Of Educational
C-64 Best Of Utilities	Vic 20 Best Of Utilities
C-64 84 Contest C-64 #1	Vic 20 Best Of Utilities
C-64 84 Contest C-64 #2	Vic 20 Contest Vic #1
C-64 84 Contest C-64 #3	

Specify Disk Or Tape \$10.00 each

COMAL STARTER PAK - 4 Disk Set - \$35.00

Bulletin Board Sys - On Best Of Utilities Collections

COMMODORE 64™ collections #1 thru 12

VIC 20™ collections #1 thru 12

Tape/Disk \$10.00 each per collection ✓ 190

SERIAL CABLES DISKET: Reset Switch LOK-LITE

PDI Program Manual \$10.00

Shipping and Handling Charges

US/Canadian Orders Add \$3.00

Foreign Orders Add \$5.00

CHECK, MONEY ORDERS, VISA and

MASTERCARD accepted. No COD's or P.O.'s

Write For A FREE Catalog

'PUBLIC DOMAIN™', INC.

5025 S. Rangeline Rd., W. Milton, OH 45383

10:00 a.m. - 5:00 p.m. EST - Mon. thru Fri.

(513) 698-5638 or (513) 339-1725

✓ 190



automatic gain control (AGC-4)

The AGC-4 automatic gain control kit from Barrett Electronics is for any Amateur who needs to keep audio levels constant. In addition to the obvious repeater, autopatch, phone patch, or HF transmitter applications, the AGC-4 can be used in RTTY or SSTV reception with minor component adjustments. As featured in the September, 1984, issue of *ham radio*, the AGC-4 will hold a constant output of 2 volts P-P (± 2 dB) with any input level ranging from -36 dBm to +10 dBm. At the center of the AGC range, the total harmonic distortion is 0.5 percent or less with a frequency response (-3 dB) that spans 40 Hz to 20 kHz. With the input shorted, the noise floor is -42 dB below the AGC output level. The AGC-4 was originally designed for the Collins/Autogram "IC" series broadcast mixer and can be operated single ended or with user supplied level or impedance matching transformers. The kit includes a drilled 2-3/4 x 1-5/8-inch printed circuit board, parts, and instructions. The unit is priced at \$28.00 including U.S. shipping.

For details, contact Barrett Electronics, 525 North 2150 West, West Point, Utah 84015.

Circle #316 on Reader Service Card.

surveillance receivers

A new generation of HF surveillance receivers has been introduced by Cubic Communications with the R-3030, which features two completely independent receivers in the same rack mount normally required for a single unit.

During the first nine months of introduction, the U. S. Navy contracted for nearly 1000 receivers in the series. Principal selling points included size, light weight, and a wide range of standard advanced features.

The basic receiver is fully functional without costly options, although customer-specified enhancements such as a special data bus or up to six selectable bandwidths also are available.

The advanced modular design (in which plug-in modules are secured by 1/4-turn fasteners and can be replaced in 30 seconds or less) simplifies maintenance and improves operation. In addition, each module is independently shielded to protect circuits from electromagnetic interference as well as potential handling and storage damage.

In shock tests conducted for the Navy, the R-3030 demonstrated its rugged construction by

passing a full 2000-foot-pound "hammer test" with a level A rating. The receiver was bolted to a platform, which then was struck by a 400-pound hammer swinging in successive arcs of one, three and five feet. The test was then repeated with the R-3030 turned 90 degrees.

The Navy's "level A" rating means the unit not only retained all components in place, but also continued to work perfectly after the shocks, which are meant to simulate the force of a direct hit to the ship by a non-nuclear torpedo. The reliability level resulting from this rugged construction means more than 5000 hours mean time between failures.

The R-3030's expanded performance features include: tuning in less than 8 milliseconds over a full 5 kHz-30 MHz range, 30 percent fewer parts than conventional radios and capability for full computer control. The modular, building-block approach makes it easier to meet special requirements for data bus connectors, bandwidths, AGC settings and so on.

Fault isolation is both simple and comprehensive, providing quick detection and easy replacement. All faults are reported automatically in three simultaneous modes: data bus, front panel annunciator, and LED on the faulty module. Field repair requires only removing the specified independently shielded module and plugging in a replacement. Each module is labeled and marked with a diagonal coding stripe to prevent improper installation. No special tools, alignment or adjustment are required.

The R-3030 also provides such standard features as: 100 memory channels, IEEE-488 or RS-232 bus connector modules, EMI/EMC shielding, five bandwidths (0.5-8 kHz), five operating modes (LSB, USB, AM, FM, and CW) versatile sweep and scan modes and minimal power input (approximately 35 watts per receiver).

The 48-pound dual system in a compact 5-1/4 x 19 inch rack chassis saves valuable operations and parts storage space in the field while offering effective coverage of virtually any general purpose or surveillance requirement.

For more information, contact Cubic Communications, 305 Airport Road, Oceanside, California 92054-1297.

Circle #306 on Reader Service Card.

transfer lettering fixative

Once a curiosity, dry transfer lettering is now part of the design engineer's and draftsman's tool kit. Even though the letters stick to virtually all surfaces, permanence can be a problem. Unprotected transfer lettering wears off with use. General purpose aerosol sprays aren't much help, because they contain aggressive solvents that cause dry transfers to dissolve, wrinkle or even float out of position before repeat coats can be applied to build up a protective film.

Two products from DATAK can help provide greater permanence: Dakakoat™ acrylic spray can be used to protect transfers applied to

painted or unpainted surfaces on metal and plastics. It will not, however, form a smooth film on porous materials such as paper and tracing vellum; Datacoat rests on top of the transfer, but will sink into the surrounding areas of porous materials.

The transfer lettering on porous surfaces can be protected with Hardcoat,™ a unique spray for use on rubdown transfers applied to paper and other porous surfaces. A single coat softens and penetrates the transfer ink, then glues it to the surface. No additional coats are needed unless severe weathering is expected.

Hardcoat is supplied in 12-ounce spray cans in either gloss or matte finishes. The price for either is \$4.75.

For further information, contact The DATAK Corporation, 65 71st Street, Guttenberg, New Jersey 07093.

Circle #307 on Reader Service Card.

engineer's sample case

Aries Electronics, Inc. has made available a Component Engineer's sample case, Part No. SB-100, containing over 100 pieces of various connector products the company makes. Included are sockets, Vertisockets,® elevator

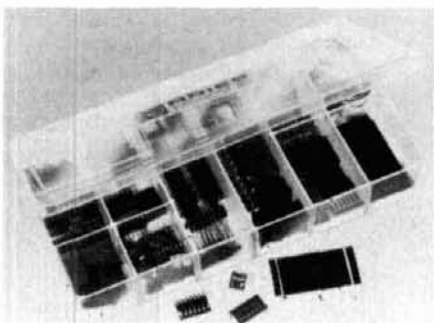

sockets and single-row sockets (both stamped and collet pin versions), headers, programmable headers, switches, shorting plugs, jumper assemblies, etc. Worth over \$100 if purchased individually, these parts come in a handy plastic case and sell for \$30.00.

For additional information, contact Aries Electronics, Inc., P.O. Box 130, Frenchtown, New Jersey 08825.

Circle #308 on Reader Service Card.

DTMF encoder mike

Midland LMR has introduced an optional DTMF encoder microphone for its Midland SYNTECH™ line of 2-way FM mobile radios. Available with or without automatic number identifier (ANI) capabilities, the new dynamic amplified microphones incorporate an integral DTMF encoder capable of generating the 16 standard DTMF digits 0-9 plus *, #, A, B, C and D. The

AT LAST A MINIATURE BASE STATION AT A MINIATURE PRICE...

The MX-15 is a 15-meter band SSB/CW hand-held transceiver. It measures only 1 1/2" (D) x 2 5/8" (H) and offers 300mW for SSB and CW operation. A single-conversion receiver employing a MOS/FET front-end offers clear and sensitive reception. As a base or portable station, the MX-15 offers an unlimited challenge in QRP operation. Additional accessories are available to extend your operation.

The MX-15 comes with full 90 day warranty and is available from factory direct or HENRY RADIO (800) 421-6631



\$129.95

VISA

ACCESSORIES SUPPLIED

- Standard Frequency crystal of your choice
- 6 pc. AAA Batteries
- DC Cable
- Instruction sheet

ACCESSORIES AVAILABLE

- | | |
|---|---------|
| ■ MX Channel crystal.... (Standard Frequency) | \$7.00 |
| ■ MS-1 External Speaker-Microphone | \$23.50 |
| ■ Noise Blanker Kit | \$6.50 |
| ■ NB-1 Side Tone Kit | \$11.50 |
| ■ SP-15 Telescoping antenna | \$19.50 |
| ■ 2M2 DC-DC Converter set | \$17.50 |
| ■ PR-1 Mobile Rack Kit | \$23.50 |
| ■ VX-15 External VXO (one crystal supplied) | \$53.50 |
| ■ PL-15 10W Linear amplifier | \$89.50 |



Photo shown MX-15, VX-15, PL-15, SP-15, MS-1 and PR-1

ALE communications, inc.

22511 ASPAN ST. LAKE FOREST, CA 92630 (714) 581-4900
Telex 29-7385 ACE UR

✓ 148

VISA



ICOM



VHF COMMUNICATIONS



✓ 192

915 North Main Street
Jamestown, New York 14701

Western New York's finest... amateur radio dealer!

PH. (716) 664-6345

ALL BAND TRAP VERTICAL

Great for DX

Completely assembled and ready to use!
-Commercial quality, built to last -Light-weight, sealed, weatherproof trap(s)
-Low loss end insulator -Handles up to 2000 watts PEP - Automatic band switching -For all transmitters, receivers & transceivers -Tuner usually never required -Deluxe end feed connector, with built in lightning arrestor, accepts PL 259 coax connector -Use as sloper or vertical - Permanent or portable use - Easy to install -Can be used without radials - Attaches to almost any support -Excellent for all class amateurs - Instructions included -10 day money-back guarantee!



4-Band-40,20,15,10 meters (27') 1 trap#VS-41
\$39.95 plus \$4.00 shipping
5-Band-80,40,20,15,10 meters (52') 2 traps #VS-52
\$54.95 plus \$4.00 shipping
50 ft. RG-58U, 52 ohm coax cable with PL-259 connector on each end - add \$8.00 to above price.
We accept VISA/MC - give Card#, Exp. date, Signature ✓ 193



SPI-RO DISTRIBUTORS,
Room 103, P.O. Box 1538
Hendersonville, NC 28793



JRS Distributors

646 W. Market Street
York, PA 17404
(717) 854-8624

Friendly
Personalized Service

Full Line of
Amateur Radio Equipment.
Factory Authorized
Kenwood and ICOM dealer.
Call us today
Jim, K3JFL Jean K3OAU
Dale, KA3KOL ✓ 201

\$\$\$ GIANT SAVINGS \$\$\$
HIGH QUALITY AT LOW PRICES

DYSAN® DISKETTES
PREMIUM QUALITY AT HUGE SAVINGS

~~\$210~~ ~~\$230~~ ~~\$240~~ ~~\$250~~ ~~\$260~~
All diskettes are in boxes of 10
with labels, envelopes and reinforced hubs.

DISK STOR holds 50 5 1/4" Diskettes. \$12.95 + \$2.00 shipping

PRINTERS

Panasonic KX-P 1090.....\$245.00
Panasonic KX-P 1091.....\$302.00
Okidata ML-82A.....\$305.00
Okidata ML-84.....\$695.00

Write or call for complete catalog on computers and/or books

SHIPPING: 5 1/4" DISKETTES - Add \$3.00 per 100 or less. PAYMENT VISA, M/C or check with order. COD orders add \$2.00. \$1.50 credit on long distance phone orders. TAXES Illinois customers add 8% ✓ 195

SCAMP SYSTEMS, INC.
BOX 59451 - CHICAGO, ILLINOIS 60659
1-312-267-9858



company had previously announced availability of a DTMF decode option for its SYN-TECH radios.

The new SYN-TECH DTMF encoder microphones have a front-mounted keypad which can be enabled and disabled by an on-off switch, with current status indicated by a red LED. An internal annunciator provides audible confirmation of each keypad switch closure. Single tones can be generated, also, by simultaneously pressing two keys in the same column or row. Top-located up/down switches allow direct control of channel selection from the microphone.

The SYN-TECH DTMF microphone with ANI capability features an ANI output which is jumper selectable from one to eight digits. The ANI sequence is automatically sent at the beginning of a transmission if a pre-set time interval has elapsed since the previous transmission. The ANI code sequence can be activated at any time by pressing the * or # key, and can be "strapped" to give single or multiple sequences when activated.



For more information on the new Midland SYN-TECH DTMF options, contact Midland LMR, Marketing Department, 1690 N. Topping, Kansas City, Missouri 64120.

Circle #309 on Reader Service Card.

micro-ohmmeter

Cambridge Technology, Inc. has introduced the Model 510, a low-cost, 4-1/2 digit, micro-ohmmeter designed to measure the resistances of switch and relay contacts, transformer and motor windings, connectors, or any other low

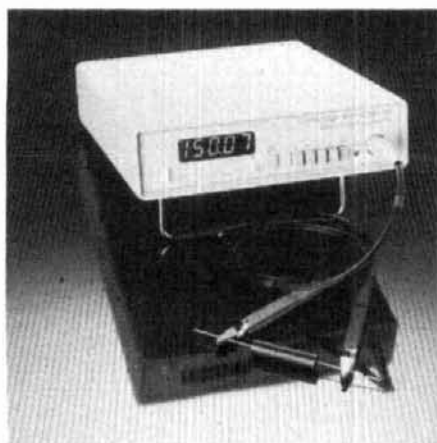

resistance devices. It has five ranges from 19.999 milliohms to 199.99 ohms, full-scale, 1 micro-ohm resolution, and a basic accuracy of 0.02 percent.

Three measurement modes are provided. The continuous DC mode is useful for making measurements on inductive components and the switched DC mode removes the effect of thermal voltages, the largest source of error in low resistance measurements. A pulsed mode is provided for thermally sensitive devices such as fuses. The standard unit comes with 4-terminal Kelvin test clips and a parallel BCD interface. Optional limits comparators, battery operation, and an RS-232 interface will be available in the first quarter of 1985.

For further information, contact Cambridge Technology, Inc., 2464 Massachusetts Avenue, Cambridge, Massachusetts 02140.

Circle #311 on Reader Service Card.

automatic phone patch system

NCG Co. has just announced its new Hotline 007 simplex autopatch unit. When connected between your radio and the telephone line, it enables initiation and reception of telephone calls without operator assistance. The Hotline 007 uses a unique method of signal processing that eliminates annoying squelch tails and chirps that are heard on other units. The unit uses a field programmable five digit access code to eliminate unauthorized use. In the event that you drive out of communications range, the Hotline 007 has a variable 3 to 12 minute time-out timer. When someone is calling, the Hotline 007 will page you with a CW message. To answer the call, simply send your 5-digit access code and the Hotline 007 will connect you to the phone call. You can also program the unit to refuse any calls that start with a 0 or 1. NCG also has DTMF microphones and telephone handsets available as options.

For further information and prices, contact NCG Co., 1275 N. Grove, Anaheim, California 92806.

Circle #301 on Reader Service Card.

DALBANI CORPORATION

PARTS COMPONENTS SYSTEMS

Dalbani Corporation offers the finest
in audio, video, computer and home electronics,
for the professional retailer or home specialist.

To obtain a copy of our 88 page
full-line 1985 catalog please call:

1-800-DALBANI*

✓ 196

DALBANI CORPORATION
785 E. 14th Street
Los Angeles, CA 90021

* Alaska, Hawaii and International please call:
1-(213) 747-6830

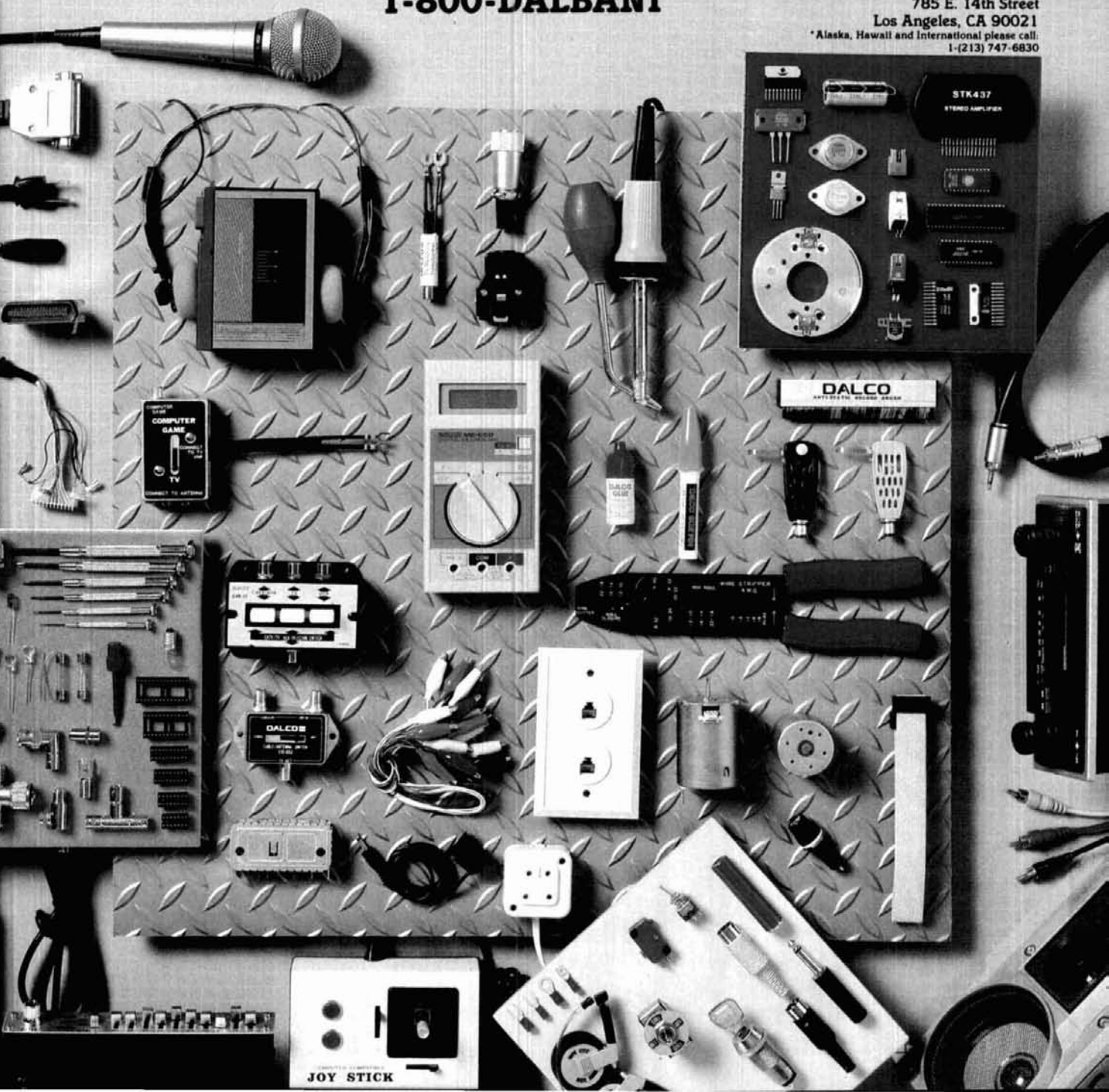



**IT'S
INCREDIBLE!**

Master code or upgrade in a matter of days. **Code Quick** is a unique breakthrough which simplifies learning Morse Code. Instead of a confusing maze of dits and dahs, each letter will magically begin to call out its own name! Stop torturing yourself! Your amazing kit containing 5 power-packed cassettes, visual breakthrough cards and original manual is only **\$39.95!** Send check or money order today to **WHEELER APPLIED RESEARCH LAB, P.O. Box 3261, City of Industry, CA 91744.** Ask for **Code Quick #103**, California residents add 6% sales tax.

One User Comments:

"First new idea in code study and the darn thing works! So much fun you don't realize how much you're learning."

M.S. Greneda, Miss.

Hundreds of satisfied customers! You can't lose! Follow each simple step. You must succeed or return the kit for a total immediate refund!

AZOTIC INDUSTRIES

2026 W. BELMONT
CHICAGO, IL 60618
312-975-1290

ELECTRONIC COMPONENTS & SUPPLIES

- RF CONNECTORS
- UG CONNECTORS
- AUDIO CONNECTORS
- LINEAR IC'S
- DIGITAL IC'S
- TRANSFORMERS
- METERS
- COMPUTER CABLES
- DISKETTES
- IDC CONNECTORS
- D-SUBMINIATURE
- TEST EQUIP
- TRANSISTORS
- DIODES
- TRIM CAPS
- RELAYS
- SWITCHES
- TOOLS

WRITE FOR FREE CATALOG
VISIT OUR RETAIL STORE
HRS. MON-FRI 10-5 SAT 10-2
PHONE ORDERS WELCOMED
312-975-1290 ✓ 198

**MICROCOMPUTER
REPEATER CONTROL**



\$119

✓ 199

Introducing the MICRO REPEATER CONTROLLER RPT-2A, a new concept in LOW COST, EASY TO INTERFACE, microcomputer repeater control. Replace old logic boards with a state of the art microcomputer that adds NEW FEATURES, HIGH RELIABILITY, LOW POWER, SMALL SIZE, and FULL DOCUMENTATION to your system. Direct interface (drop in) with most repeaters. Detailed interface information included. Original MICRO REPEATER CONTROL article featured in QST Dec. 1983.

- Two CW ID Messages
- Time Out Timer
- Pre-Timed Warning MSG
- Post-Timed CW MSG
- Courtesy Beep
- Auxiliary Inputs
- Reconfigurable COR Input
- High Current PTT Interface
- Sine Wave Tone Generator
- Low Power 9.15 VDC @ 200 ma
- Size 3.5" x 3.5"
- All Connectors Included

RPT-2A Kit Only \$119 plus \$3.00 shipping

PROCESSOR CONCEPTS

P.O. BOX 185
FORT ATKINSON, WI 53538
(414) 563-4962 7pm-10pm evenings



CALL OR WRITE FOR FREE CATALOG AND SPECIFICATIONS



**Computer Programs
for
Amateur Radio**

by Wayne Overbeck, N6NB
and Jim Steffen, KC6A

HERE'S THE EASY WAY TO PUT A COMPUTER INTO YOUR SHACK

Wouldn't you like to use one of the popular, inexpensive home computers to handle a variety of your Amateur Radio chores? N6NB and KC6A have come up with a host of valuable computer programs and background information which are just the ticket to help you computerize such duties as: logging, duping contest logs, awards record keeping, calculating Gray line and beam headings to name just a few examples. You can either enter the programs from the book by hand or you can buy the programs already loaded onto easy-to-use disks for the four most popular home computers: C-64, TRS-80, Apple II or the IBM-PC. In fact, the complete package of this 367 big, page book and program disk costs no more than many of the game programs that your kids are now using. Without a doubt, this is the *real bargain* in Amateur Radio software. See how much easier your home computer can make your hamming activities. ©1984 1st edition, 327 pages.

Program Listing

- 1) *Demo*
MiniLogger
- 2) *Data Base Mgmt.*
Logbook
Radio Awards Data Base
Setup Program for Awards Data Base
Gridlocator
- 3) *Latitude/Longitude Programs*
Data file
Beamheading chart
DX Display
Sunrise Chart
Grayline
Sunrise Anywhere
DX Checker
- 4) *Contest and Duping*
Dupechecker (& Print)
General Contest Logger
Field Day Logger
Sweepstakes Logger
Log Print
- 5) *Antenna Programs*
Antenna Scaler
Antenna Matching Evaluator
Vertical Pattern Plotter
- 6) *To the Moon and Beyond*
EME System Calculator
Sky locator
Moontracker

Program disks available for: IBM PC-DOS, Apple II (DOS 3.3), TRS-80 Model I and III and Commodore C-64.

HA-0657 Softbound \$16.95
Program Disk Alone (No documentation included) \$19.95

HA-0657 with disk **SAVE \$6.95 — \$29.95**
(Please make sure you indicate which machine) (purchased separately \$36.95)

Please enclose \$2.50 for shipping and handling.



ham radio magazine **BOOKSTORE**
GREENVILLE, NH 03048

WRITE FOR

**FREE
BOOK
CATALOG**

Ham Radio's Bookstore
Greenville, NH 03048

**one millionth satellite
earth station installed**

The Board of Directors of the Society For Private and Commercial Earth Stations (SPACE) recently celebrated the installation of the one millionth satellite earth station. SPACE is the National Trade Association representing the Manufacturers, distributors, and dealers of satellite earth stations.

Information about the Society for Private and Commercial Earth Stations, (SPACE), is available from SPACE, 709 Pendleton Street, Alexandria, Virginia 22314.

Tell 'em you saw it in HAM RADIO!

The Problem Solver...

The RF Wattmeter Model 81000-A from Coaxial Dynamics, Inc. does more than provide accurate rf measurements. Testing of transmission lines, antennas, connectors, filters and related components can reveal unknown problems and assure optimum equipment performance.

The 81000-AK Wattkit features this easy-to-read RF Wattmeter (pictured here), with its optional carrying case and an array of elements and accessories. Coaxial Dynamics elements can be purchased separately for use in other manufacturer's Wattmeters. For more information on the 81000-A Wattmeter or any of the complete line of Coaxial Dynamics RF products and OEM components please contact Coaxial Dynamics, Inc.



COAXIAL DYNAMICS, INC.

15210 Industrial Parkway, Cleveland, OH 44135 • (216) 267-2233
Outside Ohio, WATS: (800) Coaxial, Telex: 980-630

SEE US AT
OUR BOOTH
IN DAYTON

200

LISTEN TO THE WORLD



\$89.95

WITHOUT THE ANTENNA HASSLE!

Arcomm's AP4 active tuned antenna/preselector is ideal for those who want to listen but cannot put up outdoor antennas. Covers .540 to 32 MHz in 4 bands and incorporates a low noise, up to 18 dB gain preamp. Intermod is reduced by using Hi-Q toroidal inductors. Will switch four antennas and three receivers. Ideal for all general coverage receivers. 8-1/4" x 6-1/8" x 2", weight 4 lbs.

To order, send check or money order plus \$3 shipping. PA res. add 6% sales tax. Dealer inquires invited.

ARCOMM

24 Valley Street
Lewistown, PA 17044 ✓ 194

10 METER F.M.

29.310-29.700 MHz in 10 kHz Steps. 100 kHz Repeater Split provided. 4W RF Out. 0.3 uV for 12 dB Sinal. c/w Mic. mobile cradle etc.



\$79

VISA CARD
MASTER CARD
I.M.O. DRAFT

AIR POST
PREPAID
WORLDWIDE

S.M.C. Ltd., Totton, Southampton, SO4 4DP, U.K.

214

More Details? CHECK—OFF Page 160

RF Porta-Tenna

VHF/UHF Telescopic 1/4 & 5/8
Wavelength Antennas for
Hand-Held Transceivers &
Test Equipment

1/4 WAVELENGTH

Model No.	Freq. MHz	Description	Price
196-200	144-148	5/16-32 stud w/spring	\$5.95
196-204	"	BNC connector w/spring	7.95
196-214	"	BNC connector	6.95
196-224	144-UP	BNC conn. adj. angle	7.95
196-814	220-225	BNC connector	6.95

5/8 WAVELENGTH

191-210	"	5/16-32 for old TEMPO	22.95
191-214	"	BNC connector	19.95
191-219	"	PL-259 w/M-359 adpt.	22.95
191-810	220-225	5/16-32 for old TEMPO	22.95
191-814	"	BNC connector	19.95
191-940	440-450	5/16-32 for HT-220	22.95
191-941	"	1/4-32 stud	22.95
191-944	"	BNC connector	19.95

Largest Selection of Telescopic Antennas. Write for info. Prices are postpaid via UPS to 48 States. For air delivery via UPS Blue add \$2.25. Florida add 5% sales tax. Payment by M.O. or Cashiers Check only. ✓ 202

RF PRODUCTS

P.O. Box 33, Rockledge, FL 32955, U.S.A.
(305) 631-0775



TUBES and IC's

FAST DELIVERY

LOWEST PRICES

call Toll Free (800) 221-5802

In-depth Inventory - Industrial & Receiving Tubes
Here are 2 dozen examples

3-400Z	\$85.00	MRF455	\$19.95
3-500Z	85.00	M2057	15.00
4CX250B	60.00	872A	24.00
572B	53.00	4X150A	35.00
811A	12.00	6DJ8	2.75
813	35.00	6550A	7.50
6146B	7.75	8072	95.00
6360	5.75	8121	95.00
6883B	7.50	8874	215.00
7360	12.95	8877	520.00
8122	110.00	807	6.75
MRF454/A	19.95	8950	11.50

Major Manufacturers Factory Boxed and Full line of
Sylvania ECG Replacement Semiconductors



Minimum order \$25.00 Allow \$3 UPS charge

TRANSELETRONIC INC.



Box H, 1365 39th ST., BROOKLYN, NY 11218
Tel. 718-633-2800/Watts Line 800-221-5802
FAX # (718) 633-4375

CALL TOLL FREE FOR QUOTES

TNT RADIO SALES INC.

1-800-328-0250

1-612-535-5050

(IN MINNESOTA—COLLECT)

YOU GET MORE "BANG FOR YOUR BUCK" AT TNT RADIO SALES!

- | | | | |
|--------------|----------------|---------------|-------------|
| ■ Kenwood | ■ Mirage | ■ MFJ | ■ Welz |
| ■ Icom | ■ KLM | ■ Astron | ■ Azden |
| ■ Bencher | ■ Telex Hygain | ■ Alpha/Delta | ■ Santec |
| ■ AEA | ■ Nye Viking | ■ Bearcat | ■ KDK |
| ■ Kantronics | ■ Larsen | ■ Regency | ■ Ameritron |

SALES AND SERVICE AT PRICES YOU CAN AFFORD!
CALL OUR WATS LINE FOR LOW LOW PRICES!

SPECIAL OF THE MONTH: LARSEN MAG MOUNT 2M 1/2 PKG—\$36.95

VISA/MASTER CARD
FREE SHIPPING
ON MOST RIGS FOR CASH!



S.A.S.E. FOR OUR
"BENCH-TESTED"
USED EQUIPMENT LISTING

MON-FRI 9 AM - 6 PM CENTRAL TIME
SATURDAY 9 AM - 5 PM

4124 West Broadway, Robbinsdale, MN 55422 (Mpls./St. Paul)

✓ 204



GUS BROWNING, W4BPD's DX'ERS MAGAZINE

For over 17 years, Gus's DX'ERS MAGAZINE has brought thousands of DX'ERS worldwide, timely, pertinent information on when and where to find those elusive DX stations.

Gus's personable, chatty writing style and his years of DX operating experience makes the DX'ERS MAGAZINE a unique publication. One year \$14.00 USA, Canada & Mexico.

Gus also prints high quality QSLs and other related items.

✓ 205 Write today for a free sample of his QSLs and DX'ERS MAGAZINE.

Gus Browning, W4BPD • PO Drawer 405 • Cordova, SC 29039

VOICE OPERATED SQUELCH

- Fits inside most HF-SSB transceivers.
- Requires human voice to activate.
- Ignores static, noise and heterodynes.
- On/off switch only—no adjustments!
- Connects to audio leads and 9/12 VDC.
- Fully assembled and tested \$99.95.
- Complete with comprehensive manual.
- Used worldwide in commercial and military transceivers.

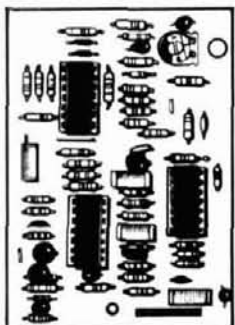

✓ 206

CMC COMMUNICATIONS, 5479 Jetport, Tampa, FL 33614 • (813) 885-3996

INCREDIBLE CODE!!

Learn the International Morse Code
by the patented
"WORD METHOD"

NO BOOKS
CARDS
VISUAL AIDS
GIMMICKS

Just listen and learn! the "WORD METHOD" is based on the latest scientific and psychological techniques. You can zoom past 13 WPM in less than HALF THE USUAL TIME!!

The kit contains two cassette tapes, over TWO HOURS of unique instruction by internationally famed educator Russ Farnsworth. Complete satisfaction guaranteed.

Available at local Electronic Dealers, or send check or money order for \$18.50 plus \$1.50 for postage and handling to:

EPSILON RECORDS

P.O. Box 71581

New Orleans, LA 70172 ✓ 207

**SAY YOU SAW IT
IN
HAM RADIO**

THE GUERRI REPORT

Ernie Gueri
W6 MGI

toward "softer" software

Early electronic data processing systems required that people communicate with them in their own language — *machine* language. But it soon became clear that communication between people and machines in binary, or some related code, was *cumbersome* — for the *people* — and "higher-level" languages had to be devised that would be more recognizable to people and would automatically do conversion to machine language. FORTRAN, COBOL, BASIC, *Ada*, and LISP are all the products of a relentless move toward computer languages that are closer to human experience, yet still accommodate more complex machine architectures. This trend toward "softer" software is aimed primarily at user friendliness — the keep-it-simple concept. But there's a price to pay. Not everything is simple. In an attempt to simplify the languages, software architects have to choose the complexity of the functions they want to implement with relatively simple program statements. In this *simplification process* much computational power can be lost.

Computer architects and software designers must now work hand-in-hand to assure that commands given by humans can be interpreted by machines whose logic has been optimally structured to perform specific algorithmic functions. As machines become more complex, finding the best combination of machine structure and software language is more difficult. If we structure the machines to

easily interpret "plain English," then the machines may be limited by what can be said in English. A compromise between language simplicity and machine functionality is in order. The best compromise has yet to be determined.

RF sonar serves medical needs

During 1985 some of the key biological functions of astronauts aboard the U.S. Space Shuttle will be monitored by a process called *echography*. In this process, body functions are observed by radio frequency sonar operating in the 3 to 5 MHz region. A small antenna probe is used to illuminate the tissue at very low power, and the echo returns form a time-sequenced image of the tissue. The data is stored as real-time video, and can then be digitized and image-enhanced. Resolution is very good; images are formed at rates up to 50 per second, and time-motion analysis can be updated as often as 5000 times per second. This can give very detailed information about heart movement and the flow of blood through vital organs. (You fellows with 75-meter beams, please — no elevation rotators!)

synthetic rocks

Researchers in Australia have developed a synthetic rock material that may have important application in the disposal of radioactive material. Major problems involved in disposing of high-level radioactive waste include site safety, disintegration of surrounding material, and the ability of the

waste containers to remain intact for the required 10,000+ years. It's not too difficult to find geographical areas which can be extrapolated to remain stable for several hundred thousand years, but finding containers whose *atomic structure is not destroyed* by years of intense radiation has been an elusive process.

The newly developed "Synroc," as its developers call it, is made of three natural minerals whose atomic structure is such that high-level radiation converts the rock to a glassy material. The glassy material is atomically stable and resists cracking and subsequent leakage. The Los Alamos National laboratory is now evaluating the material by embedding high-level waste with a short half-life (less than a year) into the Synroc and then extrapolating the results. Considering the very long half-life of the more common waste, the validity of extrapolation will have to be shown. In any case, this may be a major development in what has otherwise been an unyielding problem.

GaAs high speed ICs make progress

Silicon semiconductor material has been the mainstay of the modern electronics industry for about 25 years. It has been continually improved and now offers good speed, high yields, and best of all, low cost. However, we are now pushing the limits of silicon physics and device geometry to get further improvements. Gallium Arsenide (GaAs) and an associated family of semiconductor materials



TUNE IN THE WORLD OF HAM-TV!

Hams should be "seen" as well as heard! Thousands of ATV operators across the country are sending great looking color TV pictures (with sound) to each other. FSTV-DX can go hundreds of miles. There are now over 80 Ham Television "Repeaters" relaying these video signals over rough terrain.

Ham Radio UHF-TV is as simple as hooking up a 2 meter rig and antenna. Our "Everything You Always Wanted To Know About ATV" 112-page manual will teach you how to do it (\$9.95).

✓ 208

Under the guidance of the "United States ATV Society," Amateur TV (FSTV-SSTV-FAX) is growing in activity. And, we've been promoting it now for over 18 years!

Sample Issue - Just \$2.50 ppd.

Special Trial Subscription - \$10.00.



(Published Monthly)
A5 ATV Magazine
P.O. Box H,
Lowden, Iowa
52255

A Division of
QCD Publications, Inc.



offer the higher speeds made possible by high electron mobilities. Microwave GaAs devices have been available for some time, but the price has been fairly high due to the higher material cost and poor yields. Obtaining flat, defect-free epitaxial wafers for the fabrication of GaAs ICs has been a very difficult and costly process.

However, new techniques permit material growth and processing with sufficient quality to permit small-scale integration on a commercial basis. Simple digital circuits containing tens of devices are available in the market, and arrays with a few hundred elements will be readily available during 1985. Work is progressing on very high-speed memories with cycle times of 500 picoseconds, and complex functional circuits with 1-GHz digital and 5-GHz analog circuits sharing the same real estate should be available in another year or two.

This next generation of circuit developments will offer yet another milestone in speed and capability in practically every domain of telecommunications. Amateurs have already seen the benefits of GaAs devices in low-noise VHF/UHF amplifiers, and will next see comparable performance in the signal processing sections of new radio equipment.

ham radio

MULTI-BAND TRAP ANTENNAS

Completely assembled & ready to use - Commercial quality, built to last - Lightweight, sealed, weatherproof traps - Automatic band switching - Low loss end insulators - Handles up to 2000 watts PEP - For all transmitters, receivers & transceivers - Tuner usually never required - Deluxe center insulator, with built in lightning arrester, accepts PL-259 coax connector - May be used as inverted "V" - Excellent for all class amateurs - Instructions included - 10 day money back guarantee!

4-Band-40, 20, 15, 10 meters (55') 2 traps #D42 \$55.95 PPD
5-Band-80, 40, 20, 15, 10 meters (105') 2 traps #D52 \$59.95 PPD

SHIPPED POSTPAID! READY TO USE!

90 ft. RG-58U, 52 ohm coax cable, with PL-259 connector on each end - Add \$12.00 to above price.

✓ 193

We accept VISA/MC-Give Card #, Exp. Date, Signature

SPI-RO DISTRIBUTORS

Room 103, P.O. Box 1538
Hendersonville, NC 28793



SYNTHESIZED SIGNAL GENERATOR

MADE IN USA



MODEL
SG-100F
\$429.95
delivered

- Covers 100 MHz to 199.999 MHz in 1 kHz steps with thumbwheel dial
- Accuracy +/- 1 part per 10 million at all frequencies
- Internal FM adjustable from 0 to 100 kHz at a 1 kHz rate
- External FM input accepts tones or voice
- Spurs and noise at least 60 dB below carrier
- Output adjustable from 5-500 mV at 50 Ohms
- Operates on 12 Vdc @ 1/2 Amp
- Available for immediate delivery • \$429.95 delivered
- Add-on accessories available to extend freq range, add infinite resolution, AM, and a precision 120 dB attenuator
- Call or write for details • Phone in your order for fast COD shipment.

✓ 197

VANGUARD LABS

196-23 Jamaica Ave., Hollis, NY 11423
Phone: (718) 468-2720 Mon. thru Thu.

2.3 GHz MICROWAVE EQUIPMENT

2.3 GHz LNA, 14 Db gain, 50 ohm (BNC). Input transistor typical NF: 2.6 Db
Requires +12 VDC, 3.5" x 2" x 1 25", without enclosure

RMLA-I \$36.00

2.3 GHz double balanced mixer, 50 ohm (BNC), 2.5" x 2.5" x 1", without enclosure

RMMX-I \$20.00

2.3-2.45 GHz voltage controlled oscillator, 10 MW output, Requires +12 VDC bias and -1 to -12 VDC tuning, 2.25" x 1 25" x 1", may be FM modulated with 8 ohm speaker as microphone

RMVO-II
\$35.00

Also Antennas, Mast Mountable VCO/antennas, Detectors, Signal Generators, Attenuators, and Line Stretchers.

ROENSCH MICROWAVE
R.R. 1, Box 156B,
BROOKFIELD, MISSOURI 64628 ✓ 183



SAY YOU SAW IT IN
ham radio magazine



A fresh idea!

Our new crop of tone equipment is the freshest thing growing in the encoder/decoder field today. All tones are instantly programmable by setting a dip switch; no counter is required. Frequency accuracy is astonishing ± 1 Hz over all temperature extremes. Multiple tone frequency operation is a snap since the dip switch may be removed. Our TS-32 encoder/decoder may be programmed for any of the 32 CTCSS tones. The SS-32 encode only model may be programmed for all 32 CTCSS tones plus 19 burst tones, 8 touch-tones, and 5 test tones. And, of course, there's no need to mention our one day delivery and one year warranty.

 **COMMUNICATIONS SPECIALISTS**

426 West Taft Avenue, Orange, California 92667
(800) 854-0547 / California: (714) 998-3021



✓ 210

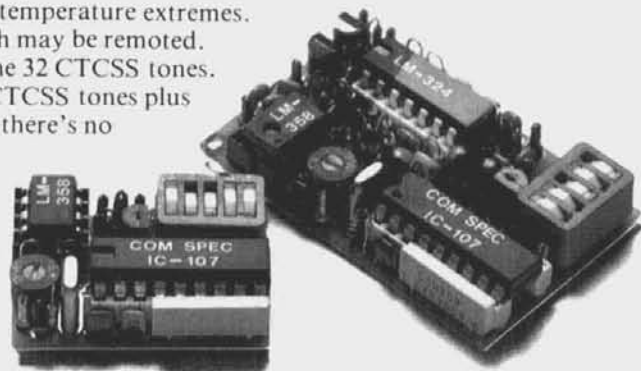

SS-32 \$29.95, TS-32 \$59.95



The DX is better out here. Ask anyone who owns an FT-726R.

It's true. Linking up to OSCAR 10 is the one sure way to bring the world into your ham shack. No matter where your shack is.

FT-726R owners know. You'll find them working the world from their apartments. Attics. And from their antenna-restricted neighborhoods.

They'll even boast of a signal quality and DX potential that would make any 20-meter operator envious. Regardless of where we are in the sunspot cycle.

In fact, the FT-726R is the world's most popular link to OSCAR 10.

And for good reason. This 2-meter, 10-watt rig gives you full cross-band duplex capability. Simply plug in two

optional modules, one for 435-MHz operation, another for cross-band duplex.

You can set up your earth station just about anywhere. All you need is the 726 and two Yagi antennas: 435-MHz for transmit and 2-meters for receive.

Even as a conventional base station, the FT-726R is a real standout.

You can choose from three operating modes: SSB, FM or CW. Expand to three-band operation with your choice of optional modules for 10 meters, 6 meters, 430-440 MHz and 440-450 MHz.

Then store your preferred frequencies and modes into the eleven memories for instant recall. With

pushbutton transfer capability to either of two VFO registers. And versatile scanning functions you'd expect from a Yaesu radio.

Plus you get a lot more extras, including a built-in speech processor, all-mode squelch and a noise blanker.

So no matter where your shack is, let Yaesu's FT-726R introduce you to OSCAR 10. The world is waiting.

YAESU

Yaesu Electronics Corporation
6851 Walthall Way, Paramount, CA 90723
(213) 633-4007

Yaesu Cincinnati Service Center
9070 Gold Park Drive, Hamilton, OH 45011
(513) 874-3100



KENWOOD

...pacesetter in Amateur radio

NEW!

“DX-cellence!”

TS-940S

The new TS-940S is a serious radio for the serious operator. Superb interference reduction circuits and high dynamic range receiver combine with superior transmitter design to give you no-nonsense, no compromise performance that gets your signals through! The exclusive multi-function LCD sub display graphically illustrates VBT, SSB slope, and other features.

- 100% duty cycle transmitter. Super efficient cooling system using special air ducting work with the internal heavy-duty power supply to allow continuous transmission at full power output for periods exceeding one hour.
- Programmable scanning.
- Semi or full break-in (QSK) CW.

- Low distortion transmitter. Kenwood's unique transmitter design delivers top "quality Kenwood" sound.
- Keyboard entry frequency selection. Operating frequencies may be directly entered into the TS-940S without using the VFO knob.
- Graphic display of operating features. Exclusive multi-function LCD sub-display panel shows VBT, SSB slope tuning, as well as frequency, time, and AT-940 antenna tuner status.
- QRM-fighting features. Remove "rotten QRM" with the SSB slope tuning, CW VBT, notch filter, AF tune, and CW pitch controls.

Optional accessories:

- AT-940 full range (160-10 m) automatic antenna tuner
- SP-940S external speaker with audio filtering
- YG-455C-1 (500 Hz), YG-455CN-1 (250 Hz), YK-88C-1 (500 Hz) CW filters;
- YK-88A-1 (6 kHz) AM filter
- VS-1 voice synthesizer
- SO-1 temperature compensated crystal oscillator
- MC-42S UP/DOWN hand mic.
- MC-60A, MC-80, MC-85 deluxe base station mics.
- PC-1A phone patch
- TL-922A linear amplifier
- SM-220 station monitor
- BS-8 pan display
- SW-200A and SW-2000 SWR and power meters.

9 40
on 21:00 off 0:00

SLOPE 1

V-B 21.250.00 US
V-A 14.200.01 US

ANTENNA TUNER
AUTO TUNE READY



- High stability, dual digital VFOs. An optical encoder and the flywheel VFO knob give the TS-940S a positive tuning "feel!"
- 40 memory channels. Mode and frequency may be stored in 4 groups of 10 channels each.
- General coverage receiver. Tunes from 150 kHz to 30 MHz.



More TS-940S information is available from authorized Kenwood dealers.

KENWOOD

TRIO-KENWOOD COMMUNICATIONS
1111 West Walnut Street
Compton, California 90220

Complete service manuals are available for all Trio-Kenwood transceivers and most accessories. Specifications and prices are subject to change without notice or obligation.