

new column —
Elmer's Notebook
by Tom McMullen, W1SL

ham radio magazine

compact cw transceiver for 20 meters



hrc

focus
on
communications
technology

NEW!



ICOM IC-761

A NEW ERA DAWNS

- **Built-in AC Power Supply**
- **Built-in Automatic Antenna Tuner**
- **SSB, CW, FM, AM, RTTY**
- **Direct Keyboard Entry**
- **160-10m/General Coverage Receiver**
- **Passband Tuning plus IF Shift**
- **QSK up to 60 WPM**

The IC-761 ushers in an exciting new era of amateur radio communications; an era filled with all the DX'ing, contesting, and multi-mode operating pleasures of a fresh new sunspot cycle. The innovative IC-761 includes all of today's most desired features in a single full-size cabinet. This is ham radio at its absolute best!

Work the World. The IC-761 gives you the competitive edge with standard features including a built-in AC power supply, automatic antenna tuner, 32 fully tunable memories, self-referencing SWR bridge, continuously variable RF output power to 100 watts in most modes, plus much, much more!

Superb Design, Uncompromised Quality. A 105dB dynamic range receiver features high RF sensitivity and steep skirted IF selectivity that cuts QRM like a knife. A 100% duty cycle transmitter includes a large heatsink and internal blower. The IC-761 transceiver is backed with a full one-year warranty and ICOM's dedicated customer service with four regional factory service centers. Your operating enjoyment is guaranteed!

All Bands, All Modes Included. Operates all HF bands, plus it includes general coverage reception from 100kHz to 30MHz. A top SSB, CW, FM, AM, and RTTY performer!

Passband Tuning and IF Shift plus tunable IF notch provide maximum operating flexibility on SSB, CW, and RTTY modes. Additional features include multiple front panel filter selection, RF speech processor, dual width and adjustable-level noise blanker, panel selectable low-noise RF preamp, programmable scanning, and all-mode squelch. The IC-761 is today's most advanced and elaborate transceiver!

Direct Frequency Entry Via Front Keyboard or enjoy the velvet-smooth tuning knob with its professional feel and rubberized grip.

Special CW Attractions include a built-in electronic keyer, semi or full break-in operation rated up to 60 WPM, CW narrow filters and adjustable sidetone.

Automatic Antenna Tuner covers 160-10 meters, matches 16-150 ohms and uses high speed circuits to follow rapid band shifts.

Complementing Accessories include the CI-V computer interface adapter, SM-10 graphic equalized mic, and an EX-310 voice synthesizer.

You're The Winner with the new era IC-761. See the biggest and best HF at your local ICOM dealer.

 **ICOM**
First in Communications

ICOM America, Inc., 2380-116th Ave. N.E., Bellevue, WA 98004 **Customer Service Hotline (206) 454-7619**
3150 Premier Drive, Suite 126, Irving, TX 75063 / 1777 Phoenix Parkway, Suite 201, Atlanta, GA 30349
ICOM CANADA, A Division of ICOM America, Inc., 3071 - #5 Road, Unit 9, Richmond, B.C. V6X 2T4 Canada

INTRODUCING

KPC-4 DUAL PORT

AVAILABLE NOW
KANTRONICS
KPC-4/KAM
2400 MODEM™
SOFTWARE ACCESSIBLE
SUGGESTED RETAIL \$69.96

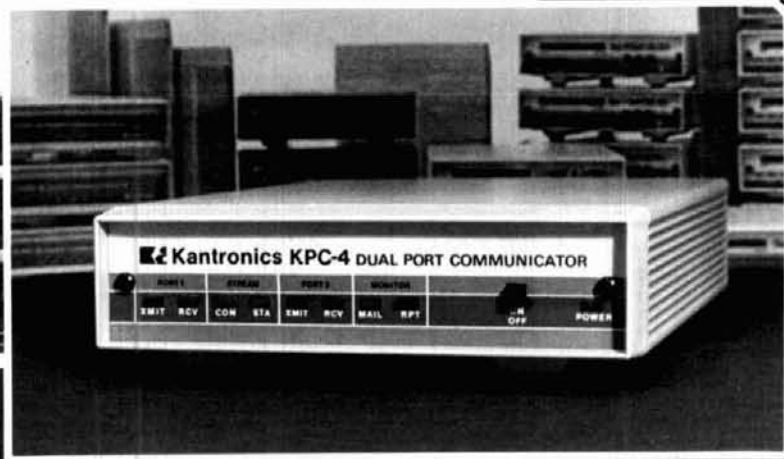

KPC-4 Gives Simultaneous Connects, Digipeating, and Gateway On Two VHF Radio Ports

KPC-4™ is your GATEWAY into VHF Packet flexibility. KPC-4 features **two fully functional packet ports**, digipeating on each port, VHF gateway between ports, and an RS-232 computer port.

What's more — digipeating and gateway operations occur simultaneously while you're connected on one or both ports.

KPC-4's RS-232/TTL terminal interfacing provides universal compatibility to all computers, including Commodores and PC compatibles. Stream switching provides for access to both radio ports, each of which

supports the ARRL adopted AX.25 protocol.

KPC-4 also contains the popular Personal Packet Mailbox™ feature, (optional on all other Kantronics Packet Communicators). You or others can leave and retrieve messages from the Personal Packet Mailbox.

Only KPC-4 lets you bridge two frequencies on one band, and operate crossband. For more information about KPC-4 Dual Port Communicator, contact Kantronics or your Kantronics dealer.

Suggested Retail \$329.00.

KPC-4 Dual Port Features

- Two simultaneous operable VHF radio ports, both ports operating at 1200 baud.
- Automatic gateway operation between ports.
- Command driven, like KPC-2 or KAM, with over 100 software commands.
- Kantronics Personal Packet Mailbox feature included.
- External modem connection point provided for future use.
- RS-232 or TTL level operation by jumper selection.
- 32K bytes RAM, 32K bytes EPROM, 512 bytes EEPROM, 63B03X processor.
- Kantronics' industry standard extruded aluminum case.
- ARRL adopted AX.25 protocol.
- FCC part 15 compliant.

Kantronics

RF Data Communications Specialists

1202 E. 23 Street Lawrence, Kansas 66046 (913) 842-7745

KENWOOD

Good
for Satellite
Digital QSOs

Matching Pair

Look for
FUJI
and
PHASE III-C

TS-711A/811A VHF/UHF all-mode base stations

The TS-711A 2 meter and the TS-811A 70 centimeter all mode transceivers are the perfect rigs for your VHF and UHF operations. Both rigs feature Kenwood's new Digital Code Squelch (DCS) signaling system. Together, they form the perfect "matching pair" for satellite operation.



- **Highly stable dual digital VFOs.** The 10 Hz step, dual digital VFOs offer excellent stability through the use of a TCXO (Temperature Compensated Crystal Oscillator).
- **Large fluorescent multi-function display.** Shows frequency, RIT shift, VFO A/B, SPLIT, ALERT, repeater offset, digital code, and memory channel.
- **40 multi-function memories.** Stores frequency, mode, repeater offset, and CTCSS tone. Memories are backed up with a built-in lithium battery.

- **Versatile scanning functions.** Programmable band and memory scan (with channel lock-out). "Center-stop" tuning on FM. An "alert" function lets you listen for activity on your priority channel while listening on another frequency. **A Kenwood exclusive!**
- **RF power output control.** Continuously adjustable from 2 to 25 watts.

- **Automatic mode selection.** You may select the mode manually using the front panel mode keys. Manual mode selection is verified in International Morse Code.
- **All-mode squelch.**
- **High performance noise blanker.**
- **Speech processor.** For maximum efficiency on SSB and FM.
- **IF shift.**
- **"Quick-Step" tuning.** Vary the tuning characteristics from "conventional VFO feel" to a stepping action.
- **Built-in AC power supply.** Operation on 12 volts DC is also possible.
- **Semi break-in CW, with side tone.**
- **VS-1 voice synthesizer (optional)** More TS-711A/811A information is available from authorized Kenwood dealers.



Optional accessories.

- IF-10A computer interface
- IF-232C level translator
- CD-10 call sign display
- SP-430 external speaker
- VS-1 voice synthesizer
- TU-5 CTCSS tone unit
- MB-430 mobile mount
- MC-60A, MC-80, MC-85 deluxe desk top microphones
- MC-48B 16-key DTMF, MC-43S UP/DOWN mobile hand microphones
- SW-200A/B SWR/power meters: SW-200A 1.8-150 MHz SW-200B 140-450 MHz
- SWT-1 2-m antenna tuner
- SWT-2 70-cm antenna tuner
- PG-2U DC power cable

Complete service manuals are available for all Trio-Kenwood transceivers and most accessories. Specifications and prices are subject to change without notice or obligation.

KENWOOD

KENWOOD U.S.A. CORPORATION
Communications & Test Equipment Group
2201 E. Dominguez St., Long Beach, CA 90810

ham radio

magazine

JUNE 1987

volume 20, number 6

T. H. Tenney, Jr., W1NLB
publisher

Rich Rosen, K2RR
editor-in-chief
and associate publisher

Dorothy Rosa, KA1LBO
managing editor

Tom McMullen, W1SL
Joseph J. Schroeder, W9JUV
Alfred Wilson, W6NIF
associate editors
Susan Shorrock
editorial production

editorial review board

Peter Bertini, K1ZJH
Forrest Gehrke, K2BT
Michael Gruchalla, P. E.
Bob Lewis, W2EBS
Mason Logan, K4MT
Vern Riportella, WA2LOQ
Ed Wetherhold, W3NQN

publishing staff

J. Craig Clark, Jr., N1ACH
assistant publisher

Rally Dennis, KA1JWF
director of advertising sales

Dorothy Sargent, KA1ZK
advertising production manager
Susan Shorrock
circulation manager
Therese Bourgault
circulation
Gary Samson,
cover photo

ham radio magazine is published monthly by
Communications Technology, Inc.
Greenville, New Hampshire 03048-0498
Telephone: 603-878-1441

subscription rates

United States:
one year, \$22.95; two years, \$38.95; three years, \$49.95
Canada and other countries (via surface mail):
one year, \$31.00; two years, \$55.00; three years, \$74.00
Europe, Japan, Africa (via Air Forwarding Service): one year, \$37.00
All subscription orders payable in U.S. funds, via international
postal money order or check drawn on U.S. bank

international subscription agents: page 91

Microfilm copies are available from
University Microfilms, International
Ann Arbor, Michigan 48106
Order publication number 3076

Cassette tapes of selected articles from *ham radio*
are available to the blind and physically handicapped
from Recorded Periodicals,
919 Walnut Street, Philadelphia, Pennsylvania 19107

Copyright 1987 by Communications Technology, Inc.
Title registered at U.S. Patent Office

Second class postage paid
at Greenville, New Hampshire 03048-0498
and at additional mailing offices
ISSN 0148-5989

Send change of address to *ham radio*
Greenville, New Hampshire 03048-0498

contents

- 8 compact 20-meter CW
travelradio**
Rick Littlefield, K1BQT
- 29 compact travel antenna**
Rick Littlefield, K1BQT
- 37 ham radio techniques:
time and frequency station WWVS**
Bill Orr, W6SAI
- 45 NBS survey**
- 53 the TEXNET packet-switching
network
part 3: software overview**
Thomas H. Aschenbrenner, WB5PUC,
and Thomas C. McDermott, N5EG,
Texas Packet Radio Society
- 69 practically speaking:
build your own
time-domain reflectometer**
Joe Carr, K4IPV
- 75 VHF/UHF world:
microwave portable operation**
Joe Reisert, W1JR
- 86 test DBMs for diode leakage**
Cliff Klinert, WB6BIH
- 95 NEW COLUMN:
elmer's notebook**
Tom McMullen, W1SL
- 98 advertisers index
and reader service**
- 6 comments**
- 66 DX forecaster**
- 92 flea market**
- 90 ham mart**
- 4 reflections**
- 26 short circuits**



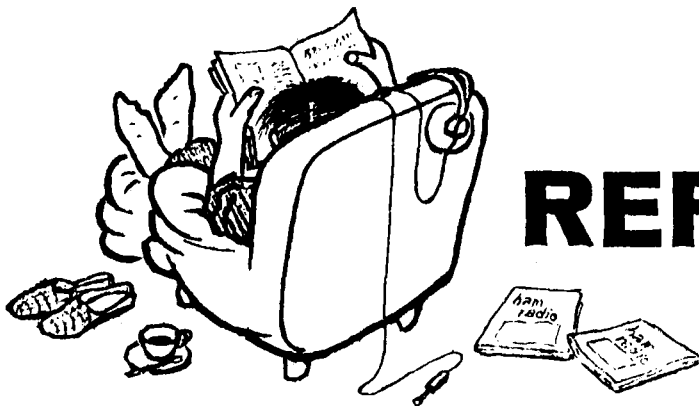

REFLECTIONS

a whole new generation of "designers"

I just read an honest, provocative article in the April, 1987 issue of *Folio*, a magazine for people who publish and produce magazines, about how some people expect to become editors and publishers simply by purchasing desktop publishing systems. In short, the author of that article said — and I fully agree — that a piece of equipment and some software do not an editor make.

I'm wondering if the same thing can be said about electrical circuit designers. Take a PC and any of your better interactive design software, be it for filters, amplifier stages, or receivers. Add some form of schematic capture capability — and voila! A full-fledged designer!

Well, maybe

Someone with reasonable intelligence (i.e., able to form cause-and-effect conclusions), when provided with a PC and some interactive software, will probably generate some pretty decent designs. You might even get those designs from him a lot faster than you'd get them from the generation of designers and engineers of which I consider myself a part.

For example, let's say you buy a relatively sophisticated piece of filter synthesis software with a well-thought-out, user-friendly, menu-driven program. A basic circuit is provided as part of a learning tutorial. Hit one of the function keys and the circuit response pops up on the screen, replete with MHz and dB. If the rejection or bandwidth or ripple isn't exactly what you want, back you go to the original menu; you simply turn the knob and *watch* the response take all different shapes.

Depending upon the sophistication of the software, you might have to do no more than enter your wish list; the computer will not only provide the circuit topology (after going through all the possible choices — Chebyshev, Butterworth, Elliptical, Gaussian, etc.) quietly and rapidly, but will determine the number of poles, matching sections, and component values as well. Of course, it's possible that your wish list will exceed even Fano's limitation (a fundamental mathematical relationship which says, in essence, that you can't get something for nothing). But then if the software is worth its salt, it will gently remind you that what you desire isn't exactly possible, and ask whether you might be willing to consider modifying the parameters to conform just a little bit more with reality.

Basically, then, what we have is a new generation of designers who don't necessarily need to rely on a storehouse of knowledge about resistors that *aren't*, coils that need to be "opened up" just a little more, box covers that *do* have an effect, and all other the peculiarities one can encounter in the analog world.

Though this makes me feel somewhat like a relic (I still enjoy "hands-on" designing), I suspect many of us older (read that "more mature") Radio Amateurs share the same feeling. However, in the case of circuit design software, I believe real progress has occurred: tools have been developed by the older generation that can be used by the younger generation to effect better and more efficient designs more quickly than ever before.

Rich Rosen, K2RR
Editor-in-Chief

KENWOOD

ALL NEW
FM mobile!

Here's One for You!

TM-221A/421A

2 m and 70 cm FM compact mobile transceivers

The all-new TM-221A and TM-421A FM transceivers represent the "New Generation" in Amateur radio equipment. The superior Kenwood GaAs FET front end receiver; reliable and clean RF amplifier circuits, and new features all add up to an outstanding value for mobile FM stations! The optional RC-10 handset/control unit is an exciting new accessory that will increase your mobile operating enjoyment!

- TM-221A provides 45 W. TM-421A is the first 35 W 70 cm mobile! Both models have adjustable 5 W low power.
- Selectable frequency steps for quick and easy QSY.

- TM-221A receives from 138-173.995 MHz. This includes the weather channels! Transmit range is 144-148 MHz. Modifiable for MARS and CAP operation. (MARS or CAP permit required.)
- The TM-421A covers 438-449.995 MHz. (Specifications guaranteed for Amateur band use only.)
- Built-in front panel selection of 38 CTCSS tones. TSU-5 programmable decoder optional.
- Simplified front panel controls makes operating a snap!
- 16 key DTMF hand mic., mic. hook, mounting bracket, and DC power cable included.
- Packet radio compatible!
- Kenwood non-volatile operating system. All functions remain intact even when lithium battery back-up fails. (Lithium cell memory back-up—est. life 5 yrs.)

- 14 full-function memory channels store frequency, repeater offset, sub-tone frequencies, and repeater reverse information. **Repeater offset on 2 m is automatically selected.** There are **two channels** for "odd split" operation.
- Programmable band scanning.
- Memory scan with memory channel lock-out.
- Super compact: approx. 1-1/2"Hx5-1/2"Wx7"D.
- New amber LCD display.
- Microphone test function on low power.
- High quality, top-mounted speaker.
- Rugged die-cast chassis and heat sink.

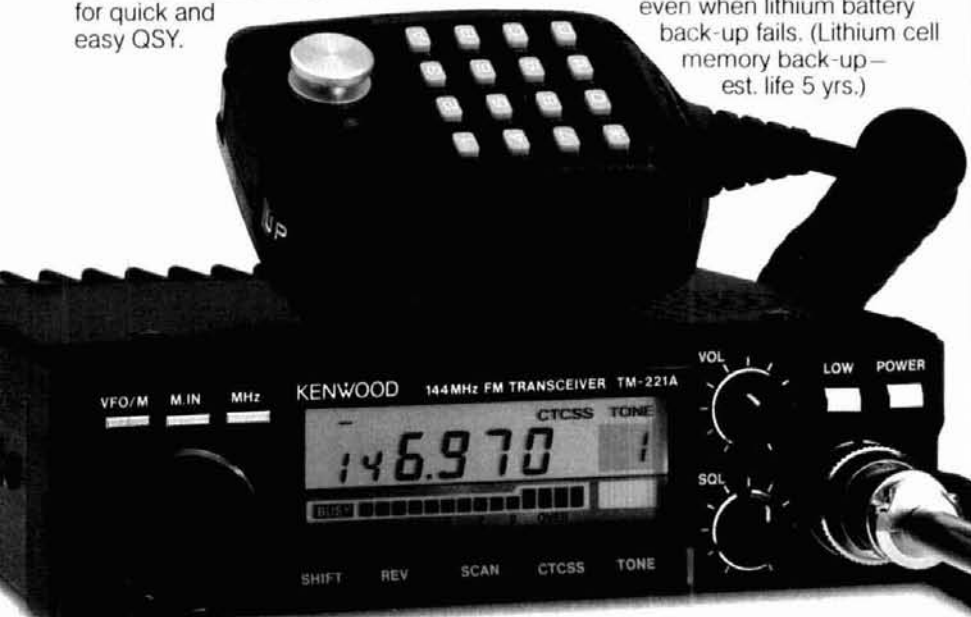

RC-10 Remote Controller

Optional telephone-style handset remote controller RC-10 is specially designed for mobile convenience and safety. All front panel controls (except DC power and RF output selection) are controllable from the RC-10. One RC-10 can be attached to **either or both** TM-221A and TM-421A with the optional PG-4G cable. When both transceivers are connected to the RC-10, **cross band, full duplex repeater** operation is possible. (A control operator is needed for repeater operation.)



Optional Accessories:

- RC-10 Multi-function handset remote controller
- PG-4G Extra control cable, allows TM-221A/TM-421A full duplex operation
- PS-50/PS-430 DC power supplies
- TSU-5 Programmable CTCSS decoder
- SW-100A Compact SWR/power/volt meter (1.8-150 MHz)
- SW-100B Compact SWR/power/volt meter (140-450 MHz)
- SW-200A SWR/power meter (1.8-150 MHz)
- SW-200B SWR/power meter (140-450 MHz)
- SWT-1 Compact 2 m antenna tuner (200 W PEP)
- SWT-2 Compact 70 cm antenna tuner (200 W PEP)
- SP-40 Compact mobile speaker
- SP-50B Mobile speaker
- PG-2N Extra DC cable
- PG-3B DC line noise filter
- MC-60A, MC-80, MC-85 Base station mics.
- MC-55 (8-pin) Mobile mic. with gooseneck and time-out timer
- MA-4000 Dual band antenna with duplexer (mount not supplied)
- MB-201 Extra mobile mount

Specifications and prices subject to change without notice or obligation
Complete service manuals are available for all Trio-Kenwood transceivers and most accessories

KENWOOD

KENWOOD U.S.A. CORPORATION
Communications & Test Equipment Group
2201E. Dominguez St., Long Beach, CA 90810

**THE
COMMITTEE
TO PRESERVE
RADIO VERIFICATIONS**

A COMMITTEE OF
THE ASSOCIATION OF NORTH AMERICAN RADIO CLUBS

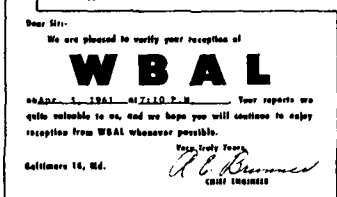
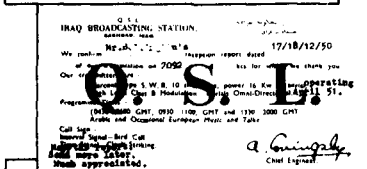
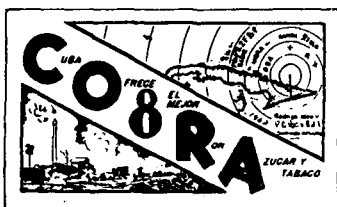

Many radio hobbyists have spent long hours building and enjoying their collections of QSL cards and verification letters. Unfortunately, few think about the long term importance of their collections.

The Committee To Preserve Radio Verifications is a five-person group whose goal is to preserve verifications belonging to hobbyists who are no longer active. Through direct contact with inactive listeners and the families of deceased hobbyists, and by a public information campaign, the committee seeks out existing QSL collections that might otherwise be lost and takes steps to preserve them.

If you are interested in donating your QSL collection to the committee or if you know of others who might be interested in the group's work, please contact:

JERRY BERG, Chairperson
38 Eastern Avenue
Lexington, MA 02173
(617) 861-8481

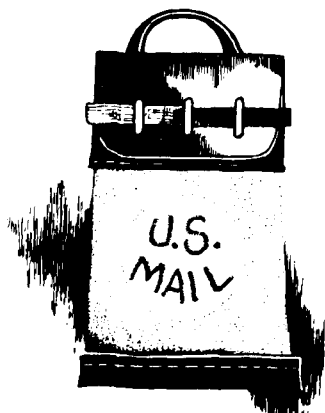

comments

groundplane antenna

Dear HR:

The original "groundplane antenna" was not developed by Brown, Epstein, and Lewis in the late 1930s, as generally published and last mentioned in *ham radio* ["The Offset Drooper — An Improved Gound Plane," by Woodrow Smith, W6BCX, February, 1986, page 43].

This VHF/UHF antenna was invented several years before in France by Maurice Ponte (French patent No. 764.473, 1933) with all the main items such as elevated feedpoint, coaxial feeding, and radials.

The "groundplane" for preventing undesired radiation from feedline was described either as a disk 1/2-wave in diameter or as a number of horizontal 1/4-wave radials.

This invention was also known and patented in the United Kingdom and in the United States (United Kingdom patent No. 414,296, applied for in 1934; United States patent No. 2,026,652, applied for in 1933 and granted in 1936).

Two remarkable early contributions to the groundplane antenna development should be noted: a base reactance compensation for reduction of amplitude and phase distortion for television application (Germany, 1936) and tuned radials, either with coiled conductors and series capacitances or with bent or encircled arms tunable for series resonance (United Kingdom, 1937/38).

This present information about the early history of groundplane, however, does not diminish the importance

of Dr. Brown's role as a great American inventor and antenna specialist. His remarkable works, known worldwide, include: *Earth Currents* (1933), *Turnstile* (1935), *Broadcast Antennas* (1935), *Multifrequency Antenna* (1936), *Ground Systems and Antenna Efficiency* (1937), *Directional Antennas* (1937), *Square Antenna* (1938), *Rotary Beam* (1940), *Collinear Antenna* (1941), *Duplex Balancer* (1942), and *RF Wattmeter* (1943).

Alois Krischke, DJ0TR/OE8AK
Munich, West Germany

kudos > kantronics

Dear HR:

With all of the less than desirable business practices going on in this world, it is with pleasure that I relate a good experience with you.

After purchasing a used Kantronics UTU Universal Terminal Unit, I discovered that there was a problem with "handshaking" between the UTU and the computer. After inserting a breakout box between the two, I found that the UTU was not sending a CTS (Clear To Send) signal to the computer. This prevented the computer from sending anything to the UTU, because as far as the computer was concerned, the UTU just wasn't ready.

I called Kantronics and spoke with their service technician, who informed me that I was using an older version of the firmware (version 1.0) and said that if I would give him my address, he would send me out the updated version (1.3). Although I informed him that I had purchased this unit used, he replied that it was company policy to correct any manufacturing errors. The replacement EPROM was received about four days later, and it works just fine.

Thus, in this day of the quick buck, it is a pleasure to announce to the world that there are still quality firms out there doing business. Please pass along the word, and send them more business!

Rick Mainhart, WB3EXR
Mystic, Connecticut 06355

New MFJ-1274 lets you work VHF and HF packet with built-in tuning indicator for \$169.95 . . .

. . . you get MFJ's latest clone of TAPR's TNC-2, TAPR's VHF/HF modem and built-in tuning indicator that features 20 LEDs for easy precise tuning

MFJ-1274
\$169⁹⁵

MFJ-1270
\$139⁹⁵



Now you can join the exciting world of packet radio on both VHF and HF bands with a precision tuning indicator . . . for an incredible \$169.95!

You get MFJ's top quality clone of the highly acclaimed industry standard TAPR TNC-2. We've made TAPR's modem selectable for both VHF and HF operation, added their precision 20 segment LED tuning indicator, a TTL serial port, an easily replaceable lithium battery for memory back-up and put it all in a new cabinet.

If you don't need the tuning indicator or the convenience of a switchable VHF/HF modem, choose the affordable MFJ-1270 for \$139.95.

All you need to operate packet radio is a MFJ-1274 or MFJ-1270, your rig, and any home computer with a RS-232 serial port and terminal program.

If you have a Commodore 64, 128, or VIC 20 you can use MFJ's optional Starter Pack to get on the air immediately. The Starter Pack includes interfacing cable, terminal software on disk or tape and complete instructions . . . everything you need to get on packet radio. Order MFJ-1282 (disk) or MFJ-1283 (tape), \$19.95.

Unlike machine specific TNCs you never have to worry about your MFJ-1274 or MFJ-1270 becoming obsolete because you change computers or because packet radio standards change. You can use any computer with an RS-232 serial port with an appropriate terminal program. If packet radio standards change, software updates will be made available as TAPR releases them.

Also speeds in excess of 56K bauds are possible with a suitable external modem! Try that with a

machine specific TNC or one without hardware HDLC as higher speeds come into widespread use.

You can also use the MFJ-1274 or MFJ-1270 as an excellent but inexpensive digipeater to link other packet stations.

Both feature AX.25 Level 2 Version 2 software, hardware HDLC for full duplex, true Data Carrier Detect for HF, multiple connects, 256K EPROM, 16K RAM (expandable to 32K with optional EPROM), simple operation, socketed ICs plus much more.

You get an easy-to-use manual, a cable to connect your transceiver (you have to add a connector for your particular radio), a connector for the TTL serial port and a power supply for 110 VAC operation (you can use 12 VDC for portable, remote or mobile operation).

Help make history! Join the packet radio revolution now and help spread this exciting network throughout the world. Order the top quality and affordable MFJ-1274 or MFJ-1270 today.



MFJ-1273, \$49.95

Now you can tune in HF, OSCAR and other non-FM packet stations fast!

This MFJ clone of the TAPR tuning indicator makes tuning natural and easy - it shows you which direction to tune. All you have to do is to center a single LED and you're precisely tuned in to within 10 Hz. 20 LEDs give high resolution and wide frequency coverage.

The MFJ-1273 tuning indicator plugs into the MFJ-1270 and all TNC-1s, TNC-2s and clones that have the TAPR tuning indicator connector.

Order any product from MFJ and try it - no obligation. If not satisfied return within 30 days for prompt refund (less shipping).

• One year unconditional guarantee • Add \$5.00 each shipping/handling • Call or write for free catalog, over 100 products.

MFJ

MFJ ENTERPRISES, INC.
Box 494, Miss. State, MS 39762

To Order or for Your Nearest Dealer
800-647-1800

Call 601-323-5869 in Miss. and outside continental USA.
Telex 53-4590 MFJ STKV



a compact 20-meter CW transceiver

Pack a private DX-pedition
in a very small bag

DX-ing from another part of the world is something most of us would like to try, but packing those extra suitcases full of equipment can take much of the joy out of traveling. My solution to this problem was to choose a favorable band and mode, and then design a super-compact station that would slip into my suitcase without displacing more essential items. I settled on the 20-meter band because it's open most of the time, and because portable antennas for that band are easy to pack and erect. I chose CW because it provides the best opportunity for reliable long-range communications on low power.

The *CW Travelradio*, described in this article, is what resulted. The entire package measures 1.5 x 4.5 x 6.0 inches and weighs just 1.5 pounds. The receiver is a conventional superhet with AGC and a switchable CW audio-bandpass filter; the choice of speaker or headphone operation is yours. The transmitter delivers 12 to 15 watts to the antenna, and features sidetone and semi-break-in. The VFO range covers the bottom 100 kHz of the band, where virtually all CW and most RTTY operation takes place.

circuit description

To expedite the design, I reworked board art from an existing 1-watt SSB exciter to make a basic transceiver circuit board. I then designed a control board to provide shaped keying, semi-break-in T/R switching, and sidetone generation. I completed the package by adding a simple two-stage audio-bandpass CW filter and a 15-watt class C PA.

The receiver is an updated version of previously published designs.^{1,2} Double-balanced mixer U1 (see fig.

1) amplifies and converts 14-MHz signals to 9 MHz, which are filtered through FL-1 and fed to i-f amplifier U2. The gain of U2 is controlled by an audio-derived AGC. U3 is a DBM product detector. U4 amplifies received signals and sidetone to speaker level, and provides AGC drive to dc amplifier circuit Q1, Q2. U4 runs at full gain, with speaker and headphone volume controlled "downstream" via R1. This arrangement permits full AGC action at all gain control settings.

Transmit mixer U5 combines BFO and VFO drive to produce a 14-MHz output. This stage is keyed via Q8 (see fig. 2). Harmonics and other unwanted products are removed by the bandpass filter at L3, L4. Broadband amplifier Q6 then boosts the filtered signal to drive FET driver stage Q7. This stage operates in class AB, and delivers about 0.7 watts at the output of a 50-ohm Pi-network. If desired, a simple class-C configuration using a bipolar device could be substituted without major disruption to the circuit board.

Q11 is a broadbanded class-C PA (see fig. 3) that delivers 12 to 15 watts output into 50 ohms. A five-section half-wave filter suppresses harmonics, and an adjustable diode detector provides a dc signal for metering rf output.

VFO Q4 tunes from 5.0 MHz to 5.1 MHz to cover the bottom 100 kHz of the band. Source-follower Q5 isolates the VFO and provides a low impedance drive to the mixers. BFO Q3 utilizes diode-switched capacitance in series with Y1 to provide a 700-Hz offset during transmit.

The CW control module provides three functions. Q8, the dc switch, simultaneously activates the transmit mixer, sidetone oscillator, and relay driver when the key is depressed. An RC input circuit shapes rise time, which in turn softens the CW wavefront and prevents key-clicks.³ Twin-T oscillator Q9 generates a 700-Hz sidetone, which is fed to audio amplifier U4 during transmit.⁴ Relays K1 and K2 are controlled by

Rick Littlefield, K1BQT, Box 114, Barrington, New Hampshire 03825



The 20-meter sub-compact QRP transceiver has most of the features of a full-sized radio, yet occupies very little space.

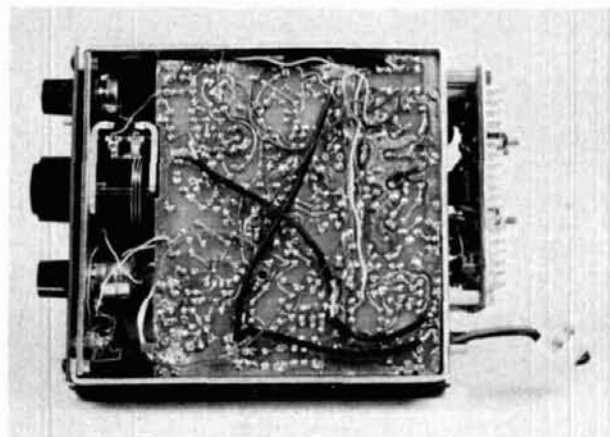

Main board is mounted about 1/4 inch above the bottom of the frame to allow space for wires and parts mounted on the bottom of the board.

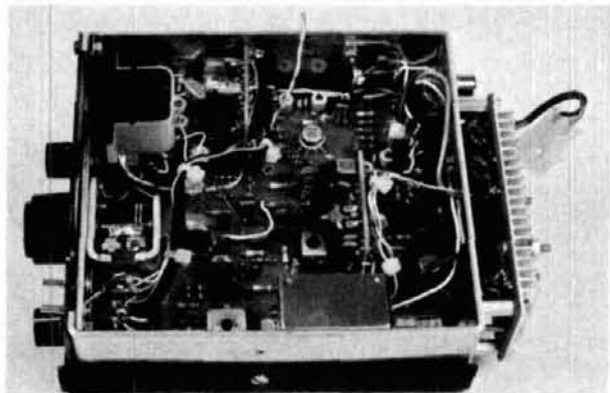

The CW control module and CW filter are mounted onto the main board with stiff buss wire. FL1 is epoxied to side panel. The power amplifier is mounted externally on the back panel to reduce heating of internal circuitry during transmit.

GLB PACKET RADIO GOES PORTABLE

THE FIRST CONTROLLER DESIGNED FOR PORTABLE AND SOLAR-POWERED STATIONS



- LOW 25 mA Current Drain.
- Miniature size - Lightweight.
- Rugged metal, shielded case.
- Lithium Battery backup for RAM.
- Onboard Watchdog for reliability.
- Standard DB25 Connectors.
- "Connected" Status output line.
- Remote Commands in Unattended Mode with Hardware Lockout.
- Retains all other PK-1 features.
- Extra I/O lines for special applications.

NEW SOFTWARE FEATURE:
INTELLIGENT "BUDLIST" - Provides selective callsign filtering for Digipeating, Monitoring and Connecting.

Model PK1-L
Wired/Tested
List price—\$209.95
Amateur net—\$179.95

Power requirement: 9 to 15 Volts DC @ 25 mA typical
Dimensions: 4.6 X 5.9 X 1.0 inches **Total Weight:** 12 ozs.

Please specify Call Sign, SSID Number, and Node Number when ordering.
Contact GLB for additional info and available options.
We offer a complete line of transmitters and receivers, strips, preselector preamps, CWID'ers & synthesizers for amateur & commercial use.
Request our FREE catalog. MC & Visa welcome.

180

GLB ELECTRONICS, INC.

151 Commerce Pkwy., Buffalo, NY 14224 716-675-6740 9 to 4

AMATEUR TELEVISION

NEW 70 CM ATV TRANSCEIVER

ALL YOU NEED IN ONE BOX



\$299 delivered
TC70-1

- **FULL COLOR, SOUND, & LIVE ACTION** just like broadcast TV. Get on this exciting amateur video mode at our affordable ready to go price.
- **WHAT IS REQUIRED FOR A COMPLETE OPERATING SYSTEM?** The TC70-1s downconverter outputs to any TV on ch 3 for receiving. Connect a good 70 cm antenna and low loss coax. Plug in any composite video source you want to transmit: Camera, VCR, computer, etc. Plug in any low Z dynamic mic or use color camera mic for Standard 4.5 MHz TV sound. Connect to 13.8 vdc for base, mobile, or portable. See chapt. 20 1985 ARRL Handbook. That's it!
- **WHAT CAN YOU DO WITH THE TC70-1 ATV TRANCEIVER?** Show the shack, projects, computer program listings, home video tapes, repeat Space Shuttle audio and video if you have a TVRO, repeat SSTV or RTTY, Weather Radar, do public service events such as parades, marathons, races, CAP searches and rescues... the list goes on. DX depends on antennas and terrain, typically 1 to 40 miles. We have video compensated RF linear amps for 20 (\$119) or 50 (\$189) watts pep for greater DX.
- **FEATURES:** Small 7x7x2.5". Push to Look (PTL) T/R switching. GaAsfet downconverter tunes whole 420-450 MHz band. Two switch selected video & audio inputs. ... RCA phone jacks and 10 pin color camera jack. Xmit video monitor output. Over 1 watt pep RF output on one or two (add \$15) selected crystal controlled frequencies. 439.25, 434.0, or 426.25 MHz.

CALL OR WRITE FOR OUR CATALOG for more info or who is on in your area. We stock antennas, modules, and everything you need on ATV.

TERMS: Visa, MC, or cash only UPS CODs by phone or mail. Checks must clear bank before shipment. Price includes UPS surface shipping in cont. USA, others add 3%. Transmitting equipment sold only to licensed Tech class or higher amateurs, verifiable in 1985 call book or copy of new license.

(818) 447-4565 m-f 8am-6pm pst.

P.C. ELECTRONICS
Tom W6ORG Maryann WB6YSS

 
2522 Paxson Lane
Arcadia CA 91006

Wide Dynamic Range and Low Distortion – The Key to Superior HF Data Communications

- Dynamic Range > 75 dB
- 400 to 4000 Hz
- BW Matched to Baud Rate
- BER < 1×10^{-5} for S/N = 0 dB
- 10 to 1200 Baud
- Linear Phase Filters



ST-8000 HF Modem

Real HF radio teleprinter signals exhibit heavy fading and distortion, requirements that cannot be measured by standard constant amplitude BER and distortion test procedures. In designing the ST-8000, HAL has gone the extra step beyond traditional test and design. Our noise floor is at -65 dBm, not at -30 dBm as on other units, an extra 35 dB gain margin to handle fading. Filters in the ST-8000 are all of linear-phase design to give minimum pulse

distortion, not sharp-skirted filters with high phase distortion. All signal processing is done at the input tone frequency; heterodyning is NOT used. This avoids distortion due to frequency conversion or introduced by abnormally high or low filter Q's. Bandwidths of the input, Mark/Space channels, and post-detection filters are all computed and set for the baud rate you select, from 10 to 1200 baud. Other standard features of the ST-8000 include:

- 8 Programmable Memories
- Set frequencies in 1 Hz steps
- Adjustable Print Squelch
- Phase-continuous TX Tones
- Split or Transceive TX/RX
- CRT Tuning Indicator
- RS-232C, MIL-188C, or TTL Data
- 8, 600, or 10K Audio Input
- Signal Regeneration
- Variable Threshold Diversity
- RS-232 Remote Control I/O
- 100-130/200-250 VAC, 44-440 Hz
- AM or FM Signal Processing
- 32 steps of M/S filter BW
- Mark or Space-Only Detection
- Digital Multipath Correction
- FDX or HDX with Echo
- Spectra-Tune and X-Y Display
- Transmitter PIT Relay
- 8 or 600 Ohm Audio Output
- Code and Speed Conversion
- Signal Amplitude Squelch
- Receive Clock Recovery
- 3.5" High Rack Mounting

Write or call for complete ST-8000 specifications.



HAL Communications Corp.

Government Products Division
Post Office Box 365
Urbana, Illinois 61801
(217) 367-7373 TWX 910-245-0784

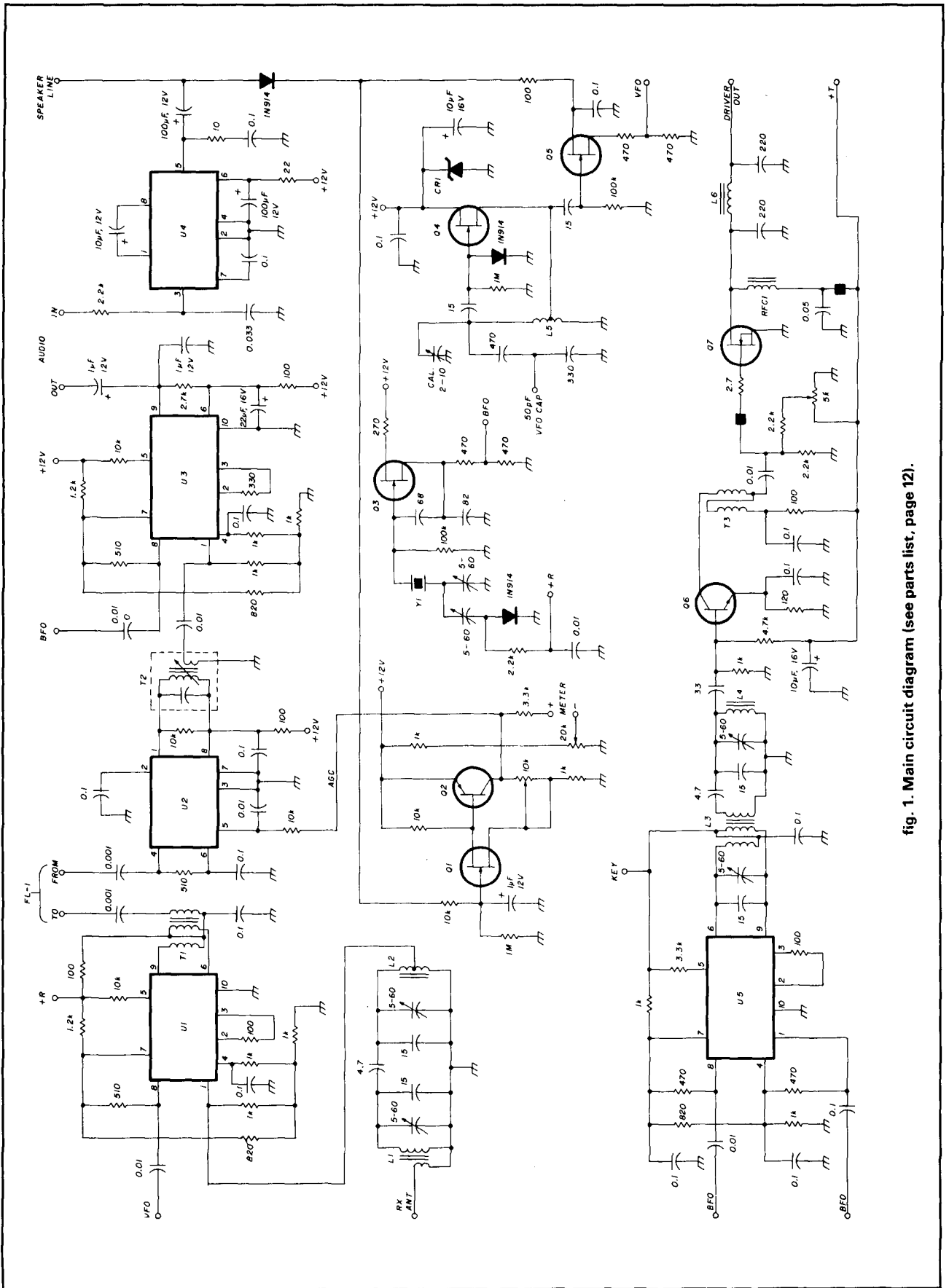

fig. 1. Main circuit diagram (see parts list, page 12).

coaxial R. F. antenna switches

Heavy Duty switch for true
1 Kw POWER - 2 Kw P.E.P.



Single Pole, 3 Position.
Desk or wall mount
All unused positions grounded
593 - UHF connectors / **\$27.25***
596 - BNC connectors / **\$36.50***

2 Pole, 2 Position, bypasses,
linears, reflectometers, antenna
tuners, etc.
#594 - UHF connectors / **\$34.25***

Single Pole, 5 Position, all unused
positions grounded.
#595 - UHF connectors / **\$32.00***
#597 - BNC connectors / **\$46.50***

* Shipping and handling for any
item add \$2 each.

ALL OUR PRODUCTS MADE IN USA



BARKER & WILLIAMSON

Quality Communication Products Since 1932

At your Distributors write or call

10 Canal Street, Bristol PA 19007

(215) 788-5581



I/O FOR REAL WORLD CONTROL



\$199.95 CALL OR WRITE FOR
MORE INFORMATION

MODEL
CIP/35A
SHOWN
WITHOUT
COVER

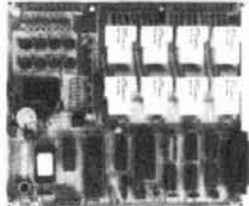

**NOW ANY PERSONAL
COMPUTER CAN HAVE THE
MOST COST EFFECTIVE
AND VERSATILE I/O BOARD
ON THE MARKET TODAY!**

- Serial Link Interface RS-232 or TTL
- 8 Relay Outputs, High Current AC/DC Form A & C
- 8 Opto-Isolated Inputs Plus 8 Bit Counter
- 8 Bit A/D with Span Adjust 0 to 5V. Provisions for up to 8 Input Channels
- EASILY Programmed & Controlled Using BASIC Statements
- Perfect for Lab Work, Machine Control, Security Systems, & Data Acquisition
- Unprecedented Usability as Attested by University, Government & Industrial Users
- Complete Documentation with Software Examples & Total Engineering Support

• IBM • HP • RADIO SHACK • COMMODORE *

* ALL REGISTERED TRADEMARKS

SIAS Engineering, Inc.

831 S. POWERS RD. / SALINA, KS 67401 / (913) 823-9209

Ferrite beads	FB43-101
FL1	9-MHz crystal filter, Showa SF0922B or equivalent
L1	20 turns No. 26 on T37-2, 2-turn link
L2	20 turns No. 26 on T37-2; tap at 10 turns
L3	10 turns No. 28 trifilar wound on T37-2
L4	20 turns No. 26 on T37-2
L5	36 turns No. 32 on 1/4-inch form; tap at 9 turns, enclose in 1/2 x 1/2 x 3/4-inch shielded can
L6	12 turns No. 24 on T37-2, spread to occupy 80 percent of form length
Q1, Q3, Q4, Q5	MPF102
Q2	2N3906
Q6	2N2222A
Q7	DV-1201K (M/A-COM, 1742 Crenshaw Blvd., Torrance, CA 90501)
T1	10 turns No. 28 trifilar wound on FT37-43
T2	10.7 MHz output transformer, green core
T3	10 turns No. 26 bifilar wound on FT37-61
U1, U3, U5	MC1496G
U2	MC1350P
U4	LM386
VFO	50 pF, 6:1 reduction drive
capacitor	8998.5-kHz crystal, series resonant
Y1	Zener, 9 volts @ 400 mA
Z1	

switching FET Q10. Delay time is set via an adjustable RC circuit on the gate of Q10.

CW filter U6 is a two-stage audio-bandpass CW filter (see fig. 4) built around a dual op-amp. This is a simplified version of a popular three-stage design.⁵ With the values shown, center frequency was measured at 720 Hz. A response curve is shown in fig. 5.

Finally, U7 is a monolithic 12-volt regulator that protects and stabilizes voltage to all stages except the PA (see fig. 6). All T/R switching is handled by miniature DPDT relays K1 and K2. An extra set of contacts is available for switching an external amplifier.

construction

Space is limited, so choosing small components is important. All four boards were designed to accommodate 1/4-watt resistors, low-voltage ceramic or monolithic caps, tantalum dips, miniature vertical trim-pots, and miniature trimmers. Attempting to substitute larger devices will quickly result in overcrowding.

Monolithic capacitors were used in most frequency-critical rf circuits. Silver mica or high quality NPO ceramic devices can be substituted in most cases, as

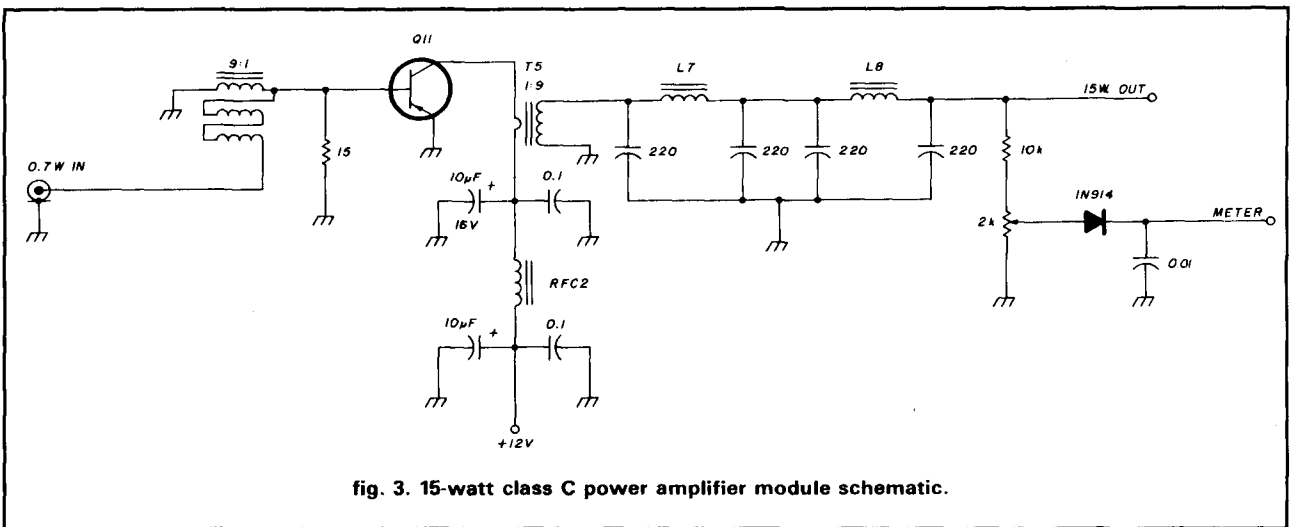
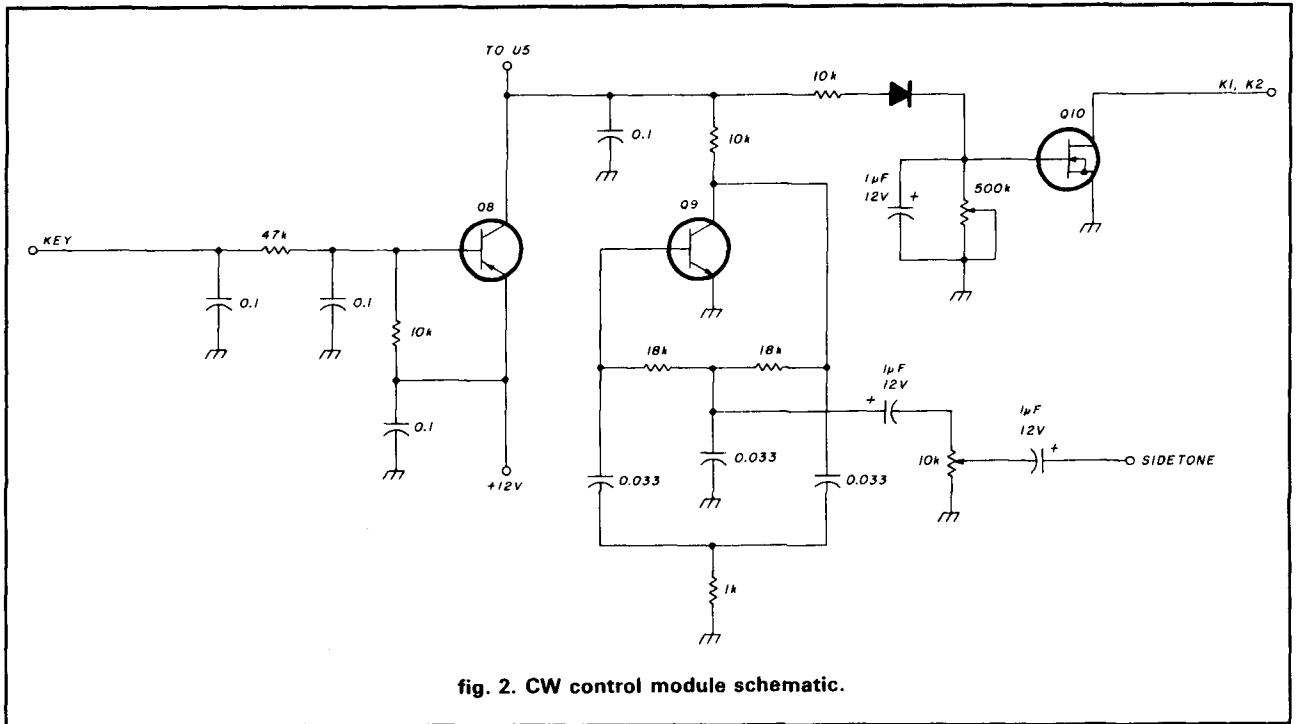

long as they're within 5 percent of specified values. While polystyrene capacitors are typically specified for frequency-critical elements in audio oscillators and active filters, monolithics are much smaller and seem to work just as well. To ensure accuracy, I matched active filter values carefully with a capacitance meter. Finally, I recommend using flexible small diameter wire and lavalier microphone cable for jumpers and interconnections. Harnessing leads together will reduce the chance of breakage. A complete kit and most of the individual parts are available from Radiokit.*

The parts layout for the main board is shown in **fig.**

7. It's generally easier to mount low-profile components (such as resistors, capacitors, and ICs) first, saving taller items (like trim pots and inductors) for last. FT-type toroid cores should be coated with clear nail polish before winding to prevent damage to enameled wire insulation. Toroids and chokes should be installed last and glued in place to prevent movement and lead breakage. When all parts and wires are installed on the top side, refer to **fig. 8** and complete the bottom side.

*For details, contact Radiokit, Box 973, Pelham, New Hampshire 03076.



HAM RADIO OUTLET

LARGEST HAM OUTLET IN THE WORLD

OUR COMMITMENT TO YOU IS
QUALITY, ACTION & SERVICE.

7 STORE BUYING POWER

KENWOOD TS-940S



TOP-OF-THE LINE
HF TRANSCEIVER

GREAT PRICE, CALL

KENWOOD TM-3530A



The First Comprehensive
220 MHz FM Transceiver.

ARE YOU READY FOR
220 MHz OPERATION?



MA-40
40' TUBULAR TOWER
\$745 SALE! \$549

MA-550
55' TUBULAR TOWER
\$1245 SALE! \$899
• Handles 10 sq. ft. at 50 mph
• Pleases neighbors with
tubular streamlined look

TX-455
55' FREESTANDING
CRANK-UP
• Handles 18 sq. ft. at 50 mph
• No guying required
• Extra-strength Construction
• Can add raising and motor
drive accessories



Shown with optional
MARB motor base

IN STOCK FOR QUICK DELIVERY
OTHER MODELS AT GREAT PRICES

KENWOOD R-5000



High Performance Receiver

- Covers 100 kHz - 30 MHz in 30 bands
- Superior dynamic range
- Computer control option

LOW PRICE!



FT-727R

5w, Dual Band

2m/440 MHz

Enhanced
Version

GREAT PRICE!



Alpha Delta Model DELTA-4

Lightning Surge Protected
4-Position RF Coax Switch

- Exclusive center "off" (ground) position.
- Uses ceramic Arc-Plug® protector.
- Micro-strip circuitry—no wafer switch.



Model DELTA-4
(UHF Connectors) \$69.95

Model DELTA-4/N
(N-type Connectors) \$89.95

HAM RADIO HOME STUDY NOVICE VOICE COURSE



- Updated novice-voice questions
- 6 stereo code & theory cassette tapes
- 2 text books, code oscillator, key & battery
- Color Ham Bands wall chart & frequency list
- Sealed novice exam for a Ham friend to give you the code & theory test in your home
- FCC license application forms & instructions to your examiner. Ideal for spouse & the kids!

\$49.95



30w in, 160w out,
with low-noise
preamp!

MODEL
2M30-160P
for 2 meters
SALE!

\$219.95

From the Originator of the
QUALITY VHF AMP/PREAMP COMBO!

Full Line Now Includes
UHF Models with
GaAs FET PREAMP!



FREE
SHIPMENT
Most items UPS
surface

All Major Brands in Stock Now!

CALL TOLL FREE (800) 854-6046



Toll free including Hawaii. Phone Hrs. 7:00 am to 5:30 p.m. Pacific Time. California, Arizona and Georgia customers call or visit nearest store. California, Arizona and Georgia residents please add sales tax. Prices, specifications, descriptions subject to change without notice.



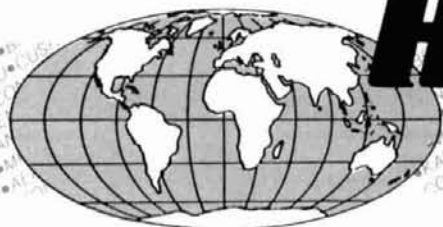

HAM RADIO OUTLET

LARGEST HAM OUTLET IN THE WORLD

FULL LINE OF ACCESSORIES IN STOCK.

7 STORE BUYING POWER

ICOM IC-761



HF SUPERIOR GRADE TRANSCEIVER

SALE! CALL FOR PRICE

ICOM IC-275A/275H



138 - 174 MHz
IC-275A (25w) IC-275H (100w)

GREAT PRICE!

ICOM IC-1271A



1.2 GHz Transceiver:
The First Full-featured
1240-1300 MHz Transceiver

ARE YOU READY FOR
1.2 GHz OPERATION?

ICOM IC-28A/28H



2-METER MOBILES
IC-28A (25w) IC-28H (45w)

LOW PRICE!

NOW! RAPID DELIVERIES

COAST TO COAST

FROM STORE NEAREST YOU

ICOM HAND-HELD VHF/UHF



IC-02AT IC-2AT 2MTR
IC-03AT IC-3AT 220 MHz
IC-04AT IC-4AT 440 MHz

ICOM IC-735



The Latest in ICOM's Long
Line of HF Transceivers

CALL FOR LOW, LOW PRICE

ICOM IC-R7000



25 MHz-1300 MHz

IN STOCK FOR
IMMEDIATE DELIVERY

ICOM IC- μ 2A/ μ 2AT

Mini
Hand-Held
AT Model
w/ TT Pad

GREAT
PRICE!



All Major Brands in Stock Now!



Bob Ferrero W6RJ
President
Jim Rafferty N6RJ
VP So. Calif Div.
Anaheim Mgr.

ANAHEIM, CA 92801

2620 W. La Palma
(714) 761-3033, (213) 860-2040
Between Disneyland &
Knotts Berry Farm

ATLANTA, GA 30340

6071 Buford Hwy
(404) 263-0700
Neil, Mgr. KC4MJ
Doraville, 1 mi. north of I-285

BURLINGAME, CA 94010

999 Howard Ave.
(415) 342-5757
George, Mgr. WB6DSV
5 miles south on 101 from SFO

OAKLAND, CA 94606

2210 Livingston St.
(415) 534-5757
Al, Mgr. WA6SYK
17N-5th Ave./17S-16th Ave.

PHOENIX, AZ 85015

1702 W. Camelback Rd.
(602) 242-3515
Bob, K7RDH
East of Hwy. 17

SAN DIEGO, CA 92123

5375 Kearny Villa Rd.
(619) 560-4900
Tom, Mgr. KM6K
Hwy. 163 & Claremont Mesa Blvd.

VAN NUYS, CA 91411

6265 Sepulveda Blvd.
(818) 988-2212
Al, Mgr. K6YRA
San Diego Fwy
at Victory Blvd.

STORE HOURS
10 AM-5:30 PM
CLOSED SUNDAYS



CALL TOLL FREE (800) 854-6046

Toll free including Hawaii. Phone Hrs: 7:00 am to 5:30 p.m. Pacific Time. California, Arizona and Georgia customers call or visit nearest store. California, Arizona and Georgia residents please add sales tax. Prices, specifications, descriptions subject to change without notice.





Cards and plaque courtesy W6TC

EIMAC's new DX champion! The 3CX800A7.

Varian EIMAC continues to commit its development of reliable tubes for HAM radio.

The new, rugged 3CX800A7 power triode provides 2 kW PEP input for voice service or 1 kW cw rating up to 30 MHz. Two tubes will meet the new, higher power ratings authorized by the FCC.

Designed for today's low profile, compact linear amplifiers, the 3CX800A7 powerhouse is only

2½ inches (6.35 cm) high. Cooling requirements are modest and a matching socket, air chimney and anode clamp are available.

A data sheet and more information is available from Varian EIMAC. Or the nearest Electron Device Group sales office. Call or write today.

Varian EIMAC
301 Industrial Way
San Carlos, California 94270
Telephone: 415-592-1221



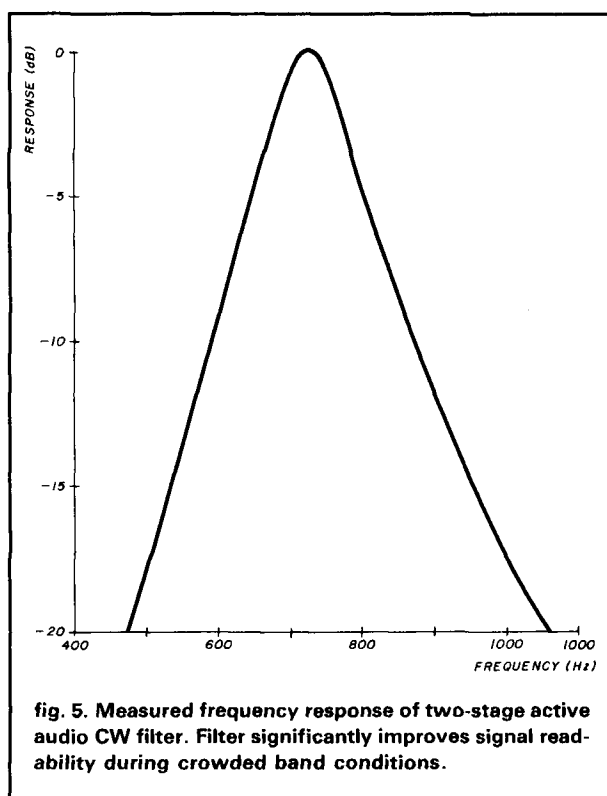
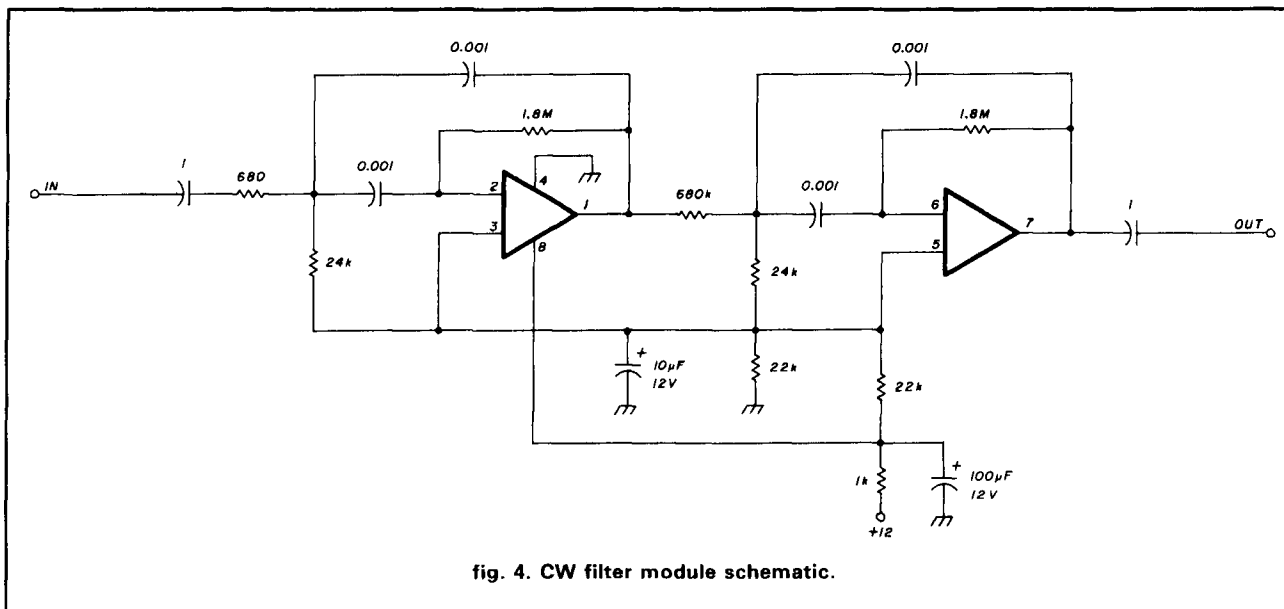

Construct the control module **fig. 9**, and the CW filter module **fig. 10** in similar fashion. Solder all power and signal leads to the foil side of these boards.

The PA circuit board is mounted onto the PA heat-sink before construction (foil side up). All components are mounted stripline-style by soldering them directly to the tracks (**fig. 11**). Note that a rectangular hole is cut in the board to accommodate mounting the PA

transistor directly to the heatsink. Since the MRF479 is an emitter-tab device, no insulating washer is used between the tab and ground.⁶

packaging

I packaged my transceiver in an open frame cabinet similar to what many commercial equipment manufacturers use. Mounting tabs for the main board were made by tacking solder lugs onto the foil, then fastening them onto the frame with No. 4-40 screws. The CW control board and CW filter modules were mounted into the main board with stiff bus wires. Crystal filter FL1, relay K2, and the meter are held in position with contact cement. Voltage regulator U7 is fastened to the frame with No. 4-40 hardware. The PA is mounted to the outside of the back panel with 3/4-inch spacers. This approach keeps circuit board and chassis wiring very accessible, and reduces the box size to a bare minimum. However, packaging is tight, and a cabinet of this type requires a metal shop and a fair amount of care to construct.

Since layout isn't very critical, the transceiver can be constructed in any convenient case — as long as a few basics are taken into account to ensure VFO stability. I recommend keeping the PA module on the outside of the case to reduce interior temperature fluctuations during transmit. Also, make sure all external VFO components are securely mounted and connected with short, rigid leads. Finally, route interstage wiring well away from VFO components. Mounted in a Hammond cast aluminum case, with a portable VCR battery, this rig would make an extremely tough and self-contained communications package for rough-and-tumble DX enthusiasts!

Once the packaging is done, and all interconnec-

WELCOME—
NOVICES

Call for Special
Prices on
220 MHz
Radios &
Antennas

MA.

TEL-COM[★]

Electronic Communications

NEW ENGLAND'S FACTORY-
AUTHORIZED SALES & SERVICE
FOR

KENWOOD  **ICOM**

Also displaying the popular accessories needed to complete a HAM STATION . . .

- ARRL PUBLICATIONS • AEA PRODUCTS • AMPHENOL
- ALPHA DELTA • ASTRON • AUSTIN ANTENNAS • AVANTI
- BELDEN • BENCHER • B & W • DAIWA • ALINCO
- HUSTLER • KLM • LARSEN • MIRAGE • ROHN
- TELEX/HY-GAIN • TOKYO HY-POWER LABS
- TRAC KEYERS • VIBROPLEX • WELZ • ETC.

✓ 172

SONY

Models 2010 & 2002

RECEIVERS

\$329.00 & \$249.00

OPEN SIX DAYS A WEEK

Telephone 617/486-3400, 3040

675 Great Rd., (Rte. 119) Littleton, MA 01460

1 1/4 miles from Rte. 495 (Exit 31) toward Groton, Mass.

NEMAL ELECTRONICS

HARDLINE — 50 OHM

Nemal No.	Description	Per Ft.
FXA12	1/2" Aluminum Black Jacket	89
FLC12	1/2" Cor. Copper Blk. Jkt.	1.59
FLC78	7/8" Cor. Copper	3.92
NM12AL	N Conn., 1/2" Alum. (Male or Female)	22.00
NM12CC	N Conn., 1/2" Copper (Male or Female)	22.00
NM78CC	N Conn., 7/8" Copper (Male or Female)	54.00

COAXIAL CABLES

Nemal No.	Description	100 Ft.	Per Ft.
1100	RG 8 95% Shielded Mil. Spec.	28.00	32
1102	RG8 95% Shielded Foam	30.00	32
1110	RG8X 95% Shield (mini 8)	15.00	17
1130	RG213/U Mil. Spec. 96% Shield	34.00	36
1140	RG214/U Mil. Spec. - Dbl. Silver	155.00	1.65
1180	Belden 9913 Low Loss	46.00	50
1705	RG142B/U Teflon/Silver	140.00	1.50
1310	RG217/U 5/8" 50 ohm Dbl. Shield	80.00	85
1470	RG223/U Mil. Spec. Dbl. Silver	80.00	85
1450	RG174 95% Shielded Mil. Spec.	12.00	14

ROTOR CABLE — 8 COND.

Nemal No.	Description	100 Ft.	Per Ft.
8C1822	2-18 Ga., 6-22 Ga.	19.00	21
8C1620	2-16 Ga., 6-20 Ga. Heavy Duty	34.00	36

* Shipping \$3.00 — 100 Ft. / Conn \$3.00 / C.O.D. \$2.00

CONNECTORS — MADE IN U.S.A.

Nemal No.	Description	Each
NE720	Type N for Belden 9913	4.25
NE723	N Female Belden 9913	4.75
PL258AM	Amphenol Barrel	1.45
PL259	Standard Plug for RG8, 213	10/5.90 or 65
PL259AM	Amphenol PL259	10/7.90 or 89
PL259TS	PL259 Teflon/Silver	1.59
UG21D	Type N for RG8, 213, 214	3.00
UG83B	N Female to PL259	6.50
UG88C	BNC RG58	1.25
UG146	SO239 to Male N	6.50
UG175/6	Adapter for RG58/59 (specify)	10/2.00 or 22
UG255	SO239 to BNC Amphenol	3.75
KAS1-18	TNC RG58	4.35
AM9501-1	SMA RG142B	8.95
SO239AM	Amphenol SO239	89

GROUND STRAP — BRAID

Nemal No.	Description	Per Ft.
GS38	3/8" Tinned Copper	30
GS12	1/2" Tinned Copper	40
GS316	3/16" Tinned Copper	15
GS316S	3/16" Silver Plated	35

GROUND WIRE — STRANDED

Nemal No.	Description	Per Ft.
HW06	6 Ga. insulated stranded	35

Call or write for complete price list. Nemal's 32-page Cable & Connector Selection Guide is available at no charge with orders of \$50.00 or more, or at a cost of \$4.00 individually.

NEMAL ELECTRONICS, INC.
12240 N.E. 14 Ave., No. Miami, FL 33161

(305) 893-3924 • Telex 6975377
24-Hr. FAX (305) 895-8178

✓ 173

ARE YOUR REPEATER OR
OTHER AUDIO LEVELS

UP AND down ?

TRY THE AGC-4!

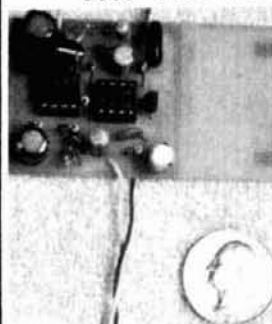

- DYNAMIC RANGE OF \approx 45dB
- OUTPUT CONSTANT \pm 2dB
- SINGLE VOLTAGE \geq 9VDC

KIT - \$28.00 PPD IN US/CANADA
BARRETT ELEC. - 525N 2150W
WEST POINT, UTAH 84015

✓ 184

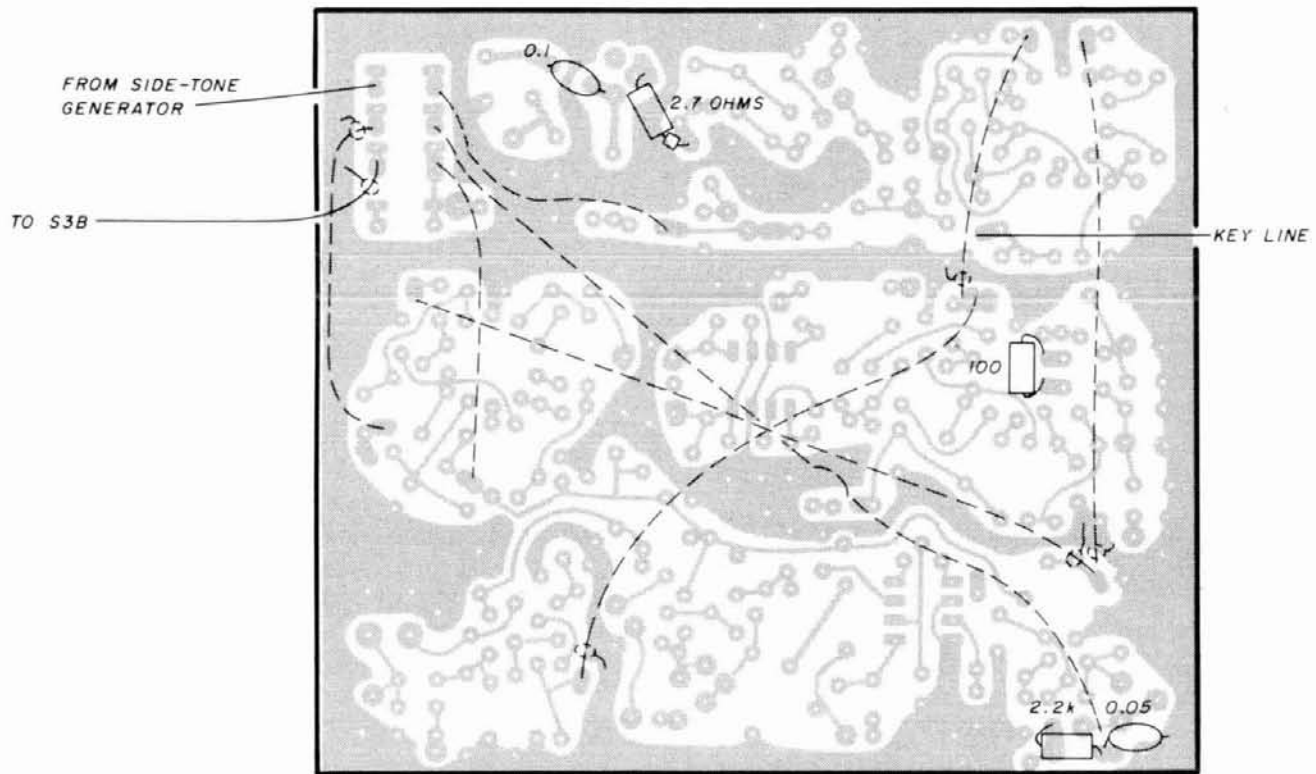

fig. 8. Wiring placement guide for main transceiver board.

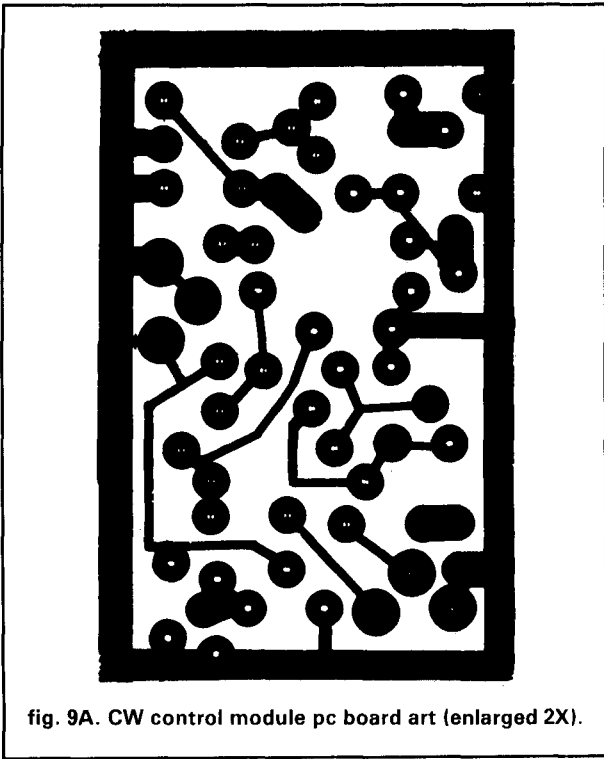

fig. 9A. CW control module pc board art (enlarged 2X).

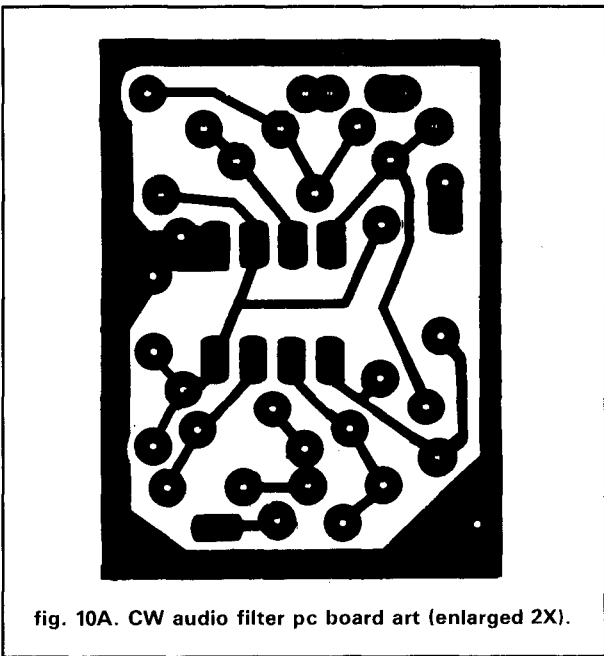

fig. 10A. CW audio filter pc board art (enlarged 2X).

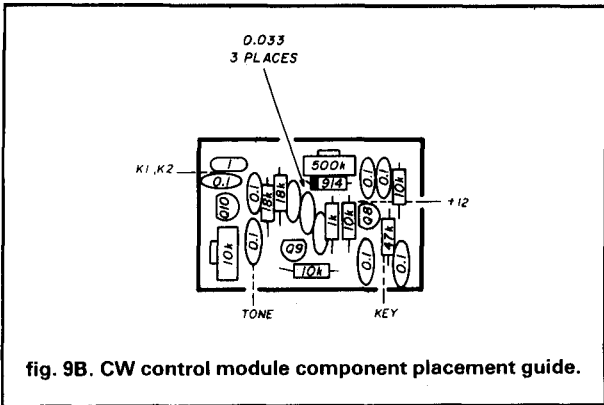

fig. 9B. CW control module component placement guide.

properly. Operation from a standard 12-volt battery may require regulating the main board at 10 volts with an adjustable device such as the LM317.

tune-up

The transceiver is easy to align (fig. 12). First, make sure both oscillators are functioning properly. Then monitor VFO output with a frequency counter or all-band receiver, and net VFO tuning into the 5.0 to 5.1 MHz range. Large adjustments may require substitut-

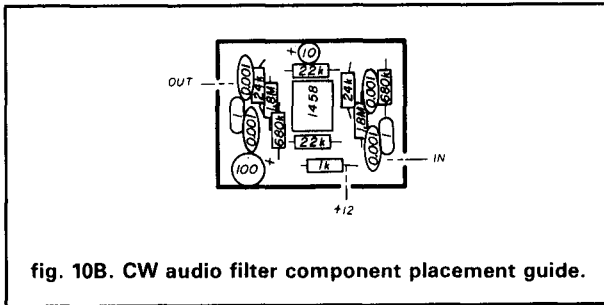

fig. 10B. CW audio filter component placement guide.

tions are made (fig. 6), it's time to double-check the wiring and connect a power supply. I use a compact 13.8-volt supply that's capable of supplying 2.5 amps for intermittent periods. Although this supply is regulated, I added 2000 μ F to the output circuit to help the regulator track the current surge as the transmitter is keyed. Note that the transceiver's voltage regulator needs a supply voltage of at least 13 volts to function

ing fixed-value capacitors (the VFO calibration trimmer has a range of about 50 kHz). Once the VFO tunes properly, the dial can be calibrated.

Next, monitor BFO output and set up BFO trimmers. When correctly adjusted, frequency on receive will be 8998.5 kHz (with +12 volts applied to the switching diode), and 8999.2 kHz on transmit (voltage removed from the switching diode). This provides a standard 700-Hz transmit offset. Since the two trimmers interact, some retuning will be necessary.

To set up the receiver section, first adjust AGC bias to 5 volts as measured at test point No. 1; then zero the S-meter. Tune T2 for maximum background noise in the speaker. Finally, peak both receiver bandpass filter trimmers for maximum sensitivity at 14.050 MHz (make sure there are two signal peaks per revolution).

Next, connect a power meter and dummy load to the transceiver output. To set a sidetone level, depress

THE MOST AFFORDABLE REPEATER

ALSO HAS THE MOST IMPRESSIVE PERFORMANCE FEATURES (AND GIVES THEM TO YOU AS STANDARD EQUIPMENT!)

BAND	WIRED	KIT
6M, 2M, 220 UHF	\$880	\$630
	\$980	\$730

(Also available for commercial bands!)



FEATURES:

- **SENSITIVITY SECOND TO NONE!** 0.15uV Typ.
- **SELECTIVITY THAT CAN'T BE BEAT!** Both 8 pole xtal filter & ceramic filter for > 100dB at ± 12kHz. Helical resonator front end to combat desense & intermod.
- **Flutter-proof squelch.** Automatic frequency control, separate spkr amplifier.
- **CLEAN, EASY-TUNE TRANSMITTER.** up to 20W output. 50W with additional PA.

ACCESSORIES

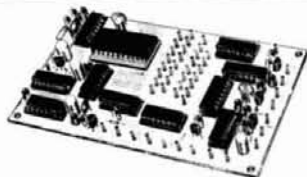

- **TD-2 DTMF DECODER/CONTROLLER** kit only \$78. Full 16 digits, 5 functions, toll call restrictor, programmable. Much more. Great for selective calling too!
- **AP-1 AUTOPATCH** kit only \$78. Reverse patch & phone line remote control std.
- **AP-2 Simplex Autopatch.** Use with above.

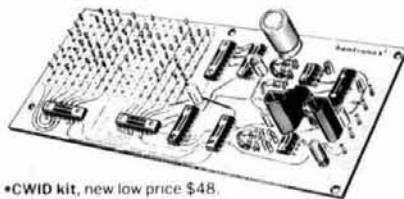

- **CWID kit,** new low price \$48. Field programmable, timers, the works!
- **COR-2 kit,** \$38. Audio mixer, local spkr amplifier, tail & time-out timers.
- **COR-3 kit,** \$48, with courtesy beep.

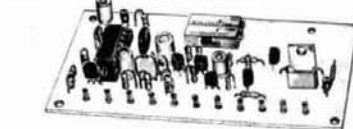

- **MO-202 FSK DATA MODULATOR** kit \$38. Run up to 1200 baud digital or packet radio signals through any FM transmitter.
- **DE-202 FSK DATA DEMODULATOR** kit \$38.

GaAs FET PREAMPS at a fraction of the cost of comparable units!

LNG -(*) GaAs FET PREAMP

ONLY \$49!
WIRED/TESTED



FEATURES:

- **Very Low Noise:** 0.7dB VHF, 0.8dB UHF
 - **High Gain:** 13-20dB, depending on freq
 - **Wide Dynamic Range:** to resist overload
 - **Stable:** new-type dual-gate GaAs FET
- * Specify tuning range desired: 26-30, 46-56, 137-150, 150-172, 210-230, 400-470, or 800-960 MHz.

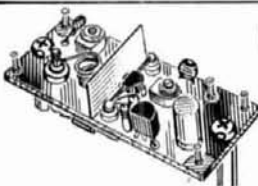

LNW -(*) MINIATURE GaAs FET PREAMP

Unbelievably Low Price ---
ONLY \$19/kit,
\$34 Wired/tested

GaAs FET Preamp similar to LNG, except designed for **low cost & small size.** Only 5/8"W x 1-5/8"L x 3/4"H. Easily mounts in many radios.

* Specify tuning range desired: 25-35, 35-55, 55-90, 90-120, 120-150, 150-200, 200-270, or 400-500 MHz.

LNS-(*)

IN-LINE PREAMP

ONLY \$59/kit,
\$79 wired/tested



GaAs FET Preamp with features similar to LNG series, except **automatically switches out of line during transmit.** Use with base or mobile transceivers up to 25W. **Tower mtg. hardware supplied.**

* Specify tuning range desired: 120-175, 200-240, or 400-500 MHz.

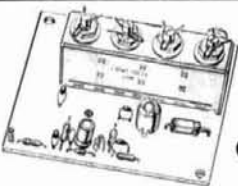

HRA -(*)

HELICAL RESONATOR PREAMP

ONLY \$49 VHF
or \$64 UHF

Low-noise preamps with helical resonators **reduce intermod & cross-band** interference in critical applications.

* Specify tuning range desired: 143-150, 150-158, 158-162, 162-174, 213-233, 420-450, 450-465, or 465-475 MHz.

HIGH QUALITY XMTR & RCVR MODULES FOR REPEATERS, LINKS, TELEMETRY, ETC.

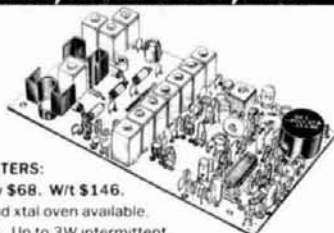

FM EXCITERS:

- Kits only \$68. W/t \$146. TCXO and xtal oven available. 2W cont. Up to 3W intermittent.
 - **TA51 for 10M, 6M, 2M, 150-174, 220 MHz.**
 - **TA451 for uhf.**
- FCC TYPE ACCEPTED FOR COMMERCIAL BANDS.
- **VHF & UHF LINEAR AMPLIFIERS.** For FM or SSB. Power levels from 10 to 45 Watts. Several models, kits starting at \$78.

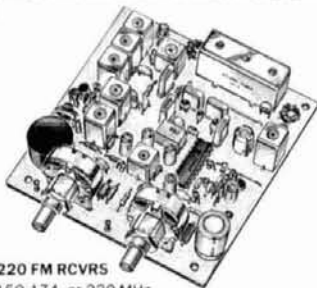

R144/R220 FM RCVRS

- for 2M, 150-174, or 220 MHz. 0.15uV sens, 8-pole xtal & 10 pole ceramic i-f filters, helical resonator front end for exceptional selectivity, > 100dB at ± 12kHz (best available anywhere!) Flutter-proof squelch, AFC tracks drifting xmtrs. Xtal oven avail. Kit \$138, w/t \$198.
- **R451 FM RCVR.** Same as above but UHF. Tuned line front end. 0.2uV sensitivity. Kit only \$138, w/t \$198.
- **R76 VHF FM RCVR** for 10M, 6M, 2M, 220. As above, but w/o AFC or hel res. Kits only \$98 to \$118.
- **R110 VHF AM RCVR** for VHF aircraft or ham bands or UHF. Kit only \$98.

NOW—FCC TYPE ACCEPTED TRANSMITTERS, RECEIVERS, AND REPEATERS AVAILABLE FOR HIGH-BAND AND UHF. CALL FOR DETAILS.

RECEIVING CONVERTERS

VHF MODELS	Antenna Input Range	Receiver Output
Kit with Case \$49	28-32	144-148
Kit less Case \$39	50-52	28-30
Wired w/case \$69	90-94	144-148
	144-146	28-30
	145-147	28-30
	144-144.4	27-27.4
	146-148	28-30
	220-222	28-30
	220-224	50-54
	222-224	28-30
UHF MODELS	432-434	28-30
Kit with Case \$59	435-437	28-30
Kit less Case \$49	432-436	144-148
Wired w/case \$75	432-436	50-54
	439-25	61-25
	902-928	422-448
	902-922	430-450

TRANSMIT CONVERTERS

For SSB, CW, ATV, FM, etc. Can be linked with receive conv for transceiver. 1 to 2 W out. Linear PA's available up to 50W.	For VHF Model XV2 Kit \$79 Wired \$149 (specify band)	Exciter Input Range	Antenna Output
		28-30	144-146
		28-30	145-148
		28-30	50-52
		27-27.4	144-144.4
		28-30	220-222
		50-54	220-224
		144-146	50-52
		144-148	28-30
	For UHF Model XV4 Kit \$79 Wired \$139	28-30	432-434
		28-30	435-437
		61-25	439-25
		144-148	432-436

HAMTRONICS, INC.

65-E Moul Rd.; Hilton NY 14468-9535

High quality equipment at reasonable prices surely appeals to me; but I want more details before I buy! Rush my copy of the 40-page Hamtronics catalog by return first class mail. I enclose \$1 (\$2 for overseas air mail).

Name _____
Address _____
City _____ State/ZIP _____

- Order by phone or mail • Add \$3 S&H per order (Electronic answering service evenings & weekends)
- Use VISA, MASTERCARD, Check, or UPS COD.

hamtronics, inc.

65-E MOUL ROAD • HILTON NY 14468-9535

Phone: 716-392-9430

Hamtronics® is a registered trademark

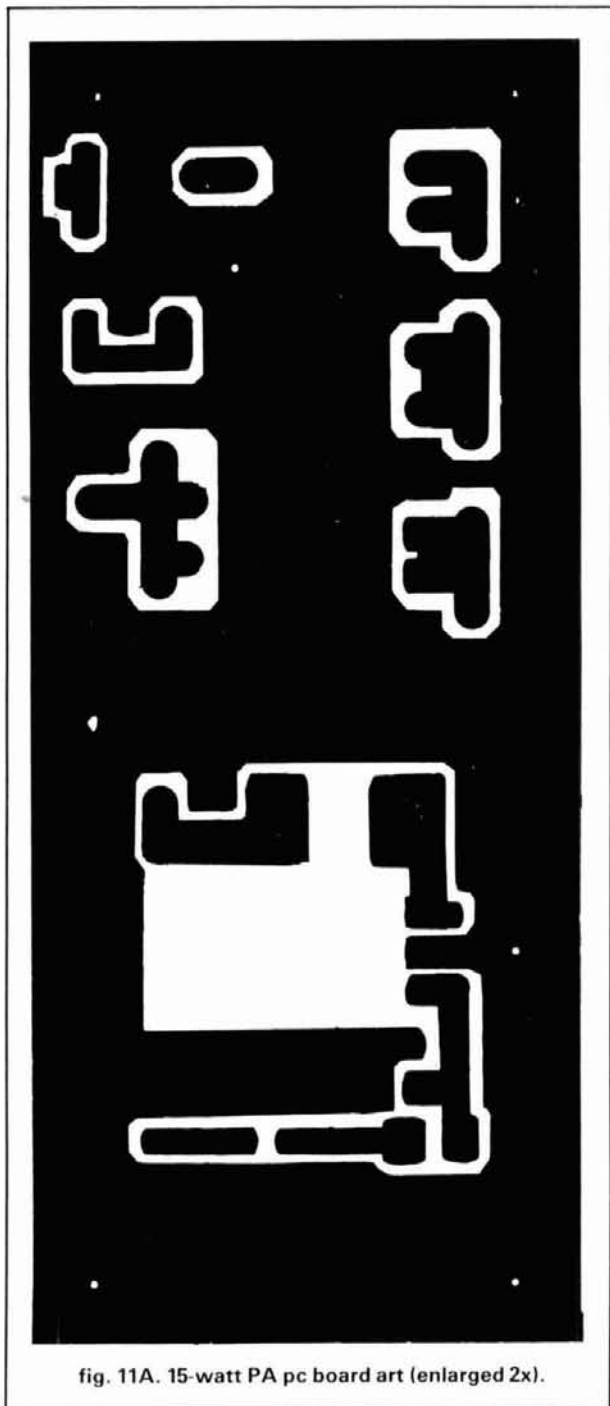

fig. 11A. 15-watt PA pc board art (enlarged 2x).

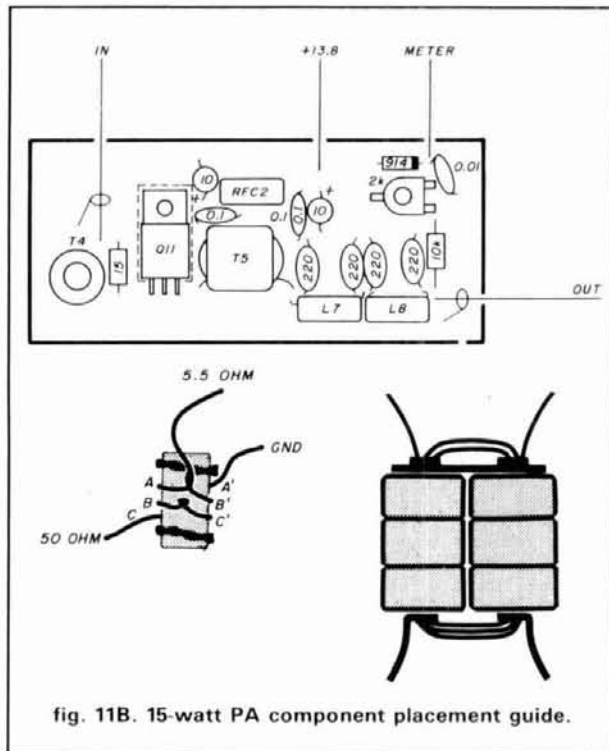

fig. 11B. 15-watt PA component placement guide.

the key and adjust the sidetone trimmer for a reading of S9 on the S-meter. Then key the transmitter and peak transmit bandpass filter trimmers for maximum output. Use a nonmetallic tuning tool; one trimmer is part of a balanced circuit, and will be detuned by a metallic blade. Finally, key the transmitter and set the bias of driver Q7 to 3 volts. Measure bias voltage at test point No. 2 with a high-impedance voltmeter.

The PA is broadbanded and requires no tuning. With a supply voltage of 13.8 volts, the indicated out-

put should be between 12 and 15 watts into a 50-ohm load. Set the rf meter's sensitivity by adjusting the 2-k rf meter trimmer on the PA board for a 3/4-scale reading. The semi-break-in delay trimmer can now be adjusted to suit sending speed and operating style.

All that remains is to connect an antenna and try your luck. Antenna SWR should normally be held below 2:1 with solid-state rigs, and this one's no exception. However, momentary accidents do happen, and my MRF479 PA has survived several with no damage. The rf meter can help you avoid trouble; it will read excessively high or low when a serious mismatch is present.

conclusion

As I called my first CQ, I wondered if 15 watts into a dipole would cut the mustard. After all, 20 is a popular band, and finding a clear spot to operate can be difficult. My fears were quickly dispelled when a UQ2 came back and gave me a 579. Several more DX contacts followed — all with good reports. I quickly discovered that 15 watts was enough power to work almost anything I could hear, including ZLs and VKs. That reliability, along with "extras" like the CW filter, a smooth sidetone note, and semi-break-in, make this rig fun to operate. Now, all I *really* need is the proper test platform from which to field-test the transceiver's portable capability. A large schooner — something with two masts headed for a tropical island — would be just right!

**TE
SYSTEMS****RF POWER AMPLIFIERS**

- Lowest NF GaAs FET Preamp
- Finest Quality Military Construction
- Off-The-Shelf Dealer Delivery



For the past five years, Amateurs worldwide have sought quality amplifier products from TE Systems. Renowned for the incorporation of high quality, low-noise GaAs FET preamplifiers in RF power amplifiers, TE Systems offers our fine line of products through select national distributors.

All amplifiers are linear (all-mode), automatic T/R switching with adjustable delay and usable with drive levels as low as 1/2 Watt. We incorporate thermal shutdown protection and have remote control capability. All units are designed to ICAS ratings and meet FCC part 97 regulations. Approx. size is 2.8 x 5.8 x 10.5" and weight is 5 lbs.

Consult your local dealer or send directly for further product information.

**TE
SYSTEMS**

TE SYSTEMS
P.O. Box 25845
Los Angeles, CA 90025
(213) 478-0591

SPECIFICATIONS

Model	Freq. MHz	Power Input	Power Output	Preamp NF-dB	Preamp Gain-dB	DC +Vdc	Power A	RF Conn.
0508G	50-54	1	170	.6	15	13.6	28	UHF
0510G	50-54	10	170	.6	15	13.6	25	UHF
1409G	144-148	3	160	.6	15	13.6	25	UHF
1410G	144-148	10	160	.6	15	13.6	25	UHF
1412G	144-148	30	160	.6	15	13.6	20	UHF
2210G	220-225	10	130	.7	12	13.6	21	UHF
2212G	220-225	30	130	.7	12	13.6	16	UHF
4410G	420-450	10	100	1.1	12	13.6	19	N
4412G	420-450	30	100	1.1	12	13.6	19	N

Models also available without GaAs FET preamp (delete G suffix on model #). All units cover full amateur band - specify 10 MHz bandwidth for 420-450 MHz amplifier.

Amplifier capabilities: 100-200 MHz, 225-400 MHz, 1-2 GHz, Military (28V), Commercial, etc. also available - consult factory.



188

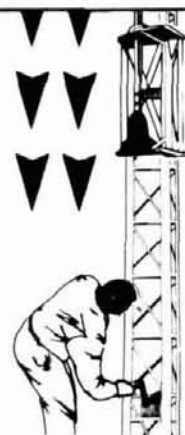

**SAVE
TIME
and
MONEY
with
THE
HAZER**

✓ 190

**Bring things down for
safety and convenience.**

Never climb your tower again with this elevator system. Antennas and rotator mount on HAZER, complete system trams tower in verticle upright position. Safety/lock system operates while raising or lowering. Never can fall.

Complete kit includes winch, 100 ft. of cable, hardware and instructions. For Rohn 20 and 25 G Towers.

Hazer 2 - Heavy duty alum. 12 sq. ft. load \$297.00 ppd.
Hazer 3 - Standard alum. 8 sq. ft. load \$213.00 ppd.
Hazer 4 - Heavy galv. steel 16 sq. ft. load \$278.00 ppd.
Ball Thrust bearing TB-25 for any of above \$42.50 ppd.

KENPRO Antenna Rotors

KR-400 11 sq. ft. Azimuth Rotor \$214.95 ppd.
KR-600 19 sq. ft. Azimuth Rotor \$299.95 ppd.
KR-2000 27 sq. ft. Azimuth Rotor \$549.95 ppd.
KR-5400 AZ-EL Satellite Rotor \$399.95 ppd.
KR-001 C-64 Computer Interface \$159.95 ppd.

Send for free details of aluminum towers specifically engineered for use with the Hazer.

Satisfaction guaranteed. Call today and charge to Visa, MasterCard or mail check or money order.

GLEN MARTIN ENGINEERING INC.
P.O. Box H 253
Boonville, Mo. 65233
816-882-2734



**17th ANNUAL
INDIANAPOLIS HAMFEST™**
And INDIANA STATE ARRL CONVENTION



July 11-12, 1987

Marion County Fairgrounds — Gates open 6:00 AM both days

2 Full Days of:

Commercial Exhibitors
Large Flea Market
Hourly Awards
Forums

FREE:

Parking
Kids Awards
Camping
Womens Awards

Free Trolley Buses to Union Station
Indiana's Largest Electronic Flea Market,
Computer and Amateur Radio Display

INDIANAPOLIS HAMFEST, P. O. Box 11776, Indianapolis, IN 46201

CALL: (317) 745-6389—Commercial (317) 356-4451—Flea Market

PAC-COMM TNC-220

HF/VHF PACKET CONTROLLER
MADE IN U.S.A.



Shown with
Tuning Indicator
Option

AMATEUR DIRECT PRICES

KIT \$129.95

ASSEMBLED \$159.95

OPTIONS: 32K RAM \$9.95

INTERNAL LED BAR GRAPH

TUNING INDICATOR \$39.95



Rear Panel
Showing Dual
Radio Connectors

YOUR BEST VALUE — COMPARE FEATURES

- Only unit under \$300 with dual radio connectors • Switch radios, data rates, modem tones with one keyboard command—no buttons to push, no cables to swap • Six pole HF filter standard—needs no "add-ons" • Software selectable carrier detection—use software method, amplitude detection, or phase lock (with tuning indicator option) • Modem disconnect header, CPU high speed clock jumper, expandable to 32K RAM
- Latest version of proven TAPR AX.25 L2V2 software supports 300 to 9600 baud terminal and radio data rates • Watchdog timer for legal unattended operation, lithium battery backed RAM • Z80 CPU, 8530 SCC hardware HDLC, 7910 integrated circuit modem • All ICs socketed
- Direct FSK output available for HF (in addition to AFSK) • Enhanced software ability to filter connects and digipeating • LED bar graph tuning indicator option with phase locked loop carrier detection for unsurpassed HF operation • Works with any TTL or RS-232 computer (no additional interface for VIC-20 or C-64) • Excellent customer support—24 hour technical hotline, electronic mail system, low cost repair service
- Assembled units carry one year limited warranty • Comprehensive manual and convenient instruction card • High quality extruded aluminum case and colorful front panel • Dealer inquiries invited.

WRITE FOR CATALOG OF PACKET EQUIPMENT, SOFTWARE AND ACCESSORIES.

ORDER DIRECT 800-223-3511 FREE UPS BROWN



Pac-Comm Packet Radio Systems, 3652 West Cypress St., Tampa, FL 33607

✓ 166

RUTLAND ARRAYS

PRESENTING

THE FINEST 432 MHZ ANTENNAS AVAILABLE

EME—WEAK SIGNAL—TROPO—ATV

THE FO-22 15.8 DBD MEASURED GAIN
22EL 14FT \$76.64

AN OUTSTANDING ANTENNA FOR EME—WEAK
SIGNAL—TROPO

THE RIW-19 14.9 DBD MEASURED
GAIN 19EL 13FT \$69.95
FOR EME—TROPO—ATV

Assembly time 1 hr. per antenna.
Add \$6 UPS, S/H for single or pair of antennas, \$8 west
of the Mississippi. PA residents add 6% state tax.

ALSO AVAILABLE: Power Dividers—Stacking frames
Write for details and Price Sheet

RUTLAND ARRAYS
1703 WARREN STREET
NEW CUMBERLAND, PA 17070

✓ 157

NEW! LOW COST AC POWERLINE DISTURBANCE MONITORS

- **MODEL LDM-120** ONLY \$99
DETECTS, STORES AND DISPLAYS
WORST CASE LINE VOLTAGE VARI-
ATION DUE TO BROWN-OUTS, SAGS
AND SURGES. 1½ AND 3 CYCLE
RESPONSE TIMES 60-160 VOLT
RANGE.
- **MODEL LSM-120** ONLY \$139
DETECTS, STORES AND DISPLAYS
WORST CASE PEAK SPIKE VOLTAGE.
NORMAL AND COMMON MODE
SELECTION 100 V-2.5 KV RANGE.

COMPLETE STANDALONE INSTRU-
MENTS WITH INTERNAL AUDIBLE ALARM
AND EXTERNAL TTL ALARM OUTPUT.
FULLY ISOLATED. 1 YEAR WARRANTY.

CATCH THOSE GLITCHES!

TESTWARE
ELECTRONIC TEST INSTRUMENTS

4425 CANOGA AVE. WOODLAND HILLS, CA 91364
(818) 346-9370

CALL OR WRITE FOR LITERATURE.

✓ 177

CIRCUIT ANALYSIS TOOL KIT

PC and XT COMPATIBLES

RF and Microwave Circuit Analysis can easily be
performed using LNCAP*1 TOOL KIT. Design and
analyze RF circuits containing network parameters
such as S, Z or Y, R, L, C'S, transmission lines,
coupled lines, stubs, hybrid models and many
other element blocks. Includes parallel and series
branching and network combining; sensitivity
analysis and full optimization. Perform complete
stability analysis for active networks plus filter
and matching network design program. Print results
to screen, disk or printer. Includes file editor with
instructions and examples.

TOOL KIT \$46.95

plus \$2.50 for S & H

BMA Software

1234 Rousseau Drive

Sunnyvale, CA 94087

(408) 732-9475

M.O. or Check Accepted

✓ 178

compact travel antenna

Complete the installation
— add this antenna
to your compact rig

Traveling with a portable rig* is fun, but raising a temporary antenna can be difficult. For one thing, few resort managers are willing to lend their flagpoles and trees to unsightly wires that could garrote paying customers. And, of course, there's always the possibility of a mishap — a poorly thrown beanbag dimpling the roof of a vintage Mercedes, for example. These liabilities are *real*, and all too often I've settled for make-shift alternatives to avoid an unpleasant confrontation.

Thinking there must be a better way, I set out to build an antenna that would provide solid on-the-road performance without scaring the spirit of cooperation out of resort owners. I started by writing down my

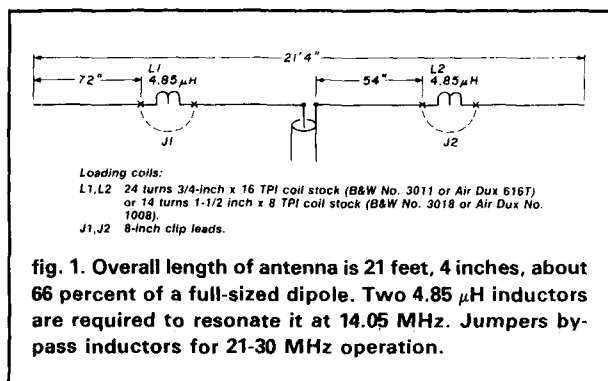

*See K1BQT's "A Compact 20-meter CW Transceiver" on page 8 of this issue.

needs: it must be self-supporting, easy to mount, and collapsible; it must cover 14-30 MHz, perform with high efficiency in either vertical or horizontal polarization, be made from available materials, and require no external matching devices.

Remembering my old Cushcraft "Trick-Stick" VHF dipole, and how easy it was to set up and use, I reasoned that a loaded hf dipole of similar size might be the answer.

design

Since I didn't want a high-budget project, my first step was to raid my junk pile, where I found several 4-1/2 foot lengths of 3/8-inch diameter thick-wall aluminum tubing. I decided that these would make sturdy center sections.

Six-foot collapsible replacement antennas from Radio Shack would be perfect for the ends. This would give me a 21-foot element in four pieces (fig. 1). Since 21 feet is a healthy 66 percent of full size, I concluded that my antenna would be efficient, and provide a good match without need for special matching devices.

loading coils

Power handling wasn't a concern, since my portable rig runs 15 watts. But efficiency was very important. With QRP and marginal locations, every watt counts! A friend who designs antennas for a living cautioned me against close-winding loading coils with enameled wire. His experience indicated that high-Q air-wound stock is less lossy, and well worth the extra investment. He said I might get away with using 3/4-inch 16 TPI (turns per inch) miniductor for low power, but strongly recommended larger diameter stock with 8 or 10 TPI spacing.

construction (see table 1)

Since this antenna is intended for temporary use,

Rick Littlefield, K1BQT, Box 114, Barrington, New Hampshire 03825

Unadilla Amateur Antenna Baluns

For 20 years, preferred by Amateur, Commercial and Military Operators
First with built-in lightning arrester-minimizes TVI, maximizes power handling



W2AU 1:1 & 4:1
Only \$17.95



W2DU-HF
Only \$19.95



W2DU-VHF
Only \$19.95

W2AU Broadband Ferrite Core Baluns

For medium power (1000 watts RF)

W2AU 1:1

- * 50 to 50 or 75 to 75 ohms
- * For dipoles, V's, beams, quads

W2AU 4:1

- * 200 to 50 or 300 to 75 ohms
- * For high impedance antennas such as folded dipoles

W2DU Non-Ferrite Very High Power Baluns

W2DU-HF (High Power)

- * 1.8-30 MHz
- * 3000-9000 watts with 1:1 antenna SWR
- * 1500-5000 watts with 2:1 antenna SWR

W2DU-VHF (High Power and Extended Range)

- * 30-300 MHz
- * 2000-4000 watts with 1:1 antenna SWR
- * 1200-2400 watts with 2:1 antenna SWR

The Perfect Dipole!



Only \$65.00

Complete Kit

- W2AU 1:1 Balun
- Pair of W2VS KW-40 Traps
- Pair of End-sulators
- 125' #14-7 Copper Wire
- Complete Installation & Pruning Instructions

Purchase from any of over
300 dealers nationwide
or order direct

- DIPOLE ANTENNA KIT.....\$65.00 ea.
 W2AU 1:1 & W2AU 4:1.....\$17.95 ea.
 W2DU-HF & W2DU-VHF.....\$19.95 ea.
 Total Order.....\$
 Shipping.....\$2.00
 Total.....

Name _____

Address _____

City _____ State _____ Zip _____

Phone () _____

VISA Mastercard

Card # _____

Expires _____

Check Money Order

To order or request informational
brochure, call

617-475-7831

or write to
ANTENNA'S ETC.

P.O. Box 215 BV, Andover, MA 01810-0814

1 week delivery for credit cards
2 weeks for personal checks.

30 DAY MONEY BACK GUARANTEE

Unadilla/Reyco/Inline is now a Division of
UNADILLA/ANTENNA'S ETC.

✓ 189

VHF-UHF POWER DIVIDERS



RF power dividers provides the best way to feed in-phase 2 and 4 antenna arrays to maximize system gain and at the same time reduce losses to a minimum. Covering 144 thru 1296 MHz, this series of VHF/UHF power dividers are premier RF devices designed for a long service life with low SWR and broad operating bandwidth.

Extruded aluminum body with a durable enamel finish in addition to silicon sealing at connector flanges results in a ruggedized unit for all array installations. Available with N-type connectors only, these units are unconditionally guaranteed for 2 years.

MODEL	CONFIG.	PRICE
144-2P	(2 ports)	\$51.00
144-4P	(4 ports)	\$58.00
220-2P	(2 ports)	\$50.00
220-4P	(4 ports)	\$57.00
430-2P	(2 ports)	\$48.00
430-4P	(4 ports)	\$56.00
902-2P	(2 ports)	\$48.00
902-4P	(4 ports)	\$56.00
1296-2P	(2 ports)	\$49.00
1296-4P	(4 ports)	\$57.00

SHIPPING NOT INCLUDED

STRIDSBERG ENGINEERING, CO.

P.O. Box 7973 • Shreveport, LA 71107 • USA
Phone: (318) 865-0523

✓ 163

MICROCOMPUTER REPEATER CONTROL

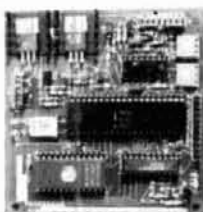

\$129

✓ 156

Introducing the MICRO REPEATER CONTROLLER RPT-2A, a new concept in LOW COST, EASY TO INTERFACE, microcomputer repeater control. Replace old logic boards with a state of the art microcomputer that adds NEW FEATURES, HIGH RELIABILITY, LOW POWER, SMALL SIZE, and FULL DOCUMENTATION to your system. Direct interface (drop in) with most repeaters. Detailed interface information included. Original MICRO REPEATER CONTROL article featured in QST Dec. 1983.

- Two CW ID Messages
- Time Out Timer
- Pre-Timeout Warning MSG
- Post Timeout CW MSG
- Courtesy Beep
- Auxiliary Inputs
- Reconfigurable COR Input
- High Current PTT Interface
- Sine Wave Tone Generator
- Low Power 9.15 VDC @ 200 ma
- Size 3.5" x 3.5"
- All Connectors Included

RPT-2A Kit Only \$129 plus \$3.00 shipping

PROCESSOR CONCEPTS

P.O. BOX 26023
ST. PAUL, MN 55126
(612) 484-9176 7pm-10pm evenings

CALL OR WRITE FOR FREE CATALOG AND SPECIFICATIONS

THE MULTIPLE RECEIVER SOLUTION



4 Channel Signal-to-Noise Voter

- Expandable to 32 Channel by Just Adding Cards
- Continuous Voting
- LED Indicators of CDR and Voted Signals
- Built-in Calibrator
- Remote Voted Indicators Pinned Out
- 4 1/2 x 6 Double Sided Gold Plated 44 Pin Card
- Remote Disable Inputs
- MORE

Built, tested and calibrated with manual

\$350.00

NEW PRODUCT

Telephone interface now available
For more information call or write:

HALL ELECTRONICS
Voter Department
815 E. Hudson Street
Columbus, Ohio 43211
(614) 261-8871

✓ 165

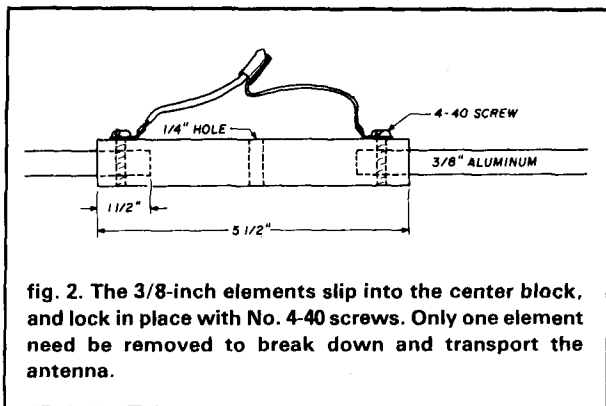

fig. 2. The 3/8-inch elements slip into the center block, and lock in place with No. 4-40 screws. Only one element need be removed to break down and transport the antenna.

electrical half wavelength (22 feet) of RG-58U directly to the center block. This accommodates most out-the-window and off-the-balcony setups. Since this antenna is certain to be installed in imperfect locations, it may be especially beneficial to decouple the feedline from the antenna. While a balun can be installed for this purpose, looping five or six tight turns in the feedline or slipping a few large ferrite beads over the cable jacket will prove just as effective.

Feel free to modify the design to suit your own particular needs. I've constructed a second version of the antenna that breaks down into 2-1/2 foot sections — just for air travel. A friend of mine built a ruggedized

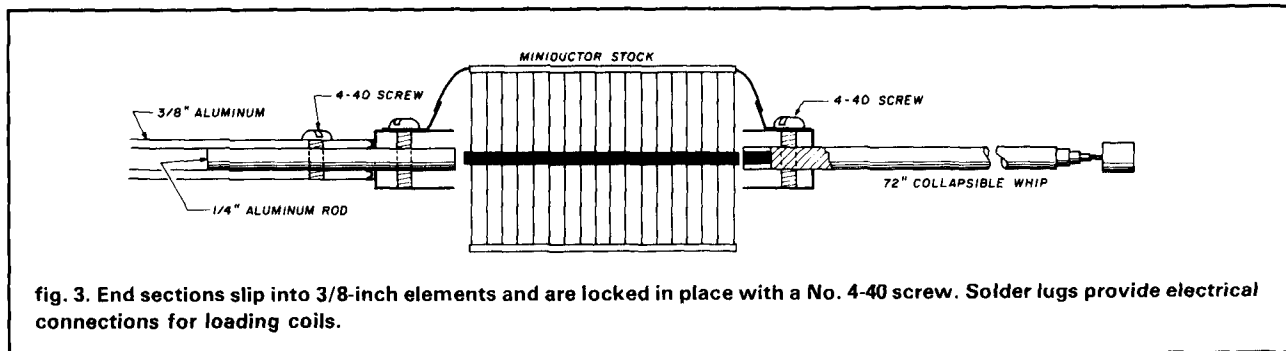

fig. 3. End sections slip into 3/8-inch elements and are locked in place with a No. 4-40 screw. Solder lugs provide electrical connections for loading coils.

I concentrated on making it lightweight and easy to assemble in the field. The center block was made from a piece of 5-1/2 inch x 3/4-inch plastic rod stock (see fig. 2). This material is fairly inexpensive, easy to machine, and available from most plastic supply houses. Each end was drilled to a depth of about 1-1/2 inches to accept the 3/8-inch tubing. The block and tubing sections were drilled and tapped to accept a No. 4-40 screw, which locks each element in place. This screw also provides electrical connection for the feedline. The center of the block can then be drilled to accept any kind of mounting scheme, including the one shown here or a standard TV mast U-bolt.

The loading coil and collapsible whip are constructed as a single assembly (see fig. 3). The coil support is a 3-inch length of 1/2-inch diameter plastic rod. A 1/4-inch solid aluminum stub is installed in one end to mate with the 3/8-inch element tubing. The whip is inserted in the other end. Note the location of the solid insert at the base of the whip. The locking hole must be drilled through this insert to ensure a secure mount and good electrical contact. Install solder lugs on mounting hardware; these will be needed for connecting the loading coils. If you plan to operate in foul weather, protect the coils with a plastic sleeve. Without them, rain and snow may detune the antenna and make it temporarily unusable.

To simplify feedline attachment, I hard-wired an

Table 1. List of materials for compact antenna.

2	3/8-inch OD x 53-inch aluminum tubing
2	1/4 x 3-inch aluminum rod
1	3/4 x 3-1/2 inch aluminum channel stock
1	3/4 x 5-1/2 inch plastic rod
2	1/2 x 3-inch plastic rod
2	Radio Shack 72-inch collapsible antenna (No. 270-1408).

model for permanent installation on his TV mast. In reality, moving loading coils closer to the ends, adjusting element lengths, and using different tubing schemes will probably do little to change performance. The most critical factors are keeping the length greater than 20 feet and using high-Q loading coils to achieve resonance. A grid dip meter works fine for making initial adjustments.

supports

To support my antenna, I cut a 6-foot strip of 3/4 x 1-inch poplar. Wood is preferable to metal in this application because it's strong, light, and less likely to damage or discolor woodwork. A short piece of 3/4-inch aluminum channel stock was used to square the center block so it would lock securely into a square notch cut into the mast. A single 1/4-inch bolt holds the antenna in place (see fig. 4).

ASTRON POWER SUPPLIES

• HEAVY DUTY • HIGH QUALITY • RUGGED • RELIABLE •

RS and VS SERIES

SPECIAL FEATURES

- SOLID STATE ELECTRONICALLY REGULATED
- FOLD-BACK CURRENT LIMITING Protects Power Supply from excessive current & continuous shorted output.
- CROWBAR OVER VOLTAGE PROTECTION on all Models except RS-4A.
- MAINTAIN REGULATION & LOW RIPPLE at low line input Voltage.
- HEAVY DUTY HEAT SINK • CHASSIS MOUNT FUSE
- THREE CONDUCTOR POWER CORD
- ONE YEAR WARRANTY • MADE IN U.S.A.

PERFORMANCE SPECIFICATIONS

- INPUT VOLTAGE: 105 - 125 VAC
- OUTPUT VOLTAGE: 13.8 VDC \pm 0.05 volts (Internally Adjustable: 11-15 VDC)
- RIPPLE: Less than 5mv peak to peak (full load & low line)



INSIDE VIEW - RS-12A



MODEL RS-50A



MODEL RS-50M



MODEL VS-50M

RM-A Series

19" X 5 1/4" RACK MOUNT POWER SUPPLIES



MODEL RM-35A

Model	Continuous Duty (AMPS)	ICS* (AMPS)	Size (IN) H X W X D	Shipping Wt. (lbs.)
RM-35A	25	35	5 1/4 x 19 x 12 1/2	38
RM-50A • Separate Volt and Amp Meters	37	50	5 1/4 x 19 x 12 1/2	50
RM-35M	25	35	5 1/4 x 19 x 12 1/2	38
RM-50M	37	50	5 1/4 x 19 x 12 1/2	50

RS-A SERIES



MODEL RS-7A

MODEL	Continuous Duty (Amps)	ICS* (Amps)	Size (IN) H x W x D	Shipping Wt (lbs)
RS-4A	3	4	3 3/4 x 6 1/2 x 9	5
RS-7A	5	7	3 3/4 x 6 1/2 x 9	9
RS-7B	5	7	4 x 7 1/2 x 10 3/4	10
RS-10A	7.5	10	4 x 7 1/2 x 10 3/4	11
RS-12A	9	12	4 1/2 x 8 x 9	13
RS-20A	16	20	5 x 9 x 10 1/2	18
RS-35A	25	35	5 x 11 x 11	27
RS-50A	37	50	6 x 13 3/4 x 11	46

RS-M SERIES



MODEL RS-35M

MODEL	Continuous Duty (Amps)	ICS* (Amps)	Size (IN) H x W x D	Shipping Wt (lbs)
• Switchable volt and Amp meter RS-12M	9	12	4 1/2 x 8 x 9	13
• Separate Volt and Amp Meters RS-20M	16	20	5 x 9 x 10 1/2	18
RS-35M	25	35	5 x 11 x 11	27
RS-50M	37	50	6 x 13 3/4 x 11	46

VS-M SERIES



MODEL VS-20M

- Separate Volt and Amp Meters
- Output Voltage adjustable from 2-15 volts
- Current limit adjustable from 1.5 amps to Full Load

MODEL	Continuous Duty (Amps) @ 13.8VDC @ 10VDC @ 5VDC	ICS* (Amps) @ 13.8V	Size (IN) H x W x D	Shipping Wt (lbs)
VS-20M	16 9 4	20	5 x 9 x 10 1/2	20
VS-35M	25 15 7	35	5 x 11 x 11	29
VS-50M	37 22 10	50	6 x 13 3/4 x 11	46

RS-S SERIES



MODEL RS-12S

- Built in speaker

MODEL	Continous Duty (Amps)	ICS* Amps	Size (IN) H x W x D	Shipping Wt (lbs)
RS-7S	5	7	4 x 7 1/2 x 10 3/4	10
RS-10S	7.5	10	4 x 7 1/2 x 10 3/4	12
RS-10L (For LTR)	7.5	10	4 x 9 x 13	13
RS-12S	9	12	4 1/2 x 8 x 9	13
RS-20S	16	20	5 x 9 x 10 1/2	18

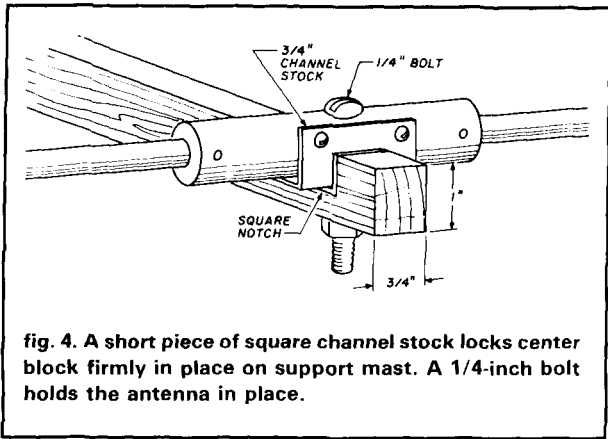

fig. 4. A short piece of square channel stock locks center block firmly in place on support mast. A 1/4-inch bolt holds the antenna in place.

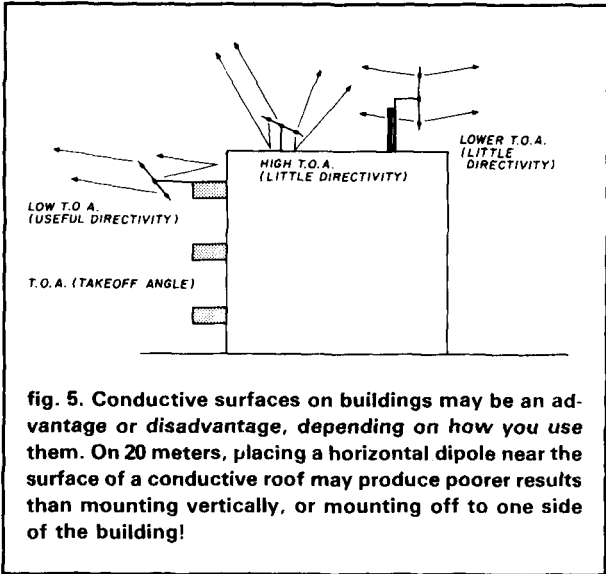

fig. 5. Conductive surfaces on buildings may be an advantage or disadvantage, depending on how you use them. On 20 meters, placing a horizontal dipole near the surface of a conductive roof may produce poorer results than mounting vertically, or mounting off to one side of the building!

When setting up the antenna, almost anything can be a potential supporting structure (window sills, balcony rails, fire escapes, standpipes, and existing TV masts are all favorites). Attaching antenna and mast to one of these supports can be a real exercise in "jerry-rig" engineering. Having the right tools helps! Gaffer's tape, lightweight ratcheting C-clamps (Stanley 83-157 or equivalent) and motorcycle bungie cords are essential tools of the trade for the imaginative field-installer!

performance

For initial testing, I mounted the antenna out a second story window, about 5-1/2 feet from the side of the building. Sections went together without difficulty, and the completed assembly seemed well balanced and easy to handle. The support mast was clamped to the window casement with a C-clamp.

After pruning the loading coils for resonance at



The monthly magazine with a natural blending of two popular hobbies — Ham Radio and Computers

- ★ Articles on Ham Radio & Most Personal Computers
- ★ Hardware & Software Reviews
- ★ Various Computer Languages
- ★ Construction Articles
- ★ Much Much More

Your #1 Source for PACKET Info

"...received my moneys worth with just one issue..."

—J. Trenbick

"...always stop to read CTM, even though most other magazines I receive (and write for) only get cursory examination..."

—Fred Blechman, K6UGT

U.S.A.....	\$18.00 for 1 year
Mexico, Canada.....	\$32.00
Foreign.....	\$43.00(land)-\$68.00(air)
(U.S. funds only)	
Permanent (U.S Subscription).....	\$150.00
Sample Copy.....	\$3.50



Circulation Manager

1704 Sam Drive

Birmingham, Alabama 35235

Phone 205/854-0271

Name _____

Call Sign _____

Address _____

City _____ State _____

Zip _____ Phone _____

Date _____

Signature _____

K.V.G. CRYSTAL PRODUCTS



9 MHz CRYSTAL FILTERS

MODEL	Applic- ation	Band- width	Poles	Price
XF-9A	SSB	2.4 kHz	5	\$61.00
XF-9B	SSB	2.4 kHz	8	83.00
XF-9B-01	LSB	2.4 kHz	8	110.00
XF-9B-02	USB	2.4 kHz	8	110.00
XF-9B-10	SSB	2.4 kHz	10	145.00
XF-9C	AM	3.75 kHz	8	89.00
XF-9D	AM	5.0 kHz	8	89.00
XF-9E	FM	12.0 kHz	8	89.00
XF-9M	CW	500 Hz	4	62.00
XF-9NB	CW	500 Hz	8	127.00
XF-9P	CW	250 Hz	8	175.00
XF-910	IF noise	15 kHz	2	21.00

10.7 MHz CRYSTAL FILTERS

WRITE FOR FULL DETAILS OF CRYSTALS AND FILTERS
Export inquiries invited. Shipping: \$3.75

MICROWAVE MODULES EQUIPMENTS

Use your existing HF or 2M rig on other VHF or UHF bands.

RECEIVE CONVERTERS

MMk	1691-137	270.00
MMk	1296-144G	190.00
MMc	439-ATV	99.00
MMc	432-28(S)	70.00
MMc	144-28(HP)	73.00
MMc	144-28	60.00

LINEAR TRANSVERTERS

MMI	1296-144G	370.00
MMx	1268-144	290.00
MMI	432-28(S)	280.00
MMI	144-28(F)	400.00
MMI	144-28	200.00
MMI	435-28(S)	300.00

LINEAR POWER AMPLIFIERS

2M			70cm		
MML	144-30-LS	145.00	MML	432-30-L	245.00
MML	144-50-S	160.00	MML	432-50	220.00
MML	144-100-S	225.00	MML	432-100	450.00
MML	144-100-LS	250.00			
MML	144-200-S	500.00			

ANTENNAS

2M				160
10XY-2M		\$80.00	LOOP YAGIS	
70cm			1268-LY	55.00
70/MBM28		\$50.00	1296-LY	55.00
70/MBM48		70.00	1691-LY	65.00
70/MBM88		115.00	order loop yagi connector extra	
DY20-900 MHz		80.00		

Send 66¢ (3 stamps) for full details of all our VHF & UHF equipments and KVG crystal products.

Shipping: FOB Concord, Mass.



si

(617) 263-2145
SPECTRUM
INTERNATIONAL, INC.
Post Office Box 1084
Concord, MA 01742, U.S.A.

BASEBALL CAP

How about an attractive **BASEBALL** style cap that has name and call on it. It gives a jaunty air when worn at Hamfests and it is a great help for friends who have never met to spot names and calls for easy recognition. Great for birthdays, anniversaries, special days, whatever occasion. Hats come in the following colors:
GOLD, BLUE, RED, KELLY GREEN

Please send call and name (maximum 6 letters per line).

UFBC-81 \$6.00 **WA2SRF**



ham radio

BOOKSTORE

Greenville, NH

03048

Please add \$3.50 for shipping and handling

I.D. BADGES

No ham should be without an I.D. badge. It's just the thing for club meetings, conventions, and get-togethers, and you have a wide choice of colors. Have your name and call engraved in either standard or script type on one of these plastic laminated I.D. badges. Available in the following color combinations (badge/lettering): white/red, wood-grain/white, blue/white, white/black, yellow/blue, red/white, green/white, metallic gold/black, metallic silver/black.

UID Engraved I.D. Badge \$2.50

14.05 MHz, I measured a minimum SWR of 1.4:1. My noise bridge read the impedance as 38 ohms — an acceptable load for broadbanded solid-state rigs. Listening across the band, I was encouraged to hear several 599+ signals. Running 15 watts, I called two lengthy CQs, both yielding no reply. Beginning to think the worst, I tried again. This time, a much-welcomed CT3 came back with a 569 report. Several more DX and stateside contacts followed, with signal ranging from 559 to 589. Flipping the antenna to vertical polarization brought similar results.

other bands

Although untested on the other bands, this antenna should do very well on 18, 21, 24, and 30 MHz. For 18-MHz operation, simply readjust the collapsible end sections for minimum SWR. For 21 MHz and up, place 8-inch jumper wires across each loading coil (the extra jumper length is needed to make the antenna resonate at 21.0 MHz). Collapsing the length of the end sections (with jumpers in place) will provide continuous coverage through 10 meters.

site suggestions

Here are some tips to help you achieve maximum performance:

- **Look for a high, open location.** Get above the roofline if you can, but keep directivity and takeoff angle in mind (fig. 5).
- **Keep the antenna at least 5 or 6 feet from the building surface.** Proximity to electrical wiring, foil insulation, and structural metal can detune it. Bending elements outward may help to decouple the ends from a metal structure.
- **When you side-mount to a building, try to locate the antenna on the side facing the desired direction of transmission.** Better to use the structure as a reflector than as a shield!
- **If there are horizontal wires close by, vertical polarization may work better.** When using vertical polarization, make sure the bottom leg is at least 6 feet above ground. Also, make sure the antenna is clear of people and pets. Even QRP rigs can develop enough rf potential at element tips to cause painful burns and injury.

conclusion

Whether you're jet-setting to VP2-land, driving cross-country, or working tabletop DX from the local flea market, a good portable antenna will help you get on the air with a minimum of hassle and frustration. I am continually pleased with how well this one has worked for me. On occasion, it has even been spotted emerging from my office window . . . at lunchtime, of course!

ham radio

**The BEST is still
"made in U.S.A."**



MIRAGE/KLM

Under New Ownership

**American made RF Amplifiers and Watt/SWR Meters
of exceptional value and performance.**

• 5 year warranty • prompt U.S. service and assistance

RF AMPLIFIERS

2 METERS-ALL MODE

B23 2W in = 30W out
(useable in: 100 mW-5W)

B108 10W in = 80W out
(1W = 15W, 2W = 30W) RX preamp

B1016 10W in = 160W out
(1W = 35W, 2W = 90W) RX preamp

B3016 30W in = 160W out
(useable in: 15-45W) RX preamp
(10W = 100W)

220 MHz ALL MODE

C106 10W in = 60W out
(1W = 15W, 2W = 30W) RX preamp

C1012 10W in = 120W out
(2W = 45W, 5W = 90W) RX preamp

C22 2W in = 20W out
(useable in: 200mW-5W)

RC-1 AMPLIFIER REMOTE CONTROL

Duplicates all switches, 18' cable

WATT/SWR METERS

- peak or average reading
 - direct SWR reading
- MP-1** (HF) 1.8-30 MHz
MP-2 (VHF) 50-200 MHz

430-450 MHz ALL MODE

D24 2W in = 40W out
(1W = 25W)

D1010 10W in = 100W out
(1W = 25W, 2W = 50W)

Available at local dealers throughout the world.

MIRAGE/KLM
COMMUNICATIONS EQUIPMENT, INC.

✓ 159

16890 Church St., Morgan Hill, CA 95037, (408) 779-7363

THE STANDARDS OF EXCELLENCE

SUPERIOR WEAK SIGNAL PERFORMANCE COMMERCIAL MODEM

COMPARE with ANY unit at ANY Price

Now Available With
PACKET RADIO

**THE WORLD OF VHF/HF PACKET*,
CW, RTTY, ASCII AND NEW DUAL
AMTOR** IS AS CLOSE AS YOUR
FINGERTIPS WITH THE BRILLIANTLY
INNOVATIVE STATE-OF-THE-ART
MICRO-COMPUTER CONTROLLED
EXL-5000E.**

**SPECIAL SALE
\$795**



SHOWN WITH OPTIONAL KANTRONICS KPC2400
AND MFJ-1270 TNC-2

Everything built in — nothing else to buy!

• AUTOMATIC SEND/RECEIVE—ANY SPEED ANY SHIFT • BUILT IN COMPUTER GRADE 5" MONITOR • EXTERNAL MONITOR JACK • TIME CLOCK ON SCREEN • TIMED TRANSMISSION AND RECEIVING • SELCAL • CRYSTAL CONTROLLED AFSK MODULATOR • PHOTOCOUPLER CW, FSK KEYS • ASCII KEY ARRANGEMENT • 15 CHANNEL BATTERY BACK-UP MEMORY • 1,280 CHARACTER DISPLAY MEMORY • SPLIT SCREEN TYPE-AHEAD BUFFER • FUNCTION SCREEN DISPLAY • PARALLEL PRINTER INTERFACE • SPEEDS: CW 5-100 WPM (AUTOTRACK), 12-300 BAUD (ASCII AND BAUDOT), 12-600 BAUD TTL; 100 BAUD ARQ/FEC AMTOR • ATC • RUB-OUT FUNCTION • AUTOMATIC CR/LF • WORD MODE • LINE MODE • WORD WRAP AROUND • ECHO • TEXT CURSOR CONTROL • USOS • DIDDLE • TEST MESSAGES (RY AND QBF) • MARK AND BREAK (SPACE AND BREAK) SYSTEM • VARIABLE CW WEIGHTS • AUDIO MONITOR CIRCUIT BUILT IN • CW PRACTICE FUNCTION • CW RANDOM GENERATOR • BARGRAPH LED METER FOR TUNING • OSCILLOSCOPE OUTPUTS • BUILT IN 100-120 / 220-240 VAC 50/60HZ AND 13.8VDC POWER SUPPLIES • AND MUCH, MUCH MORE • SIZE: 14W x 14D x 5H •

EXCLUSIVE DISTRIBUTOR: DEALER INQUIRIES INVITED FOR YOUR NEAREST DEALER OR TO ORDER
AMATEUR-WHOLESALE ELECTRONICS TOLL FREE...800-327-3102
46 Greensboro Highway, Watkinsville, Georgia 30677 Telephone (404) 769-8706 Telex: 4930709 ITT

MANUFACTURER:
TONO CORPORATION
98 Motosoja Machi, Maebashi-Shi, 371, Japan



**PLEASE CALL FOR DETAILS*

***Dual Amtor: Commercial quality, the EXL-5000E incorporates two completely separate modems to fully support the amateur Amtor codes and all of the CCIR recommendations 476-2 for commercial requirements.*

Specifications Subject to Change.

MR. NICAD

REPLACEMENT BATTERIES FOR COMMUNICATIONS

Nickel-Cadmium, Alkaline, Lithium, etc.

ICOM - BP-3 Repack - \$15.00
BP-2, BP-5, BP-8 Repacks.

NEW HOT ROD PACKS FOR ICOM 2A,
2AT, 02AT, 8 CELL 10v - 800 MAH, 10
CELL 12.5v - 500 MAH.....\$49.95 ea.

Yaesu, Kenwood, Santic, Azden,
Tempo, Standard, Cordless Phone
etc.

**MR. NICAD
E.H. YOST & CO.**

EVERETT H. YOST RR #1 BOX #37
KB9XI SAUK CITY, WI 53583
(608) 643-3194

Send for nicad-battery price list.

✓ 155

MOBILE RADIO MOUNTS

MM 10013



MM 1007

- Government
- Industrial
- Commercial
- Recreational

All New 1987 Y-5 Catalog FREE

IIX IIX Equipment Ltd.
P.O. Box 9 Oaklawn, IL (312) 423-0805

✓ 164

★Dustcovers★

by **KAGIL**™

- PROTECT your GEAR
- Waterproof PAK Nylon
- FIVE Colors
- Economical
- For ALL Amateur Radio Gear, Vintage thru Solid State...
- Custom covers
- MINI-covers

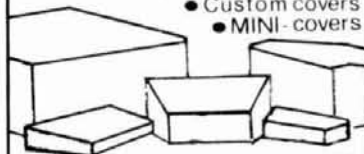

✓ 158

Send (SASE) Today
Samples & Brochure
KAGIL Dustcovers POBox 06780
Portland, OR 97206

✓ 176

ham radio TECHNIQUES

Bill W6SAI

time and frequency station WWVS

I couldn't resist the temptation. Driving along the south coast of Kauai Island, Hawaii, I saw a sign reading *U.S. Department of Commerce, National Bureau of Standards Radio Station WWVH*. In a microsecond, I turned off the highway and headed toward a brace of interesting looking antennas. After passing through a checkpoint, I quickly arrived at WWVH and was greeted by Ernie Farrow, the Engineer-in-Charge.

What an interesting visit! A low-frequency DXer would have been visibly shaken by the sight of the extensive vertical antenna and ground screen for the 2.5-MHz transmissions of WWVH. The antenna would be a "bomb" on 160 meters!

Ernie surprised me when he mentioned the time and frequency transmissions from WWVS, a station I never knew existed. WWVS, it seems, refers to the satellite-disseminated time code using the GOES (Geostationary Operational Environmental Satellite) satellites of NOAA (National Oceanic and Atmospheric Administration). The time code can be used for general-purpose reference time in the Western Hemisphere from two satellites on a nearly full-time basis.

The two active GOES satellites are in orbit over the Pacific. The satellite that serves the western United States, Canada, and western South America operates at 468.825 MHz and is located at 135 degrees West Longitude. The eastern satellite can be received on 468.8375 MHz and is positioned at

75 degrees West Longitude to serve the eastern seaboard of the United States, as well as Brazil and western Africa.

The time code to the satellites is sent from Wallops Island, Virginia. Because the path delay to and from the satellite is about 260,000 microseconds, the signals are advanced in time by this amount. The arrival time of the signal back on earth is corrected to within 16 microseconds. Other path delays are known, and the exact satellite position is included in the downlink signal for correction by the observer.

Additional information on the transmissions via WWVS and general data on time signals can be obtained in *NBS Special Publication 432*, available from Time and Frequency Division, National Bureau of Standards, Boulder, Colorado 80303.

Many thanks to Ernie Farrow at WWVH for an interesting tour, which is recommended to all visitors to the south coast of Kauai Island. Aloha, Ernie, and Mahalo!

(Note: Want to participate in the NBS 1987 survey? A brief explanation and a tear-out, postage-paid survey form follow this article. — Ed.)

nothing new under the sun!

Sam Pavone, W2DDN, sent me a copy of the original patent on the top-loaded vertical antenna, in common use today as a broadcast antenna and also as a DX antenna on the low frequency ham bands (see **fig. 1**). Looks familiar, doesn't it? Even the current distribution curve (marked "3") is what one would expect from an antenna of this type.

The U.S. Patent No. 930,746, however, was granted to Simon Eisenstein of Kiev, Russia on August 10, 1909! The preamble of the patent refers to Simon as "a subject of the Czar of Russia, residing in Kiev [sic], in said Empire of Russia." The patent then goes on to define the current in the antenna in terms of degrees and discusses the problem of corona discharge. In spite of the fact that the patent was witnessed by a lady with the unlikely name of Fannie Fisk, it is apparent that Simon knew his onions. I wonder what happened to him? Did he disappear from the pages of history after filing this contribution to radio communication?

the W0SVM minibeam design

Jack Sobel, W0SVM, has been working for some months on a miniature beam antenna for hams who have restricted air space. His basic design consists of out-of-phase, loaded dipoles in the familiar W8JK configuration (**fig. 2**). Jack's first design is for a 40-meter beam with 7.5-foot spacing. Element lengths are about 37 feet. This is about half the size of a conventional 40-meter, 2-element beam. The experimental antenna uses No. 12 AWG copper wire for the elements and is hung between two supports. Eight-foot spreaders made of wood or PVC pipe are used for the test antenna.

The radiation resistance of the antenna seems to be about 5 ohms, so its operational bandwidth is small. Jack feeds the antenna with a 50-ohm coax line and uses a Transmatch at the station to permit operation over a

The HF4B "Butterfly"™
A Compact Beam
for 20-15-12-10 Meters

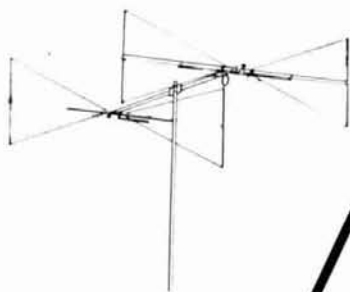

- Unique design reduces size but **not** performance
- No lossy traps; full element radiates on all bands.
- Retrofit kit for 17 meters coming soon.
- Turns with TV rotor
- Only 17 lbs.

HF ANTENNAS FROM BUTTERNUT

Butternut Verticals

Butternut's HF verticals use highest-Q tuning circuits (not lossy traps!) to outperform all multiband designs of comparable size!

Model HF6V

- 80, 40, 30, 20, 15 and 10 meters automatic bandswitching
- Add-on kit for 17 and 12 meters available now
- 26 ft. tall

Model HF2V

- Designed for the low-band DXer
- Automatic bandswitching on 80 and 40 meters
- Add-on units for 160 and 30 or 20 meters
- 32 feet tall - may be top loaded for additional bandwidth

For more information see your dealer or write for a free brochure



BUTTERNUT ELECTRONICS CO

405 East Market Lockhart, Texas 78644



This publication is available in microform from University Microfilms International.



Please send information about these titles:

Name _____

Company/Institution _____

Address _____

City _____

State _____ Zip _____

Phone (____) _____

Call toll-free 800-521-3044. In Michigan, Alaska and Hawaii call collect 313-761-4700. Or mail inquiry to: University Microfilms International, 300 North Zeeb Road, Ann Arbor, MI 48106.

TRANSMISSION LINE TRANSFORMERS

A new ARRL Publication by Dr. Jerry Sevick, W2FMI

COMING SOON!

Despite the popularity of transmission line transformers in both commercial and amateur applications, little practical design information has been published concerning these devices. The lack of data was made abundantly clear to Jerry Sevick, W2FMI when he began designing matching transformers for the short vertical antennas that are the subject of his classic series of articles that appeared in *QST*. In order to fill in the gaps of available knowledge, Jerry decided to study the subject of transmission line transformers in depth and the results of his findings are contained in this new ARRL publication!

Transmission Line Transformers covers types of windings, core materials, fractional-ratio windings, efficiencies, multi-winding and series transformers, baluns, and limitations at high impedance levels. There is also a chapter on practical test equipment. This book is must reading for everyone interested in antenna and transmission line theory. Copyright 1987, 128 pages \$10 hardcover only.

The American Radio Relay League, Inc
225 Main St., Newington, CT 06111

SPECIALIZED COMMUNICATIONS
FOR TODAY'S RADIO AMATEUR!



48 pages per issue!

Since 1967, covering all modes of Amateur Radio "specialty" communications; Fast Scan TV, SSTV, FAX, Packet Radio, Computers, RTTY, AMTOR, Satellites, TVRO, Microwave, Lasers and more! 10 issues per year. Back issues available, SASE brings TRS80C, C64, IBM software catalog. U.S. subscribers \$20/year. Foreign slightly higher. Add \$2.00 for Index Issue.

SPEC-COM Communications & Publishing Group
P.O. Box H,
Lowden, Iowa
52255



5% Added

reasonable portion of the 40-meter band. The phasing line between the elements is coiled up on the boom, or spreader. Jack hopes to get his antenna up high in the air so he can run some real operational tests. Perhaps with the coming of spring, he'll get some on-the-air tests with this interesting, compact antenna.

Jack has also built a compact beam of this design for 21-MHz operation. Spacing is less than 6 feet and overall element length is about 12 feet. For the elements, he uses 3/4-inch diameter copper pipe, available from plumbing supply stores in 10-foot lengths.

By changing the length of the phasing line, the beam pattern can be made unidirectional. As shown in the illustrations, both beams have a figure-8, bidirectional pattern, as is common with the W8JK antenna design.

Jack is experiencing lobe-splitting with the antenna and it remains to be seen if the simple feed system is distorting the antenna pattern. This problem won't be solved until milder weather comes to Missouri. Stay tuned for the latest developments.

more on "white noise"

My January column discussing the problem of "white noise" in the modern frequency-synthesized ham gear drew a lot of interesting mail. Obviously, I'm not the only one who has noticed this problem. Synthesizer noise is well known in the industry. Standards of measurement have been developed and most modern military and commercial communication equipment has limitations on this type of annoying radiation.

An interesting letter from Tom Bay, OZ5KG, outlines the ongoing problem he and other European Amateurs have had with a BBC (British Broadcasting Corporation) transmitter operating in the early morning hours on 7120 kHz. Tom provided the BBC with spectrum photographs showing the sideband noise, as monitored in Denmark.

While the problem has not been solved, the transmitter is now shifted to another frequency outside the 40-meter Amateur band, so the gener-

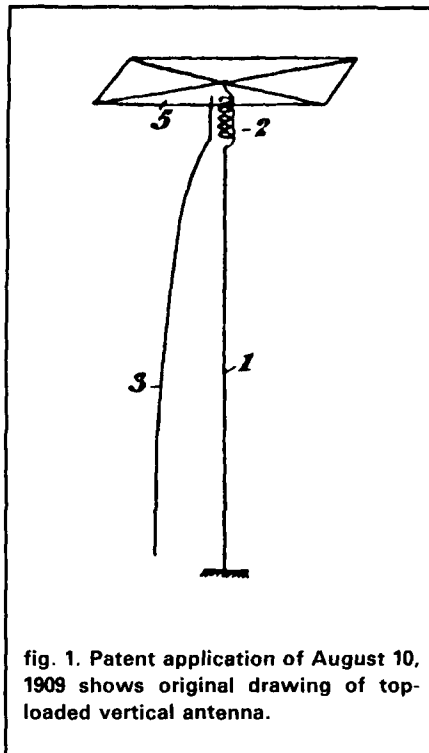

fig. 1. Patent application of August 10, 1909 shows original drawing of top-loaded vertical antenna.

ated noise doesn't affect the Danish Amateurs. This spring the BBC will again resume transmissions on 7120 kHz; it will be interesting to see if the wideband noise is still present on the signal.

phase noise standard?

Another letter came from John Grebenkemper, KA3LBO, of Saratoga, California. John said, in part, that the problem of excessive phase noise in phase-locked oscillators (PLO) isn't inherently due to the phase-locking of the oscillator. According to John, it's attributable, rather, to the necessity of keeping manufacturing costs under control.

John wrote, *In pre-PLL days, the oscillator would be designed with good coils and good capacitors in order to achieve temperature stability. This also resulted in a design which had a very high-Q oscillator resonant circuit. The high Q means that the oscillator is very good at filtering out the phase noise far away from the carrier. However, the newer designs that have PLOs can use much cheaper components because the phase-lock circuitry can now*

RF TRANSISTORS

P N	2-30 MHz 12V (1		28V)	Match Pr.
	Rating	Net Ea.		
MRF421	Q 100W	\$24.00	\$53.00	
MRF422*	150W	38.00	80.00	
MRF433	12.5W	11.00	26.00	
MRF449/A	Q 30W	12.50	30.00	
MRF450/A	Q 50W	14.00	31.00	
MRF453/A	Q 60W	15.00	35.00	
MRF454/A	Q 80W	15.00	34.00	
MRF455/A	Q 60W	12.00	28.00	
MRF475	12W	3.00	9.00	
MRF476	3W	2.75	8.00	
MRF477	40W	12.00	26.00	
MRF479	15W	10.00	23.00	
MRF485*	15W	6.00	15.00	
MRF492	Q 90W	16.75	37.50	
MRF492A	Q 90W	19.75	43.50	
SRF2072	Q 65W	13.50	31.00	
SRF3662	Q 110W	25.00	54.00	
SRF3775	Q 75W	13.50	31.00	
SRF3795	Q 90W	16.00	37.00	
3800	Q 100W	18.75	41.00	
2SC2290	Q 80W	19.75	45.50	
2SC2879	Q 100W	25.00	54.00	

Q Selected High Gain Matched Quads Available

VHF UHF TRANSISTORS				
Rating	MHz	Net Ea.	Match Pr.	
MRF224	40W 136-174	13.50	32.00	
MRF237	4W 136-174	2.70	—	
MRF238	30W 136-174	13.00	30.00	
MRF239	30W 136-174	15.00	35.00	
MRF240, A	40W 136-174	15.00	35.00	
MRF245	80W 136-174	28.00	65.00	
MRF247	75W 136-174	27.00	63.00	
MRF248	80W 136-174	33.00	71.00	
MRF641	15W 407-512	22.00	49.00	
MRF644	25W 407-512	24.00	54.00	
MRF646	40W 407-512	26.50	59.00	
MRF648	60W 407-512	33.00	69.00	
SD1441	150W 136-174	74.50	170.00	
SD1447	100W 136-174	32.50	78.00	
2N6080	4W 136-174	6.25	—	
2N6081	15W 136-174	8.00	—	
2N6082	25W 136-174	9.50	—	
2N6083	30W 136-174	9.75	24.00	
2N6084	40W 136-174	13.00	31.00	

PARTIAL LISTING OF MISC. TRANSISTORS			
JO3020	\$15.00	2N1522	\$11.95
JO3055	31.00	2N3866	1.25
MRF134	16.00	2N4048	11.95
MRF136	21.00	2N4427	1.25
MRF137	37.00	2N5590	8.00
MRF138	35.00	2N5591	11.00
MRF140	89.00	2N5642	11.00
MRF148	35.00	2N5643	13.75
MRF150	89.00	2N5646	13.00
MRF172	62.00	2N5945	10.00
MRF174	80.00	2N5946	10.25
MRF208	11.50	2N6255	2.50
MRF406	12.00	2SC1307	2.50
MRF458	20.00	2SC1946	16.50
MRF497	10.00	2SC2097	29.50
MRF515	2.50	2SC2312	4.75
MRF607	2.50	2SC2630	24.75
MRF630	3.50	25W VHF MODULES	
MRF843	22.50	SAV6	34.50
MRF846	43.50	SAV7	34.50
MRF873	24.50	M57733	(use SAV7)
NE41137	3.50	SC1019	(use SAV7)

We stock RF Power transistors for Atlas, KLM, Collins, Yaesu, Kenwood, Cubic, Mirage, Motorola, Regency, etc. Cross-reference on CD, PT, SD, SRF, JO, and 2SC P/Ns.

Orders received by 1 PM are shipped UPS same day. Minimum order twenty dollars. COD/VISA/MC Foreign Orders Accepted

Call: (619) 744-0728

FAX: (619) 744-1943



RF PARTS

1320 Grand Avenue
San Marcos, CA 92069

800-882-1343

ICOM



IC-735	List	Juns
IC-735 Gen. Cvg. Xcvr	\$999.00	Call \$
IC-751A Gen. Cvg. Xcvr	1649.00	Call \$
R7000 Gen. Cvg. Rcvr.	1099.00	Call \$
R71A Gen. Cvg. Rcvr.	949.00	Call \$
IC-27A/H FM Mobile 25w/45w	429/459	Call \$
IC-28A/H FM Mobile 25w/45w	429/459	Call \$
IC-37A FM Mobile 25w	499.00	Call \$
IC-47A 440 Mobile 25w	549.00	Call \$
IC-04AT UHF HT	449.00	Call \$
IC-48A UHF 45w	459.00	Call \$
IC-38A FM Mobile 25w	459.00	Call \$
IC-02AT FM HT	399.00	Call \$
IC-μ2AT Micro HT	329.00	Call \$

KENWOOD



TS-440S/AT	List	Juns
TS-940SAT Gen. Cvg. Xcvr	\$2249.95	Call \$
TS-430S Gen. Cvg. Xcvr	819.95	Call \$
TS-711A All Mode Base 25w	899.95	Call \$
TR-751A All Mode Mobile 25w	599.95	Call \$
TM-201B FM Mobile 45w	369.95	Call \$
TM-2530A FM Mobile 25w	429.95	Call \$
TM-2550A FM Mobile 45w	469.95	Call \$
TM-2570A FM Mobile 70w	559.95	Call \$
TH-205 AT, NEW 2m HT	259.95	Call \$
TH-215A, 2m HT Has It All	349.95	Call \$
TH21BT 2M HT	259.95	Call \$
TH31BT 220 HT	269.95	Call \$
TH41BT 440 HT	269.95	Call \$

YAESU



FT-757GX	List	Juns
FT-757 GX Gen. Cvg. Xcvr	995.00	Call \$
FT-767 4 Band New	1895.00	Call \$
FT-270RH FM Mobile 45w	439.95	Call \$
FT-290R All Mode Portable	579.95	Call \$
FT-23 R/TT Mini HT	299.95	Call \$
FT-209RH RM Handheld 5w	359.95	Call \$
FT-726R All Mode Xcvr	1095.95	Call \$
FT-727R 2M/70CM HT	479.95	Call \$
FT-2700RH 2M/70CM 25w	599.95	Call \$



3919 Sepulveda Blvd.
Culver City, CA 90230
213-390-8003

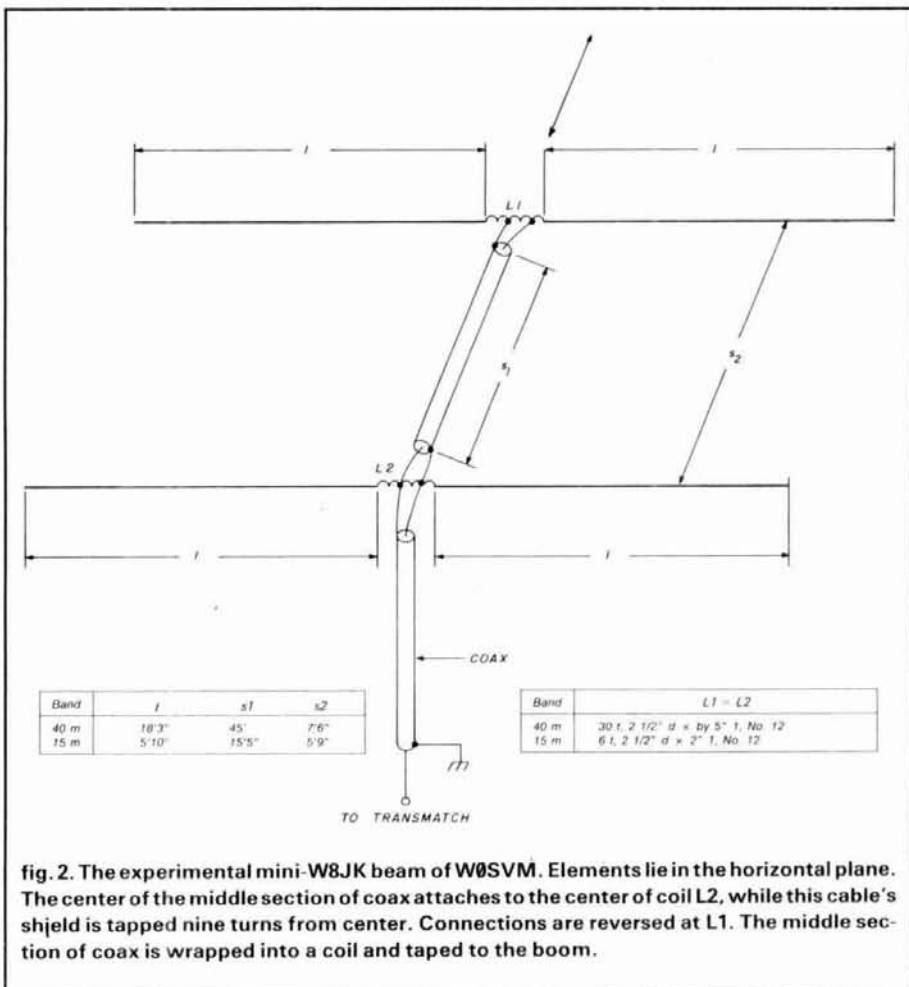

fig. 2. The experimental mini-W8JK beam of W0SVM. Elements lie in the horizontal plane. The center of the middle section of coax attaches to the center of coil L2, while this cable's shield is tapped nine turns from center. Connections are reversed at L1. The middle section of coax is wrapped into a coil and taped to the boom.

remove the local oscillator drift. Therefore, the manufacturer uses less expensive coils and capacitors and gets an oscillator which has a much lower Q and higher phase noise. The fact that the oscillator is phase-locked does not prevent the generation of noise that is far removed from the carrier.

I would suggest that Amateurs generate a set of standards for local oscillator phase noise. These standards would be much less stringent than some of the numbers that you mention. They only need to be adequate to guarantee non-interference based upon a reasonable set of assumptions. I would suggest something on the order of -140 dBc/Hz at whatever offset frequency one desires to achieve no interference. This would guarantee no interference for a 1-kW effective isotropic radiated power transmitter at a distance of 1 mile. A number of Amateur transceivers could then be

tested as to how well they meet these standards.

I have made phase noise measurements on an ICOM 745. It has a phase noise of better than -120 dBc/Hz at a 10-kHz offset, and better than -125/Hz at a 100-kHz offset. I think that is a pretty clean transceiver.

John closes his letter by saying: Phase noise is really in the same state as receiver dynamic range was 10 to 15 years ago. It yet has to be addressed by specific articles which deal with its causes, effects, and how to measure it.

I wish to thank the following individuals who sent me comments on white noise and also provided some interesting material on this subject:

- Dr. William J. Robertson, W8KHO, who sent a reprint of his article, "The Effects of Transmitter

*A more realistic value might be -125 dBc/Hz at 10 kHz offset. —W6SAI

1987 CALLBOOKS NOW AVAILABLE

The 1987 CALLBOOKS are in! Place your order now so you can get full use out of your valuable investment. All the latest names, callsigns and addresses make these two books invaluable operating aids.

NORTH AMERICAN CALLBOOK

Fully updated with all the latest up-to-date callsigns and addresses for all North American Hams. Includes handy operating aids such as; time charts, QSL bureaus, census information and much more. With calls from Panama to Greenland, every ham should have one in their shack. ©1986.

CB-US87 Softbound \$24.95

INTERNATIONAL CALLBOOK

Callsigns and addresses for all Amateur Radio operators outside of the North American continent. Invaluable aid to getting QSL cards from foreign DX'ers. Includes plenty of extra information too! Universally recognized as the source of QSL information. ©1986.

CB-F87 Softbound \$24.95

Order Both and SAVE.
Reg. Price \$49.95

Order NOW.

CB-USF \$44.95

**SPECIAL PRICE
SAVE \$5**



Please enclose \$3.50 shipping and handling
ham radio's bookstore
Greenville, NH 03048

(603) 878-1441
8-4 PM EST

Take it with you.



ShackMaster™ puts your home station in the palm of your hand. Whether portable, mobile, around the yard or around town you'll be linked through your handheld to your high performance equipment at home. Even call home from any Touch-Tone phone and operate.

Scan the bands, change modes, select antennas, turn gear on and off - all from your Touch-Tone keypad. Check into nets, work skeds, ragchew and DX without being tied down to the shack.

Exchange electronic mailbox messages with your family - like "I'll be late", or "All is OK". Or talk with your family directly through ShackPatch™, with you in remote control of your home station. Report traffic accidents or disabled motorists through your home phone while mobile or portable with PersonalPatch™.

All the power of your home station (and more) really can follow you anywhere... to find out more about ShackMaster™ just write, send us your QSL, or call and talk with us at 408-727-3330.

ACC

advanced
computer
controls, inc.

2356 Wash Avenue • Santa Clara, CA 95051

(408) 727-3330

✓ 151

CALL LONG DISTANCE ON YOUR HANDHELD

The Model 335A will deliver 35 watts of power using the latest state-of-the-art circuitry. The amplifier will operate SSB or FM and is compatible with most handheld transceivers, including the TR2400, TR2500, IC-2AT, Yaesu, Santec, and Ten-Tec. Only 300 mw input will deliver 5 watts out; 3 watts in will deliver 35 watts out. Maximum input drive level is 5 watts.

Our products are backed by prompt factory service and technical assistance.

WE SPECIALIZE IN: Complete parts list for the 140 watt, 300 watt RF amplifiers per Motorola Bulletins EB27, EB63, AN758 and AN762. We also carry a line of ATV equipment. Call or write us for our free catalog.

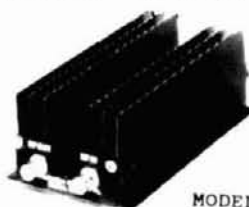

MODEL 335A Kit \$79.95
W&T \$99.95



CCI Communication
Concepts Inc.

121 Brown Street • Dayton, Ohio 45402 • (513) 220-9677



✓ 152

Measure Up With Coaxial Dynamics Model 85A Termination Wattmeter

A direct-reading instrument for servicing 50 ohm communication systems and maintaining them at peak operation.

The Model 85A features:

- Dry load no coolant required.
- Replaceable connectors, interchangeable without affecting instrument calibration.
- Four power ranges easily switchable — 0-3/15/50 and 150 watts full scale.
- Frequency Range: 20 to 512 MHz
- Accuracy: $\pm 5\%$ OFS
- Temperature Compensated

Contact us for your nearest authorized Coaxial Dynamics representative or distributor in our world-wide sales network.



**COAXIAL
DYNAMICS, INC.**

Service and Dependability... A Part of Every Product



15210 Industrial Parkway
Cleveland, Ohio 44135
216-267-2233 1-800-COAXIAL
Telex: 98-0630

Noise and Receiver Local Oscillator Noise in a Co-site Environment";

• **Douglas R. Schmieskors, Jr., WA6DYW**, who sent a reprint of "Phase Noise Intermodulation and Dynamic Range," written by Peter Chadwick of Plessey Semiconductors, Swindon, England;

• **Chod Harris, VP2ML**, who sent copies of the "DX Bulletin," which summarized problems various Amateurs have had with white noise;

• **Art Block, W3YK**, who reported severe white noise on his synthesized transceiver when subjected to heavy off-channel interference;

• **Hal Jones, W6ZVV**, who sent a reprint of "Oscillator with Odd-symmetrical Characteristics Eliminates Low Frequency Noise Sidebands," from the *IEEE Transactions on Circuits and Systems*, September, 1984.

More information on the subject is coming in. Stay tuned.

ham radio



**NEW
PACKET
BOOKS**

THE DIGITAL NOVICE



by
Jim Grubbs, K9EI



THE PACKET RADIO HANDBOOK

by Jonathan Mayo, KR3T

Packet radio is the fastest growing mode in Amateur operation today. No wonder — it combines the power of today's microcomputer with worldwide digital communications. New-comers will find this book to be full of helpful tips, tricks and information that will help get them on Packet as quickly as possible. Providing you first with packet basics, this book progresses through the inner workings and operational aspects of packet to a look at future technology still in developmental stages. Also includes: using bulletin boards, traffic handling on packet, modulation methods and networking principles, protocols (both AX.25 and VADCG) and a thorough discussion of the various TNCs and accessories available.

©1987 1st Edition 218 pages.

T-2722

Softbound \$14.95

Please enclose \$3.50 to cover shipping and handling.

THE DIGITAL NOVICE

by Jim Grubbs, K9EI

Now that novices have digital privileges, there are thousands of new Amateurs anxiously awaiting to get on-the-air. Who's going to answer their questions, however? Jim Grubbs' new book, *The Digital Novice*, is written with beginner's needs in mind. Each of the popular digital modes is fully covered with a brief history and full description of how it works. Hardware and software are covered in clear, concise terms. The book finishes with a look toward the future. Four appendixes cover; Morse, Baudot, AMTOP and ASCII Codes and has a glossary full of commonly used but misunderstood terms. Great for beginners and experts alike. ©1987 1st edition

JG-DN

Softbound \$9.95

ham radio magazine **BOOKSTORE**
GREENVILLE, NH 03048 603-878-1441

When You Decide to Decipher de Code



ege, inc.

EGE VIRGINIA
13646 Jefferson Davis Highway
Woodbridge, Virginia 22191
Information: (703) 643-1063
Service Dept: (703) 494-8750

Store Hours: M-Th: 10-6
F: 10-8
Sat: 10-4

Order Hours: M-F 9-7
Sat: 10-4

EGE NEW ENGLAND
8 Stiles Road
Salem, New Hampshire 03079
New Hampshire Orders.*
Info & Service: (603) 898-3750
or call 800-336-4799

Store Hours: MTWTF: 10-4
ThF: Noon-8

*Order & we'll credit you \$1 for the call.

LACOMBE
DISTRIBUTORS

Our associate store
Davis & Jackson Road, P.O. Box 293
Lacombe, Louisiana 70445
Info & Service: (504) 882-5355



Terms: No personal checks accepted.
Prices do not include shipping. UPS
COD fee: \$2.35 per package. Prices are
subject to change without notice or
obligation. Products are not sold for
evaluation. Authorized returns are sub-
ject to a 15% restocking and handling
fee and credit will be issued for use on
your next purchase. EGE supports the
manufacturers' warranties. To get a
copy of a warranty prior to purchase,
call customer service at 703-643-1063
and it will be furnished at no cost.

**Spring Buyer's
Guide/Catalog
Available - Send \$1.**

Antennas

Amateur HF Bands

Cushcraft, Butternut, KLM,
Mosley, Hy-Gain, Mini-
Products, B&W, Van Gardin,
Hustler, Larsen, Antenna
Specialists, Centurion, Smiley

Antennas in Stock for Mobiles, Base Stations, and Handhelds

Everything from mini rubber
duckies to huge monobanders

**ASK FOR PACKAGE
DEALS ON ANTENNAS
AND ACCESSORIES**

Also...

Antennas for Scanners, CBs,
Marine, Commercial, and
Short Wave Listening

YAESU



FT 23/73
Mini Handhelds
for 2m/440 MHz

FT 727R
2m/440 MHz Dual Band HT



FT 767GX
All Mode Transceiver
with CAT System



FRG 8800
General Coverage Receiver
All mode 150 kHz-30 MHz



FRG 9600
Scanning Receiver
for 60-905 MHz FM/AM/SSB

Towers

UNARCO-ROHN TRI-EX HY-GAIN

Ask for package quotes on
complete tower assemblies
including Phillystran, guy
wire, antennas, rotators, etc.

ROTATORS

Kenpro, Alliance, Daiwa,
Telex Hy-Gain

ICOM



IC 751A
HF Transceiver with
General Coverage Receiver



IC 3200
2m/440 MHz Mobile



IC 275A
All-mode Transceiver



R 7000
General Coverage Receiver

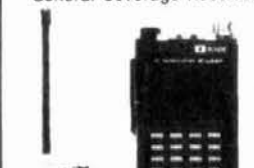

Micro 2AT
Mini 2m Handheld

IC 02AT/03AT/04AT
Handheld for 2m/220/440

Computer Stuff

Packet Controllers

Kantronics and MFJ

Amateur Software

Ham Data Software for
Commodore Computers
Ask for Descriptions

RTTY/Morse/Amtor

Hardware and Software and
packages by Kantronics,
Microlog, HAL, MFJ, & more

KENWOOD



TS 440S
HF Transceiver
with Antenna Tuner



TS-940S
HF Transceiver with
General Coverage Receiver



New TM 221A/421A
2m/440 MHz Mobile



TH 215AT
2m FM Handheld

TH 21BT/31BT/41BT
Mini Handhelds
for 2m/220 MHz/440 MHz



R 5000
General Coverage Receiver

Accessories

AMPLIFIERS

Vocom, Daiwa, TE Systems,
Amp Supply, Mirage, Alinco,
Ameritron, Tokyo Hy-Power,
RF Concepts

ANTENNA TUNERS

Amp Supply, Ameritron, MFJ

**Switches, Couplers, Filters,
Connectors, Mikes, Keysers,
Paddles, Headsets, Clocks,
Books, Power Supplies**

**SPECIAL
PACKAGE
DEALS FOR
NOVICES**
Radios/Antennas
Call for info

TEN-TEC



RX 325
Short Wave Receiver



Paragon
Amateur Transceiver with
General Coverage Receiver

KDK



FM 240
Compact 2m Mobile Radio

More Radios

ALINCO
Radios Now in Stock

**SONY
PANASONIC**
Receivers

**REGENCY
BEARCAT**
Scanners

MIDLAND
CB Radios

COBRA
CBs, Radar Detectors, Phones

UNIDEN
CBs, Radar Detectors

WHISTLER
Radar Detectors

Southwestern Bell
Telephones

For Orders & Quotes Call Toll Free: 800-336-4799
In New England Call 800-237-0047 In Virginia Call 800-572-4201

ALL NEW!

DUAL BAND ANTENNAS FOR ULTIMATE PERFORMANCE!!

Model	Description	Sug. List
2X4Z	Base/Repeater 200 Watt Gain 146 MHz 8.2dB, 446 MHz 11.5dB	\$168.95
2X4SR	Mobile with Mag. Mt. 150 Watt Gain 146 MHz 3.8dB, 446 MHz 6.2dB	71.90
2X4SDY	Mobile with Mag. Mt. 100 Watt Gain 146 MHz 2.15 dB, 446 MHz 3.8dB	65.95
HT 702	146/446 MHz Hand Held BNC 50 Watt	29.95
C7-71	Base/Repeater 920 MHz 50 Watt 7.14 dB Gain	\$115.95
C202N	Mobile 920 MHz with Mag. Mt. 5 dB Gain 50 Watt	72.95
1234E	Base/Repeater 200 Watt Gain 446 MHz 8.5dB, 1.2 GHz 10.1dB	\$178.95
124X	Mobile with Mag. Mt. 100 Watt Gain 446 MHz 2.5dB, 1.2 GHz 3.5dB	104.95
1221S	1.2 GHz Base/Repeater 100 Watt Gain 15.5dB, 21 Step colinear	\$158.95
1210M	1.2 GHz Mobile with Mag. Mt. 50 Watt Gain 8.8dB	76.95
415M	High power duplexer 146 MHz 400 Watt 446 MHz 250 Watt	59.95
412N	UHF/GHz Duplexer 446/1400MHz Max. 70 Watt	68.95



1275 NORTH GROVE ST.
ANAHEIM, CALIF. 92806
(714) 630-4541
CABLE: NATCOLGLZ
FAX (714) 630-7024

Dealer prices may be
different than list.

Prices and specifications subject to
change without notice or obligation.

✓ 144

SYNTHESIZED SIGNAL GENERATOR

MADE IN
USA



MODEL
SG-100F
\$429.95
delivered

- Covers 100 MHz to 199.999 MHz in 1 kHz steps with thumbwheel dial
- Accuracy +/- 1 part per 10 million at all frequencies
- Internal FM adjustable from 0 to 100 kHz at a 1 kHz rate
- External FM input accepts tones or voice
- Spurs and noise at least 60 dB below carrier
- Output adjustable from 5-500 mV at 50 Ohms
- Operates on 12 Vdc @ 1/2 Amp
- Available for immediate delivery • \$429.95 delivered
- Add-on accessories available to extend freq range, add infinite resolution, AM, and a precision 120 dB attenuator
- Call or write for details • Phone in your order for fast COD shipment.

VANGUARD LABS ✓ 145

196-23 Jamaica Ave., Hollis, NY 11423
Phone: (718) 468-2720 Mon. thru Thu.

THE ALL-IN-ONE DTMF DECODER



**AUTO-KALL
AK-4
NEW!**

- SELECTIVE CALLING MODE: 2-3 or 4 digit personal call, general call, call up all users and up to 15 groups, each 8K. Can be used to any of 4 group calls.
- Latched group call output • 100 personal call group call and group indicators
- Variable timer output can be used with on board relay to turn on a speaker
- REMOTE CONTROL MODE: Locking/unlocking code can be programmed with different first digits, i.e. 122 to unlock, 123 to lock
- 2 independently selectable latched outputs
- 2 memory outputs
- On Board SPEAKER can be used with any output
- High quality AT&T combined decoder chip
- Anti-fading wiring method most commonly used
- Low power CMOS chips

AK-4W: Wired/ Tested Board: \$89.95 (Plus \$2.00 Shipping/Handling)
AK-4K: PCB Kit: 69.95 (Plus \$2.00 Shipping/Handling)
AK-4H: Hardware Kit: 29.95 (Plus \$2.00 Shipping/Handling)
(Hardware enclosure, speaker, spacers, switches, jacks, LED holders)

NET-KALL NK-1 THE ECONOMY DTMF DECODER
Call all users and up to 15 individual groups. When triggered, output turns on for 3 to 2.5 seconds, holds on for 100 ms, relay on, or can stay on until manually reset

NK-1W: Wired/ Tested Board: \$49.95 (Plus \$2.00 Shipping/Handling)
NK-1K: PCB Kit: 39.95 (Plus \$2.00 Shipping/Handling)

MoTRON ELECTRONICS

695 W 21st Avenue • Eugene, Oregon 97405
TEL: (503) 687-2118 • TLX: 650-3157002 MCI
VISA / MasterCard / Check / COD

✓ 147

CADDELL COIL CORP.

35 Main Street
Poultney, VT 05764
802-287-4055

BALUNS

Get POWER to your antenna! Our Baluns are already wound and ready for installation in your transmatch or you may enclose them in a weatherproof box and connect them directly at the antenna. They are designed for 3-30 MHz operation. (See ARRL Handbook pages 19-9 or 6-20 for construction details.)

100 Watt (4:1, 6:1, 9:1, or 1:1 Impedance—select one)	\$10.50
Universal Transmatch 1 KW (4:1 Impedance)	14.50
Universal Transmatch 2 KW (4:1 Impedance)	17.00
Universal Transmatch 1 KW (6:1, 9:1, or 1:1—select one)	16.00
Universal Transmatch 2 KW (6:1, 9:1, or 1:1—select one)	18.50

Please send large SASE for info.

AMATEUR RADIO MAIL LISTS

Self-stick 1x3 labels

- *** NEWLY LICENCED HAMS ***
- *** ALL NEW UPGRADES ***
- *** UPDATED EACH WEEK ***

Total List = 462,728 (ZIP sorted)
Price is 2.5 cents each (4-up Cheshire)

BUCKMASTER PUBLISHING
Mineral, Virginia 23117
703-894-5777

✓ 145

WIDEBAND PREAMPLIFIER

5 MHz to 950 MHz
Gain=22dB, NF=4dB, IP=25dBm



Other preamps 140-160, 210-230, 420-450 MHz available

WI-COMM ELECTRONICS INC.

P.O. Box 5174, MASSENA, N.Y. 13662
(315) 769-8334

✓ 148

NBS time and frequency survey

Uncle Sam
wants *your* input

The National Bureau of Standards has invited readers to participate in its 1987 survey of users of NBS time and frequency services. More than 10,000 responses to the last survey (1975) were received; according to the NBS, these were "invaluable" in planning and carrying out the mission of the NBS over the past decade.



WWV and WWVB signals are broadcast from these antennas located about 7 miles north of Fort Collins, Colorado. The tall WWVB (60-kHz) array is fed from the building at left center, and the WWV antennas are powered from the building at right center. (Most of the WWV vertical dipoles are to the right, and scarcely visible.) Traces of the buried ground plane wires radiate from under the WWVB array.

This year the NBS is expanding the scope of its survey to include not only WWV, WWVH, and their associated telephone-accessible time-of-day services, but also the WWVB 60-kHz service and the newer GOES satellite time code broadcasts. Your responses will help NBS provide the best mix and levels of time and frequency services in the future, consistent with your needs and NBS resources.

Please answer each question that is appropriate to your use of the NBS services. Even if you answer only some of the questions, your responses will be of great help to NBS. If your responses represent the views of an entire organizational unit, please indicate that fact, clearly identifying the name of the organization you represent.

For those who may be relatively unfamiliar with the present NBS services, the term *GOES*, as used in the questionnaire, refers to the Geostationary Operational Environmental Satellites that broadcast the NBS time code. *DUT1* refers to information included in NBS broadcast formats that provides the approximate difference between the UT1 astronomical time scale and the UTC atomic time scale. *Marine Weather* refers to the marine storm warning announcements provided on WWV and WWVH, and *Geoalerts* refers to the WWV announcements relating to solar activity and solar-terrestrial conditions. *Omega* refers to the WWV and WWVH announcements that relate to the current status of the U.S. Coast Guard's Omega Navigation System. *BCD Time Code* refers to the time-of-day information in binary-coded-decimal form provided on 100-Hz subcarriers on WWV and WWVH.

Please cut out and mail your completed questionnaire to the Time and Frequency Division, 524.00, National Bureau of Standards, 325 Broadway, Boulder, Colorado 80303. (No postage is necessary if mailed within the United States.)

United States Department of Commerce,
National Bureau of Standards, 325 Broadway,
Boulder, Colorado 80303

ANNOUNCING SOUND OFF MODEL 10



Sound Off Model 10 is a self-contained message generator complete with case and power supply. The Model 10 was designed specifically for applications where repetitive high quality natural voice announcements are required, i.e. Amateur repeater and commercial radio systems. The Model 10 stores your

natural voice message in nonvolatile EPROM with single message lengths of up to 32 seconds. The Model 10 provides for both single and continuous play modes. Factory settable internal timers can set timing intervals from seconds to 30 minutes or more. All control functions and timers are provided for this application. (COR sense, transmitter activity sense, PTT, ID timer.)

Models 20, 100 and 150 available for applications requiring random access multimessage capabilities in nonvolatile re-recordable message times of up to 4 minutes.

Model 10 prices start at \$219.00.

Now for the first time you can enjoy the truly unique operation of a Digital Voice Announcement System, designed specifically for Amateur Radio communications. The DVK-100 represents the latest technology in digital audio processing.

Create your own natural voice contest calls, CO's etc. Your voice is stored in digital memory, ready to be played back at the touch of a key. The Digital Voice Keyer is not a tape recorder or robotic sounding synthesizer but a true full fidelity natural voice record/playback system.

The DVK-100, is a must for the avid contest and great audio accessory for any Ham Shack.

FEATURES

- Superior natural voice quality
- Micro processor controlled
- 32 seconds of message time
- PTT/VOX operation
- Dynamic/condenser mic input
- Selectable monitor amplifier with preset level controls
- Selectable audio compressor
- Sealed membrane keyboard
- 4 independent voice memories
- Positive/negative keyed PTT
- ESD/EMI/RFI shielding
- Selectable end of transmission tone generator

✓ 141

The sound of the future is here today. Contact your local Amateur Radio dealer or NTL for further information.

\$249.00 SUGGESTED NET
AMATEUR PRICE

DEALER INQUIRIES INVITED



NEL-TECH LABS, INC.
28 DEVONSHIRE LANE • LONDONDERRY, NH 03053
603-434-8234



INTERNATIONAL MONTHLY MAGAZINE BY AND FOR ACTIVE RADIOAMATEURS

Radiosporting

THIS IS IT! - FOR BIG GUNS & LITTLE PISTOLS

A magazine dedicated to quality and sportsmanship in amateur radio operating. Fresh, timely, practical and down to earth reading for little pistols and big guns. Written by the world's best in their fields: ON4UN, SM0AGD, LZ2CJ, VE3BMV, KH6BZF, DJ9ZB, ZS6BRZ, W1WY, N2AU, K7GCO, K4ZN, W4GF, VE3JTQ, WB4ZNH, WB9TBU, KQ2M, NS6X, W3FG, KA3B, K1PLR, N7CKD, VE3XN, AB0X, JE1CKA and others.

Includes DX News, QSL Info, 160m, 80m, 10m, 6m columns, DXpeditioning, Propagation, Awards, Contest rules and results, Traffic - Emergency, FCC News, New Products, Antennas, Technical news and articles, equipment reviews and modifications, computer programs, Radio Funnies, Club Life, RTTY, VHF/UHF, Mail Box, Classified Ads and much more in a magazine format with the speed of a bulletin.

RADIOSPORTING sponsors DX Century Award, Contest Hall of Fame and World Radio Championship contest.

"Your publication is superb! Keep it up!" **Joe Reisert, W1JR**

"Your W2PV articles are priceless. Your magazine is super!"
Rush Drake, W7RM

"Let me congratulate you on a very impressive magazine. Just what I've been looking for as a DXer and Contester!"

Dick Moen, N7RO
"RADIOSPORTING, once received, cannot be tossed aside until it is read from cover to cover. Then reviewed again and again."
Chas Browning, W4PKA

Subscription rates: 1 year USA \$18, Canada CDN\$26, Overseas US\$23; 2 years \$33, \$48, \$42 respectively. Single issue \$2. USA First Class Mail add \$8/year, DX Air Mail add \$15/year.

TRY US! SUBSCRIBE OR SEND \$1 FOR YOUR SAMPLE COPY.

RADIOSPORTING Magazine
PO Box 282, Pine Brook, NJ 07058, USA



✓ 142

Join AMSAT...Today

Amateur Radio Satellite OSCAR 10 provides:

- **A New Worldwide DX Ham Band** open 10 hours a day.
- **Rag Chew With Rare DX Stations** in an uncrowded, gentlemanly fashion.
- **Popular Modes In Use:** SSB, CW, RTTY, SSTV, Packet
- **Full Operating Privileges** open to Technician Class licensee or higher.

Other AMSAT Membership Benefits:

Newsletter Subscription:

Dependable technical articles, satellite news, orbital elements, product reviews, DX news, and more.

Satellite Tracking Software
Available for most popular PCs.

QSL Bureau, AMSAT Nets, Area Coordinator Support, Forum Talks

Construction of Future Satellites For Your Enjoyment!

AMSAT Membership is \$24 a year, \$26 outside North America. VISA and MC accepted.

AMSAT
P.O. Box 27
Washington, DC 20044

301 589-6062

✓ 143

1987 SURVEY OF NBS TIME AND FREQUENCY SERVICE USERS

My responses primarily reflect the view of: an individual an organization

Organization name _____ Approximate number of time and frequency users in this organization _____

USE OF CURRENT SERVICES	WWV (MHZ)					WWVH (MHZ)				WWVB 60 KHZ	GOES SATELLITE 469 MHZ	TELEPHONE	
	2.5	5	10	15	20	2.5	5	10	15			WWV	WWVH
How often do you use each of these NBS services? (0=Never; 1=Rarely; 2=Sometimes; 3=Frequently)													
How often do you observe harmful interference when using these services? (0=Never; 1=Rarely; 2=Sometimes; 3=Frequently)													
How would you characterize your usual reception reliability? (0=Extremely poor; 1=Poor; 2=Generally adequate; 3=Excellent)													
Do you usually use these services during daytime or nighttime hours? (D=Day; N=Night; B=Both)													

ADEQUACY OF CURRENT SERVICES	WWV	WWVH	WWVB	GOES SATELLITE	TELEPHONE TIME-OF-DAY
Do the current NBS services satisfy your needs for accuracy? (0=No; 1=Marginally; 2=Generally yes; 3=Yes)					
Do the current NBS services satisfy your needs for reliability of reception and ease of use? (0=No; 1=Marginally; 2=Generally yes; 3=Yes)					

FOR USERS OF WWV AND WWVH	VOICE TIME OF DAY	BCD TIME CODE	1-SECOND TICKS	STANDARD FREQUENCY	DUTI VALUES	MARINE WEATHER	GEOALERTS	OMEGA STATUS
Which types of information on these broadcasts do you use at least occasionally? (Indicate by checking each appropriate box)								
How important is each type of information? (0=Not at all; 1=Marginal importance; 2=Important; 3=Very important)								
Is the present quality of the voice announcements of weather, geoalerts, and Omega System status adequate for your needs? (Yes or No)	<input type="checkbox"/> Yes <input type="checkbox"/> No <i>If no, why?</i> _____							

FOR USERS OF WWVB	STANDARD FREQUENCY	TIME CODE
How important to you or your organization is each of these aspects of WWVB? (0=Not at all; 1=Marginal importance; 2=Important; 3=Very important)		

FOR USERS OF THE GOES SATELLITE TIME CODE
Does interference in your area significantly hinder the usefulness of the satellite time code? (Yes or No) <input type="checkbox"/> Yes <input type="checkbox"/> No
Do you use the GOES time code status reports by accessing the "NBSGO" file in the U.S. Naval Observatory's Automated Data Service System? (Yes or No) <input type="checkbox"/> Yes <input type="checkbox"/> No
Do you use the full accuracy of the time code (100 microseconds) via a receiver that automatically corrects for path delay variations? (Yes or No) <input type="checkbox"/> Yes <input type="checkbox"/> No
Do the occasional time code shifts of more than 100 microseconds at times of satellite maneuvers cause serious problems for your application? (Yes or No) <input type="checkbox"/> Yes <input type="checkbox"/> No

FOR USERS OF THE WWV OR WWVH TELEPHONE TIME-OF-DAY SERVICES
How often do you encounter busy signals when calling (303) 499-7111 or (808) 335-4363? (0=Never; 1=Rarely; 2=Sometimes; 3=Frequently) <input type="checkbox"/>
Would the value of these services be decreased if only a high-quality voice time announcement were available without the weather, geoalert, or Omega status information? (Yes or No) <input type="checkbox"/> Yes <input type="checkbox"/> No
If yes, why? _____

(OVER)

PLEASE FOLD AND TAPE BEFORE MAILING. DO NOT STAPLE!

POSSIBLE FUTURE CHANGES IN NBS SERVICES	ACCURACY	RECEPTION RELIABILITY	COVERAGE AREA	EASE-OF-USE	USER COST
In the development of future time and frequency services which of the following aspects need the most improvement? (Check appropriate boxes)					
If the availability of new services in the future with improved capabilities in terms of accuracy, reliability, coverage, etc. required the payment of an annual user fee of less than \$250/year, would you or your organization likely subscribe to such a service? (Yes or No) <input type="checkbox"/> Yes <input type="checkbox"/> No					
Do you need NBS timing signals designed for direct interfacing to computers? If "Yes", what accuracy level is needed? <input type="checkbox"/> Yes <input type="checkbox"/> No Accuracy Level _____					
What new or improved time and frequency services would you find useful? (Please describe briefly) _____					

USER DATA

Please indicate which of the items below apply to you as a user of NBS services: (✓)

- | | | | |
|--|--|---|--|
| <input type="checkbox"/> Private Citizen | <input type="checkbox"/> Electric Power Industry | <input type="checkbox"/> Communications Systems | <input type="checkbox"/> Pleasure Boating |
| <input type="checkbox"/> Government/civilian | <input type="checkbox"/> Telephone Industry | <input type="checkbox"/> University | <input type="checkbox"/> Equipment Manufacturing |
| <input type="checkbox"/> Government/military | <input type="checkbox"/> Aviation/aerospace Industry | <input type="checkbox"/> Geophysics/seismology | <input type="checkbox"/> Jeweler/watchmaker |
| <input type="checkbox"/> Radio/TV Operations | <input type="checkbox"/> Transportation Systems | <input type="checkbox"/> Health Care Industry | <input type="checkbox"/> Amateur Radio |
| <input type="checkbox"/> Standards Lab | Other (Specify) _____ | | |

Please indicate which of the items below describe the purposes for which you use the NBS time and frequency services: (✓)

- | | | | |
|---|--|--|---|
| <input type="checkbox"/> Frequency Calibrations | <input type="checkbox"/> Time Base for Computers | <input type="checkbox"/> Surveying | <input type="checkbox"/> Astronomy |
| <input type="checkbox"/> Watch/clock Setting | <input type="checkbox"/> Time Base for Synchronizing or Controlling Operations | <input type="checkbox"/> Space/missile tracking | <input type="checkbox"/> Hobby |
| <input type="checkbox"/> Master Clock | <input type="checkbox"/> Time Base for Data Monitoring | <input type="checkbox"/> Marine Weather | <input type="checkbox"/> Geolart Information |
| <input type="checkbox"/> Navigation/Position Location | | <input type="checkbox"/> Propagation Information | <input type="checkbox"/> Omega System Information |

Other (Specify) _____

In what state of the United States or foreign country do you use the NBS time and frequency services? (Two-letter state abbreviation or country) _____

Please estimate the annual economic value of the NBS time and frequency services to you or your organization, if possible. \$ _____

Additional Comments:

U.S. DEPARTMENT OF COMMERCE
National Bureau of Standards
 325 Broadway
 Boulder, Colorado 80303

OFFICIAL BUSINESS
 Penalty for Private Use, \$300



POSTAGE AND FEES PAID
 U.S. DEPARTMENT OF COMMERCE
 COM-215

Time & Frequency Division, 524.00
National Bureau of Standards
 325 Broadway,
 Boulder, CO 80303

**AUTHORIZED KENWOOD
I-COM RADIO DEALER**



✓ 137

H. L. HEASTER, INC., 203 Buckhannon Pike, Clarksburg, W. Va. 26301 Clarksburg Phone (304) 624-5485 or W. Va. Toll-Free 1-800-352-3177

HAROLD HEASTER, KA8OHX, 91 Ridgefield Place, Ormond Beach, FL 32074 Florida Phone (904) 673-4066

**NEW NATION-WIDE TOLL-FREE TELEPHONE 1-800-84-RADIO
1-800-84-72346**

Call us for a quotation, WE WILL SAVE YOU MONEY!

**SPECIALISTS
IN FAST TURN
P.C. BOARDS**

**PROTO TYPE P.C. BOARDS
AS LOW AS \$25.00**

- SINGLE & DOUBLE SIDED
- PLATE THROUGH HOLES
- TEFLON AVAILABLE
- P.C. DESIGN SERVICES

FOR MORE INFORMATION

MT Midland Technologies

34374 EAST FRONTAGE ROAD
BOZEMAN, MT 59715 (406) 586-1190

✓ 138

**Full Feature
Remotely Programmable
Repeater Controller
for under \$600**

- ✓ Field tested for over 2 years
- ✓ Full 2 year warranty

FREE

Free Full Color Brochure

Call Toll-Free

1-800-621-8387

ext. 244, 8 am - 5 pm Mountain Time

Or Write: **S-COM**
INDUSTRIES

✓ 187

P.O. Box 8921 • Fort Collins, CO 80525

TELEWAVE ANTENNAS

HAVE YOU EVER SEEN A MILLENNIUM SEAL?



TELEWAVE, INC.

1155 TERRA BELLA, MOUNTAIN VIEW, CALIFORNIA 94043
(415) 968-4400 • TWX 910-3795055

The Land Mobile Communication industry recognizes the open dipole base station antenna, with a direct feed to each element, as the most versatile and efficient gain antenna available. Why doesn't everyone use this type of antenna? The answer is obvious; DURABILITY. The antennas supplied by major manufacturers of Open Dipole Antennas to the communications market today, have one common fault. After a short period of time, contaminants leak into the cable harness junctions and destroy the performance of the antenna. Finally, the problem has been solved by Telewave's new MILLENNIUM-SEAL™. This space-age compound forms a permanent protective bond on the cable junctions that long outlasts all previous protective methods. Using our new MILLENNIUM-SEAL™ enhances the time proven design and by the application of our black epoxy coating over the alodined aluminum surface sets a new standard for the communications industry. Telewave is a full line supplier of all types of antenna systems, including end fed fiber glass, and yagi antennas. We also offer a full compliment of communications cables and connectors for land mobile and microwave that meet every installation requirement.

✓ 140

**NEW
NEW
NEW**

**RADIO HANDBOOK
23rd Edition**

by Bill Orr W6SAI

22424 Hardbound \$26.95

Reg. 29.95 SAVE \$3

Please enclose \$3.50 to cover shipping and handling



**ham
radio** magazine

GREENVILLE, NH 03048

BOOKSTORE

603-878-1441

Understanding Automatic Antenna Tuners

One of the most popular yet often misunderstood accessories in modern amateur radio setups is the fully automatic antenna tuner. While this item plays a significant role in any station's overall performance and enjoyment, inquiries regarding its specific use and operation continue surfacing during conventions and ICOM Day discussions. Answering those questions in a "shared knowledge" manner thus inspired this Tech Talk's topic.

The basic purpose of an automatic antenna tuner is matching an antenna's transmission line-presented impedance to that of a transceiver's output. This technique is usually referred to as **obtaining a low SWR for full band coverage**. Many of today's multiband dipoles, beams, and verticals exhibit narrowband characteristics, for example, and must be retuned for SSB or CW band segments before outdoor installation. Attempting subsequent operations in their less favored or "high SWR" range creates an impedance mismatch that restricts RF power output from their connected transceiver.

An antenna tuner utilizes a large multitapped coil and two variable capacitors to counteract undesired capacitive or inductive reactances and re-establish a matched condition between the transmission line and the transceiver. While this impedance matching doesn't eliminate coax cable losses, it does allow a station's transceiver to efficiently deliver its full output to the antenna system. This impedance matching arrangement has also been proven beneficial in reducing harmonic radiations and TVI.

The basic inner operation of all automatic antenna tuners is similar in nature. Initial band selection determines the

proper coil tap to be utilized while reversible motors position the variable capacitors at their point of lowest SWR. "Correction voltage" applied to the motors is derived from the tuner's SWR sensing circuits which, in turn, are activated by RF energy from the transceiver.

Manual antenna tuners perform similar impedance matching functions; however, the station operator must personally monitor SWR readings while trial-and-error selecting coil taps and rotating capacitors to find a proper impedance matching point. The convenience and enjoyment of an automatic tuner "following your lead and readying everything for action" creates a **deluxe setup that's a pleasure to operate**.

There are presently two design variations in automatic antenna tuners: the totally "hands off" unit, and the operator-adjustable unit. "Hands off" units typically exhibit a limited impedance matching range and can't be operator fine-tuned. Operator-adjustable units usually exhibit a comparatively wider tuning range and offer greater overall station flexibility, but improper settings must be minimized.

ICOM's fully automatic AT-500, AT-100, and AT-150 antenna tuners incorporate the best features of previously discussed concepts in their designs. They can be used as a strictly automatic/hands-free unit or operator-adjusted when desired. Additionally, each tuner includes an automatic **four-selection antenna switch** and a transceiver interfacing cable for fully automated station operating convenience. The AT-500 and AT-100 handle 500 and 100 watts, respectively, and operate automatically with all ICOM HF transceivers (LDA option required for IC-730). The AT-150 handles 100 watts and mates

with the compact IC-735 for true "dream station" performance.

Operating an AT-500/AT-100/AT-150 equipped ICOM station is an amateur's delight. When a particular band is selected on the station's transceiver, the "slaved" tuner connects the required antenna and internal coil tap. Transmitting a brief low power signal then allows the tuner to adjust its capacitors for an optimum impedance match, and the station is ready for action. If additional "tweaking" is desired, a top access hatch permits indirectly fine tuning capacitor settings. Four LEDs (two for each capacitor) provide direct assistance by indicating the resonant point of each control. Merely ensure the tuner's AUTOMATIC/Preset (Manual operation) switch is in its **AUTO** position, then rotate the controls until all LEDs extinguish. If a particular antenna exhibits exceptionally high SWR, the tuner may be switched into preset/manual operation. The previously mentioned internal controls may then be (slowly) adjusted while monitoring SWR on the transceiver's meter. Two capacitor-adjusting controls are provided for each band; thus, one band's antenna settings will not disturb another's. Two helpful hints: when **manually** presetting, always start with adjustments in **midrange**. When auto tuning reluctant antennas, try "**Walking**" the tuner by allowing it to fully retune in 25kHz steps rather than 300kHz jumps. Remember, also, all tuners have their limits.

Inclusion of an automatic antenna tuner in any HF setup truly opens an exciting new world of enjoyment. A smooth operating station also inspires investigation of new pursuits and modes. Naturally, ICOM wants you to enjoy amateur radio's many rewards in TOP style!



GET ON THE AIR WITH THE BEST

All Novices Can Now Talk on 220MHz, 10 meters and 1.2GHz.

ICOM extends congratulations to privilege-enhanced Novices, and invites everyone to extend their horizons with ICOM!

ICOM is the only amateur radio manufacturer hosting a full product line especially geared toward privilege-enhanced Novices (and Technicians joining 10-meter activity). Whether your interests include 1.2GHz, 220MHz, HF bands, FM, CW, or SSB, choosing ICOM gear means going First Class!

Explore 1.2GHz DX attractions and local activities with pacesetter ICOM gear. The all mode IC-1271A base station transceiver includes numerous de-

lux features and is expandable with your future interests. FM mobiling pleasures begin with ICOM's new 10 watt IC-1200A which is easy to install and operate. Every amateur enjoys hand-held portable operations, and ICOM's deluxe IC-12AT handheld is ready to go.

Experience 220MHz activities using top quality ICOM equipment. For your multi-mode interests is the new IC-375A 25-watt base station transceiver: a true masterpiece of modern technology. ICOM's ultra slim IC-37A and compact IC-38A are ideal 25-watt mobile units. For a versatile and rugged handheld, choose the deluxe IC-03AT or the ever-popular IC-3AT.

Enjoy HF QSOs worldwide and depend on ICOM transceivers for top communications performance. The exciting new IC-761 offers you superb "everything in one cabinet" operation. Or there's the ICOM deluxe midsize transceivers, the IC-751A and IC-745. The IC-735 is today's most popular fixed/mobile rig. Also, friends, all ICOM HF transceivers include a full one-year warranty.

ICOM Accessories are interchangeable. Use them with ICOM's 2-meter and 440MHz gear when you upgrade!

Get on the Air with ICOM and explore 1.2GHz, experience 220MHz, and enjoy HF QSOs.



ICOM
First in Communications

ICOM America, Inc., 2380-116th Ave. N.E., Bellevue, WA 98004 Customer Service Hotline (206) 454-7619
3150 Premier Drive, Suite 126, Irving, TX 75063 / 1777 Phoenix Parkway, Suite 201, Atlanta, GA 30349
ICOM CANADA, A Division of ICOM America, Inc., 3071 - #5 Road, Unit 9, Richmond, B.C. V6X 2T4 Canada

All stated dimensions are approximate and subject to change without notice or obligation. All ICOM radios significantly exceed FCC regulations limiting spurious emissions. NH287.

Heathkit



A completely mobile, programmable, electromechanical robot, HERO[®] 2000 is capable of interacting with its environment free of external control.



Hams! Get the latest in amateur radio technology including high-speed Packet Radio Communication.



Powerful new IBM-PC compatible Heathkit computers are yours to build easily and save with, or to buy assembled.



Build from our full line of precision test instruments and see how they can increase your troubleshooting effectiveness.



New Digital Rain Gauge records rainfall accurately and reads out inside your home in 100ths of an inch.

Your guide to everything that's new in electronics, computers and technical education. Over 400 items. Discover fascinating kits to build, enjoy and learn with, as well as assembled high tech products for home, business and hobby.

Get our famous High Tech Catalog

FREE

Heathkit[®]

Heath
Company

Heath Company
Dept. 122-544
Benton Harbor, Michigan 49022

MAIL COUPON TODAY and receive the latest issue of the Heathkit Catalog free of charge

Name

Address

City State

CL-783BR3 Zip

✓ 190

the TEXNET packet-switching network part 3: software overview

Z-80 assembly language
software offers
multi-node, multi-user
versatility in real time

In previous installments of this three-part series,^{1,2} we described network algorithms and the design and testing of network hardware. This month, we'll discuss node control software.

Contained in a single 27C256 ROM, the software determines the functions and user features offered by the network nodes. Highly modular in design, the software was written in Z-80 assembly language for two reasons: one, because the wide array of services offered by a single node put memory space at a premium; and two, because one or more of each node's ports would be operating at 9600 bps, therefore stressing real-time capacity.

Because space is limited, we'll discuss the functions of specific software areas rather than describe the software itself in detail. **Figure 1** illustrates a typical node, with each major software area indicated by a circled reference letter.

common logic

The common logic portion of the software package, identified as *A* in **fig. 1**, is responsible for memory allocation and management, real-time scheduling, and interfacing to the various hardware I/O devices, such as SIO's and the CTC. As an example of these house-keeping tasks, let's look at memory management. Because there are many more users for memory than there is memory capacity, memory management — specifically in regard to time-sharing — is critical to efficient system operation. The generic problem with most memory management schemes, however, is *deadlock*, which occurs, for example, when a memory user has some memory allocated and needs more to complete the job, but can't get more because of what's already been assigned. The node software package follows a procedure known as *load shedding* to prevent deadlock; it does this by finding the "oldest" and largest consumer of memory and aborting his resource allocation.

The largest section of the common logic is the multi virtual connection PAD (Packet Assembly/Disassembly) logic. This general-purpose software has a standard interface to the higher layers of software wishing to use its services. The PAD is completely state table driven and currently implements the ARRL AX.25 V1.0 and V2.0 protocol specification. The PAD supports a variable number of simultaneous virtual connections

Thomas H. Aschenbrenner, WB5PUC, and Thomas C. McDermott, N5EG, Texas Packet Radio Society, P.O. Box 831566, Richardson, Texas 75083-1566

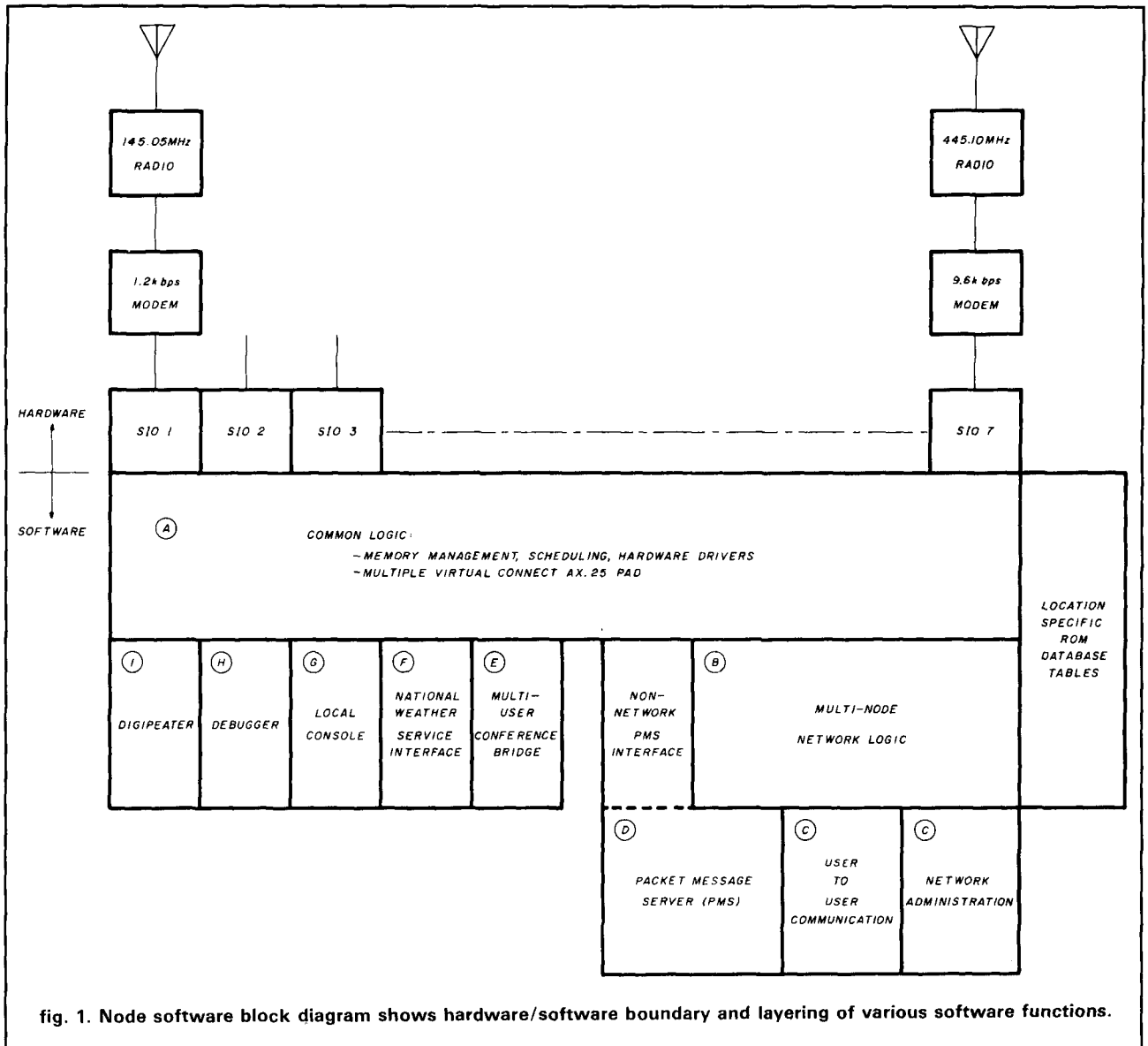

fig. 1. Node software block diagram shows hardware/software boundary and layering of various software functions.

(currently set to 20), with any of the virtual connections conforming to either V1.0 or V2.0 of AX.25. Selection of V1 or V2 operation is determined by the users' setting of their TNCs — for example, if they're running V1, then the node will act like a V1 TNC when they connect. Users running V2 will see the node as a V2 device.

The PAD, which supports up to eight physical communications channels (four SIO's), has been tested in a multiport configuration with both 9600 bps and 1200 bps, operating simultaneously without loss of data. In order to achieve this performance level for 9600-bps operation, a nested interrupt structure (the interrupt service routines are themselves interruptible) which would allow timely response to interrupts from the 9600-bps port(s) had to be designed.

The common logic provides a number of features of the node. All users of the node see the node as a series of AX.25 addresses. For example, this is how users see the Garland, Texas node:

- W9DDD-2 1st conference bridge**
- W9DDD-3 2nd conference bridge**
- W9DDD-4 TEXNET Access**
- W9DDD-5 Node's local console**
- W9DDD-6 Test access**

These applications will be explained shortly; what's important to note here is that all of the addresses have the same Amateur call, W9DDD, and that the application is selected according to the SSID. (This method of operation is only one configuration of the address database. Instead of using the same call (W9DDD) five

times, different calls could have been configured, with the SSID held constant. The node will support any combination of the above examples.)

The common logic also supports various restriction and parameter tables. New connections to any AX.25 address of the node can be inhibited as a function of the number of digipeaters used to get to the node. This has been found to be useful in reducing channel congestion attributable to excessive retries on long digipeater paths to a specific node. The preferred method is to put a network node near enough to the user group and carry the traffic on the network backbone trunks.

Parameters managed by the common logic, on a per-physical port basis, include all of those specified in the AX.25 protocol (i.e., T1, T2, T3, K, N2, etc.) and some unique to this application. It was found desirable to define the AX.25 T3 timer as either an all-seems-well timer (its original function) or an auto-disconnect timer. In the auto-disconnect mode, if a user's virtual connection is idle for greater than the T3 time value (nominally 3 minutes) he or she is automatically disconnected from the node, thereby making room for other users. This mode can be overridden by the ALERT network mode, which will be discussed below.

Finally, the common logic is responsible for gathering statistics for the node. Two main groups of statistics are collected. The first are those that aid in "traffic engineering" the node. Quantities such as the amount of memory in use, the maximum amount ever used, and the total available allow visibility into the level of service being provided and indicate whether or not more RAM should be allocated to the free memory pool, thus decreasing memory space available for applications. Experience indicates that a free memory pool of approximately 30K, allocatable in about 200-byte chunks, provides good service with enough reserve capacity to handle rather large impulse loads, such as congestion on 9600-bps trunk circuits.

The second group of statistics collected are those having to do with node use. Quantities such as the number of frames transmitted, received, and retransmitted for each physical channel yield data on overall network use, thereby suggesting possible additions to the node or changes in network configuration. These numbers can also be used to determine the performance level of network trunks.

multi-node network logic

As illustrated, the multi-node network logic (see B in fig. 1) is supported by the common logic. In turn, it supports higher-level applications such as Network Administration, User Intercommunication, and the Packet Message Server.

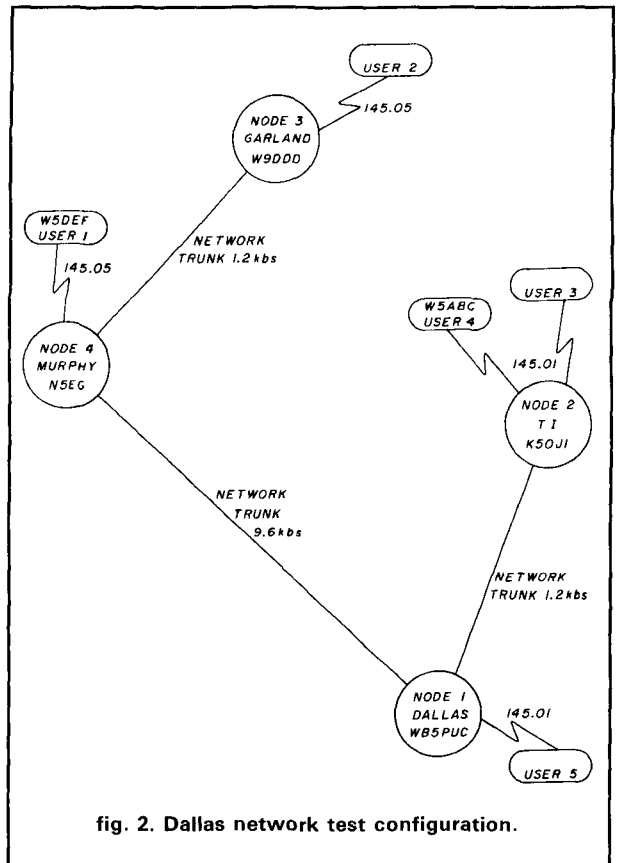

fig. 2. Dallas network test configuration.

The multi-node network logic is a datagram-based system that can support up to 256 node locations with as many as 20 simultaneous users at each node. All network nodes interconnect via permanent virtual connections between them.

The network is a database-driven system that features an extremely user-friendly termination-based routing structure. The network provides end-to-end flow control to eliminate internal congestion. A user's TNC "going busy" causes a network message to be sent to the far node, which in turn will "busy" the subject port at the far node, thus causing the remote user's TNC to stop sending.

In order to allow for an increased level of reliability, the network allows for alternate routing of data via multiple routes to a single node. Controlled by the node's database, alternate routing is automatically performed upon detection by a node that its first-choice route has failed.

The network provides substantial feedback to the user community via a mechanism called *Network Information Codes* (NIC). These NICs are printed at a user's terminal when something unusual happens that will affect the performance of the network from the user's viewpoint.

For an example of NIC operation, and for further

illustration and explanation, see **fig. 2**, which illustrates the network test configuration as it was in Dallas when this article was being prepared. This test configuration was used for software testing during the development phase and for a series of operational tests during the beta-test phase.

The system shown in **fig. 2** is located in the north Dallas area. No particular attention was paid to the geographical locations except for convenience of access for testing. The illustrated network architecture was chosen because it provides for testing of all possible configurations of actual network operation.

Each of the four nodes has an Amateur call sign assigned as its user-access AX.25 address. Each node also has a mnemonic name to which all users refer when asking the network for services. For example, Node 4 has a user-access address of N5EG-4, and is referred to by users in all network commands as MURPHY. (Note: MURPHY is named for its location in Murphy, Texas — not in honor of the universal law of the same name.)

In an actual geographically dispersed network, the user community around each node has to know only their own node's user access address (N5EG-4 in the example above). They refer to all other nodes in the network by the network node names (GARLAND, MURPHY, DALLAS, TI [Texas Instruments Radio Club] — see **fig. 2**).

Also shown in **fig. 2** are typical user stations, labeled User 1 through User 5. These stations are standard Amateur packet stations equipped with commercially available TNCs and VHF transceivers.

the network users' interface

The Network Users' Interface (see C in **fig. 1**) provides the user's view of the network. Referring to **fig. 2**, if User 5 were to connect to WB5PUC-4, he would see the following displayed on his screen:

C WB5PUC-4

***Connected to WB5PUC-4

WB5PUC-4 Virtual Connection 06 at 18:32:20 on 11/20/86

Welcome to TEXNET

Network Cmd?

At this point he can issue any of the network commands or just disconnect if he's finished.

network command structure

The network command structure is as follows:

- **@NODENAME**. The NODENAME field may consist of any valid network node name. Valid node names may be two to seven characters long and can consist of any ASCII character except carriage return. As indicated in **fig. 2**, these names are MURPHY, GARLAND, TI, and DALLAS in our test configuration. User entry of a name not recognized by the node as

valid will result in a message to the user indicating that an invalid node name has been entered. A list of valid names will be printed to allow correction of the error.

Because any command may be destined for any node, most commands are terminated by the @NODENAME field. Some commands have an implied node name. Commands that are currently implemented are listed in **table 1**. For purposes of this description, the network commands are divided into two categories: User and Administration. Note that this division is for explanation only; any user may execute any command. Those who simply want to communicate via the network need learn only the commands listed in the User category. A much smaller group of people — those who are responsible for network engineering and administration — need to learn the Administration commands.

While the command words are spelled out fully in **table 1**, only the first character must be entered for most commands — for example, **H** for **HELP**. **Table 1** includes examples of network commands and their abbreviated formats.

- **HELP**. The user entering this command is given a partial list of commands (those marked "user") and referred to the network operation manual for further enlightenment. This strategy, rather than the on-line tutorial method, was chosen in order to reduce channel congestion. All new users are sent a copy of the TEXNET manual; this eliminates trial-and-error learn-

Table 1. Active network commands can be typed by user in response to the network command prompt, which is received after the user does a standard connect to the node.

Type	Command	Parameters	Example using
User	Help	() = optional input None	abbreviated command H
User	Circuit	Call sign (via Digi)	C W5ABC @ Dallas C W5ABC V WA5LXS @ Dallas
User	Locations	None	L
User	Message	None	M
User	Alert-on	None	A -on
User	Alert-off	None	A -off
Admin	Statistics	None	S @ Dallas
Admin	Initialize	None	I @ Dallas
Admin	Time	(DDMMYYHHMM)	T @ Dallas T 0108871420 @ Dallas
Admin	Route add	26 bytes of information	R A 01 7F @ Dallas
Admin	Route delete	Number	R D 2 @ Dallas
Admin	Point	Function number	P E 2 @ Dallas P D 2 @ Dallas P S @ Dallas

ing on the air, which results in more efficient use of channel space.

- The **CIRCUIT** command tells the network the desired destination of the user's connection. See **fig. 2**; if User 1 wanted to communicate with User 4, he would enter the following at the command prompt:

C W5ABC @ TI

Obviously, this example assumes that User 4's call sign is W5ABC. Note that User 1 doesn't need to know how the network will connect to User 4; he just enters the terminating node name TI, and it's the network's responsibility to figure out how to route the message to TI.

The routing strategy is accomplished by the database in a node's knowing which of its adjacent nodes should be used to get to a remote node. It's a tradeoff, in that it makes the node database somewhat more complex — but it does allow the users an extremely easy interface.

Because the users don't need to know the physical configuration of the network in order to communicate, the network administration group can change it at will without having to inform (and thus re-educate) the entire user community. This routing strategy takes advantage of the disparity between the number of times users access the network to communicate (very large) versus the number of times the administration group adds or makes changes to a node (very small). The increased burden on the administration group is more than offset by the benefit to users.

In order to compensate for incomplete geographic network coverage, the **CIRCUIT** command allows an optional string of digipeaters to try to connect to the desired station. Thus,

C W5ABC V WA5LXS @ TI

would cause the remote node TI to attempt to connect to W5ABC, using WA5LXS as a digipeater. Up to two digipeaters can be specified in the **CIRCUIT** command.

Operations note: whenever a remote node attempts to connect to a station (as when TI attempts to connect to W5ABC in our example), the node will use Version 2 of the AX.25 protocol unless a digipeater is specified. If a digipeater is specified, the remote node will attempt the connect using Version 1 AX.25. This is because there are still some digipeaters around that won't accommodate Version 2.

After User 1 enters the **CIRCUIT** network command, one of three things will happen. First, his CRT may display the message,

Your connection is established

in which case he's being advised that the desired remote user (User 4) is on line. At the far side, our re-

mote user (User 4) would receive the following on his screen:

*****Connected to K5OJI-4**

*****Linked to W5DEF at Murphy via Texnet**

Therefore, User 4 knows exactly to whom he is connected via the network, and where the originating station is located. The above example, of course, assumes User 1's call is W5DEF.

The "**** Linked to" string received from the network allows a WØRLI-compatible BBS system to know who the real user is (W5DEF) rather than thinking it is connected to the node (K5OJI-4).

The second possible message is:

Remote user not responding

In this case, User 1 is informed that connection is impossible. This could occur for a number of reasons: the remote station may not have its equipment turned on, or it may be turned on but involved in another QSO.

The third possibility is receipt of an NIC message. Using our example, if user 1 received:

Network information code 017 from Dallas

he could look in the **TEXNET** manual and find that code 017 means his attempt was routed as far as Dallas, but couldn't be routed further because of a network trunk outage. This can then be reported to network administration for remedial action.

- The **LOCATIONS** command allows users to ask the node for a list of remote locations which can be reached through the network.

- The **MESSAGE** command gives any network user, regardless of node location, access to the network Packet Message Server (PMS) logic. Details of the PMS subsystem will be covered below; for the moment, let's just say that it's a network-wide message file system similar to the WØRLI bulletin board system.

It's important to note that users at any node in the network don't need to know where in the network the PMS system is physically located. All a user needs to do is type **MESSAGE** or **M**, and the network takes care of routing to PMS. In the test configuration shown in **fig. 2**, PMS is actually located at Node 1 or Dallas, but very few users are aware of this, since they can connect to any node to access PMS. Once the network has established a connection for the user to PMS, the user can enter PMS commands to store, list, or read messages.

- **ALERT-ON AND ALERT-OFF** enable or disable a special mode of operation called **ALERT**, which is especially designed for accommodating emergency traffic handling via packet radio. The **ALERT** mode can be enabled from any node in the network. When a user

connects to any node and issues the ALERT-ON network command, his or her node will send a "broadcast" command to all other nodes in the network informing them that ALERT mode is being enabled and telling each the name of the originating node. At this point, several things happen in every node.

Users connecting to the network are informed that an ALERT is in progress. Let's assume that a user at Dallas has enabled the ALERT mode. As in our previous example, User 1 wants to communicate with User 4; when he tries to connect, however, he receives the following message on his CRT:

```
***Connected to N5EG-4
N5EG-4 Virtual Connection 03 at 08:30:20 on 12/15/86
Pls disconnect unless your traffic is related to the network
alert in progress from Dallas.
**Welcome to TEXNET**
Network cmd?
```

When ALERT is enabled, all user automatic disconnect timing is disabled. Thus, instead of the standard 3-minute idle time disconnect, to which all users are subject, all nodes will allow connections of unlimited duration to their ports. This disconnect timing suspension affects all connects to the node. Thus, if groups of users want to use their node's conference bridges to handle emergency traffic, they can remain connected indefinitely. User connects to PMS may also be of indefinite duration.

With the enabling of ALERT, a special mode of PMS that provides a real-time message exchange between the multiple users connected to PMS is also enabled. Thus, when one user SENDS (see PMS description below) to another, all of the standard PMS functions are invoked. In addition, after automatically saving the message on disk, PMS will check to see if the addressee is currently connected to PMS on another of its logical ports. If he is, PMS will automatically display the message at the addressee's terminal.

With this mode of operation enabled, PMS becomes a real-time message forwarding system among its connected users, with the added feature that all messages are archived to the disk. This feature can be extremely useful in emergency government communications back-up, since the stations connected to PMS could be physically located anywhere along the network.

For a Department of Public Safety (DPS) exercise, for example, Amateurs equipped with standard packet equipment could be located in each community's DPS office. Each station would be connected, via the network, to one of the logical ports of PMS. Because the ALERT mode would be enabled, they would be able to stay connected indefinitely — remember, DISC (disconnect) timing is inhibited with the enabling of ALERT — and each time one station uses the standard S feature of PMS, the message would be dis-

played in real time at the receive station. Of course, the message would be automatically saved to disk so the receive station can review it at will. Other advantages of this technique include a complete on-disk record of all messages (useful for exercise postmortems) and the fact that other connected stations may review all communications except those sent as private messages.

- **The STATISTICS** command, when issued with the NODENAME parameter, causes the local node to acquire the operational statistics of the remote nodes. The statistics counters in a node aren't cleared by this command; this allows timed interval measurements to be taken. Every midnight, all statistics counters are cleared to zero.

The following are the statistics kept at each node and therefore available via the STATISTICS command:

- Frame buffers available**
- Frame buffers in use**
- Maximum frame buffers ever used**
- Total connects**
- Connects to weather**
- Connects to conference bridge**
- Connects to network**
- Network circuits active**
- Maximum network circuits ever active**
- Packets sent on each physical channel**
- Packets received on each physical channel**
- Packets re-sent on each physical channel**

In addition, the real time at the subject node is sent back with the statistics. By looking at some of the statistics returned, the network administrators can make various engineering judgments about the level of service being provided by a node to its user community. Quantitative measurements of the activity of a node's local user community, and of which node services are being used, can also be made.

- **The INITIALIZE** command is the means of remotely restarting any node. When a node receives an INITIALIZE command directed to it from someplace on the network, two functions are executed. First, upon receipt and decoding of the command, the software kills all activity in the node for 30 seconds. This delay allows time for adjacent nodes to have their network trunks to the subject node time out because of the subject nodes' lack of activity. This action gracefully removes the subject node from the network fabric. At the end of the delay period, the subject node does a cold restart, thus appearing to the rest of the network as if it had just been turned on. In response to this action, the subject node — after consulting its database — establishes network trunks to the appropriate adjacent nodes. Network operation is now re-established.

New PK-232 Breakthrough

Six Digital Modes - Including Weather FAX

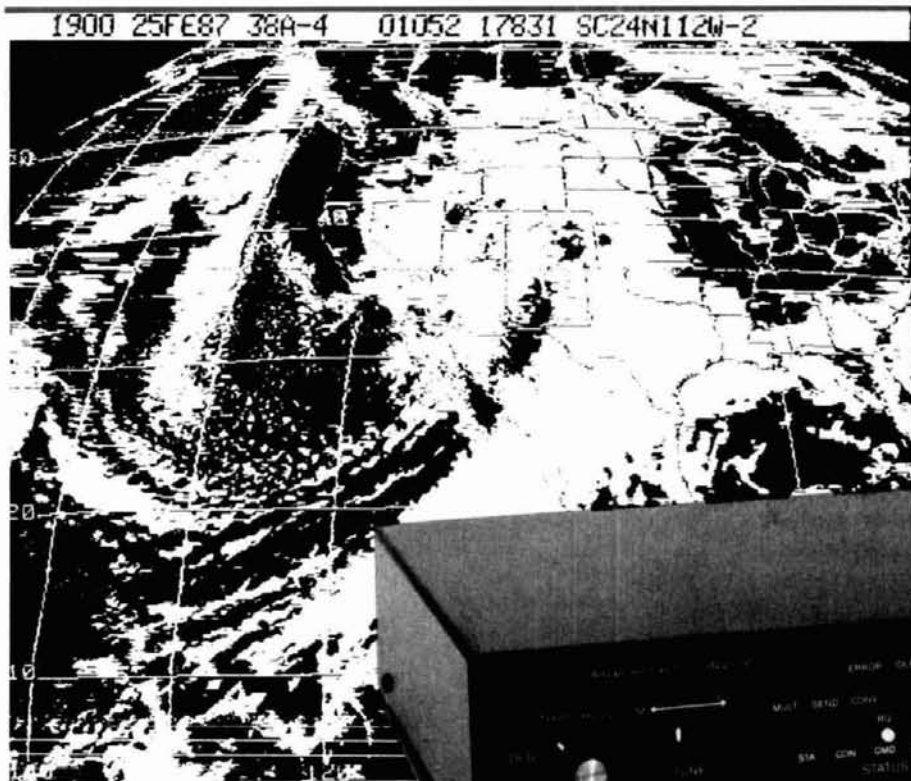

A new software enhancement makes the AEA PK-232 the only amateur data controller to offer six transmit/receive modes in a single unit.

- * Morse Code
- * Baudot (RTTY)
- * ASCII
- * AMTOR
- * Packet
- * Weather FAX



\$319⁹⁵ AMATEUR NET
\$379.95 AEA RETAIL

Your home computer (or even a simple terminal) can be used for radio data communication in six different modes. Any RS-232 compatible computer or terminal can be connected directly to the PK-232, which interfaces with your transceiver. The only program needed is a simple terminal program, like those used with telephone modems, allowing the computer to be used as a data terminal. All signal processing, protocol, and decoding software is in ROM in the PK-232.

The PK-232 also includes a no compromise VHF/HF/CW modem with an eight pole bandpass filter, four pole discriminator, and 5 pole post detection low pass filter. Experienced HF Packeteers are reporting the PK-232 to have the best Packet modem available.

Operation of the PK-232 is a breeze, with twenty-one front panel indicators for constant

status and mode indication. The 240 page manual includes a "quick start" section for easy connection and complete documentation including schematics. Two identical back panel radio ports mean either your VHF or HF radio can be selected with a front panel switch. Other back panel connections include external modem disconnect, FSK and Scope Outputs, CW keying jacks, and RS-232 terminal interface.

The RS-232 connector is also used for attaching any Epson graphics compatible parallel printer for printing Weather Fax. Weather maps and satellite photos, like the one in this ad, can be printed in your shack.

Contact your local AEA dealer today for more information about the one unit that gives you six modes for one low price, the PK-232.



Brings you the Breakthrough

2006-196th St. SW
Lynnwood, WA 98036
(206) 775-7373

The second thing that happens upon receipt of an INITIALIZE command is the activation of an external hardware fail-safe circuit. Buried in the INITIALIZE command as it traverses the network is a unique bit sequence generated by the originating node and specific to the subject node. Upon detection of the bit sequence by the subject node's external hardware fail-safe circuit, the master reset line of the Z-80 is asserted. This technique obviates the above discussion on the software execution of the INITIALIZE command unless, of course, there's a failure in the fail-safe hardware itself. The combination of the two techniques would require a double failure in a node before the ability to remotely reset it would be lost.

- **The TIME command**, when issued by a user at any node and directed to a specific remote node, will cause the real-time clock at the remote node to be updated to the time contained in the message. If no time parameter is input by the originating user, then the current time at the user's node is sent to the remote. If the time parameter is entered by the user, his or her node's real-time clock is updated with the input time before its value is sent to the remote node.

- **ROUTE ADD/DELETE.** Since in every node the ROM routing table is copied to RAM for operation, it may be changed by being added to or deleted from. The ROUTE commands are the means by which new nodes can temporarily be added to an existing network or by which the network configuration can be changed to accommodate a failure or some other special event.

- **POINT COMMAND.** This command is used to control external equipment at any node site. Within each node control point (NCP), there are 5 bits of input and 5 bits of output available for external use. These bits, called control points, could be used to control and monitor anything that interfaces via contact closures. Co-located equipment at the node site, such as other repeaters, could take full advantage of digital control via this feature of the NCP.

The POINT command allows full on/off control of the output points. For example, suppose a co-located voice repeater at the GARLAND node needed to be controlled. NCP output Point 1 could then be wired to the voice repeater's control relay, and perhaps NCP input Point 1 would be wired to one of the control relay contacts to allow monitoring of relay closure.

Any authorized packet station, anywhere on the network, can issue the following command to enable the co-located voice repeater:

POINT ENABLE 1 @ GARLAND

or for short,

P E 1 @ GARLAND

Displayed on the CRT — after the network has passed the POINT command to the GARLAND node and the command was executed — would be:

Control Points at Garland Are

```
Point:   1  2  3  4  5  6  7  8
Input:   E  D  D  D  D  D  D  D
Output:  E   D  D  D  D  D  D
```

Since the control operator knows that Control Point 1 is wired to the voice repeater, he can see that it's enabled, and by looking at Input Point 1, confirm that the control relay is closed.

Any time the control operator wishes to check if the voice repeater is on, he needs only to type **P S @ GARLAND** to get the status display of the control functions. When he chooses to shut the voice repeater down, he enters **P D 1 @ GARLAND** at the network command prompt. Again the status will be displayed on his screen in response to the command, allowing confirmation that shutdown has occurred.

One important use of the POINT command is the control of a pair of control points wired over to the node's Uninterruptible Power Supply (UPS). By design, the UPS has a control lead which, when enabled, forces the UPS to switch from ac to battery. Another UPS lead provides an indication that the UPS has switched to battery operation.

In a normal node configuration, Control Point 5 input and output are wired to the UPS control leads. This allows any node in the network to be instructed to operate off battery power by the simple issuance of the **P E 5 @ Node** command. Issuing the **P D 5 @ Node** command restores the node to ac operation. This feature allows weekly testing of the UPS to ensure that it would be effective during an emergency.

network internals

It may be interesting at this point to describe some of the internal workings of the network software, which has the ability to establish, kill, and communicate over any number of virtual connections. Thus, at system startup, the network application executes logic to find out who its neighboring nodes are. It then establishes a virtual connection to each, over whatever physical channel is specified to be used as the network trunk. This virtual connection is left up forever. All subsequent communications from this node to its neighbor, whether user data or network management data, travel over this permanent virtual connection. Additional logic determines the network configuration for the node's routing table.

A special byte string is added to the beginning of all packets going over a network trunk. This string, known as a *Network Header Block* (NHB), consists of a minimum of 5 bytes:

NHB.RNN Destination Node Number
NHB.RLC Destination Virtual Connection
 Number
NHB.LNN Originating Node Number
NHB.LLC Originating Virtual Connection
 Number
NHB.NCF Network Control Field
 ~ ~ Any Network or User Data

When a node receives information from a virtual connection marked as a network trunk, it examines the NHB. Looking at NHB element **NHB.RNN**, it checks to see if the received string is for this node. If it isn't, the node consults its routing table to see on which of its trunk circuits (virtual connections) it is to retransmit the string. This is known as *transit routing*, and it's extremely fast, thereby yielding a large node bandwidth in this mode. If the examination of **NHB.RNN** confirms that the string is for this node, the **NHB.NCF** byte is decoded to tell the node the proper action to take on the received string. There are over 15 valid network control fields in the current design, so it wouldn't be practical to cover them all here; therefore, we'll choose just one as a simple example.

The example will be of a remote node (perhaps many hops, or nodes, away — we don't know, and we don't care if the information came to us via transit routing through multiple nodes) asking us to send our operational statistics. When we finally receive the string, we find it's directed to our node; moreover, after examining the network control field, we see it is set at 01 HEX, which tells us that the remote wants us to send our collected statistics. Our response to this is to reverse the NHB items so we can send information back to the requester and reset the network control field to 02 HEX, which will inform the requester, when he receives the string, that we responded. We append approximately 40 bytes to the string. These appended bytes are the operational statistics we've been collecting, which is what the remote requested.

the packet message server

The PMS logic (see *D* in fig. 1), resident within a node, allows a simple three-chip interface to a Western Digital WD 1002-05G disk controller and a standard ST506 5-Megabyte hard disk to become a network wide integrated message storage/retrieval system. Normally, only one disk is required per network. It's possible, however, in a very large network, to assign specific groups of nodes to a given PMS, in which case there could be more than one PMS disk. The PMS logic is resident in each node, but only the node(s) equipped with a physical disk allow it to execute.

From an individual user's viewpoint, the PMS looks and acts like a WORLI bulletin board system. This choice of operational methods was made to reduce the amount of end-user training required. It also aids in the transition that must occur when all users in a given area are switching from being served by an in-place WORLI system to the PMS system running on the network. Because of the similarities between the familiar WORLI system and the PMS, this discussion will not cover details such as how the SEND, READ, KILL, and other commands work, but will instead concentrate on the PMS's enhancements.

Because the PMS system is designed to provide message service for all the users of a network subregion, the bandwidth requirements are greater than those found in other message systems. Unlike existing message systems, which have the ability to service only one user at a time, the PMS system allows up to ten users to log on simultaneously, providing the same grade of service, relative to response time, to each.

The storage element in a PMS is a 5-Megabyte hard disk. These disks are equipped with four head assemblies and a platter assembly capable of accommodating 154 cylinders. To make use of these characteristics and to provide the response time needed, the software was expressly designed to have a message file structure that takes advantage of the physical characteristics of the disk. The first time a new node is energized, the disk is automatically formatted and then configured to the necessary file structure. Every restart thereafter preserves all saved messages.

The combination of the hard drive and special file structure results in an incredibly small response time; even with multiple users, each user has a real-time response from the PMS, with a delay of less than 1 second. In tests run on the Dallas network test configuration, remote network users accessing the PMS via a 9600-bps network trunk observed no difference in response time from that observed by users directly connected to a PMS system. Both experienced a response time of less than 1 second. Most operational response time delay was attributable to congestion on the 1200-bps final link to the user.

The PMS system supports up to 500 active messages from a message number range of 1 to 99,999. There's no difference in response time if a user is accessing Message No. 1, 500, or 50,000.

All active messages are subject to the auto-delete function of the PMS. An undeleted message will remain in PMS for no fewer than 14 days and no more than 28 days before being automatically deleted by the system. While these times are variable, users seem to find them satisfactory.

Important note: the PMS message system is

★ QUALITY PARTS ★ DISCOUNT PRICES ★ FAST SHIPPING!

SEND FOR FREE 1987 CATALOG... 48 PAGES!

ALL ELECTRONICS CORP.

EDGE CONNECTORS
ALL ARE .156" SPACING.

22 EDGE CONNECTOR \$1.25 ea
solder lug style 10 for \$11.00

22/4 EDGE CONNECTOR \$2.00 ea PC style 10 for \$18.00

22/4A EDGE CONNECTOR \$2.00 ea PC style 10 for \$18.00

28/8 EDGE CONNECTOR PC style \$2.50 ea

36/12 EDGE CONNECTOR PC style \$3.00 ea

48/16 EDGE CONNECTOR PC style \$4.50 each

COMPUTER GRADE CAPACITORS

1,400 mfd 200 Vdc 3" x 2" dia. \$2.00

6,400 mfd 80 Vdc 1 1/4" x 1 3/8" dia. \$2.50

7,500 mfd 200 Vdc 5 3/4" x 3" dia. \$4.00

12,000 mfd 40 Vdc 1 1/4" x 2" dia. \$2.50

22,000 mfd 25 Vdc 4 3/4" x 2" dia. \$2.50

48,000 mfd 10 Vdc 6" x 2 1/2" dia. \$1.50

66,000 mfd 15 Vdc 3 3/4" x 3" dia. \$1.00

72,000 mfd 15 Vdc 4" x 2" dia. \$1.50

100,000 mfd 10 Vdc 6" x 2 1/2" dia. \$1.00

COMMODORE PRINTER/PLOTTER
Commodore Model # 1520
Four color X-Y plotter. Standard VIC serial interface allows easy connection to Commodore 64 computers. Up to 80 characters per line in four styles.

4 inch paper CAT # COM-1520 \$49.95 each
EXTRA pen sets \$1.50 per set.

2K 10 TURN SOLID STATE BUZZER
MULTI-TURN POT. 2K 10 TURN POT. #MOD 554-7161 \$5.00 EACH

POLARITY SWITCH
Designed to control an external coaxial relay on a satellite TV system. IDEAL FOR THE EXPERIMENTER AS PARTS. Heavy chassis box containing a 5 Vdc relay. CA 358 pin amp and other parts.

Catalog # RDDP \$1.75 each 10 for \$15.00

WALL TRANSFORMER
11.5 Vdc 1.95 Amp. INPUT: 120 Vac. SIZE: 3 3/4" x 2 7/8" x 2 5/8". CAT # DCTX-11519 \$6.50 each

3 1/2" SPEAKER
8 ohm impedance. Full range speaker. 8 ohm magnet. 4 diagonal mounting centers. \$2.50 each 10 for \$20.00

SPRING LEVER TERMINALS
Two color coded terminals on a sturdy 2 1/2" x 3/4" base. Great for speaker enclosures or power supplies. 75¢ EACH 10 for \$6.00.

TRANSISTORS

2N108 4 for \$1.00
2N2222A 3 for \$1.00
PN2222A 4 for \$1.00
2N2904 3 for \$1.00
2N2905 3 for \$1.00
2N2906 3 for \$1.00
2N3855 1 for \$1.00
PMD 104 40 \$1.00
TIP 122 1 for \$1.00
TIP 125 75¢

MICRO-CASSETTE MECHANISM
Micro-cassette tape transport for Standard MC60 micro-cassettes. 3 Vdc operation. Contains drive motor, belt, head, capstan pinch wheel and other components. 1 1/2" x 2 1/8" x 5 3/8". CAT# MCMEC \$3.00 each 10 for \$27.50

3rd TAIL LIGHT
Steel high-tech lamp assembly. Could be used as a third auto tail light, emergency warning light, or special-effects lamp. Red reflective lens as 2 3/4" x 5 1/2" field of view (about 120 degrees). Includes 12V replaceable bulb. CAT# TLB \$3.95 each.

RELAYS
10 AMP SOLID STATE CONTROL 3-17 Vdc. LOAD 140 vac. 10 amp. SILENT. \$9.50 EACH 10 FOR \$90.00

ULTRA-MINIATURE 5 VDC RELAY
Features: 1. FBA211NE0005M20 high sensitive. 2. COIL 120 vac. 3. CONTACTS 1 amp. 4. Mounts in 4-pin DIP socket. \$12.25 each 10 for \$10.00

MINIATURE 6 VDC RELAY
Aronax #RS05-V Super Small SMD Pin relay. 600uA coil. 600uA contact current. 1 amp @ 30 vdc. Highly sensitive. 120 Ohm coil. 120 Ohm contact. Operates from 4-6 vdc. 10 for \$15.00

48 KEY ASSEMBLY FOR COMPUTER OR HOBBYIST
NEW! 11 KEYBOARDS Originally used on computers, these key boards feature 48 S.P.S.T. mechanical switches. Terminates to 15 pin connector. Frame 4" x 9". CAT# KFB-48 \$3.50 each

TELEPHONE COUPLING TRANSFORMER
Standard # TTPC 8 or Trax # TV 300 p. 400 ohms ± 1, 600 ohms ± 2. PC board mount. 3/4" x 3/8" x 1/4". \$1.25 each

XENON FLASH TUBE
3/4" long X 1/8" dia. Flash tube designed for use in compact camera flash units. Ideal for experimenters. CAT# FT-2 for \$1.00.

TRANSFORMERS
120 volt primaries

5.6 volt @ 750 ma. \$3.00
6.3 volt @ 800 ma. \$1.50
12 VCI @ 200 ma. \$2.00
12 VCI @ 400 ma. \$2.00
12 VCI @ 1 amp. \$4.00
12 VCI @ 2 amp. \$4.85
12 VCI @ 3 amp. \$5.50
16 volts @ 450 ma. \$2.00
24 VCI @ 200 ma. \$2.50
24 VCI @ 1 amp. \$4.50
24 VCI @ 2 amp. \$6.75
24 VCI @ 3 amp. \$8.25
24 VCI @ 4 amp. \$11.00

PHOTO-FLASH CAPACITORS
170 MFD 330 Volt 400 MFD 330 Volt. CAT# PFC-170 75¢ each
CAT# PFC-400 \$1.00 ea

LIGHT ACTIVATED MOTION SENSOR
This device contains a photo-eye which sends a signal to a relay which causes a light to flash. When an object or person passes within the field of view (about 120 degrees) it beeps for several seconds then resets. Could be used as a alarm annunciator or modified to trigger other devices. 5 1/2" x 4" x 1". Operates on 6 Vdc. Requires 4 AA batteries (not included). Catalog # LMSD \$5.75 per unit

13 VDC RELAY
CONTACTS: SP-NC 10 amp @ 120vac. Energize coil to open contact. COIL: 13 vdc 650 ohms. SPECIAL PRICE \$1.00 each

4PDT RELAY
14 pin DIN style. 3 amp contacts. USED but fully tested. \$1.70 each. Specially constructed. Silver 24 vdc or 120 vac. LARGE QUANTITIES AVAILABLE

MINIATURE TOGGLE SWITCHES
ALL ARE RATED 5 AMPS @ 125 VAC

S.P.D.T. (on-on) \$1.50 each
S.P.D.T. (on-off-on) \$1.50 each
D.R.D.T. (on-on) \$1.50 each
D.R.D.T. (on-off) \$1.50 each

WALL TRANSFORMERS
All plug directly into 120 vac outlet

4 VDC @ 70 ma. \$2.00
6 VDC @ 500 ma. \$3.50
6 VDC @ 750 ma. \$4.50
9 VDC @ 800 ma. \$5.00
12 VDC @ 200 ma. \$3.00
12 VDC @ 10 VA and 12 VDC @ 250 ma. \$3.50
MULTI-VOLTAGE @ 500 ma. 3.4v, 4.7v, 6.3v, 12 VDC. \$7.50

TI SWITCHING POWER SUPPLY
Compact, well-regulated switching power supply designed to power Texas Instruments computer equipment. INPUT: 14-25 vac @ 1 amp. OUTPUT: 12 vdc @ 300ma. SPECIAL PRICE \$3.50
1.5 vdc @ 1.2 amp \$3.50
5 vdc @ 200 ma \$3.50
SIZE 4 1/2" x 4 1/2" x 1 1/2"

RECHARGEABLE NI-CAD BATTERIES
AAA SIZE 1.2V 500mAh \$1.85
AA SIZE 1.2V 500mAh \$1.85
AA with wiper lead \$2.00
C SIZE 1.2V 500mAh \$3.50
SUB-C SIZE solder lead \$3.50
D SIZE 1.2V 1200mAh \$3.50

NI-CAD CHARGER
Will charge TESTER most every size Ni-cad battery available. CAT # UNCC-N \$12.50

LED'S STANDARD JUMBO DIFFUSED T-1-3/4
RED 10 for \$1.50
GREEN 100 for \$13.00
YELLOW 100 for \$17.00

FLASHER LED
2-volt operation. 100 for \$1.50
NEW GREEN FLASHER CAT# LEDAG \$1.00

BI-POLAR JUMBO 1/4 WATT
\$1.70

D.R.S.T. LIGHTED ROCKER SWITCH
115 vdc lighted rocker. 1/2" x 1 1/2" hole. Orange lens. 16 amp contact. \$1.50

MINI-PUSH BUTTON
S.P.S.T. momentary normally open. 1/2" bushing. Red button. 35¢ each 10 for \$3.50

SNAP ACTION SWITCH
Cherry select #E21-N O N C 0.1A contacts. Suitable for alarms and other low-voltage circuits. 1 1/2" lever. 45¢ EACH 10 FOR \$4.20

MINI-BOX
Pomona #A104

Heavy duty black phenolic project box with cover and screws. 2 1/4" x 1 1/2" x 1 1/2". \$1.00 EACH

FUSES
3AG (C) SIZE 1 1/4" x 2 1/4" 3, 4, 5, 6 AMP. 5MA SIZE 1-1/4" x 3/4" 5 AMP. 5 of any DNE amperage 75¢

8" 15 WATT SPEAKER
C.T.S. Model #83073
Full range speaker. 100-10,000Hz. Ideal for PA systems. Mounting holes for line-matching transformer. CAT#K8-15 \$3.50 ea. Case of 8 pcs. \$25.00 per case

220 Vac COOLING FAN
ROTRON # MX177A3
Metric XL 220 Vac. 4 1/8" square metal frame. CAT# CF-220 \$6.50 ea 10 for \$60.00 100 for \$50.00

LED'S
RED 10 for \$1.50
GREEN 100 for \$13.00
YELLOW 100 for \$17.00

FLASHER LED
2-volt operation. 100 for \$1.50
NEW GREEN FLASHER CAT# LEDAG \$1.00

BI-POLAR JUMBO 1/4 WATT
\$1.70

LED HOLDERS
Two piece holder for jumbo LED. 10 for \$5.00

CLEAR CLIP-LEAD HOLDER
Mount LED in fancy clip-lead holder. 4 for \$1.00

S.P.S.T. TOGGLE SWITCH
10 amp. # 125 Vac. All plastic body and toggle. CAT# STS-1 \$1.00 ea 10 for \$8.50 100 for \$7.50 LARGER QUANTITIES

ALL ELECTRONICS CORP.
LOS ANGELES, CA 90001
800 S. Vermont Ave.
214-966-0001

MAIL ORDERS TO: P.O. BOX 20406, Los Angeles, CA 90066

TW: (800) 801-1001, (214) 966-0001
FAX: (800) 801-1001, (214) 966-0001
1-800-826-9432

USA
VISA
MasterCard

TOLL FREE ORDERS ONLY
1-800-826-9432 (ORDER ONLY)
IN CALIFORNIA 1-800-258-6666
ALASKA, HAWAII, OR INFORMATION (213) 880-8000 NO CO.D.

QUANTITIES LIMITED
MINIMUM ORDER \$10.00
USA \$3.00 SHIPPING
FOREIGN ORDERS INCLUDING SUFFICIENT SHIPPING
CALIF RES ADD 6.75%

EVERYTHING IN HF WIRE ANTENNAS FROM DIPOLES TO S1 PERLOOPS

SEE WHAT WE'RE DOING WITH ANTENNAS & BALUNS

Computer optimized NEW G5RV, Super Zepp, Incomparable C1-2K, C1-4K, B4-2K BALUNS. Coming soon the MONSTER BALUN.

SUPERLOOP
80 & 40 Mhz band loop SWR < 2.1 from 3.5 to 3.8 & 7.0 to 7.3 Mhz. All bands with transmatch New and only \$69.95

THE RADIO WORKS

134

NOVICES
Discover 28 & 220 Voice THE FUN STARTS NOW Everything you need for a BIG signal on the NEW bands: It's all here.

SEND SASE FOR NEW CATALOG FROM JIM W4THU (804) 484-0140 BOX 6159 PORTSMOUTH, VA 23703
MONEY ORDER, VISA, MASTER CHARGE OR UPS. COD PLEASE ALLOW FOR POSTAGE

7 MILLION TUBES

FREE CATALOG

Includes all Current, Obsolete, Antique, Hard-To-Find Receiving, Broadcast, Industrial, Radio/TV types. **LOWEST PRICES**, Major Brands, In Stock.

UNITY Electronics Dept. H
P.O. Box 213
Elizabeth, NJ 07206

133

MICROWAVE MODULES Ltd.
LIVERPOOL ENGLAND

LINEAR TRANSVERTERS		POWER AMPLIFIERS	
MMT 50/28S	50 Mhz 20 Watts \$359	MML 144/30LS	30 WATT - 1, 3W INPUT \$136
MMT 144/144S	50 Mhz 20 Watts \$359	MML 144/100LS	100 WATT - 1, 3W INPUT \$244
MMT 144/28	144 Mhz 10 Watts \$198	MML 144/200S	200 WATT GAAS FET PREAMP \$455
MMT 144/28R	144 Mhz GAAS FET 25 Watts \$359	MML 432/30L	30 WATT - 1, 3W INPUT \$244
MMT 220/28S	220 Mhz 15 Watts \$242	MML 432/100	100 WATT ATV/SSB/FM/RPT \$455
MMT 432/28S	432/435 Mhz 10 Watts \$299	MML 432/150	150 WATT - 10 INPUT \$215
MMT 1296/144F	1296 Mhz GAAS FET 2 Watts \$380	MML 1296/15	15 WATT - 1, 3W INPUT CALL
MMX 1268/144	OSCAR MODE-L 2 WATT XMIT \$289		
CONVERTERS		PREAMPLIFIERS GaS FET	
MHC 50/28	50 Mhz RCV CONVERTER \$ 59	MMG 144V	144Mhz RF SW 100 WATTS \$ 75
MHC 144/28HP	2m GAAS FET RCV CONVERTER \$ 79	MMG 1296	1296 Mhz GAAS FET \$116
MHC 432/28S	432/435 Mhz RCV CONVERTER \$ 91	MMG 1691	1691 Mhz GAAS FET \$208
MMK 1296/144	1296 Mhz RCV CONVERTER \$206		
MNC 1691/137.5	1691/137.5 Wx RCV CONV. \$ 239	MMC 435/600	432 to 600Mhz BLOCK CONV \$ 65
	PRICES SUBJECT TO CHANGE WITHOUT ADVANCE NOTICE. VISA/MASTERCARD ACCEPTED	MTV 435	20 WATT VIDEO XMITR-70CM \$314

CONVERTERS PREAMPLIFIERS ATV OSCAR

THE "PX" SHACK
52 STONEYCROFT DRIVE
BELLE MEAD, N.J. 08502
(201) 874-6013

CALLING HOURS
11 AM - 3 PM orders
6 PM - 10 PM technical EST

FOX-TANGO Corp.
Box 15944, W. Palm Bch, FL 33416
Telephone: (305) 683-9587
European Agent: INGOIMTEX, Post Fach 2449, D8070 Ingolstadt, West Germany

designed to run *completely* unattended. No SYSOP is required. All duties previously performed by people running mailboxes are done automatically by the PMS logic.

The PMS system can run "stand-alone" — for example, with its user community geographically near the PMS equipment, thus replacing an existing mailbox system. In testing this configuration, a version of the software was put into an MFJ I270 TNC-2 with a hard disk interfaced to it. This system is currently used as a demo system for other groups of Amateurs wishing to participate in TEXNET.

PMS is used primarily as a network-wide message system. In its network configuration, any user located anywhere on the network may, after receiving the network command prompt, issue only the MESSAGE command to be automatically routed over the network to his servicing PMS. Referring again to **fig. 2**, the PMS equipment (all that's required in addition to an existing NCP is the disk controller and hard drive) is physically located at Node 1 in our Dallas test system. Any user can connect to any other node by issuing a connect request to the desired nodes call and using the -4 SSID. After this, all that must be done is to issue the MESSAGE command. The next thing that appears on the CRT is the text from PMS.

Since the PMS is network-compatible, it knows who the originator is as well as where (i.e., at what node name — DALLAS, GARLAND, TI, etc.) he's located. All of this is used automatically whenever a user does an **S** command to send a message to another user. If, after doing the message send, the user does a simple **R** (in PMS, the **R** with no qualifier or number will read back the last message number), he'll see that his call and the name of his node have been automatically entered in the message header.

In order to provide a message interface between an entire network and the existing Amateur message forwarding system, the PMS supports a subset of message forwarding. All messages that network users enter into PMS and which require forwarding will be passed by PMS to a single W0RLI system for eventual forwarding by the existing systems. The identification of this W0RLI system is contained in the node's database. This same W0RLI system can also forward messages into the PMS system for reading by all network users. PMS is designed to follow the standard forwarding protocol and uses a direct access port to connect with the W0RLI system. For example, in **fig. 2**, Node 1, containing the PMS system, will access the WA5MWD BBS system in Dallas by using its WB5PUC-7 direct access port. The WA5MWD BBS system can pass messages into the network by connecting to WB5PUC-7. The WA5MWD box doesn't know it's talking to the network system; it thinks it's talking to just another standard W0RLI system.

non-network local services

The following are services provided by each network node on a standard basis. These services are independent of the network, but still extremely useful:

Multi-user Conference Bridge
National Weather Service interface
Local Node Console
Debug Aid
Digipeating

multi-user conference bridge³

The multi-user conference bridge (see *E* in **fig. 1**) logic allows up to six remote users to hold a roundtable conversation with each remote, with the ability to see all text generated by all other remotes. Each remote user has a direct AX.25 connect to a logical port on the conference bridge. Upon reception of a packet of information from one user, the bridge will make multiple copies and send one to each of the other connected users. Since each user has an AX.25 connect to the bridge, he's assured of not losing packets, since the bridge will retry upon lack of an acknowledgment from the affected remote.

As the text is being transmitted to a remote user, it's modified to show which of the other remotes originated it. Therefore, all users not only see all text from each other, but know who originated it.

In a standard software package, the conference bridge logic simultaneously supports two completely independent six-party conferences. Each of these independent conference bridges is accessed by remotes using unique SSIDs, (usually -2 and -3).

Since the bridge logic is supported by the common logic, any of the remote users may be operating in either AX.25 version 1 or 2. Text is transferred among users without regard to versions used by individual remotes.

At any time during a conference, any of the users may type **CONTROL-U**. Upon receipt of this character, the conference bridge logic will respond by sending the requester a list of call signs of all other remote users currently connected to the conference bridge. Any of the remotes may exit an established conference, and other remotes may join (on a noninterference basis) the conference in progress.

Tests conducted in the Dallas area show the conference bridge to be a cleaner and more reliable way for groups to hold multi-user roundtable connects than the UNPROTO mode available on standard TNCs. This is because of the built-in advantage of error-free AX.25 connects combined with the fact that each remote has to have a good path only to the conference bridge, not to all other users.

NWS interface

The National Weather Service (NWS) application (see *F* in fig. 1) runs concurrently with others at a node. Typically, one node in each region could have this application enabled and interfaced via a standard 75-wpm, Baudot-encoded, 20-mA landline to the National Weather Service.

The NWS wire feed provides raw weather data for a large geographic region. The NWS logic monitors all received data, but selects and stores only those NWS products (for example, region forecasts, severe storm alerts, thunderstorm warnings, etc.) which have their unique codes programmed into the node's database. The NWS logic currently supports 30 code sequences, with each having the ability to be from 2 to 11 characters in length. This code format is consistent with the nine-character sequence utilized as a standard by the NWS.

Remote users connect to the node's NWS logic by means of a unique SSID (usually -1). Up to ten remote users may be connected to a node's NWS logic simultaneously. Upon connection to the logic, the system will wait for the remote user to enter a single product designator — for example, a user in Dallas who enters "D" causes the node to send the current Dallas area weather forecast. Entering a question mark prints the entire list of stored product designators.

All remote users are assured of receiving the latest data because the node updates its buffers in real time, as new information is received from the weather bureau. At 2 A.M. each day, the node clears all buffers to eliminate products sent infrequently by the weather service.

local CRT console

Figure 1 (see *G*) shows the local console CRT logic "sitting on top of" the common logic. The CRT logic at each node allows a locally connected standard ASCII CRT to originate and terminate connects with any standard TNC. In operation, it uses a unique SSID (usually -5) to distinguish itself from other node services. The local console logic isn't meant to be a full TNC-human user interface, as commercial TNCs are. Instead, this logic provides a minimum subset of human user commands that are necessary for testing and administration of the node. Table 2 contains examples of command types supported; some specific commands follow.

• The **ORIGINATE ON PHYSICAL CHANNEL** command allows the user to select which physical channel is to be used for originating connects. The console will accept connects from any physical channel, but will do so only if it's not currently busy. This command allows the console to originate on the physical channel connected to the 1200-bps radios and,

Table 2. Command types supported by TEXNET's CRT logic.

Command Type	Format
ORIGINATE ON PHYSICAL CHANNEL	ON where N=0, 1, etc. = physical channel
CONNECT	C W5ABC V WA5MWD, N5EG
DISCONNECT	D
BUSY	B
FRAME TRACE	FT
LOCAL TIME SET	LT DDMMYYHHMM
STANDARD MODE	SM
VERSION SELECT	V1

therefore, look like a standard user. Also allowed are connections to be established to any other node site via the 9600-bps trunk circuits. The latter is particularly useful for troubleshooting remote nodes from our network control site.

• **CONNECT AND DISCONNECT** are identical to the commands on any standard TNC.

• **BUSY** sets the console into a busy state to facilitate troubleshooting the network's end-to-end flow control logic.

• **FRAME TRACE** is similar to that command on any standard TNC in that it provides a real-time look at all frames as they're received by any physical channel on the node. Displayed are both hex and ASCII equivalents of the received frame.

• **LOCAL TIME SET** allows maintenance personnel to reset the real-time wall clock at a node. This command usually isn't used because it's possible to set the time at any node in the network from any other node using the network TIME command.

• **STANDARD MODE** permits an unused bit in the standard AX.25 protocol to be toggled. This bit is utilized by the PAD logic, network logic, and debug logic to signify that the remote is a special user capable of accessing advanced functions.

• **VERSION SELECT** allows the local console to originate connects in either AX.25 V1 or V2. This command controls only the originating version, since the common logic automatically accommodates either version on terminating connects.

The local console CRT interfaces to the NCP via one half of an SIO, which can be strapped for multiple baud rates. The console employs a 1000-character buffer to accommodate the speed differences between incoming text and the rate of display. Because the local console need not be equipped on a node, the console logic handles cases where no hardware is present.

Table 3. Some commands and functions supported by the debug logic.

Command	Format	Description
MEMORY	M Adr1,Adr2 M Adr1	Do a hex dump from memory location Adr1 to Adr2. Display the contents of memory location Adr1 and then wait for new contents to be entered. Entering a period escapes this mode.
COPY	C Adr1, Adr2, Adr3	Copy the contents of memory locations Adr1 to Adr2 to the new location, beginning with Adr3.
*(OFFSET)	* Adr1	The offset (*) register is useful for input arithmetic. For example, setting the * register to 1000H (*1000) allows subsequent entering of M* + 2 to display location 1002H.
HEX ARITH	H Num1 + Num2 - Num3	Perform hex arithmetic on any entered numbers. Addition and subtraction are supported with support of the offset (*) register.
PORT	P75	Display the contents of the Z-80 I/O address 75H, then wait for a new number to be input. Entering a period escapes this mode.
INITIALIZE	I Adr1, Adr2, Num	Initialize the memory block from Adr1 to Adr2 with the number (Num) entered.
EXECUTE	E Adr1	Transfer execution control to Adr1 with the Z-80 registers initialized per the "R" command.
REGISTER	R	Display and allow change of the Z-80 register file
X DIAGNOSTIC	X Adr1, Adr2	Run read/write/verify memory diagnostics on the memory block Adr1 to Adr2.

debugger

The debug logic (see *H* in **fig. 1**) has proved to be an invaluable aid in initial software debug as well as in system integration. The debugger at any node is accessed by specially authorized remote users via requesting a connect to the node utilizing a given SSID (usually -6). This logic supports a single user and inhibits others from connecting if someone is currently active.

The debugger executes concurrently with the network logic and the PMS, as well as at the same application level (see **fig. 1**). Accessed from the common logic, it is used as an aid in debugging these and other applications in an on-line manner.

Table 3 describes some of the commands and functions which are currently supported by the debug logic.

digipeating

Unless inhibited from doing so by the database, every network node can also function as a local digipeater (see *I* in **fig. 1**) for whatever frequency is being used as an input. In Dallas, it's 145.05. Multiple digipeater addresses are supported, thus allowing for any number of ALIASES or standard AX.25 addresses. It should be noted here that the PAD addresses mentioned above and the digipeater addresses are completely separate.

Enhanced digipeating is supported by the node because the output physical channel for retransmission of a packet is a function of both the digipeater address

and the physical channel on which the packet was received. Thus, it's possible to have a cross-frequency digipeater using no special tricks or logic. For example, N5EG-8 (Node 4, MURPHY) is configured to be a bidirectional cross-frequency digipeater between 2 meters and 450 MHz. This has proven to be extraordinarily useful in network software construction because it allows access to a remote node (one which is potentially many hops away) via digipeating over the 9600-bps trunk circuits. This method of access completely bypasses all other software and is, therefore, useful (in conjunction with the debugger) in troubleshooting.

conclusion

Thanks to the members of the Texas Packet Radio Society for helping to make this series of articles possible.

We'd like to hear from developers and users of other packet systems to learn what you're doing. Please address correspondence (enclose SASE) to Tom McDermott, N5EG, The Texas Packet Radio Society, P.O. Box 831566, Richardson, Texas 75083-1566.

references

1. Thomas H. Aschenbrenner, WB5PUC, and Thomas C. McDermott, N5EG, "The TEXNET Packet Switching Network: Part 1 — System Definition and Design," *ham radio*, March, 1987, page 29.
2. Thomas H. Aschenbrenner, WB5PUC, and Thomas C. McDermott, N5EG, "The TEXNET Packet Switching Network: Part 2 — Hardware Design," *ham radio*, April, 1987, page 29.
3. Bill Wade, WD5HJP, "Packet Radio Conference Bridge," *ham radio*, April, 1987, page 24.

ham radio

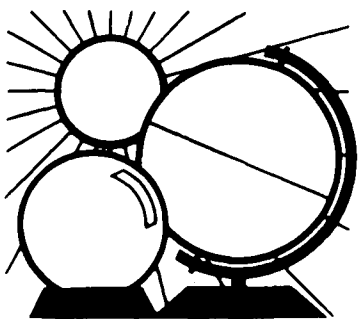

DX FORECASTER

Garth Stonehocker, KØRYW

sporadic-E season

During the summer months the sun — directly overhead at 23 degrees north — produces more ions in the lower ionosphere than it does in winter. These abundant ions are formed into cloud-like patches known as sporadic-E. The patches, which form in a thin but dense layer about 60 miles above the earth, give rise to strong mirror-like signal reflections over short-skip distances of 600 to 1200 miles.

Because E_s is related to the summer sun, the best locations for working these E_s openings are in the Northern Hemisphere from June through September and in the Southern Hemisphere during their summer, December through March. In each hemisphere, the best E_s is found on either side of the geomagnetic equator; it's especially good where the geomagnetic equator is furthest from the geographic equator. These special areas are Southeast Asia and the Mediterranean in the Northern Hemisphere and South America in the Southern Hemisphere, with the former the better, as shown in fig. 1. The contours in the figure represent the percentage of the time sporadic-E is available along that line. A "10-line" indicates that sporadic-E is available 10 percent of the month, or three days out of 30 — or, equivalently, 6 minutes out of each hour. This is a purely statistical measure of the chance of an E_s patch being available at the location of the midpoint of a 2000-km path. E_s openings can be utilized as high as the 6-meter band this year.

month, daily MUFs should be lower. As a result, fewer openings on 10 to 30 meters can be expected, except for a few sporadic-E short-skip paths. There's a slim possibility of one occurring on 6 meters. Long-skip conditions on these bands will improve somewhat in the third week. The lower bands will be best for daytime short-skip paths during the second week, corresponding to a minimum solar flux in June. Nighttime DX conditions should be best then as well, and should be fairly good during the whole month except when atmospheric noise levels are high.

The moon will be full and at perigee (its closest approach) on June 11.

Summer solstice is on the 21st at 2211 UTC. The Aquarid meteor shower starts about the 18th, peaks about the 28th, and lasts until about August 7. The maximum radio-echo rate will be 34 per hour.

band-by-band summary

Six meters will provide occasional openings to South Africa and South America around noontime via short-skip E_s propagation.

Ten meters will provide long-skip conditions in the afternoon during the peak times of the 27-day solar cycle. Otherwise, look to sporadic-E short-skip and multihop openings around local noon for DX on this band. (Trans-equatorial evening openings usually don't occur in the summertime.)

Twelve and fifteen meters, almost always open to some southern part of the world, will be the main daytime DX bands. Operate on 12 first, then move down to 15 later. DX is considered 5000 to 7000 miles on these bands. There may be some long one-hop transequatorial propagation early in the month.

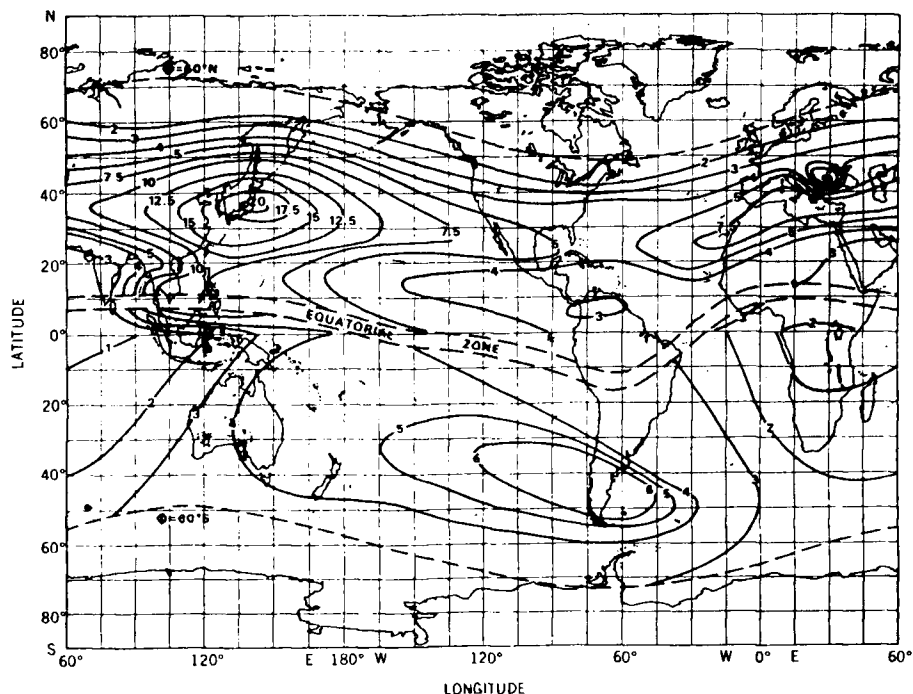

fig. 1. World map includes sporadic-E contours. The numbers on each line represent statistically the percentage of time during the month that a sporadic-E patch exists at that location.

last-minute forecast

During the first two weeks of the

WESTERN USA

GMT	PDT	Direction							
		N	NE	E	SE	S	SW	W	NW
0000	5:00	20	30	20	12	20	15	10	15
0100	6:00	20	30	20	15	20	12	10	15
0200	7:00	20	30	30	15	20	10	10	15
0300	8:00	15	30	30	20	20	10	10	15
0400	9:00	20	30	30	20	30	10	10	15
0500	10:00	20	20	20	20	30	12	12	15
0600	11:00	20	20	15	20	30	12	15	15
0700	12:00	20	20	15	20	30	15	15	20
0800	1:00	20	30	20	20	30	15	20	20
0900	2:00	30	30	30*	30	40	15	20	20
1000	3:00	30	30	20	30	40	20	20	20
1100	4:00	30	20	20	30	40	20	20	30
1200	5:00	30	20	15	20	40	20	20	30
1300	6:00	20	20	12	20	40	30	30	30
1400	7:00	20	20	12	15	40	20	30	20
1500	8:00	20	20	10	12	40	30	30	30
1600	9:00	20	20	10	12	40	30	30	40
1700	10:00	20	15	10	12	30	20	30	30
1800	11:00	30	15	12	12	20	20	30	20
1900	12:00	30	15	15	12	20	15	20	20
2000	1:00	30	20	15	10	20	12	12	20
2100	2:00	30	20	20	10	20	15	12	20
2200	3:00	20	20	20	10	20	12	10	20
2300	4:00	20	20	20	12	20	12	10	20

MID USA

GMT	MOT	Direction							
		N	NE	E	SE	S	SW	W	NW
0000	6:00	20	20	20	12	20	15	10	15
0100	7:00	20	30	20	15	20	12	10	15
0200	8:00	20	30	30	15	20	10	10	15
0300	9:00	20	40	30	20	30	10	12	15
0400	10:00	20	30	30	20	30	12	12	20
0500	11:00	20	30	20	20	30	12	15	20
0600	12:00	20	30	20	20	30	12	15	20
0700	1:00	30	20	20	20	30	15	15	20
0800	2:00	30	20	20	20	40	15	20	20
0900	3:00	30	20	30*	30	40	15	20	30
1000	4:00	30	30	20	30	40	20	20	30
1100	5:00	20	30	20	30	40	20	20	30
1200	6:00	20	20	15	20	40	30	30	20
1300	7:00	20	20	15	20	40	30	30	20
1400	8:00	20	20	12	15	40	30	30	20
1500	9:00	20	20	12	15	40	30	30	30
1600	10:00	20	20	10	12	40	20	30	30
1700	11:00	20	20	10	12	40	20	30	30
1800	12:00	20	20	12	10	20	15	15	20
1900	1:00	30	20	15	10	20	15	12	20
2000	2:00	30	20	15	10	20	15	12	20
2100	3:00	40	20	20	10	20	15	12	20
2200	4:00	30	20	20	10	20	12	10	20
2300	5:00	20	20	20	12	20	12	10	20

EASTERN USA

GMT	EDT	Direction							
		N	NE	E	SE	S	SW	W	NW
0000	8:00	20	20	20	12	20	10	10	20
0100	9:00	20	20	20	15	20	10	10	20*
0200	10:00	20	30	30	15	30	12	12	20
0300	11:00	20	40	30	20	30	12	12	20
0400	12:00	20	30	30	20	30	12	12	20
0500	1:00	30	40	20	20	30	15	15	20
0600	2:00	30	30	20	20	40	15	15	20
0700	3:00	30	30	30*	20	40	15	20	30
0800	4:00	20	20	20	20	40	20	20	30
0900	5:00	20	20	20	30	40	20	20	30
1000	6:00	20	20	15	20	40	30	30	20
1100	7:00	20	20	15	20	40	20	20	20
1200	8:00	20	20	12	15	40	20	20	20
1300	9:00	15	20	12	12	40	20	20	20
1400	10:00	20	20	10	12	40	20	30	20
1500	11:00	20	20	10	12	40	30	30	30
1600	12:00	20	20	10	12	30	20	30	30
1700	1:00	20	20	10	12	30	20	30	20
1800	2:00	20	20	12	12	20	15	30	20
1900	3:00	30	20	15	12	20	15	15	20
2000	4:00	30	20	15	10	20	15	12	20
2100	5:00	40	20	20	10	20	15	10	20
2200	6:00	30	20	20	12	20	12	10	20
2300	7:00	20	20	20	12	20	12	10	20

Shaded numbers signify the bands to try during the transition and early morning hours, while the standard type provides MUF during "normal" hours.

*Look at next higher band for possible openings.

MADISON SUMMER SHOPPER

New rigs and old favorites, plus the best essential accessories for the amateur.

CALL FOR ORDERS
1-713-520-7300 OR 1-713-520-0550
TEXAS ORDERS CALL COLLECT

ALL ITEMS ARE GUARANTEED OR SALES
PRICE REFUNDED
1 (800) 231-3057

EQUIPMENT

New Icom IC 761	Trades wanted
Kenwood TH205AT	Trade in your old HT
Kenwood TS 440S/AT	Call for trade
Icom R7000 25-2000 MHz	949 00
Icom IC735	849 00
Ten-Tec 2510 (Easy OSCAR)	439 00
KDK FM 240 NT	279 00
Mirage Amps	15% OFF
Tokyo Hy Power HL 1K AMP, no 4CX250B	699 00
New Kenwood TM-221A, 45W, mobile	Call
VJ Amplifier, VHF, built in England, 1 in-100 out, 3-100, 5-100	(ea) 269 00
10 in-100 out	229 00
25 in-160 out	319 00
All models include preamp	
Lunar 2M4-40P	109 00

ACCESSORIES

B&W VIEWSTAR ANTENNA TUNER	89 95
Heil HC4/HC5	Stock
Heil BM10 Boom Mike headset	CALL
Tri-H 5000A Remote Phone	\$189 00
Daiwa NS660A 30/300/3000 watts	135 00
Alinco ELH 230D- Excellent buy	88 00
Nye MB5-A (for the big boys!)	529 00
Shure 444D	54 95
Ameco PT-3	Soon
New Tokyo HC 200A	115 00
Astatic SilverEagle & Base	66 00
Ten-Tec Mobile Switch 3001	17 00

ANTENNAS

Isopole 144 MHz	44 95
AQP-1 Complete Oscar Antenna	149 95
Butternut HF6V, 80-10 vertical	125 00
HF2V, 80 & 40 vertical	119 00
HF4B	189 00
Hustler G7-144	119 95
Hustler 6BTU	139 00
KLM HF World Class Series Antennas	Call Don
ALPHA Delta DX-DD	63 00
Coax Seal	2.00/roll
B&W Dipoles	Less 10%
KLM KT-34A	399 00
W2AU, W2DU	Now Available
NEW KLM 1.2-44LBX	129 00
1296 Power Divider	Soon
Create CD-78 + BS 80 75/80 rotatable dipole	349 00
G5-RV	44 00

OTHER ANTENNAS

Diamond D-130 Discose 25-1300 MHz	79 00
Larsen Kuldack	17 00
Larsen 2M 1/2 wave telescope ant	25 00
Avanti AP151 3G on Glass Antenna	36 00
Anteco 2M, 5/8 Mag Mount, Comp	25 00
Orion 2M 1/2 wave Handy Antenna	19 00
Van Gordon SLA-1 160-80-40 Sloper	44 00
Valor AB-5 Mobile	79 95
Stoner DA100 D Active Rx Antenna	190 00
DC Tenna Hitch 3/8 24 Thread	
Fits 3/4" trailer hitches	29 95

PARTS

1.5 Amp/400V full wave bridge rectifier	1 95
2 5A/1000PIV Epoxy diode	29 each or 19 00/100
0015/10KV or 001/20KV	1 95 each
3N201	95
4 inch ferrite rod	1 95
365pF cap	1 95
Sanyo AAA AA Nicads w/tabs	2 00
2 4 5 6 8 pin mic plugs	3 00
1/8 1/4 watt carbon resistors	05 each
Meter 0-3000 VDC 0-1 Amp DC 2 1/2" Square with shunt	19 95
Drake—Collins mike plug	2 00
Thousands of panel meters	3 95 up CALL
MICA Cap 0004/3KV	5 00 others CALL
Diodes 3A/1000 PIV	29
Duracell 9 Volt Battery - 2 Pak MN1604	3 49
DC Fan 3 1/2" Sq x 1"	9 95
CINCH 12 pin conn fitz (Drake etc) female	3 00

AMPHENOL

8315P PL259 Silverplate	1 25
UG176 reducer RG8X	30
831J Double Female UHF	2 00
82-61 N Male	3 00

82-97 N Female Bulkhead	3 00
82-63 Inline Female N	4 00
82-98 N elbow	9 00
31-212 BNC-RG59	1 50
31-216 UG201 A/U N Male-BNC Female	2 00
31-2 BNC-RG58	1 50
34025 N Male, RG58	3 00
34125 N Female UHF male	9 00
3128 BNC Female-PL259	3 00
4400 N Male-S0 239	7 00



ICOM 28H/TTM 399 00

TUBES

Collins & Drake Replacement tubes	Stock
GE 6146B	12 95
3-500Z	109 95
GE Industrial Tubes	Call
GE 12BY7A	7 00
GE 6J56C	12 95
GE 8950	16 00
12JB6 Sylvania	6 00
Hard to find Tubes 50-90% off list	
6JB6A	9 95
6JE6C/6LQ6	9 95
572B	69 00
6KD6	10 95

PACKET POWER

AEA PK 232 with new WX FAX	299 00
Kantronics Packet II	149 00
MFJ 1270	119 00
MFJ 1274	149 00
AEA PM-1	149 00
New AEA UDC-232 Firmware, No modem, List 279 00	249 00
New Kantronics KAM	299 00

SERVICES

Complete KVM 2 Retube	179 00
Flat fee Collins rebuild	Call

USED EQUIPMENT

All equipment, used, clean, with 90 day warranty and 30 day trial. Six months full trade against new equipment. Sale price refunded if not satisfied.
Call for latest used gear list

TOWER ACCESSORIES

1/4" E H S Guy cable Rohn US 1000 ft	250 00
3/16" E H S cable Rohn US 1000 ft	210 00
1/4" Guy Cable 6100 #7 x 7 strand, import	18c/ft
3/16" Guy Cable 3700 #7 x 7 strand, import	15c/ft
3/8" x 6 E&J Turnbuckle	7 95
3/16" Wire Rope Clips	40
1/4" wire clips	50
1/4 Thimbles	45
Porcelain 500D Guy Insulator (3/16)	1 99
Porcelain 502 Guy Insulators (1/4)	3 39

POLICIES

Minimum order \$10 00 Mastercard, VISA, or C.O.D. All prices FOB Houston, except as noted. Prices subject to change without notice. Items subject to prior sale. Call anytime to check the status of your order. Texas residents add sales tax. All items full factory warranty plus Madison warranty

DON'S CORNER

New Nye 160-10m Tuner 3KW, deluxe, big box — coming soon

130

MADISON

Electronics Supply

3621 FANNIN
HOUSTON, TEXAS 77004



Twenty, thirty, and forty meters will support DX propagation from most areas of the world during the daytime and into the evening hours almost every day. Forty meters has joined this daytime DX group because of lower signal absorption, and therefore lower LUF (lowest usable frequency) during these sunspot minimum years. DX on these bands may be either long-skip to 2500 miles or short-skip E_s to 1250 miles per hop. The length of daylight is approaching maximum, providing many hours of good DXing.

Thirty, forty, eighty, and one-sixty are all good for nighttime DX. Although the background thunderstorm noise is beginning to be noticeable, these bands are still quiet enough to provide good DX working conditions. Sporadic-E propagation may be a contributing factor toward enhanced conditions at local sunset and will occur more often during the next three months.

ham radio

Announcing New 6- & 8-Pole Crystal Filters For ICOM, Kenwood & Yaesu Radios

- ICOM 730/735/740/745/751/R70/R71A SSB 2.1kHz, 8-Pole — Exact replacement for FL-44A. Model IR455HI.05X — \$99
- ICOM IC-271/471/1271/ CW 400Hz, 8-Pole — Great for DXing or EME. Model IR10.7H400C — \$115
- Kenwood TS-930/940/830/R-2000 CW Super Selective 250Hz 8-Pole 455 kHz Filter — Comes mounted on high-quality glass PC board for the TS-930 and TS-940, drops into the TS-830.
- Kenwood 930/940/830 2.1 kHz SSB Matched Filter Set \$150. Model IR455HI25C — \$125
- TS-940/930/830 Super Selective CW Switch Kit — This new kit allows you to add another CW bandwidth. For example, on the 930/940/830, if you already have 400Hz or 500Hz filters installed, you can now select a set of IR1250Hz filters. Our 250Hz matched set allows for a lower noise floor for super quiet DXing.
- 9mHz 8-Pole Crystal Filters for Experimenters — All 8-Pole Filters — \$60
All 6-Pole Filters — \$50

For SSB		For FM	
A. 2.4kHz @ 6dB	B. 2.1kHz @ 6dB	A. 1.5kHz @ 6dB	B. 30kHz @ 6 dB
C. 1.8kHz @ 6dB	D. 2.2kHz @ 6dB	For CW	
★ E. 2.2kHz @ 6dB	★ F. 600Hz @ 6dB	A. 600Hz @ 6dB	★ B. 600Hz @ 6dB
For AM		★ (6-pole)	
A. 6.0kHz @ 6dB	★ B. 6.0kHz @ 6dB	\$5.00 shipping and handling on all orders.	

For more information, call



International Radio, Inc.
747 So. Macedo Blvd.
154 Port St. Lucie, FL 33452
(305) 879-6868

Send S.A.S.E. (39¢) for latest catalog

build your own time-domain reflectometer

Solving transmission line difficulties can be a tedious and difficult chore, especially when the load end isn't easily accessible. Although a number of different methods of dealing with these problems are available, I want to discuss time-domain reflectometry this month; we'll cover some of the others in subsequent columns. Although commercial time domain reflectometers (TDRs) are expensive, some of the methods of time-domain reflectometry can be used by any Amateur who has access to an oscilloscope. The results won't be as good as those obtained with professional TDR equipment, but the methods will work.

TDR fundamentals

Time-domain reflectometry works on the principle that waves on a non-matched transmission line *reflect*. [Any variation from the characteristic impedance of the transmission line will cause a reflected component to be sent back to the source. — Ed.] The waveform seen at any given point along the line is the algebraic sum of the forward and reflected waveforms. In TDR measurements, we look at the waveform at the input end of the transmission line system.

Figure 1 shows the basic setup for a TDR. A pulse generator, or other source of 1-MHz square waves, is applied simultaneously to the vertical input of an oscilloscope and the input end of the transmission line. The simplest way of splitting the signal is to use an ordinary coaxial "tee" connector, either a BNC or UHF.

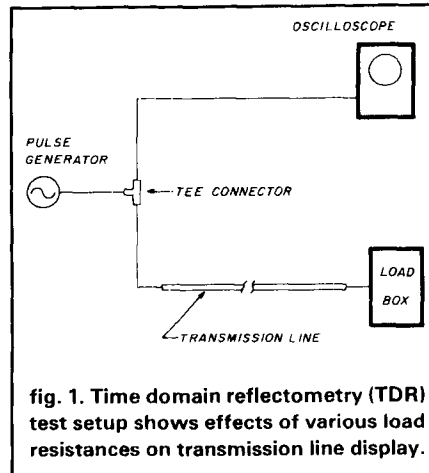

fig. 1. Time domain reflectometry (TDR) test setup shows effects of various load resistances on transmission line display.

pulse source

Almost any source of 1-MHz square waves can be used for the pulse generator. If you have a function generator with a 1 MHz or higher output pulse rate, you can use it; be careful, however, if the output impedance is 600 ohms. In such a case, you might want to wind a 600-to-50 ohm trans-

former or add a simple resistor pad. Alternatively, you can build your own pulse source.

building an oscillator

Many different forms of TTL oscillator can serve as a pulse source. **Figure 2A** is a circuit for a pulse generator that uses the Motorola MC-4024P device. This dual, TTL-compatible, voltage controlled oscillator is enclosed in a shielded box. The operating frequency is determined from $f = 300/C$, where f is the frequency in MHz and C is capacitance in pF. The actual operating frequency isn't terribly critical, as long as it's somewhere near 1 MHz. For very short transmission lines, the operating frequency may have to be increased. Experiment with it.

The output waveform is a square wave with a period of about 1.1 μ S, with $C1 = 330$ pF. The half-cycle used in the experiment (see **fig. 2B**) has a duration of 550 nanoseconds (0.55 μ S). If you want to clean up the rise

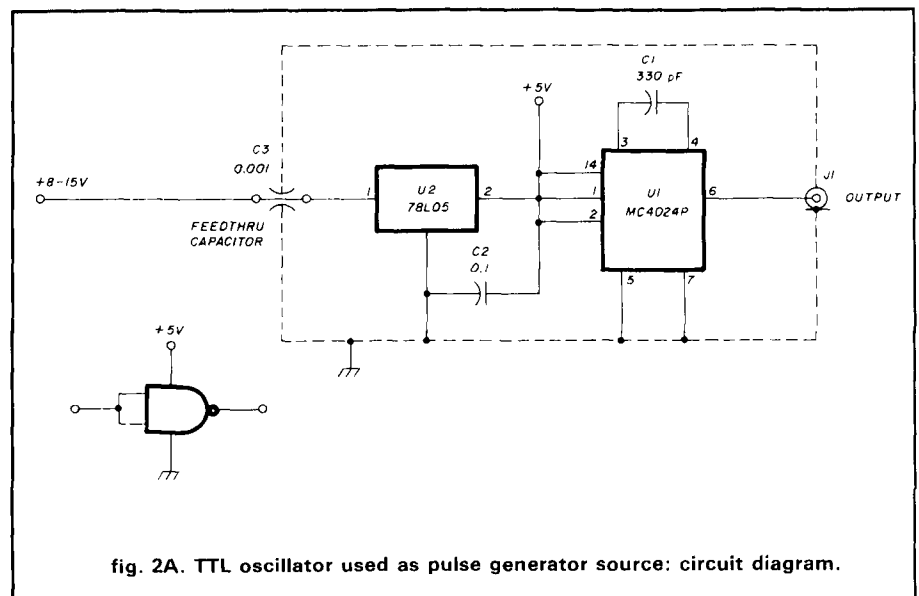

fig. 2A. TTL oscillator used as pulse generator source: circuit diagram.



SWL's: Are You Plagued By Phantom Signals?



Meet the Eliminator.

Don't let its small dimensions (4"x3"x2") fool you—the Grove **Minituner III** is a big weapon against images, intermod and phantom signals on your shortwave receiver!

This short wave/long wave pre-selector is designed to boost performance in the 100 kHz-30 MHz frequency range. If you own one of the popular general coverage communications receivers and are using an outside antenna, you **NEED** this extra measure of selectivity.

No power required. Simply connect between your receiver and antenna. Equipped for standard PL-259 connections. **Only \$39** (free UPS shipping; \$5 U.S. Mail/Parcel Post). Order TUN-3.



Grove Enterprises
140 Dog Branch Road
Brasstown, N.C. 28902

MC, Visa or COD call:
1-800-438-8155

Shop Grove for fantastic values in shortwave receivers, antennas, cable, performance boosting accessories and literature.

Call (704) 837-9200 or write to above address for free catalog!



SAVE YOUR EARS

WITH THIS HANDY SIGNAL ENHANCER

See Article in HR's December, 1986 issue

Hildreth Engineering

936 Azalea Drive Sunnyvale, CA 94086



SSB ELECTRONIC TRANSVERTERS & PREAMPLIFIERS

LT 2S	144/28 XVRTR 20W GaAsfet DBM	TBA
LT33S	902/144 Xvrtr 20W GaAsfet	\$549
LT23S	1296/144 Xvrtr 10W GaAsfet	\$549
MICRO-13	2304/144 XVRTR 0.5W GaAsfet	\$429
MICRO-X	10368/144 Xvrtr 0.1W GaAsfet	\$599
DX	series low noise GaAsfet preamps	from \$129
MV	series mast mounted GaAsfet preamps	\$199
K	series rx cnvtrs GaAsfet DBM	from \$129

TRANSVERTERS UNLIMITED

T220/28	220 Mhz Xvrtr 28 or 50 IF, 20 W	\$220
T144/28	144 Hhz Xvrtr 28 or 50 IF, 25 W	\$199
PA23200	1296 Mhz 2 tube PA, 200W +	\$299
PA23150	1296 2tube PA, 150 + W	\$449
PA1325	2304 1tube PA, 25 + W	\$429
HF400	High power relay 2Kw at 144 Mhz	\$129
RK500	Medium power relay 1KW at 144 Mhz	\$ 69

Call or write for catalogue.

TRANSVERTERS UNLIMITED **HANS PETERS (VE3CRU)**
BOX 6286 STATION A (416) 759-5562
TORONTO, ONTARIO
CANADA M5W 1P3

LOW BAND DX-ING COMPUTER PROGRAMS

by John Devoldere, ON4UN,

for Apple IIe/c, MS-DOS, Commodore C-128 Apple Macintosh and Kaypro CPM Computers

Here's a collection of 30 super programs written by ON4UN. Just about every interest or need is covered—from antenna design and optimization to general operating programs. Antenna programs include: shunt and series input L network design, feedline transformer, shunt network design, SWR calculation, plus 11 more! General Ham programs include: sunrise/sunset, great circle distances, grayline, vertical antenna design program, sunrise calendar plus 9 more! Phew. When you sit down to use these programs you'll be amazed at what you have. Super value at a super low price. The best value in computer software available today. © 1986.

<input type="checkbox"/> UN-Apple IIe/c	\$19.95	<input type="checkbox"/> UN-C-128 (COMMODORE)	\$19.95
<input type="checkbox"/> UN-MS (MS-DOS)	\$19.95	<input type="checkbox"/> UN-MAC (MACINTOSH)	\$24.95
<input type="checkbox"/> UN-CPM/Kaypro	\$19.95	Please add \$3.50 for shipping and handling	

HAM RADIO'S BOOKSTORE

Greenville, NH 03048 (603) 878-1441





TUBES — 2000 TYPES DISCOUNT PRICES!

Early, hard-to-find, and modern tubes. Also transformers, capacitors and parts for tube equipment.
Send \$2.00 for 20 page wholesale catalog.

Antique Electronic Supply
688 W. First St. • Tempe, AZ 85281
602/894-9503



fig. 2B. TTL oscillator used as pulse generator source: output waveform.

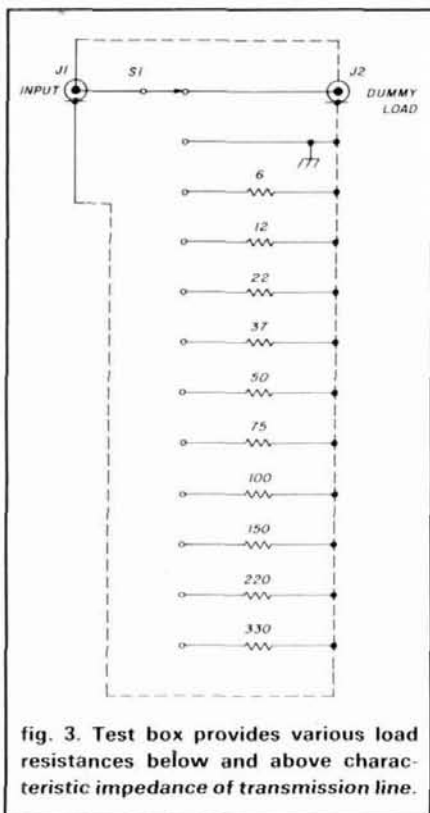

fig. 3. Test box provides various load resistances below and above characteristic impedance of transmission line.

and fall times of the output waveform, pass the output through either an inverter made from an "H" series TTL or a Schmitt trigger (7414). The inset to fig. 2A shows an inverter made by strapping the inputs of a 74H00 NAND gate.

Figure 2B was photographed from my oscilloscope with the coaxial cable disconnected. In the following photos, we'll see what this pulse looks like when a reflected pulse hits it after returning from its round trip on the transmission line.

Another alternate pulse generator is a 1- or 2-MHz crystal oscillator. These oscillators can also serve as marker generators for other purposes.¹ Another possibility would be a 20-MHz TTL crystal oscillator with cascaded TTL frequency dividers providing 10-MHz, 5-MHz, 2-MHz, 1-MHz, 500-kHz, 100-kHz, 50-kHz, and 10-kHz outputs. There's no reason the marker generator can't be used as the pulse source in TDR measurements.

test setup

The test setup shown in fig. 1 was built to accomplish these measurements. The load box (see fig. 3) at the "antenna" end of the transmission line is a multi-impedance dummy load. The choices are ten discrete impedances, a short circuit, or an external load. When the external dummy load is disconnected, the load box sees an open transmission line in that switch position. (Why have a load box? It isn't part of the TDR, but it helped in calibrating the system and in generating the pictures that follow.) The impedance values shown were selected to represent a wide range of actual impedances typically encountered in Amateur antennas.

measurements

Figure 4 shows two conditions that often occur on transmission lines: open circuits and short circuits. It rarely matters which one happens; both need to be corrected at the antenna end. The VSWR reading won't tell you which one has occurred, because in either case the entire incident wave is reflected. The only difference is the location of the nodes and anti-nodes, which are out of phase with each other. If the exact electrical length of the line is known, we can determine whether the line is open or shorted. Otherwise, we'll need to make a TDR measurement.

Figure 4A shows the waveform when the load end of the line is short circuited (in other words, when Z_L is zero). In the opposite case, an open-circuited line (with infinite impedance) appears as shown in fig. 4B.

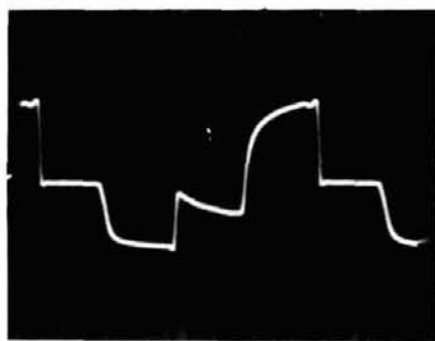

fig. 4A. Waveform seen on the oscilloscope under extreme load conditions: short circuit.

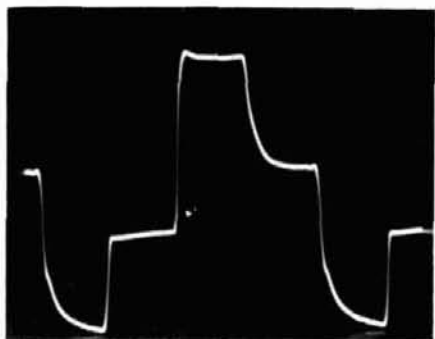

fig. 4B. Waveform seen on the oscilloscope under extreme load conditions: open circuit.

As you might suspect, impedances between zero and infinity are represented by various combinations (see fig. 5 of the two waveforms shown in fig. 4. Figure 5A shows the supposedly matched 50-ohm case. If the system were perfect, the top edge of the pulse would be totally flat. But the actual resistor used in the load box was 51 ohms (with 5 percent tolerance). In addition, there's bound to be some reactance in the load, and perhaps some anomalies in the coax itself. When I performed this little experiment before, using a non-inductive 200-ohm potentiometer as the load, I was able to all but totally adjust out the lack of flatness. As you'll see in a moment, the waveform in fig. 5A represents a real load impedance greater than 50 ohms.

The waveform shown in fig. 5B is for a 22-ohm load. This impedance is common on vertical antennas. (The nominal impedance for quarter-wave-



Your SINGLE SOURCE for MOBILE ANTENNAS!

NEW . . . 2 meter squared SSB mobile \$45.⁰⁰

Bug Catchers . . . still the best HF mobile antenna 250 watt & 1kw sizes 80-10meters (we pay shipping on above items)
Call for other antennas available—both commercial and amateur

MISSION COMMUNICATIONS
11903 Alief Clodine Rd #500
Houston, Texas 77082
713-879-7764
telex 166872 MCON UT
(MC/VISA/COD)

✓ 123

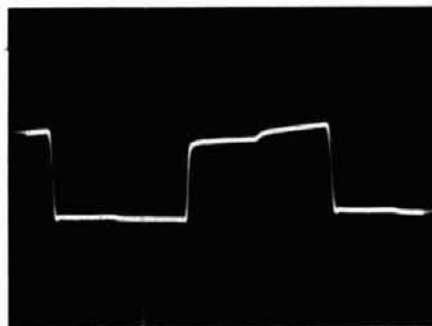

fig. 5A. Waveform seen on oscilloscope under typical load conditions: 50 ohms.

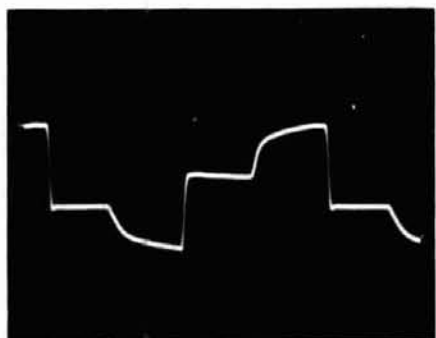

fig. 5B. Waveform seen on oscilloscope under typical load conditions: 22 ohms.

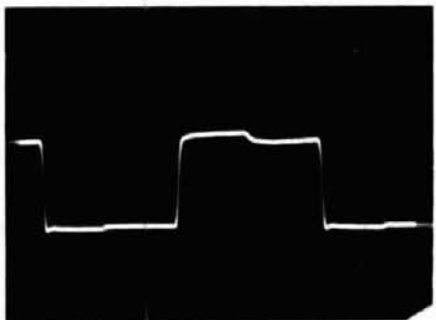

fig. 5C. Waveform seen on oscilloscope under typical load conditions: 75 ohms.

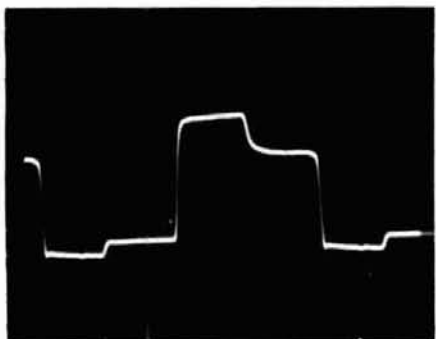

fig. 5D. Waveform seen on oscilloscope under typical load conditions: 150 ohms.

length vertical is 37 ohms, but impedances will lower for shorter verticals.)

With load impedances greater than 50 ohms, the waveform takes on a different shape. Instead of the reflected impedance causing a little rise in the flat-top edge, it causes a droop. By comparing **figs. 5C** and **5D** you can see that the amount of droop is related to how far above the surge impedance the load is.

The ideas presented here work, but I'm sure they can be improved upon. If you have any ideas, let me know. (Please note new address: P.O. Box 1099, Falls Church, Virginia 22041; current *Callbook* address is incorrect).

repairs in a jungle QTH

A missionary friend of mine, home on leave from some jungle QTH, asked about tools, parts, and test equipment to take with him when he returns. His purpose: to keep his two SSB rigs operating. (One is a Kenwood TS-130 for Amateur operation, and the other's a six-channel, crystal-controlled portable HF SSB rig from Stoner Communications. The Stoner has been the mainstay of backpacking missionaries, but the new Yaesu portable is making inroads in that market). Although I have plenty of experience, including years of communications repair shop time and more than a few Beer Days . . . errr, I mean *Field Days* . . . I'm soliciting your help in this matter.

Why? Well, once upon a time a couple planning to spend a year on a desert island asked a physician — who had never been in such a situation — what medicines they should take with them. While they used few of the recommended medicines (except for aspirin), they regretted not having taken along a topical antibiotic for skin infections. If you've had any experience with repairing radio communications gear in remote areas, I would especially appreciate hearing from you.

references

1. R. Richardson, W4UCH, "Low-cost Spectrum Analyzer with Kilobuck Features," *ham radio*, September, 1986, page 82.

ham radio

BLACK DACRON® POLYESTER ANTENNA ROPE

- UV-PROTECTED
- HIGH ABRASION RESISTANCE
- REQUIRES NO EXPENSIVE POTTING HEADS
- EASY TO TIE & UNTIE KNOTS
- EASY TO CUT WITH OUR HOT KNIFE
- SIZES: 3/32" 3/16" 5/16"
- SATISFIED CUSTOMERS DECLARE EXCELLENCE THROUGHOUT U.S.A.

LET US INTRODUCE OUR DACRON® ROPE TO YOU • SEND YOUR NAME AND ADDRESS AND WE'LL SEND YOU FREE SAMPLES OF EACH SIZE AND COMPLETE ORDERING INFORMATION



synthetic textiles, inc.
2472 EASTMAN AVENUE, BUILDING 21
VENTURA, CALIFORNIA 93003 (805) 658-7903

✓ 124

THE SOTRON
ANTENNAS FROM 160-10 METERS

NO TUNERS!
NO RADIALS!
NO RESISTORS!
NO COMPROMISE!

THREE EXCELLENT REVIEWS JUST DON'T HAPPEN BY CHANCE.
CALL US FOR A FREE CATALOGUE.

BILAL COMPANY
S.R. 2, Box 62, Dept. 2
Eucha, Ok. 74342 (918) 253-4094

✓ 125

Light Weight/ High Strength ALUMINUM Tubing for Masts and Telescoping Elements

How many antennas have you seen ruined by the failure of the mast? If you are stacking antennas, or have a beam antenna, our Light Weight/High Strength Aluminum masts will increase the survivability of your antenna system. These masts are 67% lighter and 50% stronger than galvanized steel tubing. Example of weight difference: 1/4" wall x 2" OD x 24' long; AL, 39 lbs., Steel, 112 lbs.

Sizes available:

1-1/2" to 8" OD x 1/8" to 3/4" wall x 24' long
1/4" to 2" OD x .058" wall x 12' long (drawn for telescoping)

Club and volume discounts are offered. MC & VISA accepted. For a complete stock/price list, please write or call:

Metal & Cable Corp., Inc.

(formerly Exmet, Inc.)
P.O. Box 117, 2170 E. Aurora Rd.
Twinsburg, Ohio 44087
(216) 425-8455

COMMODORE 64 LADDER NETWORK ANALYSIS PROGRAM "ALADYN-64"

This program is a menu-driven design tool with a built-in circuit file editor, fast calculations and graphic output to either the screen or printer. Useable for circuits which operate from VLF through Microwave. Circuit elements include R's, L's, C's, transmission lines, transistors and FET's. Output format rectangular or Smith chart.

\$59.95 PPD. Check or M.O.
INTERCEPTOR ELECTRONICS INC.
ROUTE 1, BOX 439, ROUND HILL, VA
22141-9307 PHONE (703) 338-4905

1986-87 CALL DIRECTORY (on microfiche)

Call Directory \$8
Name Index \$8
Geographic Index \$8

All three — \$20
Shipping per order \$3

BUCKMASTER PUBLISHING
Mineral, Virginia 23117
703-894-5777

**Sub Problem?
Contact Sue. She'll
fix it for you!**

(603) 878-1441

Ham Radio
Greenville, N. H. 03048

Barry Electronics Corp.

WORLD WIDE AMATEUR RADIO SINCE 1950
Your one source for all Radio Equipment!

For the best buys in town call:
212-925-7000
Los Precios Mas Bajos en
Nueva York ...

**KITTY SAYS: WE ARE NOW OPEN 7 DAYS A WEEK.
Saturday & Sunday 10 to 5 P.M.**
Monday-Friday 9 to 6:30 PM Thurs. to 8 PM
Come to Barry's for the best buys in town.

ONV Safety
belts-in stock



ICOM

ICRT1A 753A 745 738AN MA 48A Mod-24 R-7000
IC-9E IC-375A 275AM 300R 475AM 735

KENWOOD



TS440SAT, R-5000, R-2000, TS-940 SAT, TM-201B,
TM-221A421A, TM-2570A/50A/30A, TM-751A,
Nameless, Service/Repair, TM-2131A1 BT TS-71AB11A,
TM3530A, TH205AT, TH215A

RF Concepts

NEL-TECH-DK-W Digital Voice Keyer
COMPU-FIRE EXTINGUISHERS

VoCom/Mirage/Alinco
Tokyo Hy-Power/TE SYSTEMS
Amplifiers &
5/8" HT Gain
Antennas IN STOCK

Soldering
Station,
48 Watts, \$68

MICROLOG-ART 1, Air Disk,
SWL, Morse Coach

KANTRONICS
UTU, KAM, UTU-XT,
KPC 2400, KPC IV

EIMAC
3-500Z
572B, 6J56C
12BY7A &
4-400A

BIRD
Wattmeters &
Elements
in Stock

AEA 144 MHz
AEA 220 MHz
AEA 440 MHz
ANTENNAS

Computer Interfaces
stocked: MFJ-1270B,
MFJ-1272, MFJ-1224, AEA
CP-1 PK-87, PK-64A, PK-64,
PM-1, PK-232

Complete Butternut Antenna
Inventory In Stock!

DIGITAL FREQUENCY COUNTERS
Tritonys, Model TR-1000, 0-600 MHz

AMP SUPPLY STOCKED
Long range Wireless
Telephone for export in stock

BENCHER PADDLES,
BALUNS,
IN STOCK

MIRAGE AMPLIFIERS
ASTRON POWER SUPPLIES
Saxton Wire & Cable

MAIL ALL ORDERS TO BARRY ELECTRONICS CORP., 512 BROADWAY, NEW YORK CITY, N.Y. 10012.

New York City's LARGEST STOCKING HAM DEALER COMPLETE REPAIR LAB ON PREMISES

"Aqui Se Habla Espanol"

BARRY INTERNATIONAL TELEX 12 7670
MERCHANDISE TAKEN ON CONSIGNMENT
FOR TOP PRICES

Monday-Friday 9 A.M. to 6:30 P.M. Thursday to 8 P.M.
Saturday & Sunday 10 A.M. to 5 P.M. (Free Parking)

AUTHORIZED DIST. MCKAY DYMEK FOR
SHORTWAVE ANTENNAS & RECEIVERS
IRTILEX-Spring St. Station

Subways: BMT-Prince St. Station
IND-"F" Train Bwy. Station
Bus: Broadway #6 to Spring St.
Path-9th St. 9th Ave. Station

Commercial Equipment
Stocked: ICOM, MAXON,
Midland, Standard, Wil-
son, Yaesu. We serve
municipalities, busi-
nesses, Civil Defense
etc. Portables, mobiles,
bases, repeaters

We Stock: AEA, ARRL, Alpha, Ameco, Antenna Specialists, Astatic, Astron,
B & K, B & W, Bencher, Bird, Butternut, CDE, CES, Collins, Communications
Spec. Connectors, Covercraft, Cushcraft, Dawa, Dentrin, Digimax, Drake,
ETO (Alpha), Eimac, Encorn, HeilSound, Henry, Hustler (Newtronics), Hy-
Gain, Icom, KLM, Kantronics, Larsen, MCM (Dawa), MFJ, J.W. Miller, Mini-
Products, Mirage, Newtronics, Nye Viking, Palomar, RF Products, Radio
Amateur Callbook, Rockwell Collins, Saxton, Shore, Telex, Tempo, Ten-Tec,
Tokyo Hi Power, Tronics TUBES, WZAL, Water, Wilson, Yaesu Ham and
Commercial Radios, Voccom, Vibroplex, Curtis, Tri-Ex, Wacom Duplexers,
Repeaters, Phelps Dodge, Fanon Intercoms, Scanners, Crystals, Radio
Publications.

WE NOW STOCK COMMERCIAL COMMUNICATIONS SYSTEMS

HAM DEALER INQUIRES INVITED. PHONE IN YOUR ORDER & BE REIMBURSED
COMMERCIAL RADIOS stocked & serviced on premises.
Amateur Radio Courses Given On Our Premises, Call SALES
Export Orders Shipped Immediately. TELEX 12-7670 FINAL

Barry Electronics Commercial Radio Dept. offers the Best in two-way communications for Business, Municipalities, Civil Defense, Broadcasting Companies, Hospitals, etc. Sales and Service for all brands: Maxon, Yaesu, Icom, Tad, Octagon, Regency/Wilson, Midland, Standard, Uniden, Shinway, Fujitsu, Seas, Spillsbury, Neutec, etc. Call or write for information. 212-925-7000.

ALL ABOUT VERTICAL ANTENNAS by Bill Orr, W6SAI and Stu Cowan, W2LX

Smart DX'ers know that the vertical antenna can be the secret to low band DX success. Theory, design, construction, operation—all the secrets of making the vertical work—are fully covered by Ham Radio's well known columnist and book author Bill Orr in a clear concise easy-to-read text. Orr is a master at making the complex simple and this book is no exception. Here's just a sample of what this exciting new book covers: Horizontal vrs vertical—which is best? Top loaded and helical antennas, 5 high efficiency Marconi antennas for 80 and 160, verticals and TVI—is there a problem? The effects of ground on vertical antennas and a how to make an effective ground system, The Bobtail beam, construction data for 25 different antennas, matching circuits of all descriptions—which is best, plus P-L-E-N-T-Y more! For years Hams have been asking for this book. Get your's now. You won't regret it! © 1986

Please enclose \$3.50
to cover
shipping and handling

**ham
radio** magazine

GREENVILLE, NH 03048



RP-VA

Softbound \$10.95

BOOKSTORE

603-878-1441

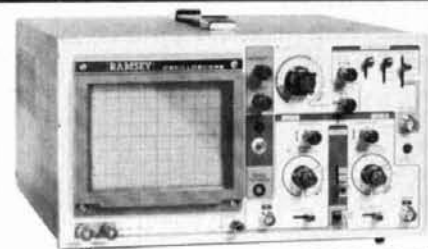

\$369.95*
INCLUDES 2 HOOK-ON PROBES
20 MHz DUAL TRACE

Features component testing circuit for resistors, capacitors, digital circuits and diodes—TV sync filter—high sensitivity—Z axis—XY mode—built-in calibrator—5X horizontal magnifier

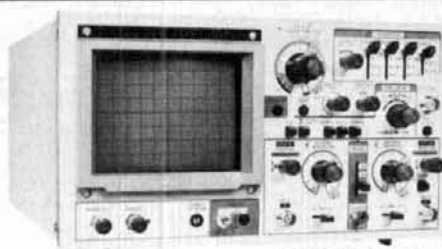

\$499.95*
INCLUDES 2 HOOK-ON PROBES
35 MHz DUAL TRACE

wide frequency bandwidth—optimal sensitivity—delayed triggering sweep—hold off—ALT trigger—single sweep TV sync 5X magnification—XY or XYZ operation—HF/LF noise reduction



\$449.95*
INCLUDES 2 HOOK-ON PROBES
15 MHz DUAL TRACE PORTABLE

Field/bench applications—built-in charger and battery pack—up to 2 hours operation per charge—5X horizontal magnification—high brightness CRT—front panel trace rotator

RAMSEY OSCILLOSCOPES

All Ramsey oscilloscopes feature unsurpassed quality at an unbeatable price. Of heavy duty construction, they are suitable for hobby, service and production applications.

*Add an additional \$10.00 for each unit for shipping.

MODEL	BAND WIDTH	# TRACES	CRT SIZE	VERTICAL SENSITIVITY	MAXIMUM TRIG FREQ	USEABLE MAXIMUM BANDWIDTH
2200	20 MHz	(2)	8x10CM	5 mV per div	35 MHz	30 MHz
2500	15 MHz	(2)	3.5 inch	2 mV per div	30 MHz	25 MHz
3500	35 MHz	(2)	8x10CM	1 mV per div	50 MHz	60 MHz

All include high quality 1:1, 10:1 hook on probes, instruction/service manual with schematic and component layout, 1 year warranty.

MINI-100 COUNTER



\$119.95 CHARGER, NICAD BATTERIES, AC ADAPTER INCLUDED

CT-70 7 DIGIT 525 MHz



\$139.95 WIRED INCLUDES AC ADAPTER

CT-90 9 DIGIT 600 MHz



\$169.95 WIRED INCLUDES AC ADAPTER

CT-50 8 DIGIT 600 MHz



\$189.95 WIRED INCLUDES AC ADAPTER

CT-125 9 DIGIT 1.2 GHz



\$189.95 WIRED INCLUDES AC ADAPTER

MODEL	FREQ RANGE	SENSITIVITY	ACCURACY	DIGITS	RESOLUTION	PRICE
MINI-100	1-500 MHz	Less than 250mv	1 PPM	7	100 Hz, 1 KHz	119.95
CT-70	20 Hz-550 MHz	< 50mv To 150 MHz < 150mv To 600 MHz	1 PPM	7	1Hz, 10Hz, 100Hz	139.95
CT-90	10 Hz-600 MHz	< 10mv To 150 MHz < 150mv To 600 MHz	1 PPM	9	0.1Hz, 1Hz, 10Hz	169.95
CT-50	5 Hz-600 MHz	LESS THAN 25 mv	1 PPM	8	1Hz, 10Hz	189.95
CT-125	10 Hz-1.25 GHz	< 25mv @ 50 MHz < 15mv @ 500 MHz < 100 mv @ 800 MHz	1 PPM	9	0.1Hz, 1Hz, 10Hz	189.95
CT-90 WITH OV-1 OPTION	10 Hz-600 MHz	< 10mv To 150 MHz < 150mv To 600 MHz	0.1 PPM	9	0.1Hz, 1Hz, 10Hz	229.90

RAMSEY FREQUENCY COUNTERS

Ramsey Electronics has been manufacturing electronic test gear for over 10 years and is recognized for lab quality products at breakthrough prices. Our frequency counters have features and capabilities of counters costing twice as much. BP-4 Nicad battery pack for CT-70, CT-90 and CT-125 Frequency Counters. \$8.95.



RAMSEY D-4100 COMPACT DIGITAL MULTITESTER

\$249.95

test leads and battery included



Compact sized reliability and accuracy. This LCD digital multimeter easily fits in your pocket, you can take it anywhere. It features full overload protection • 3 1/2 digit LCD readout • recessed input jacks • safety probes • diode check function • 2000 hours battery life



RAMSEY D-5100 HANDHELD DIGITAL AUTORANGING METER

\$49.95

Includes Probes 1 Year Warranty

Has TOUCH-HOLD feature to allow readings to be logged or referred to before making the next reading. Up to 10 AMP current capability and a continuity function which beeps on zero Ohms.



\$449.95

wired includes AC adapter
PR-2 kit \$39.95

PR-2 COUNTER PREAMP
The PR-2 is ideal for measuring weak signals from 10 to 1,000 MHz • flat 25 db gain • BNC connectors • great for sniffing RF • ideal receiver/TV preamp



\$699.95

wired
PS-2 kit \$49.95

PS-2 AUDIO MULTIPLIER
The PS-2 is handy for high resolution audio resolution measurements, multiplies up in frequency • great for PL tone measurements • multiplies by 10 or 100 • 0.01 Hz resolution & built-in signal preamp/conditioner



\$899.95

wired includes AC adapter

PS-10B 1 GHz PRESCALER
Extends the range of your present counter to 1 GHz • 2 stage preamp • divide by 1000 circuitry • super sensitive (50 mV typical) • BNC connectors • 1 GHz in, 1 MHz out • drives any counter

MINI KITS—EASY TO ASSEMBLE—FUN TO USE—FOR BEGINNERS, STUDENTS AND PROS

<p>TONE DECODER A complete tone decoder on a single PC board. Features: 400-5000 Hz adjustable range via 20 turn pot, voltage regulation, 567 IC. Useful for touch-tone burst detection, FSK, etc. Can also be used as a stable tone encoder. Runs on 5 to 12 volts</p> <p>Complete kit TD-1 \$5.95</p>	<p>COLOR ORGAN See music come alive! 3 different lights flicker with music. One light each for high, mid-range and lows. Each individually adjustable and drives up to 300 W. runs on 110VAC</p> <p>ML-1 Kit \$8.95</p>	<p>VIDEO MODULATOR Converts any TV to video monitor. Super stable, tunable over ch 4-6. Runs on 5-5V accepts dist. video signal. Best unit on the market! Complete kit, VD-1</p> <p>\$7.95</p>	<p>FM WIRELESS MIKE Transmits up to 300' to any FM broadcast radio. Uses any type of mike. Runs on 3 to 9V. Type FM-2 has added sensitive mike preamp stage</p> <p>FM-1 kit \$3.95 FM-2 kit \$4.95</p>	<p>SUPER SLEUTH A super sensitive amplifier which will pick up a pin drop at 15 feet! Great for monitoring baby's room or as general purpose amplifier. Full 2W rms output, runs on 6 to 15 volts, uses 8-45 ohm speaker</p> <p>BN-9 kit \$5.95</p>	<p>TELEPHONE TRANSMITTER Low cost with professional performance. Features include: self phone line powered, tunable from 76 to 100 MHz, polarity antiseismic, compact size (1" x 1"), easily installs anywhere on the phone line or inside the instrument itself</p> <p>PS-1 kit \$14.95</p>	<p>FM MINI MIKE A super high performance FM wireless mike kit! Transmits a stable signal up to 300 yards with exceptional audio quality by means of its built in electret mike. Kit includes case, mike, on-off switch, antenna, battery and super instructions. This is the finest unit available!</p> <p>FM-3 kit \$14.95 FM-3 Wired and Tested 19.95</p>	
<p>40 WATT 2 mtr PWR AMP Simple Class C power amp features 8 times power gain 1W in for 8 out, 2W in for 15 out, 5W in for 40 W out. Max output of 50 W, incredible value, complete with all parts, less case and T-R relay</p> <p>PA-1, 40 W pwr amp kit \$22.95 TR-1, RF sealed T-R relay kit 6.95</p>	<p>VOICE ACTIVATED SWITCH Voice activated switch kit provides switched output with current capability up to 100 mA. Can drive relays, lights, LED or even a tape recorder motor. Runs on 9VDC</p> <p>VS-1 kit \$6.95</p>	<p>LED BLINKY KIT Alternately flashes 2 jumbo LEDs. Use for name badges, buttons, warning panel lights. Runs on 3 to 15 volts</p> <p>BL-1 kit \$2.95</p>	<p>MAD BLASTER Produces LOUD ear shattering and attention getting siren like sound. Can supply up to 15 watts of obnoxious audio. Runs on 6-15 VDC</p> <p>MB-1 kit \$4.95</p>	<p>60 Hz TIME BASE Runs on 5-15 VDC. Low current (25ma) 1 min/month accuracy</p> <p>TB-6 kit \$5.50 TB-6 Assy \$9.95</p>	<p>UNIVERSAL TIMER Provides the basic parts and PC board required to provide a source of precision timing and pulse generation. Uses 555 timer IC and includes a range of parts for most timing needs</p> <p>UT-5 kit \$5.95</p>	<p>WHISPER LIGHT An interesting kit, small mike picks up sounds and converts them to light. The louder the sound, the brighter the light. Includes mike, controls up to 300 W, runs on 110VAC</p> <p>WL-1 kit \$6.95</p>	<p>SIREN Produces upward and downward wail. 5 W peak audio output, runs on 3-15 volts, uses 3-45 ohm speaker</p> <p>Complete kit, SM-3 \$2.95</p>

ACCESSORIES FOR RAMSEY COUNTERS

- Telescopic whip antenna—BNC plug \$ 8.95
- High impedance probe, light loading 16.95
- Low pass probe, audio use 16.95
- Direct probe, general purpose use 13.95
- Tilt bail, for CT-70, 90, 125 3.95

PHONE ORDERS CALL

716-586-3950

TELEX 466735 RAMSEY CI

FAX 716-586-4754



TERMS: • satisfaction guaranteed • examine for 10 days; if not pleased, return in original form for refund • add 6% for shipping and insurance to a maximum of \$10.00 • foreign add 15% (for surface mail) • CDD add \$2.50 (CDD in USA only) • orders under \$15.00 add \$1.50 • NY residents add 7% sales tax • 90 day parts warranty on all kits • 1 year parts & labor warranty on all wired units.

RAMSEY ELECTRONICS, INC.
2575 Baird Ave.—Dept. HR
Penfield, N.Y. 14526

microwave portable operation

Spring and summer are the seasons of the year for VHF/UHF microwavers to dust off their rigs, fix all the gear that's been waiting for their attention, and get set to do some serious operating.

Portable operation offers some unique opportunities, especially if the home QTH isn't an ideal VHF location. Other reasons are often centered on the thrill of putting out rare VUCC grid squares, setting new DX records, or just the desire to commune with nature while enjoying our favorite activity. It presents some special problems however, not only for newcomers, but for old-timers as well. Often special equipment and antennas are required and things *can go wrong* — even things that might have been easily anticipated.

selecting your location

One of the first considerations in going portable is the choice of location. For starters, it probably would be advisable to select a location that's reasonably close to home. This will incur minimum expense, and if something goes wrong, you can either go home and bring back reinforcements or just QRT. After a few local operations, go for the long haul!

Successful portable or contest operation demands careful preparation. First, you'll have to determine whether the chosen location is accessible by conventional vehicles. Can you get there by four-wheel drive, or will you have to hike the last part of the trip? If you have to hike, what about lugging all the gear to the site? Is power available, or do you have to bring your own? (More on this shortly.)

Is the chosen location sufficiently clear so that you won't have problems erecting an antenna high enough to get above local obstructions — such as tall trees? It's always best to secure

a topographic or geological survey map in advance. Usually available in local book stores, libraries, or sporting goods shops that carry camping or backpacking gear, such maps typically cover only a 7-1/2 minute section, 1/8 of a degree, or about a 6- by 9-mile area at midlatitudes. Therefore, more than one map may be necessary.

Accurate, detailed maps are invaluable, especially if you intend to operate near a state, county, or grid square border. You must always know, with a reasonable degree of certainty, *that you really are where you think you are!* Bring a camera; photos are good evidence, and you and your friends can enjoy the pictures for years to come (see **fig. 1**). They can also help when briefing others who may be interested in operating from the same location later on.

If possible, contact a local resident (preferably an Amateur) who's familiar with the area in question, or visit the proposed location before your operat-

ing excursion. Bring a small rig to try out the location. Check out possible operating positions, available facilities, and power sources. Don't underestimate travel and setup time! A preparatory visit will also give you a feel for the travel time from your home QTH so you can be on site and ready to operate at the scheduled time.

Even if you've visited the proposed location beforehand, bring a magnetic compass. Find the local magnetic offset for the proposed location before you leave home. In the New England area, the magnetic offset is over 15 degrees! If you have a distance and bearing program, this can be determined before you go.¹ Enter the approximate location for the magnetic north pole at 76 degrees north latitude and 101 degrees west longitude into your program.

An elementary knowledge of astronomy is also helpful for locating the North Star, but obviously this will be impossible in the daytime or if the



fig. 1. Antenna installation used by W1JR/CY1 operating from FN76 in the June, 1983 QSO party. The brick building was our shelter. Andy McLellan, VE1ASJ/VE1SPI is at left; Joe Reiser, W1JR is at the right.

Table 1. This table shows some of the more well-known mountain-top locations popularized by VHF/UHF/microwave and millimeter-wavers to set DX and contest records.

Name	Location (approx.)	Elevation (feet)	Grid Square
<i>Eastern USA</i>			
Cadillac Mountain	Bar Harbor, Maine	1,530	FN54
Mount Washington	Glen, New Hampshire	6,288	FN44
Pack Monadnock	Peterborough, New Hampshire	2,280	FN42
Mount Equinox	Manchester, Vermont	3,816	FN33
Mount Mansfield	Burlington, Vermont	4,393	FN34
Mount Greylock	North Adams, Massachusetts	3,491	FN32
High Point	Port Jervis, New York	1,803	FN21
Watchusett Mountain	Princeton, Massachusetts	2,006	FN42
Mount Mitchell	Asheville, North Carolina	6,684	EM85
Mount Toxaway	Oakland, North Carolina	4,777	EM85
Spruce Knob	Simoda, West Virginia	4,860	FM08
<i>Western USA</i>			
Pikes Peak	Colorado Springs, Colorado	14,110	DM78
Mount Rose	Reno, Nevada	10,778	DM09
Mount Diablo	Walnut Creek, California	3,849	CM97
Mount Hamilton	San Jose, California	4,209	CM97
Mount Pinos	Frazier Park, California	8,831	DM04
Mount Palomar	Julian, California	6,126	DM13
Mount Ashland	Ashland, Oregon	7,530	CN70

weather is inclement, so back to the compass! The local transit time of the sun can also be determined for a true south marker. Check maps ahead of time to see what azimuth directions will be used most. At the same time, check the approximate bearings of other local landmarks which can be used for additional sightings.

Probably the most famous VHF/-UHF and microwave locations are the high hills and mountains where prior contesting has taken place or from which DX records have been set. Some of these are shown in **table 1**. Reference 2 discusses some of these locations and includes pointers on how to get to them and what to expect, as well as any particular local considerations. Regardless of the above, do your homework in advance, since it's often difficult to secure on-the-spot operating permission.

On-site rf emitters can be a problem. But they, too, can be checked on a preparatory visit. Elevated locations frequently have broadcast, VHF/UHF TV transmitters, repeaters, or other sources of local noise. Will this rf be a problem with spurious beats or noise? If so, choose another location or bring adequate external preselector filters with you just in case!

Portable contest operation involves

several other considerations. Are you sure that when you arrive at the location, somebody else won't already be there? Always have a plan for a back-up location! Are sleeping accommodations available, or must you provide your own? Is camping permitted? Do you need written or verbal permission to operate a transmitter or a generator at the location?

Can you operate at the chosen location overnight? Though overnight use of facilities is frequently not allowed at national or state parks, it can sometimes be negotiated before you go; try to get written verification before you go. Whatever you do, don't leave the local natives restless. And definitely — as the Boy Scouts say — always leave the area in the same shape or better than it was when you arrived. Remember, either you or some other Amateur may want to return.

establishing records

Record setting is surely one of the big reasons serious VHF/UHF and microwavers seek out portable locations. It's well known that the elevated locations will often add the extra low-angle takeoff so critical for record setting — not to mention the extended line-of-sight propagation on the upper microwave and millimeter-wave bands.

Coastal locations are acceptable, especially if over-water paths are contemplated.

Some operational pitfalls deserve discussion. It's usually advisable to conduct some sort of rf liason, typically on 2 meters or 70 cm. Often, however, I've heard of disasters — especially if the path is long (over 20 miles or line-of-sight). For instance, if 2-meter fm is used for liason, will its signal be strong enough over the path?

Believe it or not, some operations have been unable to establish two-way 2-meter communications between high locations with a 10-watt fm rig operating into a quarter-wave car-mounted vertical antenna. In this case, even a small (three to four element) Yagi would have been sufficient to complete the path.

A Yagi antenna on a liason frequency has a second advantage. If it has high enough gain, it can be used as a crude direction finder so you'll at least know in what general direction other higher frequency antennas should be aimed! Typically, a ten-element or longer Yagi will have less than a 40-degree beamwidth — not as narrow as the typical record setting antenna, but definitely a confidence builder, especially if a visible sighting isn't possible.

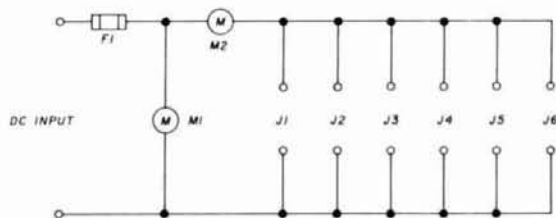

fig. 2. Recommended power distribution and monitoring circuit. M1 is a 0-25 volt dc meter. M2 is a dc ammeter, typically 10-20 amperes. F1 is the fuse, which is set by the current limit of the supply and/or ammeter. J1 through J6 are output terminals, as discussed in text.

choice of frequency and gear

Before you get too far along in your portable operation plans, the frequency and gear must be carefully selected. If single-band operation is chosen, the problems are considerably simplified. Do you have your own gear, or will you have to borrow some or all for the operation? Are you interested in just the more populated bands such as 6 and 2 meters, 70 cm (432 MHz) and 23 cm (1296 MHz)? Or do you want to go higher, or on one of the lower, less populated bands such as 135 cm (220 MHz) or 33 cm (903 MHz)? The more populated bands may yield more QSOs, but the less populated bands can often offer more satisfaction.

There's plenty of self-contained commercial gear available such as the "multimode" rigs that offer easy operation in a single compact package. Units manufactured by ICOM, Kenwood, and Yaesu — the most popular manufacturers — offer VHF/UHF coverage from 50 to 1300 MHz on CW, SSB, and fm. Some of these manufacturers even offer dual or multiband operation in the same package. Most of these rigs will operate on either 115 VAC or 12 to 13 volts dc.

Some operators prefer up/down converters or transverters, which can often be optimized for the ultimate in sensitivity, selectivity, and/or high dynamic range. References 3 through 10 provide typical circuitry for "rolling your own."

Many commercial manufacturers offer this type of gear from 50 MHz to

10.368 GHz! Popular suppliers are ARR, Microwave Modules, Mutek, and SSB Electronics. Remember that if an up/down converter is used, an extra hf transceiver or appropriate i-f will also be required.

power sources

It almost goes without saying that if commercial power is available at the proposed portable location, you're in luck. If not, there are several alternatives. Most low-power (less than about 100 watts) VHF/UHF gear will also operate on 12 to 13 volts dc. For short periods of time (i.e., a few hours), especially at lower power levels (100 watts maximum), the power can be taken from the battery in your automobile.

However, if this is done, extreme care must be taken. It's best to install a separate large diameter (No. 10 AWG minimum) wire connected directly to the battery terminals and kept to the minimum possible length to prevent large voltage drops. I'd also recommend that a circuit breaker or fuse be installed in this line as close as possible to the positive terminal of the battery.

Furthermore, I'd recommend that a power distribution and monitor box be fabricated. A schematic of a recommended type is shown in fig. 2. Note that it also has a fuse for double protection. The voltmeter is used to monitor the voltage regulation and warn of possible loss of battery charge. The ammeter monitors the current drawn by the gear in use. This will also aid in any troubleshooting exercise.

KENNEDY ASSOCIATES

Stocking all major lines. San Antonio's Ham Store. Great Prices—Great Service. Factory authorized sales and service. Hours: M-F 10-6; SAT 9-3

KENWOOD

YAESU



ICOM

Amateur Radio Division
5707A Mobud
San Antonio, TX 78238
Telephone: 512-680-6110



117

Electronic Repair Center Servicing

Amateur Commercial Radio

The most complete repair facility on the East Coast. Large parts inventory and factory authorized warranty service for Kenwood, Icom and Yaesu.

SEND US YOUR PROBLEMS

Servicing "Hams" for 30 years, no rig too old or new for us.

HAMTRONICS, INC.

4033 Brownsville Road
Trevose, Pa. 19047
215-357-1400



IF YOU BUY, SELL
OR COLLECT
OLD RADIOS,
YOU NEED...

Antique Radio's
Largest-Circulation
Monthly Magazine



ANTIQUE RADIO CLASSIFIED

Articles - Classifieds - Ads for Parts & Services.

Also: Early TV, Ham Equip., Books, Telegraph, 40's & 50's Radios & more... Free 20-word ad each month. Don't miss out! Sample - Free. 6-Month Trial - \$10. 1-Year: \$18 (\$24 by 1st Class). Foreign - Write. A.R.C., P.O. Box 2-A2, Carlisle, MA 01741

118

1987 CALLBOOKS

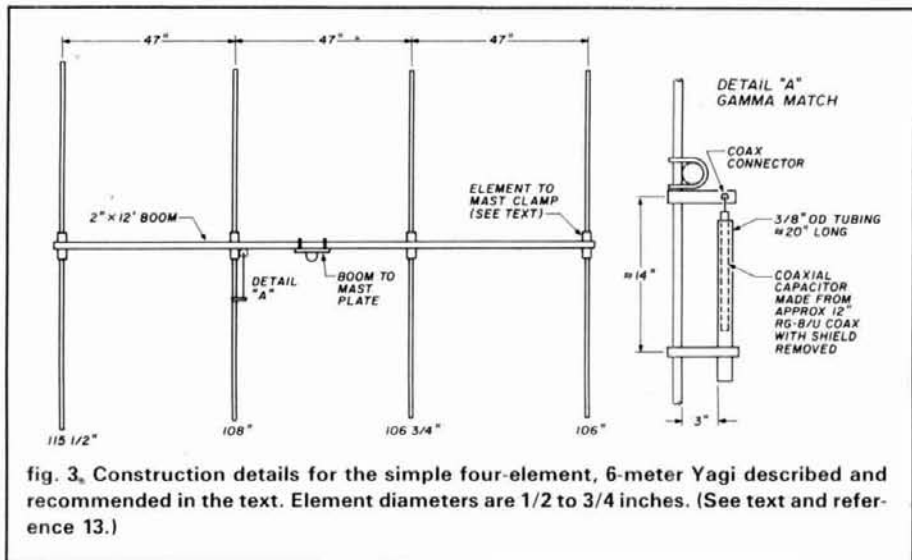

portable antennas

Next to the selection of your location, the most important key to success is your antenna. While you're not likely to be running high power, every bit of antenna gain will be important to attract attention. You'll probably hear all the more powerful home stations. But will they be able to hear you?

There are many factors to consider in choosing a portable antenna. Unless you're going to operate on just one band, a moderate-sized Yagi would almost certainly be your best choice. Although a large antenna would obviously be hard to aim and keep aloft, especially if you're operating alone, your antenna should be as long as conveniently manageable, since the apparent path attenuation increases with frequency unless the physical aperture of the antenna is the same.¹¹

I've seen poor results on 70 cm when a portable station took down a 20-foot boom, 2-meter Yagi and replaced it with a 10-foot boom, 70-cm antenna. Try using the same boom-length antennas on each band. Your performance on the higher bands will be either the same or improved.

Some operators prefer to change antennas each time they change bands; if you do this, you can use a larger antenna on each band. Others may operate two or three bands, but prefer

to mount all antennas on a single mast. In this case, the size of the individual antennas will probably have to be smaller. The choice is really one of convenience versus performance.

Another antenna constraint is transportation. If you have roof racks, you may be able to support a fully assembled 12- to 15-foot boom Yagi. If the antennas are transported inside a car or in a car trunk, they may have to be limited in size or broken down into shorter lengths not exceeding 5 to 8 feet. In the latter case, it may be possible to design the boom so that it can be conveniently broken down into shorter sections.

Try using Yagis that are easily assembled and preferably symmetrical. Most, but not all, Yagi designs use either similar length or a downward director taper. These designs are preferred for portable operation since there's less likelihood of positioning the directors on the boom incorrectly. Mounting and assembly are also simplified.

If beams are broken down for transporting, place electrical tape or its equivalent on the elements or boom before transporting to mark the proper location of elements for reassembly. Steve Murray, K1KEC, taught me another trick: when transporting antennas, always tape down any loose nuts so they won't shake off and get lost.



The "Flying Horse" sets the standards

Continuing a 66 year tradition, there are three new Callbooks for 1987.

The North American Callbook lists the calls, names, and address information for licensed amateurs in all countries from Canada to Panama including Greenland, Bermuda, and the Caribbean islands plus Hawaii and the U.S. possessions.

The International Callbook lists the amateurs in countries outside North America. Coverage includes South America, Europe, Africa, Asia, and the Pacific area.

The 1987 Callbook Supplement is a new idea in Callbook updates; it lists the activity in both the North American and International Callbooks. Published June 1, 1987, this Supplement will include all the new licenses, address changes, and call sign changes for the preceding 6 months.

Publication date for the 1987 Callbooks is December 1, 1986. See your dealer or order now directly from the publisher.

- North American Callbook
incl. shipping within USA \$28.00
incl. shipping to foreign countries 30.00
- International Callbook
incl. shipping within USA \$28.00
incl. shipping to foreign countries 30.00
- Callbook Supplement, published June 1st
incl. shipping within USA \$13.00
incl. shipping to foreign countries 14.00

SPECIAL OFFER

- Both N.A. & International Callbooks
incl. shipping within USA \$53.00
incl. shipping to foreign countries 58.00

Illinois residents please add 6½% tax.
All payments must be in U.S. funds.

RADIO AMATEUR
callbook INC.
Dept. F
925 Sherwood Dr., Box 247
Lake Bluff, IL 60044, USA

Tel: (312) 234-6600



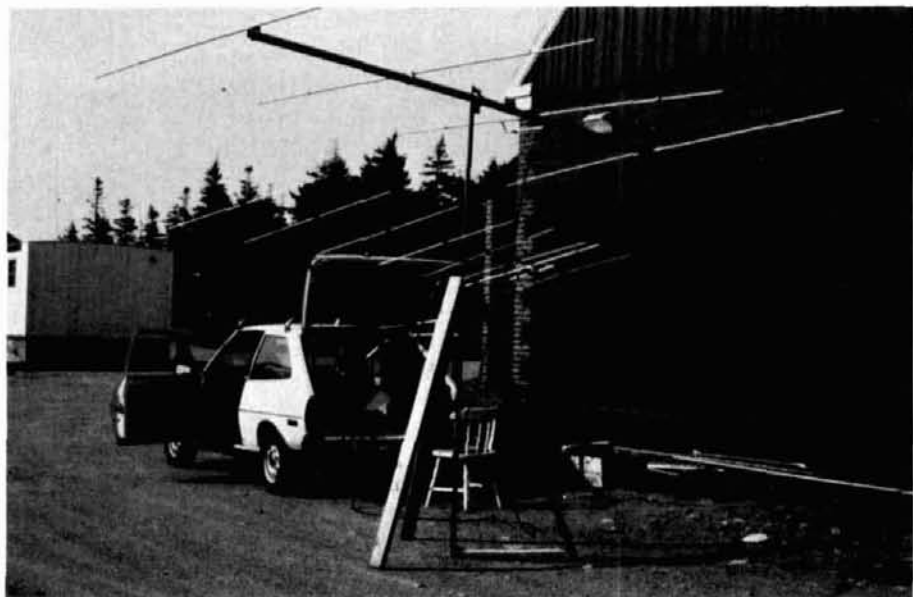

fig. 4. Portable operation by W1JR/1 in FN54 in the June, 1983 ARRL QSO party. Operation is from the car's tailgate. Notice the tripod as detailed in fig. 5. The antenna on the bottom is the eight-element, 2-meter Yagi described in reference 13. The antenna on the top is the four-element, 6-meter Yagi shown in fig. 3.

Finally, just in case you do lose some hardware during transportation, bring along a few spare nuts, bolts, and screws in your tool box. You'll never regret it.

For 6-meter operation I prefer a 12-foot boom Yagi. This is a convenient length for a four-element design. I also prefer a 1-3/4 to 2-inch diameter boom so that the elements won't spin. A single piece of tubing can be used, but you may prefer to use a two-piece boom with a center joining section. "WD4BUM" can provide a suitable boom with 6-foot sections.

My 6-meter antenna follows a symmetrical design with equal element spacing and is based on an unpublished 0.6-wavelength NBS design.¹² It offers gain of just under 10 dBi, and — along with other VHFers in the W1/VE1 area — I've used it extensively to put out rare grid squares. It's also been used to work not only the USA and Canada, but Europe, the Caribbean and South America, all with low power!

The mechanical details for this design are illustrated in fig. 3. The finished product is shown in fig. 4. My antenna was built from an old CB

antenna, but parts from an old 6- or 10-meter beam are sufficient. The construction techniques are similar to those described in last month's column.¹³ The elements can be any diameter between 1/2 and 3/4 inches or tapered (as discussed in reference 13). A gamma match is used because it's small and easy to fabricate. You may have to adjust the length of the driven element, the length of the coaxial capacitor, or the shorting bar slightly for optimum VSWR.

Many small 6-meter or "hilltopper" Yagis are available commercially. For 2 meters, there are also many choices: if you're a homebrew artist like myself, the eight-element Yagi design described in last month's column is highly recommended.¹³ It has a great pattern, about 13.5 dBi of gain, and fits on a 12-foot boom. What could be simpler?

Many NBS Yagi designs are also described in reference 12. The 0.8-, 1.2-, and 2.2-wavelength designs are particularly recommended for 2 meters because they offer manageable lengths and reasonably good gain and radiation patterns. Likewise, there are plenty of commercial 2-meter Yagis available in many different boom-

lengths and prices. Some are even specifically designed for mountain-topping.

Stan Jaffin, WB3BGU, originally became interested in 2-meter antennas suitable for mountain-topping. He therefore devised Yagi analysis programs which later resulted in several articles on optimized 50- through 450-MHz Yagi designs.¹⁴ His articles discuss a number of optimized designs in this frequency range.

Stan offers a few suggestions for 2-meter portable antennas. Yagis measuring 72 inches are suitable for carrying in an automobile, but 50-inch booms are good if you want to transport your antenna in your trunk, where it's out of sight. Stan also prefers wooden booms at least 3/4 inch wide, since wooden boom antennas don't require boom corrections and work fine as long as they're not exposed to the elements for extended periods of time. Stan also feels that the elements should be substantial enough (at least 3/16 inch diameter) so that the elements don't break or bend during transportation or in the wind.

Designs for 135-cm Yagis are available in references 12 and 14. The NBS 4.2-wavelength design is particularly recommended if a 19-foot boom is used. Several commercial 135-cm Yagi designs are also on the market.

Many 70-cm Yagi designs are readily available. The NBS Yagi designs allow choices of up to 4.2-wavelength booms.¹² The DL6WU Yagi designs can be used for boomlengths of 2 or more than 10 wavelengths.¹⁵ On several expeditions I used the 24-foot boom Yagi design described in last December's column.¹⁶ The K2RIW 19-element and the new K1FO 22-element Yagi designs are excellent for 13- to 14-foot boomlengths.¹⁷ Kits of parts for the W1JR, K1FO, and K2RIW designs are now available from Tom Rutland, K3IPW**. Many commercial 70-cm Yagis are also available.

* George Shira, WD4BUM, Route 7, Box 258, Anderson, South Carolina 29624.

** Tom Rutland, K3IPW, 1703 Warren Street, New Cumberland, Pennsylvania 17070.

*** Down East Microwave, W3HQT, Box 1655A, RFD 1, Burnham, Maine 04922.

The loop Yagi, surely one of the most popular antennas on 23 and 33 cm, can be built on a 12-foot boom. Gain is high and the size is quite manageable. Details on loop Yagi design can be found in references 9, 10, and 18. Loop Yagis are available from Down East Microwave.*** Several other sources manufacture Yagis for both bands.

Fewer antennas are available for 13 cm (2304 MHz) and above. The 45-element loop Yagi is a good choice.^{18,19} Down East Microwave*** offers this loop Yagi.

Parabolic dishes are also popular on 13 cm and above. However, if solid dishes are used, they may require a good mount because windload can be severe. Smaller dishes (18 to 24 inches in diameter) are often used on 3 cm (10 GHz) and can often be mounted on a good tripod similar to those used by surveyors. This also will allow some degree of azimuth calibration if a compass rose is available on the tripod mounting. Design of parabolic dishes and feeds for 13 cm and above are discussed in references 20 and 21.

towers and masts

By now it should be obvious that the type and size antenna used in portable operation is determined largely by the way it's supported. Several methods in widespread use include towers, tripods, and masts. Regular towers are great, but they're usually bulky and require guys and possibly special mounting techniques such as attachments to the side of a camper.

Some Amateurs prefer to use just a simple mast mounting. They usually attach some sort of pipe fitting near the end of a large plank and fit a 10- to 15-foot mast into the pipe flange. If the plank is large enough and the flange is near one end, it can be supported by driving over the top of the end with one wheel of an automobile. The support can consist of multiple sections of the 5-foot TV type masts that are readily available at Radio Shack and suppliers of TV antenna accessories.

There's at least one technical

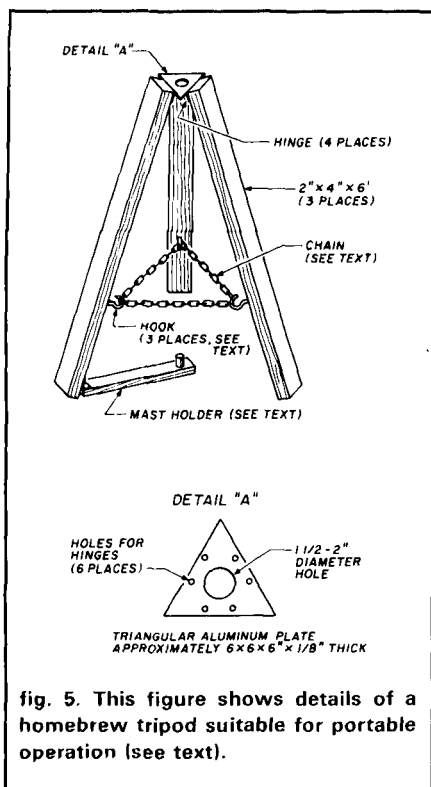

fig. 5. This figure shows details of a homebrew tripod suitable for portable operation (see text).

problem with this mounting method. An antenna mounted near an automobile may suffer pattern distortion. The larger the antenna and the closer to an automobile, the greater the problem. As a rule of thumb, antennas should be spaced at least 25 to 50 percent of their boomlength away from any local objects. This is particularly important for those who use masts or towers attached to a camper. Furthermore, antennas should always be mounted at least 1 to 2 wavelengths above the ground for tropo work or at least 7 to 14 feet high on 2 meters.

I prefer tripods or small self-supporting towers for portable operation. Several manufacturers now supply four-legged free-standing towers. I use the one shown in fig. 4 of last month's column¹³ on my portable EME station. These small towers usually have hooks at the top to allow guy lines to be added if necessary.

Figure 5 shows construction details for a simple tripod that I use for portable operation and back yard antenna testing. It consists of three 6-foot lengths of 2 X 4 lumber joined at the top to a triangular aluminum plate

using small hinges available in hardware stores. A hole large enough to pass a mast through is drilled in the plate. An inexpensive piece of chain link is used to hold the shape and it is attached between the legs with hook eyes.

This tripod (figs. 1 and 4) is relatively compact, and the weight of the lumber makes it very stable even in a mild wind. The antenna mast can be sections of the 5-foot TV type just described, which can rest on the ground. For a more substantial mast holding method, I sometimes use a plank such as the one described above, which can be attached with another hinge to one of the tripod legs (see figs. 1 and 4). For peace of mind, I sometimes attach a rope to the antenna in use to hold it in position, but I'm sure there are better safety methods.

Amateurs who go portable devise many different ways to hold their antennas. Antenna rotators can be used, but will require 115 VAC, as discussed earlier. Others attach a lever arm to the mast to allow quick steering. Whatever method you use, do consider something that will allow a relatively accurate azimuth indication such as a compass rose, since this may mean the difference between success and failure of your operation.

transmission lines and VSWR indicators

One big advantage of portable operation is that transmission lines are usually short. Hence, lower cost coax such as RG 8/U or RG 213/U may be perfectly acceptable. The newer 9913 coax is especially recommended if you want very low loss or expect to work on 70 cm and above.

Because you sometimes don't know how long a feedline will be required at the site, I prefer to take several short cables as well as a few 10- and 25-foot feedlines, all fitted with type-N connectors. If the first feedline is too short just add another section, joining them with a coax barrel adapter.

Another suggestion: if you keep the number of connector types to a minimum, you won't have to bring too

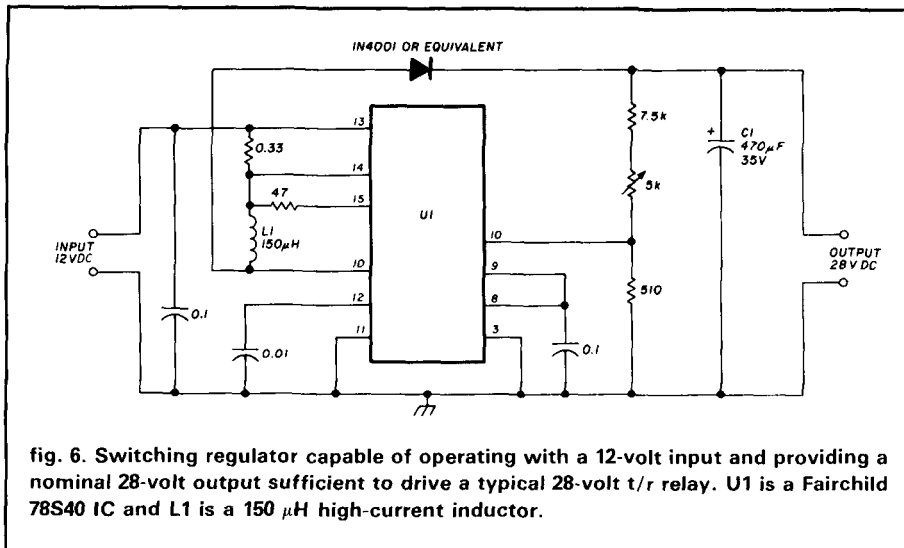

fig. 6. Switching regulator capable of operating with a 12-volt input and providing a nominal 28-volt output sufficient to drive a typical 28-volt t/r relay. U1 is a Fairchild 78S40 IC and L1 is a 150 μ H high-current inductor.

many different types of adapters. I prefer to use either type-N or BNC connectors in portable operation. Furthermore, bring along several short coax cables with the correct type of connectors so you can easily bypass rigs in case of unexpected equipment failure.

One indispensable accessory is a VSWR/power meter. Don't leave home without it! Not only will it tell you that your transmitter is putting out the correct power, but it will give you a quick indication of VSWR that may tell you if the antenna system is functioning properly. This is particularly important on portable operation because the antenna may have been improperly assembled in a hurry to get on the air. If only a VSWR meter is used, try to have it calibrated before leaving home so that you'll at least be able to know that the power indicated is in the ballpark.

antenna relays

Most of the popular multimode transceivers have built-in t/r relays. However, if an external preamplifier or power amplifier is used, an additional t/r relay may be necessary. Since most portable operation requires a 12-volt dc relay, you should obtain one well ahead of time and check it out, especially with respect to integration with the t/r switching. I may be old-fashioned, but I use a footswitch on all

operation because I feel it's more reliable and allows me other freedoms. I have a small box with the switching and voltages all wired beforehand.

If you can't find a 12-VDC t/r relay you can use the 28-volt type, which is more readily available. But how do you use it on 12 volts? The answer is that you need an external 24- to 28-volt supply that's powered from 12 VDC.

Figure 6 shows a schematic of such a supply which will operate on 12 to 13 VDC and deliver a nominal 28 VDC. It uses one of the newer IC chips and will easily provide enough current to drive a single 26-volt t/r relay. This circuit works as a "switching regulator." Such a device is really an oscillator that operates very efficiently in supplying power to the output filter capacitor, C1, on demand. Normally the internal diode between pins 2 and 1 of the IC is used to connect to the output filter/divider. However, I used an external diode to keep chip dissipation to a minimum. One caution: switching regulators generates rf spikes. Therefore, it's best to place the circuit in a shielded box and filter the dc input and output lines.

The circuit shown in fig. 6 is quite straightforward. The only special components are the IC chip (a Fairchild 78S40) and the switching inductor. The inductor should be of the very high current type made with large gauge wire such as the J. W. Miller

type 5506 or equivalent. If you can't locate these parts, Circuit Cellar offers a package deal of the 78S40 and the Miller inductor for \$15.00.****

Recently a new series of switching regulator chips with higher output current capabilities was introduced by Linear Technology Corporation. Several choices such as the LT1070CK, LT1071CK, and LT1072CK, with specified output currents of 5, 2.5 and 1.25 amperes, respectively, are offered.

I built the circuit in fig. 7 using the higher current device, the LT1070CK, which costs \$12.74 in small quantities and the same inductor as used in fig. 6. I haven't completely put this circuit through its paces, but it looks as if it will have considerably more output current capability than the 78S40 circuit. Therefore, if high current isn't required, you may want to use one of the lower-cost chips in this series.

power amplifiers

So far I haven't mentioned power amplifiers. They aren't always needed for portable operation. However, there are many choices if solid-state amplifiers are used. Reference 7 describes circuitry that will work for solid-state power up to the 100-watt level through 70 cm. Many different solid-state amplifiers are available commercially.

If you really want to go high power, tubes are still king. However, you'll probably need to use either local power or bring along a generator so that the filament and high voltages can be generated conveniently.

A couple of years back there were some AM6154 and AM6155 tube-type power amplifiers on the surplus market. They can be adapted to operation on 144, 220, and 432 MHz.²² This amplifier seems like just the ticket for high-power portable operation because it's relatively small, fully self-contained, and can deliver 300 to 500 watts of rf with 10 to 20 watts of drive.

field repairs

Because it can be very frustrating working in the field, especially if a

**** Circuit Cellar, P.O. Box 428, Tolland, Connecticut 06084.

Table 2. Items recommended for a trouble-free portable operation. This list is by no means complete; you may want to expand some categories as you make your own list.

Antennas, transmission lines, and accessories:

- antennas
- tripod/tower
- rotator
- feedlines — short, medium and long
- link antennas
- masts
- rope
- coax cable adapters

Equipment:

- radios
- link gear
- HT
- t/r relay and power source
- straight key and keyer
- spare fuses
- spare preamplifiers
- power amplifiers
- master control system
- preselector filters
- earphones
- power distribution box (fig. 2)

Power generation:

- ac generator (plus spare plugs, gasoline, oil)
- dc to ac inverter
- batteries
- extension cords and ac outlet strips
- power supplies (if required)

Tools and supplies:

- tools (make a long list)
- hookup wire
- hardware
- pipe cleaners
- soldering iron and solder
- electrical tape
- ruler/tape measure
- clip leads

Test equipment:

- multimeter
- noise generator
- power/VSWR meter
- frequency calibration source

Miscellaneous:

- compass
- pens, pencils, scratch paper
- folding table
- operating platform
- beverage cooler stocked with water
- manuals on gear being used
- camera and film
- logbooks
- tent/tarpaulin
- folding chairs
- first-aid kit, aspirin, insect repellent
- beverages and snacks
- lamps/flashlight
- maps

QTH _____ GRID LOCATOR _____

W1JR/ _____

QSO WITH	DATE	BMT	MHz.	RST	2-WAY
SAMPLE					

EX-W1JAA W6FZJ W8TBY W2NQL DXCC HONOR ROLL IOBWA8

XMTR: _____

RCVR: _____

ANT: _____

PSE QSL TNX

JOE REIBERT
 17 MANSFIELD DR.
 CHELMSFORD, MASS. 01824
 U.S.A.

fig. 8. QSL card used by W1JR for portable operations.

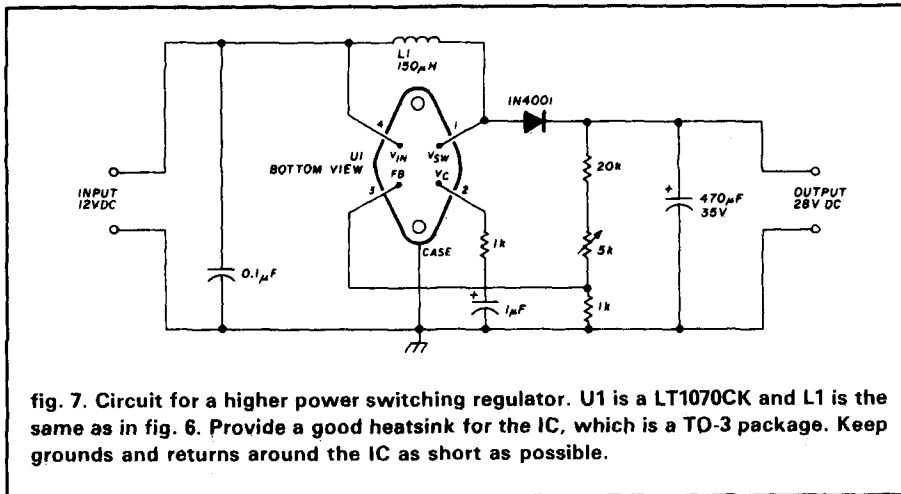

fig. 7. Circuit for a higher power switching regulator. U1 is a LT1070CK and L1 is the same as in fig. 6. Provide a good heatsink for the IC, which is a TO-3 package. Keep grounds and returns around the IC as short as possible.

failure occurs, always bring along extra gear, tools, and supplies. A multimeter is a *must*. Many inexpensive handheld types are available. A crystal calibrator is also nice for checking if you're on frequency.²³ I also carry a simple noise generator made with a diode, battery, and coax attenuator. It isn't accurate, but it can tell you in one quick test if your preamplifier or receiver is inoperative!

It's also a good idea to bring along a soldering iron. On one expedition I needed one to repair a broken relay coil. Luckily I was able to borrow a battery-operated one locally, and it

saved the day! At the same time I needed a light. I had a flashlight, but I was alone and didn't have three hands. I recommend a lamp that operates from a car cigarette lighter. It can also help by providing light for filling out your log.

If you're working on 115 VAC, don't forget to bring extension cords and extra power outlet strips. Extra leads with alligator clips are great for makeshift patching. I also recommend that you carry a package of ordinary pipe cleaners. They're great for removing water or other debris that can get into coax connectors.

amenities

I really haven't discussed creature comforts. If you're going to operate from a car, bring along a board or platform on which to mount your rig, key, and logbook. If your car has a tailgate you can set the gear on it, but don't forget to bring a folding chair. Of course, campers or vans can be ideal for portable operation since they usually have a built-in table and seat.

If you're not fortunate enough to obtain the use of a local building, bring along a tent or tarpaulin to not only help in inclement weather, but shield you and your gear from the high temperatures of direct sunlight.

Table 2 lists these and other items necessary (or advisable) for a successful portable operation. This list may not be complete. Suggestions and information on mountain-topping from another perspective is also available in reference 24.

If you decide on portable operation, first generate your own list and check off each item before you go out into the field. Even better yet, set your entire station up in your back yard or driveway and try it out. When all is working to your satisfaction, review your checklist and pack everything in sight into your car!

the final courtesy

Once you've completed operation from that special location, go home, unpack, and wait for the mailman to arrive with all the QSL requests! Yes, that's what it's all about. Just think of all those VHF/UHFers who struggled to work you for a new state, grid, or DX record!

It's really not hard to confirm a QSO, but many portable operations want to send out special QSLs or some great memento. This could take many months and cost plenty, especially if photographic QSL cards are desired. Special QSLs are fine, but the ham waiting for the card couldn't care less. (Don't forget all the phone calls and duplicate letters asking whether you received the QSLs and why you haven't QSLed yet.)

One quick way to QSL is to just mark up one of your own regular station cards or fill out one of those often offered as an advertising gimmick. But why not make up a universal QSL card instead — especially if you contemplate multiple operations or multiple QTHs?

With the help of Steve Gilbert, WA1AYS, who has his own printing business, I've done just that. It's simple and effective, and it does the trick with a minimum of work and expense. The final result is shown in **fig. 8**. All you have to do is to fill in the QTH and grid square along with the usual information. Think about it the next time you're planning a trip; it certainly simplifies QSLing.

summary

Portable operation on the VHF/UHF, microwave, and millimeter-wave bands is becoming quite a popular sport. I've tried to provide suggestions on how to improve your success rate; obviously, the most successful operations are those that were planned, tested, and integrated at home instead of on location.

acknowledgments

I'd particularly like to thank those who suggested a column on this subject, and especially Stan Jaffin, WB3BGU, for his helpful suggestions about antennas.

Important VHF/UHF Events

June 7	<i>Predicted peak of the daytime Arietids meteor shower at 1900 UTC.</i>
June 10	<i>Predicted peak of the Zeta Perseids meteor shower at 0400 UTC.</i>
June 13	<i>EME perigee.</i>
June 13-15	<i>ARRL June VHF QSO party.</i>
June 20-21	<i>SMIRK Party Contest (contact KA0NNO).</i>
June 21	<i>Peak of sporadic-E propagation (± 1 month).</i>
July 1	<i>Look for European 6-meter opening (± 1 month).</i>
July 11	<i>EME perigee.</i>
July 18-19	<i>CQ Magazine VHF WPX Contest.</i>
July 20	<i>Look for 2-meter sporadic-E propagation (± 2 weeks).</i>

- July 23-26 *Central States VHF Conference, Arlington, Texas (contact KD5RO).*
- July 29 *Predicted peak of the Delta Aquarids meteor shower at 1500 UTC.*

references

1. RF CAD Package — Version 3.51, Computer-aided design package for radio frequency and microwave circuits and antennas (IBM PC compatibles), developed by Joe Reisert, W1JR, and Gary Field, WA1GRC. Available from Ham Radio's Bookstore, Greenville, New Hampshire 03048 for \$39.95 plus \$3.50 shipping and handling.
2. Wayne Overbeck, N6NB, "VHF Mountain-topping in America: A Travel Guide," *QST*, July, 1980, page 46.
3. Joe Reisert, W1JR, "VHF/UHF World: VHF/UHF Receivers," *ham radio*, March, 1984, page 46.
4. Joe Reisert, W1JR, "VHF/UHF World: VHF/UHF Exciters," *ham radio*, April, 1984, page 84.
5. Joe Reisert, W1JR, "VHF/UHF World: High Dynamic Range Receivers," *ham radio*, November, 1984, page 96.
6. Joe Reisert, W1JR, "VHF/UHF World: Low-Noise GaAsFET Technology," *ham radio*, December, 1984, page 99.
7. Joe Reisert, W1JR, "VHF/UHF World: Medium-power Amplifiers," *ham radio*, August, 1985, page 39.
8. Joe Reisert, W1JR, "VHF/UHF World: High Dynamic Range on 2 Meters," *ham radio*, November, 1985, page 54.
9. Joe Reisert, W1JR, "VHF/UHF World: 33 cm — Our Newest Band," *ham radio*, April, 1986, page 83.
10. Joe Reisert, W1JR, "VHF/UHF World: 33 cm Update," *ham radio*, April, 1987, page 74.
11. Joe Reisert, W1JR, "VHF/UHF World: Microwave and Millimeter-Wave Propagation — Part 1," *ham radio*, July, 1986, page 82.
12. Joseph H. Reisert, Jr., W1JR, "How to Design Yagi Antennas," *ham radio*, August, 1977, page 22.
13. Joe Reisert, W1JR, "VHF/UHF World: Optimized 2- and 6-Meter Yagis," *ham radio*, May, 1987, page 92.
14. Stanley Jaffin, WB3BGU, "Applied Yagi Antenna Design, Parts 1-6," *ham radio*, May through October, 1984.
15. Günter Hoch, DL6WU, "Extremely Long Yagi Designs," *VHF Communications*, Fall 1982 issue, page 130.
16. Joe Reisert, W1JR, "VHF/UHF World: A High-gain 70-cm Yagi," *ham radio*, December, 1986, page 75.
17. Steve Powlishen, K1FO, "The K1FO 22-Element, 432-MHz Yagi," *VHF/UHF and Above*, January, 1987, page 2.
18. Joe Reisert, W1JR, "VHF/UHF World: Designing Loop Yagis," *ham radio*, September, 1985, page 56.
19. Joe Reisert, W1JR, "Designing Loop Yagis for 13 And 23 cm," *Proceedings of the First 1296/2304 Conference*, Estes Park, Colorado, September, 1985.
20. Joe Reisert, W1JR, "VHF/UHF World: Reflector Antennas — Part 1," *ham radio*, February, 1986, page 51.
21. Joe Reisert, W1JR, "VHF/UHF World: Reflector Antennas — Part 2," *ham radio*, March, 1986, page 68.
22. Joe Reisert, W1JR, "VHF/UHF World: High Power Amplifiers — Part 2," *ham radio*, February, 1985, page 38.
23. Joe Reisert, W1JR, "VHF/UHF World: VHF/UHF Frequency Calibrator," *ham radio*, October, 1984, page 55.
24. John Lindholm, W1XX, "VHF Mountain-topping for the '80s," *QST*, March, 1986, page 49.

ham radio

HAMTRONICS, INC.

YOUR ONE STOP ELECTRONICS SHOPPING CENTER

NOVICES!

Call TODAY (215) 357-1400

*for all your new gear needs. Transceivers, handhelds, digital gear — **everything** you need to take advantage of your new, expanded voice and digital privileges!*

KENWOOD
TM3530A



AEA
Ameco
Astron

B & W
Bencher
Cushcraft

 **ICOM**
IC03AT IC27A



ECG
Hy-Gain
MFJ

Rohn
Sylvania

YAESU
FT109



If you stop in, we would like to shake your hand, congratulate you and give you a free gift for your shack...No, you don't have to buy anything.

ACCESSORIES PLUS MUCH MORE

Technicians, Generals, Advanced and Extra Class Operators Too!

HAMTRONICS HAS IT ALL

Call today
for Your
SPECIAL PRICES



HAMTRONICS, INC.

A DIVISION OF TREVOSE ELECTRONICS
4033 BROWNSVILLE RD., TREVOSE, PA 19047
(215) 357-1400

test DBMs for diode leakage

Decreased performance indicates damaged diodes

Commercially manufactured diode double-balanced mixers (DBMs) are popular with experimenters and equipment designers because of their low cost, predictable performance, and versatility. They're used as mixers, all kinds of modulators, and current-controlled attenuators.

But mixers can suffer from failure that degrades performance without catastrophic destruction. This damage, caused by transient inputs exceeding ratings, may go unnoticed unless mixer performance characteristics are specifically tested.

It's important to be aware of this effect when using an old mixer in a new design, or when performance seems to decrease. This article provides a method for making quick functional checks of mixer performance that can prevent a lot of frustrating troubleshooting.

mixer abuse

The obvious solution to the problem raised in the previous paragraph is to not exceed the manufacturer's specifications. However, we're all experimenters and tinkerers — and we just might install a mixer in a new configuration, inadvertently causing problems that aren't immediately apparent. We might use the same damaged mixer in a number of different projects, with disappointing, seemingly inexplicable results. And we *are* known for trying to squeeze maximum performance from a component by exceeding its ratings.

Mixers can be used in several different applications. A DBM makes a very simple and trouble-free balanced modulator for generating a DSB signal. The DBM doesn't require external adjustment of balance controls, and since these controls aren't used, it doesn't require subsequent readjustment to compensate for drift. The DBM balanced modulator is connected as shown in **fig. 1**. I used this scheme to generate a DSB signal using an LM386 IC audio amplifier driving the DBM i-f port. This worked perfectly, and its simplicity made it seem ideal. However, carrier suppression deteriorated after a period of use, and was cured by replacing the DBM. I was confused; a quick ohmmeter check on the mixer diodes indicated that they were still intact. The DBM had to be soldered into the circuit to determine that its balance had changed.

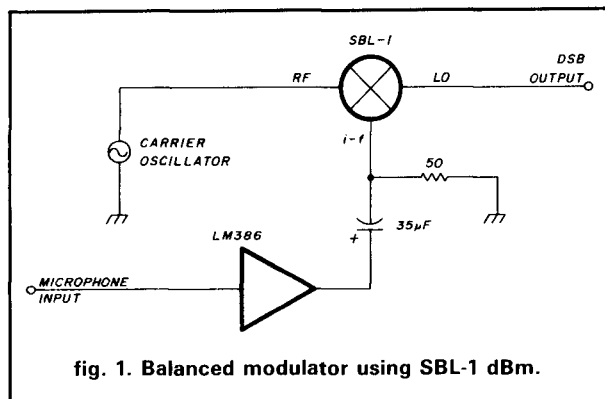

fig. 1. Balanced modulator using SBL-1 dBm.

But how was the DBM damaged? **Figure 2** shows the schematic of a Mini-Circuits SBL-1 mixer with the equivalent circuit for dc representation of the diodes. There is direct access to the diodes through the i-f port, making them most vulnerable to damage when the i-f is used as an input, which often occurs where a low frequency rf input is required but only a high frequency DBM is available. The LM386 power amplifier could easily generate transients that exceeded the DBM's 40 mA maximum i-f current rating. These glitches only happened when making connections or touching the amplifier input leads. Normal microphone input resulted in normal modulation.

testing

Checking the damaged mixers with an ohmmeter didn't seem to reveal much difference between a bad and a good mixer. Continuity checks are done to test for typical semiconductor failures — opens and shorts. The resistance measurements shown in **table 1** were carefully made to document results. I used a Micronta 22-204A meter; other meters will provide different but similar results. Study of the actual resistance measurements reveals that mixer damage tends to progressively deteriorate the diode reverse leakage and cause imbalance. A good mixer has higher (and equal) reverse resistances than a damaged mixer. Continuing to operate with additional mixer damage causes the reverse resistance to decrease. When it reaches 20 or 15 ohms per diode, the DBM will pass virtually no signal.

I knew that I was in big trouble because I had a collection of used DBMs that might or might not have been damaged. The familiar balanced modulator

Cliff Klinert, WB6BIH, 1126 Division Street,
National City, California 92050

**PERFORMANCE
AND VALUE
WITHOUT COMPROMISE**

KRP-5000 REPEATER

2 meters — 220 — 440

**Word is spreading fast—
"Nothing matches the KRP-5000
for total performance and value. Not GE, not even Motorola."**

RF performance really counts in tough repeater environments, so the KRP-5000 receiver gives you 7 helical resonators, 12-poles of IF filtering, and a precise Schmitt trigger squelch with automatic threshold switching. The transmitter gives you clean TMOS FET power.

Enjoy high performance operation with: remote programmability, sequential tone paging, autopatch, reverse autopatch, 200-number autodial, remote squelch setting, status inputs, control outputs, and field-programmable Morse messages.

Call or write for the full performance story . . . and the super value price!

Micro Control Specialties
23 Elm Park, Groveland, MA 01834
(617) 372-3442

TELEX: 4932256 Kendecom
FAX: 6173737304

**The first choice in
Transmitters - Receivers
Repeaters
Repeater Controllers
Power Amplifiers
Voice Mail Systems**



KRP-5000 Repeater shown
with PA-100 Amplifier

The XP-706-US Multiband Antenna

**In the final
analysis quality is
less expensive**

The unique design of the XP-706-US antenna system gives you MONOBAND PERFORMANCE in a Multiband beam. The antenna *USES NO TRAPS* of loading coils that rob power and limit bandwidth. Sommer Antennas use the FULL surface area of the elements on ALL bands.

Our commitment to use only the finest materials insures that your investment will last for years. Our system uses a Double rectangular boom, CAST aluminum element mounting brackets, all stainless hardware and a high power balun.

Monoband performance on a Multiband beam is yours when you move up to Sommer, the last beam you'll have to buy. We believe Sommer is your best antenna value when compared to the construction and performance of other multi and monoband antenna systems.

H.J. Theller Corp.
P.O. Box 5369
Spartanburg, SC 29304
(803) 576-5566

SOMMER

NUTS & VOLTS MAGAZINE

P.O. Box 1111-H
PLACENTIA, CA 92670
714-632-7721



Ham Radio
Computer Hardware
Computer Software
Plans-Kits
Schematics
Test Equipment
CB Gear
Satellite TV
Video
Components
Antique Electronics
Cable TV
Publications
Repairs-Services
New Products
Events Calendar

IF YOU ARE INTO ELECTRONICS AND SAVING MONEY IS IMPORTANT TO YOU, THEN YOU OWE IT TO YOURSELF TO TRY NUTS & VOLTS MAGAZINE. DISCOVER WHY THOUSANDS OF SMART PEOPLE NATIONWIDE TURN TO NUTS & VOLTS EACH MONTH TO MEET THEIR ELECTRONIC NEEDS. WHETHER YOU'RE BUYING, SELLING, OR JUST TRYING TO LOCATE THOSE UNIQUE OR HARD-TO-FIND ITEMS, FIND OUT HOW NUTS & VOLTS CAN HELP!

SUBSCRIBE TODAY!

CHECK MONEY ORDER VISA MC

Name _____

Address _____

City _____

State _____ Zip _____

Card No. _____ Exp. Date _____

CALL FOR ADVERTISING INFORMATION
DISTRIBUTOR INQUIRIES INVITED

Subscription Rates

U.S. FUNDS REQUIRED

3rd Class Mail - USA

One Year \$10.00
Two Years \$18.00
Lifetime \$50.00

1st Class Mail

One Year - USA . . . \$18.00
Canada & Mexico . . \$20.00

Air Mail

Foreign - 1 Year . . . \$50.00

Includes one FREE 40-word
Classified Ad

A National Publication For The Buying And Selling Of Electronic Equipment

Table 1. Mixer test data.

Resistance on Pins:	Bad Mixer 1		Bad Mixer 2		Good Mixer	
	Forward	Reverse Ω	Forward	Reverse Ω	Forward	Reverse Ω
3-5	7.0	35	8.0	42	7.5	45
5-4	7.0	30	7.5	34	7.5	45
4-6	7.5	35	8.0	45	7.5	45
6-3	7.5	35	8.0	33	7.5	45
Isolation R-L at 10 MHz		15 dB		20 dB		Unmeasurable ($>>30$ dB)
Loss 10 mA i-f current		10 dB		7 dB		3 dB

Note: Check ohmmeter current before making resistance measurements. To prevent damage, current into a diode shouldn't exceed about 40 mA.

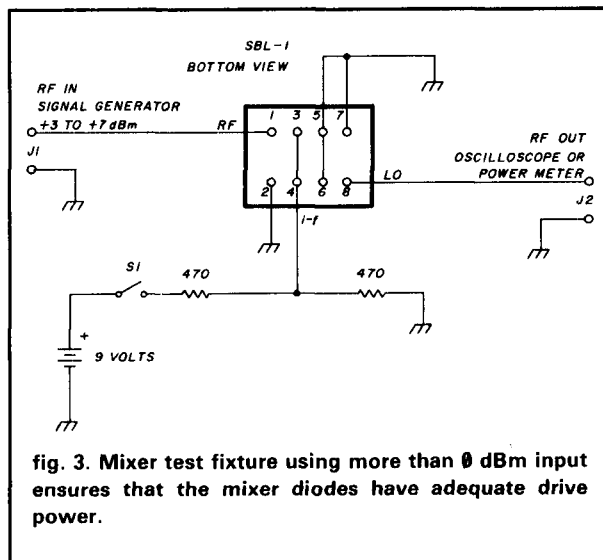
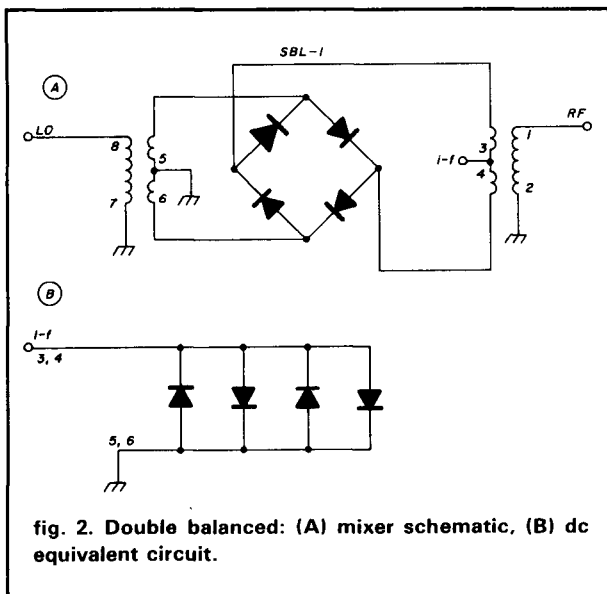

seemed like a good basis for a test fixture, so I settled on the circuit shown in **fig. 3**. Constructed on a perforated board, this circuit was used to prepare the rf measurements listed in **table 1**.

Mixer sockets aren't available, so I made one by cutting up some IC sockets. This approach wasn't entirely successful because the pin sizes don't match. Crystal sockets have the same problem, so it may not be practical to build a permanent test jig. Applying 10 to 20 mA of current to a DBM i-f port will reduce rf-LO isolation to 3 dB or less. The resistors shown in **fig. 3** terminate the i-f port with about 50 (specifically, 47) ohms, and the 9-volt battery supplies about 10 mA of i-f current. Press S1 to make the **table 1** loss measurements. J1 and J2 can be reversed with similar results. This mixer output should be terminated with a 50-ohm load for precise results, but even a high input impedance oscilloscope is adequate to differenti-

ate between good and bad mixers. A receiver with a calibrated variable attenuator could perhaps be used to measure a good mixer's typical 50-dB isolation accurately.

summary

I was amazed to find a semiconductor failure mode resulting in gradual damage rather than complete instant destruction. It's necessary to make a careful check of mixer diode resistances, or a quick rf test to identify this problem. Precise measurements could be made, but aren't necessary for functional testing.

bibliography

RF/IF Signal Processing Handbook, Volume 1, Section 2, Mini-Circuits Labs, P.O. Box 166, Brooklyn, New York 11235.

ham radio



the HAM STATION

P.O. Box 4405
220 N. Fulton Ave.
Evansville, IN 47710

Store Hours
MON-FRI: 9AM - 6PM
SAT: 9AM - 3PM
CENTRAL TIME

SEND SASE FOR NEW & USED SHEETS
WARRANTY SERVICE CENTER FOR:
ICOM, YAESU, TEN-TEC

TERMS:

Prices Do Not Include Shipping.
Price and Availability Subject to
Change Without Notice
Most Orders Shipped The Same Day





- FT-767**
- HF/VHF/UHF Base Station
 - Plug-in Modules for 6m, 2m, 440 MHz
 - Loaded with Features
- \$ SPECIAL PRICE \$**



- IC-μ2AT**
- Pocket-Sized 2 Meter HT
 - TX-140-150 MHz, RC 139-174 MHz
 - 10 Memories and a LCD Readout
- \$ SPECIAL PRICE \$**



- IC-761**
- The Biggest & Best From ICOM**
- All HF Bands plus General Coverage Receiver from 100 kHz-30 MHz
 - Built in Power Supply
 - Built in Automatic Antenna Tuner
 - Built in Electronic Keyer
 - Plus LOTS More!

AVANTI	ASTRON	CUSHCRAFT	HY-GAIN
151.3G 2m On-Glass antenna \$33.00	VS-35M \$58.00 RS-50A 64.00 RS-50M 83.00 VS-50M 99.00	161.00 10-3CD 10m Beam 189.00 10-4CD 10m Beam 219.00 215WB 2m Beam 227.00 ARX2B 2m Vertical A449-6 440MHz Beam	287 2m Mag Mount, % CD-45 Rotor \$105.00 Ham IV Rotor 119.00 T2X Rotor 75.00 Explorer 14 HF Beam 39.95 TH7DX HF Beam 37.00 V2S 2m Vertical 56.00 V3S 220 Vertical 56.00 V4S 440 Vertical 67.00
ASTRON	BUTTERNUT	HY-GAIN	PALOMAR
RS-10A \$58.00 RS-12A 64.00 RS-20A 83.00 RS-20M 99.00 RS-35A 126.00 RS-35M 142.00	HF6V HF Vertical \$119.00 HF4B HF Beam 184.00 220 CV5 220MHz Vertical 49.00 2MCV5 2m Vertical 56.00	214 BS 2m Beam \$59.00 23BS 2m Beam 35.00 25BS 2m Beam 39.00 28 BS 2m Beam 53.00	PT-340 Tuner-Tuner \$89.95 P-410X AC Preamp 135.00 P-412X DC Preamp 135.00 RX-100 Noise Bridge 56.95

DISCOUNTS ON RIGS AND ACCESSORIES FROM: AEA, ARRL, ALINCO, ALLIANCE, ALPHA-DELTA, AMECO, AMERITRON, AMP SUPPLY, ANTENNA SPECIALISTS, ASTRON, BENCHER, BUTTERNUT, B & W, CSI, CALLBOOK, CUSHCRAFT, DAIWA, DIAMOND, ENCOMM, HAL, HEIL, HUSTLER, ICOM, KDK, KANTRONICS, KENPRO, LARSEN, MFJ, MICROLOG, MIRAGE/KLM, NYE, PALOMAR, RF CONCEPTS, ROHN, SANTEC, SHURE, TE SYSTEMS, TELEX/HYGAIN, TEN-TEC, TOKYO HY-POWER, VIBROPLEX, W2AU BALUNS, WELZ, YAESU

For Orders and Price Checks Call 800-523-7731 Indiana and Information
Call 1-812-422-0231



HERE'S A NEAT GIFT IDEA

When we first saw the Casio PQ-40U Portable World Time Clock, we knew instantly that Ham Radio Bookstore customers would love this one. This time piece is more than a simple clock. Besides all the standard features, alarm, snooze, lightweight portable design and digital readout, this clock gives you time at 21 different locations around the world at the twist of a dial. DX'ers will delight at being able to get rid of their cumbersome manual time calculators: determining band and path to use will be greatly simplified. Contesters can simultaneously display both local and UTC times for logging purposes. In fact, every Amateur will find at least a dozen uses for this nifty clock. You can take it with you when you go on vacation—business trips—set the alarm and get out of meetings early—anywhere you need a clock, the PQ-40U can go with you. Get a couple of them and give them as gifts, one for the house, car, office, just about anywhere you need a clock, the PQ-40U can go with you. Quantities are limited—order now and avoid disappointment.

PQ-40U \$29.95

Please enclose \$3.50 shipping and handling

ham radio magazine **BOOKSTORE**
GREENVILLE, NH 03048 603-878-1441

W6SAI BOOKS

published by Bill Orr, W6SAI and Stu Cowan, W2LX

BEAM ANTENNA HANDBOOK

Completely revised and updated with the latest computer generated information on BEAM Antenna design. Covers HF and VHF Yagi's and 10, 18 and 24 MHz WARC bands. Everything you need to know. 204 illustrations. 268 pages. ©1985. Revised 1st edition.

RP-BA Softbound \$9.95

SIMPLE LOW-COST WIRE ANTENNAS

Primer on how-to-build simple low cost wire antennas. Includes invisible designs for apartment dwellers. Full of diagrams and schematics. 192 pages. ©1972 2nd edition

RP-WA Softbound \$9.95

ALL ABOUT CUBICAL QUAD ANTENNAS

Simple to build, lightweight, and high performance make the Quad at DX'ers delight. Everything from the single element to a multi-element monster. A wealth of information on construction, feeding, tuning and installing the quad antenna. 112 pages. ©1982. 3rd edition.

RP-CQ Softbound \$7.95

THE RADIO AMATEUR ANTENNA HANDBOOK

A wealth of projects that covers verticals, long wires, beams as well as plenty of other interesting designs. It includes an honest judgement of gain figures, how to site your antenna for the best performance, a look at the Yagi-Quad controversy, baluns, slopers, and delta loops. Practical antenna projects that work! 190 pages. ©1978. 1st edition.

RP-AH Softbound \$9.95

Please enclose \$3.50 for shipping and handling.



ham radio magazine **BOOKSTORE**
GREENVILLE, NH 03048 (603) 878-1441



Ham Radio's guide to help you find your local

California

JUN'S ELECTRONICS
3919 SEPULVEDA BLVD.
CULVER CITY, CA 90230
213-390-8003
800-882-1343 Trades
Habla Espanol

Colorado

COLORADO COMM CENTER
525 EAST 70th AVE.
SUITE ONE WEST
DENVER, CO 80229
(303) 288-7373
(800) 227-7373
Stocking all major lines
Kenwood Yaesu, Encomm, ICOM

Connecticut

HATRY ELECTRONICS
500 LEDYARD ST. (SOUTH)
HARTFORD, CT 06114
203-527-1881
Call today. Friendly one-stop shopping
at prices you can afford.

Delaware

**AMATEUR & ADVANCED COMMUNI-
CATIONS**
3208 CONCORD PIKE
WILMINGTON, DE 19803
(302) 478-2757
Delaware's Friendliest Ham Store.

DELAWARE AMATEUR SUPPLY
71 MEADOW ROAD
NEW CASTLE, DE 19720
302-328-7728
800-441-7008
Icom, Ten-Tec, Microlog, Yaesu,
Kenwood, Santec, KDK, and more.
One mile off I-95, no sales tax.

Florida

AMATEUR ELECTRONIC SUPPLY
1898 DREW STREET
CLEARWATER, FL 33575
813-461-4267
Clearwater Branch
West Coast's only full service
Amateur Radio Store.
Hours M-F 9-5:30, Sat. 9-3

AMATEUR ELECTRONIC SUPPLY
621 COMMONWEALTH AVE.
ORLANDO, FL 32803
305-894-3238
Fla. Wats: 1 (800) 432-9424
Outside Fla: 1 (800) 327-1917
Hours M-F 9-5:30, Sat. 9-3

Georgia

DOC'S COMMUNICATIONS
702 CHICKAMAUGA AVENUE
ROSSVILLE, GA 30741
(404) 866-2302 / 861-5610
ICOM, Yaesu, Kenwood, Bird...
9AM-5:30PM
We service what we sell.

Hawaii

HONOLULU ELECTRONICS
819 KEEAUMOKU STREET
HONOLULU, HI 96814
(808) 949-5564
Kenwood, ICOM, Yaesu, Hy-Gain,
Cushcraft, AEA, KLM, Tri-Ex Towers,
Fluke, Belden, Astron, etc.

Idaho

ROSS DISTRIBUTING COMPANY
78 SOUTH STATE STREET
PRESTON, ID 83263
(208) 852-0830
M 9-2; T-F 9-6; S 9-2
Stock All Major Brands
Over 7000 Ham Related Items on
Hand

Illinois

ERICKSON COMMUNICATIONS, INC.
5456 N. MILWAUKEE AVE.
CHICAGO, IL 60630
312-631-5181
Hours: 9:30-5:30 Mon, Tu, Wed & Fri;
9:30-8:00 Thurs; 9:00-3:00 Sat.

Indiana

THE HAM STATION
220 N. FULTON AVE.
EVANSVILLE, IN 47710
812-422-0231
Discount prices on Ten-Tec, Cubic,
Hy-Gain, MFJ, Azden, Kantronics,
Santec and others.
SASE for New & Used Equipment List.

Maryland

MARYLAND RADIO CENTER
8576 LAURELDALE DRIVE
LAUREL, MD 20707
301-725-1212
Kenwood, Ten-Tec, Alinco, Azden. Full
service dealer.
M-F 10-7 SAT 9-5

Massachusetts

TEL-COM, INC.
675 GREAT ROAD, RTE. 119
LITTLETON, MA 01460
617-486-3400
617-486-3040
The Ham Store of New England
You Can Rely On.

Michigan

ATLANTIC SOLAR POWER/ENCON
(SINCE 1979)
37279 W. SIX MILE RD.
LIVONIA, MI 48152
(313) 591-7745
Solar Electric Power for Repeaters,
Ham Shacks, Packet Radio.
Call Paul, WD8AHO

Minnesota

TNT RADIO SALES
4124 WEST BROADWAY
ROBBINSDALE, MN 55422 (MPLS/ST.
PAUL)
TOLL FREE: (800) 328-0250
In Minn: (612) 535-5050
M-F 9 AM-6 PM
Sat 9 AM-5 PM
Ameritron, Bencher, Butternut, ICOM,
Kenwood

Missouri

MISSOURI RADIO CENTER
102 NW BUSINESS PARK LANE
KANSAS CITY, MO 64150
(800) 821-7323
Missouri: (816) 741-8118
ICOM, Kenwood, Yaesu
Same day service, low prices.

Nevada

AMATEUR ELECTRONIC SUPPLY
1072 N. RANCHO DRIVE
LAS VEGAS, NV 89106
702-647-3114
Dale Porray "Squeak," AD7K
Outside Nev: 1 (800) 634-6227
Hours M-F 9-5:30, Sat. 9-3

Dealers: *YOU SHOULD BE HERE TOO!*
Contact Ham Radio now for complete details.

Amateur Radio Dealer

New Hampshire

RIVENDALL ELECTRONICS
8 LONDONDERRY ROAD
DERRY, N. H. 03038
603-434-5371
Hours M-S 10-5; THURS 10-7
Closed Sun/Holidays

New Jersey

ABARIS SYSTEMS
276 ORIENTAL PLACE
LYNDHURST, NJ 07071
201-939-0015
Don WB2GPU
Astatic, Azden, B&W, Butternut, Larsen,
Mirage/KLM, Kenpro, Nye, Santec,
THL, and many others.
M-F 10 am-9 pm
SAT 9 am-7 pm
VISA/MC

KJI ELECTRONICS
66 SKYTOP ROAD
CEDAR GROVE, NJ 07009
(201) 239-4389
Gene K2KJL
Maryann K2RVH
Distributor of: KLM, Mirage, ICOM, Lar-
sen, Lunar, Astron. Wholesale - retail.

QEP's
110-4 ROUTE 10
EAST HANOVER, N. J. 07936
201-887-6424
In N.J. 1-800-USA-9913
Bill KA2QEP
Jim N2GKW
VISA/Mastercard
Belden Coaxial Cable
Amphenol Connectors
Hours: 9:30 am-7:00 pm

New York

BARRY ELECTRONICS
512 BROADWAY
NEW YORK, NY 10012
212-925-7000
New York City's Largest Full Service
Ham and Commercial Radio Store.

VHF COMMUNICATIONS
915 NORTH MAIN STREET
JAMESTOWN, NY 14701
716-664-6345
Call after 7 PM and save! Supplying all
of your Amateur needs. Featuring ICOM
"The World System." Western New
York's finest Amateur dealer.

North Carolina

F & M ELECTRONICS
3520 Rockingham Road
Greensboro, NC 27407
1-919-299-3437
9AM to 7PM Closed Monday
ICOM our specialty — Sales & Service

Ohio

AMATEUR ELECTRONIC SUPPLY
28940 EUCLID AVE.
WICKLIFFE, OH 44092 (Cleveland Area)
216-585-7388
Ohio Wats: 1 (800) 362-0290
Outside Ohio: 1 (800) 321-3594
Hours M-F 9-5:30, Sat. 9-3

DEBCO ELECTRONICS, INC.
3931 EDWARDS RD.
CINCINNATI, OHIO 45209
(513) 531-4499
Mon-Sat 10AM-9PM
Sun 12-6PM
We buy and sell all types of electronic
parts.

UNIVERSAL AMATEUR RADIO, INC.
1280 AIDA DRIVE
REYNOLDSBURG (COLUMBUS), OH
43068
614-866-4267
Featuring Kenwood, Yaesu, Icom,
and other fine gear. Factory author-
ized sales and service. Shortwave
specialists. Near I-270 and airport.

Pennsylvania

**HAMTRONICS,
DIV. OF TREVOSE ELECTRONICS**
4033 BROWNSVILLE ROAD
TREVOSE, PA 19047
215-357-1400
Same Location for over 30 Years

LaRUE ELECTRONICS
1112 GRANDVIEW STREET
SCRANTON, PENNSYLVANIA 18509
717-343-2124
ICOM, Bird, Cushcraft, Beckman,
Larsen, Amphenol, Astron, Belden,
Antenna Specialists, W2AU/W2VS,
Tokyo Hy-Power Labs, WELZ, Daiwa,
Sony, Saxton, Vibroplex, Weller.

Tennessee

MEMPHIS AMATEUR ELECTRONICS
1465 WELLS STATION ROAD
MEMPHIS, TN 38108
Call Toll Free: 1-800-238-6168
M-F 9-5; Sat 9-12
Kenwood, ICOM, Ten-Tec, Cushcraft,
Hy-Gain, Hustler, Larsen, AEA,
Mirage, Ameritron, etc.

Texas

MADISON ELECTRONICS SUPPLY
3621 FANNIN
HOUSTON, TX 77004
713-520-7300
Christmas?? Now??

KENNEDY ASSOCIATES
AMATEUR RADIO DIVISION
5707A MOBUD
SAN ANTONIO, TX 78238
Stocking all major lines. San Antonio's
Ham Store. Great Prices — Great
Service. Factory authorized sales and
service.
Hours: M-F 10-6; SAT 9-3

MISSION COMMUNICATIONS
11903 ALEIF CLODINE
SUITE 500 (CORNER HARWIN &
KIRKWOOD)
HOUSTON, TEXAS 77082
(713) 879-7764
Now in Southwest Houston—full line
of equipment. All the essentials and
extras for the "ham."

Wisconsin

AMATEUR ELECTRONIC SUPPLY
4828 W. FOND DU LAC AVE.
MILWAUKEE, WI 53216
414-442-4200
Wisc. Wats: 1 (800) 242-5195
Outside Wisc: 1 (800) 558-0411
M-F 9-5:30 Sat 9-3

Foreign Subscription Agents for Ham Radio Magazine

Ham Radio Austria Karin Ueber Postfach 2454 D-7850 Loerrach West Germany	Canada Send orders to Ham Radio Magazine Greenville, NH 03048 USA Prices in Canadian funds 1 yr. \$41.85, 2 yrs \$74.25 3 yrs \$99.90
Ham Radio Belgium Sterehouse Brusselaesteenweg 416 B-9218 Gent Belgium	Ham Radio Italy Via Manago 15 I-20134 Milano Italy
Ham Radio Holland Postbus 413 NL-7800 Ar Emmen Holland	Ham Radio Switzerland Karin Ueber Postfach 2454 D-7850 Loerrach West Germany
Ham Radio Europe Box 2064 S-194 02 Upllands Vasby Sweden	Ham Radio England c/o R.S.G.B. Lambda House Cranborne Road Potters Bar Herts EN6 3JW England
Ham Radio France SM Electronic 20 bis. Ave des Clarions F-89000 Auxerre France	
Ham Radio Germany Karin Ueber Postfach 2454 D-7850 Loerrach West Germany	

flea market



RATES Noncommercial ads 10¢ per word; commercial ads 60¢ per word **both payable in advance.** No cash discounts or agency commissions allowed.

HAMFESTS Sponsored by non-profit organizations receive one free Flea Market ad (subject to our editing) on a space available basis only. Repeat insertions of hamfest ads pay the non-commercial rate.

COPY No special layout or arrangements available. Material should be typewritten or clearly printed (not all capitals) and must include full name and address. We reserve the right to reject unsuitable copy. **Ham Radio** cannot check each advertiser and thus cannot be held responsible for claims made. Liability for correctness of material limited to corrected ad in next available issue.

DEADLINE 15th of second preceding month.

SEND MATERIAL TO: Flea Market, Ham Radio, Greenville, N. H. 03048.

R-390A RECEIVER: \$195 check; \$115 reparable. Parts, tubes, sections. Info SASE. Mint military-spec pull-out 12A7, 6AG5: \$15/ dozen. CPRC-26 six meter transceiver (see Ham Radio, March 1985) \$17.50 apiece, \$32.50 pair (add \$4.50/unit shipping). Baytronics, Box 591, Sandusky, OH 44870. (419) 627-0460 evenings.

DUAL ANTENNA Rotor Controller. For info SASE to: A & A ENGINEERING, 2521 W. La Palma Ave, #K, Anaheim, CA 92801. (714) 952-2114.

SELL MFJ-1270 TNC2. New in box. Will UPS for \$100.00. Matt (512) 675-3323 or Callbook QTH.

SUPERFAST MORSE CODE Super easy. Subliminal cassette. \$10. Amazing mnemonics: Learn Morse Code in 1 hour; Q signals super easy; Novice written exam super easy! \$5 each. Money-back guarantee. Free catalog. SASE. Bahr, 2549-H2 Temple, Palmbay, FL 32905.

TEST EQUIPMENT: HP8551B/851B Spectrum Analyzer and display section, frequency range 10.1 MHz to 12 GHz sensitivity up to -100 DBM \$1,850.00, measurements model 800 FM signal generator, covers FM bands 25 MHz to 960 MHz \$550.00. HP803A signal generator 50 kHz thru 65 MHz \$375.00, HP803A VHF impedance bridge 50 MHz thru 500 MHz, 2 to 2000 Ohms, measures directly, plus phase angle \$125.00, HP616B microwave signal generator 3.8 GHz thru 7.6 GHz \$375.00, URM-25D signal generator 10 kHz thru 50 MHz \$245.00, HP414A autovoltmeter \$85.00, URM-32A frequency meter 125 kHz thru 1000 MHz \$59.50. Lab calibrated, satisfaction guaranteed. Visa, M/C or check, add shipping, phone Bill Sleg (704) 524-7519. SLEP ELECTRONICS COMPANY, Highway 441, Otto, NC 28763.

MORSE CODE TUTOR 5-35 wpm. IBMpc compatibles. Random characters, disk file, variable speaker frequency, \$7.00 plus \$2.00 S&H. Jack Goral, N9ERY, 105-60th Street, Downers Grove, IL 60516.

BACK ISSUES of HR Magazine from Vol. 1 No. 1 thru 1986, except 2 issues. \$200 for all, postpaid. Also PopTronics, RE, 73 back to 1961. \$20.00/full year. Write with your needs. Bill Fossmann, 632 Wetmore, Everett, WA 98201.

ANALOG AND RF CONSULTING for the San Francisco Bay area. James Long, Ph.D N6YB (408) 733-8329.

CHASSIS, CABINET KITS. SASE. K3IWK, 5120 Harmony Grove Road, Dover, PA 17315.

IBM/APPLE COMPUTER program "Hamlog". 18 modules logs auto-sorts 7-band WAS/DXCC. Full feature. Also CP/M. Apple \$19.95, IBM \$24.95. HR-KA1AWH, PB 2015, Peabody, MA 01960.

IBM-PC SOFTWARE: CW Keyer, COM sends CW from RS232 port, any speed, using type ahead buffer, memory or disk. \$29.50. ELEC. EXE solves most common electronic equations, \$19.50. Bill Feldmann, 6677 Charing St, Simi, Calif. 93063, or SASE for details.

TELEVISION SETS made before 1946, early TV parts, literature wanted for substantial cash. Especially interested in "mirror in the lid" and spinning disc tv's. Finder's fee paid for leads. Arnold Chase, 9 Rushleigh Road, West Hartford, Conn. 06117. (203) 521-5280.

WANTED: EIMAC 8873 tube for Heath SB-230. Please contact G2DRT, F.S.G. Rose, 84 Cock Lane, High Wycombe, Bucks HP 13 7 EA England.

ENGINEERS request free catalog of Electronics Software. Circuit analysis, filter design, graphics, etc. BV Engineering, 2200 Business Way, Suite 207, Riverside, CA 92501 (714) 781-0252.

NJ-NJ-NJ-NJ-NJ-NJ-NJ-NJ A Full-Service Ham-SWL-CB-Scanner store in NJ. Discount Grand Opening Prices. Top performing radio systems for every budget. New 10 meter and VHF/UHF rigs. ARRL, Amphenol, Astatic, Astron, Azden, B&W, Bilal Belden 9913, Butternut, Clear Channel, KLM, Larsen, MFJ, Mirage, Mil Spec Cables, much more. Open M-F 10 AM-9PM. Sat 10 AM-7 PM. Buy and sell used gear and have qualified repair facility. ABARIS SYSTEMS, 276 Oriental Pl, Lyndhurst, NJ 07071 (201) 939-0015.

IBM-PC RTTY/CW. New ComPrty II is the complete RTTY/CW program for IBM-PC's and compatibles. Now with larger buffers, better support for packet units, pictures, much more. Virtually any speed ASCII, BAUDOT, CW. Text entry via built-in screen editor! Adjustable split screen display. Instant mode/speed change. Hardcopy, diskcopy, break-in buffer, select calling, text file transfer, customizable full screen logging, 24 programmable 1000 character messages. Ideal for MARS and traffic handling. Requires 256K PC or AT compatible, serial port, RS-232C TU. \$65. Send call letters (including MARS) with order. David A. Rice, KC2HO, 25 Village View Bluff, Ballston Lake, NY 12019.

CODE PROGRAMS. Apple/C-64. 31 modes, graphics, menus, wordprocessor, etc. LARESCO, POB 2018, 1200 Ring Road, Calumet City, IL 60409. (312) 891-3279.

SOLAR ELECTRIC PANELS and System Components. 1st quality for home or repeaters. Lowest prices in country. KA8DSS, RADIANT DISTRIBUTORS, 3900 Dursum, Ada, MI 49301. (616) 874-8899.

HOMEBREW PROJECTS LISTS SASE. WB2EUF, Box 708, East Hampton, NY 11937.

AMPLIFIER BREAKTHROUGH. The current amplifier drives loads push-pull without internal voltage gain. Fastest, quietest circuit in transistor electronics. Plans for quieter audio amplifiers, ideal for home builders, all wattages, 15. Amplifiers Unlimited, Rt. 2, Box 139, Highmore, SD 57345.

NATIONAL HRO-60 parts wanted: coils AA, AB, AC, AD, E, F, G, H, J. Power transformer #SA9209, 4H4 tubes. National Radio logo emblem (front panel mount). K6VRS, 33815-133rd Avenue SE, Auburn, Washington 98002 (206) 833-7298.

WA9GFR RF SOFTWARE \$15.00 disk contains HF/VHF/UHF/L-BAND propagation and Smith Chart impedance matching programs. Specify Commodore-64 or MS-DOS BASIC. Lynn Gerig, 6417 Morgan RD, Monroeville, IN 46773.

REMEMBER TROLLEY CARS? *Trolley Treasures: The Wartime Years in New Jersey* (1939-1947), a 4-volume photo-documentary history, includes 1600 unpublished, original photographs plus extensive historical notes. Volume 1, *The Compromise Roof Cars of Public Service Coordinated Transport*, ready now. SASE for details. To order, contact Trolley Themes, A.W. Mankoff, 2237-3 Woodside Lane, Sacramento, CA 95825. (\$14.95 plus \$1.50 S&H).

UHF PARTS. GaAs Fets, MMICs, trimmers, chip caps, teflon pcb, and other builder parts. SASE brings list. MICROWAVE COMPONENTS, 11216 Cape Cod, Taylor, MI 48180.

\$\$\$\$\$SUPER SAVINGS on electronic parts, components, supplies and computer accessories. Free 40-page catalog for SASE. Get on our mailing list. BCD ELECTRO, PO Box 830119, Richardson, TX 75083 or call (214) 890-1102.

RTTY JOURNAL—Now in our 35th year. Join the circle of RTTY friends from all over the world. Year's subscription to RTTY JOURNAL, \$10.00, foreign \$15.00. Send to: RTTY JOURNAL, 9085 La Casita Ave., Fountain Valley, CA 92708.

IMRA International Mission Radio Association helps missionaries. Equipment loaned. Weekday net, 14,280 MHz, 2.3 PM Eastern. Eight hundred Amateurs in 40 countries. Brother Frey, 1 Pryer Manor Road, Larchmont, New York 10538.

RUBBER STAMPS: 3 lines \$4.50 PPD. Send check or MO to G.L. Pierce, 5521 Birkdale Way, San Diego, CA 92117. SASE brings information.

ELECTRON TUBES: Receiving, transmitting, microwave... all types available. Large stock. Next day delivery, most cases. DAILY ELECTRONICS, PO Box 5029, Compton, CA 90224. (213) 774-1255.

CUSTOM MADE EMBROIDERED PATCHES. Any size, shape, colors. Five patch minimum. Free sample, prices and ordering information. HEIN SPECIALTIES, Inc., Dept 301, 4202 N. Drake, Chicago, IL 60618.

RECONDITIONED TEST EQUIPMENT \$1.25 for catalog. Walter, 2697 Nickel, San Pablo, CA 94806.

COMING EVENTS

Activities — "Places to go . . ."

SPECIAL REQUEST TO ALL AMATEUR RADIO PUBLICITY COORDINATORS: Please indicate in your announcements whether or not your Hamfest location, classes, exams, meetings, flea markets, etc. are wheelchair accessible. This information would be greatly appreciated by our brother/sister hams with limited physical ability.

NEW YORK: June 14. The Hall of Science ARC Hamfest, New York Hall of Science parking lot, Flushing Meadow Park, 47-01-111 Street, Queens. 9 AM to 3 PM. Donations—buyers \$4.00; sellers \$6.00 per space. Talk in on 144.300 simplex link 223.600 repeat and 445.225 repeat. For information call Steve Greenbaum, WB2KDG (718) 898-5599 or Arnie Schiffman, WB2YXB (718) 343-0172 evenings.

COLORADO: June 6 and 7. The Northern Colorado ARC is having its 9th annual Superfest, McMillen Building (wheelchair accessible) Larimer County Fairgrounds, Loveland. License exams, technical seminars, CW contest, Army MARS, exhibits, flea market and refreshments. General admission \$3.00. Tables \$7.50 each advance; \$9.00 at the door, includes two chairs and one admission. For reservations contact Duff McRoberts, NFOU, 1308 Ellen Place, Loveland, CO 80537. (303) 669-3708.

MICHIGAN: June 14. The Monroe Radio Communications Association Swap and Shop, Monroe. 8 AM to 3 PM. Admission \$2.50 advance; \$3.00 at the gate. Trunk sales \$2.00 per space. tables 50 cents/foot. Tickets or reservations contact: Elaine Wessel, KA8RKN, PO Box 237, Monroe, MI 48161 or call (313) 279-1571.

CALIFORNIA: June 21. Father's Day Swapfest sponsored by the Satellite ARC. Union Oil Company Newlove Picnic Grounds south of Santa Maria on US 101. Free general admission 9 AM. Barbeque 1 PM. Price for tickets TBA. Talk in on 145.14 down 600. For tickets and information write Santa Maria Swapfest, PO Box 5117, Vandenberg AFB, CA 93437.

WISCONSIN: July 18. The South Milwaukee ARC will hold its annual Swapfest, American Legion Post 434, 9327 South Shepard Avenue, Oak Creek. 7 AM to 3 PM. Parking, picnicking, food, refreshments and free overnight camping available on grounds. Admission \$3.00 includes "happy time" with free beverages. License exams. Packet meeting. For details write South Milwaukee ARC, PO Box 102, South Milwaukee, WI 53172-0102.

MARYLAND: June 21. The Frederick ARC will hold its 10th annual Hamfest, Frederick Fairgrounds, 8 AM to 4 PM. Admission \$3.00. Tailgaters \$2.00 extra. Non-hams and kids free. For information: Clyde C. Wachter, WB3KQV, 7317 Ridge Road, Frederick, MD 21701.

MINNESOTA: June 6 and 7. The North Area Repeater Association will sponsor the upper Midwest's largest Swapfest and exposition for Amateur Radio operators at the Minnesota State Fairgrounds, St. Paul. Admission \$4.00 advance; \$5.00 at the door. Free overnight parking for self-contained campers June 5 and 6. Giant outdoor flea market. License exams. For information: Amateur Fair, PO Box 857, Hopkins, MN 55343 (612) 566-4000.

INDIANA: June 14. The 41st annual Wabash Valley Amateur Radio Association's Hamfest, Vigo County Fairgrounds, Terre Haute. Saturday night camping \$5.00. Sunday 8:00 AM EST. Free outdoor flea market. Covered flea market \$3.00. Food and refreshments. Advance tickets \$2.00 or 3/\$5.00. \$3.00 at the gate. FCC exams by pre-registration only. Children under 12 free. Talk in on 147.69/09 and 146.52 simplex. For tickets and information SASE to WVARA Hamfest, PO Box 81, Terre Haute, IN 47808.

PENNSYLVANIA: July 5. 8th annual Wilkes-Barre Hamfest & Computerfest sponsored by Murgas ARC, Vigo County Fairgrounds, Terre Haute. Saturday night camping \$5.00. Sunday 8:00 AM EST. Free outdoor flea market. Covered flea market \$3.00. Food and refreshments. Advance tickets \$2.00 or 3/\$5.00. \$3.00 at the gate. FCC exams by pre-registration only. Children under 12 free. Talk in on 147.69/09 and 146.52 simplex. For tickets and information SASE to WVARA Hamfest, PO Box 81, Terre Haute, IN 47808.

NEW JERSEY: June 20. The Raritan Valley Radio Club's 16th annual Hamfest, Columbia Park, Dunellen. Gates open 8 AM. Sellers spots \$5.00 for one, \$10.00 two or more. No tables supplied. Talk in on Club repeater W2QW/R 146.025/625 and 146.52 simplex. For information call Dave, KA2TSM (201) 763-4849 or Bill, KD2XK (201) 467-7342, 8 AM to 5 PM.

PENNSYLVANIA: June 14. Milton Amateur Radio Club's 13th annual Hamfest, Winfield Firemen's grounds, Rt. 15 Lewisburg. Rain or shine. Admission \$3.00. Non-hams and kids free. Talk in on 146.97, 146.625 and 146.52. Contact Jerry Williamson, WA3SXQ, 10 Old Farm Lane, Milton, PA 17847.

MICHIGAN: June 6. The Independent Repeater Association is sponsoring its annual Hamfest, National Guard Armory, 44th Street, Grand Rapids. Free tables for dealers and sellers. For table reservations: Independent Repeater Association, 562-92nd Street, SE, Byron Center, MI 49315 (616) 455-3915.

NEW JERSEY: GILFER SWL FEST/FLEA MARKET: Saturday, June 13 rain/shine. 9 AM to 3 PM. Shortwave only. Free admission for all visitors. Sellers: \$3.00 (tailgate only, bring own table). Reservation deadline: June 1. Location: GILFER SHORT-WAVE, 52 Park Avenue, Park Ridge, NJ 07656. For further information please call (201) 391-7887.

MARYLAND: June 10-13. The Antique Radio Club of America will hold its 15th annual National Convention, SHERATON HOTEL AND EXHIBITION CENTER, RT. 450, New Carrollton, 10 miles NE of Washington, DC. The public is cordially invited to attend this 4-day event. Membership information can be obtained from ARCA, 81 Steeplechase Road, Devon, PA 19333.

KENTUCKY: June 7. The Northern Kentucky ARC's "Ham-O-Rama '87", Erlanger, Kentucky, Lions Park. Open to public 8 AM. Admission \$5.00. Children under 13 free. Flea market spaces \$3.00 each, no tables provided. Contact WA4WNF c/o NKARC, PO Box 281, Florence, KY 41042 (606) 371-2255.

INDIANA: June 21. The Lake County ARC will hold its 15th annual Dad's Day Hamfest, Lake County Fairgrounds, Crown Point. All tickets \$3.00. Gates open 8 AM. Talk in on club repeater 147.60/00 and 146/52. Contact: Ken Brown, WDSHYF, 918 Chippewa Drive, Crown Point, IN 46307.

ILLINOIS: June 14. The Six Meter Club of Chicago announces its 30th annual Hamfest, Santa Fe Park, 91st and Wolf Road, Willow Springs, SW of downtown Chicago. Advance tickets \$3.00. At the gate \$4.00. Talk in on K9ONA 146.52 or K9ONA/R 37.97. For advance ticket Mike Corbett, K9ENZ, 606 South Fenton Avenue, Romeoville, IL 60441 or any club member.

CENTRAL ALBERTA RADIO LEAGUE annual Picnic and Hamfest. June 19, 20 and 21.

PENNSYLVANIA: July 4. The annual Firecracker Hamfest sponsored by the Harrisburg RAC, Bressler Fire Company picnic grounds, Harrisburg. Admission \$3.00 includes tailgating. Non-ham spouse and kids free. VE exams. For information: Dave, KC3MG, 131 Livingston Street, Swatara, PA 17113 (717) 939-4957.

WASHINGTON: June 6 and 7. Apple City Radio Club's "Come Have a Picnic With Us" Hamfest, Rocky Reach Dam, 7 miles north of Wenatchee, US 97. Free Camping/Trailer space at the Park, Saturday evening banquet, Sunday potluck dinner, Swap Shop, VE exams.

WEST VIRGINIA: July 19. The 9th annual TSARC Wheeling Hamfest/Computer Fair, Wheeling Park. 9 AM to 4 PM. WV's largest. Dealers welcome 30,000 square feet under roof; 5 acres flea market. Family activities at Park. Admission \$3.00 in advance; \$4.00 at door. To reserve space contact: Carl Williams, WD8PPS, 9 East High St, Flushing, OH 43977. For tickets: TSARC, Box 240, RD 1, Adena, OH 43901 (614) 546-3930.

NEW HAMPSHIRE: June 20. Fly-in to New Hampshire's 2nd largest Amateur Radio/electronic flea market, Manchester Municipal Airport. Sponsored by the NH FM Association. Rain date Sunday, June 21. Starts 9 AM. General admission \$1.00. Sellers \$5.00. Bring table or tailgate. License exams. Talk in on 146.52 FM. For further information on flea market contact Steve Morin, WB18XB (603) 663-4019 or Dick Desrosiers, W1KZG, 173 Maplehurst Avenue, Manchester, NH 03103 (603) 668-6868.

PENNSYLVANIA: June 7. The 33rd annual Breeze Shooters Hamfest, White Swan Amusement Park, Rt 60, near Pittsburgh International Airport. Free admission and Flea Market, family amusement park. 9 AM to 4 PM. For information and table reservations Bud Faulhaber, N3DOS, 1059 Balmoral Drive, Pittsburgh, PA 15237 (412) 366-5097.

COLORADO: June 20. The Grand Mesa Repeater Society will hold its 8th annual Western Slope Amateur Radio and Computer Swapfest, 9 AM to 4 PM, National Guard Armory, 482-28 Road, Grand Junction. Free admission. Swap tables \$5.00 each. In-door swapfest, Amateur Radio exams, auction and refreshments. Talk in on 146.22 / 82 and 449.20. For tables or information SASE to Les Scott, NV0F, 2105 Yellowstone Rd, Grand Junction, CO 81503 or call (303) 242-5296.

1987 "BLOSSOMLAND BLAST" Sunday, September 20, 1987. Write "BLAST" PO Box 175, St. Joseph, MI 49085.

VIRGINIA: June 7. The Ole Virginia Hams present the Annual Manassas Hamfest, Prince William County Fairgrounds, 8 AM to 4 PM. General admission \$4.00. Children under 12 free. Tailgating \$5.00/space. Dealers, ARRL booth, CW proficiency award. Talk in on 146.37/97, 146.52. For information write: Ole Virginia Hams ARC, POB 1255, Manassas, VA 22110. John Gunsett, K1MVP (703) 361-5255 or Gene Roberts, N4HFW (703) 361-3983.

MICHIGAN: June 7. The Chelsea Swap and Shop, Chelsea Fairgrounds, Chelsea. Sellers 5 AM. Buyers 8 AM to 1 PM. Donation \$2.50 advance and \$3.00 at the gate. Children under 12 and non-ham spouses free. Talk in on Chelsea Repeater 146.980. For information: Robert Schantz, 416 Wilkinson St, Chelsea, MI 48118. (313) 475-1795.

OPERATING EVENTS

"Things to do . . ."

June 19 to 21: The Six Meter International Radio Klub, Inc. announces their 12th annual SMIRK PARTY Contest. SASE for log requests to Lisa Lowell, KA0NNO, PO Box 547, Hugo, CO 80621.

June 6 and 7: The Wireless Institute of Northern Ohio (W.I.N.O.) will have a special events station to commemorate Ohio Wine Month. The station will be operating from a winery in Madison, Ohio and will use call sign K080. For a special certificate send legal SASE to K080 WINO Weekend, 7126 Andover Drive, Mentor, Ohio 44060.

June 26-28: The Ottawa ARC will operate W8MCB from 1700Z to 2300Z to celebrate the 175th anniversary of establishment of the Fort during the War of 1812. For a commemorative certificate send OSL and SASE to WD8RJR, Paul Baumgart, RR #3, Box 341, Delphos, Ohio 45833.

July 11 and 12: Oklahoma Amateur Radio Operators will conduct their 4th annual "Field Day" exercises at Lake Canton, OK. Activities begin 2 PM Saturday during noon Sunday. For additional information contact Tim Mauldin, WA5LTM, Lake Canton Field Day, PO Box 19097, Oklahoma City, OK 73144 (405) 521-5048.



NEW BOOKS

THE DIGITAL NOVICE

by Jim Grubbs, K9EI

Now that novices have digital privileges, there are thousands of new Amateurs anxiously awaiting to get on-the-air. Who's going to answer their questions however? Jim Gubb's new book, *The Digital Novice* is written with beginner's needs in mind. Each of the popular digital modes is fully covered with a brief history and full description of how it works. Hardware and software are covered in clear, concise terms. The book finishes with a look toward the future. Four appendixes cover; Morse, Baudot, AMTOP and ASCII Codes and has a glossary full of commonly used but misunderstood terms. Great for beginners and experts alike. ©1987 1st edition

JG-DN Softbound \$9.95
Pre-Publication Special Save \$1.00

YAGI ANTENNA DESIGN

by Dr. James Lawson, W2PV

Based upon the popular Ham Radio Magazine series, this book includes notes, charts, graphs as well as other additional information not found in the original text. W2PV was known world-wide as one of the most knowledgeable experts on antenna design and optimization. This book is full of his contest winning "trade secrets." Eight chapters cover: Performance calculations, Simple Yagi antennas, Yagi antenna performance optimization, Loop antennas, The effects of ground, Stacking, Practical design, and Practical Amateur Yagi antennas. A wealth of information at a modest price—Lawson's book should sell for much more—every Ham should get a copy for their bookshelf. ©1986 1st edition

AR-YD Hardbound \$14.95

RADIO DATABASE INTERNATIONAL 1987 Edition

One of the problems SWL's encounter is having an up-to-date and accurate program schedule for international broadcasters. While no listing can ever be 100% accurate, this new book represents thousands of hours of research and is one of the most accurate SWL international broadcasting listings available. Stations are listed by frequency and language format. Also included is power output and to whom the programming is directed and other helpful information. Covers 2 to 26 MHz short-wave bands. A Buyer's Guide gives you information on selected portable and tabletop radios. A number of tutorial articles have been included to help you get the most from your radio. ©1986

IBS-RDI Softbound \$12.95

Please enclose \$3.50 shipping and handling

ham radio magazine
BOOKSTORE
GREENVILLE, NH 03048
603-878-1441



CHARGE YOUR CLASSIFIED ADS

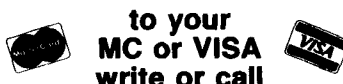

to your
MC or VISA
write or call

HAM RADIO MAGAZINE

Greenville, NH 03048

(603) 878-1441

MOVING? KEEP HAM RADIO COMING . . .

If possible let us know four to six weeks before you move and we will make sure your HAM RADIO Magazine arrives on schedule. Just remove the mailing label from this magazine and affix below. Then complete your new address (or any other corrections) in the space provided and we'll take care of the rest.

ham radio Magazine
Greenville, NH 03048

Allow 4-6 weeks for correction.

Thanks for helping us to serve you better.

Here's my new address:

Call _____
Name _____
Address _____
City _____ State _____ Zip _____

AFFIX LABEL HERE

MISSOURI RADIO CENTER

102 N.W. Business Park Lane, Kansas City, MO 64150 816-741-8118

Call toll free — 9am - 6pm Mon - Fri., 9am - 2pm Sat.
In Missouri Call — 816-741-8118

1-800-821-7323

TRADE INS ACCEPTED
MasterCard — VISA — COD Welcome

AEA
ALINCO
AMERITRON
ASTRON
AVANTI
B & W
BENCHER
BUTTERNUT
COMM SPEC
CUSHCRAFT
DAIWA

KENWOOD



TS940S "DX-celence"

- Programmable Scanning
- High Stability, Dual Digital VFO's
- 40 Channel Memory
- General Coverage Receiver

KENWOOD



TS440S "DX-CITING"

- 100% Duty Cycle
 - 100 memories
 - Direct Keyboard Entry
 - Optional Built-in AT
- On Sale Now, Call For Price!

KENWOOD



TM-3530A

- 220 MHZ MOBILE FM
TRANSCIVER
- 220-225 MHz with 25 Watts
 - 7-Digit Telephone No. Memory
 - Direct Frequency Entry
 - 23-Channel Memory

KENWOOD

NEW

TH-215A

"FULL FEATURED 2m HT"

- 141-163 MHz Receive
- 144-148 MHz Transmit
- 2.5w Output (5w Optional)
- 10 Memories
- Built-in CTCSS Encoder
- Nine Types of Scanning

YAESU



FT-757GX "CAT SYSTEM"

- All Mode Transceiver
 - Dual VFO's
 - Full Break-in CW
 - 100% Duty Cycle
- CALL FOR BEST PRICE!

YAESU



FT-767GX HF/VHF/UHF

- BASE STATION
- Add Optional 6m, 2m & 70cm Modules
 - Dual VFO's
 - Full CW Break-in
 - Lots More Features

YAESU

FT23/73R

- Zinc-Aluminum Alloy Case
 - 10 Memories
 - 140-164 MHz, 440-450 MHz
 - 600 MAH Standard Opt. 5w
- New "super handle"



YAESU

FT-109RH

220 MHz H.T.

- 5 Watts Output
- Battery Saver
- 10 Memories
- Multiple Scanning Routines
- Power Meter



ICOM



IC-735 "NEW"

Can you put a price tag on reliability? Now ICOM offers a ONE YEAR WARRANTY on its HF Transceivers & Receivers purchased after August 1, 1986.

ICOM



IC-751A "NEW"

- 100 KHz - 30 MHz
- FM Standard
- 32 Memories
- QSK (Nominal Speed 40 WPM)

ICOM



IC-38A

- Full 25W, 5W low
 - 21 memories
 - Subtones built in
 - RX 215-230 MHz
- CALL FOR BEST PRICE

ICOM

IC-12AT

- 140-163 MHz
- 10 Memories
- 1W, 1.5W optional
- 32 tones built-in



IC-03AT

- 220 to 224.995 MHz
- 2.5W, 5W Optional
- Built in subtone
- 10 Memories



Kantronics



KAM

Kantronics All Mode

- CW, RTTY, ASCII, AMTOR, HF & VHF Packet
- RS-232/TTL, Universal Compatibility
- Transmit and Receive CW 6-99 wpm, RTTY/ASCII 45-300 Baud, ARQ, FEC, SELFC, Listen ARQ, VHF and HF Packet



MFJ-1274

TNC 2 PACKET RADIO

- VHF and HF Packet
- Precision Tuning Indicator
- AX .25 Level 2 Version 2 Software
- TTL Serial Port
- More!

MFJ

NOVICES

ARE YOU CONFUSED ABOUT YOUR NEW PRIVILEGES? CALL US FOR THE UP-TO-THE-MINUTE INFORMATION AND ASSISTANCE WITH YOUR GEAR.

✓ 109

PK 232



- Make any RS-232 compatible computer or terminal a complete digital operating position.
- Morse, Baudot, ASCII, AMTOR, Packet
- Loaded with features.

ASTRON CORPORATION



Power Supply

- RS7A \$48
- RS12A \$68
- RS20A \$88
- RS20M \$105
- VS20M \$125
- RS35A \$133
- RS35M \$149
- VS35M \$165
- RS50A \$189
- RS50M \$215
- RM50A \$219
- VS50M \$229

HUSTLER

HYGAIN

ICOM

• MOST ORDERS SHIPPED SAME DAY •

J.I.L.

KANTRONICS

KDK

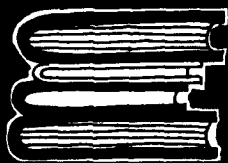

ELMER'S NOTEBOOK

Tom McMullen, W1SL

elmer's notebook

Welcome to *ham radio's* new feature: Elmer's Notebook. You're going to find it informative, interesting, and — we hope — useful in many ways.

who's Elmer?

Elmer is the person who helped us at one time or another, either in our efforts to get started or in trying something new in Amateur Radio. Although he wasn't necessarily an old-timer, he had considerably more experience than we did. Who was he?

Maybe *you!* Many of you have been Elmers without realizing it. Some would have been mildly embarrassed if caught in the act. But Elmers you have been, nevertheless.

For some, being an Elmer is actually a hobby within the hobby. Dedicated Elmers spend large amounts of time helping newcomers bone up for exams and acquire their first rigs. They're always available to critique the new fist or help calm the first-contact jitters.

That's what this new column is all about — to provide guidance, encouragement, and useful material for the Elmers among *ham radio's* readers. Of course, if Novice or other licensees find Elmer's Notebook helpful or thought-provoking, that's great too!

novice enhancement

Novice Enhancement has been in the works since April, 1986, when the FCC adopted a Notice of Proposed Rule Making (NPRM) in response to several petitions. After several hearings and response periods, it finally became official on March 21, 1987: Novices now have expanded privileges

that provide immense possibilities for communication and enjoyment on the 10-meter band, and new privileges in the 220- and 1270-MHz bands. **Figure 1** shows the relationship of these segments to other parts of the Amateur Radio spectrum. The shaded areas in-

a concern for safety at these higher frequencies; until the operator has learned enough to understand why caution is essential, low power levels are prudent indeed. We'll talk more about this aspect of operation in future columns.

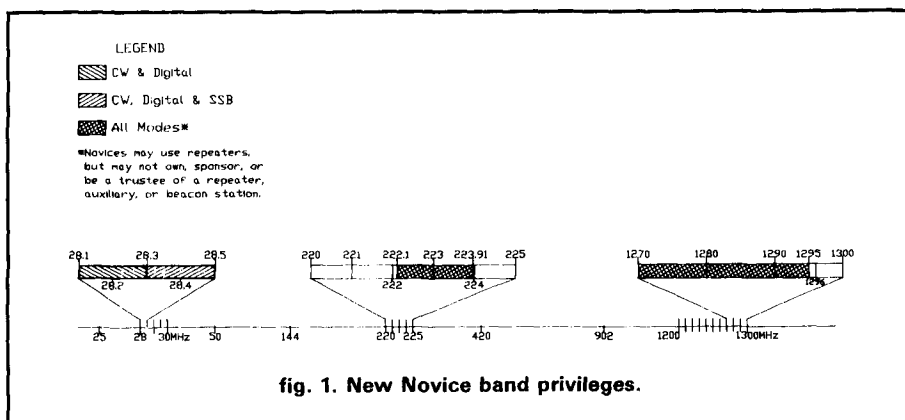

fig. 1. New Novice band privileges.

dicating the modes Novices are permitted to use on those band segments. Power levels are 200 watts PEP on 28.1 to 28.5 MHz (this same power restriction applies to Technician class licensees on this band), 25 watts PEP on 222.1 to 223.91, and 5 watts PEP on 1270 to 1295 MHz.

These power levels are reasonable. They're adequate for plenty of exciting communications, either direct or through repeaters, yet still offer incentive to upgrade to a higher license in order to expand capabilities. Though the 5-watt limit at 1270 MHz may seem low at first glance, it's ample for use through repeaters and for direct communication via hand-held equipment or mobile and fixed stations. There is

the challenge

These new privileges and frequencies not only give Novices room for growth, but also generate a challenge for us Elmers: to help Novices respond to the FCC's strong recommendation, voiced in its Report and Order, that current licensees "become knowledgeable in the new requirements before using the new privileges." It's up to us to advise them about techniques, equipment, and procedures required for the new modes of communication and on the new bands so they'll be comfortable when they try them — and so they can enjoy these privileges without creating problems simply because they haven't been there before.

Along with this primary challenge

The Professional Meter for Amateur Radio.



The standard of the electronics industry is setting a new standard for amateur radio use as well.

The Fluke 77 multimeter is ideal for testing and repairing any amateur radio gear. It's inexpensive, easy to use, and filled with professional features. Plus a full line of accessories let you measure high frequency, high voltage and current, and temperature. Made in the U.S.A. and backed by a 3-year warranty, the new Fluke 77 is the world's first handheld meter to combine analog and digital displays.

For a free brochure or the distributor nearest you, call toll-free **1-800-227-3800, ext. 229**. Or write John Fluke Mfg. Co., Inc., P.O. Box C9090, Everett, WA 98206. Distributor programs available.

FROM THE WORLD LEADER
IN DIGITAL MULTIMETERS.

FLUKE 73	FLUKE 75	FLUKE 77
\$79†	\$109†	\$145†
Analog/digital display	Analog/digital display	Analog/digital display
Volts, ohms, 10A, diode test	Volts, ohms, 10A, mA, diode test	Volts, ohms, 10A, mA, diode test
Autorange	Audible continuity	Audible continuity
0.7% basic dc accuracy	Autorange/range hold	Touch-Hold™
2000+ hour battery life	0.5% basic dc accuracy	Autorange/range hold
3-year warranty	2000+ hour battery life	0.3% basic dc accuracy
	3-year warranty	2000+ hour battery life
		3-year warranty
		Multipurpose holster

† Suggested U.S. list price, effective January 2, 1987.



© 1987 Fluke

comes a second one — to prepare prospective Amateurs for the ten new questions to be incorporated into the revised Element 2 exam. (All Novices licensed before March 21 will be "grandfathered" into the new privileges.) If we do our homework and work toward meeting the primary goal, we'll be better prepared for meeting the second.

There shouldn't be much trouble in explaining voice modes (with the possible exception of answering the questions about PEP). Novices have been waiting to try voice for a long time, and have had plenty of time to listen to voices on the high-frequency bands, just a twist of the dial away from their own CW segments.

Digital modes? Now it gets interesting. Digital communications is a relative newcomer to the Amateur Radio bands. The newest facet of that mode is packet radio, with AMTOR a close second. RTTY has been with us for quite a while, but its image has changed dramatically over the years. I can still recall the heavy, noisy, cranky monster that I assembled back in the late 1940s — but that's another story.

As I peruse the exhibitor's booths and the flea markets at hamfests, I note many small, neat, RTTY demodulators that fit handsomely on the operating desk, work with almost any common computer setup, and make very little noise. They use less power than it took to just light the filaments in the tubes in my early rig. (Filaments? Oh, they were like heating elements down inside the tube, and their function was to get the adjacent metal hot enough to excite the electrons so they'd be easier to manipulate. Filaments also made a nice cozy glow in a darkened room, made the watt-hour meter spin merrily, and told you immediately that the tube was on.) Although today's digital equipment is as far ahead of RTTY as the new RTTY demodulators are ahead of the military surplus that clanked out endless RYRYRY messages in the 1950s, RTTY is still an attractive means of communication.

Obviously, the Novice license is taking beginners into much more interesting and complex technology, and we should be prepared to provide answers and guidance. The new segments on 220 and 1270 MHz offer many exciting possibilities. Just a few of the inevitable questions include "What can be done at these frequencies?" "What's their communication range?" "Where do I get equipment?" "What about antennas?" And — here's a good one — "Can I send television on 1200 megs?" There are many answers to search for and lots of exciting territory to explore. We're here to help.

Next month, we'll take a closer look at the specific privileges indicated in **fig. 1**. In future issues, we'll discuss equipment and operating procedures, and provide information to help you prepare would-be Amateurs for the new Element 2 exam questions.

ham radio

Welcome Back, Tom

With this first installment of "Elmer's Notebook," we welcome Tom McMullen, W1SL, former managing editor of *Ham Radio Horizons*, back to *ham radio*.

Tom's involvement in radio began during his days as a Navy radio operator on a cruiser in the Pacific during World War II. First licensed in 1947, Tom credits much of his early growth in Amateur Radio to his Elmer, the late W8GBF.

Although his initial interest was in handling traffic on 80 meters, Tom moved on to VHF and microwave communications in the early 1970s and remains active in those areas today. He and his wife Eleanor, W1RNT, live in Florida, where Tom is employed as publications manager for a major electronics firm. — Ed.

DOWN EAST MICROWAVE



MICROWAVE ANTENNAS AND EQUIPMENT

- Loop Yagis • Power Dividers • Linear Amplifiers • Complete Arrays • Microwave Transverters • GaAsFET Preamps
- TROPO • EME • Weak Signal • OSCAR • 902 • 1296 • 1296 • 2304 • 2400 • 3456 MHz

- 2345 LY 45el loop Yagi 1296 MHz 20dBi \$93
- 1345 LY 45el loop Yagi 2304 MHz 20dBi \$80
- 3333 LY 33el loop Yagi 902 MHz 18.5dBi \$93

Above antennas assembled and tested. Kits available. All Aluminum and Stainless Construction. Add \$8 UPS S/H, \$11 West of the Mississippi.

- 2316 PA Linear Amp 1W in 18W out 1296 MHz 13.5V. \$245 ppd.
- 2335 PA Linear Amp 10W in 35W out 1296 MHz 12.5V. \$295 ppd.

NEW! MICROWAVE CONVERTERS BY LMW ELECTRONICS

- 1296TRV5D 5W, GaAsFET, T/R Sequencer, Output Meter \$499
- 2304TRV2D 2W, GaAsFET, T/R Sequencer, Output Meter \$589

Add \$6 for shipping UPS/48

Stripped down version, kits also available

Write For FREE Catalog

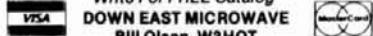

DOWN EAST MICROWAVE
Bill Olson, W3HQT

Box 1855A RFD #1, Burnham, ME 04922 U.S.A.
(207) 948-3741

✓ 105

PRC®

SERVICE CENTER
for
ICOM, KENWOOD
and **YAESU**

Fully equipped repair shop Amateur,
Marine and Land Mobile repairs.

FCC NABER Lic
Mon-Fri 10:00-4:00 pm
(206) 776-8993

PACIFIC RIM COMMUNICATIONS

Bob KG7D
23303 56th Ave. West
Mountlake Terrace, Wa 98043

& C.O.D.S. Welcome

✓ 106

ALL BAND TRAP "SLOPER" ANTENNAS!

FULL COVERAGE! ALL BANDS! AUTOMATIC SELECTION with PROVEN Weatherproof sealed Traps - 18 Ga Copperweld Wire! GROUND MOUNT SLOPERS - No Radials needed! Ground to rod, or house water faucet! Connect Top to Trees, Buildings, Poles, etc at ANY angle from Straightup to 60 degrees for excellent "SLOPER" DX Antenna Gain or bend it anywhere you need to! 2000 Watt PEP Input, max. Permanent or portable Use. Installs in 10 minutes. SMALL - NEAT - ALMOST INVISIBLE - No one will know you have a Hi-Power DX Antenna. Ideal For COND'Os APARTMENTS - RESTRICTED AREAS - Pre-tuned for 2-1 or less SWR over ALL bands (except 80-160-300Kc) No adjustments needed - EVER. COMPLETELY ASSEMBLED, with 50 ft RG-58U Coax feedline and PL259 connector - Built in lightning arrester - ready to hookup! FULL INSTRUCTIONS!

No. 1080S - 80-40-20-15-10 - 1 trap 49 ft. - \$59.95
No. 1040S - 40-20-15-10 - 1 trap 26 ft. - \$58.95
No. 1020S - 20-15-10 - 1 trap 13 ft. - \$57.95
No. 1016S - 160-80-40-20-15-10 - 2 traps 83 ft. - \$89.95

SEND FULL PRICE FOR PPDEL IN USA (Canada is \$5.00 extra for postage etc) or order using VISA, MASTERCARD - AMER EXP. Give Number & Date. Ph: 1-308-236-5333 weekdays. We ship in 2-3 days (Per Cks 14 days) Guaranteed 1 yr - 10 day money back trial.

WESTERN ELECTRONICS
Dept. AH Kearney, Nebraska 68847

✓ 107

SUBSCRIBE

AND RENEW

TOLL-FREE



ham radio
magazine

1 YR - \$22.95 2 YRS - \$38.95

3 YRS - \$49.95

Prices U.S. only



- MASTERCARD
- VISA BILL ME

Please have your charge card ready.

DATATEL 800™

800-341-1522

Weekdays 8 AM - 9 PM EST • Saturdays 9 AM - 5 PM EST
IN MAINE CALL COLLECT (207) 236-2896

OUR 800 NUMBER IS FOR SUBSCRIPTION ORDERS ONLY!

For Errors or Change of Address CALL *ham radio*
direct at (603) 878-1441 8-5 EST

ADVERTISER'S INDEX AND READER SERVICE NUMBERS

Listed below are the page and reader service number for each advertiser in this issue. For more information on their products, select the appropriate reader service number make a check mark in the space provided. Mail this form to ham radio Reader Service, I.C.A., P.O. Box 2558, Woburn, MA 01801.

Name _____ Call _____

Address _____

City _____ State _____ Zip _____

*Please contact this advertiser directly.

Limit 15 inquiries per request.

Please use before July 31, 1987.

READER SERVICE #	PAGE #	READER SERVICE #	PAGE #
151 - Advanced Computer Controls	41	100 - Glen Martin Engineering, Inc.	27
115 - Advanced Receiver Research	78	120 - Metal & Cable Corp.	73
135 - AEA	59	169 - MFJ Enterprises	7
131 - All Electronics Corp.	62	111 - Micro Control Specialties	87
155 - Amateur Wholesale Electronics	36	138 - Midland Technologies	49
143 - AMSAT	46	159 - Mirage Communications	35
129 - Antique Electronic Supply	70	123 - Mission Communications	72
118 - Antique Radio Classified	77	109 - Missouri Radio Center	94
132 - ARRL	38	147 - Motron Electronics	44
162 - Astron Corp.	32	144 - NCG	44
* - Barker & Williamson	12	141 - Nel-Tech Labs, Inc.	46
184 - Barrett Elec.	20	173 - Nema Electronics	20
* - Barry Electronics	73	110 - Nuts & Volts	87
125 - Bilal Company	72	171 - P.C. Electronics	9
178 - BMA Software	28	166 - Pac-Comm Packet Radio Systems, Inc.	28
122 - Buckmaster Publishing	73	106 - Pacific Rim Communications	97
145 - Buckmaster Publishing	44	* - Palomar Engineers	78
102 - Burghardt Amateur Center	99	156 - Processor Concepts	30
* - Butternut Electronics	38	186 - The PX Shack	62
* - Caddell Coil Corp.	44	114 - Radio Amateur Callbook	79
150 - Coaxial Dynamics, Inc.	42	134 - Radio Works	62
152 - Communication Concepts, Inc.	41	142 - Radiosporting	46
103 - Communications Specialists	100	119 - Ramsey Electronics, Inc.	74
161 - CTM	33	* - RF Parts	39
170 - Digitrex	98	157 - Rutland Arrays	28
105 - Down East Microwave	97	187 - S-Com	49
149 - EGE, Inc.	43	183 - Sias Engineering Co.	12
108 - Fluke Manufacturing Co.	96	112 - Sommer	87
* - Fox Tango Corp.	62	* - Spec-Com	38
180 - GLB Electronics	9	160 - Spectrum International	34
126 - Grove Enterprises	70	163 - Stridsburg Engineering Co.	30
137 - H.L. Heaster, Inc.	49	181 - STV/OnSat	26
182 - HAL Communications Corp.	10	124 - Synthetic Textiles, Inc.	72
165 - Hall Electronics	30	188 - TE Systems	27
* - Ham Radio Magazine	97	172 - Tel-Com	20
174 - Ham Radio Outlet	14, 15	140 - Telewave, Inc.	49
* - Ham Radio's Bookstore	34, 41, 42, 49, 70, 73, 89	177 - Testware	28
* - The Ham Station	89	128 - Transverters Unlimited	70
* - Hamtronics, NY	23	189 - Unadilla/Antennas Etc	30
113 - Hamtronics, PA	85	133 - Unity Electronics	62
* - Hamtronics, PA	77	* - University Microfilm Int.	38
190 - Heath Company	52	146 - Vanguard Labs	44
127 - Hildreth Engineering	70	175 - Varian EIMAC	16
136 - ICOM America, Inc.	50, 51	116 - W9INN Antennas	78
167 - ICOM America, Inc.	CII	101 - Wacom Products, Inc.	98
164 - IIX Equipment Ltd.	36	107 - Western Electronics	97
* - Indianapolis Hamfest	27	148 - Wi-Comm Electronics, Inc.	44
121 - Interceptor Electronics, Inc.	73	104 - Yaesu Electronics Corp.	CIII
154 - International Radio	68	176 - E.H. Yost Co.	36
153 - Jun's Electronics	40		
158 - Kagil	36		
168 - Kantronics	1		
117 - Kennedy Associates	77		
* - Trio-Kenwood Communications	2, 5, CIV		
130 - Madison Electronics Supply	68		

WACOM DUPLEXERS

Our Exclusive Bandpass-Reject Duplexers
With Our Patented

B_p B_r CIRCUIT[®] FILTERS

✓ 101

provide superior performance... especially at close frequency separation.

Models available for all commercial and ham bands within the frequency range of 30 to 960 MHz.



CALL
817/848-4435



WACOM PRODUCTS, INC.

P.O. BOX 21145

WACO, TEXAS 76702 • 817/848-4435



POCKET SIZED!!
1-500 MHZ
FREQUENCY COUNTER
BUILT, TESTED, AND
READY-TO-GO!

ONLY \$49.95 Prepaid

HAND HELD!!
1-1300 MHZ
FREQUENCY COUNTER
BNC INPUT CONNECTOR



ONLY \$79.95 Prepaid

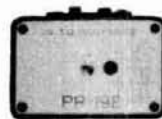

PICK UP THOSE WEAK
SIGNALS! FULLY
ENCLOSED PA-19E HAS
.5-200 MHZ RANGE.
POWER SUPPLY OPTION
AT NO CHARGE WITH
THIS PREAMPLIFIER

ONLY \$24.95 Prepaid
Without case... \$9.95

PA-20E PRE-AMP
FULLY ENCLOSED
WITH A DC-1000 MHZ
RANGE AND POWER
SUPPLY OPTION.



ONLY \$34.95 Prepaid
Without case... \$19.95

✓ 170

Specify type of radio when ordering pre-amplifiers.

DIGITREX ELECTRONICS

division of NCI
10073 North Maryann
Northville, MI 48167

West Coast:
Call Ray Lukas
805-497-2397

Personal checks, money orders, MasterCard or Visa are welcome. Or call in a C.O.D. PHONE (313) 348-7313 NOW!

NEWS *we'll treat you*

BULLETIN

For more than 40 years we have been serving the amateur community with QUALITY PRODUCTS and DEPENDABLE "S-E-R-V-I-C-E" and, we fully intend to carry on this proud tradition with even MORE new product lines plus the same "fair" treatment you've come to rely on. Our reconditioned equipment is of the finest quality with 30, 60 and even 90-day parts and labor warranties on selected pieces. And, remember...

— WE SERVICE WHAT WE SELL —

AEA	DRAKE	MOSELEY
AMECO	ENCOMM	NYE
AMERITRON	HUSTLER	PALOMAR
ANTEK	ICOM	RADIO CALLBOOK
ARRL	JANEL	ROBOT
ASTRON	KANTRONICS	ROHN
ANTENNA	KDK	TELEX / HYGAIN
SPECIALISTS	KLM	TEN-TEC
B & W	LARSEN	TRIO-KENWOOD
BENCHER	MFJ	UNADILLA / REYCO
BUTTERNUT	MINI-PRODUCTS	YAESU
CUSHCRAFT	MIRAGE	
DIAWA		

✓ 102

Write today for our latest
Bulletin/Used Equipment List.

SELECTION
S-E-R-V-I-C-E
and
SATISFACTION!

STORE HOURS:
9-5 P.M. (CST)
MONDAY thru FRIDAY
OPEN SATURDAYS
from 9-1 P.M. (CST)
CLOSED
SUNDAYS/HOLIDAYS



P.O. Box 73
208 East Kemp
Watertown, SD 57201

Burghardt INC.

AMATEUR CENTER

"AMERICA'S MOST RELIABLE AMATEUR RADIO DEALER"

SELL-TRADE

New & Reconditioned HAM EQUIPMENT

Call or Write Us Today For a Quote!
You'll Find Us to be Courteous, Knowledgeable
and Honest

PHONE (605) 886-7314

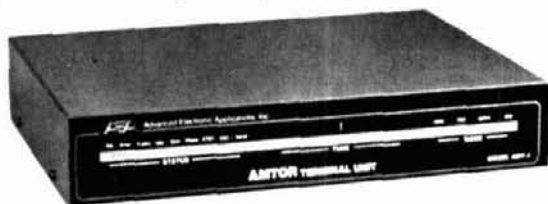

AEA AMT-1. REGULARLY \$479.95
NOW ONLY \$299.95

THE AMTOR TERMINAL UNIT!!! Works with any
ASCII terminal or personal computer with a terminal
program. Also works RTTY, CW, ASCII.
ORDER YOURS TODAY! Limited quantities.

NEW



FULLY
REVISED
Second
Edition

BEVERAGE ANTENNA HANDBOOK by Vic Misek, W1WCR

Recognized around the world as the definitive work on Beverage Antennas. W1WCR has spent countless hours developing new antenna ideas and optimizing the SWA (Steerable wave antenna.) Misek delves deep into the secrets of the single wire Beverage with helpful hints and tips on how to maximize performance based upon wire size, height above ground, overall length and impedance matching. Also includes information on center fed Beverages constructed out of several wire types. **CITY LOT OWNERS** Note: Misek has developed a Beverage for you too! Called the Micro-SWA, it is just 60 ft long. You get excellent directivity and null steering capabilities. Transformer design information for both termination and feedline matching is completely revised. © 1987 80 pages 2nd Edition

VM-BAH Softbound \$14.95

COMING SOON!!!
ON4UN's New LOW FREQUENCY DX'ING book.
Availability expected in July 1987.

Stay tuned for details...
Please enclose \$3.50 for shipping and handling

TRANSMISSION LINE TRANSFORMERS

by Jerry Sevick, W2FMI

Available in June from ARRL. Everything you need to know
about transmission line transformers. 144 pages

AR-TLX Hardbound \$9.95



ham
radio BOOKSTORE
GREENVILLE, NH 03048 603-878-1441

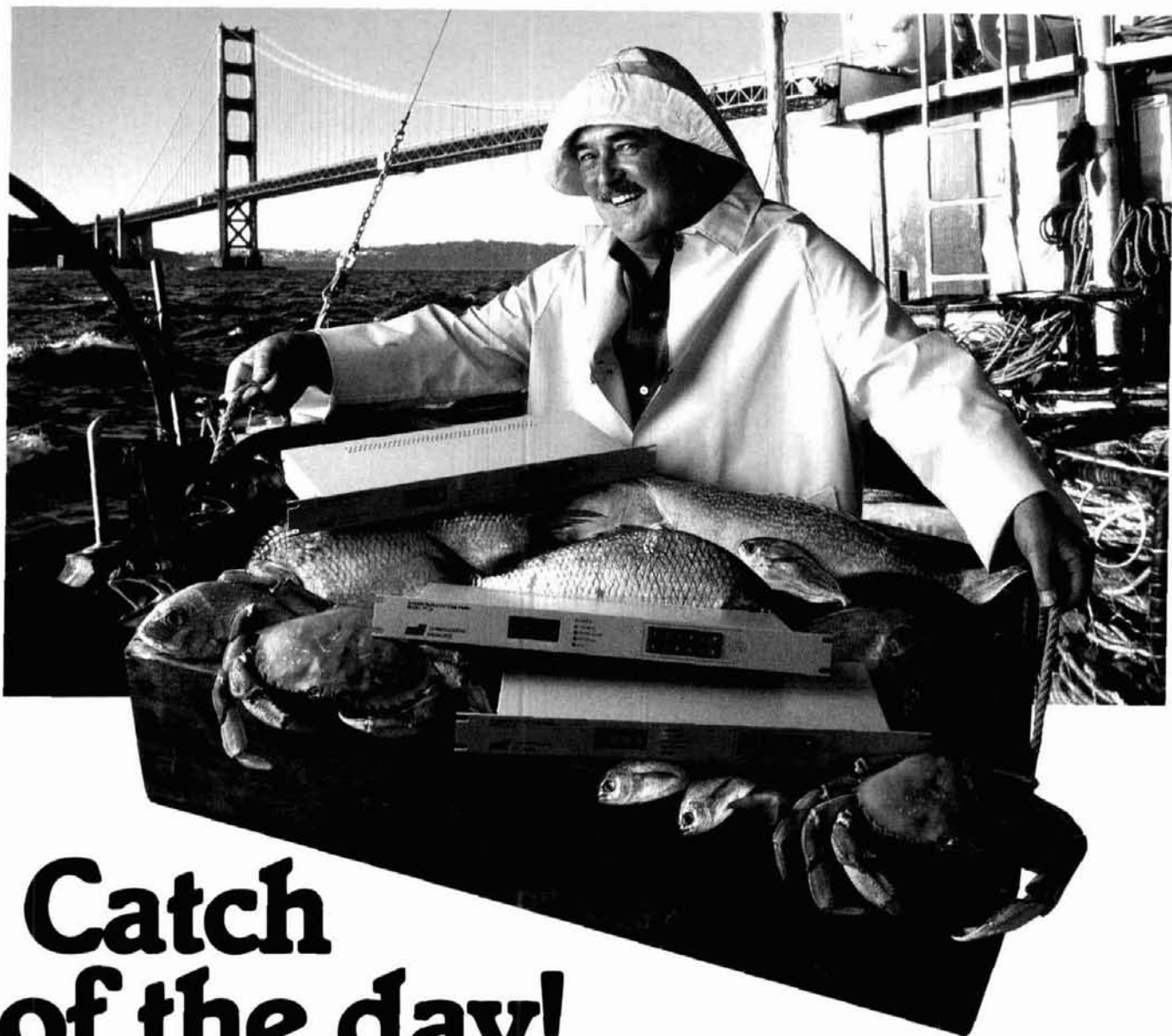

Catch of the day!

Have you been trawling the bounding main for a new product? We have just netted it—the TP-38 microprocessor controlled community repeater panel which provides the complete interface between the repeater receiver and transmitter. Scuttle individual tone cards, all 38 EIA standard

CTCSS tones are included as well as time and hit accumulators, programmable timers, tone translation, and AC power supply at one low price of \$595.00. The TP-38 is packed like a can of sardines with features, as a matter of fact the only additional option is a DTMF module for \$59.95. This module allows complete offsite remote control of all TP-38 functions, including adding new customers or deleting poor paying ones, over the repeater receiver channel.

Other features include CMOS circuitry for low power consumption, non-volatile memory to retain programming if power loss occurs, immunity to falsing, programmable security code and much more. The TP-38 is backed by our legendary 1 year warranty and is shipped fresh daily. Why not set passage for the abundant waters of Communications Specialists and cast your nets for a TP-38 or other fine catch.

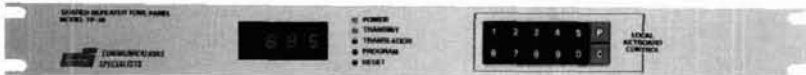

\$595.00 each
\$59.95 DTMF module



Introducing all-mode radios for your mode of travel.

Yaesu's 2-meter FT-290R and 6-meter FT-690R Mark II Series are the perfect all-mode traveling companions.

On the road, simply snap on the heat sink, apply 12 volts of power, and you've got a 25-watt mobile station. (FT-690R: 10 watts).

On foot, attach the optional C-cell battery pack and shoulder strap, and take off with 2.5 watts RF output.

You get around fast on SSB, CW and FM with ten memories, dual VFOs, LCD display, automatic storage of repeater shift into memory register, offset tuning during receive or transmit for satellite operation, relative power output/S-meter, and optional CTCSS unit.

And everything fits into a lightweight-yet-rugged case, measuring just 2¼ x 6½ x 8¼ inches.

The FT-290R and FT-690R Mark II are perfect for emergency use, camping trips, talking around town, and DX work.

Plus each is priced to maximize your ham budget's mileage.

So discover Yaesu's 2-meter FT-290R Mark II and 6-meter FT-690R Mark II all-mode transceivers today. They're just a quick trip away at your nearest Yaesu dealer.

YAESU

Yaesu USA 17210 Edwards Road, Cerritos, CA 90701 (213) 404-2700
Repair Service: (213) 404-4884 Parts: (213) 404-4847

Yaesu Cincinnati Service Center 9070 Gold Park Drive, Hamilton, OH 45011 (513) 874-3100

Prices and specifications subject to change without notice.

KENWOOD

NEW!
Computer Interface

“DX-cellence!”

TS-940S

The new TS-940S is a serious radio for the serious operator. Superb interference reduction circuits and high dynamic range receiver combine with superior transmitter design to give you no-nonsense, no compromise performance that gets your signals through! The exclusive multi-function LCD sub display graphically illustrates VBT, SSB slope, and other features.

- **100% duty cycle transmitter.** Super efficient cooling system using special air ducting works with the internal heavy-duty power supply to allow continuous transmission at full power output for periods exceeding one hour.
- **High stability, dual digital VFOs.** An optical encoder and the flywheel VFO knob give the TS-940S a positive tuning “feel!”
- **Graphic display of operating features.** Exclusive multi-function LCD sub-

display panel shows CW VBT, SSB slope tuning, as well as frequency, time, and AT-940 antenna tuner status.

- **Low distortion transmitter.** Kenwood's unique transmitter design delivers top “quality Kenwood” sound.
- **Keyboard entry frequency selection.** Operating frequencies may be directly entered into the TS-940S without using the VFO knob.
- **QRM-fighting features.** Remove “rotten QRM” with the SSB slope tuning, CW VBT, notch filter, AF tune, and CW pitch controls.
- **Built-in FM, plus SSB, CW, AM, FSK.**
- **Semi or full break-in (QSK) CW.**
- **40 memory channels.** Mode and frequency may be stored in 4 groups of 10 channels each.
- **Programmable scanning.**
- **General coverage receiver.** Tunes from 150 kHz to 30 MHz.
- **1 yr. limited warranty.** Another Kenwood First!

Optional accessories:

- AT-940 full range (160-10m) automatic antenna tuner
- SP-940 external

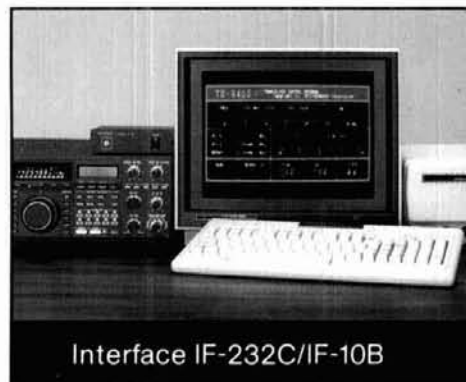

speaker with audio filtering • YG-455C-1 (500 Hz), YG-455CN-1 (250 Hz), YK-88C-1 (500 Hz) CW filters; YK-88A-1 (6 kHz) AM filter • VS-1 voice synthesizer • SO-1 temperature compensated crystal oscillator • MC-43S UP/DOWN hand mic. • MC-60A, MC-80, MC-85 deluxe base station mics. • PC-1A phone patch • TL-922A linear amplifier • SM-220 station monitor • BS-8 pan display • SW-200A and SW-2000 SWR and power meters.



Complete service manuals are available for all Trio-Kenwood transceivers and most accessories. Specifications and prices are subject to change without notice or obligation.



More TS-940S information is available from authorized Kenwood dealers.

KENWOOD

KENWOOD U.S.A. CORPORATION
Communications & Test Equipment Group
2201 E. Dominguez St., Long Beach, CA 90810