

New...  
Ham Radio Bulletin Board

# HAM RADIO



*Maritime Mobiles  
Need Simple Rigs  
and Good Installations*

*Digital Signal Processing  
Part 1 The Fundamentals*

*Trap Dipole for 12 and 17 meters*



ICOM

IC-970 All Mode Transceiver

# Tomorrow's Transceiver Today.



## The New IC-970

Designed for the serious operator on 144, 440 and 1200MHz, ICOM's IC-970 brings futuristic technology to DX, digital and satellite communications.

### Versatile Communications.

The IC-970 comes fully equipped as an all mode dual bander for 144MHz and 440MHz. Expand your limits on 1200MHz with the optional UX-97 band unit or listen to the world with the UX-R96 50-905MHz receive unit.

### Satellite Communications.

Reach beyond the stars, communications via satellite has never been easier. The amazing IC-970 automatically tracks uplink and downlink frequencies as the tuning control

is rotated. Ten memory channels specially designed for quick satellite communications emphasize ICOM's total commitment to your future communications needs.

### Progressive Quality Throughout.

Dual band watch lets you receive both main and sub band audio simultaneously. Multiple scanning systems on the main and sub bands, plus 99 memories, an easy-to-read multi-function display and ICOM's DDS system create the transceiver of tomorrow. Additional features include a built-in pager, code squelch function, direct keyboard entry and ICOM's CI-V system.

See tomorrow's transceiver today at

your local ICOM dealer. You'll see why the IC-970 is the transceiver of a new generation!

CORPORATE HEADQUARTERS  
ICOM America, Inc. 2380-116th Ave. N.E. Bellevue, WA 98004  
Customer Service Hotline (206)454-7619  
CUSTOMER SERVICE CENTERS  
3150 Premier Drive, Suite 126 Irving, TX 75063  
1777 Phoenix Parkway, Suite 201, Atlanta, GA 30349  
3071 - #5 Road, Unit 9, Richmond, B.C. V6X 2T4 Canada  
2380-116th Ave. N.E., Bellevue, WA 98004

All stated specifications are subject to change without notice or obligation. All ICOM radios significantly exceed FCC regulations limiting spurious emissions. 970190

For a brochure on this or any other ICOM product, call our Toll-Free Literature Request Hotline 1-800-999-9877.

**ICOM**  
First in Communications

# INTRODUCING AEA'S NEW ATV SYSTEM

Add a new dimension to your amateur radio communications with AEA's Amateur Television (ATV) system. If you hold at least a technician-class license, you can transmit and receive live or taped audio and video Fast-Scan TV (FSTV) information that rivals broadcast quality. Now you can share more than conversation over the air with this new mode of "personal communications."

## It's Easy and Inexpensive.

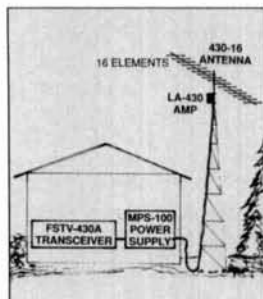

If you have a video camera or camcorder and a standard TV set, you may already own the most expensive components of an ATV system. AEA's ATV system includes a transceiver and antenna. Simply connect the camera, TV and the antenna to the transceiver, and you're on the air LIVE with one watt P.E.P.! Your TV set will

monitor your transmitted and received pictures. If you want to broadcast with more power, AEA also offers a 50 watt mast-mounted linear amplifier with power supply.

**The FSTV-430A Transceiver** features a low-noise UHF GaAsFET preamp with a typical noise figure of less than 1.5dB and a crystal-controlled or variable tuning down converter. Output is available on channel 3 or 4 for signal reception AND monitoring transmissions. Two frequencies can be selected from the front panel for transmission (one crystal is included). The AEA design is also optimized for superior video and audio quality without sync buzz even with weak signals. The FSTV-430A is the only transceiver you need to work ATV and it also allows you to use the same TV set to monitor your transmitted and received pictures.

**The LA-430/50 Amplifier with Power Supply** gives a boost to your ATV signal. It includes a 50W P.E.P. mast-mounted Linear Amplifier (patent pending) covering 420 to 450 MHz and a GaAsFET preamp which utilize the antenna feedline for DC power. The mast-mount eliminates the line loss between the amplifier/preamplifier and the antenna to improve both transmission and reception, and is the equivalent of a 100W amplifier in the shack with a 3dB line loss. The amplifier is housed in a weather-resistant anodized aluminum case. The MPS-100 power supply also provides a 13.6 volt output for the FSTV-430A.

**The 430-16 Antenna** is a high-performance, computer-optimized yagi specifically designed for ATV operation. It features broadband frequency coverage from 420 to 440 MHz, 14.3dB gain, O-ring sealed connectors, 28 degree E plane and 32 degree H plane beam widths and 16 elements on a 10-foot boom.

See AEA's FSTV System at your local authorized AEA dealer. Put yourself in the ATV picture and join the fun!



## What is the advantage of Vestigial Sideband (VSB)?

AEA's FSTV-430A Vestigial Sideband operation drastically reduces adjacent-channel interference. VSB requires much less bandwidth than existing double-sideband designs; it's the standard method of modulation required by the FCC for all U.S. broadcast TV stations. Similar in principle to SSB, VSB puts all of the audio energy and most of the video in ONE sideband instead of two. Using about half the spectrum space of competitive units, the FSTV-430A is the ONLY ATV unit that conserves spectrum space by using VSB. Even with AEA's LA-430/50 amplifier, one sideband is reduced more than 30dB. VSB presents an obvious advantage to the bandwidth-conscious ATV operator.

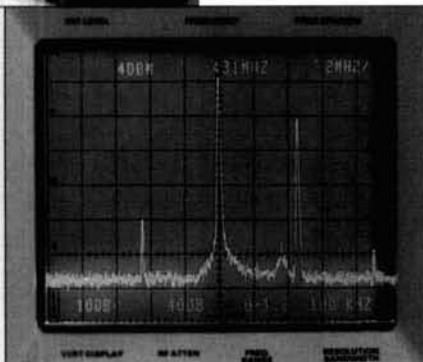

## Advanced Electronic Applications, Inc.

2006-196th St. SW/P.O. Box 2160 Lynnwood, WA 98036 206-775-7373

Prices and specifications subject to change without notice or obligation. Dealer inquiries invited. Copyright 1989.

**AEA Brings You  
A Better Experience.**



# KENWOOD

## The DXpeditioner!

### TS-440S

Compact high performance HF transceiver with general coverage receiver

Portable reliable performance and ease of use makes the TS-440S your obvious "low bands" choice. It is "Every Ham's" rig to go - ham shack, portable or mobile. But don't let the small size fool you - there's lots of "big rig" performance packed into this package. Built-in antenna tuner option. Continuous duty transmitter. Super DynaMix™ front end. Five filter functions. The TS-440S is at your service wherever you wish to operate.

- **Covers all Amateur bands**  
General coverage receiver tunes from 100 kHz-30 MHz. Easily modified for HF MARS operation.
- **Direct keyboard entry of frequency**
- **All modes built-in**  
USB, LSB, CW, AM, FM, and AFSK. Mode selection is verified in Morse Code.
- **VS-1 voice synthesizer (optional)**
- **Built-in automatic antenna tuner (optional)**. Covers 80-10 meters.
- **5 IF filter functions**
- **Superior receiver dynamic range**  
Kenwood DynaMix™ high sensitivity direct mixing system ensures true 102 dB receiver dynamic range. (500 Hz bandwidth on 20 m.)
- **100% duty cycle transmitter**  
Super efficient cooling permits continuous key-down for periods exceeding one hour. RF input power is rated at 200 W PEP on SSB. 200 W DC on CW, AFSK, FM, and 110 W DC AM. (The PS-50 power supply is needed for continuous duty.)
- **Computer interface port**
- **Adjustable dial torque**
- **100 memory channels**  
Frequency and mode may be stored in 10 groups of 10 channels each. Split frequencies may be stored in 10 channels for repeater operation.
- **TU-8 CTCSS unit (optional)**



- **MC-43S UP/DOWN mic. included**
- **Superb interference reduction**  
IF shift, tuneable notch filter, noise blanker, all-mode squelch, RF attenuator, RIT/XIT, and opt. filters fight QRM.
- **Dual SSB IF filtering**  
A built-in SSB filter is standard. When an optional SSB filter (YK-88S or YK-88SN) is installed, dual filtering is provided.
- **VOX, full or semi break-in CW**
- **AMTOR compatible**



#### Optional accessories:

- **AT-440** internal auto. antenna tuner (80 m - 10 m)
- **AT-250** external auto. tuner (160 m - 10 m)
- **AT-130** compact mobile antenna tuner (160 m - 10 m)
- **IF-232C/IC-10** level translator and modem IC kit
- **PS-50** heavy duty power supply
- **PS-430** DC power supply
- **SP-430** external speaker
- **MB-430** mobile mounting bracket
- **YK-88C/88CN** 500 HZ/270 Hz CW filters
- **YK-88S-88SN** 2.4 kHz/1.8 kHz SSB filters
- **MC-60A/80/85** desk microphones
- **MC-55** (8P) mobile microphone
- **HS-4/5/6/7** headphones
- **SP-41/50B** mobile speakers
- **MA-5/VP-1** HF 5 band mobile helical antenna and bumper mount
- **TL-922A** 2 kw PEP linear amplifier
- **SM-220** station monitor (no pan display)
- **VS-1** voice synthesizer
- **TU-8** CTCSS tone unit
- **PG-2C** extra DC cable.

KENWOOD U.S.A. CORPORATION  
COMMUNICATIONS & TEST EQUIPMENT GROUP  
P.O. BOX 22745, 2201 E. Dominguez Street  
Long Beach, CA 90801-5745  
KENWOOD ELECTRONICS CANADA INC.  
P.O. BOX 1075, 959 Gana Court  
Mississauga, Ontario, Canada L4T 4C2

# KENWOOD

...pacesetter in Amateur Radio



# HAM RADIO



WB6VPX, page 9



KB8ZW, page 79

APRIL 1990  
Volume 23, Number 4

**Publisher & Editor-in-Chief:**  
T.H. TENNEY, JR., W1NLB

## EDITORIAL STAFF

**Editor:**  
TERRY NORTHUP, KA1STC

**Consulting Technical Editors:**  
Marty Durham, NB1H  
David McLanahan, WA1FHB  
Alfred Wilson, W6NIF  
Robert D. Wilson, WA1TKH

**Associate Editors:**  
Peter Bertini, K1ZJH  
Tom McMullen, W1SL  
Joseph J. Schroeder, W9JUV

**Production Editor:** Susan Shorrock  
**Copy Editor:** Peggy Tenney, KA1QDG  
**Editorial Assistant:** Beth McCormack

## Editorial Review Board:

Forrest Gehrke, K2BT  
Michael Gruchalla, P.E.  
Hunter Harris, W1SI  
Bob Lewis, W2EBS  
Mason Logan, K4MT  
Vern Riportella, WA2LQQ  
Ed Wetherhold, W3NQN

## PUBLISHING STAFF

**Assistant Publisher:**  
J. CRAIG CLARK, JR., NX1G

**Advertising Manager:**  
Marty Durham, NB1H

**Advertising Production Manager:**  
Dorothy Sargent, KA1ZK

**Circulation Manager:** Susan Shorrock  
**Circulation:** Marion Tuttle

**Traffic Manager:** Phil Alix, N1FPX

**Book Store:** Priscilla Gauvin

**Cover photo:** Photo courtesy of the Hinckley Company, Southwest Harbor, Maine. Talaria, a Hinckley Sou'wester 51 sloop, is pictured here sailing off the Florida coast. Later renamed Skipjack, the sloop won the Bermuda One Two Race in 1989.

## FEATURES

<b>MARITIME MOBILES NEED SIMPLE RIGS AND GOOD INSTALLATIONS</b>	9
<i>Clyde Kirlin, WB6VPX</i>	
<b>Microwaves: OPTICAL RECEIVER</b>	14
<i>Bob Atkins, KA1GT</i>	
<b>The Weekender: A 220-MHZ RECEIVING ADAPTER</b>	20
<i>Peter J. Bertini, K1ZJH</i>	
<b>DIGITAL SIGNAL PROCESSING PART 1: THE FUNDAMENTALS</b>	24
<i>Bryan P. Bergeron, NU1N</i>	
<b>Practically Speaking: SOME ANALOG METER APPLICATIONS</b>	36
<i>Joseph J. Carr, K4IPV</i>	
<b>INSTRUMENTATION SERIES: OSCILLOSCOPES</b>	49
<i>Denton Bramwell, K7OWJ</i>	
<b>SKYWAVE COMMUNICATIONS, PART 2</b>	60
<i>Cornell Drentea, WB3JZO</i>	
<b>Ham Radio Techniques: THE YAGI OPTIMIZER</b>	68
<i>Bill Orr, W6SAI</i>	
<b>The Weekender: THE SUPERDISCHARGER</b>	73
<i>W.C. Cloninger, Jr., K3OF</i>	
<b>OUTSTANDING 144-MHZ EME ACHIEVEMENT</b>	79
<i>Bill Takacs, KB8ZW</i>	
<b>Elmer's Notebook: ELEMENTARY ELECTRONICS: INDUCTORS AND AC</b>	84
<i>Tom McMullen, W1SL</i>	

## DEPARTMENTS

<b>BACKSCATTER</b>	4	<b>FLEA MARKET</b>	82
<b>COMMENTS</b>	6	<b>DX FORECASTER</b>	88
<b>HAM NOTEBOOK</b>	58	<b>ADVERTISERS INDEX</b>	90
<b>HAM RADIO</b>		<b>READER SERVICE</b>	90
<b>BULLETIN BOARD</b>	66		

HAM RADIO Magazine (ISSN 0148-5989) is published monthly by Communications Technology, Inc. Main Street, Greenville, New Hampshire 03048-0498 Telephone: 603-878-1441 FAX: 603-878-1951. **Subscription Rates:** United States: one year, \$22.95; two years, \$38.95; three years, \$49.95; Canada and Mexico: one year, \$31.00; two years, \$55.00; three years, \$74.00. All other countries: one year, \$35.00 via surface mail only. All subscription orders payable in U.S. funds, via international postal money order or check drawn on U.S. bank. **International Subscription Agents:** page 81.

Microfilm copies are available from Buckmaster Publishing Mineral, Virginia 23117. Cassette tapes of selected articles from HAM RADIO are available to the blind and physically handicapped from Recorded Periodicals, 919 Walnut Street, Philadelphia, Pennsylvania 19107.

Copyright 1990 by Communications Technology, Inc. Title registered at U.S. Patent Office.

Second-class postage paid at Greenville, New Hampshire 03048-0498 and at additional mailing offices. Send change of address to HAM RADIO, Greenville, New Hampshire 03048-0498.

# Backscatter



## Life, Liberty, and the Right to Privacy

Have you ever wondered about a QSO in progress? Have you ever thought to yourself in the middle of a transmission, "Is this subject really appropriate for Amateur Radio?" Obviously, business communications are forbidden. But common sense also dictates that there are plenty of subjects best left to other methods of communication — like the telephone. Or are they?

An interesting case has come to light in Iowa concerning police monitoring of cordless telephone conversations. The November 29, 1989 edition of *The Wall Street Journal* reported that the Scott County Iowa Sheriff monitored a family's cordless telephone conversations over a 9-month period. This monitoring led to a 10-year sentence for conspiracy and theft. The family, in turn, has sued the sheriff for violating their constitutional right to privacy. In fact, they asked the Supreme Court to determine whether or not Fourth Amendment protection against unreasonable searches and seizures applied. Though the Supreme Court has decided not to hear the case, this story isn't over yet.

According to the *Journal*, lower court precedents don't favor Fourth Amendment protection for cordless telephones. They do apply, however, for more *technically sophisticated* cellular and wireless telephone conversations. Because the technology used for cordless telephones makes the calls easy to intercept, users shouldn't expect protection. The cellular telephone industry was able to ram legislation through Congress that could bring an all expenses paid "vacation" at the Allenwood, Pennsylvania Federal Correctional Facility for anyone hearing even the mere whisper of a cellular telephone conversation. To me this conjures up images of police raids on families huddled around TV sets scanning channels 70 to 83 in search of "neat" cellular conversations. While I shudder at the thought of people with paper pads and tape recorders ready to copy juicy tidbits of information, I hate to think that "Big Brother" might be looking over their shoulders while they do so.

This legislation is an example of a law which criminalizes an act that can't, in any way, be enforced. As a young ham, I feared the FCC. I was afraid that any indiscretion, even my beginner's sloppy fist, would bring the "radio police" to my door with a warrant for my arrest. In all practicality it wasn't going to happen, but I was still scared.

So what's the real scoop? Where should the line be drawn regarding what is and what isn't constitutionally protected in Amateur Radio conversations? For us radio Amateurs, the fight for privacy in communications will have little impact. However, it's always good to be reminded that when we talk, *many are listening*. A casual comment about going away for a weekend could result in a house break-in, or worse. There are millions of radios, scanners, and other types of equipment out there that can tune into Amateur communications.

It will be interesting to see if this matter is brought before the Supreme Court again. Hypothetically, if the case were to receive a favorable judgment, one could conjecture that all radio communications would enjoy protection. That would mean that you could call, but nobody could listen. Just think of it; the ham bands would be filled with endless CQs, and not one answer! *Is this scenario off the wall? Yes. Is it probable? No. Well...maybe?*

de NX1G

# KENWOOD

## Stacked in your favor!

### TM-231A/ 331A/431A/531A

#### FM Mobile Transceiver

Looking for a compact transceiver for your mobile VHF and UHF operations? KENWOOD has a compact rig for each of the most popular VHF/UHF bands.

- 20 multi-function memory channels.
- High performance — high power! 50W (TM-231A), 35W (TM-431A) with a 3 position power switch.
- Optional full-function remote controller (RC-20).

A full-function remote controller can be mounted in any convenient location. Using the IF-20 interface the RC-20 may be connected to four mobile transceivers. (TM-231A/431A/531A or the TM-701A).

- Multi-function microphone supplied. Various controls are provided on the mic. for increased utility.
- Auto repeater offset on 144 and 220 MHz.
- Built-in digital VFO allows selection of the frequency step. (5, 10, 15, 20, 12.5, 25kHz; TM-531A: 10, 20, 12.5, 25kHz.)
- Selectable CTCSS tone built-in.
- Tone alert system — for true "quiet monitoring"! When enabled this function will activate a tone when squelch opens.
- DRS (Digital recording system). The optional DRU-1 can store received and transmitted messages for up to 32 seconds, allowing the operator to check or return any call using the tone alert system.
- Automatic lock tuning function (TM-531A).
- Repeater reverse switch.

#### Optional Accessories:

- RC-20 Full-function remote controller
- RC-10 Handset
- IF-20 Interface unit handset
- DRU-1 Digital recording unit
- MC-44 Multi-function hand mic.
- MC-44DM Multi-function hand mic. with auto-patch
- MC-48B 16-key DTMF hand mic.
- MC-55 8-pin mobile mic.
- MC-60A/80/85 Desktop mics.
- MA-700 Dual band (2m/70cm) mobile antenna (mount not supplied)
- SP-41 Compact mobile speaker
- SP-50B Mobile speaker
- PS-430 Power supply
- MB-201 Mobile mount
- PG-2N Power cable
- PG-3B DC line noise filter

- PG-4H Interface connecting cable
- PG-4J Extension cable kit
- TSU-6 CTCSS unit

KENWOOD U.S.A. CORPORATION  
COMMUNICATIONS & TEST EQUIPMENT GROUP  
P.O. BOX 22745, 2201 E. Dominguez Street  
Long Beach, CA 90801-5745  
KENWOOD ELECTRONICS CANADA INC.  
P.O. BOX 1075, 959 Gana Court  
Mississauga, Ontario, Canada L4T 4C2

## KENWOOD

...pacesetter in Amateur Radio

Complete service manuals are available for all Kenwood transceivers and most accessories. Specifications, features and prices are subject to change without notice or obligation.



# Comments



## Lose some..win some!

Dear HR

I wanted to write to you and express my pleasure that you have picked up Bob Atkins, KA1GT, to write a new microwaves column. I was very sorry to see W1JR drop out, but I'm sure Bob's column will be every bit as interesting. This was the first column I would turn to in *QST* to read. So their loss is your gain!

Keep up the good work at publishing the best ham magazine available.

I might also suggest that possibly an ATV column would be nice. Perhaps W6ORG, Tom O'Hara, or KB9FO, Henry Ruh, would consider being contributing editors.

Again I'm very happy to see a microwaves column.

**Dave Williams, WB0ZJP**  
St. Louis, Missouri

## Early radar buff

Dear HR

"Understanding Over-the-Horizon Radar," *Ham Radio*, February 1990, brought back memories of field testing early warning radar SCR270 in the Signal Corps the summer of 1941 on Sandy Hook, New Jersey. It operated around 106 MHz and if the planes and thunderstorms were high enough it would reach out 100 miles or so. Not exactly over-the-horizon but a good radar application at the time. I understand from Dick Aspinwall, W7PV, that there is a museum where this equipment is on display along with the SCR584, an "S" band microwave radar Gunn director, that I later worked on.

Keep up the good work.

**Wayne W. Cooper AG4R**  
Miami Shores, Florida

## A good time to upgrade

Dear HR

I feel compelled to respond to N6SWA's "pet peeve" expressed in the February "Comments," regarding higher class licensees operating in the Novice/Technician 10-meter phone band.

I'm sorry, but I can't sympathize with him. Since the expansion of the 10-meter phone band, the majority of the "rarer" DX stations have been operating below 28.5 MHz. With the excellent propagation we are experiencing at the peak of the sunspot cycle, Novice/Techs have an unprecedented opportunity to take part in some of the best worldwide communications conditions we have had in many years. In six months it should be possible to work DXCC with 100 watts and a dipole with a little effort.

However, these conditions are not going to last, and will decline over the next couple of years. As an avid DXer, I am certainly not about to miss taking part in the peak activity and will operate wherever the DX is, with 100 watts if that will do, or a kilowatt if necessary.

Even under very good propagation conditions 28.3 to 28.5 has plenty of elbow room. And 200 kHz is more than most of us can operate on the other HF phone bands (except 15 meters). I have never heard QRM on 10 that comes close to what you'll find on 20 meters.

The best solution for the Novices and Techs that feel inhibited with their band allocations is, of course, to upgrade. I empathize with the Techs that have a problem with code (note that I don't have a 2X1 call) but with effort most people can make 13 wpm. Thanks to the question pool being

"Bashed" a few years ago, the General Class (and higher) theory is now easily passed by anyone who is willing to read and memorize for a dozen or so evenings, with no real need for comprehension.

As further incentive, newcomers to the HF bands should be aware that it won't be very long until 10 meters will only be good for talking across town, and a sporadic E opening to another state will be a big deal. So "kwitchebellyakin," upgrade, and be ready to put up with some real QRM when 20 is the only band open and everyone is crowded into 200 kHz.

**Bruce Sanborn, KB2WN**  
Rochester, New York

## On the mark

Dear HR

I wish to comment on "Elmer's Notebook" in the January issue of *Ham Radio*. It is by far the best review on "resistance" I have ever read and has a very positive outline on the basics of the subject.

Thanks again for this and many other articles you have written. I look forward to "Elmer's Notebook" each month.

**Stuart J. Tuma, W1QXS,**  
Melrose, Massachusetts

Dear HR

I receive *Ham Radio* magazine every month, and look forward to each magazine with anticipation. I am a project builder and enjoy all the articles.

My wife gives me the magazine every year as a Christmas present. You and your staff are to be congratulated on a very fine magazine. Keep up the fine work.

**Phil Fuglsaug, WD0HXY**  
Imperial, Missouri

# KENWOOD

## TM-731A/631A 144/450 and 144/220 MHz FM Dual Banders

- **Extended receiver range** (136.000 – 173.995 MHz) on 2 m; 70 cm coverage is 438.000 – 449.995 MHz; 1-1/4 m coverage is 215 – 229.995 MHz. (Specifications guaranteed on Amateur bands only. Two meter transmit range is 144 – 148 MHz. Modifiable for MARS/CAP. Permits required.)
- **Separate frequency display** for "main" and "sub-band."
- **Versatile scanning functions.** Dual scan, and carrier and time operated scan stop.
- **30 memory channels.** Stores everything you need to make operating easier. Two channels for "odd splits."
- **50 Watts on 2 m, 35 watts on 70 cm, 25 watts on 1-1/4 m.** Approx. 5 watts low power.
- **Automatic offset selection.**
- **Dual antenna ports.**
- **Automatic Band Change (A.B.C.)** Automatically changes between main and sub-band when a signal is present.
- **Dual watch function** allows VHF and UHF receive simultaneously.
- **CTCSS encode/decode** selectable from front panel or UP/DWN keys on microphone. (Encode built-in, optional TSU-6 needed for decode.)
- **Balance control and separate squelch controls** for each band.

- Full duplex operation.
- Dimmer switch.
- 16 key DTMF/control mic. included.
- Frequency (dial) lock.

### Optional Accessories:

- **PG-4H** Extra interface cable for IF-20 (for three to four radios)
- **PG-4J** Extension cable kit for IF-20 DC and audio
- **PS-430** Power supply
- **TSU-6** CTCSS decode unit
- **SWT-1** 2 m antenna tuner
- **SWT-2** 70 cm antenna tuner
- **SP-41** Compact mobile speaker
- **SP-50B** Deluxe mobile speaker
- **PG-2N** DC cable
- **PG-3B** DC line noise filter
- **MC-60A, MC-80, MC-85** Base station mics.
- **MA-700** Dual band 2 m/70 cm mobile antenna (mount not supplied)
- **MB-11** Mobile bracket
- **MC-43S** UP/DWN hand mic.
- **MC-48B** 16-key DTMF hand mic.

KENWOOD U.S.A. CORPORATION  
COMMUNICATIONS & TEST EQUIPMENT GROUP  
P.O. BOX 22745, 2201 E. Dominguez Street  
Long Beach, CA 90801-5745  
KENWOOD ELECTRONICS CANADA INC.  
P.O. BOX 1075, 959 Gana Court  
Mississauga, Ontario, Canada L4T 4C2

## KENWOOD

...pacesetter in Amateur Radio

# "Dynamic Duals"

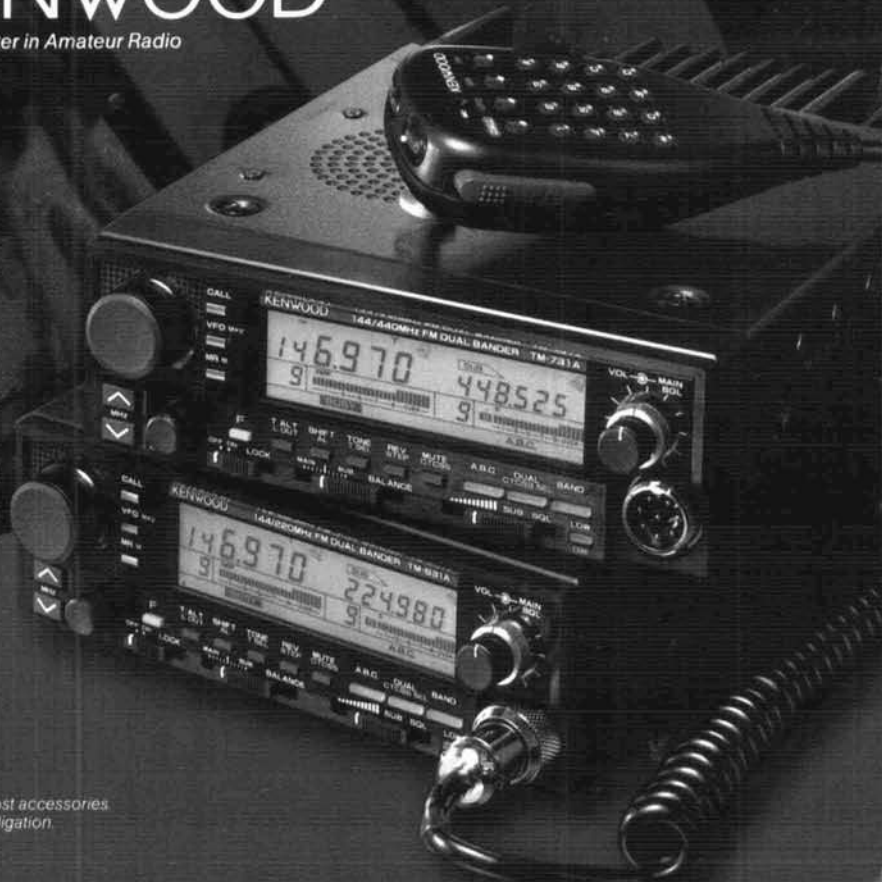

# MFJ gives you *all 9* digital modes and *keeps on* bringing you state-of-the-art advances . . . while others offer you *some* digital modes using 3 year old technology

MFJ-1278  
\$279<sup>95</sup>



No 3 year old technology at MFJ!  
Using the latest advances, MFJ brings you 9 exciting digital modes and *keeps on* bringing you state-of-the-art advances.  
You get tons of features other multi-modes just don't have.

**Only MFJ gives you all 9 modes**  
Count 'em -- you get 9 fun modes -- Packet, AMTOR, RTTY, ASCII, CW, FAX, SSTV, Navtex and full featured Contest Memory Keyer.  
You can't get all 9 modes in *any* other multi-mode at *any* price. Nobody gives you modes the MFJ-1278 doesn't have.

**The best modem you can get**  
Extensive tests in *Packet Radio Magazine* prove the modem used in the MFJ-1278 copies HF packet more accurately than all other modems tested.

MFJ-1278 is the *only* multi-mode with a *true* DCD circuit for HF. This dramatically reduces sensitivity to noise and dramatically increases completed QSOs.

**Exclusive Built in Printer Port**  
Only the MFJ-1278 has a dedicated printer port that lets you plug in your printer.

You don't need to buy an optional \$40 cable just to plug in your printer.

**New Easy Mail™ Personal Mailbox**  
You get MFJ's new Easy Mail™ Personal Mailbox with soft-partitioned memory so you and your ham buddies can leave messages 24 hours a day.

**20 LED Precision Tuning Indicator**  
MFJ's unequalled tuning indicator

makes it really easy to work HF packet.  
And unlike others, you use it exactly the same for all modes -- not differently for each mode. Just tune your radio to center a single LED and you're *precisely* tuned in to within 10 Hz -- and it shows you which way to tune!

**Multi-Gray Level FAX/SSTV Modem**  
You'll see tomorrow's news today when you copy outstanding FAX news photos with crisp, clear details.

MFJ-1278 is the *only* multi-mode with a built-in multi-gray level modem. It lets you transmit and receive high resolution multi-gray level FAX/SSTV pictures with an appropriate terminal program.

or dumb modem, fast throughput anti-collision technology, independent transmit level for each radio port, random code generator, lithium battery backup, RS-232 and TTL serial ports, standard 850 Hz RTTY shift, socketed ICs, tune up command, peripheral I/O port, automatic serial numbering, programmable message memories, dual radio ports (each HF or VHF), CW key paddle jack, speaker jack that lets you monitor CW sidetone, transmit and receive audio and packet connect bell, *new* fully intergrated instruction manual with *Fast Start™* instructions and more in a 9½ x 9½ x 1½ inch cabinet.

**Get on the air instantly**  
Just plug it all in

All you need is an MFJ-1278, your rig, computer and program.

With an MFJ Starter Pack you just plug it all in, wire up your mic connector, and you're on the air.

Order MFJ-1284 for IBM compatibles (includes Picture Passing); MFJ-1287 for Macintosh; MFJ-1282 (disk) for C-64/128; MFJ-1283 (tape) for VIC-20. \$24.95 each.

**No Matter What™ Guarantee**

You get MFJ's one year No Matter What™ Guarantee.

That means we will repair or replace your MFJ multi-mode (at our option) *no matter what* happens to it for a year.

Others give you a *limited* warranty. What do you do when they say, "Sorry, your *limited* warranty doesn't cover that?"

**Get 9 new ways of having fun**

Don't settle for 3 year old technology. Choose the only multi-mode that gives you the latest advances and all 9 modes.

Get 9 new ways of having fun *today!*

## New MFJ-1278T Turbo with fast 2400 baud modem

MFJ-1278T  
\$359<sup>95</sup>



The new MFJ-1278T Turbo gives you fast 2400 baud packet -- *twice* the baud rate of any other multi-mode. By communicating faster you'll reduce chances for error, lessen congestion and more efficiently utilize our ham frequencies. You'll also get 1200/300 baud for compatibility with older TNCs. The 2400 baud modem is also available separately. Order MFJ-2400, \$79.95, for any MFJ and most other TNCs

### One FREE Upgrade!

When you buy your MFJ-1278 *today*, you don't have to miss new modes and features that come out *tomorrow*.

Why? Because your MFJ-1278 comes with a coupon good for one *free* eeprom upgrade exchange that'll add new features.

### Plus More . . .

Plus you get . . . 32K RAM (not 16K), free AC power supply, Host mode that lets MFJ-1278 serve as a KISS interface

## What the ham magazines say about the MFJ-1278:

**QST Magazine:** "I was especially impressed by the new '1278s DCD (data carrier detect) circuit performance. This function, vital to HF packet-radio operation, performs admirably . . . Refinements such as this go a long way toward improving the viability of HF packet-radio operation with a multimode!"

"FAX reception is so good that it is irresistible to tune around for interesting FAX transmissions. The current '1278 provides good copy on all seven supported FAX formats . . . I most enjoyed copying news-photo transmissions. Some of these were outstanding, with crisp, clean reproduction and a surprising amount of detail." **September, 1989.**

**CQ Magazine:** "I found the '1278 did an excellent job (copying CW), even with bad operators. I've checked lot of CW 'copiers' in

my time, and certainly this unit was as good or better than most."

"I switched the terminal mode to HF packet . . . I was very impressed, because with the tuning indicator I immediately received (good) packet copy . . . I (tried) a connect with an east coast station. Before I knew it I had a QSO going and even handled break-in stations anxious to log New Mexico." **May, 1989.**

**73 Magazine:** "If you think I enjoyed using (the MFJ-1278) you are right. It was easy and fun to use . . . Overall, I found the MFJ-1278 to be . . . a good multi-mode controller at a reasonable price. You won't be disappointed." **April, 1989.**

**Worldradio Magazine:** "Bottom line: Excellent value for the money. Solid performer. Easy to use. Easiest of the top three to get on line . . ." **September, 1989.**

MFJ ENTERPRISES, INC.  
P.O. Box 494  
Mississippi State, MS 39762  
Phn: (601) 323-5869; TELEX: 53 4590  
FAX: (601) 323-6551; Include \$5 s/h.  
© 1990 by MFJ Enterprises, Inc.

**MFJ**  
MFJ . . . making quality affordable

For your nearest dealer or to order:

**800-647-1800**

Request your *FREE* MFJ Catalog!



# MARITIME MOBILES

## NEED SIMPLE RIGS AND GOOD INSTALLATIONS

### Sound tips keep maritime operations afloat

By Clyde Kirlin, WB6VPX, P.O. Box 2116, Walnut Creek, California 94595

**S**ailboats and Amateur Radio have been mates afloat for many years. Sailors have frequently explored ocean-going Amateur Radio as a hobby, but in recent years it has been used more as a lower cost substitute for a single sideband (SSB) marine radio. Today's technology makes it easier than ever for the multitasked sailor to use ham gear.

Dial twisting is a thing of the past. Memory bands now hold the frequencies we most commonly use. Microprocessor-controlled automatic antenna tuners quickly adjust for the chosen frequency. Push buttons, rather than analog rotation devices, simplify RF gain, mode selection, and tuning dial adjustments.

While operations are streamlined, good installation practices are often forgotten in the haste to "get on the air." Successfully fitting a radio to a sailboat involves creating a good ground plane, installing an exceptional antenna, and placing the equipment in proper relationship to antenna, ground plane, and power source. Additionally, the operator's transceiver selection process is often affected by brand preference, peer pressure, and impulse buying. Buyers frequently ignore the basic requirements and specifications that comprise a good receiver, as well as available power sources at sea.

### Is the best really the best?

Take the case of my good friend Sam, who was about to fit his sailboat with an ICOM-781. Knowing he was a pragmatist at heart, I felt he had been swayed by the unsurpassed quality and features of the IC-781. Granted, it is a superb transceiver in a base station environment, but it wasn't designed for a sailboat. The IC-781's receiver performance is highly rated and I don't know of any radio that can equal the tricks performed with the IC-781's built-in keyer, filters, and twin passband tuning. Consider, however, what's required to maintain this performance level on a sailboat. Would Sam be using RTTY, AMTOR, and CW at sea? I doubt it. Good voice communications meet most objec-

tives — no need for full break-in, noise blankers, and CW filters in that mode.

Because the 781 operates only on 120 volts AC, a 12-volts DC inverter or fuel-driven AC generator would be needed on a sailboat. A major maker of inverters agreed with my observations that a "demand-type" inverter wouldn't respond quickly enough to the fluctuating power demands of a CW or SSB signal. And who wants to listen to a noisy generator on board while enjoying the pleasure of Amateur Radio? Further, the IC-781's automatic antenna tuner is designed for a 50-ohm output and not suited to match the varying impedance of an unloaded whip or random wire, as would be used on a sailboat.

Several other models using the same upbeat technology, but with simplified operation, stood at the head of the selection line. ICOM's compact IC-725 with its AH-3 automatic tuner\* would be an excellent choice, as would economical performers from Kenwood† and Yaesu‡.

### Many questions and some answers

Sam continued his quest for the best maritime setup with questions on how to create an antenna ground plane, the use of a mobile center-loaded whip or the boat's backstay as an antenna, and antenna length.

In my opinion, receiver specifications come first. The old adage applies, "If you can't hear 'em, you can't talk to 'em." Receiver sensitivities of less than 0.5  $\mu$ V are quite common and most adequate for the quiet atmospheric environment of radio work at sea. Automatic antenna tuners will match almost any wire span that isn't near a half-wave in length in less than three seconds! All the operator needs to do is pick up the microphone and talk.

### What makes a good installation?

A cruising sailboat is usually between 35 and 40 feet long, made of fiber glass, and rigged with one or two masts. Most sailboats carry a set of 12-volt DC batteries which are charged intermittently by the boat's engine alternator. Preplanning the overall installation layout is important. Because the antenna system will be similar to that of a quarter-wave ground plane vertical antenna, the antenna, antenna tuner, and ground plane must be in a reasonable vertical alignment. Mount the antenna tuner in a dry location in the lazarette area under the cockpit. Connect the antenna to the tuner here. The radiation current node

\* ICOM America, 2380 116th Avenue, NE, Bellevue, Washington 98004.

† Kenwood U.S.A. Corporation, PO Box 22745, Long Beach, California 90801-5745.

‡ Yaesu USA, 17210 Edwards Road, Cerritos, California 90701.

TABLE 1

## Antenna Length Calculations

Commonly used Amateur frequencies and the decimal portion of a wavelength that various antenna lengths represent

1. One-half wavelength =  $492/\text{Frequency (MHz)}$
2. One-half wavelength  $\times 2$  = one wavelength (W/L)
3. Antenna length/one wavelength (W/L) = decimal portion of W/L

Frequencies (MHz)	Antenna Lengths in Feet					
	23.00	30.00	35.00	40.00	45.00	50.00
	Wavelengths					
7.25	0.17	0.22	0.26	0.29	0.33	0.37
14.35	0.34	0.44	0.51	0.58	0.66	0.73
21.35	0.50	0.65	0.76	0.87	0.98	1.08
28.35	0.66	0.86	1.01	1.15	1.30	1.44

begins at the tuner output. Keep the portion of antenna wire inside the boat as short as possible to increase power radiation outside the hull.

Radiation resistance is composed of several factors, including ground resistance. Unfortunately, the antenna tuner usually is situated at some point above ground. Make the tuner think that it's sitting in sea water (ground) by using multiple copper ground straps between the tuner and the ground plane. Keep the straps as short as possible to reduce the ground resistance. The transceiver should be located at a convenient operating position, as close as possible to the batteries.

### The antenna selection

Choose an antenna that fits the boat's rigging configuration, but is as long as possible. With today's high aspect ratio of tall mast and short boom, the boat's boom doesn't overhang the stern. This leaves an area for mounting a 23-foot vertical unloaded whip, like a Shakespeare Model 390,\* or a mobile center-loaded whip designed for a specific frequency. Of course, this leaves open for debate the question of insulating the backstay for longer antennas, creating higher efficiency on lower frequencies — versus the possibility of backstay failure in heavy weather.

Being safety minded, I opt for the 23-foot unloaded whip or the mobile center-loaded whip. With either of these, there are cautions to be considered. The 23-foot whip works well on 10, 20, and 40 meters. However, at 15 meters, it's close to one-half wavelength and won't load properly. The mobile whip must be mounted at the stern, using the metallic stern pulpit as a mounting base and possible ground plane. This creates a dangerous situation for the sailor attempting to change loading coils in a heavy seaway. Also, with the pulpit as a ground plane, a portion of the radiation — the lower 2 or 3 feet of the antenna mounting staff — is often wasted because it's sheltered by the ground plane itself.

### How long is a vertical antenna?

The actual antenna length includes the distance from the tip of the antenna, the antenna lead-in to the tuner, through the ground lead from tuner to ground. Because antennas don't load very well at multiples of one-half wavelength, the

formula in Table 1 outlines the calculation of antenna lengths to be avoided.

For 10, 15, 20, and 40-meter operation, insulate the backstay to produce an antenna and ground lead length of 30, 40, or 45 feet. Note that a 35-foot antenna is close to a quarter wavelength at 40 meters — an ideal vertical antenna length. Yet the same antenna crowds the half-wavelength point on 20 meters. The total length from tip to ground should not be a multiple of one-half wavelength for any frequency being used.

### The backstay

The backstay, when used as an antenna, must have strain insulators inserted in the wire. A good backstay insulator must be able to withstand 15-kV breakdown voltage and have the physical strength to endure the rigors at sea. Any backstay insulator work is best left to a professional rigging shop, for both selection and fitting. They must assume the responsibility for insulator failure and possible dismasting.

Have the lower insulator placed in the backstay at a height of 6 feet above the deck level, so those looking for a steady grip at sea don't grab onto an antenna that's radiating power. Make sure there's high voltage insulation (25 to 30 kV) on the antenna lead from the coupler to the insulator.

The placement of the upper insulator depends on the distance between the point where the antenna tuner connects to the ground plane and the upper end of the desired antenna length. To offset any detrimental ground effects that a metal mast introduces to the antenna, a third insulator may be placed at the upper end of the backstay, within a foot or so of the masthead. "Living dangerously?" you ask. "A greater chance for dismasting," you observe. Yes, but this is why the insulator task is best left to professional riggers.

The antenna lead-in from the tuner to the backstay is a piece of high voltage insulated wire like GTO-15 neon sign wire or the polyethylene dielectric core of RG-8/U. One end of the lead-in is secured to the insulated portion of the backstay with U-bolts mounted close to the lower insulator. Wrap the U-bolt clamp with chafe protection. The tuner end of the lead-in is fed through a watertight deck fitting into the lazarette area near the antenna tuner (see Figure 1). If you have a metal deck, use a porcelain feedthrough insulator to keep the antenna lead-in as much as 6 inches from the

\* The Shakespeare Company Antenna Group, PO Box 733, Newberry, South Carolina 29108.

FIGURE 1

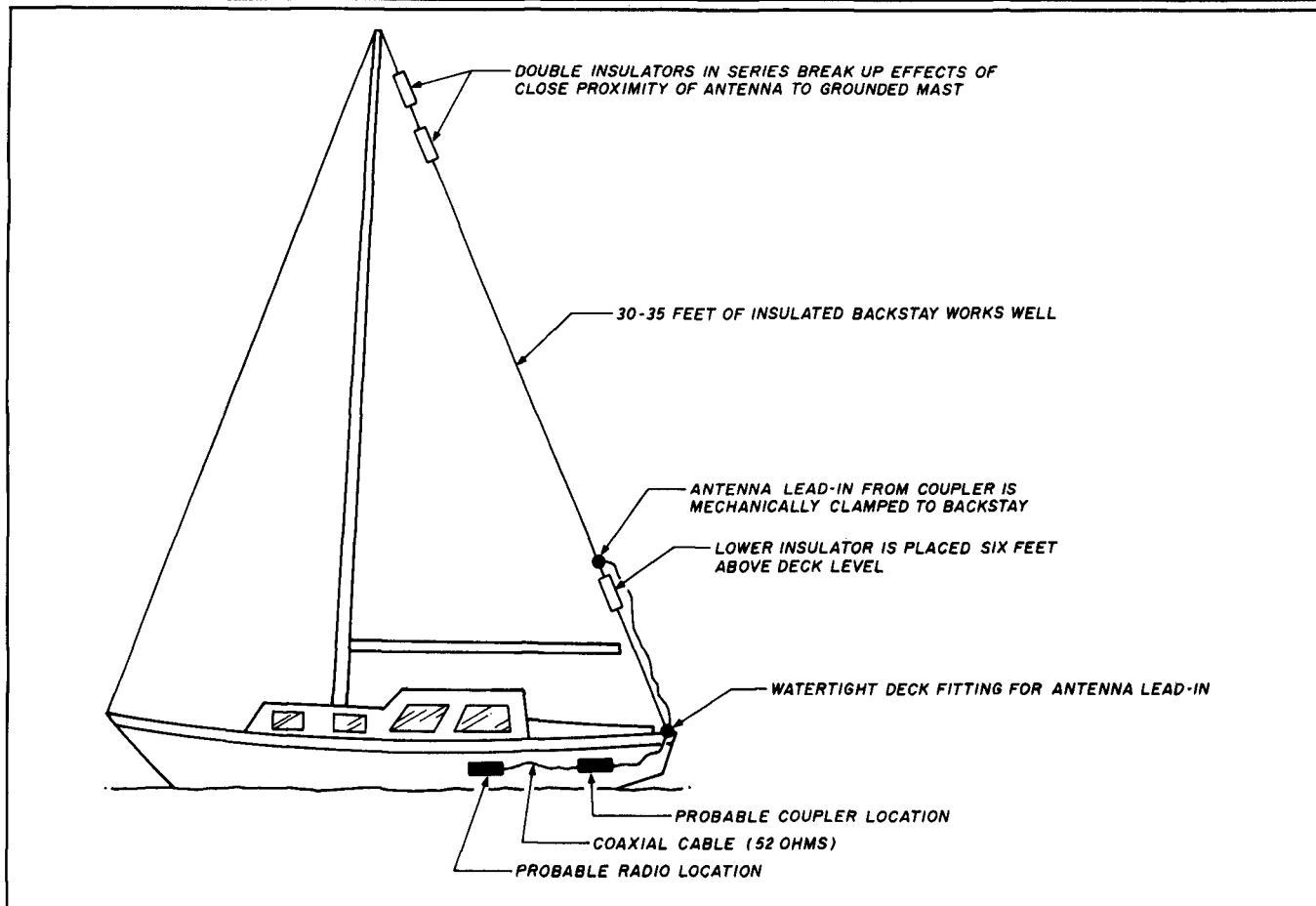

**Pre-planning the overall layout of the antenna system — the antenna, antenna tuner, and ground plane — for best results.**

metal. Also, if the antenna lead-in is to be fixed in place on a metal hull, dress it 6 inches from all metal.

**Creating the ground plane**

What constitutes an adequate ground plane when afloat? Where should it be positioned? How large should it be? What material should be used? The only reasonable location for an antenna on a sailboat is far aft. The antenna, antenna tuner, and ground plane should be in reasonable vertical alignment. The only logical place for the ground plane is aft.

It's difficult to relate the ground plane area afloat with the number and length of radials used ashore. A coupling effect to the water exists if a ground plane is mounted low in the boat. The higher the ground plane is above the water, considering its necessarily limited size, the less efficient the system will be.

The best material for a ground plane on a boat is copper window screen, 16 mesh, found at most hardware stores. Cut the screen to the shape of the area in which it is to be mounted. Seam solder the wires of two edges at right angles to each other with a 2-inch wide, cold-rolled and annealed copper strap of 0.005-inch thickness. This way you'll know that all of the individual wires are a part of the ground plane. The copper strap readily allows other portions of the screen to be attached together with soldered joints. Secure the antenna tuner to the ground plane with

several copper straps attached at different points on the ground plane. Look for copper straps at your local sheet metal supply house.

A good ground plane will lie high in the bilge (out of bilge water) in close proximity to the sea water. There's a degree of capacitive coupling to the sea water through the non-metallic hull. As an alternative layout, use the underside of quarterberths — those berth areas generally found on either side of the cockpit or engine — for part of the total ground plane. Bond these portions of the screening with copper strap soldered to the bilge portion of the ground plane (see Figure 2).

In Figure 3 you'll see that tankage, metal hydraulic tubing, fire extinguisher piping, water lines, lifelines, toerails, engine, shaft, through-hull fittings, propeller, and rudder constitute the rest of the ground plane when bonded to other ground plane portions with copper strap and soldered joints.

With any boat installation, everything is a compromise. One could claim that 400 square feet of ground area is required, but a horizontal area that large is difficult to obtain on a boat. Yet a ground plane of 10 by 15 feet is the absolute minimum for good efficiency. The limitations of boat size and layout face you. Do the best you can.

**Wrapping it up**

With the antenna and the ground plane in place, and the antenna tuner positioned and attached to the ground plane,



FIGURE 2

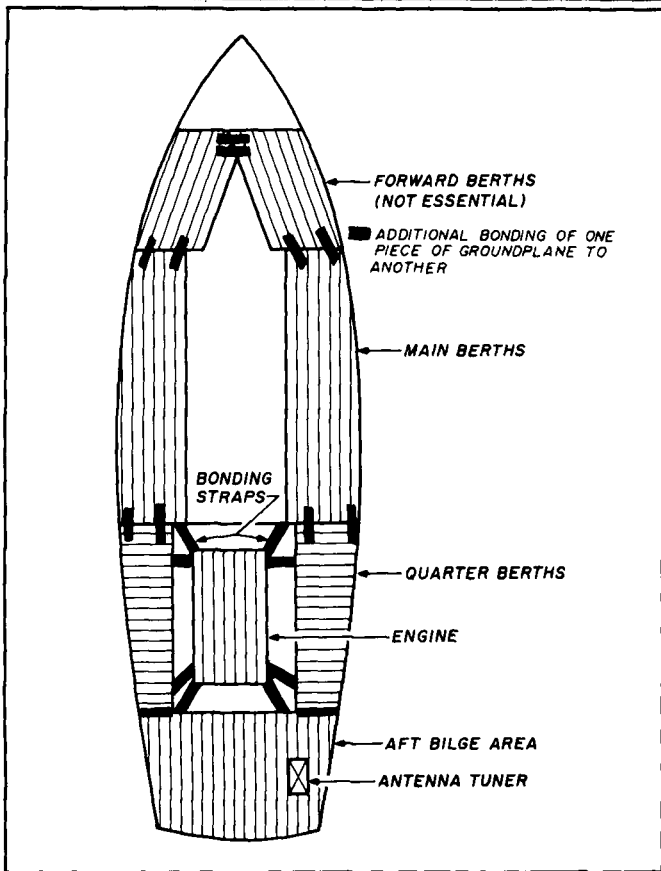

What the antenna would see, if it were to search out possible candidates for ground plane or counterpoise areas. The areas of the cabin sole would add to this, but only if neatness could be maintained by covering screening with carpeting. However, in heavy weather cruising carpeting isn't always practical because it will get wet.

the transceiver can be wired to the boat's battery system. Good practice dictates that a dedicated electronic wiring bus be used to bring full power to an electronic distribution circuit breaker panel.

One hundred-watt transceivers draw 20 A when transmitting. The wire size between the battery and transceiver should be selected to limit the voltage drop to about 3 percent.

The American Boat and Yacht Council (ABYC)\* recommends using AWG no. 6 wire if the length of the conductors from the battery to the transceiver and back to the battery is between 25 and 40 feet. Any longer wiring run will require AWG no. 4 wire.

Most manufacturers will provide a power cable less than 6 feet in length of an AWG no. 10 wire size. This may be used only if the battery is located within the length of cable provided. Otherwise, this cable should be shortened to less than 2 feet and terminated on a barrier terminal strip using crimp lugs. Use heavier wiring of a size that follows the ABYC dictates between the terminal strip and the distribution panel.

Wire the tuner and transceiver as directed and connect the two units with a piece of RG-58/U antenna lead-in cable to complete your system.

### Time to get on the air!

All antenna and ground elements are secured in near vertical alignment. The ground plane is as large and as horizontal as you can make it, and located close to the bilge in the after section of your boat. Finally, due to your professional wiring, there's a full 12 volts DC at your rig when transmitting. If all the work has been done with care, there's not much left to do except to get on the air and listen to those gratifying comments from 10,000 miles away, "You're 20 over 9!" 

\* The American Boat and Yacht Council, PO Box 806, Amityville, New York 11701.

FIGURE 3

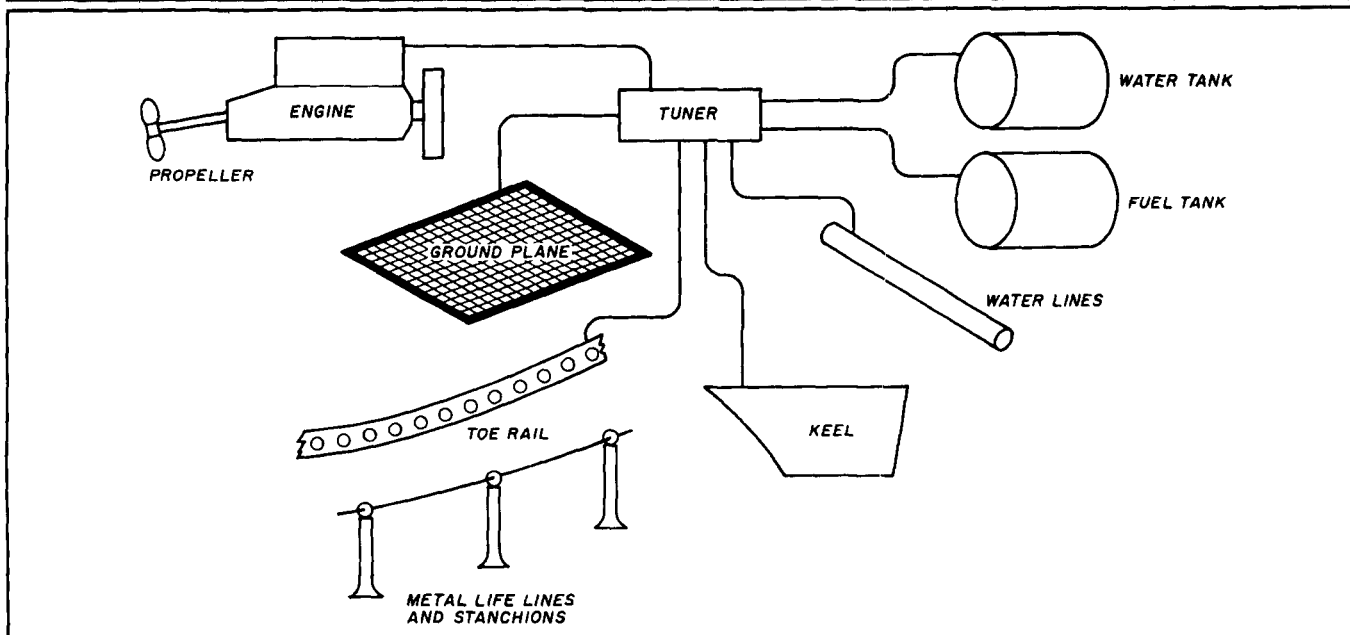

Make sure you bond to everything for a good ground plane, or counterpoise.

See Us At Dayton  
Booths 41, 42, 43, 44,

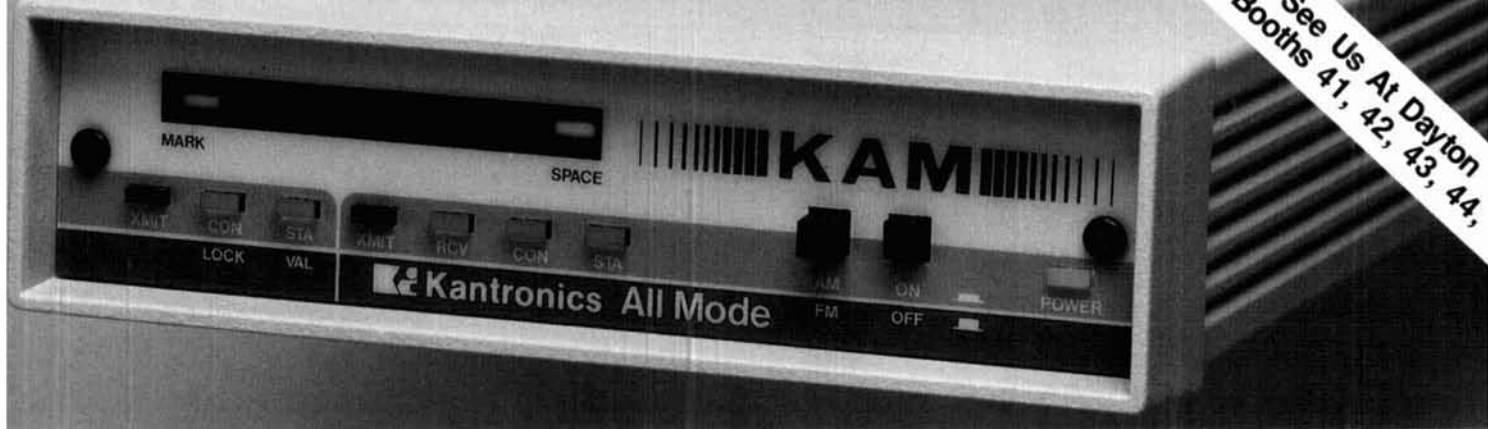

## If You Want the Most Advanced TNC Today...

**I**n 26 countries around the world, tens of thousands of amateurs know that Kantronics is the leader in bringing tomorrow's technology to their stations today. They also know they will always be among the first to incorporate just-introduced features and modes with Kantronics software and firmware updates.

And, they know that Kantronics is unique in its ability to seek out, develop and incorporate the most advanced features into each of five different TNC models before anyone else. Why? Because every program Kantronics writes, and every unit Kantronics designs and produces are born right here at the factory in the U.S.A.

### Meet Your Mailman

**I**n this age of telco LANS, E-mail and FAX,



*PBBS is just one of the firsts Kantronics delivered.*

you will know you have mail in your **Personal Packet Mailbox™** when your KAM "STA" LED is blinking. New firmware level 2.85 has also added a handy automatic mailbox user-

connect. So save your computer and monitor life by turning them off when you are away, and never miss a beat on the airwaves.

Version 2.85 KAMs have increased Packet Cluster™ compatibility, **KA-NODE™** path preservation, KA-NODE recognition of the "NET" nodes and HF baud rates from 50 through 300! And there are three new mailbox commands: *List Mine, Read Mine* and *Kill Mine*.

## and Tomorrow...

### Will the Real Dual-Port Please Stand Up?

**R**ead our lips. **The KAM™ is the only true dual-port when it comes to packet.** Your Personal Packet Mailbox™ is accessible from both HF and VHF! Version 2.85 has dual-port compatibility with RLI/MBL boards and KISS mode for both ports. You can monitor HF and VHF packet operations at the same time. Users can even gateway from HF to VHF (or in reverse) through your KAM.

Kantronics All-Mode™ (KAM) has Packet, WEFAX, ARQ, FEC, RTTY and CW reception. But we have five models to suit your particular taste. **Ask your dealer for the best choice today...and tomorrow.**

**Kantronics**  
RF Data Communications Specialists

1202 E. 23rd Street Lawrence, Kansas 66046  
(913) 842-7745

Packet Cluster™ is the copyrighted software of Pavilion Software  
KAM™, All-Mode™, KA-NODE™, and Personal Packet Mailbox™,  
are trademarks of Kantronics Company, Inc.

# Microwaves

By Bob Atkins, KA1GT

## OPTICAL RECEIVER

Last month I described the requirements for the transmitter end of an optical communications link. This month I'll take a look at the other end of the link — the receiver.

### The optical receiver

Just as the equipment used in the laser transmitter has RF analogs, so do the components used in an optical receiver like the one shown in **Figure 1**. Probably the best analogy is that of a crystal set. The antenna of a crystal set would correspond to the lens (or mirror) of the optical receiver. The crystal set's tuned circuit corresponds to the optical filter, the crystal itself is analogous to the optical detector, and the headphones of the crystal set are replaced by the amplifier section of the optical receiver.

The first function of the optical receiver is to capture as much of the transmitted light as possible and to direct that light towards the optical detector. The function is the same as that of a telescope, with the receiver as the eye, so it's no surprise that an optical receiver closely resembles a telescope. Either a large lens or mirror can be used to capture the light. For visual use, the optics of a telescope system must be shaped with extreme accuracy. In fact, they must correspond with their designed shapes to better than one-quarter the wavelength of light (a few millionths of an inch). Though such optics would work well in an optical receiver, they are very expensive in large sizes. Rather than form a detailed image, the optics of the optical receiver need only concentrate the incoming light into an area less than or equal to the area of the optical detector; thus lower quality optics can be used to good effect.

### The fresnel lens

One type of lens which has been used in optical receivers is known as the fresnel lens. This lens is comprised of concentric rings of prismatic elements, each of which bend the incoming light towards the lens's focal point as shown in **Figure 2**. The fresnel lens has advantages over conventional optics because it is much cheaper,



much thinner, and lighter. Unfortunately, the fresnel lens produces a very poor quality visual image. But, as I pointed out earlier, this may be of no consequence in an optical receiver. To compare prices, a 6-inch diameter optical lens might cost \$700 and a 6-inch parabolic mirror might run \$150, but a 12-inch fresnel lens (which captures 4 times as much light as the 6-inch optics) can be purchased for around \$30.

### Interference and absorption filters

As mentioned last month, the light from a laser is monochromatic (i.e.,

**FIGURE 1**

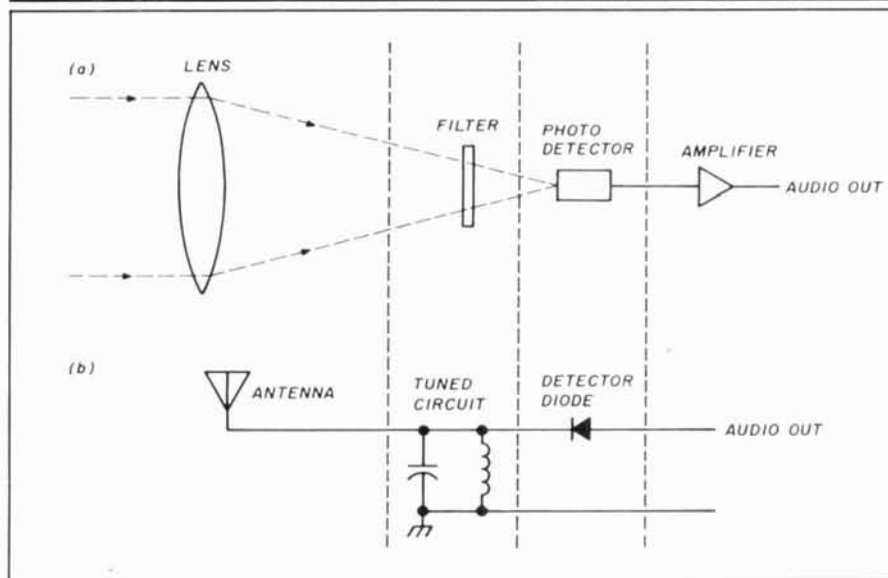

(A) Schematic of a simple optical receiver. (B) Analogous components of a crystal set.

**FIGURE 2**

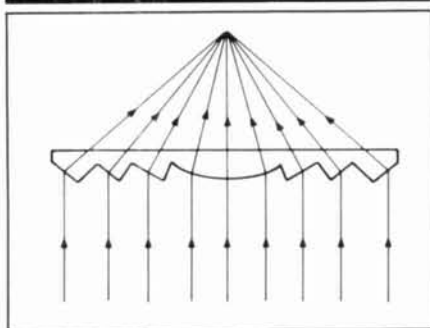

Cross-section of a fresnel lens.

composed of only one color). The background light entering the optical receiver will, in general, be composed of all visible colors plus some infrared and ultraviolet wavelengths. These unwanted background optical signals can be thought of as "optical QRM." A filter can be used to select out only the laser light, just as an RF filter is used to select one specific RF frequency.

There are two commonly used filter types — interference and absorption filters. Interference filters are composed of many layers of different dielectric



# ONLY ICOM COULD BUILD THIS MANY FEATURES INTO SUCH A TINY RADIO

ICOM's new "S Series" mini handhelds deliver top performance on the 144, 220 and 440MHz bands with super easy operation and a kaleidoscope of features. Built to fit your needs today, tomorrow, anywhere and anytime.



**Wide Frequency Coverage.** Plenty of overlap for scanning, monitoring, CAP and MARS use. IC-2SA/IC-2SAT: 138-174 MHz Rx. IC-3SAT 220-225MHz Rx. IC-4SAT: 440-450 MHz Rx. All units transmit all U.S. Amateur bands.

**Flexible Size And Power.** The IC-2SA packs 2.5 watts with supplied BP-82. The IC-2SAT, 3SAT and 4SAT's internal battery packs 2 watts of output on high power. All models deliver five watts when powered via optional BP-85 battery pack or via top-mounted 13.8 volt socket. A small rig with a big punch!

**48 Memories.** Store your present frequencies and expand your future interests. Offset frequencies are independently programmed in memory channels 0-9. Memories 10-47 use offset frequency contents of the VFO. Also includes soft-sector memory masking. Use only the number of memories you need!

**Band and Memory Scanning** with programmable limits, memory skip

function, plus selectable pause times while scanning. Additional features include:

**Automatic Power Shut-off.** Built-in programmable timer automatically switches off transceiver when you forget.

**Optional DTMF Paging Function.** Silently monitors any selected frequency for your preprogrammed 3-digit DTMF-keyed calls, then beeps and displays calling station's code.

All ICOM's "S Series" handhelds are supported by an extensive line of optional battery packs, chargers, cases, speaker/mics and other accessories. See the exciting new ICOM mini-series handhelds at your authorized ICOM dealer today!

ICOM America, Inc. 2380-116th Ave. N.E. Bellevue, WA 98004  
 Customer Service Hotline (206) 454-7619  
 3150 Premier Drive, Suite 126, Irving, TX 75063  
 1777 Phoenix Parkway, Suite 201, Atlanta, GA 30349  
 ICOM CANADA, A Division of ICOM America, Inc.  
 3071 - #5 Road, Unit 9, Richmond, B.C. V6X 2T4 Canada

All stated specifications are subject to change without notice or obligation. All ICOM radios significantly exceed FCC regulations limiting spurious emissions. 2SAT989

**Four Power Selections**

**10 Memory DTMF Auto**

**DC Socket For Charging and Moding**

**24 Hour Clock With Timer**

**48 Memories**

**ACTUAL SIZE**

**Easy Knob or Keypad Frequency Selection**

**Power Output**

**ICOM**  
 First in Communications

# DAYTON Hamvention®

April 27, 28, 29, 1990

## Early Reservation Information

• General Chairman, Ed Hillman, N8ALN

• Asst. General Chairman, Dave Grubb, KC8CF

- Giant 3 day flea market • Exhibits
- License exams • Free bus service
- CW proficiency test • Door prizes

### 1990 Deadlines

*Award Nominations:* March 15

*License Exams:* March 26

*Advance Registration and banquet:*

USA - April 4    Canada - March 31

*Flea Market Space:*

Spaces will be allocated by the Hamvention committee from all orders received prior to February 1. Express Mail *NOT* necessary! Notification of space assignment will be mailed by March 15, 1990. Checks will not be deposited until after the selection process is complete.

Flea market tickets and grand banquet tickets are limited. Place your reservations early, please.

### Flea Market Tickets

A maximum of 3 spaces per person (non-transferable). Tickets (valid all 3 days) will be sold IN ADVANCE ONLY. No spaces sold at gate. Vendors MUST order registration ticket when ordering flea market spaces.

### Special Awards

Nominations are requested for "Radio Amateur of the Year," "Special Achievement" and "Technical Achievement" awards. Contact: Hamvention Awards Chairman, Box 964, Dayton, OH 45401.

### Information

General Information: (513) 433-7720  
or, Box 2205, Dayton, OH 45401

Lodging Information: (513) 223-2612  
(No Reservations By Phone)

Flea Market Information: (513) 845-3683

### License Exams

Novice thru Extra exams scheduled Saturday and Sunday by appointment only. Send FCC form 610 (Aug. 1985 or later) - with requested elements shown at top of form, copy of present license and check for prevailing ARRL rates (payable to ARRL/VEC) to: Exam Registration, 8830 Windbluff Point, Dayton, OH 45458

### Lodging

Please write to **Lodging, Dayton Hamvention, Chamber Plaza, 5th & Main Streets, Dayton, OH 45402** or refer to our 1989 Hamvention program for lodging information which includes a listing of hotel/motels located in the areas surrounding Dayton.

HAMVENTION is sponsored by the Dayton Amateur Radio Association Inc.

## Advance Registration Form

Dayton Hamvention 1990  
Reservation Deadline - USA-April 4, Canada-March 31  
Flea Market Reservation Deadline: February 1

Enclose check or money order for amount indicated and send a self addressed stamped (#10) envelope.

Please Type or Print your Name and Address clearly.

	<u>How Many</u>		
Admission (valid all 3 days)	_____	@ \$10.00*	\$ _____
Grand Banquet	_____	@ \$22.00**	\$ _____
Women's Luncheon (Saturday)	_____	@ \$8.00	\$ _____
(Sunday)	_____	@ \$8.00	\$ _____
Flea Market (Max. 3 spaces)	_____	\$25/1 space \$50/2 adjacent	\$ _____
Admission ticket must be ordered with flea market tickets	_____	\$150/3 adjacent	\$ _____
		<b>Total</b>	\$ _____

\* \$12.00 at door    \*\* \$24.00 at door, if available

Name \_\_\_\_\_

Address \_\_\_\_\_

City \_\_\_\_\_ State \_\_\_\_\_ Zip \_\_\_\_\_

Make checks  
payable to - **Dayton HAMVENTION**  
Mail to - **Dayton Hamvention  
Box 2205  
Dayton, OH 45401**

materials and work on the principle of the constructive and destructive interference of light. These filters have a very narrow passband, analogous to high Q cavity filters at RF. With interference filters, the wavelength of maximum transmission depends on the angle at which the light strikes the filter. This is of consequence when such a filter is used in conjunction with small f-number receiving optics.

The f-number of a lens is given by the focal length of the lens divided by its diameter. As you can see in **Figure 3**, light captured by the edge of such a lens will arrive at its focal point at a large angle (theta). This may be sufficient to cause the transmission maximum of an interference filter to shift to such an extent that light of the laser's wavelength is no longer transmitted. For a 10-nm wide filter at the He-Ne wavelength of 632.8 nm, light coming from the edge of an f2 lens will hit the filter at a 14-degree angle of incidence. This is enough to shift the filter peak response from 632.8 nm to around 628.4 nm, reducing the transmission by around 50 percent. Because only the light from the edges of the lens suffers this much attenuation, this configuration is acceptable. However, if an f1 lens is used (and this is not unusual for a fresnel-type lens), 632.8-nm light from the outer edges of the lens won't pass through the filter at all, and only light collected by the central region of the lens can be used.

What this all boils down to is that a 6-inch diameter f2 lens (12-inch focal length) will be as efficient at light collecting as a 12-inch f1 lens (12-inch focal length) when a 10-nm bandwidth interference filter is used. If you have a lens whose f-number is less than 2, there are two ways to use it efficiently. A small diverging (convex) lens can be placed before the filter. This converts the converging beam from the main lens to a parallel (or much less converging) beam, lessening the angle at which the light enters the filter. The other alternative is to use an absorption filter instead of an interference filter. Absorption filters absorb light of certain wavelengths and allow all others to pass through. In RF terms, they can operate like low pass, high pass, or bandpass filters of low to moderate Q.

In summary, the interference filter has the advantage of narrow bandpass (and hence high background

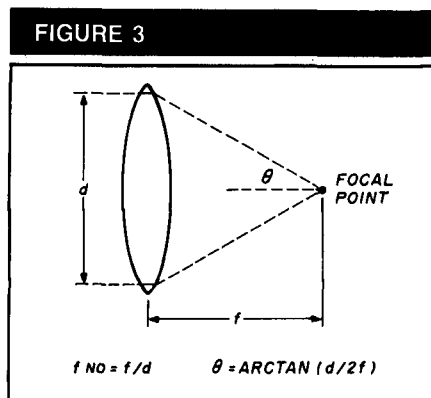

**Definition of the f number of a lens. Note: When the f number is small, angle  $\theta$  is large. This can be a problem if an interference filter is used in the optical path (see text).**

light rejection) at the expense of sensitivity to incidence angle and cost. On the other hand, while absorption filters are low in cost and insensitive to incidence angle, they do not provide the background rejection of interference filters. For daytime operation the use of an interference filter is highly desirable, perhaps even essential, while nighttime operation is possible with an absorption filter, or even no filter if there's little or no background light.

For He-Ne lasers, a 632-nm interference filter 0.5 inches in diameter with a 10-nm bandpass is available for \$38 from Edmund Scientific (see last month's column). A red photographic filter (Kodak types 29, 26, or 25) would be acceptable as an absorption filter for use with He-Ne lasers. A 2-inch diameter filter should be available from local photographic equipment suppliers for less than \$10.

After capturing and filtering the light, the next step is to convert the optical energy into electrical energy using an optical detector. There are two detector types of practical interest, the photomultiplier and the photodiode.

The photomultiplier is an electron tube device which contains a number of internal electrodes (dynodes). An overall supply voltage of around 1000 volts is split evenly between the electrodes. When a photon enters the tube it impacts on a photocathode and ejects an electron (this is known as the photoelectric effect). This electron is then accelerated to the nearest electrode by the potential difference between them. When it hits the electrode, it ejects several more electrons. These electrons are accelerated to the next electrode, where they strike it and

emit even more electrons, and so on. Finally, after passage via the multiple electrodes, the initial electron release is effectively multiplied by up to 1 million times, and a measurable current is generated.

In contrast to the high voltage/amplification characteristics of the photomultiplier, the photodiode is a low voltage device with no intrinsic gain. It operates much like a solar cell, generating a small current when exposed to light. To be useful at low light levels, the current generated is converted to a voltage and amplified. This is accomplished most simply using an op amp configured as a transimpedance amplifier. Some photodiodes are available with a built-in high gain amplifier in the same package. This is a desirable configuration because, owing to the very high gains needed ( $>10^5$ ), pickup of stray signals is a problem. These signals can be minimized by housing the photodiode and amplifier together in the same shielded package.

## Choosing an optical detector

The choice of optical detector depends on a number of factors including spectral response, size, sensitivity, and convenience of use. Most photomultipliers are more sensitive in the blue region of the spectrum than the red. A typical tube might be 10 times more sensitive at 442 nm (He-Cd) than at 632 nm (He-Ne). Some tubes do have extended red response, but they are less common on the surplus market and more expensive. Photodiodes usually show maximum response in the near infrared at around 900 nm. They are usually about 1.5 times more sensitive at 632 nm than at 442 nm. The shapes of the response curves for several photodetectors are shown in **Figure 4**.

Detector area is also an important parameter. For maximum receiver efficiency, all the light collected by the lens must hit the active area of the detector. Using a fresnel lens will result in a larger image than would be obtained using high quality optics. It's evident, therefore, that a larger area optical detector is desirable because it will increase the probability that all the collected light will hit the detector. For the same reason, a large detector area also lowers the required pointing accuracy. A potential drawback of a very large area detector is that, given

reasonable imaging optics, it will collect light from a wider area than a small area detector (hence the easier pointing). This means that if there's a lot of background light, it could swamp out the laser signal. This shouldn't be a problem at night and/or when efficient narrowband filters are used. A typical photomultiplier has quite a large active area of around 1 cm x 2 cm.

Photodiodes are available in a range of sizes from an active area of several square centimeters down to less than 1/10 of a square millimeter. Very small area detectors, like those of the Motorola MRD series (MRD 360 photodarlington, MRD 510 photodiode, and MRD 300 phototransistor) are quite sensitive and inexpensive (\$2), and even include photodarlington transistor detectors which effectively show intrinsic gain. Unfortunately, for the reasons given previously, their extremely small active area (0.03" x 0.03" maximum) makes them a poor choice for most free space DX optical receivers. However, they are good and inexpensive devices for initial experimentation. Large area detectors are normally more expensive (\$10 to \$30), but will provide much better results in most cases. They do generate a little more internal noise, though in this application it shouldn't be enough to cause a problem.

### Noise equivalent power

Ultimate detector sensitivity is limited by the intrinsic noise generated internally by the device. There is a measure of this noise known as the noise equivalent power (NEP). This is roughly comparable to the noise figure of a diode or transistor. NEP is defined as the amount of optical power required to generate a signal equal to the intrinsic noise level of the detector. Therefore, it's also the amount of optical power required to give a 0-dB signal-to-noise ratio. Because noise is a function of bandwidth, it's expressed in units of W/Hz<sup>1/2</sup>. The NEP of a good photomultiplier is about 10 times lower than that of a good photodiode. Some typical NEP values for devices which would be suitable for use in Amateur optical receivers are:

Hamamatsu R906 photomultiplier  
 at 440 nm = 3e-16 W/Hz<sup>1/2</sup>  
 (blue sensitive, \$70)  
 at 632 nm = 6e-15 W/Hz<sup>1/2</sup>

FIGURE 4

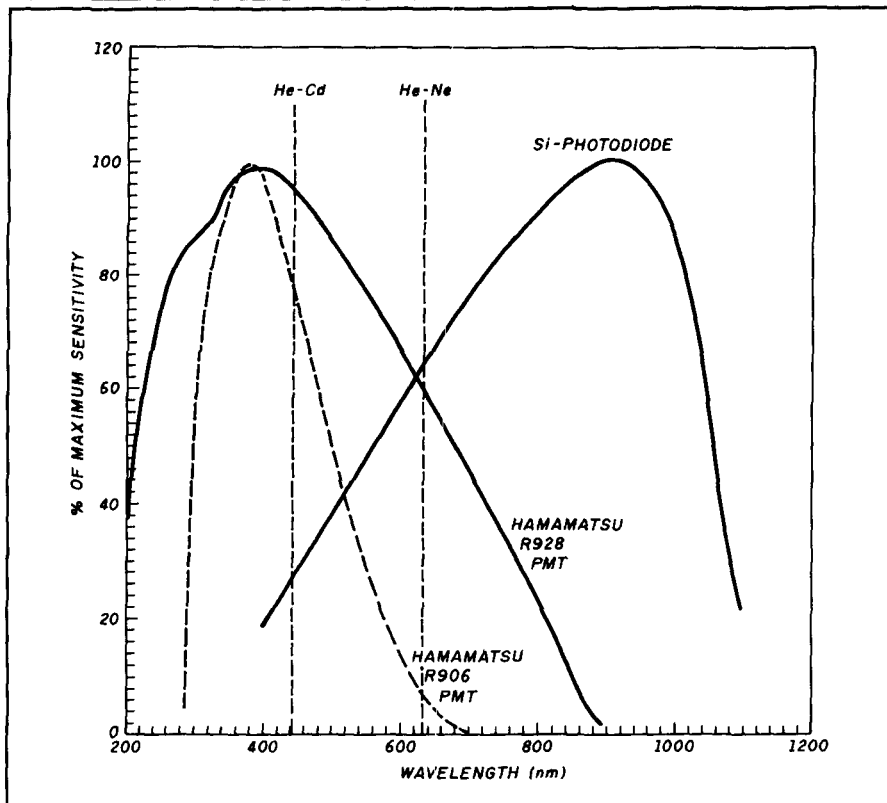

Relative response curves for photodetectors.

Hamamatsu R928 photomultiplier  
 at 440 nm = 1e-16 W/Hz<sup>1/2</sup>  
 (red sensitive, \$300)  
 at 632 nm = 2e-16 W/Hz<sup>1/2</sup>

Hamamatsu S2386-8K photodiode  
 at 440 nm = 8e-15 W/Hz<sup>1/2</sup>  
 (area = 33mm<sup>2</sup>, \$30)  
 at 632 nm = 3e-15 W/Hz<sup>1/2</sup>

UDT-020D photodiode/amplifier  
 at 440 nm = 2.5e-14 W/Hz<sup>1/2</sup>  
 (area = 20mm<sup>2</sup>, \$43)  
 at 632 nm = 5.1e-14 W/Hz<sup>1/2</sup>

If the laser transmitter is tone modulated before keying (MCW or A2A modulation as described last month), all that's required to produce an audible CW signal is to amplify the output of the optical detector and feed the signal into an audio amplifier. A narrowband audio filter centered on the modulation frequency can be included for improved performance. If the laser is not tone modulated (CW or A1A modulation), and if DC coupling is then used throughout, the output of the photodetector after the transimpedance amplifier is a voltage level which rises and falls as the transmitter is keyed. To

produce an audible signal, this voltage level must be used to key a tone on and off. This can be achieved by feeding the amplifier output into one input of a comparator. A reference voltage is then fed into the other comparator input and adjusted so the comparator output is low when the laser is off and high when the laser is on. The output of the comparator can then be used to key a tone on and off — or its digital state can be read directly by a computer.

Figure 5 shows the electrical schematic for a complete optical receiver suitable for the reception of keyed tone-modulated transmissions. If an integrated detector/amplifier is used, this would replace the first amplifier stage. Note that such detector/amplifiers are DC coupled, which means that their output saturates (reaches the supply voltage) with fairly low levels of incident light. For example, the EG&G HUV 2000B, using a ±15 volt supply, will saturate at about 3x10<sup>-7</sup> watts of incident light energy when operating at maximum "gain." (Strictly speaking, "gain" is an inappropriate term because the amplifier is operating as a current-to-voltage converter.) In a well-constructed optical receiver,



and with a low level of background light, the detection of limit will probably be in the range of  $10^{-10}$  to  $10^{-12}$  watts of modulated laser energy — depending on the quality of construction, noise levels generated in the amplifier stages, the receiver bandwidth, and how well you can copy weak CW! For those interested in a detailed mathematical analysis of the noise components of optical detectors, check out the EG&G Photon Devices catalog cited at the end of this article.

diodes and \$21 for small photodiode/amplifier combinations. Minimum order \$100. Data sheets available. Contact UDT, 12525 Chadron Avenue, Hawthorn, California 90250.

**EG&G Photon Devices** — Manufacturer of photodiodes. Small photodiodes from \$17, diode/amplifier combinations from \$70. No minimum order. Catalog available. Contact EG&G Solid State, 35 Congress Street, P.O. Box 506, Salem, Massachusetts 01979-6526.

**Motorola** — Manufacturer of small

## MICROWAVE ANTENNAS

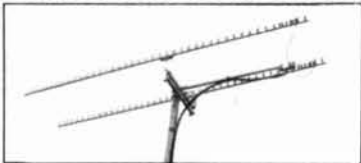

Loop Yagis, Power Dividers, Stacking Frames, Complete Array of 902, 910, 1269, 1296, 1691, 2304, 2401, 3456 MHz. For Tropo, EME, Weak Signal, OSCAR, ATV, Repeaters, WEFAx, Commercial point to point. Available in kit form or assembled and tested.

3333LYK	33el	loop Yagi Kit	902 MHz	18.5 dBi	\$89.00
2345LYK	45el	loop Yagi Kit	1296 MHz	21 dBi	\$89.00
2445LYK	45el	loop Yagi Kit	1269 MHz	21 dBi	\$89.00
1844LY	44el	loop Yagi (assem.)	1691 MHz	21 dBi	\$99.00
2355LYK	55el	Superlooper Kit	1296 MHz	22 dBi	\$99.00
1345LYK	45el	loop Yagi Kit	2304 MHz	21 dBi	\$75.00
945LYK	45el	loop Yagi Kit	3456 MHz	21 dBi	\$75.00

Other models available. Call or write for catalog.

SEE YOU AT DAYTON 1990

## DOWN EAST MICROWAVE

Bill Olson, W3HQT

Box 2310, RR1 Troy, ME 04987

(207) 948-3741



## MICROWAVE TRANSVERTERS

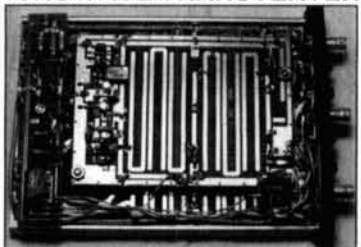

SHF 1240 Complete Transverter

**SHF SYSTEMS** No tune linear transverters and transverter kits for 902, 1269, 1296, 2304, 2400, 3456 MHz. All use 2m i.f.g.13.8V. Kits include mixer and L.O. P.C. boards, xtal and all components. Built units include I.F./D.C. switchboard, connectors and compact low profile housing. Other frequency options in amateur band available.

SHF 900K	902-906 MHz	50mW	Kit \$129	Built \$250
SHF 1240K	1296-1300 MHz	10mW	Kit \$139	Built \$240
SHF 1269K	1268-1272 Oscar Mode L	10mW	Kit \$130	Built \$240
SHF 2304K	2304-2308 MHz	10mW	Kit \$195	Built \$320
SHF 2401K	2400 MHz Mode S rcv Conv	Kit \$150	Built \$250	
SHF 3456L	3456-3460 MHz	10mW	Kit \$195	Built \$320
SHF LOK	540-580 MHz L.O.	50mW	Kit \$ 64	

CALL OR WRITE FOR COMPLETE CATALOG

## DOWN EAST MICROWAVE

Bill Olson, W3HQT

Box 2310, RR1 Troy, ME 04987

(207) 948-3741



## MICROWAVE AMPLIFIERS

from

## DOWN EAST MICROWAVE

### Linear Power Amps

for SSB, ATV, FM, 902—1296—2304—3456MHz

2304 PA	10mW in 5W out	1240-1300 MHz	\$130
2318 PAM	0.5W in 18W out	1240-1300 MHz	\$205
2335 PA	10W in 35W out	1240-1300 MHz	\$315
2340 PA	1W in 35W out	1240-1300 MHz	\$355
2370 PA	5W in 70W out	1240-1300 MHz	\$695
3318 PA	1W in 20W out	902-928 MHz	\$265
3335 PA	14W in 40W out	902-928 MHz	\$320
1303 IPA	10mW in 0.4W out	2304 MHz	\$150
901 IPA	10mW in 1W out	3456 MHz	Write or Call

T/R Switching available, all 13.8 VDC

**Low Noise Preamps & preamp kits**—432, 902, 1296, 1691, 2304, 2401, 3456 MHz, 5.7 and 10 GHz.

33LNA	preamp 6 dB NF	902 MHz	13.8V	\$ 90
23LNA	preamp 6 dB NF	1296 MHz	13.8V	\$ 90
13LNA	preamp 7 dB NF	2300-2400 MHz	13.8V	\$130
1691LNAP	preamp 1 dB NF	1691 MHz mast mounted	13.8V	\$140
4017LNK	preamp kit	400-1700 MHz	6 dB	\$ 40

Preamp kits for 2304-10 GHz Write or Call

CALL OR WRITE FOR MORE INFORMATION

## DOWN EAST MICROWAVE

Bill Olson, W3HQT

Box 2310, RR1 Troy, ME 04987

(207) 948-3741



FIGURE 5

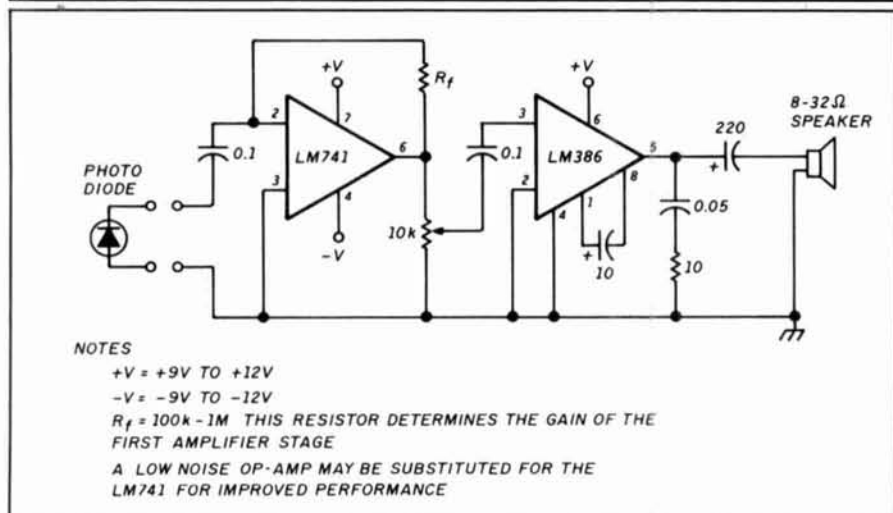

Schematic of the electronic stages of an optical receiver.

## Suppliers

Here are a few sources for the components required to construct an optical receiver. The catalogs and data books referenced are free to commercial users, but there may be charges to individuals who order them. This is not an exhaustive list; inclusion or omission from the list does not imply endorsement or otherwise.

**Hamamatsu** — Manufacturer of photomultipliers and photodiodes. Large range of products includes PMTs from \$70, photodiodes from \$10. Minimum order \$25. Will take credit cards. Catalogs available. Contact Hamamatsu, Order Service Department, 360 Foothill Road, Box 6910, Bridgewater, New Jersey 08807-0960.

**United Detector Technology** — Manufacturer of photodiodes. Good selection, from \$10 for small photo-

area optoelectronic devices (photodiodes, phototransistors, photodarlingtons), mostly in the \$2 to \$15 price range. Optoelectronics Data book available from Motorola Literature Distribution, P.O. Box 20912, Phoenix, Arizona 85036. Devices available through distributors (e.g., Newark, Hamilton-Avnet).

See last month's column for suppliers of optics and filters.

Next month, in the final article on optical communication, I'll discuss the factors (principally scattering) which influence optical communication range and I'll show you how to calculate the DX potential of a laser communication system. Please send comments, questions and any microwave activity reports to Bob Atkins, KA1GT, 103 Division Avenue, Millington, New Jersey 07946.

## A 220-MHZ RECEIVING ADAPTER

By Peter J. Bertini, K1ZJH, 20 Patsun Road, Somers, Connecticut 06071

**C**atch the wave — 1-1/4 meter waves, that is — with your 2-meter handheld and this simple converter! This weekend project allows casual 1-1/4 meter monitoring on your 2-meter handheld or VHF scanner. The self-contained converter is small enough to mount directly on the antenna jack of most BNC outfitted handhelds. Many converter designs have been published, but I wanted a circuit that didn't need an etched pc board. I also wanted to make this project as simple as possible!

### Works both ways!

The converter uses a passive diode mixer and is bilateral; you can also receive 2-meter signals on a 220-MHz receiver! In this mode the converter is connected "backwards." My service monitor, an older Cushman CE-3, covers 144 MHz but not 220. With this converter, I can use the monitor to perform accurate frequency/deviation monitoring and limited signal generation on the 1-1/4 meter band (more on this later).

A VHF converter may use several stages. You might find an LO oscillator with one or two multiplier stages, a mixer, and usually an RF amplifier. This is hardly something you could build in a weekend or would want sitting on top of your 2-meter HT! I make do with only a mixer and oscillator. The mixer has fairly high losses and the ultimate sensitivity is determined by the 2-meter IF receiver.

### Construction starts with plastic case

The converter is housed in a plastic Radio Shack project case. A matching perfboard with 0.1-inch spaced component mounting holes comes with the case. A VHF converter would normally be built on an etched pc board. I avoided this by mounting a piece of sheet brass, slightly less than 0.7 inches wide, transversing the center length of the perfboard. All component leads going to ground connect directly to this strip. The brass stock is available at hobby shops and can be cut easily with tinsnips. A thickness of 0.01 inch will do. When mounting the trimmer capacitors, connect the rotor plates to ground. This lets you use metallic

tuning tools during alignment, except when you're working with the trimmer on the oscillator secondary winding where both plates are at RF potential.

The BNC connector ground lugs are connected to the ground plane. This also holds the finished converter board in place. Remove the two plastic standoffs inside the case, so the converter board will sit flush with the case bottom. Carefully break away the standoff material with a small pair of needle-nose pliers. You may clean any remaining rough edges with a penknife. With care, everything — including the 9-volt battery — will fit inside the case. Parts layout isn't critical.

I used chassis mount BNC female connectors. You'll need a double male BNC adapter to connect the converter to most handhelds. You can also use a cable end male connector on the case for the radio connection. Use the rear cable nut to mount the connector through the enclosure. Prepare a short piece of bare hookup wire and solder it to the male pin of the BNC connector. Insert the pin so it's properly seated in the connector. Several drops of epoxy will keep the pin from pushing back when mated.

FIGURE 1

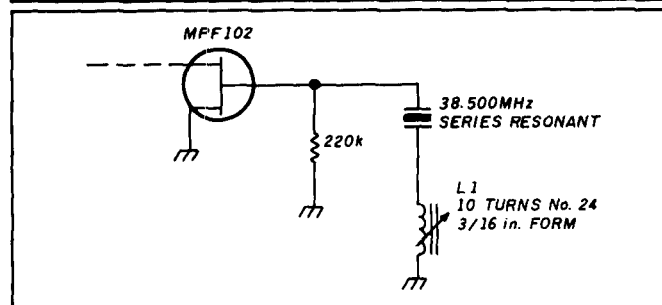

Variation of oscillator circuit uses series-resonant crystal with adjustable series inductance to permit precise setting of oscillator frequency.

FIGURE 2

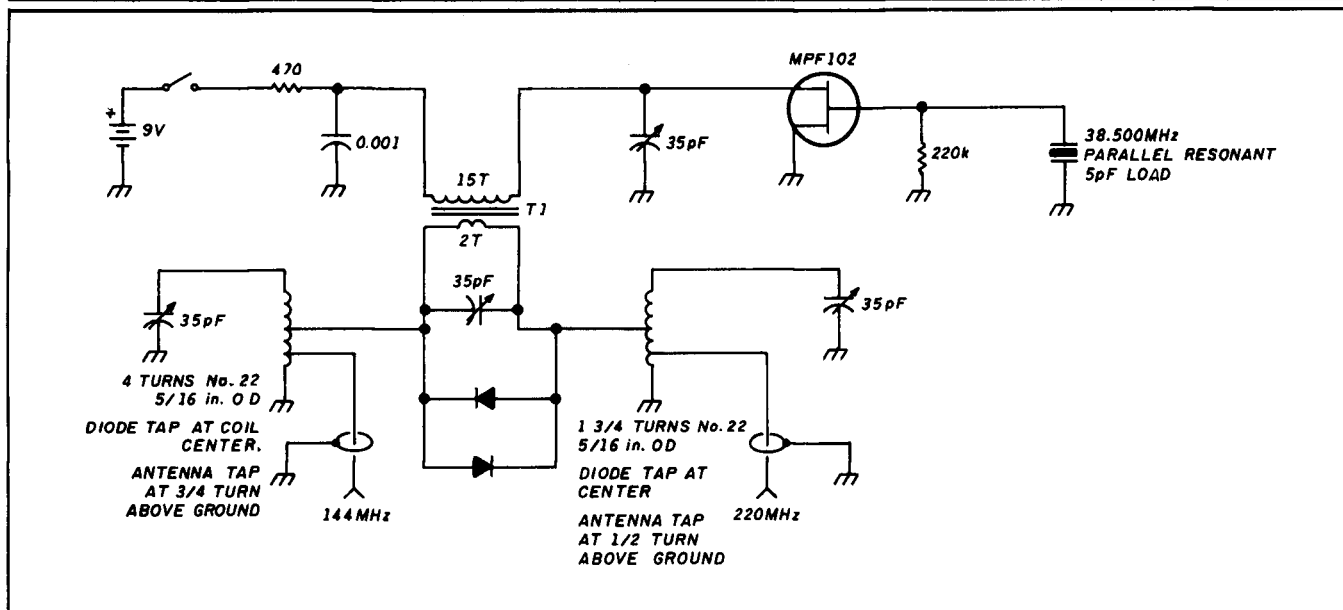

Receiving converter adapter circuit. Oscillator is shown with parallel-resonant crystal cut for 5-pF load and is accurate to within a few hundred cycles. Coil details are given in the test and parts lists.

**PARTS LIST**

**Capacitors**

- 4 Trimmers, between 30-40 pF maximum, plastic or ceramic miniature.
- 1 Ceramic disc, 25 or greater working volts  
1000 pF (0.001 μF)

**Coils**

- 1 220-MHz antenna coil, 1-3/4 turns no. 22 tinned wire, air wound. 5/16-inch OD, center tap for diode connection. Antenna tap is at 1/2 turn above ground.
- 1 144-MHz antenna coil, 4 turns no. 22 tinned wire, 5/16-inch OD, center tap for diode connection. Antenna tap is at 3/4 turn above ground.
- 1 L1 warping inductor. About 12 turns AWG no. 24 magnet wire solenoid wound on 1/4 to 3/16-inch slug-tuned form. Used only with series resonant cut crystal.

**Crystal**

- 1 38.5000-MHz, third overtone cut, HC-18u wire lead case.  
Note: order ICM factory no. 4713601 for general use. Parallel resonant, 5-pF load.

Order ICM factory no. 471360 if it is desirable to set frequency. Series resonant mode. Used with series inductor to set frequency.

**Diodes**

- 2 High speed switching, silicon 1N914, 1N4148 or hot carrier type.

**Project case**

- 1 Radio shack 270-283 or similar

**Resistors**

- 1 1/4 watt carbon or film composition, 20 percent or better
- 1 470 ohm
- 1 220 k

**Transistor**

- 1 FET, MPF102 or 2N5486

**Transformer (T1)**

- 1 Toroid, T-37-6, yellow SF mix, 0.37-inch OD primary winding 15 turns AWG no. 24 enamel magnet wire, secondary winding 2 turns AWG no. 24 enamel magnet wire wound in phase over primary winding.

**Oscillator is only active stage**

The third overtone oscillator is the only active stage in this converter. Because I wanted 223 MHz to correspond to 146 MHz, I needed an LO frequency of 77 MHz. The third overtone oscillator operates at one-half the LO frequency. For casual monitoring, use an International Crystal catalog no. 4713601 38.5000-MHz crystal. It will be within several hundred cycles and will work fine. This parallel resonant crystal is cut for a 5-pF load.

For critical applications — like using the converter with a service monitor to set frequencies — I suggest an International Crystal catalog no. 471360 38.500-MHz crystal. This series resonant crystal can be set, or “warped,” to exactly 38.5000 MHz by placing a small variable inductor in series with the crystal. See Figure 1 for details. About ten turns of no. 24 wire on a 3/16 to 1/4-inch slug-tuned form will suffice. Be careful, too much inductance will cause spurious oscillations; some cut-and-try experimentation may be necessary.

**Innovative mixer simplifies circuit**

The mixer is driven directly by the 38.5-MHz oscillator. This unique passive mixer stage uses two diodes paralleled back to back (see Figure 2). Each diode conducts on alternating crests of the LO injection. This halves the required LO injection and eliminates the need for a frequency doubler. While this isn't the ultimate mixer, it serves my needs. I spent a lot of time optimizing the mixer circuitry, particularly when trying to couple the LO energy into the diodes. The best performance was achieved with the diodes connected across the output link over the oscillator tank circuit; however, losses were still very high. I discovered (entirely by accident!) that by resonating the coupling link to 2 meters the mixer losses dropped by several dB — hence the trimmer capacitor across the link winding. Why this improves performance I honestly don't know, but I surmise the coupling link loads the mixer diodes until they are transformed into

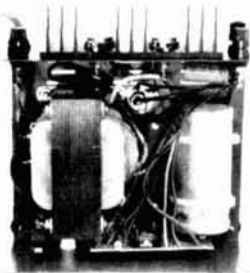

INSIDE VIEW — RS-12A

## ASTRON POWER SUPPLIES

• HEAVY DUTY • HIGH QUALITY • RUGGED • RELIABLE •

### SPECIAL FEATURES

- SOLID STATE ELECTRONICALLY REGULATED
- FOLD-BACK CURRENT LIMITING Protects Power Supply from excessive current & continuous shorted output
- CROWBAR OVER VOLTAGE PROTECTION on all Models except RS-3A, RS-4A, RS-5A.
- MAINTAIN REGULATION & LOW RIPPLE at low line input Voltage
- HEAVY DUTY HEAT SINK • CHASSIS MOUNT FUSE
- THREE CONDUCTOR POWER CORD
- ONE YEAR WARRANTY • MADE IN U.S.A.

### PERFORMANCE SPECIFICATIONS

- INPUT VOLTAGE: 105-125 VAC
- OUTPUT VOLTAGE: 13.8 VDC  $\pm$  0.05 volts (Internally Adjustable: 11-15 VDC)
- RIPPLE Less than 5mv peak to peak (full load & low line)
- Also available with 220 VAC input voltage



MODEL RS-50A



MODEL RS-50M



MODEL VS-50M

### RM SERIES



MODEL RM-35M

### 19" $\times$ 5 1/4" RACK MOUNT POWER SUPPLIES

MODEL	Continuous Duty (Amps)	ICS* (Amps)	Size (IN) H $\times$ W $\times$ D	Shipping Wt. (lbs.)
RM-12A	9	12	5 1/4 $\times$ 19 $\times$ 8 1/4	16
RM-35A	25	35	5 1/4 $\times$ 19 $\times$ 12 1/2	38
RM-50A	37	50	5 1/4 $\times$ 19 $\times$ 12 1/2	50
• Separate Volt and Amp Meters				
RM-12M	9	12	5 1/4 $\times$ 19 $\times$ 8 1/4	16
RM-35M	25	35	5 1/4 $\times$ 19 $\times$ 12 1/2	38
RM-50M	37	50	5 1/4 $\times$ 19 $\times$ 12 1/2	50

### RS-A SERIES



MODEL RS-7A

MODEL	Continuous Duty (Amps)	ICS* (Amps)	Size (IN) H $\times$ W $\times$ D	Shipping Wt. (lbs.)
RS-3A	2.5	3	3 $\times$ 4 3/4 $\times$ 5 3/4	4
RS-4A	3	4	3 3/4 $\times$ 6 1/2 $\times$ 9	5
RS-5A	4	5	3 1/2 $\times$ 6 1/8 $\times$ 7 1/4	7
RS-7A	5	7	3 3/4 $\times$ 6 1/2 $\times$ 9	9
RS-7B	5	7	4 $\times$ 7 1/2 $\times$ 10 3/4	10
RS-10A	7.5	10	4 $\times$ 7 1/2 $\times$ 10 3/4	11
RS-12A	9	12	4 1/2 $\times$ 8 $\times$ 9	13
RS-12B	9	12	4 $\times$ 7 1/2 $\times$ 10 3/4	13
RS-20A	16	20	5 $\times$ 9 $\times$ 10 1/2	18
RS-35A	25	35	5 $\times$ 11 $\times$ 11	27
RS-50A	37	50	6 $\times$ 13 3/4 $\times$ 11	46

### RS-M SERIES



MODEL RS-35M

MODEL	Continuous Duty (Amps)	ICS* (Amps)	Size (IN) H $\times$ W $\times$ D	Shipping Wt. (lbs.)
• Switchable volt and Amp meter				
RS-12M	9	12	4 1/2 $\times$ 8 $\times$ 9	13
• Separate volt and Amp meters				
RS-20M	16	20	5 $\times$ 9 $\times$ 10 1/2	18
RS-35M	25	35	5 $\times$ 11 $\times$ 11	27
RS-50M	37	50	6 $\times$ 13 3/4 $\times$ 11	46

### VS-M AND VRM-M SERIES



MODEL VS-35M

- Separate Volt and Amp Meters • Output Voltage adjustable from 2-15 volts • Current limit adjustable from 1.5 amps to Full Load

MODEL	Continuous Duty (Amps)			ICS* (Amps) @ 13.8V	Size (IN) H $\times$ W $\times$ D	Shipping Wt. (lbs.)
	@ 13.8VDC	@ 10VDC	@ 5VDC			
VS-12M	9	5	2	12	4 1/2 $\times$ 8 $\times$ 9	13
VS-20M	16	9	4	20	5 $\times$ 9 $\times$ 10 1/2	20
VS-35M	25	15	7	35	5 $\times$ 11 $\times$ 11	29
VS-50M	37	22	10	50	6 $\times$ 13 3/4 $\times$ 11	46
• Variable rack mount power supplies						
VRM-35M	25	15	7	35	5 1/4 $\times$ 19 $\times$ 12 1/2	38
VRM-50M	37	22	10	50	5 1/4 $\times$ 19 $\times$ 12 1/2	50

### RS-S SERIES



MODEL RS-12S

- Built in speaker

MODEL	Continuous Duty (Amps)	ICS* Amps	Size (IN) H $\times$ W $\times$ D	Shipping Wt. (lbs.)
RS-7S	5	7	4 $\times$ 7 1/2 $\times$ 10 3/4	10
RS-10S	7.5	10	4 $\times$ 7 1/2 $\times$ 10 3/4	12
RS-12S	9	12	4 1/2 $\times$ 8 $\times$ 9	13
RS-20S	16	20	5 $\times$ 9 $\times$ 10 1/2	18



a high impedance parallel resonant circuit. It's possible that dividing the coupling link into two series parallel resonant circuits, one at 144 MHz and the other at 220 MHz, might further reduce the mixer losses.

I tried both hot carrier and high speed switching diodes, and noted no discernible difference. The HCDs may offer the advantage of better performance with lower LO drive as the battery voltage falls off. Diodes like the 1N914 or 1N4148 work well in this mixer.

### Mixer limitations

The mixer has 12 dB of insertion loss. This is a little high and is a fair compromise between cost and circuit simplicity. Despite the losses, I achieved a respectable 0.5- $\mu$ V sensitivity with the ICOM 2-AT. Repeaters within 20 miles of my QTH are full quieting with only a rubber duck antenna. With just one tuned stage used at each mixer port, unwanted converter image responses and high levels of LO and related harmonic energy leakage may occur. The converter offers about 20-dB attenuation port to port. Thus, for example, a strong signal on 146.82 MHz may compete with a repeater on 223.82 MHz.

### Where to find the parts

I made every effort to use common parts. Many of the components can be found at the local Radio Shack. Most of the other parts (trimmer caps, toroids, FETs, etc.) can be obtained via mail order. I recommend you try Radiokit or Circuit Specialists. I used handwound coils and capacitive tuning, and avoided the high cost of slug-tuned inductors, which are hard to find anyway. I also used inexpensive 35-pF plastic trimmer capacitors. Radio Shack currently offers 50-pF trimmers. You can use these in a pinch, but you may find the tuning overly sharp. The airwound coils were made from no. 22 gauge hookup wire stripped of its insulation and wound over a pencil. The wire gauge isn't especially critical; neither are the coil dimensions — within reason.

### Alignment

Oscillator tuning is performed by monitoring the current drawn by the converter. When oscillating, the current will drop sharply — typically from 8 mA to about 2 to 4 mA. The trick here is to trade maximum oscillator output for reliable oscillator startup when power is removed and reapplied. The oscillator should maintain oscillation and start reliably with voltages as low as 6 volts. If you use it, set the warping inductor to minimum inductance (slug out) during testing. You may use a frequency counter to set the oscillator to exactly 38.500 MHz, or you can simply adjust for minimum distortion on monitored signals. The oscillator's fourth harmonic can also be zero beat to 144.000 MHz on an SSB transceiver.

Tune the 144 and 220-MHz tuned stages for best sensitivity. You can use a signal generator or strong local 220-MHz signal. If a peak occurs at minimum or maximum capacity, try spreading or compressing the coil windings to compensate. Finally, you can tweak the oscillator tank slightly for best sensitivity. You may have to retweak the input circuit a bit if you change antennas. Use a 220-MHz antenna for best sensitivity.

I use a 9-volt alkaline battery for power. The battery will last a long time with only a 2 or 3-mA draw. For continuous monitoring use a wall plug-type power supply. The converter

is forgiving of accidental transmitter keying, but it is not burn-out proof. Always set the handheld to low power before connecting the converter.

### Using the converter with a service monitor

Need 220-MHz coverage on your service monitor? This converter makes that possible. First, calibrate the converter. Set the preselector and CE-3 to monitor 144.000 MHz. Connect the 2-meter port to the preselector input and adjust the oscillator frequency to exactly 144.000 MHz. This sets the converter to the limits of the CE-3's own calibration.

To monitor a 220-MHz signal, connect the converter 2-meter port to the preselector input. Set the Cushman to the 2-meter frequency corresponding to the 220-MHz frequency to be monitored. You can now make very accurate 220-MHz frequency and deviation checks. Connecting the 2-meter port to the signal generator output will produce 220-MHz signals. Although the generator calibration won't be very accurate because the conversion losses will affect the readings, you can still perform meaningful relative comparisons and receiver peaking. 

#### Crystals

International Crystal Manufacturing Company  
P.O. Box 26330  
701 West Sheridan  
Oklahoma City, Oklahoma 73126-0330

#### Case, resistors, miscellaneous components

Radio Shack, local retail outlet

#### RF part, trimmers, caps, resistors, toroids, etc.

RADIOKIT  
P.O. Box 973  
Pelham, New Hampshire 03076

Jameco Electronics  
1355 Shoreway Road  
Belmont, California 94002

BCD Radio Parts Company  
P.O. Box 119  
Richardson, Texas 75080-0020

Circuit Specialists  
Box 3047  
Scottsdale, Arizona 85257

#### Toroids

Amidon Associates  
12033 Otsego Street  
North Hollywood, California 91607

A well-stocked junkbox is the best source of parts. I suggest writing the above companies for current catalogs; prices, minimum orders, and stock vary continually.

# DIGITAL SIGNAL PROCESSING

## PART 1: THE FUNDAMENTALS

By Bryan P. Bergeron, NU1N, 30 Gardner Road, Apt. 1G, Brookline, Massachusetts 02146

The introduction of transistors and other solid-state devices over the past 20 years has changed the way most of us think about and work with electronic circuitry. As radical as the change from tube-type to solid-state devices and circuits seemed, the current progress in digital signal processing (DSP) technology suggests that an even greater revolution is at hand. Signal processing itself isn't new to electronics or communications — it was used extensively during World War II to remove the noise and clutter from radar signals.<sup>1</sup> Most early signal processing was done in analog form and was of limited value. The introduction of specialized DSP chips has kindled a new interest in signal processing using powerful *digital* techniques. Just as the digital compact disk (which relies on DSP techniques) has redefined the standards in the field of music recording and reproduction, DSP technology promises to drastically enhance the power and flexibility of Amateur and commercial communications systems. This article, the first in a series, examines the fundamentals of digital signal processing and provides experiments in DSP techniques that you can perform on your home computer.

### DSP fundamentals

To compare and contrast DSP and classic circuit design techniques, I'll approach a simple problem from both perspectives. For discussion's sake, assume that a low frequency audio signal is accompanied by a significant amount of high frequency noise — for example, a 1000-Hz CW signal accompanied by considerable QRN, most of which is higher than 1000 Hz in frequency at the receiver audio stage. The task is to provide low pass filtering to minimize the amplitude of the high frequency components of the offending noise, without appreciably degrading the desired CW signal.

The standard approach to this problem is to design either an RC or RL low pass filter comprised of discrete components. The DSP approach is considerably more involved and requires several components including an analog antialiasing filter, an analog to digital (A/D) converter, a digital filter and, in the form of hardware and computer instruc-

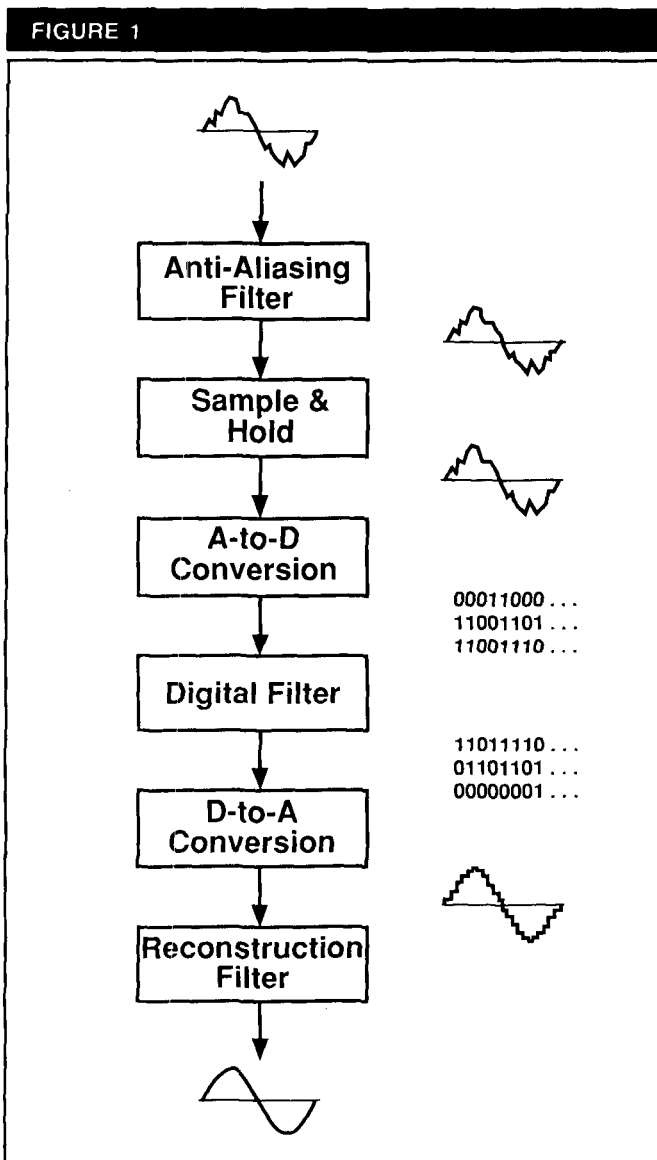

A digital signal processing system configured to provide low-pass filtering of an analog signal.

tions, a digital to analog (D/A) converter and an analog reconstruction filter (see Figure 1).

## Antialiasing filter

The analog antialiasing filter removes extraneous noise or other higher frequency signals that, when sampled by A/D conversion circuitry, could appear as false low frequency signals. This effect of folding higher frequencies down to lower frequencies is often called aliasing, hence the name antialiasing filter.

## A/D converter

The A/D converter can be thought of as a combination sampler, quantizer, and encoder. The A/D converter samples the analog input signal at evenly spaced intervals of time, and produces an accurate, digital representation of the instantaneous signal amplitude.

Of the wide variety of techniques available for analog-to-digital signal conversion, the most common include parallel encoding, successive approximation, voltage-to-frequency conversion, and single slope integration.<sup>2</sup> Each of these basic techniques has its own tradeoffs in terms of relative accuracy, speed, and expense. A/D converters vary in sampling rate, quantization noise, dynamic range, and digitization technique used.

The Nyquist sampling theorem states that the minimum sampling frequency is at least twice that of the signal to be sampled. The sampling rate effectively limits the upper frequency range of signals that can be digitized accurately. To adequately digitize a 50-kHz analog signal, the digitizer should sample the input waveform at least 100,000 times/second. Sampling at a lower rate results in aliasing, a significant source of noise in A/D conversion. One way to avoid aliasing is to use a low pass (antialiasing) filter that cuts out frequencies greater than half of the sampling rate.

Both the quantization noise and the dynamic range of an A/D converter are related to how the digital data is represented. Eight-bit digitizers, which represent amplitude variations with integers from 0 to 255, generally have more quantization noise than 12 or 16-bit digitizers. Quantization noise can be thought of as the high frequency noise introduced into a digitized waveform due to the "staircase effect" inherent in the A/D process. For example, even though the amplitude of an analog signal smoothly varies from 2 to 3 volts, an eight-bit digital representation of the signal might show sudden jumps from 2.0 to 2.5 to 3.0 volts. A 16-bit digitizer, on the other hand, might record less drastic changes. The less jagged representation provided by the 16-bit digitizer should result in less associated quantization noise. You can also think of quantization noise as the difference between the true value and the actual value of a waveform that would be observed on an oscilloscope if the digital representation were immediately applied to a D/A converter.

The digital representation of signal amplitude defines the maximum dynamic range (the difference between the largest and smallest signal that can be recorded) of a digitized signal. The dynamic range of an A/D converter, equivalent to the signal-to-noise ratio of a converter, is related to the number of bits used to represent a waveform by the following equation:<sup>3</sup>

$$SNR = 6.02 n + \log_{10} (1.5) \text{ dB}$$

where  $n$  is the number of bits used in the digital representation of the sinusoidal waveform, not including the sign bit. That is, an eight-bit ( $N = 8$ ;  $n = 7$ ) A/D converter uses one bit for sign (+ or -) and seven bits ( $n = 7$ ) for magnitude. For example, with  $N = 8, 12, 16,$  and  $32,$  the  $SNR = 42, 66, 90,$  and  $187 \text{ dB},$  respectively.

## Digital filter

The digital filter (in actuality a computer program or algorithm) works with the digitized signal data to produce the desired output, which is also in digital form. Unlike a conventional system based on discrete components, all waveform manipulations in a digital filter are implemented in software. In many respects, this operation is not unlike everyday data processing. It just so happens that the data represents signal amplitude levels, as opposed to financial account balances or the current value of stocks and bonds. The other qualification is that DSP deals with *real time* analog signals which are processed digitally.

Because of the computational demands of digital filtering, systems based on general purpose microcomputers typically are limited to applications where the signals have bandwidths of only a few hundred hertz. Specialized DSP chips, which can be interfaced to a microcomputer system, extend the working bandwidth by several orders of magnitude. I'll discuss a working example of a microcomputer-based algorithm that implements digital low pass filtering for signals in the audio frequency range later in this article.

## D/A converter

The D/A converter performs the inverse function of the A/D converter described earlier. The output of the digital filter is converted by the D/A conversion circuitry into an analog signal. Like A/D converters, D/A converters suffer from the staircase effect, in that a continuous output signal is represented as abrupt changes in amplitude.

## Reconstruction filter

Like the antialiasing filter, the reconstruction filter is typically an analog low pass filter composed of discrete components. Its purpose is to remove the high frequency staircase artifact introduced by the D/A conversion process.

## Advantages of DSP

Given the above signal processing environment, the digital filter designer would still be faced with the problem of specifying the sample rate for the A/D and D/A converters, selecting the implementation hardware, and creating or locating the appropriate algorithm for the desired characteristics of the digital filter. The designer also has to work around the memory and computational limits of the hardware platform.

With these demands, why would anyone ever consider using DSP techniques instead of conventional methods of circuit design? The major reason is flexibility, especially when complex filtering operations are considered. For simple problems, the DSP solution is much more complex than the conventional alternative. However, this distinction fades when you consider complex filtering involving multiple inputs. While the DSP system would be able to perform all needed operations without a change in physical configuration, a conventional analog system would probably require numerous discrete components for each filtering

operation. A DSP system can be transformed into a specific tool with changes only in programming.

Digital signal processing has additional advantages over analog systems developed with discrete components. DSP techniques are stable, repeatable, and predictable. DSP systems don't degrade with time, suffer from temperature drift, or change operating characteristics with age. The mathematical relationships and binary operations within a digital system remain constant, making the outcome completely predictable and reproducible from one DSP system to another.

Using DSP, the conventional hardware design task is transformed into a programming problem. Once you know the algorithms, it's relatively straightforward to get a process working. The bulk of the development cycle is typically spent improving the speed and performance of the algorithms. Many operations that are difficult or nearly impossible to achieve with conventional analog processing techniques, like linear phase filtering, are almost trivial with today's DSP techniques. DSP promises to minimize the design and testing time inherent in circuit design and maximize the designer's flexibility when solving particular problems.

## DSP limitations

DSP techniques are not without their limitations. In addition to quantization noise and limited dynamic range, DSP suffers from round-off and truncation errors, along with limited bandwidth.

## Round-off and truncation errors

All digital computations, especially those that use multiple operations on floating point numbers (3.1415926535898 or  $\pi$ , for example) are prone to errors. Because of the way in which the two components of a floating point number (the mantissa and the exponent) are handled, computations involving numbers in floating point format aren't exact. Even when hardware is dedicated to floating point operations, the cumulative results of multiple mathematical manipulations will become significant, given enough iterations.

*Round-off errors*, like quantization noise and limited dynamic range, are due to computer hardware limitations. They can be minimized by the judicious use of appropriate data types and algorithms. Another type of error, independent of the computer hardware, can be attributed to the algorithms used. *Truncation errors* occur when algorithms use approximations to arrive at an answer. Instead of computing the sum of an infinite series, a practical algorithm might stop after a sufficient number of elements in the series have been added. Truncation error can best be thought of as the difference between the actual answer and the answer obtained via a practical calculation. Unlike round-off errors, which are inherent to the hardware platform, truncation errors can be minimized by selecting the appropriate algorithms for a given problem.

## Limited bandwidth

Although there are DSP systems which operate in real time on microwave signals (massively parallel over-the-horizon radar receiving installations<sup>4</sup>), most of us will have to contend with the limited bandwidth of current commercial DSP devices.

The best of today's generally available DSP chips use

clock frequencies of up to 42 MHz to realize cycle times of as low as 50 nanoseconds.<sup>3</sup> Depending on how many signals must be handled concurrently, the usable bandwidth of these devices approaches only a few hundred kHz.

## DSP hardware

For the past several decades, the use of digital signal processing has been limited by the inherent limitations of available computer hardware. Although digital signal processing can be done with a general purpose computer system, only the relatively recent introduction of special purpose digital hardware has moved DSP from the research laboratory into the hands of engineers and developers. The introduction of VLSI chips that can perform signal processing algorithms in parallel, with many chips operating simultaneously, makes it possible to perform many signal processing tasks up to a thousand times faster than present computers — including supercomputers.<sup>1</sup>

## Dedicated integrated circuits

The first generation of dedicated DSP devices, like the INTEL 2920 introduced in 1979, had on-chip scratch pad (RAM) and program memory (EPROM), sample and hold circuitry, and a high speed digital processor, along with D/A and A/D converters.<sup>5</sup> With a 10-MHz clock, this 40-pin DIP chip was fast enough to perform real time processing on analog signals. It was used extensively to implement frequency and phase filters, as well as peak detectors.

Since the introduction of the INTEL 2920, there have been two subsequent generations of dedicated DSP devices. Examples of later generation devices are Texas Instruments' TMS320, Analog Devices' ADSP2100, Motorola's DSP5600, NEC's MPD7720, Fujitsu's MB8764, and AT&T's WE DSP32. These later devices typically provide much more program memory than the 2920, allowing for more conventional programming techniques. That is, some devices provide enough memory to permit programmers to work in high level languages — like C, as opposed to ASSEMBLER.

Compared to the INTEL 2920, which was limited by its on-board A/D and D/A converters, these newer devices have been used to implement a wide variety of digital filters for a variety of applications. The TMS320 has been a popular building block of portable spectrum analyzers.<sup>6</sup> All current DSP chips use a single 5-volt supply, and are designed to interface directly with TTL devices.

## Device architectures

DSP chips are designed with one primary consideration: speed of execution. Unlike the serial nature of the general purpose microcomputer, DSP devices use parallel architectures and pipelining to increase execution speed. Unlike the typical microcomputer which handles one instruction at a time, DSP devices perform multiple operations simultaneously. A complex problem that might take 20 instruction cycles to solve in a serial device might take only six instruction cycles in a parallel device.

Most DSP chips make use of the Harvard Architecture, where the program memory is separate from data memory.<sup>3</sup> This allows data to be fetched concurrently with program instructions. The Harvard Architecture contrasts sharply with the architecture of conventional computer systems, in which only a data value or a program instruction can be moved from one memory location to another at a time.



# 63 years and still serving the amateur's needs..now two more fine new amplifiers

## *the* 3KD Classic *the* 2KD Standard

Now you have a  
choice of four high  
quality HF desk  
models providing  
the performance  
and reliability you  
have come to  
expect from a  
Henry Amplifier



### 3KD CLASSIC. . .new to the Henry line

1500 W PEP nominal output SSB and CW. 1000 Watts ICAS, RTTY, and FM, covering the 3.5 to 30.0\* MHz frequency range. Nominal gain: 15 to 20 times input drive. Tube complement consists of one remarkable new Eimac 3CX-1200D7 ceramic triode. It uses a Pi-L plate circuit with a silver plated tank coil for maximum efficiency and attenuation of unwanted harmonics.

### 2KD STANDARD. . .new to the Henry line

Smaller than the 2KD Classic and with a slightly lower power output, but still the same rugged construction, the same superior components, the same dependability. The 2KD Standard is a 1200 W PEP nominal output SSB, CW, 750 W RTTY FM RF linear covering the 3.5 to 30.0\* range. It uses a Pi-L plate circuit with a silver plated tank coil for maximum attenuation of unwanted harmonics. Its tube complement consists of one Eimac 3-500Z glass envelope triode in a grounded grid circuit.

### 3KD PREMIER

The same superb specs as the Classic, BUT with the addition of 160 meter operation and QSK break in keying. Both the Premier and the Classic desk models are no nonsense. . .no compromise amplifiers that will please the most discerning amateur for many years to come.

### 2KD CLASSIC

A proven desk top workhorse providing full legal power. Uses two Eimac 3-500Z glass envelope triodes plus a full complement of top quality components. And, as with all Henry amplifiers is backed by an enduring history of the most reliable equipment available for the amateur market.

\*10 meters available on export models only

**For additional information on these and the rest of the fine line of Henry amplifiers please call or write for our new information packet.**

*The Henry line of amplifiers also offers four very heavy duty HF floor consoles in addition to several UHF and VHF models. In all, we now offer 15 different amplifiers. . .more than any other manufacturer that we know of. One of them has to be just right for you.*

*In addition to our broad line of amateur and commercial FCC type accepted amplifiers we offer special RF power generators for industrial and scientific users. Call or write Ted Shannon for full information.*

Try our new 24 hour "Bulletin Board Service"  
... (213) 826-4954



## Henry Radio

2050 S. BUNDY DR. • LOS ANGELES, CA 90025 • (213) 820-1234  
Toll free order number: (800) 877-7979 TELEX: 67-3625(Henradio) FAX (213) 826-7790

# HITACHI SCOPES AT DISCOUNT PRICES

## Digital Storage Scopes



VC-6025 20MS/S  
50MHz Bandwidth  
2K Word Memory  
Capacity  
**\$2349.00**

Advanced storage functions create new dimensions in scopes such as one shot observation, flicker free display, bright display for even high speed event, trace observation for low speed event, hard copy by plotter and data output to computer.

VC-6045 100MHz 40MS/S 4K word Memory cap (call)

All Hitachi scopes include probes, schematics, and Hitachi's 3 year worldwide warranty on parts and labor. Many accessories available for all scopes.



**\$425**  
List \$595  
Save \$170  
DC to 20MHz  
Dual Channel



V-1060  
List \$1595 **\$1,359**

- DC to 100MHz
- Dual Channel
- Delayed Sweep
- CRT Readout
- Sweep Time
- Autoranging
- Trigger Lock
- 2mV Sensitivity

	LIST	PRICE	SAVE
V-422 40MHz D.T., 1mV sens, DC Offset Vert Mode Trigger, Alt Mag	\$940	\$740	\$200
V-423 40MHz D.T., 1mV sens, Delayed Sweep, DC Offset, Alt Mag	\$1,025	\$825	\$200
V-425 40MHz D.T., 1mV sens, DC Offset, CRT Readout, Cursor Meas	\$1,070	\$849	\$221
V-660 60MHz D.T., 2mV sens, Delayed Sweep, CRT Readout	\$1,295	\$1,145	\$150
V-1065 100MHz D.T., 2mV sens, Delayed Sweep, CRT Readout, Cursor Meas	\$1,895	\$1,670	\$225
V-1100A 100MHz Q.T., 1mV sens, Delayed Sweep, CRT Readout, DVM, Counter	\$2,450	\$2,095	\$355
V-1150 150MHz Q.T., 1mV sens, Delayed Sweep, Cursor Meas, DVM, Counter	\$3,100	\$2,675	\$425

# ELENCO PRODUCTS AT DISCOUNT PRICES

## 20MHz Dual Trace Oscilloscope

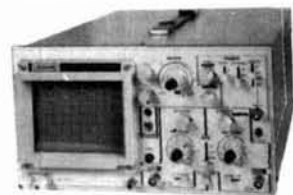

**\$375**  
**MO-1251**

- 6" CRT
- Built in component tester
- TV Sync

## FREE DMM

with purchase of  
ANY SCOPE

### SCOPE PROBES

P-1 65MHz, 1x, 10x \$19.95  
P-2 100MHz, 1x, 10x \$23.95

## 35MHz Dual Trace Oscilloscope



**\$495**  
**MO-1252**

- High luminance 6" CRT
- 1mV Sensitivity
- 6KV Acceleration Voltage
- 10ns Rise Time
- X-Y Operation • Z Axis
- Delayed Triggering Sweep

Top quality scopes at a very reasonable price. Contains all desired features. Two 1x, 10x probes, diagrams and manual. Two year guarantee.

## PRICE BREAKTHRU on Auto Ranging DMMs



3 to choose from:  
MDM-1180 **\$24.95**  
MDM-1181 **\$27.95**  
MDM-1182 **\$29.95**

- 3 1/2 LCD Display
- 27 Functions
- Auto/Manual Ranges
- Audible Continuity
- Data Hold (MDM-1182)
- 1% Accuracy (MDM-1181)



True RMS 4 1/2 Digit Multimeter  
**\$135** M-7000

.05% DC Accuracy  
.1% Resistance with Freq. Counter and deluxe case



Multimeter with Capacitance and Transistor Tester  
**\$55** CM-1500

Reads Volts, Ohms, Current, Capacitors, Transistors and Diodes with case

## Digital Capacitance Meter

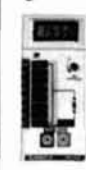

CM-1550  
**\$58.95**

9 Ranges  
.1pf-20,000ufd  
.5% basic accy  
Zero control with case

## Digital LCR Meter

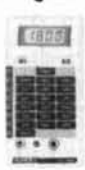

LC-1801  
**\$125**

Measures Coils 1uH-200H  
Caps .1pf-200uf  
Res .01-20M

## Bench DMMs



M-3500  
3 1/2 digit  
.1% accy

M-4500  
4 1/2 digit  
.05% accy



AC Current Meter  
ST-1010  
**\$69.95**

1000 Amps  
Data&Peak Hold  
8 Functions  
Deluxe Case

## Solderless Breadboards



9430 1,100 pins **\$15**  
9434 2,170 pins **\$25**  
9436 2,860 pins **\$35**  
All have color coded posts  
9436 SHOWN

## AC Clamp-On



Current Adapter  
ST-265  
**\$25.00**  
0-1000A AC  
Works with most DMM

## Wide Band Signal Generators

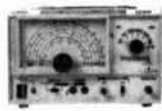

SG-9000 **\$129**  
RF Freq 100K-450MHz  
AM Modulation of 1KHz  
Variable RF output

SG-9500 with Digital Display and 150MHz built-in Freq Ctr \$249



AUDIO GENERATOR  
SG-9200  
**\$129**

Low distortion (<.05%)  
10-1MHz Sine/Square Wave  
600 ohm Output Impedance, High Output Voltage

## Function Generator



Blox  
#9600  
**\$28.95**

Provides sine, tri, squ wave from 1Hz to 1MHz  
AM or FM capability

## Decade Blox



#9610 or #9620  
**\$18.95**

#9610 Resistor Blox  
47 ohm to 1M & 100K pot  
#9620 Capacitor Blox  
47pf to 10MFD

## Digital Triple Power Supply

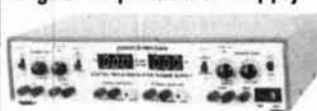

XP-765  
**\$249**

0-20V at 1A  
0-20V at 1A  
5V at 5A

Fully Regulated, Short circuit protected with 2 Limit Cont., 3 Separate supplies

XP-660 with Analog Meters \$175

## Quad Power Supply



XP-580  
**\$59.95**

2-20V at 2A  
12V at 1A  
5V at 3A  
-5V at 5A

Fully regulated and short circuit protected

XP-575 without meters \$39.95

## AM/FM TRANSISTOR RADIO KIT with TRAINING COURSE

Makes a great school project  
Model AM/FM-108  
14 Transistors + 5 Diodes  
**\$26.95**

Circuits are laid out in systematic order on an oversized PC board for easy understanding of the flow of radio signals, from antenna to speaker. Complete course includes all parts, PC board and training manual. When completed you will be proud to display your masterpiece.

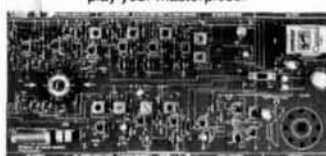

7 Transistor AM RADIO KIT \$16.95

## Four-Function Frequency Counters



F-100 120MH  
**\$179**  
F-1000 1.2GH  
**\$259**

Frequency, Period, Totalize, Self Check with High Stabilized Crystal Oven Oscillator, 8 digit LED display

## GF-8016 Function Generator with Freq. Counter



**\$249**

Sine, Square, Triangle Pulse, Ramp, .2 to 2MHz  
Freq Counter .1 - 10MHz

GF-8015 without Freq. Meter \$179

**WE WILL NOT BE UNDERSOLD!**  
UPS Shipping: 48 States 5%  
(\$10 Max) IL Res., 7% Tax



**C & S SALES INC.**  
1245 Rosewood, Deerfield, IL 60015  
(800) 292-7711 (708) 541-0710

**15 Day Money Back Guarantee**  
**2 Year Warranty** Prices subject to change  
**WRITE FOR FREE CATALOG**

In addition to separate data and program memory, DSP chips have a number of dedicated processing units that can work in a highly coordinated fashion. One or more arithmetic logic units (ALUs) handle addition, subtraction, logical operations, and address generation. The shifter scales data to or from other processor units, while the multiplier (MAC) performs multiplications.

## DSP chip instruction sets

The instruction sets (an instruction set is the native language of a microprocessor chip) supported by specialized DSP chips are in many respects comparable to those supported by the multipurpose CPUs used in popular microcomputers. DSP devices regularly support an impressive assortment of arithmetic and logic operations, data and program control, condition testing, and system control instructions specifically designed to support signal acquisition and processing.

## DSP software

Every DSP program has two components: one that deals with signal acquisition, and one that's concerned with the actual processing. Of the two components, signal acquisition is usually the most straightforward, perhaps because the alternatives are limited. Designers are typically constrained by the resolution, sampling rate, and dynamic range associated with a particular A/D converter, even in a system designed around a general purpose microcomputer. On the other hand, designers have considerable flexibility in the design of the actual signal processing software.

Perhaps the most significant software design issue, especially in a microcomputer-based DSP system, is whether to work in the frequency or time domain — that is, whether to represent signal amplitude as a function of time or frequency. This decision is akin to deciding between using an oscilloscope or a spectrum analyzer as a diagnostic tool; it depends on your experience with the tools in question and on the problem at hand. Traditionally, digital signal processing in the time domain has been avoided in favor of the more powerful processing available when working in the complex frequency domain. Although there's increased activity in investigating time domain signal processing,<sup>9</sup> frequency domain work continues to be the most popular method of signal processing.

Even so, most of us are more comfortable working in the time domain. After all, recording events relative to the passage of time is part of our everyday lives. Many of our test instruments, including the common oscilloscope, assume that time is the point of reference. Electronic signals are commonly expressed as functions of time. Time usually serves as the point of reference in the analysis of common circuits, like the charging of a capacitor. Were you to view the charging of a capacitor on an oscilloscope screen, you'd see a familiar voltage curve increasing exponentially over time.

Anyone who has worked with a spectrum analyzer appreciates the unique perspective it provides. A conventional time-domain oscilloscope simply isn't useful in assessing quantitatively the spectral quality or bandwidth of a signal. Similarly, there are operations in signal processing that just can't be performed easily in the time domain. For example, consider the problem of constructing a linear phase filter — a low pass filter that has linear phase characteristics over the operating frequency range of the filter. The

very concept of phase linearity is foreign to the design of high and low pass filters in the time domain, where we work with magnitude characteristics without regard to phase.

By working in the frequency domain with mathematical techniques like the Fourier Transform, a filter designer can manipulate the phase characteristics of a filter easily. Just as a spectrum analyzer is easy to understand and use, designing filters and other circuits in the frequency domain can become second nature once you understand the nature of the device and the mathematical tools involved.

## DSP with your personal computer

For signals in the audio spectrum, the capabilities of even the most modest personal computer are sufficient to demonstrate basic DSP techniques. Some microcomputer systems, like the Commodore 64, have hardware dedicated specifically to DSP tasks. I'll describe the DSP capabilities of the C-64 hardware in more detail in the next section, along with two BASIC programs that demonstrate the capabilities of this class of hardware environment.

## Audio frequency DSP with the C-64

The 6581 Sound Interface Device (SID) in the C-64 can be used as a simple DSP system. While the 6581 supports several tone oscillators, amplitude modulators, envelope generators, and A/D conversion, the most important characteristic from the perspective of DSP is its programmable filter. The digital filter section of the 6581 can provide high, low, bandpass, and notch filtering, as well as variable resonance and volume control over a range of 30 Hz to 12 kHz.<sup>7</sup> The rolloff is about 12 dB/octave.

The SID chip supports three separate software-definable filters whose outputs can be chained to produce a variety of effects. For example, both low pass and high pass filters can be selected to produce a notch filter response. The volume can be varied from no output to maximum volume in 16 linear steps. Because the SID chip provides no amplification, maximum volume represents no attenuation of the input signal.

The external analog audio input, applied to pin 5 of the C-64's audio/video socket (see **Figure 2**), shouldn't exceed 3 volts peak to peak. The input impedance is on the order of 100 k. The external signal can ride a DC voltage, if necessary, because the external input is AC-coupled to the SID chip through a 1- $\mu$ F electrolytic capacitor. The audio output of the SID chip, directed to pin 3 of the audio/video socket shown in **Figure 2**, has an impedance of approximately 1 k. The output level, set by the output volume control on the SID chip, reaches a maximum of 2 volts peak to peak. Like the audio input, the audio output of the SID chip is AC-coupled to the audio/video socket through a 1- $\mu$ F electrolytic capacitor.

**Table 1** describes the registers and SID chip addresses pertinent to the discussion of DSP. SID offset addresses 21 and 22 define the cutoff frequency used by the filters. Offset address 23 controls both the filter resonance and voice input controls; offset address 24 selects the filter mode and volume.

To better understand how the SID chip can be manipulated for DSP purposes, see the Commodore BASIC program in **Table 2**. This short routine provides an example of digital low pass filtering, with a cutoff frequency of 1000 Hz. The first step is to define the starting address, S or 54272,

**TABLE 1**

Register Address	Bits	Function
S + 21	□□□□■	Filter cutoff frequency: low-nibble
S + 22	■	Filter cutoff frequency: high-byte
S + 23	■ ■ ■ ■ □ □ □ □ □ □ □ □ ■ □ □ □	Filter resonance/voice input control Filter resonance: 0 - 15 Filter external input: 1 = Yes; 0 = No
S + 24	□ □ □ □ □ □ □ □ □ □ ■ □ □ □ □ □ □ □ ■ □ □ □ □ □ □ □ □ □ ■ □ □ □ □ □ □ □ ■ ■ ■ ■	Filter mode and volume High-pass mode: 1 = On Band-pass mode: 1 = On Low-pass mode: 1 = On Output volume: 0 - 15

**Description of the registers and SID chip addresses pertinent to the discussion of DSP.**

of the SID device (line 110) and then to clear the SID registers (lines 140 to 160). Next, define the cutoff frequency (lines 190 to 200). The decimal values to be POKEd into memory locations S+21 and S+22 can be determined by the following formula:

$$S+21 = \text{Frequency}_{Hz} \text{ MOD } 256$$

$$S+22 = \text{Frequency}_{Hz} - \{(S+21) \times 256\}$$

For example, with a cutoff frequency of 1000 Hz:

$$S+21 = 1000 \text{ MOD } 256 = 3$$

$$S+22 = 1000 - \{(3) \times 256\} = 1000 - 768 = 232$$

The Commodore, like many other microcomputers, stores multiple part numbers with the low part placed in the first memory location and the high part next. You should note that, because the maximum value that can be POKEd into the low bits of filter frequency cutoff (S+21) is 7 or 111 binary,<sup>8</sup> the cutoff frequency range is from 0 Hz to ((7 × 256) + 255), or 2047 Hz.

Now that you've initialized the SID chip and defined the cutoff frequency, you need to route the external audio input to the filter circuitry (line 220). Line 250 defines the resonance characteristics of the filter. In this example 7, a moderate value of resonance, is selected. To vary the amount of resonance provided by the filter, use the following formula:

$$\text{POKE } S + 24, \text{ PEEK } ((S + 24) + (R \times 16))$$

where R is equal to the amount of resonance desired from 0 to 15 (0000 to 1111 binary).

Next, you need to define the output volume of the filter (line 280). Like resonance, output volume can be varied from 0 to a maximum (as in this example) of 15. Remember that maximum volume is really minimum attenuation, as the C-64 doesn't provide amplification of the external audio signal.

Finally, you can define the type of filtering provided by the SID chip — in this case low pass filtering (Line 310). This filter will pass any frequency lower than the cutoff frequency set in addresses S+21 and S+22 without attenuation. See Figure 3 for a summary of this and other filter mode definitions that can be substituted for line 310 of Table 2.

**FIGURE 2**

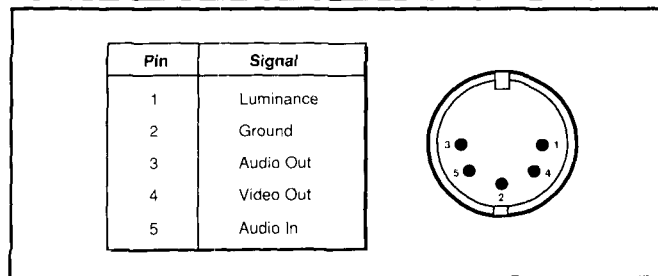

The audio/video port pinouts for the Commodore-64. Pins 2, 3, and 5 are used in the audio frequency DSP program described in the text.

**FIGURE 3**

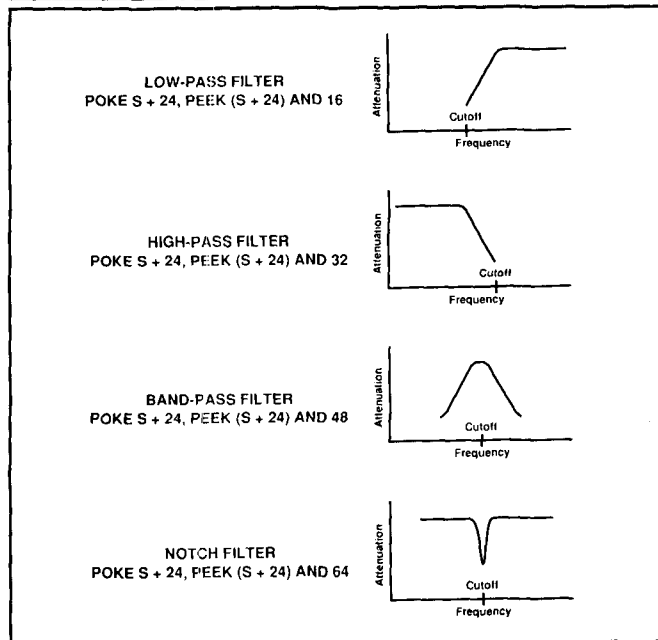

**Filter mode definitions that can be used with the Commodore-64's SID chip.**

Table 3 provides a more interactive DSP environment on the C-64. A standard game paddle can be used to vary the cutoff frequency of a notch filter in real time, from 0 to 2047 Hz. Line 110 defines the memory address for the start of the paddle routine. Because the paddles are unreliable when read from BASIC alone, a machine language routine (lines 340 to 400) is POKEd into memory (line 130). Next, as in Table 2, the SID chip address is defined (line 150) and the chip is reset (line 170). The filter is set up to handle an external audio signal (line 190), filter resonance is set to medium (line 210), and filter volume is set to maximum (line 230). Next, the filter mode is set to notch (line 250).

Because the machine language routine to read the paddle values (lines 340 to 400) returns a value between 0 and 255 when called (line 280), the value returned is multiplied by 8 to cover most of the frequency range supported by the filter, 0 Hz to 2047 Hz. For example, when the paddle value is read as 255, the value variable (V) is set to 8 × 255 or 2040. Because the cutoff frequency must be POKEd into the appropriate memory locations as separate high and low order bits, the value variable is decomposed





# The Magnificent Six Gives You More Power



## DR-570T

*Set your sights for dual!*

The Alinco DR-570T "Twin Bander" has dual LCD readout, volume, squelch and tuning controls. Double barreled power with 45W on 2M and 35W on 70 cm, plus simultaneous receive on both bands or intermix with four modes of scan. The DR-570T will win the "battle" with its illuminated front function panel and LCD readout, readable in any lighting conditions. Don't let the "Tiny" DR-570T fool you! It's fast, and leaves the competition in the dust with many standard features you expect. Cross band repeat with the flick of a switch. Full duplex, 20 memory channels, call channels, 16-key DTMF Microphone, and subtones are just a few. "Reach" for the DR-570T today!



## DR-510T

*Best Dual Value on the Market!*

The Alinco DR-510T has most of the outstanding features of its sister the DR-570T, including 14 memory channels, cross band duplex and cross band repeat. The multi color LCD display, and simple tune control panel makes simplicity the key word. The DR-510T with 45/35 watts is the best, feature-packed dual bander on the Amateur market today. See the DR-510T along with the other Alinco "Magnificent" ones at your favorite dealer today!

## DJ-500T

*Power-Packed Dual Handi!*

20 Memory channels, subtones, built-in DC to DC, 700 mah nicad battery, LCD readout with 6W on 2M and 5W on 70 cm (with optional battery) call channels, DTMF Touchtone, and direct keyboard entry, are just the few winning features of the Alinco DJ-500T Dual Band Handheld. Easy to use, and Value Priced at your Alinco Dealer.



## DR-110T&R-410T

*Tiny 2M Power From Alinco!*

DR-110T, this 2M Alinco, enters the nineties a proven winner with the "reputation" of best value. The DR-110T packs a powerful 45W on 2M and sports all the features you expect in today's transceivers. Tuning is a snap with the multi-functioned easy-to-see keyboard, 14 memory channels, subtones, scan, multi-colored LCD readout, reverse, are a few of the many features of the DR110T. The mobile of the future — today! DR-410T available for 70 cm.



## DJ-100T&DJ-200T

*Best 2M Micro Value Anywhere!*

The Alinco DJ-100T is "Magnificent" for its tiny size, but stands up to the competition with power and capability. 10 memory channels store offsets and subtones. Has LCD readout with call channel and reverse at your fingertips. 500 mah battery with direct DC to DC is standard. 3W on standard battery, 6W on optional battery leaves the competition in the dust! DJ-200T for 220 MHz.



## DJ-160T&DJ-460T

*2M H/T is here! And wow!*

"Bells & Whistles" is a tame word to use for the new DJ-160T, newest "Magnificent" one from Alinco. Keyboard entry is just one of four ways to enter a frequency in the extended receiver (137-173.995 Mhz) of the DJ-160T. You can store duplex/simplex pairs in any of 20 Memories, or Call Channel, with offsets, and any of 38 encoding subtones. Choose one of 3 scan modes, "Band" "Program" or "Memory" and one of five step ranges in VFO. Priority mode can be used in VFO, Memory or Call. "Dual Watch" allows the DJ-160T to scan 3 seconds alternately on CALL, VFO or one MEMORY. "Pager" is for group or single person alert. Other features include: Auto "Battery Save", Auto "Power Off", and 2-Memory Autodialer. Get 3-watts on standard 700 mah battery, or increased power from built-in DC to DC, or optional 12V battery. The Alinco DJ-160T, now the "Top Gun" with the competition today! DJ-460T for 70cm.



**ALINCO ELECTRONICS, INC.**

20705 S. WESTERN AVE., SUITE 104, TORRANCE, CALIFORNIA 90501  
TEL: (213) 618-8616 • FAX: (213) 618-8758

THE MOST POWERFUL  
HANDHELD LCR METER  
w/ DISSIPATION FACTOR  
**ANYWHERE!**



**\$ 249.00**

**BENCH-UNIT PERFORMANCE  
...AT 20% OF THE PRICE**

**FEATURES:**

- \* Drop-Proof, Heavy Duty.
- \* Inductance: 200uH to 200H.
- \* Capacitance: 200pf to 20mf.
- \* Resistance: 2 to 20M ohms. (max. resolution: 1 milliohm).
- \* Dissipation Factor Measurement (D=I/Q).
- \* 120Hz & 1KHz Test Frequencies.
- \* SMD or chip type component test probes available.

**APPLICATIONS:**

- \* Quality Control of transformers (opens, shorts).
- \* Finding opens and shorts of transmission lines.
- \* Capacitance & resistance measurement for SMD or chip type components.
- \* Precision measurement of milliohm applications.
- \* Phase Detection, Mutual inductance & Ratio of Turns for transformers.

Now ARI gives the ultimate in Handheld LCR Meters. For details, call **(800)654-9838**



**AMERICAN RELIANCE INC.**

9241E. VALLEY BLVD. ROSEMEAD, CA91770  
TEL: (818) 287-8400 FAX: (818) 287-8855

**Alpha Delta Model CLP  
Rotor Control Line  
Transi-Trap®  
Surge Protector**

**NEW**

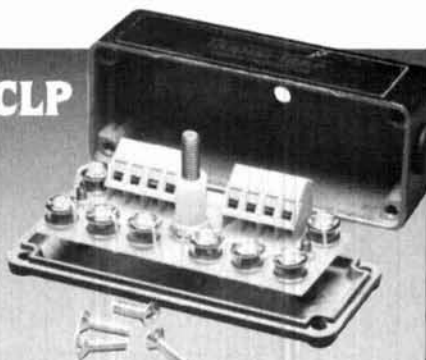

Protect your valuable communications equipment against destructive lightning-induced surge voltages that occur on the control lines to your rotor control and remote antenna switch boxes. Straightforward installation — no soldering.

- Protects up to eight 16 AWG wire control line cables . . . covers the most commonly used rotor and remote switch models. Requires no modification to control boxes.
- Utilizes eight NEMP-rated high surge current field-replaceable gas tube Arc-Plug® cartridges. Each line is individually protected.



**ALPHA DELTA COMMUNICATIONS, INC.**

P.O. Box 571, Centerville, Ohio 45459 • (513) 435-4772

current solutions to current problems



✓ 163

- High quality G-10/FR4 glass epoxy printed circuit board construction. Your control line connects directly to special industrial grade PC mount connectors for best low inductance discharge performance. Computer designed. No soldering required.
- Equally effective for modem/phone line protection. The low capacitance gas tube Arc-Plug cartridges accommodate high baud data transmission and greatly outperform competitive MOV models.

**Model CLP Control Line Transi-Trap Protector . . . . . \$49.95**

Also check out our line of time-proven Transi-Trap coax cable surge protectors. At your Alpha Delta Dealer. Or order direct in U.S.: add \$3.00 for postage and handling. MasterCard and VISA accepted. Ohio residents add Sales Tax. Exports quoted.

**NEMAL ELECTRONICS**

- \*Complete Cable Assembly facilities MIL-STD-45208
- \*Commercial Accounts welcome- Quantity pricing \* Same day shipping most orders
- \*Factory authorized distributor for Alpha, Amphenol, Belden, Kings, Times Fiber

Call NEMAL for computer cable, CATV cable, Flat cable, semi-rigid cable, telephone cable crimping tools, D-sub connectors, heat shrink, cable ties, high voltage connectors.

**HARDLINE 50 OHM**

FXA12 1/2" Aluminum Black Jacket.....	89/ft
FLC12 1/2" Cablewave corr. copper blk jkt .....	1.69/ft
FLC78 7/8" Cablewave corr.copper blk jkt .....	4.25/ft
NM12CC N conn 1/2" corr copper m/1 .....	25.00
NM78CC N conn 7/8" corr copper m/1 .....	54.00

**COAXIAL CABLES (per ft)**

1180 BELDEN 9913 very low loss .....	55
1102 RG8/U 95% shield low loss foam 11ga.....	36
1110 RG8X 95% shield (mini 8) .....	17
1130 RG213/U 95% shield mil spec NCV jkt.....	39
1140 RG214/U dbl silver shld mil spec.....	1.85
1705 RG142B/U dbl silver shld, teflon ins .....	1.50
1310 RG217/U 50 ohm 5000 watt dbl shld .....	98
1450 RG174/U 50 ohm .100" od mil spec .....	14

**ROTOR CABLE-8 CONDUCTOR**

8C1822 2-18ga and 6-22ga .....	25
8C1820 2-18ga and 6-20ga .....	39

**CONNECTORS-MADE IN USA**

NE720 Type N plug for Belden 9913 .....	\$3.9
NE723 Type N jack for Belden 9913.....	4.9
PL259AM Amphenol PL259 .....	.8
PL259TS PL259 teflon ins/silver plated.....	1.5
PL258AM Amphenol female-female (barrel).....	1.6
UG175/UG176 reducer for RG58/59 (specify).....	2.
UG21DS N plug for RG8,213,214 Silver .....	3.3
UG83B N jack to PL259 adapter, teflon .....	6.5
UG146A SO239 to N plug adapter, teflon .....	6.5
UG255 SO239 to BNC plug adapter, Amphenol.....	4.25
SO239AM UHF chassis mt receptacle,Amphenol.....	81
UG88C ENC plug RG58, 223, 142 .....	1.4

**GROUND STRAP-GROUND WIRE (per ft.)**

GS38 3/8" tinned copper braid .....	.4C
GS12 1/2" tinned copper braid .....	.5C
GS200 1-1/2" heavy tinned copper braid .....	2.0C
HW06 6ga Insulated stranded wire .....	.31
AW14 14ga stranded Antenna wire CCS .....	.1-

Prices do not include shipping, \$3 minimum, Visa/Mastercard \$30 min, COD add \$3.00  
Call or write for complete price list. Nemal's new 40 page CABLE AND CONNECTOR SELECTION GUIDE is available at no charge with orders of \$50 or more, or at a cost of \$4 with credit against next qualifying order.

**NEMAL ELECTRONICS, INC. 12240 NE 14th Ave. N. Miami, FL 33161  
(305) 893-3924 Telex 6975377 24hr FAX (305)895-8178**

into V1, the low order three bits, and V2, the high order eight bits (line 290). The high and low order bit values are then POKEd into their corresponding cutoff frequency memory locations (line 300). The endless loop structure set up by line 310 causes the cutoff frequency value to be updated continuously, therefore following the instantaneous game paddle position.

Equipped with the above programs, you can experiment with a variety of audio input and output hardware devices. For example, if you take moderate care to match the input and output impedances of the C-64 hardware with your communications gear, you can experiment with digitally processed CW signals. I found that a pair of common audio transformers, like the popular 1000 to 8-ohm variety (Radio

TABLE 2

```

100 REM DEFINE SID CHIP SOUND ADDRESS
110 S = 54272
120 REM
130 REM CLEAR SID CHIP REGISTERS
140 FOR I = 0 TO 28
150 POKE S + I, 0
160 NEXT I
170 REM
180 REM SET CUTOFF FREQ TO 1KHZ
190 POKE S + 21, 3
200 POKE S + 22, 232
210 REM FILTER EXTERNAL INPUT
220 POKE S + 23, PEEK (S + 23) OR 16
230 REM
240 REM SET RESONANCE TO MEDIUM
250 POKE S + 23, PEEK (S + 23) + (7 * 16)
260 REM
270 REM SET VOLUME TO MAXIMUM
280 POKE S + 24, 15
290 REM
300 REM SET FILTER MODE TO LOW PASS
310 POKE S + 24, PEEK (S + 24) AND 16

```

A BASIC listing for the Commodore-64 that illustrates audio-frequency DSP techniques. This program defines a low-pass digital filter with a cutoff frequency of 1 kHz.

FIGURE 4

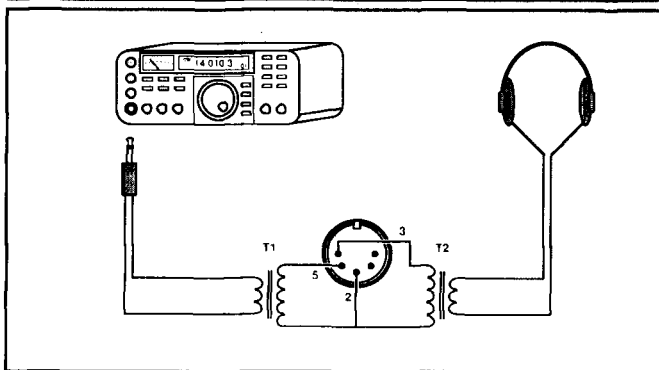

A suggested configuration for experimenting with DSP and real-time CW signals. Audio output from a receiver or transceiver is coupled to the relatively high impedance external audio input (pin 5) port of the Commodore-64, through an impedance matching transformer (T1). The digitally filtered audio output (pin 3) is coupled to low impedance headphones through a second impedance matching transformer (T2).

TABLE 3

```

100 REM DEFINE START OF PADDLE ROUTINE
110 C = 12 * 4096
120 REM READ IN PADDLE ML DATA
130 FOR I = 0 TO 63: READ A: POKE C + I, A: NEXT I
140 REM DEFINE SID CHIP SOUND ADDRESS
150 S = 54272
160 REM CLEAR SID CHIP REGISTERS
170 FOR I = 0 TO 28: POKE S + I, 0: NEXT I
180 REM FILTER EXTERNAL INPUT
190 POKE S + 23, PEEK (S + 23) OR 16
200 REM SET RESONANCE TO MEDIUM
210 POKE S + 23, PEEK (S + 23) + (7 * 16)
220 REM SET VOLUME TO MAXIMUM
230 POKE S + 24, 15
240 REM SET FILTER MODE TO NOTCH
250 POKE S + 24, PEEK (S + 24) AND 64
260 REM
270 REM SET CUTOFF FREQ
280 SYSC: V = 8 * PEEK (C + 257)
290 V1 = INT (V/256): V2 = V - V1
300 POKE S + 21, V1: POKE S + 22, V2
310 GOTO 280
320 REM
330 REM MACHINE LANGUAGE DATA
340 DATA 162, 1, 120, 173, 2, 220, 141, 0, 193
350 DATA 169, 192, 141, 2, 220, 169, 128, 141
360 DATA 0, 220, 160, 128, 234, 136, 16, 252
370 DATA 173, 25, 212, 157, 1, 193, 173, 26
380 DATA 212, 157, 3, 193, 173, 0, 220, 9, 128
390 DATA 141, 5, 193, 169, 64, 202, 16, 222
400 DATA 173, 1, 220, 141, 6, 193, 88, 96

```

A BASIC listing for Commodore-64 that provides an interactive environment for investigating audio DSP techniques. The cutoff (center) frequency of the digital notch filter can be controlled, in real time, by the position of a game paddle attached to the game port of the Commodore-64.

Shack no. 273-1380), are sufficient to couple receiver audio into the C-64 filter system and out to a pair of low impedance headphones (see Figure 4). Alternatively, you can experiment with an audio signal generator and your home stereo system or an audio amplifier.

Figure 4 shows a suggested configuration for experimenting with DSP and real-time CW signals. Audio output from a receiver or transceiver is coupled to the relatively high impedance external audio output (pin 5) port of the Commodore-64 through an impedance matching transformer (T1). The digitally filtered audio output (pin 3) is coupled to low impedance headphones through a second impedance matching transformer (T2).

### Time domain DSP with generic PC hardware

Experimentation with microcomputer-based DSP techniques needn't be limited to computer systems that come factory equipped with DSP hardware, like the Commodore 64, especially if real time processing isn't a necessity. Assuming that there's some way of moving real or simulated signal data into and out of working memory by means of D/A and A/D converter cards or simple data statements written in BASIC, then DSP is simply a matter of programming. (A variety of digital I/O boards and peripherals are available for the popular microcomputer systems through a number of sources including MetroByte Corporation, 440 Myles Standish Boulevard, Taunton, Massachusetts 02780.) Although the programs will typically be much more involved than the example listings I've provided for the C-64, they can also be much more powerful. You are no longer constrained to make do with the algorithms provided

TABLE 4

```

100 REM DEFINE VARIABLES, IN/OUT ARRAYS
110 LAST = 0
120 COUNT = 30
130 DIM INPT[COUNT]
140 DIM OUTPT[COUNT]
150 REM
160 REM READ INPUT SIGNAL INTO INPT ARRAY
170 FOR I = 1 TO COUNT: READ INPT[I]: NEXT I
180 REM
190 REM DEFINE FILTER TIME CONSTANT
200 INPUT "Cutoff Frequency (1-100)?", CUTOFF
210 IF CUTOFF < 1 OR CUTOFF > 100 THEN 170
220 X = CUTOFF * 628 / 256
230 ALPHA = (X * X * 35 - 9644 * X + 1000000) / 1000
240 REM
250 REM FILTER INPUT SIGNAL
260 FOR I = 1 TO COUNT
270 TEMP = (1024 - ALPHA) * (INPT[I] * 1024)
280 TEMP = (TEMP + (ALPHA * LAST)) / 1024
290 LAST = TEMP
300 OUTPT[I] = INT(TEMP / 1024)
310 NEXT I
320 REM
330 REM PRINT FILTER OUTPUT
340 CLS
350 FOR I = 1 TO COUNT: PRINT OUTPT[I]: NEXT I
360 REM
370 REM STEP SIGNAL OF AMPLITUDE 20
380 DATA 0, 0, 0, 20, 20, 20, 20, 20, 20, 20
390 DATA 20, 20, 20, 20, 20, 20, 20, 20, 20, 20
400 DATA 20, 20, 20, 20, 20, 20, 20, 20, 20, 20

```

A BASICA listing for the IBM-PC and clones that illustrates time-domain DSP with generic computer hardware. The program simulates a first order recursive low-pass filter, with a user-definable cutoff frequency.

in ROM, but are free to develop your own digital signal processing algorithms.

The program in Table 4, developed in BASICA for the IBM PC, provides for low pass filtering in the time domain (frequency domain filtering will be considered in a future article). For those who don't have a digital I/O board for their PC, the input data for the filter is supplied by data statements within the program. Remember that in an actual digital processing system, the input and output would be directed, through the I/O board, to a buffer in preparation for processing.

This program simulates a first order recursive (IIR) low pass filter, with a user-definable cutoff frequency. The filter is said to be recursive because at any given moment the output of the filter is a function of the current and previous inputs and previous outputs.<sup>10</sup> Recursive filters, while generally superior in performance to nonrecursive filters (filters which don't feed on their own output), suffer from problems associated with instability.<sup>11</sup> While nonrecursive filters are always stable, recursive filters may not be, so the output of a poorly designed recursive filter may increase exponentially — even though the input has ceased. The challenge associated with designing recursive filters comes in selecting filter coefficients that minimize instability while providing the required filter response.

The underlying equation defining the operation of the low pass filter in Table 4 is:

$$Output_n = \{(K - \hat{\alpha}) \times (Input_n \times K) + (\hat{\alpha} \times Output_{n-1})\} / K$$

Where  $\hat{\alpha}$  is the low pass filter time constant, and the coeffi-

FIGURE 5

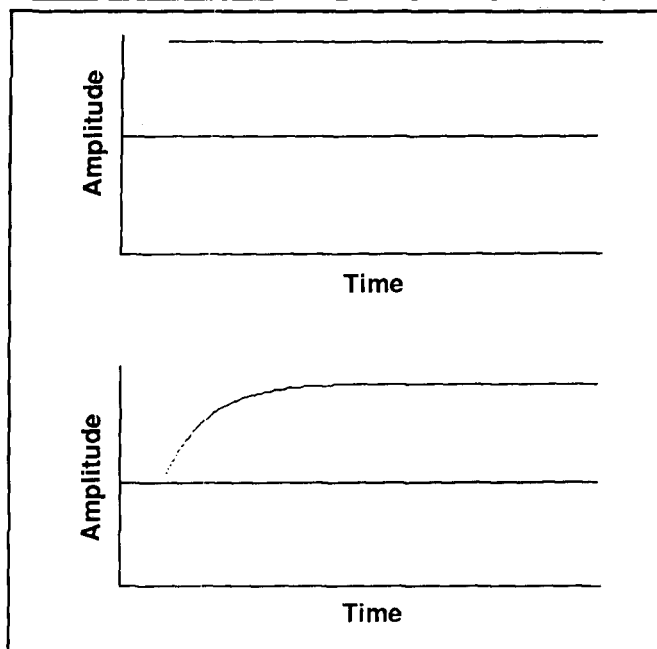

Input to (top) and output from (bottom) the first-order recursive low-pass filter defined in Table 4 (bottom). The step function, defined in the DATA statements of Table 4, was sent through the filter with the cutoff frequency set to 1 Hz.

cient  $K$  is taken to be  $2^{10}$ , or 1024. As you can see, the output of this recursive filter is due in part to the previous filter output value ( $Output_{n-1}$ ).

In this example,  $\hat{\alpha}$  is related to the filter cutoff frequency by the following equation:

$$\hat{\alpha} = \{(Cutoff \times K_1)^2 \times K_2 - K_3 \times (Cutoff \times K_1) + K_4\} / K_5$$

where the coefficients  $K_1$ ,  $K_2$ ,  $K_3$ ,  $K_4$ , and  $K_5$  are defined as 2.45, 35, 9644, 1000000, and 1000, respectively, and Cutoff is the cutoff frequency in hertz. For an excellent introduction to how these coefficients are selected, see the texts by Hamming<sup>12</sup> and Rice.<sup>13</sup>

Given the preceding relationships, it's rather easy to define the filter in a BASIC program. As shown in Table 4, the first step is to declare the variables and arrays used in the program (lines 110 to 140). The variable LAST holds the previous output of the filter; that is,  $Output_{n-1}$ . COUNT is the number of data points in the input signal. In line 170, the input data is read into the input data array, INPT. In this example, a step signal of amplitude 20 is used as the input to the filter (lines 380 to 400). Remember that in an actual DSP application, the input data would be routed in real time to the filter input.

Lines 200 to 230 define the filter constant,  $\hat{\alpha}$  in terms of the desired cutoff frequency. Notice that the cutoff frequency range has been limited to between 1 and 100 Hz (line 210). This range will be more than sufficient to examine the effect of digital low pass filtering on the input signal provided. (Note that the cutoff and signal frequencies are relative.)

The actual filter processing takes place in lines 260 to 310. For each input data element, an output value is calculated, based on the filter constant and the previous output value.



The output of the filter is saved into the LAST variable for the next filter cycle (line 290). In line 300, the filter output is both scaled and converted from a real to an integer value for a more esthetic output. Line 340 clears the screen in preparation for a listing of the filter output values (line 350).

In place of the simple listing of filter output, you can substitute a graphic plotting routine to get a better grasp of the relationship between cutoff frequency and filter output over time. The lower half of **Figure 5** shows the plotted output of the program in **Table 4**, with a cutoff frequency of 1 Hz. To make the plot, the data statement was extended to contain 70 additional input signal points, and the count variable adjusted to 100 accordingly. The filter output was then sent to an Apple Macintosh plotting program for the graphical representation.

The plots shown in **Figure 6** were made in a similar manner by substituting sinusoidal data for the step data in lines 380 to 400 of the program. The input signal (**Figure 6**, top) has a frequency of 10 Hz. Notice the decreased amplitude of the output signal after processing by the digital low pass filter, which has a cutoff frequency of 1 Hz. Upon careful examination of the start of the output waveform (**Figure 6**, bottom), you'll notice that the baseline of the first sine wave is abnormally elevated. The subsequent output waveforms, however, seem to be centered squarely on the baseline.

This aberration is due to the assumptions made during initialization of the LAST variable, corresponding to  $Output_0$  in the program. Although an initial value of 0 for  $Output_0$  was appropriate for the step function, it wasn't optimum for the sinusoidal signal. If we know a priori about the nature of the input signal (that it always starts with a positive-going sine wave, for instance), then  $Output_0$  can be initialized to an appropriate (that is, negative) value, thereby minimizing the baseline distortion.

FIGURE 6

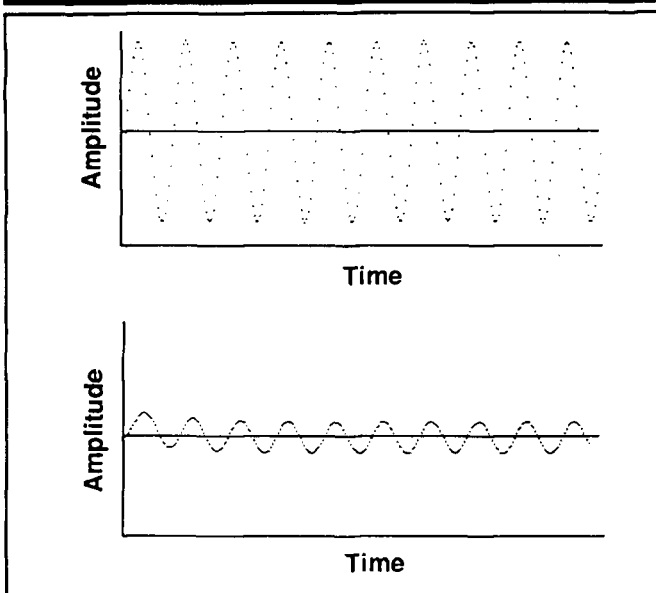

Input to (top) and output from (bottom) the first-order recursive low-pass filter defined in **Table 4** (bottom). To obtain this plot, the DATA statements in **Table 4** were modified to represent the 10 Hz sine wave with amplitude 40. As in **Figure 5**, the cutoff frequency of the filter was defined as 1 Hz. Note the elevated baseline of the first sine wave processed by the filter.

Modifying a prototype low pass filter made of discrete components to create a high pass filter would likely entail several minutes of additional soldering, in addition to the time it would take locate components with the appropriate values. Because you're working with algorithms and not components in the DSP domain, circuit modifications are mere keystrokes away. For example, the low pass filter described in **Table 4** can be modified to work as a recursive high pass filter if you substitute the following line for the one in the complete listing:

```
270 TEMP = 1024 * ((INPT[I] * 1024) - LAST)
```

This BASIC statement, together with the supporting code in lines 260 to 300, implements the following relationship:

$$Output_n = \{ (K (Input_n \times K) - Output_{n-1}) + (\hat{a} \times Output_{n-1}) \} / K$$

where K and  $\hat{a}$  are defined as in the original low pass filter design.

## Summary

DSP may one day make conventional circuit design obsolete. Designers will no longer be concerned with component values and tolerances, but will deal with algorithms and software. In part 2, I'll consider techniques used for digital signal processing in the frequency domain, including the Fourier Transform. 

## REFERENCES

1. K. Sheldon, "Probing Space By Camera: The Development of Image Processing At NASA's Jet Propulsion Laboratory," *Byte*, March 1987, pages 143-148.
2. P. Horowitz, and W. Hill, "Digital Meets Analog," *The Art of Electronics*, Cambridge University Press, Cambridge, 1980.
3. A. Bateman, and W. Yates, *Digital Signal Processing Design*, Pitman, London, 1988, page 5.
4. B.P. Bergeron, NU1N, "Understanding Over-the-Horizon Radar," *Ham Radio*, February 1990, page 9.
5. J. Rittenhouse, "The Intel 2920," *Signal Processor Chips*, Quarmby ed., Granada Publishing Ltd., London, 1984.
6. P. Strzelecki, "The TMS320," *Signal Processor Chips*, Quarmby ed., Granada Publishing Ltd., London, 1984.
7. *Commodore 64 Programmer's Reference Guide*, Commodore Business Machines, Inc., and Howard W. Sams & Company, Inc., 1982, page 458.
8. P. Paveiko, and T. Kelley, *The Master Memory Map for the Commodore 64*, Reston Publishing Company, Inc., Reston, Virginia, 1983, page 82.
9. H.J. Hutchings, "Convolution-Time-Domain Signal Processing," *Electronics and Wireless World*, 1988, 94(1623): pages 109-110.
10. A.V. Oppenheim, A.S. Willsky, and I.T. Young, "Filtering," *Signals and Systems*, Prentice Hall, Englewood Cliffs, New Jersey, 1983.
11. W.H. Press, B.P. Flannery, S.A. Teukolsky, and W.T. Vetterling, "Fourier Transform Spectral Methods," *Numerical Recipes in C*, Press Syndicate of the University of Cambridge, Cambridge, 1988.
12. R.W. Hamming, *Digital Filters*, Prentice Hall, Englewood Cliffs, New Jersey, 1977.
13. J.R. Rice, *The Approximation of Functions*, Addison-Wesley, Reading, Massachusetts, 1964.

## RFI KIT

Use ferrite beads to keep RF out of your TV, stereo, telephone, etc. Kit includes one dozen beads, one dozen toroids 1/2" to 1 1/4" diameter, three "split beads" and our helpful RFI tip sheet. Everything needed to fix most RFI problems. \$15 + \$4 S&H U.S. and Canada. 7 1/4% tax in CA.

Free catalog and RFI tip sheet on request.

## PALOMAR ENGINEERS

Box 455, Escondido, CA 92025  
Phone: (619) 747-3343

# Practically Speaking

By Joseph J. Carr, K4IPV

## SOME ANALOG METER APPLICATIONS

In March I looked at analog meter movements, mostly those of DC meters. This month I'll expand the discussion to include some application issues (including meter movement protection) and a construction project.

### Meter protection

The electrical environment for meters is hostile enough that meter movements seem to be perpetually at risk of total destruction. There can be physical damage. A bent pointer can result when the meter is connected into a circuit where a severe overrange current flows, or if the meter is connected backwards in the circuit. The meter can also fail to perform properly because of the strong RF fields inside a piece of ham radio transmitting equipment. Fortunately, there are a few things you can do to protect your meter.

### Overcurrent protection

The simplest way to prevent meter movement damage from overcurrent is to place a fuse in series with the meter. This approach is reasonable when the meter has a current range compatible with fuse values, but there's no fuse for 1-mA (or less) meters. In fact, meter movements much under 100 mA probably can't be protected easily with a fuse.

Figure 1 shows a method used in some multimeters to prevent meter movement destruction when an overrange current tries to flow in the movement. Diodes CR1 and CR2 are silicon diodes (e.g., 1N4148) of the type used in low current meters; rectifier diodes (e.g., 1N400x) are used in high current meters. The silicon diode requires a forward bias potential of 0.6 volts or more for proper linear operation, and is virtually ineffective at potentials lower than about 0.3 volts. The voltage drop

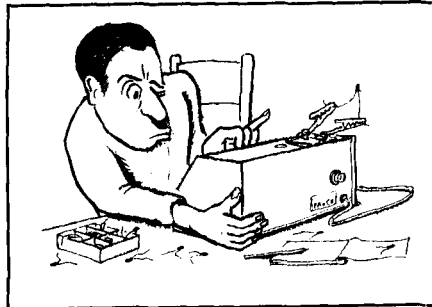
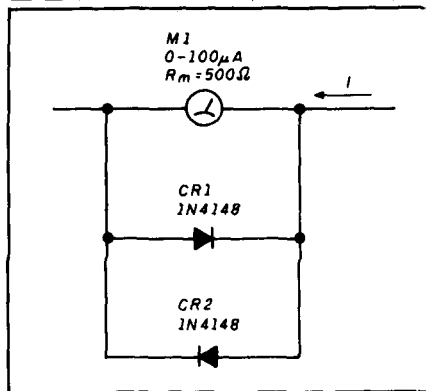
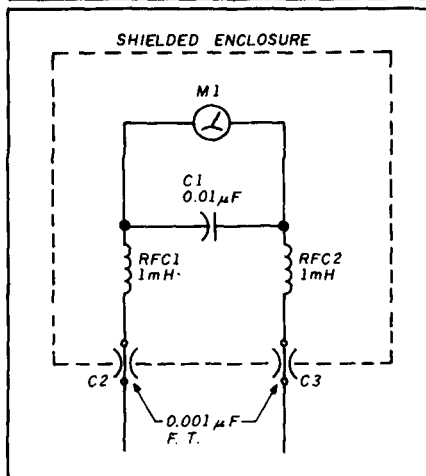

FIGURE 1



Protection diodes shunted across the meter movement.

FIGURE 2



RF protection diodes.

across the meter is the product of the current flowing in the meter and the meter's internal resistance ( $R_m$ ). In Figure 1, the meter movement is 100  $\mu$ A full scale and has an internal resistance

of 500 ohms. (Always check; the value in your meter will probably be different.) The full-scale current will produce a voltage drop of 500 ohms  $\times$  0.000100 A, or 0.05 volts. Under normal circumstances, the voltage drop won't forward bias CR1 and CR2. However, when a severely excessive current flows, a larger voltage drop will occur and the diodes will become forward biased. When this happens the diodes shunt the meter, protecting it from harm (though probably destroying themselves).

### RF protection

RF protection is a must for meters used in transmitters. Figure 2 shows several of the basic methods used to protect analog meters in transmitters and linear amplifiers. It's always wise to shield the meter in the RF environment. Either use an aluminum box or fashion a shield of your own design from sheet metal. The meter movement is usually mounted directly to the front panel of the equipment, so the shield can also be mounted in that fashion. This simplifies the design and makes simple boxes a reasonable approach.

In most cases, you can get away with using a single bypass capacitor across the meter terminals. Use a disk ceramic capacitor (or other type that will work at the frequencies used in the equipment) between 0.01  $\mu$ F and 0.5  $\mu$ F. Make sure the capacitor is mounted directly on the body of the meter movement, stretched between the electrical connection terminals of the meter. The capacitor leads should be as short as possible. In some cases, especially with high powered amplifiers, the RF chokes (at least 1 mH) should also be added in series with the meter movement. Capacitors C1 and C2 are 0.001- $\mu$ F feedthrough capacitors that are mounted directly to the shielded metal enclosure. If these aren't available or practical, use a 0.01- $\mu$ F disk ceramic capacitor mounted directly on the input connections to the shielded housing. In any event, regardless of how many of these fixes are incorporated into your project, keep all leads inside the shielded

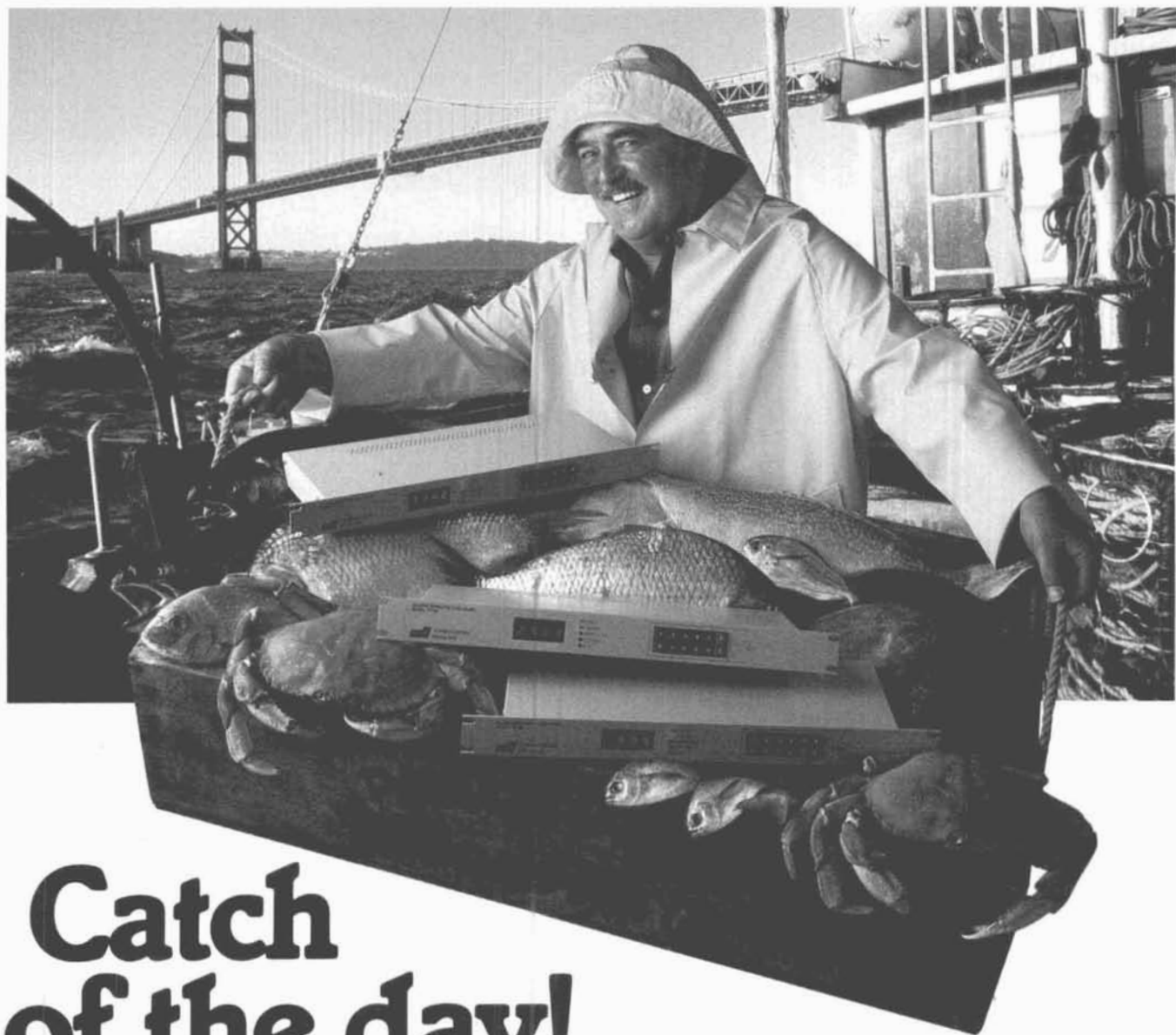

# Catch of the day!

Have you been trawling the bounding main for a new product? We have just netted it—the TP-38 microprocessor controlled community repeater panel which provides the complete interface between the repeater receiver and transmitter. Scuttle individual tone cards, all 38 EIA standard

CTCSS tones are included as well as time and hit accumulators, programmable timers, tone translation, and AC power supply at one low price of \$595.00. The TP-38 is packed like a can of sardines with features, as a matter of fact the only additional option is a DTMF module for \$59.95. This module allows complete offsite remote control of all TP-38 functions, including adding new customers or deleting poor paying ones, over the repeater receiver channel.

Other features include CMOS circuitry for low power consumption, non-volatile memory to retain programming if power loss occurs, immunity to falsing, programmable security code and much more. The TP-38 is backed by our legendary 1 year warranty and is shipped fresh daily. Why not set passage for the abundant waters of Communications Specialists and cast your nets for a TP-38 or other fine catch.



**\$595.00 each**  
**\$59.95 DTMF module**  
**\$149.95 Digital CTCSS modu**

*Now available with  
 Digital CTCSS*

**COMMUNICATIONS SPECIALISTS, INC.**  
 426 West Taft Avenue • Orange, CA 92665-4296  
 Local (714) 998-3021 • FAX (714) 974-3420  
 Entire U.S.A. 1-800-854-0547



FIGURE 3

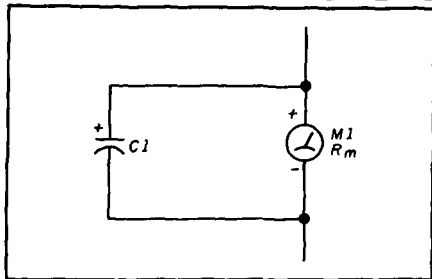

Integrating or low-pass filtering the meter movement.

enclosure as short as possible to minimize RF pickup.

### Damping

Some signals have either too much variation or too much noise present on them to be read effectively on an analog meter movement. In those cases it's possible to *integrate* (time average) the meter reading by connecting a capacitor across the meter terminals (see Figure 3). This is an old trick in the instrumentation trade. I've seen capacitors from 0.1  $\mu\text{F}$  to 500  $\mu\text{F}$  strapped across the meter terminals. The time constant of the circuit ( $R_m C_1$ ) tells you something about the amount of averaging in any given case.

### Amplified meters

The bare meter movement is sometimes boosted with an amplifier circuit to improve sensitivity or perform certain specific instrumentation jobs. One application (see Figure 4A) is to provide a higher input impedance to a microammeter or milliammeter (M1) that's connected as a voltmeter. The sensitivity of a 0 to 1-mA or even 0 to 100- $\mu\text{A}$  meter movement might be too poor for practical use, especially in solid-state circuits. But if the meter is *buffered* with an operational amplifier (op amp), as in Figure 4A, then the circuit sees the high input impedance of the op amp (A1). In order to maintain that high impedance, be sure to use a device with a very high input impedance. The CA-3140 type is a good example of such a device, and it's both inexpensive and widely available from mail order and local parts sources.

In the circuit of Figure 4A the op amp (A1) is connected in the *unity gain noninverting follower* configuration. When a DC voltage ( $V_{in}$ ) is applied to the +IN terminal of the op amp, exactly

the same potential appears at the output terminal; that is, point A. The full-scale input voltage and the series resistors are used to custom tailor the meter movement for voltmeter service. The sum of R1 and R2, denoted R, is found from:

$$R = \frac{V_{in(max)} - I_{fs} R_m}{I_{fs}} \quad (1)$$

where R is the sum  $R_1 + R_2$ ,  $V_{in(max)}$  is the maximum allowable full-scale input voltage,  $I_{fs}$  is the full-scale current of meter M1, and  $R_m$  is the internal resistance of M1.

If you want the meter to see an amplified voltage, then use the alternate *noninverting follower with gain circuit*<sup>1</sup> of Figure 4B. The DC voltage gain of this circuit will be:

$$A_V = \frac{R_4}{R_3} + 1 \quad (2)$$

The voltage at point A (Figure 4A) will

be  $A_V V_{in}$ . In that case, the maximum voltage at point A will be used in place of  $V_{in(max)}$  in Equation 1 to find R.

The reason for making the meter multiplier resistor from two resistors ( $R_1$  and  $R_2$ ) instead of a single resistor is twofold. First, it allows a series combination of a fixed resistor and a potentiometer to replace a hard-to-find precision resistor. Second, it lets you adjust the meter to full scale easily. Apply the maximum value of input voltage to the noninverting input of the op amp and then adjust R2 for a full-scale deflection of M1.

Figure 4B shows an optional *zero adjust* circuit. This circuit injects a counter current into the summing junction of the op amp (at the inverting input). This current is used to counteract any DC offset that's present in the op amp output. To adjust R7, short the input terminal (the noninverting input of A1) to ground, and mechanically zero the meter movement pointer

FIGURE 4A

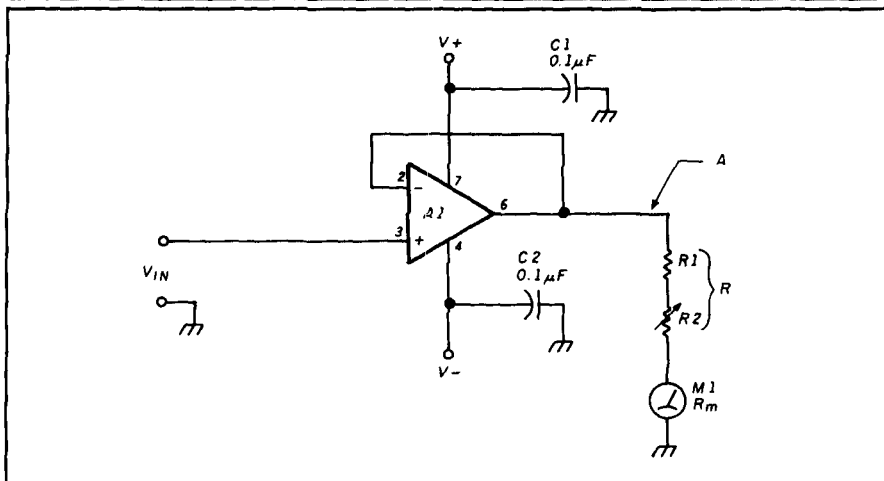

Unity gain voltmeter.

FIGURE 4B

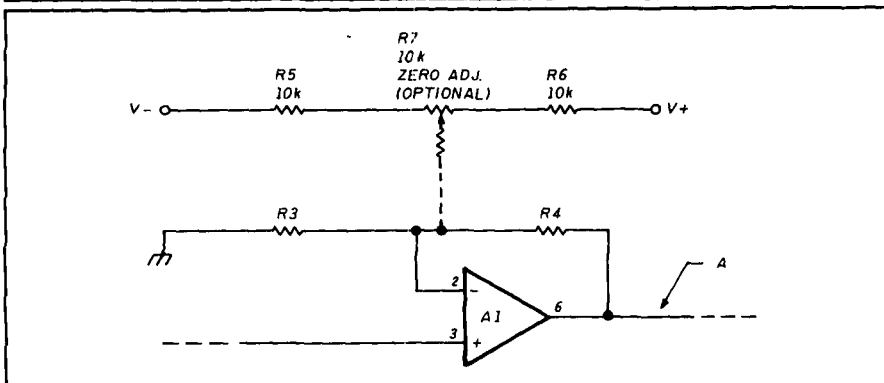

Gain voltmeter.

# MADISON ★ ★ ★ SHOPPER

**CALL FOR ORDERS**  
**1 (800) 231-3057**  
**1 (713) 520-7300 or**  
**1 (713) 520-0550**  
**FAX 1 (713) 358-0051**

**TEXAS ORDERS CALL COLLECT.**  
**ALL ITEMS ARE GUARANTEED**  
**OR SALES PRICE REFUNDED.**



New Yaesu FT-1000D..... Trades wanted  
 Kenwood TH215A, TH25AT..... Trade in your old HT  
 TS440 S/AT..... Call  
 New Kenwood TM-731A, mobile..... Call  
 ICOM IC-24AT..... Call



TS 790A Superior 2 Meter 70 cm Rig,  
 1.2 GHz Option Available..... Call  
 BW VS 300A..... 99.00  
 Penta 6146B..... 12.00  
 Penta 572B..... 79.00  
 Penta 3-500Z..... 99.00  
 Penta 811A..... 12.00  
 Penta 4CX250B..... 79.00  
 Icom 765..... 2695.00  
 NYE MB5A Tuner..... 629.00  
 Alpha Delta Transitrapp HV..... 33.00  
 CSI Private Patch V..... 489.00

Ampire VHF, UHF GaAsFET preamps..... Call  
 831SP-PL259 Silverplate (Amphenol)..... 1.50  
 82-61 N Male (Amphenol)..... 3.50  
 82-202-1006 N Male (9913)..... 3.50  
 Double Female UHF..... 1.00  
 UG176 RGBX..... each .40  
 Surplus Elbow PL259-SO239..... each \$1  
 Receiving tubes 50-90% off list price..... Call  
 3 Amp RF Meter, 2.5" Round New, Boxed..... 30.00  
 25 pF/10KV Doorknob Cap..... 5.00  
 100mFd/450V axial cap..... 4.00  
 Throat Mike (new mil. surplus)..... 5.00  
 Yaesu FT 747, 757/II..... Call  
 GGT Morse Tutor..... 18.00



New Kenwood TS 950-SD..... Call  
 Ameco PT 3 Pre Amp..... 99.00  
 Larsen 2-meter on glass..... 49.95  
 Anteco 2M, 5/8, Mag. Mount, Comp..... 25.00  
 YAESU FT-1000D..... Call for price



Kenwood TS 140S..... Call for trade  
 Van Gordon Windom WA2..... 44.00  
 Bird 43, elements/stock..... Call  
 Thousands of panel meters..... 3.95 up CALL  
 Belden 9913, 8267, 8214 Stock..... Call  
 MICA Capacitors..... Call

### USED EQUIPMENT

All equipment, used, clean, with 90 day warranty and 30 day trial. Six months full trade against new equipment. Sale price refunded if not satisfied.

(800) 231-3057

### POLICIES

Minimum order \$10.00. Mastercard, VISA, or C.O.D. All prices FOB Houston, except as noted. Prices subject to change without notice. Items subject to prior sale. Call anytime to check the status of your order. Texas residents add sales tax. All items full factory warranty plus Madison warranty.

**Bird and Belden products in stock. Call today.**

# MADISON

**Electronics Supply**  
 3621 FANNIN  
 HOUSTON, TEXAS 77004

**NEW SUPER LONG PLAY TAPE RECORDERS**  
 12 Hour Model — \$119.00\*  
 USES D-120 TAPE



Modified Panasonic Slimline, high quality, AC-DC Recorders provide 6 continuous hours of quality recording & playback on each side of cassette for a total of 12 hours. Built-in features include: • Voice level control, • Digital counter, etc. TDK DC 120 Cassette Furnished.

**PHONE RECORDING ADAPTER**  
 Records calls automatically. All Solid state connects to your telephone jack and tape recorder. Starts recording when phone is lifted. Stops when you hang up. **\$28.50\***



**VOX VOICE ACTIVATED CONTROL SWITCH**  
 Solid state. Self contained. Adjustable sensitivity. Voices or other sounds automatically activate and control recorder. Uses either recorder or remote mike. **\$28.50\***



\*Add for ship & hdig. Phone Adapter & Vox \$1.50 ea. Recorders \$4.00 ea. Cal. Res. add tax. Mail order, VISA, M/C, COD's OK. Money Back Guarantee. Qty. disc. avail. Dealer Inquiries invited. Free data. **AMC SALES INC.** Dept. 9335 Lubec St., Box 928, Downey, CA 90241 Phone (213) 869-8519

## Measure Up With Coaxial Dynamics Model 81000A RF Directional Wattmeter

Model 81000A is a thoroughly engineered, portable, insertion type wattmeter designed to measure both FWD/RFL C. W. power in Coaxial transmission lines.

81000A is comprised of a built-in line section, direct reading 3-scale meter protected by a shock-proof housing. Quick-match connectors, plus a complete selection of plug-in elements, gives the FRONT RUNNER reliability, durability, flexibility and adaptability with a two year warranty.

Contact us for your nearest authorized Coaxial Dynamics representative or distributor in our world-wide sales network.



**COAXIAL DYNAMICS, INC.**

15210 Industrial Parkway  
 Cleveland, Ohio 44135  
 216-267-2233  
 1-800-COAXIAL  
 Telex: 98-0630



Service and Dependability... A Part of Every Product

See us at Dayton Booths 401 & 402



**TE  
SYSTEMS****RF POWER AMPLIFIERS**

NEW!

**400 WATTS**  
(144-148 MHz)

TE SYSTEMS new HPA Series of high power amplifiers now available through select national distributors.

All amplifiers are linear (all-mode), automatic T/R switching, and incorporate optional GaAs FET preamp. Amps are usable with a wide input drive level range. Thermal shutdown protection and remote control capability included. All units are designed to ICAS ratings and meet FCC part 97 regulations. Approx. size is 2.8 x 10 x 11.5" and weight is 8 lbs.

Consult your local dealer or send directly for further product information.

**TE  
SYSTEMS****TE SYSTEMS**

P.O. Box 25845  
Los Angeles, CA 90025  
(213) 478-0591

**SPECIFICATIONS**

Model	Freq. MHz	Power		Preamp		DC +Vdc	Power A	RF Conn.
		Input	Output	NF-dB	Gain-dB			
0550G	50-54	10	400	.6	15	13.6	60	UHF
0552G	50-54	25	400	.6	15	13.6	55	UHF
1450G	144-148	10	400	.6	15	13.6	54	UHF
1452G	144-148	25	400	.6	15	13.6	50	UHF
2252G	220-225	25	220	.7	14	13.6	36	UHF
4450G	420-450	10	175	1.1	12	13.6	34	N
4452G	420-450	25	175	1.1	12	13.6	29	N

Models also available without GaAs FET preamp (delete G suffix on model #). All units cover full amateur band - specify 10 MHz bandwidth for 420-450 MHz amplifier. Continuous duty repeater amps also available.

Amplifier capabilities: 100-200 MHz, 225-400 MHz, 1-2 GHz, Military (28V), Commercial, etc. also available - consult factory.

## 500,000 Radio Amateur Call Signs at Your Fingertips

### Introducing Buckmaster's HamCall on CD-ROM

Over 500,000 call signs in the U.S. and possessions are available, searchable by call sign, name, address, city, state, Zip code or license class. Using CD-ROM optical disc technology and your micro-computer, you have instantaneous access to the Buckmaster HamCall data base.

**\$499.95 per Package  
plus Shipping (Quantities Limited)**

HamCall on CD-ROM is a package that includes the CD-ROM data disc, a Sony CDU-6100 external CD-ROM drive with interface card for IBM PC/AT type computers,\* and MS-DOS CD-ROM extensions software.

Publishers Data Service Corporation's new Questar™ retrieval software package is also supplied. This retrieval system enables the user to search the CD-ROM data quickly and efficiently.

**Order by calling 1-800: 282-5628**

**SONY****BUCKMASTER**

"Whitehall" Rte. 3, Box 56  
Mineral, Virginia 23117  
703: 894-5777



\*Requires 640k RAM, hard disk drive and MS-DOS 3.1 or later version.

From Here



To Here

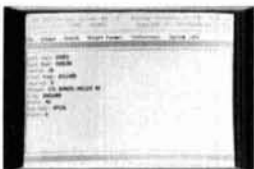

Instantly!

## WIN AN ICOM 1275, OR AEA FS430! OR ONE OF SEVERAL OTHER PRIZES!

Your home video about any aspect  
of Ham Radio could win!

Enter the WWATS/ATVQ  
Ham Video Contest.

For rules and entry form send SASE to:  
WWATS/ATVQ Video Contest  
1545 Lee Street, #73  
Des Plaines, IL 60018  
Entry deadline March 1, 1990. Enter today.

Contest sponsored by Western Washington  
ATV Society and Amateur Television Quarterly  
Magazine. Winners announced at Dayton 1990.

(there's usually a small screw adjustment on the front panel of the meter). Next, turn on the circuit and adjust R7 for exactly zero reading on the meter.

Figure 5 shows how to make a milliammeter or microammeter into a higher current instrument with an amplifier. Resistor R1 is a small value, precision resistor that's placed in series with the load ( $R_L$ ) of the circuit. The current flowing in the circuit without this resistor is  $V_{dc}/R_L$ , and with the resistor it reduces slightly to  $V_{dc}/(R_L + R1)$ . It's very important to make  $R1 \ll R_L$  to prevent errors.

The op amp is connected in the DC differential amplifier configuration, and has a differential DC voltage gain of  $R4/R2$ . The input signal seen by the amplifier (A1) is the voltage drop across R1, which is  $I \times R1$ . The voltage appearing across the meter circuit at point A is  $V_{in}R4/R2$ . It's important to keep  $R2 = R3$  and  $R4 = R5$ . The values of R6 and R7 are found in the same manner as in the example of Figure 4A.

### Precise AC voltmeters

The AC voltmeter is made from the DC meter movement plus a rectifier. Last month you saw a bridge rectifier that can be used to make the meter read AC values. Unfortunately, that circuit is limited when it comes to very low voltage circuits. The problem is caused by the fact that PN junctions are diodes which are used to rectify the AC before applying it to the meter movement, and aren't linear in the low range of forward bias voltage (see Figure 6A). The ideal diode I-versus-V curve is a straight line from zero to maximum current. It's said to be an *ohmic device* because it obeys Ohm's law. But actual diodes are ohmic only in the region above a certain critical voltage ( $V_g$ ); this voltage is 0.2 to 0.3 volts in germanium diodes and 0.6 to 0.7 volts in silicon diodes. Below  $V_g$  the diode is nonlinear, and therein lies the problem.

A "fix" for nonlinearity is to replace the diode with a *precise rectifier circuit* like Figure 6B. This circuit uses an op amp to "servo-out" the nonlinearities and make the diode act more like the ideal diode. That's why this circuit is also called the *ideal rectifier* or *ideal diode* circuit. Diodes CR1 and CR2 are ordinary silicon signal diodes like 1N914s and 1N4148s.

The diodes are shown in Figure 6B

FIGURE 5

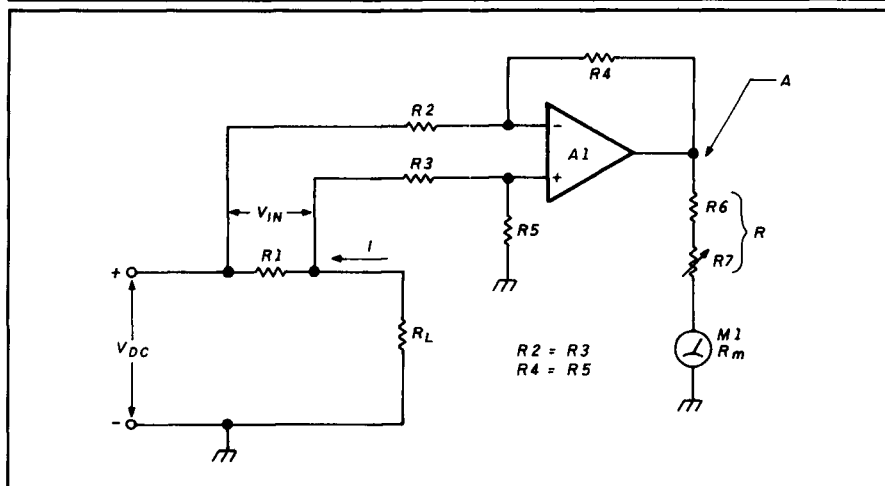

Amplified current meter.

in the direction that will produce a positive  $V_o$  with positive  $V_{in}$ ; this circuit is called a *positive precise rectifier*. Reversing the diode direction (turning them around) will produce a positive output voltage with negative input voltage (*negative precise rectifier*).

Unfortunately, the circuit of Figure 6B is only a half wave and won't prove as useful in many applications. A *full-wave precise rectifier*, also called an *absolute value circuit*, is shown in Figure 6C. This circuit combines a positive precise rectifier and a negative precise rectifier into a single output. The output is obtained by amplifier A1, which is a gain-of-one summer. As long as all three resistors have the same value, the output voltage ( $V_{odc}$ ) will be the sum of the two rectifier outputs ( $V_{o1}$  and  $V_{o2}$ ), and will be a full-wave rectified pulsating DC waveform.

### RMS AC voltage measurement

Simple rectified meters produce a

reading that's related to the average voltage of the pulsating DC waveform produced by the rectifier. It can be interpreted to be the *root mean square (rms)* voltage only if the scale is so calibrated *and* the input waveform remains a sine wave. However, that condition isn't often met in practice. A

FIGURE 6A

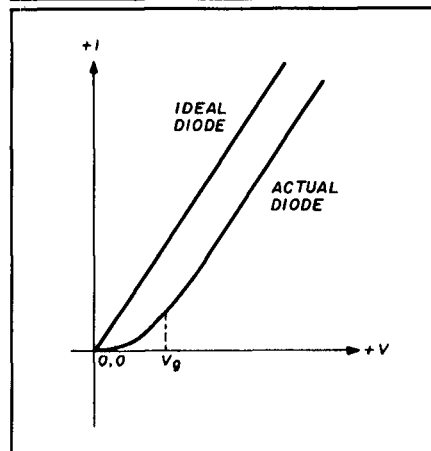

Ideal and actual diode I-versus-V curves.

FIGURE 6B

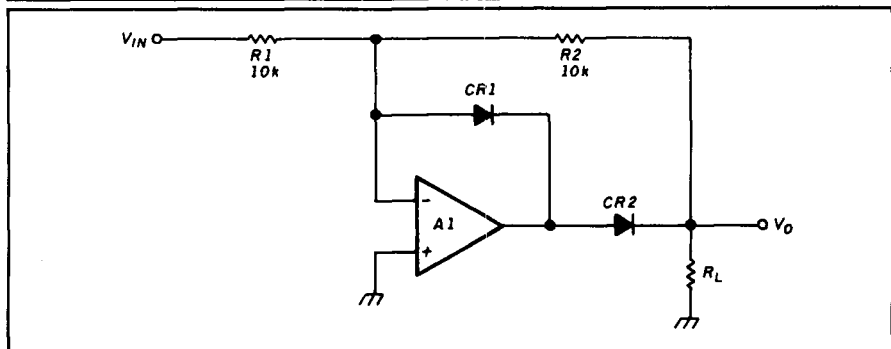

Half-wave precise rectifiers.

FIGURE 6C

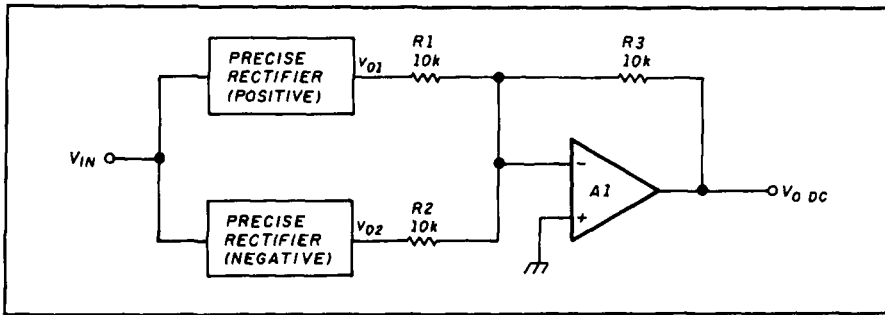

Block diagram of a full-wave precise rectifier.

FIGURE 7

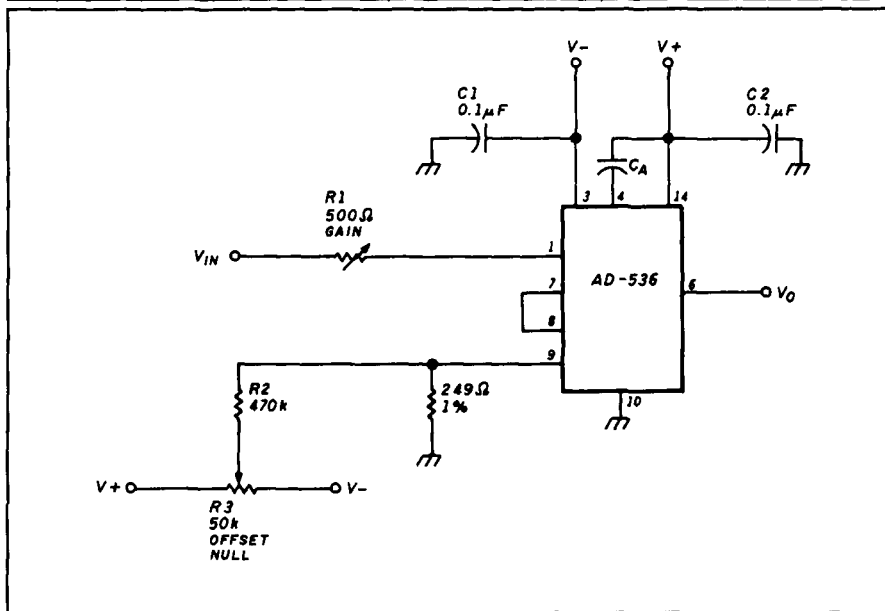

RMS-to-DC converter.

FIGURE 8

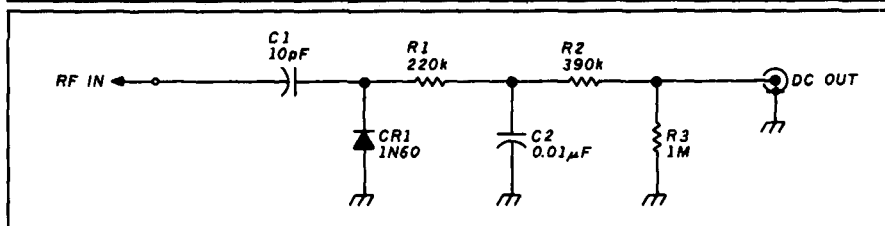

RF demodulator probe.

true rms voltmeter requires an *rms-to-DC converter* circuit. Figure 7 shows an rms converter based on the Analog Devices, Inc. AD-536 rms-to-DC converter. The output voltage will be a DC voltage that's proportional to the rms value of the applied AC voltage. The AD-536 will operate properly at frequencies to 300 kHz if the input rms voltage is >100 mV, and 2 MHz if the

input rms voltage is >1 volt. This circuit offers *offset null* (zero) and *gain* controls.

### RF voltmeters

Many Amateur Radio applications require measurement of RF voltages. For example, the output power of a CW transmitter can be determined in many cases by measuring the voltage across

a dummy load. In other cases, troubleshooting requires such measurements. Figure 8 shows a simple, passive RF demodulator probe. This circuit must be built into a shielded enclosure, and consists of a rectifier (CR1) and an RC ripple filter that uses values consistent with the RF frequencies. The diode used should be a germanium diode of the 1N34, 1N60, or ECG-109 type (also NTE-109). This circuit works for voltages up to about 40 volts peak. Increased voltages are obtained by series connecting two or more rectifiers.

### Bridge amplifier: a construction project

There are many applications for a differential voltmeter, especially in circuits like the Wheatstone bridge used for measuring resistive impedances and other parameters. The circuit in Figure 9 can be used for either single-ended or differential applications. Photo A shows the completed project.

The input or "front end" of the differential voltmeter is an instrumentation amplifier consisting of three operational amplifiers: A1, A2, and A3. The two input amplifiers, A1 and A2, should be RCA/GE CA-3140 devices or other high input-impedance equivalents. These devices are easily obtained on the mail order parts market. The gain of this section of the amplifier is found from:

$$A_v = \frac{2 R_2}{R_1} + 1 \quad (3)$$

For the value shown, the differential voltage gain of this section is  $\times 20$ . The presumption is that  $R_2 = R_3$ .

The follow-on post amplifier (A3) has a gain of:

$$A_v = \frac{R_6}{R_4} \quad (4)$$

assuming that  $R_4 = R_5$ , and  $R_6 = R_7 + R_8$ . With the values shown, the gain of the post amplifier is  $\times 10$ , so the overall gain of the instrumentation amplifier section is the product of the two gains, or  $\times 200$ .

The *scaling amplifier* (A4) has a switch selectable gain of  $\times 1$  or  $\times 10$ , making the overall gain of the circuit either  $\times 200$  or  $\times 2000$ . With this higher gain, the DC offsets of the amplifiers can be quite high, so a ZERO control (R13) is provided.

There are two outputs on the

# MIRAGE

## The Best 2-Meter Power You'll Ever Use

With the *LOWEST* noise GaAs-FET pre-amp in the industry

### B-3030-G

144 MHz 30W in - 300W out



High-speed RF switching relay—(5 ms or less typical switch time)  
Dual-gate GaAs-MES/FET pre-amp, typical gain of greater than 22dB

Dynamic wide-range overload protection Over-temp and high VSWR shut-down

There are a lot of amps on the market, but few ruggedized bricks. Whether your interests are H-F, 6-meters, 2-meters, 220 MHz or 440 MHz, our FULL line of ruggedized amps are in-stock, and ready to ship.

Complete your rig with any of KLM's 2-Meter antennas.

Anything from short-range YAGI's or verticals to long-range satellite circulars.

## Best Amateur Tribanders Available— KT-34A\*/KT-34XA

### SPECIFICATIONS—KT-34XA

#### ELECTRICAL

- |             |                       |            |                          |
|-------------|-----------------------|------------|--------------------------|
| • Bandwidth | ..... 14.0-14.350 MHz | • VSWR     | ..... 1.5:1              |
|             | 21.0-21.450 MHz       | • F/B      | ..... 20 dB              |
|             | 28-29.7 MHz           | • F/S      | ..... 40 dB              |
| • Gain      | ..... 8.5-9 dB        | • Feed Imp | ..... 50 Ohms with balun |
|             | 9-9.5 dB              | • Balun    | ..... 4:1, 5 kW PEP      |
|             | 11-11.3 dB            |            |                          |

#### MECHANICAL

- |                  |                |            |                  |
|------------------|----------------|------------|------------------|
| • Element Length | ..... 24 ft.   | • Windload | ..... 9 sq. ft.  |
| • Boom Length    | ..... 32 ft.   | • Weight   | ..... 68 lbs.    |
| • Turn Radius    | ..... 21.5 ft. | • Mast     | ..... 2 in. O.D. |

- Lack of space or funds? How about a KT-34A? It's upgradable to a KT-34XA and similar in performance!

Antenna gain figures used by MIRAGE/klm are measured according to the National Bureau of Standards. These figures are actual gain listed in dB at free space measured over a dipole. Some manufacturers do not choose to use this standard and therefore indicate gain figures that appear to be higher.

*To order, contact your local dealer, or call us direct.*

# MIRAGE/KLM

P.O. Box 1000 Morgan Hill, CA 95037  
(408) 779-7363 (800) 538-2140 (outside CA)

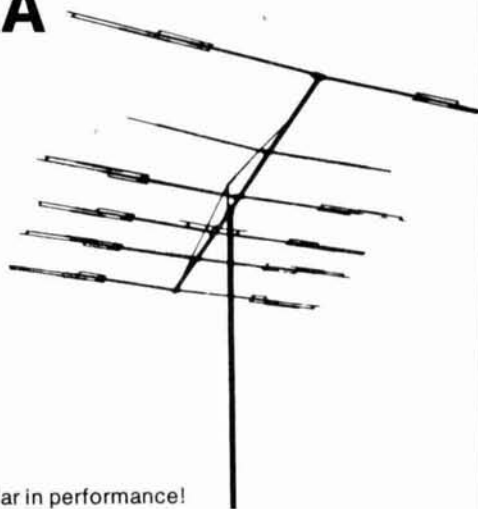
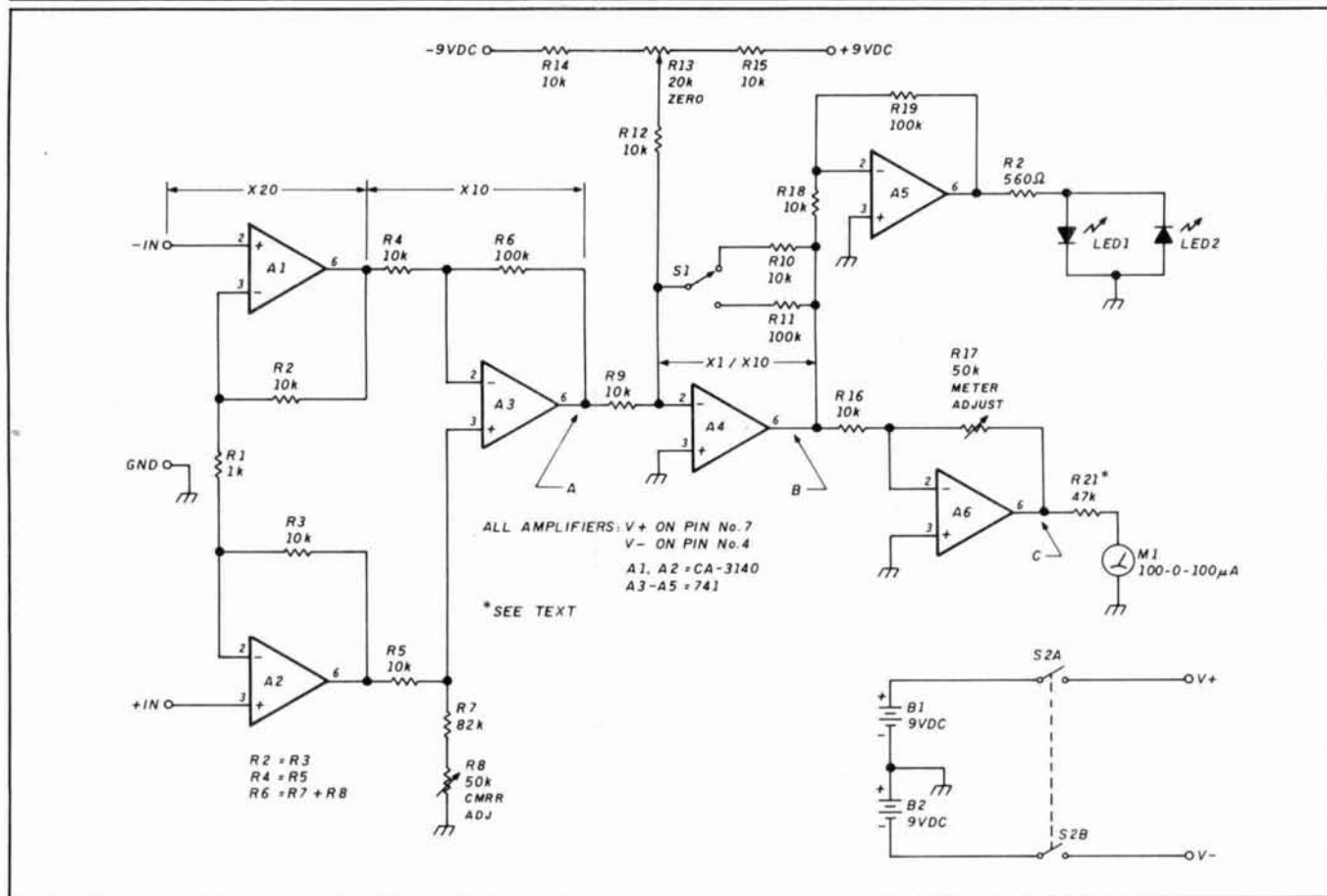

FIGURE 9



**Differential voltmeter circuit.**

differential voltmeter. The conventional output uses a 100 to 0 to 100  $\mu$ A DC meter in the manner described previously. The second output stage is a null detector made from light emitting diodes (LED1 and LED2). The null condition is indicated when **both** LEDs are extinguished.

Initially, you should adjust the meter with the controls in the following positions:

- IN/+IN: shorted to ground
- S1: in the  $\times 10$  position (to R11)
- S2: off
- R8, R13, R17: midrange

Turn on the meter power switch (S2) and let the instrument warm up for about ten minutes. If the meter movement is pegged, adjust R17 to bring it back to the proper range. Adjust CMRR ADJ (R8) for zero volts at point A. Next, adjust ZERO (R13) for zero volts at point B. Now, unground -IN/+IN and connect these two terminals together. Apply a 1.5-volts DC signal from a dry cell to the shorted inputs. Readjust R8 for zero volts at point A if any change has occurred.

Recheck the voltage at point B and readjust R13 if necessary.

If a precision value of  $V_{in}$  is to be read, then apply a 1-mV DC potential to -IN, and ground +IN. Adjust R17 for the proper deflection of M1. This mode isn't normally needed, however, because the purpose of the meter is to find a null.

The DC differential voltmeter is usable as is, or you can use the information contained in this article to design your own application. Don't try to obtain gains higher than  $\times 2000$ , because the drift and other defects will conspire to cause problems. You need to use special compensation methods in those cases.

**Conclusion**

The analog meter movement can be used in a variety of applications. These are some of the more popular applications of those meters used in conjunction with other circuitry.

**REFERENCES**

1. Joseph J. Carr, K4IPV, *IC User's Casebook*, Howard W. Sams & Company, Inc., Cat. no. 22488, \$12.95.



Photo of Figure 9 project.



See Us At Dayton  
Booths 41,42,43,44  
144/440 MHz Dual Band Amplifier  
Coming Soon

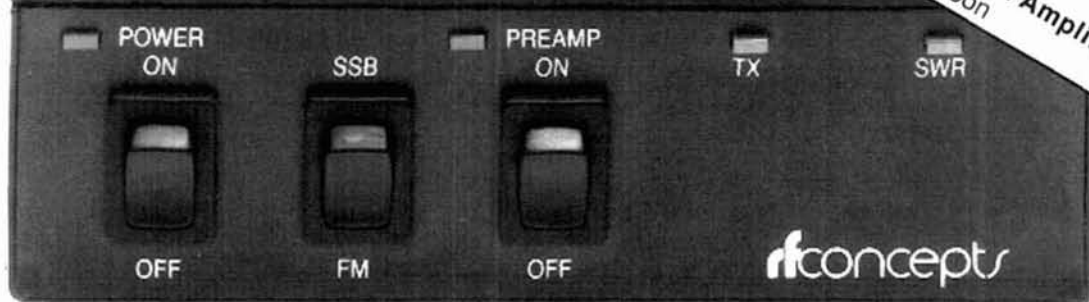

# REAL POWER!

VHF & UHF AMPS

### 144 MHz Amps

RFC 2-23, 2W in= 30 out  
RFC 2-217, 2W in=170 out  
RFC 2-117, 10W in=170 out  
RFC 2-317, 30W in=170 out  
RFC 2-417, 45W in=170 out

### 220 MHz Amps

RFC 3-22, 2W in= 20 out  
RFC 3-211, 2W in=110 out  
RFC 3-112, 10W in=120 out  
RFC 3-312, 30W in=120 out

### 440 MHz Amps

RFC 4-32, 3W in= 20 out  
RFC 4-310, 30W in=100 out  
RFC 4-110, 10W in=100 out

rfconcept

Inquiries: 2000 Humboldt St, Reno, NV 89509 - 702.827.0133 - Div. of Kantronics, Inc.  
Service: 1202 E. 23rd St, Lawrence, KS 66044 - 913.842.4476

153

Make the most of your general coverage transceiver with *Monitoring Times!*

Every month *Monitoring Times* brings everything you need to make the most of your general coverage transceiver: the latest information on international broadcasting schedules, frequency listings, international DX reports, propagation charts, and tips on how to hear the rare stations. *Monitoring Times* also keeps you up to date on government, military, police and fire networks, as well as tips on monitoring everything from air-to-ground and ship-to-shore signals to radioteletype, facsimile and space communications.

**ORDER YOUR SUBSCRIPTION TODAY** before another issue goes by. In the U.S., 1 year, \$18; foreign and Canada, 1 year, \$26. For a sample issue, send \$2 (foreign, send 5 IRCs). For MC/VISA orders (\$15 minimum), call 1-704-837-9200.

### MONITORING TIMES

Your authoritative source, every month.

P.O. Box 98 A  
Brasstown, N.C. 28902

154

## 1990 HAM CALENDARS ORDER YOUR'S NOW

Ham the year away with your own copy of the 1990 Amateur Radio Operator Calendar and Operating Aid.

Looks great in your shack. Keep up-to-date on all the important Amateur Radio events from contests, meteor shower, phases of the Moon, CQ and ITU zones, prefix and zone multiplier lists, USSR Oblast list, plus much, much more.

You also get a special four page commemorative insert on Edward H. Armstrong. Includes rare photos.

Calendar covers through February 1991.  
\$10.95 (plus \$3.75 shipping and handling)

HAM RADIO'S BOOKSTORE  
GREENVILLE, NH 03048  
CALL (603) 878-1441  
FAX (603) 878-1951



For A HRO 72 Page  
Communication Equipment Catalog  
Send \$1.00 to any HRO Store

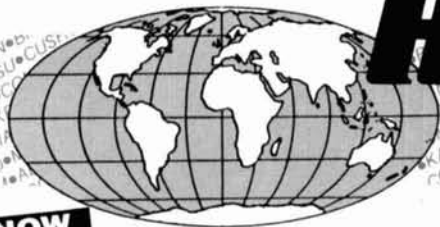

# HAM RADIO OUTLET

LARGEST HAM OUTLET IN THE WORLD

NOW

9

## STORE BUYING POWER



Advanced Electronic Applications

**PK-232 Multi-mode Data Controller**  
Now with PakMail function



- NEW IBM Fax Screen Display Program Available
- Transmit/Receive on Six Modes
- CW/RTTY/ASCII/AMTOR/Packet/FAX
- IBM and Commodore terminal programs available
- Radio Ports for HF and VHF

In Stock for Quick Delivery  
Free Shipment

### Kantronics/KAM



True dual port - simultaneous HF/VHF packet operation

- Personal Bulletin Board
- RTTY/ASCII/AMTOR/CW/Weather Fax
- Programmable MARK and SPACE tones
- Terminal programs for PC compatibles and Commodore
- WEFAX programs for PC, Commodore, and Macintosh

One-year Warranty

CALL FOR LOW, LOW PRICE



**MA-40**  
40' TUBULAR TOWER  
~~\$809~~ SALE! \$629

**MA-550**  
55' TUBULAR TOWER  
~~\$1369~~ SALE! \$999

- Handles 10 sq. ft. at 50 mph
- Pleases neighbors with tubular streamlined look

**TX-455 SALE! \$1389**

- 55' FREESTANDING CRANK-UP
- Handles 18 sq. ft. at 50 mph
- No guying required
- Extra-strength Construction
- Can add raising and motor drive accessories

TOWERS RATED TO EIA SPECIFICATIONS  
OTHER MODELS AT GREAT PRICES



ORION BUSINESS INTERNATIONAL, INC.

### OR-2300

- Reliable Worm Gear Drive
- Stainless Steel Hardware
- Reversal Delay Circuit & Variable Speed Control
- Fits Most Towers



VHF/UHF SOLIDSTATE AMPLIFIERS

Contemporary design, quality and a 5 year warranty on parts and labor. 6 months on the RF Final transistors.

All amplifiers have GaAsFET receive pre-amps and high SWR shutdown protection



Full MFJ line stocked in depth!

MFJ ... making quality affordable  
All MFJ Tuners Stocked!



### MFJ-949D 300 Watt Tuner

- Built-in dummy load
- New peak and Average Lighted 2-color Cross-Needle SWR/Wattmeter
- Built-in antenna switch, balun
- Covers 1.8-30 MHz



### MFJ-1278 Multi-mode

- All 9 digital modes
- Easy Mail™ Personal Mailbox
- 20 LED Precision Tuning Indicator
- Includes free power supply
- Includes free eprom upgrade

Call now for all MFJ products ... wattmeters, dummy loads, coax switches, keyers, clocks, speaker/mics, software, books and more! One year unconditional guarantee.

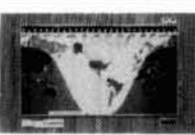

GEOCHRON GLOBAL TIME INDICATOR

SALE

- Detailed illuminated map shows time, time zone, sun position and day of the week at a glance for any place in the world.
- Continuously moving - areas of day and night change as you watch.
- Mounts easily on a wall. Size: 34 1/2" x 22 1/2".

\$1295 \$1159.95  
DELIVERED IN U.S.

FREE SHIPMENT  
Most items over \$100  
UPS surface

# All Major Brands in Stock Now!

CALL TOLL FREE  
IN CALIFORNIA CALL STORE NEAREST YOU

Call any time zone 800 number during business hours from coast to coast.

MID-WEST/WEST ANAHEIM, 9 to 5:30 PST	SOUTHEAST ATLANTA, 9 to 5:30 EST	MID-ATLANTIC WOODBIDGE, 9 to 5:30 EST	NEW ENGLAND SALEM, 9 to 5:30 EST
1-800-854-6046	1-800-444-7927	1-800-444-4799	1-800-444-0047



Toll free including Hawaii. Phone Hrs: 7:00 am to 5:30 p.m. Pacific Time. California, Arizona and Georgia customers call or visit nearest store. California, Arizona, Georgia and Virginia residents please add sales tax. Prices, specifications, descriptions subject to change without notice.

For A HRO 72 Page  
Communication Equipment Catalog  
Send \$1.00 to any HRO Store

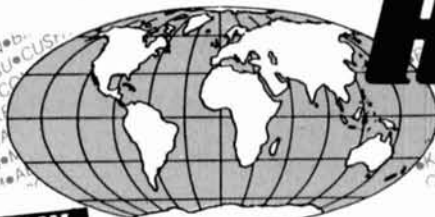

# HAM RADIO OUTLET

LARGEST HAM OUTLET IN THE WORLD

**NOW**  
**9**

## STORE BUYING POWER

**ICOM IC-765**



100W GENERAL COVERAGE RECEIVER  
HF ALL BAND TRANSCEIVER  
Maximum Operation Flexibility

**SALE! CALL FOR PRICE**

**ICOM IC-781**



THE ULTIMATE  
150 W, ALL BAND  
HF TRANSCEIVER

**GREAT PRICE!**

**ICOM IC-901**

FIBER OPTIC  
MULTI-BAND  
TRANSCEIVER



2 METER AND 440 MHz  
EXTRA-LARGE MULTI COLOR LCD  
HM14 TOUCH TONE MICROPHONE

**CALL FOR PRICE**

**ICOM** A Models 25 WATTS  
H Models 100 WATTS

**IC-275A/275H**, 138-174 MHz  
**IC-375A**, 220 MHz  
**IC-475A/475H**, 430-450 MHz



**LOW PRICE!**

**HAM RADIO OUTLET  
NATIONWIDE TEAM**



**COAST  
TO COAST**

**RAPID DELIVERIES  
FROM STORE NEAREST YOU**

**ICOM** HAND-HELD  
VHF/UHF



**IC-32AT** Dual Band Hand Held  
**IC-2GAT** 2 Meter HT 7 WATT  
**IC-3SAT**, 2MTR  
**IC-4SAT**, 440 MHz

**MICRO SIZE**

**ICOM IC-2400A**  
2m, 440 MHz



VHF/UHF DUAL BAND  
FM TRANSCEIVER

**ICOM IC-228A/H**  
2 METER MOBILES  
**IC-448A**  
440 MHz MOBILE



FM TRANSCEIVER  
20 Memories with Memory  
Channel Lock-Out.

**ICOM IC-725**



100W GENERAL COVERAGE RECEIVER  
HF ALL BAND COMPACT TRANSCEIVER

**GREAT PRICE**



### All Major Brands in Stock Now!

**FREE SHIPMENT!**  
Most items over \$100  
UPS surcharge

**ANAHEIM, CA 92801**  
2620 W. La Palma  
(714) 761-3033, (213) 860-2040  
Between Disneyland &  
Knotts Berry Farm

**ATLANTA, GA 30340**  
6071 Buford Hwy.  
(404) 263-0700  
Larry, Mgr. WD4GW  
Doraville, 1 mi. north of I-285

**Burlingame, CA 94010**  
999 Howard Ave.  
(415) 342-5757  
George, Mgr. WB6DSV  
5 miles south on 101 from SFO

**OAKLAND, CA 94605**  
2210 Livingston St.  
(415) 534-5757  
Rich, Mgr. WA9WYB  
IS-880 at 23rd Ave. Ramp

**PHOENIX, AZ 85015**  
1702 W. Camelback Rd.  
(602) 242-3515  
Gary WB7SLY, Mgr.  
East of Hwy. 17

**SALEM, NH 03079**  
224 N. Broadway  
1-800-444-0047  
Curtis, Mgr. WB4KZL  
28 miles north of Boston exit 1 I-93

**SAN DIEGO, CA 92123**  
5375 Kearny Villa Rd.  
(619) 560-4900  
Tom, Mgr. KM6K  
Hwy. 163 & Claremont Mesa Blvd.

**WOODBRIDGE, VA 22191**  
14803 Build America Drive  
(703) 643-1063 1-800-444-4799  
Linda, Mgr. KB4ZYT

**VAN NUYS, CA 91411**  
6265 Sepulveda Blvd.  
(818) 988-2212  
Al, Mgr. KBYRA  
San Diego Fwy. at Victory Blvd

**CALL TOLL FREE** (FROM MOST AREA'S)  
INSIDE CALIFORNIA CALL STORE NEAREST YOU

Call any of our 800 numbers coast to coast from most parts of the country..

**MID-WEST/WEST** ANAHEIM, 9 to 5:30 PST  
**SOUTHEAST** ATLANTA, 9 to 5:30 EST  
**MID-ATLANTIC** WOODBRIDGE, 9 to 5:30 EST  
**NEW ENGLAND** SALEM, 9 to 5:30 EST

**1-800-854-6046 1-800-444-7927 1-800-444-4799 1-800-444-0047**

Toll free including Hawaii. Local phone hours: 9:30 AM to 5:30 PM. Arizona, California, and Georgia customers call or visit nearest store. Arizona, California, Georgia and Virginia residents please add sales tax. Prices, specifications, descriptions subject to change without notice.





# Go First Class on **GAP** Airwaves with the **CHALLENGER DX-V** or New **CHALLENGER DX-VI**

Unique Multiband Antennas that Utilize the Patented  
**GAP Elevated Launch Technology**

The Revolution in Antenna Design

That . . .

- Launches RF from an elevated
- Eliminates earth loss
- Comes pre-tuned. No adjustments necessary
- Uses 3 short radials @ 25 feet
- Assembles in less than 30 minutes
- Is self supporting w/drop in ground mount and is 31 feet high



but has **NOT!!!**

- Traps
- Coils
- Transformers
- Baluns
- Resistors
- or Base Insulators

Challenger DX-V \$199\*

Total bandwidth on  
40, 20, 15, 10 meters  
80 KHz on 80 meters

Challenger DX-VI \$219\*

Total bandwidth on  
40, 20, 15, 12, 10 meters  
130KHz on 80 meters

Best of all the **ENTIRE** antenna is always active!!

To Order Call—(407) 388-2905

\*Plus shipping and handling  
Florida residents add 6% tax



**ANTENNA PRODUCTS**

6010—Bldg J  
N. Old Dixie Highway  
Vero Beach FL 32967

✓ 149

## NEED BATTERIES? COME SEE THE EXPERTS



Everett H. Yost  
KB9XI

**E.H. YOST & CO.**

7344 TETIVA RD  
SAUK CITY, WI 53583

**(608) 643-3194**

**FAX (608)643-4439**

**ASK FOR FREE CATALOG**

### WHERE QUALITY COMES FIRST

We have batteries for commercial, amateur radio, computers, tools, phones and more.

**“The Perfect Combination”**

**MR. NICAD**

and the

**1990 Dayton Hamvention**

**Stop By Booths 120-122 & 505**

for

**NEW LOW PRICES**

and

**MANY SHOW SPECIALS**

**—REPLACEMENT BATTERIES—**

FOR ALL YOUR NEEDS

Nickel Cadmium, Alkaline, Lead-acid, Lithium, Mercury, etc.

✓ 150

# SATELLITE ESSENTIALS

Satellite TV is still full of the wonderment that made it so popular in the early '80s. The tinkerers are there, the programming is there, and never has the cost of becoming a dish owner been so low.

So, how do you find out about this exciting entertainment?

Through publications devoted specifically to satellite TV, that's how!

## ONSAT

### America's Weekly Guide To Satellite TV

OnSat is unsurpassed for the most up-to-date listings of satellite programming. Dr. Dish, Mailbag, and the Transponder Service Watch are all geared to help you make the best use of your satellite TV system. A sample issue can be obtained for only \$1.

## STV GUIDE

### The Complete Monthly Guide To Satellite TV

STV Guide contains over 300 pages of programming information, product reviews, home troubleshooting, and information about satellite TV. A sample issue can be obtained for only \$2.

Both OnSat and STV Guide contain listings for over 120 channels and Prime Time Grids for over 50 channels. Subscribe to either the weekly OnSat or the monthly STV Guide for only \$48 per year.

To start receiving the best in satellite TV guides and information, call toll-free (800) 234-0021. VISA® and MasterCard® accepted.

**STV Guide/OnSat**

**PO Box 2384 • Shelby, NC 28151-2384**

✓ 151

# INSTRUMENTATION SERIES: OSCILLOSCOPES

Denton Bramwell, K7OWJ, Director Heath Instruments, Heath Company, Benton Harbor, Michigan 49022

If you like to tinker and build, or if you just want to make routine equipment repairs, an assortment of electronic test equipment is undoubtedly on your "must own" list. If you're like me, you have a pretty strong attachment to your test equipment. After all, your equipment lets you put your knowledge to work.

Unfortunately, not all test equipment is created equal — even equipment with exactly the same specs. I'd like to talk about the pros and cons of various pieces of apparatus to help you select the right tools for your purposes, and get the most out of them once you own them. My topic for this article is oscilloscopes.

Years ago there was a question on the General class exam that asked which measurement tool was the most useful of all. The correct answer, to no one's amazement, was the oscilloscope. It's still a good answer. If you could own just one piece of equipment, you'd probably be wise to choose a good 'scope because it lets you look at both static and dynamic voltages.<sup>1</sup> Choosing a good 'scope isn't difficult if you take the time to learn a few indicators.

Note that I said a "good" 'scope. There are a lot of junky ones on the market, and your first task is to sort out the equipment that's part of the solution from the equipment that's part of the problem. A discussion of what constitutes a good 'scope can be broken down into sections: vertical amplifiers, timebases, trigger circuits, and extra or convenience features. Of these, the vertical amplifier portion of the oscilloscope deserves the most discussion.

## Vertical amplifiers

Look at almost any oscilloscope ad and you'll find the bandwidth specification displayed prominently. In fact, for many buyers bandwidth has too often become the single figure of merit for oscilloscopes. That's too bad; buyers who consider only bandwidth when buying an instrument are courting disappointment. To further compound the problem, a lot of people misunderstand and are misguided by the meaning of bandwidth.

In a nutshell, you probably need a lot more bandwidth than you think you do. Looking at your 9-MHz IF? A 10-MHz 'scope ought to do the job with some room to spare, right? Well, no. In fact, not by a long shot.

Photo A shows the output of an oscillator designed to what I'd call minimal standards. The oscillator was made from a fast logic gate and crystal, breadboarded with little

PHOTO A

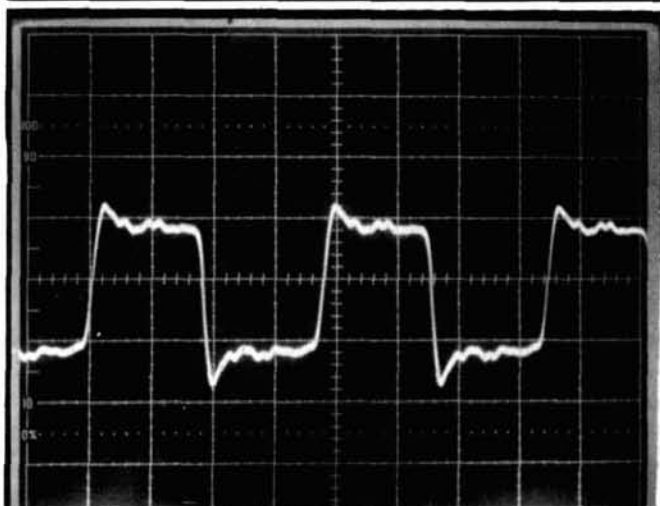

A 13.3-MHz square wave, rich in harmonics, as seen on a 200-MHz oscilloscope.

regard for layout. The result is a 13.3-MHz signal, which could charitably be described as "rich in harmonics." What you see in Photo A is a reasonably accurate representation of the output of the circuit taken from a 200-MHz oscilloscope.

Now look at what happens when you try to use an instrument with inadequate bandwidth. Photo B shows the same signal, with the same sensitivity and sweep settings, on a 40-MHz oscilloscope. You'd think that a 40-MHz instrument would be ample for a 13.3-MHz signal, but in this case it's not. Photo C shows a worse case, from a 20-MHz oscilloscope. The bandwidth of the instrument is 50 percent higher than that of the signal, but the on-screen trace is nothing like the one from the 200-MHz 'scope. Why do you need so much bandwidth for a 13.3-MHz signal? The reason is easily understood.

Bandwidth is *not* the same as frequency range. When some instruments (like frequency counters) are specified, the term frequency range is used because counters work properly up to some limit and then cease counting. Oscilloscopes don't work up to a particular frequency and stop. They start rolling off slowly until they reach the point where they are 3 dB down. We call that the bandwidth. In short, a pure sine wave will appear at 70.7 percent of its true amplitude if its frequency is equal to the bandwidth of the 'scope.



# Hi Pro Repeaters ELCO

MAGGIORE ELECTRONIC LAB.

Manufacturers of Quality Communications Equipment

- Repeaters
- Links
- Remote Base
- VHF, UHF
- Receivers
- Transmitters
- Antennas



- Standard and Computerized Controllers
- Standard and Computerized Auto Patches
- Duplexers

## Hi Pro 'E' EXPANDABLE REPEATER SYSTEM

- A NEW CONCEPT IN REPEATER DESIGN, THE Hi Pro "E" IS AN EXPANDABLE REPEATER WITH THE FOLLOWING FEATURES: A BASIC REPEATER WHICH WOULD INCLUDE A COMPLETE RECEIVER, TRANSMITTER, COR, FRONT PANEL CONTROLS AND INDICATORS, LOCAL SPEAKER AND MIC JACK AND CAPABLE OF FUTURE EXPANSION. ALL HOUSED IN AN EXTREMELY RUGGED, ENCLOSED, 19-INCH RACK MOUNTABLE CABINET.
- THIS SYSTEM CAN BE EXPANDED AT TIME OF PURCHASE OR CAN BE AN AFTER-PURCHASE ADD ON. THE ADD ONS ARE—HIGHER POWER, 110/220 VAC POWER SUPPLY, IDENTIFIER, AUTO PATCH, OR COMPUTER CONTROLLERS. IN ADDITION TO THESE ADD ONS AN ADDITIONAL RECEIVER AND TRANSMITTER CAN BE MOUNTED INTERNALLY FOR USE AS CONTROL LINKS, REMOTE BASE OR DUAL BAND OPERATION, ETC.
- AN EXTENSION PANEL IS AVAILABLE FOR LOCAL MONITORING OF THE REPEATER AND CONTAINS ALL NECESSARY METERING, STATUS LIGHTS AND INDICATORS. ALL ADD ONS ARE AVAILABLE FROM THE COMPANY AND ARE COMPLETE INCLUDING INSTRUCTIONS.

MAGGIORE ELECTRONIC LAB.

600 Westtown Rd.

West Chester, PA 19382

Phone (215) 436-6051



Telex 499 0741 MELCO  
FAX 215-436-6268

WRITE OR CALL FOR OUR COMPLETE CATALOG

### Engineering Consulting's computer controlled Ham Shack See system variables, control & reprogram all via packet! Ultra Comshack 64 Repeater Controller HF & VHF Remote Base\*Autopatch\*CW Practice\*Rotor Control \*Voice Meters\*Paging\*Logging\*Polite ID's\*Packet Voice B.B.S.

Model CS64S \$359.95  
Includes: Interface, disk, cables, Manual  
Ultra Options

FT 757; 767; 980; 736; 747  
TS 440; 940; 140  
IC 735; 701 VHF  
FT 727R; 767; 736  
TS 711; 811; 680

Controller Features  
\*Change variables remotely from touchtones or Packet  
\*Unlimited voice vocabulary!  
\*Alarm Clock, auto, execute  
\*Individual 4 digit user codes  
\*Disk & Printer logging of users, tel #'s, lapsed time  
\*18 Rotating Polite ID's  
\*18 External relay controls \* 2, 5, & CTCSS Tone Paging  
\*CW Practice with voice  
\*Security mode, T.tone mute  
\*Voice announces each user call sign when logging on

Autopatch & Reverse  
\*1000 (18 digit) tel #'s stored  
\*Quick dial & quick answer  
\*Directed, general page  
\*Selected restricted patch  
\*Telephone control input  
Dual Combined Remotes  
\*18 Macro/Scan memories  
\*Scan up/down; 100Hz steps  
\*Monitor & lock modes  
\*Operate splits, combine HF & VHF radios as Dual VFO's  
\*Automatic mode selection  
\*Talking S Meter; Voltmeter  
\*Voice Beacon rotating msg

Model CS64S \$359.95  
Includes: Interface, disk, cables, Manual  
Ultra Options  
Add duplex tel. Remote Base control & 3 way patch. TLCN. \$159.95  
External relays; 3 DPDT relays +5 Open Col. Trans. Sw...CS 8...\$89.95  
\*Rotor control D.C. to digital display & Voice; for all rotors...HM1...\$59.95  
\*2 Voice Meters & 2 Alarm Inputs:  
8 Relay On/Off Control. PK8.\$159.95  
\*Reprogram & Control via Packet;  
Packet to Voice B.B.S. PK1...\$89.95  
\*EPROM Autoboot CART...\$109.95  
\*C64 & 1541 12V. Switching supply crystal controlled...DCPS...\$129.95  
\*Digital Voice Rec/PB 32 or 64 sec. voice Mailbox & ID Tail.DVM \$179.95  
\*Manual (REFUNDED) MN1...\$20.00

Computer Control YAESU FT-727R  
C64 OR IBM Mini Cat  
Allows H.T. to scan 100 Channels & programs H.T. for field use! Digital "S" Meter; comment fields; auto resume & delay; Scan Lock-outs; Loads FT727 in 15 sec. Hardware, cables, & disk included for C64 or IBM  
Model 727 \$49.95

Touchtone Decoder 4 digit sequence; & QUAD expansion 4 relay option  
2"x3" TSQD  
8/20 V & audio in; Field Program 50,000 Codes; Mom. & Latching; DPDT Relay; Wrong digit reset; LED for digit valid & latch; inc. 24 Pin connector QUAD option adds: four 2 Amp. relays; 5 digit master on/off control for each relay.  
TSQD \$89.95 QUAD \$99.95

Decode-A-Pad Touchtone to RS232 300 Baud Interface  
Use with all computers  
Decodes 16 touchtones  
Includes Basic program  
DAP \$99.95

12 Volt C64 SWITCHER  
Crystal 60Hz  
9VAC 5V. 2A.  
C64 & 1541  
DCPS \$129.95

AUDIO BLASTER  
IC02; 04; 2AT; FT-727; 411; 209; 470; 73; 23; U16; TH25  
←Miniature Audio Amp.  
Module installs inside all H.T.'s;  
1 watt audio amp! When it needs to be loud! Installs in 15 Min. Used by police, fire!  
Model AB1S \$24.95

New Digital Voice Recorder  
Records 32 or 64 Sec. studio quality audio  
\*Use for auto CO, ID tail, Mailbox, Local or logic control; Up to 16 selectable messages!  
Includes: 1 Watt audio amp; 1 Meg RAM; Mic & Spkr Jacks, vol. control; Req. 9 to 12V; Interfaces to Ultra Com Shack 64 Ver 8.0; Provides Digital Voice CO, ID tail, Mailbox, bulletins DVM \$179.95

ENGINEERING CONSULTING  
583 GANDLWOOD ST.  
BREAR, CA. 92621  
TELEPHONE: 714-671-2009  
FAX: 714-255-9984

We accept: C.O.D.'s  
MasterCard, VISA, Disc  
AMERICAN EXPRESS  
add \$4.00 SH U.S.A.  
\*Ca. residents add 6%

## W6SAI BOOKS

by noted HR columnist Bill Orr, W6SAI.

### ALL ABOUT VERTICAL ANTENNAS

Theory, design, construction and operation are fully covered for vertical antennas. Grounds and their importance get extra emphasis. Construction data for 25+ antenna designs. 192 pages ©1986 1st edition

RP-VA Softbound \$10.95

### THE RADIO AMATEUR ANTENNA HANDBOOK

Covers all kinds of antennas from HF to VHF, horizontal to vertical. Compiled from years of W6SAI's extensive writings. Great reference volume to have on hand. Chock full of proven antenna designs that work! 190 pages ©1978 1st edition

RP-AH Softbound \$11.95

### INTERFERENCE HANDBOOK by WA6FOG

With homes rapidly filling with vulnerable electronic equipment, knowing how to solve interference problems is a must. WA6FOG has years of experience and tells you everything you need to know to solve even the thorniest interference problem. ©1981 1st edition

RP-IH Softbound \$11.95

### THE RADIO HANDBOOK 23rd edition

Great technical resource to have available in your Ham workshop. Full of all kinds of projects, antennas and the best compilation of HF and VHF amplifiers in the Amateur Radio field. Includes new easy-to-use charts, graphs and tables. Best value in Amateur Radio today. 1200 pages ©1986 23rd edition

22424 (Reg \$29.95 SAVE \$3) Hardbound \$26.95

Please enclose \$3.75 shipping and handling

**HAM  
RADIO**  
Greenville, N.H. 03048



Order today! (603) 878-1441  
or "FAX" us (603) 878-1951

PHOTO B

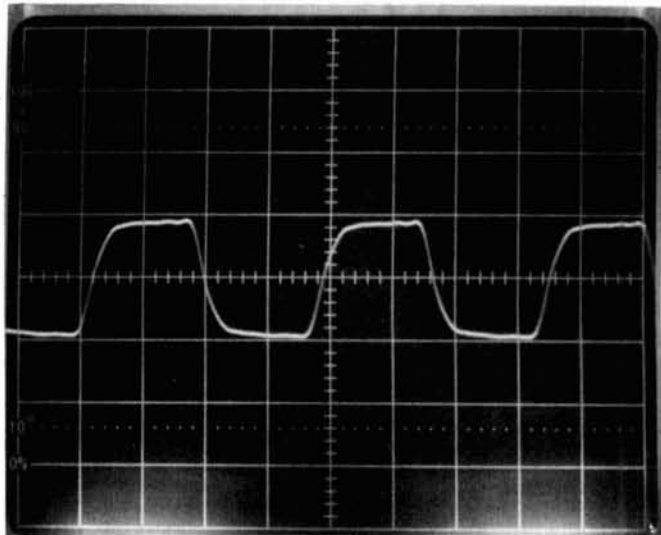

Same 13.3-MHz signal, as seen on a 40-MHz oscilloscope.

PHOTO C

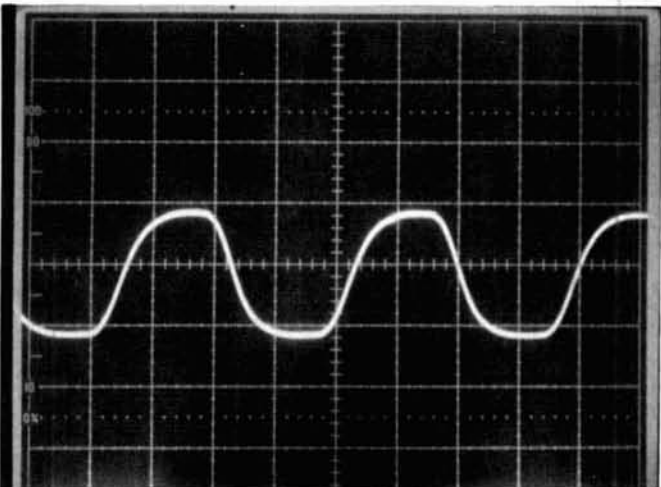

Same signal again, but on a 20-MHz oscilloscope.

If you know in advance that you're dealing with a pure sine wave, you might find such a measurement useful — but this is seldom the case. In fact, if you know that your signal is only a pure sine wave, you can get all the information you need from an RF voltmeter and a frequency meter. Normally circumstances don't justify the assumption that your signals are sine waves. Actually, in RF work it's often the deviations from sine waves that are interesting.

If you don't know in advance what your waveforms look like, you need a bandwidth *much* greater than your signal. An ideal square wave contains an infinite series of odd harmonics. To obtain a reasonable representation of a square wave, you probably ought to think about getting an instrument with a bandwidth five to seven times the frequency of the signals you want to look at. And next time someone tries to tell you that his 35-MHz oscilloscope is really good

## coaxial R. F. antenna switches

**Heavy Duty switch for true  
1 Kw POWER — 2 Kw P.E.P.  
Ceramic with Coin Silver  
Switch Contacts**

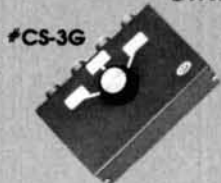

#CS-3G

**Single Pole, 3 Position.**  
Desk or wall mount  
All unused positions grounded

#CS-3G — UHF connectors / **\$36.50\***  
#CS-3G-BNC — BNC connectors / **\$43.95\***

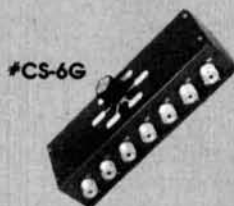

#CS-6G

**Single Pole, 5 Position.**  
All unused positions grounded

#CS-6G — UHF connectors / **\$46.50\***  
#CS-6G-BNC — BNC connectors / **\$59.50\***

\*Shipping and handling for any item add \$2 each.

ALL OUR PRODUCTS MADE IN USA



**BARKER & WILLIAMSON**

Quality Communication Products Since 1932

At your Distributors write or call  
10 Canal Street, Bristol PA 19007

(215) 788-5581



## AMATEUR TELEVISION

**SMILE! YOU'RE ON TV**



See you in Dayton!

**Only  
\$329**



Designed and  
built in the USA  
Value + Quality  
from over 25 years  
in ATV...W6ORG

With our all in one box TC70-1, 70cm ATV Transceiver, you can easily transmit and receive live action color and sound video just like broadcast TV. Use any home TV camera or VCR by plugging the composite video and audio into the front VHS 10 pin or rear phono jacks. Add 70cm antenna, coax, 13.8 Vdc and TV set and you are on the air...it's that easy! TC70-1 has >1 watt p.e.p. with one xtal on 439.25, 434.0 or 426.25 MHz & properly matches Mirage D15, D24, D100 amps for 15, 50, or 70 watts. Hot GaAsfet downconverter varicap tunes whole 420-450 MHz band to your TV ch3. Shielded cabinet 7x7x2.5". Req. 13.8 VDC @ .5A. Transmitters sold only to licensed amateurs, for legal purposes, verified in the latest Callbook or send copy of new license. Call or write now for our complete ATV catalog including downconverters, transmitters, linear amps, and antennas for the 70, 33, & 23cm bands.

(818) 447-4565 m-f 8am-5:30pm pst.

Visa, MC, COD

**P.C. ELECTRONICS**

2522 Paxson Ln Arcadia CA 91006

Tom (W6ORG)  
Maryann (WB6YSS)

PHOTO D

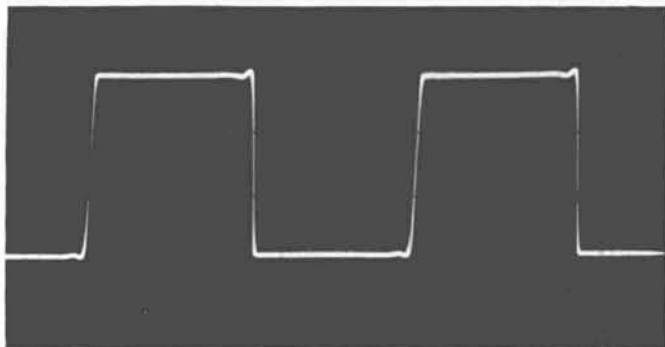

High quality square wave.

to 40 or 50 MHz, you'll know better! Even for sine waves, you'll want a bandwidth three to five times greater than your signal. Otherwise, your measurements will be in error by more than a reasonable factor. A 35 to 65-MHz instrument, rather than a 10-MHz instrument, is what you want for measurements on your 9-MHz IF.

Once you've decided on a bandwidth, you need to look at the pulse characteristics of your instrument. This is necessary *even if you're not looking at pulses*.

The impulse response of a system is the Fourier transform of its transfer function. This is simply a \$64 way of saying that if you tell me exactly how something responds to a very fast pulse, I'll tell you exactly how it responds to *anything*. In other words, if you mess with pulse response you also mess with bandwidth. The consequence of accepting poor pulse response is that you also accept sensitivity that isn't flat and doesn't roll off in a neat, orderly manner. You'll find bumps and dips in the sensitivity of the instrument that are well within its useful range. So what do you look for, and how good is good?

The easiest spec of pulse fidelity is the overshoot and ringing spec. A small percentage of overshoot and ringing extends the bandwidth of the oscilloscope greatly. The usual practice is to allow 3 to 5 percent. Be very suspicious of any 'scope that doesn't have this spec. Some manufacturers ignore this parameter altogether. It lets them offer a very high bandwidth for a very low cost, but you won't be satisfied with the instrument for long.

It's important to look for a combination of a good bandwidth spec and good pulse response when you're checking out a new oscilloscope. However, there's one other parameter that's seldom mentioned, and it's one that's very important. I'm talking about dynamic range.

Photo D is taken from a 'scope that's a bit short on this parameter. It shows a square wave from a good quality signal generator. The representation is pretty good. There's a little negative tip on the negative-going slope that really isn't there, but it's small and well within reasonable specs. Now double the sensitivity and use almost the entire screen. You'll see that those innocuous little tips have grown to problem size in Photo E. Advance the gain a little more, as in Photo F, and they really get unruly. Position the trace upward, as shown in Photo G, and the picture changes dramatically once again.

PHOTO E

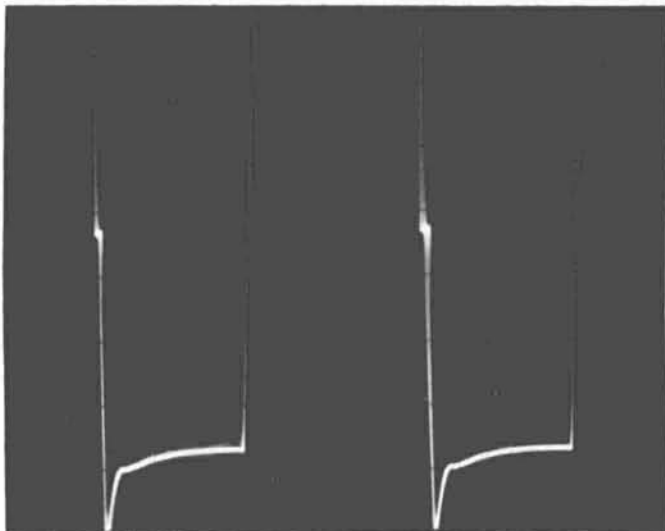

Same square wave, same oscilloscope, but at twice the sensitivity.

PHOTO F

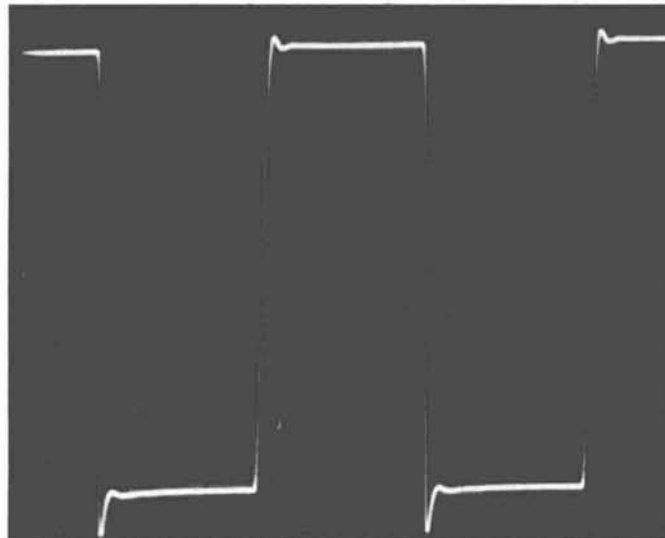

Same square wave again, but at a sensitivity that puts half the signal offscreen.

PHOTO G



Same signal, same settings, except that the vertical position control has been changed.

# BATTERIES "R" US...

You've bought our replacement batteries before...  
**NOW YOU CAN BUY DIRECT FROM US, THE MANUFACTURER!**



**ICOM**  
 CM2, BP2 7.2v @ 500MAH  
 CM5, BP5 10.8v @ 500MAH  
**SUPER**  
 7S 13.2v @ 1200 MAH \$63.95  
 8S 9.6v @ 1200 MAH \$59.95  
 (base charge only-1" longer)  
 ICOM CHARGERS AVAILABLE

## FOR ICOM: CONVERTIBLE BATTERY



8 Cells — Alkaline  
 or NICAD Holder  
 Complete with (8)  
 Alkaline Batteries  
**\$26.00**

**BP-7**  
 13.2v @ 500MAH \$61.95  
 13.2v @ 600MAH \$64.95  
**BP-8**  
 8.4v @ 600MAH \$61.95  
 8.4v @ 1000MAH \$64.95



## APRIL SPECIAL

**CELLULAR PHONE BATTERIES  
 LESS - 10%**

MOTOROLA  
 PANASONIC  
 OKI  
 NEC  
 MITSUBISHI  
 DIAMONDTL  
 GE  
 NOKIA-MOBIRA  
 AUDIOVOX  
 NOVATEL  
 TECHNPHONE



**CUSTOM MADE BATTERY  
 PACKS & INSERTS**  
 Made to your specifications.  
**Introductory Offer!**  
**KENWOOD INSERTS**  
 PB-21 - \$13.75, PB-25 - \$20.00,  
 PB-26 - \$20.00  
**ICOM INSERTS**  
 BP-5 - \$23.00, BP-3 - \$17.45,  
 BP-7, BP-8

Prices subject to change without notice.



MasterCard and Visa  
 cards accepted. NYS  
 residents add 8 1/4%  
 sales tax. Add \$3.50  
 for postage and  
 handling.



**SOURCE FOR ALL YOUR COMMUNICATION  
 BATTERY REPLACEMENT NEEDS.**

## W & W ASSOCIATES

29-11 Parsons Boulevard, Flushing, N.Y. 11354

WORLD WIDE DISTRIBUTORSHIPS AVAILABLE. PLEASE INQUIRE.

In U.S. & Canada Call Toll Free (800) 221-0732 • IN NYS (718) 961-2103 • Telex: 51060 16795 • FAX: (718) 461-1978

**SEE US  
 IN DAYTON  
 BOOTHS  
 560 & 561  
 FOR SHOW  
 SPECIALS!**

146

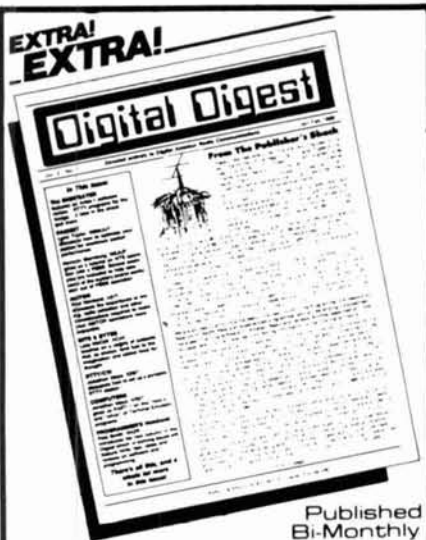

Published  
 Bi-Monthly

Read All About Your  
 Favorite Modes Of  
 Digital Communications!

★ **Subscribe Today!** ★

## Digital Digest

4063 N. Goldenrod Road  
 Winter Park, FL 32792

**\$16.00** Per Year  
 U.S. \$22.00 Elsewhere

Payable in U.S. Funds Only / Check or M.O. Preferred

## SUPER PERFORMANCE BATTERIES

### UPDATED SUPER ICOM

**SUPER ICOM BP-7S.** 13.2 volts,  
 1200ma triple the capacity of the  
 Icom BP-7, 5w output.

**SUPER ICOM BP-8S.** 9.6 volts,  
 1200ma, 50% more capacity than  
 the Icom BP-8.

Both are rapid base charge only, or  
 slide in wall charger, 4 inches high,  
 BP-7S or BP-8S. \$65.00

### SUPER KENWOOD

**SUPER KENWOOD PB-25S/PB-26S.** 8.4  
 volts, 900ma, double the capacity  
 of the PB-25/PB-26 for the 2500/  
 2600/3500/3600. Charge with either  
 the standard wall charger or drop  
 in charger. 3 inches high. \$65.00



Exact replacement FNB-2 Nicad pack  
 for Yaesu FT-404R/207R/208R/708R  
 \$22.50

### SPEAKER/MICS

Icom HM-9 \$35.00  
 Yaesu MH12A2B \$31.00

### SUPER YAESU

**SUPER YAESU FNB-4SH.** 12 volts,  
 1000ma, double the capacity of the  
 Yaesu FNB-4, 5 watt output. Rapid  
 charge only. \$71.00

**SUPER YAESU FNB-3S.** 9.6 volts,  
 1200ma, triple the capacity of the  
 Yaesu FNB-3, 3.5 watt output.  
 Rapid or wall charge. \$65.00

Both are perfect for the 03, 09 and  
 727 series radios and are 4 inches  
 high

Inserts for:  
 Kenwood PB-25, 25H, 26 \$25.00  
 Icom BP-3 \$18.95  
 Icom BP-5 (500ma) \$24.95  
 Icom BP-7 (500ma) \$29.50  
 Icom BP-8 \$29.50

Full line for Yaesu 411/811/470, FNB-10/11/12/14 available.  
 Add \$4.00 shipping & handling for first pack. CT residents add 8% tax.

Complete line of NICAD packs for Icom, Kenwood, Yaesu, Tempo, Santec, Azden, Cordless Telephones,  
 Alkaline, Nicad & Gell-Cells. All NICAD packs include 1 year guarantee. Commercial Radio Packs available.  
 For all your battery needs, write or call today for a complete catalog. Dealer inquiries invited.

MADE BY HAMS FOR HAMS



**PERIPHERAL Inc.**

149 Palmer Road • Southbury, CT 06488

(800) 634-8132 In CT (203) 264-3985 FAX: (203) 262-6943



147



You should expect *some* errors of this type; however, these are a bit large. Unfortunately, I've seen products far worse than this. Since dynamic range is seldom specified, it's an item you'll probably have to check for yourself using the method shown here.

Here's another very common trap. You plunk down \$700 for a racy new 50-MHz oscilloscope, and then spend \$50 on a pair of 50-MHz probes. Sounds reasonable — a nice, matched system. It's not. A 50-MHz probe on a 50-MHz 'scope will give you about 35 MHz at the probe tip! And the degradation is even more severe when you hook it to a point in your circuit with more than 50 ohms of source impedance!

It's better to spend a few more bucks for probes of 250 MHz (three to five times your 'scope bandwidth) or so. That will preserve almost all of your bandwidth at the probe tip, and give you more megahertz per dollar.

One more thing before I go on. Check out the cabinet material before you buy. You'd be surprised how many plastic 'scopes suddenly get inch-wide traces when you key your transmitter. A metal case doesn't guarantee immunity, but it does better the odds. I've found that plastic-cased oscilloscopes tend to be more EMI susceptible, and should be avoided unless they have good internal shielding.

There's a lot of information out there about vertical amplifier sections,<sup>2</sup> but what I've discussed here should provide you with a better than average survival kit. These simple questions and performance tests will keep you from making the most common errors in oscilloscope selection and use.

## Timebases

Old, low cost oscilloscopes used a horizontal oscillator with a synchronizing circuit. The idea was to synchronize the frequency of the timebase with the frequency of your signal, thus obtaining a usable display. That style of design has pretty much become a thing of the past.

The calibrated and triggered timebase has played a major part in making oscilloscopes as popular and useful as they are today. A timebase is fairly easy to check out; it's supposed to be linear. Just feed in any signal known to produce peaks or zero crossings at a rate of one or five times per division, and look for errors. If the largest error on any timebase setting is 2 to 3 percent, the 'scope is doing as well as analog models generally do. Photo H shows a typical example.

Usually, the oscilloscope has a magnifier which allows you to expand the trace five or ten times. This is quite handy. It's often the only way you can spread out a signal at the upper limit of your 'scope enough to really look at it. You'll pay a price in accuracy, but that's to be expected. Don't be surprised if the accuracy spec at the fastest sweep speeds isn't nearly as good as it is on the other ranges. That, also, is to be expected.

Delayed sweep is a commonly misunderstood feature. When I called on customers for a major instrument supplier, I was always amazed at the number of people who felt they positively, absolutely had to have delayed sweep — even though they didn't have the foggiest idea what it was or how to use it. If you really need it, nothing else will do. If you don't, save your money. Delayed sweep adds significantly to the cost of an oscilloscope.

Delayed sweep means that an instrument has two independent timebases. The second sweep runs after a

PHOTO H

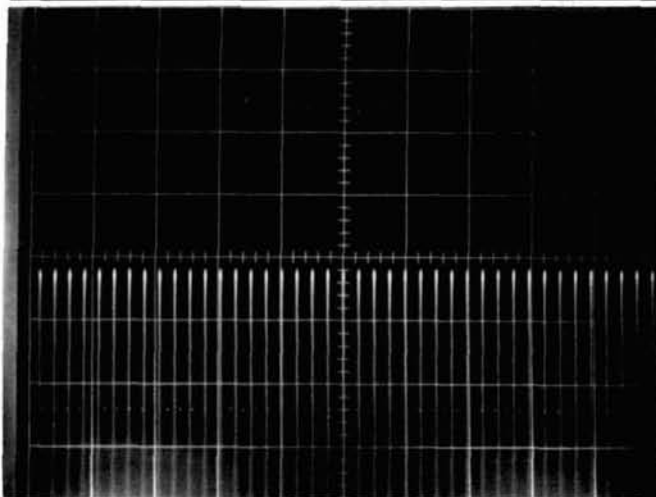

RF generator and frequency counter used to check time base accuracy.

PHOTO I

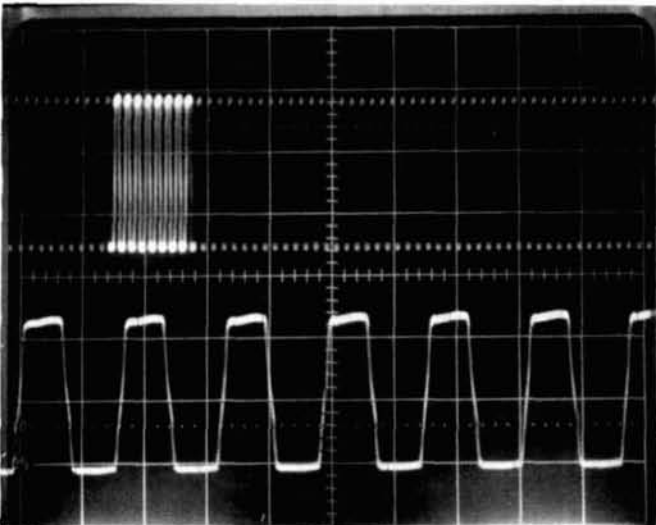

Upper trace: main sweep with an intensified zone (A intensified by B). Lower trace: delayed sweep alone. This photo required a double exposure. Some oscilloscopes are capable of actually presenting both traces on screen at the same time.

delay of your choice, using the first timebase. The most useful implementation of this involves a precision, multiturn pot.

Why the precision pot? It lets you make a more precise time measurement than is possible on the screen. You don't have to worry about CRT nonlinearity, so you can get down into the 1/2-percent range by reading time off the pot rather than the screen. This can be important if, for example, you're trying to measure timing on a digital circuit. With the instruments available today, there are often better ways to make timing measurements without the expensive precision pot.

Another use for delayed sweep is found in digital work. Suppose you have some sort of index pulse, followed by a hundred or so data pulses. Let's also suppose that you want to look at each pulse in turn. A convenient way to do so is to use the delayed sweep. Let me illustrate.



When performance & price really count...

# CRYSTEK CRYSTALS

The pulse of dependable communications



Reliability & Quality  
From Start To Finished Product

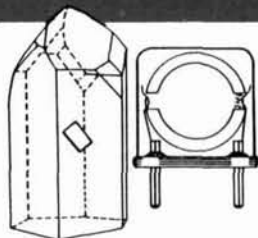

### QUARTZ CRYSTALS/OSCILLATORS FOR ELECTRONIC — INDUSTRIAL

- Micro-Processor Control
- Computers/Modems
- Test/Measurement
- Medical

### COMMUNICATIONS — REPLACEMENT

- Mobile/2-way/Channel Elements
- Pagers
- Marine
- Aircraft
- Telemetry
- Monitor/Scanners

### AMATEURS

- CB
- Hobbist
- Experimenter

COST EFFECTIVE  
MODERATE PRICING  
FAST DELIVERY



Replacement Crystals Catalog

Custom Made Crystals Catalog

### The Pulse of Dependable Communications

Crystek Crystals offers their new 16 page **FREE** catalog of crystals and oscillators. Offering state-of-the-art crystal components manufactured by the latest automated technology. Custom designed or "off the shelf," Crystek meets the need, worldwide. Write or call today!

**CRYSTEK CORPORATION**  
DIVISION OF WHITEHALL CORPORATION

2351/2371 Crystal Dr. • Ft. Myers, FL 33907  
P.O. Box 06135 • Ft. Myers, FL 33906-6135  
**TOLL FREE 1-800-237-3061**  
(813) 936-2109 —



## ATV CONVERTERS • HF LINEAR AMPLIFIERS

DISCOVER THE WORLD OF  
FAST SCAN TELEVISION



HF AMPLIFIERS per MOTOROLA BULLETIN

Complete Parts List for HF Amplifiers Described in the MOTOROLA Bulletin.

AN758 300W \$160.70	ER61 140W \$ 88.65
AN762 140W \$ 93.25	ER37A 300W \$139.20
AN779L 20W \$ 83.70	EB104 600W \$448.15
AN779H 20W \$ 93.19	AR303 300W \$403.00

UNIVERSAL DIGITAL FREQUENCY READOUT  
YK-1 (Wired/tested) \$149.95

REPEATER CONTROLLER  
RC-1000 (Wired/tested) \$239.95

HEAT SINK MATERIAL  
Model 99 Heat Sink (6.5 x 12 x 1.6) \$ 22.00  
CHS-8 Copper Spreader (6 x 8 x 3/8) \$22.00

NEW!! 1K WATT 2-50 MHz Amplifier

### AMATEUR TELEVISION CONVERTERS

ATV1 420-450 \$ 44.95 Kit  
ATV3 420-450 (GaAs-FET) \$ 49.95 Kit  
ATV4 902-928 (GaAs-FET) \$ 59.95 Kit

### AUDIO SQUELCH CONTROL for ATV

SIL \$ 39.95 Kit

### 2 METER VHF AMPLIFIERS

35 Watt Model 335A \$ 79.95 Kit  
75 Watt Model 875A \$119.95 Kit

Available in kit or wired/tested

### POWER SPLITTERS and COMBINERS

600 Watt PEP 2-Port \$ 69.95  
1000 Watt PEP 2-Port \$ 79.95  
1200 Watt PEP 4-Port \$ 89.95

### 100 WATT 420-450 MHz PUSH-PULL LINEAR AMPLIFIER — SSB-FM-ATV

KEB67-PK \$159.95  
KEB67-PCB (PC Board) \$ 18.00  
KEB67-I (Manual) \$ 5.00

For detailed information and prices, call or write for our free catalog.

We ship worldwide.



**CCI** Communication Concepts Inc.

508 Millstone Drive • Xenia, Ohio 45385 • (513) 426-8600  
FAX (513) 429-3811



WE SHIP WORLDWIDE

## Amazing New Sonic 'SUPER EAR' MICROPHONE™

Lets You

# HEAR A WHISPER up to 100 feet away

**WARNING! BEWARE OF  
CHEAP IMITATIONS!**

Don't be fooled by "hearing devices" that look like ordinary radio units. Sonic Super Ear is the only high technological unit of it's kind with truly multi-directional capability that is used by surveillance experts around the world. Buy the best!

Just Aim...



And Listen!

The Same Style  
Used By Detectives,  
Secret Agents & Surveillance  
Experts — **NOW AVAILABLE  
FOR PRIVATE CITIZEN USE!**

You can INSTANTLY have "super-human hearing" to listen in on the hidden sounds of nature... on a quarterback's secret instructions. Pick a voice out of the crowd.

This lightweight, portable, surveillance-style 'SUPER EAR' MICROPHONE™ SYSTEM has the same advanced miniature sound amplification circuitry found in expensive professional models.

Unit weighs only 4 ounces — goes anywhere you do — is easily "hidden" and transported in briefcase, glove compartment, even coat jacket pocket! Makes the perfect gift for any amateur detective.

- **ULTRA SENSITIVE, MOISTURE-SEALED MICROPHONE AMPLIFIES SOUND UP TO 50 DECIBELS (at 2000Hz)!**
- **CAN BE USED HAND-HELD OR ATTACHED TO BINOCULARS AND TAPE RECORDER!**
- **COMES COMPLETE WITH HIGH PERFORMANCE ADJUSTABLE HEADPHONES!**
- **OPERATES ON JUST 1 "AAA" BATTERY (included)**

Retail Value  
~~\$79.95~~  
Special Price  
Now Only  
**\$19.99**

**PLEASE NOTE:** This device is not intended for eavesdropping or recordings of private conversations.

THE MOST PORTABLE, COMPACT SOUND-GATHERING SYSTEM EVER RELEASED FOR PUBLIC SALE!

Ultra-sensitive 4" "Shotgun Microphone" with volume controlled amplifier.



Comes with bracket for binocular attachment

STEREO HEADPHONES can also be used with your phonograph or tape player. © 1990 CSI

### 100% SATISFACTION GUARANTEED

Listen to all weddings, concerts, sporting events, etc.

A truly multi-directional amplification system to pinpoint sound.



Credit Card Holders  
Call Toll Free

**1-800-874-3337**

U.S. Consumer, — Dept. BE-90  
2721 U.S. 19 North, Suite 173, Palm Harbor, FL 34684

YES! Please rush me \_\_\_\_\_ (qty.) 'SUPER EAR' MICROPHONE SYSTEM(S) at only \$19.99 each plus \$2.75 postage & handling.

Enclosed is \$\_\_\_\_\_ FL & MI res. add sales tax.  
Charge to:  VISA  MC  AMEX  DINERS CLUB

Card # \_\_\_\_\_

Exp. Date \_\_\_\_\_ / \_\_\_\_\_ Signature \_\_\_\_\_

NAME \_\_\_\_\_

ADDRESS \_\_\_\_\_

CITY \_\_\_\_\_

STATE \_\_\_\_\_

ZIP \_\_\_\_\_

**Kenwood  
TS-950SD  
In Stock**



# TEL-COM

*Electronic Communications*

NEW ENGLAND'S FACTORY-  
AUTHORIZED SALES & SERVICE

FOR

**KENWOOD  ICOM**

Also displaying the popular accessories needed to complete a HAM STATION . . .

- ARRL PUBLICATIONS • AEA PRODUCTS • AMPHENOL
- ALPHA DELTA • ASTRON • AUSTIN ANTENNAS • AVANTI
- BELDEN • BENCHER • B & W • DAIWA • ALINCO
- HUSTLER • KLM • LARSEN • MIRAGE • ROHN
- TELEX/HY-GAIN • TOKYO HY-POWER LABS
- TRAC KEYERS • VIBROPLEX • WELZ • ETC.

OPEN SIX DAYS A WEEK   WELCOMED

**Telephone 508/486-3400, 3040**

675 Great Rd., (Rte. 119) Littleton, MA 01460

1<sup>3</sup>/<sub>4</sub> miles from Rte. 495 (Exit 31) toward Groton, Mass.

**NEW!**

**PK-232 MBX**

New Features  
including mailbox

**\$349.95**

Enjoy This  
**Martin  
TOWER  
and HAZER**

Never climb again with this tower and elevator system. MARTIN TOWERS are made of aluminum and specifically engineered for use with THE HAZER. All bolted construction, no welds. Easy to install hinge base, walk up erection, next plumb with leveling bolts in base. Mount antennas and rotor on HAZER in vertical upright position, then winch to top of tower for normal operating position. Guy wires fasten to HAZER or above HAZER at top of tower. Safety lock system operates while raising or lowering. Never can fall. Photo shows HAZER and antenna at top.

**SPECIAL TOWER PACKAGE** prices include everything but rotor and antenna: 50' M-18 alum. tower kit form, hinged base, concrete footing section, HAZER kit, Phyllystran guy wires, turnbuckles, earth screw anchors, 10' mast, thrust bearing, tool kit, rated at 15 sq. ft. antenna load @ 70 MPH. **\$1925.95** FOB Boonville.

50' M-13 alum tower, same pkg as above	<b>\$1637.95</b>
40' M-13 alum tower, same pkg as above	<b>1463.80</b>
30' M-13 alum tower, same pkg as above	<b>1294.25</b>
HAZER 2 for Rohn 25 - hvy duty alum 12 sq ft wind ld	<b>311.95</b>
HAZER 3 for Rohn 25 - Std alum 8 sq ft wind ld	<b>223.95</b>
HAZER 4 for Rohn 25 - Hvy galv stl 16 sq ft wind ld	<b>291.95</b>

Satisfaction guaranteed. Call today and charge to Visa, MasterCard or mail check or money order. Immediate delivery.

Glen Martin Engineering, Inc.  
R 2, B322, Boonville, MO 65233  
**816-882-2734**  
FAX: 816-882-7200



## Improve Your World Image



### PC HF FACSIMILE 4.0 \$99

A complete facsimile reception system for the IBM PC or Compatible. Receives up to 16 intensity levels.

- Includes:**
- Demodulator Software
  - 80 Page Manual Tutorial Cassette
  - Frequency List
  - Interpretation Guide
- Features:**
- Print on Epson, or HP Laser Jet
  - Disk Save, Zooming, Image processing
  - Unattended Image Capture and much more

### PC GOES/WEFAX \$250

Designed to receive images directly from U.S. and Soviet meteorological satellites. Includes all of the above feature plus a complete orbital tracking system and resolution of up to 256 gray levels.

**Software Systems Consulting**  
150 Avenida Cabrillo, "C", San Clemente, CA 92672  
**(714)-498-5784**

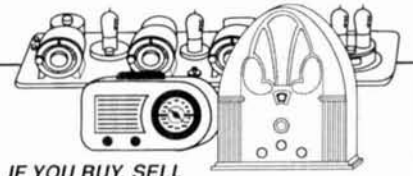

IF YOU BUY, SELL  
OR COLLECT OLD RADIOS, YOU NEED...

### ANTIQUE RADIO CLASSIFIED

FREE SAMPLE COPY!

Antique Radio's Largest Monthly Magazine Classifieds - Ads for Parts & Services  
Articles - Auction Prices-Flea Market Info.  
Also: Early TV, Ham Equip., Books, Telegraph, Art Deco, 40's & 50's Radios & more...  
Free 20-word ad each month. Don't miss out!

6-Month Trial - \$11.  
1-Year: \$20 (\$30 by 1st Class)

Foreign by air - Canada: \$32; Mexico: \$30; Other: \$60.  
A.R.C., P.O. Box 802-A5, Carlisle, MA 01741

Photo I shows an upper trace with an intensified zone. The whole trace is a product of the main timebase. The intensified zone is a product of the delayed (second) timebase. The starting point of the intensified zone depends on the pot setting, regardless of whether it's a precision pot or not. The length of the intensified zone is the length of the delayed sweep. Changing from "main" or "A" timebase to "delayed" or "B" produces the result shown in the lower trace — an expansion of the intensified zone.

If you want to examine a pulse train, set it up as shown in the upper trace and look at the greatly expanded pulses using the B sweep. A good example of an application of this kind is viewing data off hard disks.

Once again, I'd advise you not to spend the money for delayed sweep if you don't have a use for it. The sweep magnifier lets you do almost the same thing on a more limited scale, and for some applications it's just as satisfactory.

## Triggers

The most basic trigger circuit should have AC and DC coupled triggers, and a choice of positive slope or negative slope. This permits locking on the front or back side of most signals. These basic functions take care of a surprising number of situations. My own instrument spends practically all of its time in the AC+ position.

There are, however, some nice additions that don't necessarily cost a lot. These are AC low frequency reject, AC high frequency reject, line, single sweep, TV horizontal, and TV vertical.

AC high frequency reject is useful if you need a stable display of an AM signal and want to look at the modulation envelope. With simple AC or DC coupling, your 'scope is going to have a hard time. Each RF cycle evokes a trigger, and you won't be able to stabilize the envelope. Switch in the high frequency reject, and the RF usually becomes a blur. But the envelope is stable, because that's all the trigger circuit can "see."

The reverse situation is also useful. If, for example, you want to look at an audio frequency signal that's carrying a bunch of RF trash, you can invoke AC high frequency reject and the 'scope will trigger on the AF only.

Line triggering locks you to the AC line. Want to know if a signal is derived from the AC line? Just switch to the line triggering, and look to see if your signal stands still on the screen. If it does, your signal is line related.

Single sweep doesn't rearm the trigger after the sweep. It lets you wait for a trigger, generate one sweep, and then waits for you to rearm the sweep manually. This gives you a convenient way to monitor for a single shot event.

TV horizontal and vertical triggers are just that. They let you generate a stable trace that's locked to the horizontal or vertical synch pulses of a television signal.

## Extras or convenience features

The following features are ones that often make the difference between a tool that does the job and one that makes the tool a joy to use.

Consider a simple thing like graticule illumination. You'll notice that you can see the graticule in some of the photos, and in others you can't. The difference lies in the addition of a couple of small light bulbs and a pot on the front panel. This isn't a big deal from the expense standpoint, and is a very useful feature — even if you're not planning to take

PHOTO J

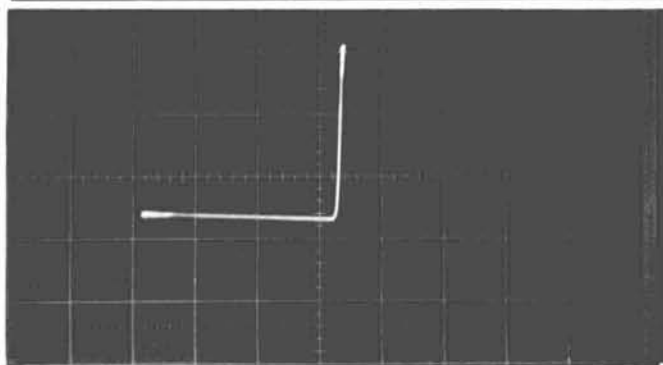

Current versus voltage curve of a diode, using the component tester in an oscilloscope.

photos. Recently I finished up a little keyer for portable use, and had to trim the timing components for an exact 3:1 dash/dot ratio. I turned on my 'scope and put the timebase on one of its slower sweep speeds. My 'scope is a Heath SO-4251, which is not a storage model, and I had to turn down the lights to see the afterglow of the trace. When the lights are low, you can't see the graticule unless it's illuminated, so I was very glad to have that convenience.

A component tester is another feature that can be very handy. This is a simple gadget that allows you to put a low amplitude swept voltage on a component, even when it's in a circuit, and lets you see the component's current-versus-voltage curve. The component tester lets you make some intelligent estimates of component values and quality. You can see the trace of a good diode in Photo J. One word of warning. It's very tempting to use a component tester across the emitter base junction of a transistor. If you're not careful, this can have a very insidious effect. It will degrade the beta of the transistor you're testing,<sup>3</sup> and create problems you didn't have before. Emitter base breakdown apparently punches little holes in the junction; that's something you don't need.

You might also want to check out the tube's accelerating potential. The higher it is, the brighter the tube will be. On a 20-MHz instrument 2.5 to 3 kV is enough. This is often the voltage manufacturers use, because it provides satisfactory performance at a reasonable price. As bandwidth increases, so does your need for accelerating potential, since your timebase spreads your beam electrons thinner and thinner as you increase sweep speed. Seven to 9 kV are nice in a 40 to 50-MHz instrument; very high bandwidth units can have potentials up to 25 kV.

## Conclusion

Though this isn't a complete discussion of oscilloscopes, I hope you'll find it helpful as a purchasing guide. The information presented here should enable you to make an informed decision and have some sense of where the oscilloscope you choose can be properly applied. 

### REFERENCES

1. *The 1989 ARRL Handbook for the Radio Amateur*, ARRL, 1989, page 25-26.
2. Bob Orwiler, "Vertical Amplifier Circuits," *Tektronix*, 1969.
3. Wes Hayward and Doug DeMaw, *Solid State Design for the Radio Amateur*, ARRL, 1986, page 24.



# Ham Notebook

## More RIT/XIT for the Kenwood TS-530S

We all have our weak spots, and mine is CW DX. I don't rabidly chase DX, but when it's there I do my best to work it. So when I heard the XF4 expedition on 15 meters calling CQ and listening up 5 kHz, I found the frustration almost unbearable from not being able to tune that far from my transmit frequency.

### The problem

The TS-530S is a serviceable rig, but it has a range of only about  $\pm 1.5$  kHz on its receiver incremental tuning (RIT) function. Because RIT is usually implemented with a varactor and pot for bias, I thought I'd try to find it on the schematic in the owner's manual and see if I could coax it into tuning farther. Stripped of a lot of extra lines on the drawing, the schematic is shown in **Figure 1**. Pot VR5 on the IF assembly sets the range midpoint, and the varactor in the VFO assembly is the actual component that changes.

The "cleanest" modification would be to change the varactor for one with a wider tuning range. This would be hard to do, though, as the VFO is a sealed assembly. A cheap and dirty alternative would be to increase the voltage swing to the varactor, and this is the method I used.

Not knowing anything about the particular diode used, I was concerned about increasing the diode voltage. A quick look at the schematic showed that this wasn't possible, because the full 9-volt supply is across the diode when the pot is at one end of its rotation. All I had to do was increase the voltage swing.

If I knew the varactor tuning curve, calculating the range would be easy. Lacking that, I clipped some test leads across the 6.8-k resistor to ground and paralleled some resistance until the tuning range was what I wanted. I settled on a 1-k resistor as the value to add in parallel to the existing part.

### Circuit changes

Installing the 1-k resistor (marked \* in **Figure 1**) is the only thing tricky about this mod. First, I moved the exist-



PHOTO A

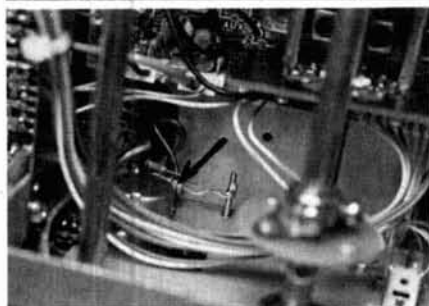

Changes to extend the Kenwood TS-530S RIT take about an hour.

ing resistor slightly out and down. Then I prepared the new part by forming a loop in one lead, tinning it lightly, and cutting the other lead to length. I looped the tinned end over the existing resistor, flowed the solder with my smallest iron, then wrapped the other end in place and soldered it. All of this inside work was made easier because I had a pair of hemostats\* to do the fine positioning and holding. **Photo A** shows the completed modification.

Once the resistor is installed, you'll need to set VR5 so the frequency doesn't change when you turn on the RIT. Center the front panel pot and turn the RIT on and off. Note the frequencies with and without the RIT, and adjust VR5 so there's no change when you turn RIT on.

With the modification in place, the RIT tunes  $\pm 5.1$  kHz. I was a little ner-

\*A clamplike instrument used in surgery to reduce or prevent bleeding. Ed.

FIGURE 1

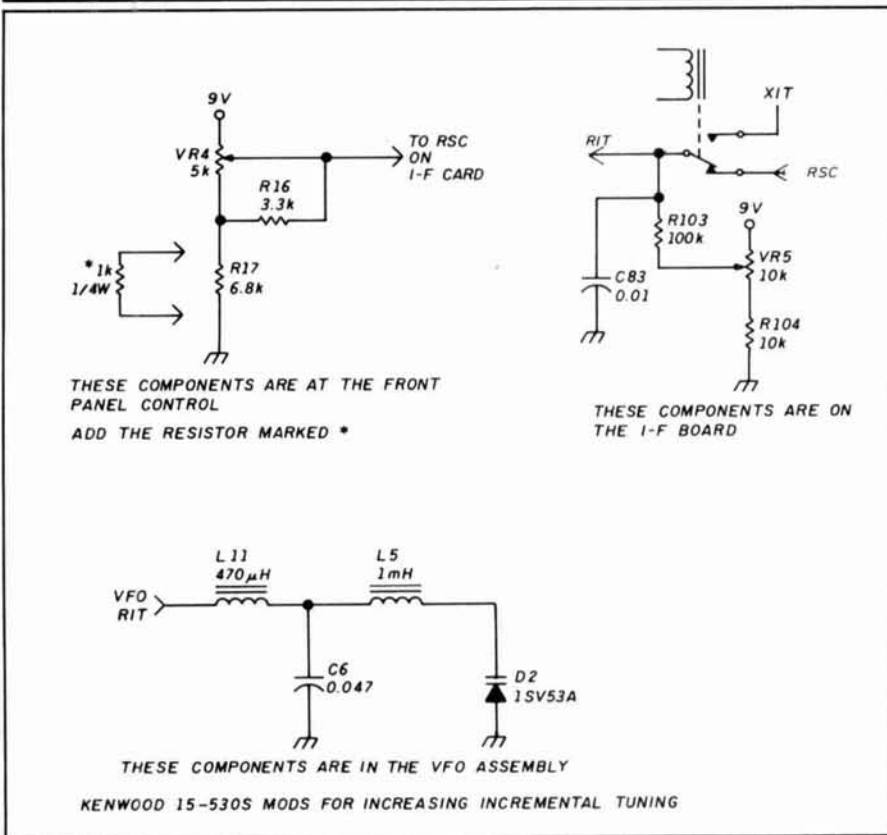

Kenwood TS-530S mods for increasing incremental tuning.

vous about trying for more range, because all but the most expensive varactors have a nonlinear tuning curve, and I wanted the resulting tuning range to be symmetrical on the RIT control.

This modification took about an hour from the time I decided to do it until the rig was buttoned up and operational. In case you were wondering, I worked the XF4 station a few hours later, both SSB and CW, with 5 kHz of RIT.

**Bob Lombardi, WB4EHS**

## FREE CATALOG!

Features Hard-to-Find Tools and Test Equipment



Jensen's new catalog features hard-to-find precision tools, tool kits, tool cases and test equipment used by ham radio operators, hobbyists, scientists, engineers, laboratories and government agencies. Call or write for your free copy today.

**JENSEN®** Dept. HR  
7815 S. 46th Street  
Phoenix, AZ 85044  
TOOLS INC. (602) 968-6231

✓ 136

### SIGNAL-TO-NOISE Voting Comparator

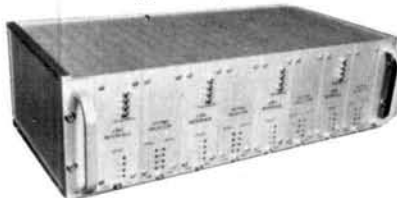

Improve coverage by adding receivers

- Expandable to 32 Channels
- Continuous Voting
- 19" Rack Mountable
- Select/Disable Switches for Manual Override
- Can be used with RF Links or Dedicated Lines
- LED Indicators
- Hundreds in Service
- More

—Competitively Priced—

For more information call or write:

**Doug Hall Electronics**

815 E. Hudson St.

Columbus, Ohio 43211 • (614) 261-8871

✓ 137

## High Performance vhf/uhf preamps



Receive Only	Freq. Range (MHz)	N.F. (dB)	Gain (dB)	1 dB Comp. (dBm)	Device Type	Price
P28VD	28-30	<1.1	15	0	DGFET	\$29.95
P50VD	50-54	<1.3	15	0	DGFET	\$29.95
P50VDG	50-54	<0.5	24	+12	GaAsFET	\$79.95
P144VD	144-148	<1.5	15	0	DGFET	\$29.95
P144VDA	144-148	<1.0	15	0	DGFET	\$37.95
P144VDG	144-148	<0.5	24	+12	GaAsFET	\$79.95
P220VD	220-225	<1.8	15	0	DGFET	\$29.95
P220VDA	220-225	<1.2	15	0	DGFET	\$37.95
P220VDG	220-225	<0.5	20	+12	GaAsFET	\$79.95
P432VD	420-450	<1.8	15	-20	Bipolar	\$32.95
P432VDA	420-450	<1.1	17	-20	Bipolar	\$49.95
P432VDG	420-450	<0.5	16	+12	GaAsFET	\$79.95
<b>Inline (rf switched)</b>						
SP28VD	28-30	<1.2	15	0	DGFET	\$59.95
SP50VD	50-54	<1.4	15	0	DGFET	\$59.95
SP50VDG	50-54	<0.55	24	+12	GaAsFET	\$109.95
SP144VD	144-148	<1.6	15	0	DGFET	\$59.95
SP144VDA	144-148	<1.1	15	0	DGFET	\$67.95
SP144VDG	144-148	<0.55	24	+12	GaAsFET	\$109.95
SP220VD	220-225	<1.9	15	0	DGFET	\$59.95
SP220VDA	220-225	<1.3	15	0	DGFET	\$67.95
SP220VDG	220-225	<0.55	20	+12	GaAsFET	\$109.95
SP432VD	420-450	<1.9	15	-20	Bipolar	\$62.95
SP432VDA	420-450	<1.2	17	-20	Bipolar	\$79.95
SP432VDG	420-450	<0.55	16	+12	GaAsFET	\$109.95

Every preamplifier is precision aligned on ARR's Hewlett Packard HP8970A/HP346A state-of-the-art noise figure meter. RX only preamplifiers are for receive applications only. Inline preamplifiers are rf switched (for use with transceivers) and handle 25 watts transmitter power. Mount inline preamplifiers between transceiver and power amplifier for high power applications. Other amateur, commercial and special preamplifiers available in the 1-1000 MHz range. Please include \$2 shipping in U.S. and Canada. Connecticut residents add 7-1/2% sales tax. C.O.D. orders add \$2. Air mail to foreign countries add 10%. Order your ARR Rx only or inline preamplifier today and start hearing like never before!

### Advanced Receiver Research

Box 1242 • Burlington, CT 06013 • 203 582-9409



✓ 135



# ICOM



SEE YOU IN DAYTON

## VHF COMMUNICATIONS

9:00 am - 5:30 pm  
weekdays

Weekends and evenings  
by appointment.



280 Tiffany Avenue  
Jamestown, New York 14701

Weston New York's finest... amateur radio dealer!  
1-800-752-8813 (For Orders Only)

✓ 138



# SKYWAVE COMMUNICATIONS PART 2

## The atmosphere and the ionosphere

By Cornell Drentea, WB3JZO

**A**ccording to Kenneth Davies,<sup>1</sup> Watson-Watt was the first to apply the term ionosphere to "that part of the atmosphere in which free ions exist in sufficient quantities to affect the propagation of radio waves." Other names associated with the ionosphere include Stuart (1878), Schuster (1889), Heaviside (1902), and Kennelly (1902). The discovery of how the ionosphere affects radio communications can also be attributed to the many Amateur Radio operators who have experimented with it during this century. The ionosphere can be a very hard thing to define due to its ever changing refractive and reflective characteristics. Although there is not complete agreement, it is generally accepted that the ionospheric region extends in the atmosphere from about 30 km (18.6 miles) above the earth's surface to almost 1,000 km (620 miles).

Assuming that its content remains constant with the altitude (a theory which is disputed), the general atmosphere is made up of the following gases:

Gas	Volume (percent)	Mass (percent)
Nitrogen	78.09	28.02
Oxygen	20.95	32.01
Argon	0.93	39.96
Carbon dioxide	0.33	44.02

Small amounts of water vapor, ozone, nitric oxide, and hydrogen also occur.

Within this concept, the atmosphere follows general meteorological behavior. Turbulent mixing exists up to 100 km (62 miles), with pressure and density variations behaving according to well-known barometric equations.

Some assume that above this altitude the atmosphere presents the same composition, but that its content is much more rarefied. Here, the ultraviolet rays and the x-rays coming from the sun generally produce the ionospheric reflective and refractive effects. During periods of disturbed sun, particle radiation — like high energy protons, alpha particles, and low energy protons and electrons — disturbs

the ionosphere down to altitudes as low as 45 km (28 miles) above the surface. Under these conditions absorption of earth-generated waves takes place, so their energy will never reach the higher altitude reflective layers.

### Sunspots and flares

The mechanism of the sun causes the ionization of the rarefied gases when the radiation passes through the ionosphere. This gaseous globe of fire is 540,000 km (335,540 miles) in diameter. Its volume is one and a third million times the volume of the earth, while its density is only one-fourth that of the earth. The temperature at the center of the sun is believed to be approximately 7.2 million degrees Celsius (13 million degrees Fahrenheit). There are those who dispute this figure, believing that it is twice that much. At the surface of the sun, the temperature has been measured in the vicinity of 5,500 degrees Celsius (10,000 degrees Fahrenheit). The sun's hot gases are composed of dissociated atoms. Elements like hydrogen make up about 70 percent of the sun's mass, while helium makes up about 28 percent. The remaining 2 percent consists of all the heavier elements. Only a few hardy compounds hold together in the unspotted areas of the sun. The light and heat radiation received continuously on earth from the sun is the equivalent of about 1.5 kW per square meter. The sun has been outputting this energy for more than a billion years, and will likely continue to do so for several billion more.

The most important process on the sun impacting the ionosphere is the formation of sunspots. Sunspots are confined, eruptive masses of cooled gaseous plasma, which exhibit molecular (versus atomic) composition and move about the sun's surface in a swirling fashion. This happens to a greater extent every eleven years or so, creating what is known as the sunspot cycle. However, a certain number of spots exist on the surface of the sun at all times. To an observer, they appear in groups and move in a westerly direction across the sun's surface. Their speeds differ slightly, depending on their exact latitude. The sunspot rotation cycle is approximately 27.5 earth days (the sun's rotation period), making it easy to predict a rounded 28-day

## INTRODUCING OUR NEW COMPUTER-CONTROLLED REP-200 REPEATER

If you always thought a computer-controlled repeater had to be expensive, LOOK AGAIN! You could easily spend this much just for a controller.

As always, Hamtronics strives to give superb performance at modest cost! In this case, a premium repeater with versatile computer control, autopatch, and many dtmf control features at less than many charge for a bare-bones repeater!

We don't skimp on rf modules, either! Check the features on R144 Receiver, for instance. GaAs FET front-end, helical resonators, sharp crystal filters, hysteresis squelch.

We completely re-thought the whole idea of what a repeater should be, to give the best features at the lowest cost.

**ONLY \$1295!**

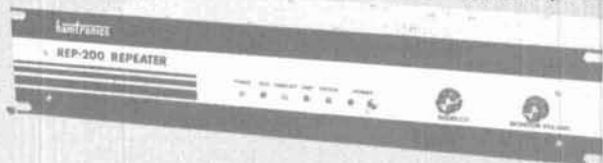

- Available for the 10M, 6M, 2M, 220MHz, 440MHz, 902MHz ham bands. FCC type accepted models also available for vhf and uhf commercial bands.
- Rugged exciter and PA, designed for continuous duty.
- Power output 15-18W (25W option) on 2M or hi-band; 15W on 220MHz; 10W on uhf or 902MHz.
- Accessory add-on PA's available with power levels up to 100W.
- Five courtesy beep types, including a pleasant multi-tone sequence.
- AUTOPATCH: either open or closed access, toll-call restrict, auto-disconnect.
- Reverse Autopatch, two types: auto-answer or ring tone on the air.
- DTMF CONTROL: over 45 functions can be controlled by touch-tone. Separate 4-digit control code for each function, plus extra 4-digit owner password.
- Owner can inhibit autopatch or repeater, enable either open- or closed-access for repeater or autopatch, and enable toll calls, reverse patch, kerchunk filter, site alarm, aux rcvr, and other options, including two auxiliary external circuits.
- The cwid message, dtmf command codes, and owner-specified default parameters for cor and cwid timers and tones are burned into the eeprom at the factory.
- Cw speed and tone, courtesy beep and tail timers, and courtesy beep type can all be changed at any time by owner-password-protected dtmf commands.
- Many built-in diagnostic & testing functions using microprocessor.
- Color coded led's indicate status of all major functions.
- Welded partitions for exciter, pa, receiver, and controller. PEM nuts for covers.
- 3-1/2 inch aluminum rack panel, finished in eggshell white and black.
- Auxiliary receiver input for independent control or cross linking repeaters.

There are many other features, too numerous to mention. Request catalog for full details.

## HIGH PERFORMANCE XMTRS & RCVRs FOR REPEATERS, AF & DIGITAL LINKS, TELEMTRY, ETC.

### FM EXCITERS:

- kits \$99, w/t \$169. 2W continuous duty. TCXO & xtal oven options available. FCC type accepted for com'l uhf & hi bands.
- TA51 for 10M, 6M, 2M, 150-174, 220MHz.
- TA451 for uhf.
- TA9D1 for 902-928MHz, 0.5W out (w/t only, \$169).
- VHF & UHF AMPLIFIERS. For fm, ssb, atv. Output from 10W to 100W. Several models, kits starting at \$79.

### FM RECEIVERS:

- R144/R220 FM RECEIVERS for 2M, 150-174, or 220MHz. GaAs FET front end, 0.15uV sensitivity! Both crystal & ceramic if filters plus helical resonator front end for exceptional selectivity: >100dB at ±12kHz (best available anywhere!). Flutter-proof hysteresis squelch; afc tracks drift.
- R451 UHF FM RCVR, similar to above
- R901 902-928MHz FM RCVR. Triple-conversion, GaAs FET front end.
- R76 ECONOMY FM RCVR for 10M, 6M, 2M, 220MHz, w/o helical res. or afc. Kits \$129.
- Weather satellite & AM aircraft rcvrs also available.

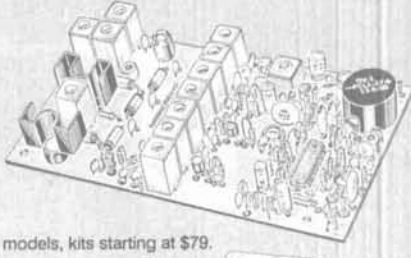

If you prefer a plain-vanilla or kit repeater, you couldn't find a better value than our original **REP-100 REPEATER**

Same fine rf modules as REP-200 but with COR-4 Controller. Can add autopatch, dtmf decoder, CTCSS, either now or later. Kit only \$675, w/t \$975.

## ACCESSORIES

- **COR-3 REPEATER CONTROLLER kit.** Features adjustable tail & time-out timers, solid-state relay, courtesy beep, and local speaker amplifier .....\$49
- **CWID kit.** Diode programmed any time in the field, adjustable tone, speed, and timer, to go with COR-3 .....\$59

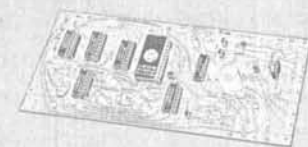

**NEW COR-4 kit.** Complete COR and CWID all on one board for easy construction. CMOS logic for low power consumption. Many new features. EPROM programmed; specify call .....\$99



**NEW TD-3 SUBAUDIBLE TONE DECODER/ENCODER kit.** Adjustable for any tone. Designed especially for repeaters, with remote control activate/deactivate provisions .....\$24

**TD-2 TOUCH-TONE DECODER/CONTROLLER kit.** Full 16 digits, with toll-call restrictor, programmable. Can turn 5 functions on/off. Great for selective calling, tool .....\$79

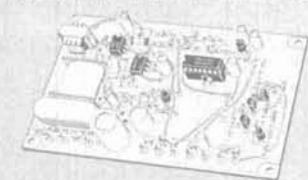

- **AP-3 AUTOPATCH kit.** Use with above for repeater autopatch. Reverse patch & phone line remote control are std. ....\$79
- **AP-2 SIMPLEX AUTOPATCH Timing Board kit.** Use with above for simplex operation using a transceiver .....\$39



**MO-202 FSK DATA MODULATOR kit.** Run up to 1200 baud digital signals through any fm transmitter with full handshakes. Radio link computers, telemetry gear, etc. ....\$39

**DE-202 FSK DEMODULATOR kit.** For receive end of link. ....\$39

**9600 BAUD DIGITAL RF LINKS.** Low-cost packet networking system, consisting of new MO-96 Modem and special versions of our 220 or 450 MHz FM Transmitters and Receivers. Interface directly with most TNC's. Fast, diode-switched PA's output 15 or 50W. Call for more info on the right system for your application!

## GaAs FET PREAMPS

at a fraction of the cost of comparable units!

### LNG-(\*)

**ONLY \$59**  
wired/tested



FEATURES:

- Very low noise: 0.7dB vhf, 0.6dB uhf
  - High gain: 13-20dB, depends on freq
  - Wide dynamic range - resist overload
  - Stable: low-feedback dual-gate FET
- \*Specify tuning range: 25-30, 46-56, 137-150, 150-172, 210-230, 400-470, or 800-960 MHz.

### LNW-(\*) MINIATURE GaAs FET PREAMP

**ONLY \$24/kit, \$39 wired/tested**

- GaAs FET Preamp similar to LNG, except designed for low cost & small size. Only 5/8"W x 1-5/8"L x 3/4"H. Easily mounts in many radios.
- \*Specify tuning range: 25-35, 35-55, 55-90, 90-120, 120-150, 150-200, 200-270, or 400-500 MHz.

### LNS-(\*) IN-LINE PREAMP

**ONLY \$79/kit, \$99 wired/tested**

- GaAs FET Preamp with features similar to LNG series, except automatically switches out of line during transmit. Use with base or mobile transceivers up to 25W. Tower mounting brackets incl.
- \*Specify tuning range: 120-175, 200-240, or 400-500 MHz.

## HELICAL RESONATOR PREAMPS

Preamps with 3 or 4 section helical resonators reduce intermod & cross-band interference in critical applications. MODEL HRA-(\*) \$49 vhf, \$94 uhf. \*Specify tuning range: 142-150, 150-162, 162-174, 213-233, 420-450, 450-470.



## RECEIVING CONVERTERS

Low noise converters to receive vhf and uhf bands on a 10M receiver. Choice of kit with case & BNC jacks, kit with pcb only, or w/t unit in a case. Other models available for other in/out ranges & atv. Request catalog for complete listings.

VHF input ranges avail: 136-138, 144-146, 145-147, 146-148, 220-222, 222-224; kit less case \$39, kit w/case \$59, w/t in case \$89.

UHF input ranges avail: 432-434, 435-437; kit less case \$49, kit w/case \$69, w/t in case \$99.

902-928 MHz converts down to 422-448 or 430-450 range. Same price as uhf.

## TRANSMITTING CONVERTERS

XV2 for vhf and XV4 for uhf. Models to convert 10M ssb, cw, fm, etc. to 6M, 2M, 220, 432, 435, and for atv. 1W output. Kit only \$79. PA's up to 45W available. Request catalog for complete listings.

OUR 27TH YEAR!

# hamtronics, inc.

65 MOUL RD. - HILTON NY 14468-9535  
Phone: 716-392-9430 -- FAX: 716-392-9420

Hamtronics is a registered trademark. Copyright 1989, Hamtronics, Inc. All rights reserved.

- For complete info, call or write for FREE 40-page catalog. Send \$2 for overseas air mail. For casual interest, check reader service; allow 3-4 weeks.
- Order by mail, fax, or phone (answering machine off hrs).
- Min. \$3 S&H charge for first pound plus add'l weight & ins.
- Use VISA, Mastercard, check, or UPS C.O.D. (\$3 fee).

# NUTS & VOLTS

## MAGAZINE

P.O. Box 1111-H  
PLACENTIA, CA 92670  
714-632-7721



Ham Radio  
Computer Hardware  
Computer Software  
Plans-Kits  
Schematics  
Test Equipment  
CB Gear  
Satellite TV  
Video  
Components  
Antique Electronics  
Cable TV  
Publications  
Repairs-Services  
New Products  
Events Calendar

**IF YOU ARE INTO ELECTRONICS AND SAVING MONEY IS IMPORTANT TO YOU, THEN YOU OWE IT TO YOURSELF TO TRY NUTS & VOLTS MAGAZINE. DISCOVER WHY THOUSANDS OF SMART PEOPLE NATIONWIDE TURN TO NUTS & VOLTS EACH MONTH TO MEET THEIR ELECTRONIC NEEDS. WHETHER YOU'RE BUYING, SELLING, OR JUST TRYING TO LOCATE THOSE UNIQUE OR HARD-TO-FIND ITEMS, FIND OUT HOW NUTS & VOLTS CAN HELP!**

### SUBSCRIBE TODAY!

CHECK    MONEY ORDER    VISA    MC

Name \_\_\_\_\_

Address \_\_\_\_\_

City \_\_\_\_\_

State \_\_\_\_\_ Zip \_\_\_\_\_

Card No. \_\_\_\_\_ Exp. Date \_\_\_\_\_

CALL FOR ADVERTISING INFORMATION  
DISTRIBUTOR INQUIRIES INVITED

### Subscription Rates

U.S. FUNDS REQUIRED

#### 3rd Class Mail - USA

One Year ..... \$12.00  
Two Years ..... \$21.00  
Lifetime ..... \$60.00

#### 1st Class Mail

One Year - USA ..... \$20.00  
Canada & Mexico ..... \$22.00

#### Air Mail

Foreign - 1 Year ..... \$55.00

Includes one FREE 40-word  
Classified Ad

Toll Free **ORDERS** Only Line  
1-800-783-4624

*A National Publication For The Buying And Selling Of Electronic Equipment*

✓ 133

### Model WLA24M

#### 5-1000 MHZ PREAMPLIFIER

For analyzers, scopes, radio/TV, ICOM R-7000, scanners, etc. Gain 23 dB, Noise Fig. 3 dB, Pout (1dB) 18 dBm, 12-15 VDC. Usable 2-1100 MHz, with input protection, in cast aluminum case. Pull signals from noise. Only \$109 + \$4. Bypass switch & 430/50 MHz conv. available. Mast mount WLA24T \$169.



### WILAM TECHNOLOGY

P.O. Box 5174, MASSENA, N.Y. 13662  
(315) 769-8334

✓ 175

### MAKE CIRCUIT BOARDS THE NEW, EASY WAY



#### WITH TEC-200 FILM

#### JUST 3 EASY STEPS:

- Copy circuit on TEC-200 film using any plain paper copier
- Iron film on to copper clad board
- Peel off film and etch

**SATISFACTION GUARANTEED**  
convenient 8½ x 11 size

**5-Sheets for \$3.95**  
**10 sheets only \$5.95**

add \$1.25 postage — NY res. add sales tax

### The MEADOWLAKE Corp.

DEPT. D, P.O. Box 497  
Northport, New York 11768

✓ 176

### HAM LICENSE PREPARATION

#### WRITTEN TEST STUDY GUIDES

All word-for-word questions, multiple choices... answers. Choose Novice, Technician, General, Advanced or Extra Class Answer explanations supplied!

**\$4.95 Each version + \$1.50 shipping.**

**All five manuals: \$22.95 postpaid.**

#### HAM RADIO Q&A MANUAL

All 1,932 questions, multiple choices and answers found in every ham license exam, Novice through Extra Class.

**\$9.95 Shipped postpaid.**

#### MORSE CODE TEST PREPARATION

Set contains two 2-hr. cassette tapes

Code Teacher,	0-5 WPM	\$9.95
General Code,	3-15 WPM	\$9.95
Extra Code,	12-21 WPM	\$9.95

**Plus \$1.50 shipping per set.**

All Manuals/Code Tapes:	\$49.95
New \$Part 97 Ham Rules:	\$ 2.95

Order shipped same day received!  
Credit card phone orders: 10 a.m. - 2 p.m.

#### W5YI MARKETING

P.O. Box #565101 - Dallas, TX 75356  
Tel: (817) 461-6443 - 24 hours

propagation cycle. Sunspot diameters have been measured at up to 128,000 km (79,535 miles). The spots appear darker than the surface of the sun because of their lower temperature — 4,400 degrees Kelvin (4,126 degrees Celsius, or 7,460 Fahrenheit) compared with 6,100 degrees Kelvin (5,826 degrees Celsius, or 10,520 Fahrenheit). They are likely to appear in two rather narrow bands located equidistant from the sun's equator. Groups that are usually characterized by two larger spots accompanied by a number of smaller ones appear at latitudes of 5 to 30 degrees north and south of the sun's equator. Through selective spectrum analysis, the paired sunspots have been identified to contain reversed magnetic polarity from each other. For example, during a particular cycle the preceding spots in the Northern Hemisphere show their positive poles, while the following spots show their negative poles. The process is reversed in the Southern Hemisphere. An interesting phenomenon occurs when a new cycle begins; this magnetic mechanism appears to be reversed from the previous cycle.

Study of the molecular composition of sunspots has revealed that they contain about 18 compounds. These include titanium oxide and the hydrides (compounds of hydrogen with other elements) of calcium and magnesium. The sunspot's powerful magnetic fields have been measured at about 4500 gauss. They keep the colder matter confined within the spot's perimeters.

Explosive outbursts of matter and energy at the edges of the sunspots are called flares. These explosions are associated with sunspots, but not to be confused with them. Flares burst out in space from the edges of sunspots to an altitude of about 20,000 km (12,427 miles) at speeds of about 300 km per second (186 miles per second). The resulting radiation, composed of copious amounts of ultraviolet rays, x-rays, and cosmic particles, leaves the surface of the sun and travels out into space. Depending on its nature and, consequently, its speed, a certain amount of this energy arrives here on earth at various intervals. For instance, it takes approximately 8.3 minutes for the ultraviolet and x-rays to arrive in the ionosphere, 15 minutes for the high energy particles like alpha rays and protons, and 18 to 40 hours for the low energy protons and electrons. This latter type of radiation is also known as the solar wind.

## Ionospheric interaction

As flare radiation penetrates the earth's atmosphere, it interacts with the rarefied gases starting at about 600 km (373 miles) from earth. The interaction with the denser gaseous layers located closer to the earth's surface tapers off the flare's energy at about 30 km (18.6 miles) from the earth's surface where the ionosphere ceases to exist. According to a recent theory, the ionosphere can be thought of as a thick layer of disassociated atmospheric gases impacted primarily by ultraviolet radiation and x-rays. Because the ultraviolet radiation is not monochromatic, you can assume that certain gases, depending upon how they occur at different altitudes in the atmosphere, provide various degrees of absorption to certain wavelengths. This, in turn, creates several layers of ionization.<sup>2</sup>

Another current theory says that, contrary to appearances, the ionosphere is not made up of separate physical layers, but that the degree of ionization (the number of electrons per unit volume) is a continuous function of altitude, with maxima and areas of inflection. Therefore, we should

talk about "ionized regions" rather than the more accepted layer terminology.<sup>3</sup> However, the word layer would be acceptable (because it has been used for many years) if defined as the altitude at which wave reflection takes place.

In any case, the ionization process consists of a breakup of neutral molecules and atoms into free electrons and positive ions. The free electrons recombine with the positive ions or attach to other neutral molecules, creating negative polarized ions. It is believed that the free electrons are responsible for the ionospheric reflections and refractions. If you accept the second theory, electron density is a function of the continuous equilibrium between the electron creation processes and the de-ionization processes. It depends on the recombination of the positive ions with the electrons, and the electron capture by other neutral atoms. Because of their heavy mass, it is believed that ionized atoms do not play a role in propagation.

The status of the ionosphere is always changing and depends on many things like sunspot activity, the magnetic field generated by the earth, the time of day, and even the winds in the upper atmosphere. Proof of some of these dependencies was demonstrated during ionosphere heating experiments at Arecibo Observatory when it was discovered that plasma waves were being generated in the ionosphere. This in turn accelerated the free electrons to high energies, making them travel from one hemisphere to the other. The experiments at Arecibo have led to speculation that certain new forms of electromagnetic waves can be generated through the modulation of these electric currents into the ionosphere, and that the process can be used for communication purposes.

To conclude, the ionosphere is comprised of several layers of dense ionization which are always changing and overlapping each other, but that can be defined distinctly enough to be studied individually. Now I'll look at what happens to HF radio signals arriving in the ionosphere.

According to one theory, the electric field of an earth-generated HF wave arriving at an excited ionospheric layer causes the electrons to oscillate at the same frequency as the original signal. This oscillation produces a new electric field which is mathematically out of phase from the incident wave. The result is a perceived refraction or reflection of the wave at the ionosphere level. The transmitted signal can be received back on earth in the direction of the short or long paths at great distances. This is known as "skip." The regenerated (reflected) wave can bounce back and forth between the ionosphere and earth several times, making for audible and measurable delays over great distances (multiple hop propagation).

Some recent speculations suggest an even newer concept in long distance low power (QRP) communications. Some feel there is good reason to believe that the excited electrons in the ionosphere act not only as a reflector as is generally known, but as a plasma amplifier and a re-radiating antenna at the same time.\* When conditions are right, a gain of anywhere from about 3 to 6 dB is believed to be obtained. The theory behind this mechanism is based on a lasing-like\*\* reaction of the RF-excited mag-

\* This theory was advanced by Albert Henderson, K6AJ, at RF Expo 1985 in Anaheim, California. It has not been validated by other laboratories, like the National Astronomy and Ionosphere Center, or by the Los Alamos National Laboratory.

\*\* LASER stands for light amplification by stimulated emission of radiation; MASER stands for microwave amplification by stimulated emission of radiation.

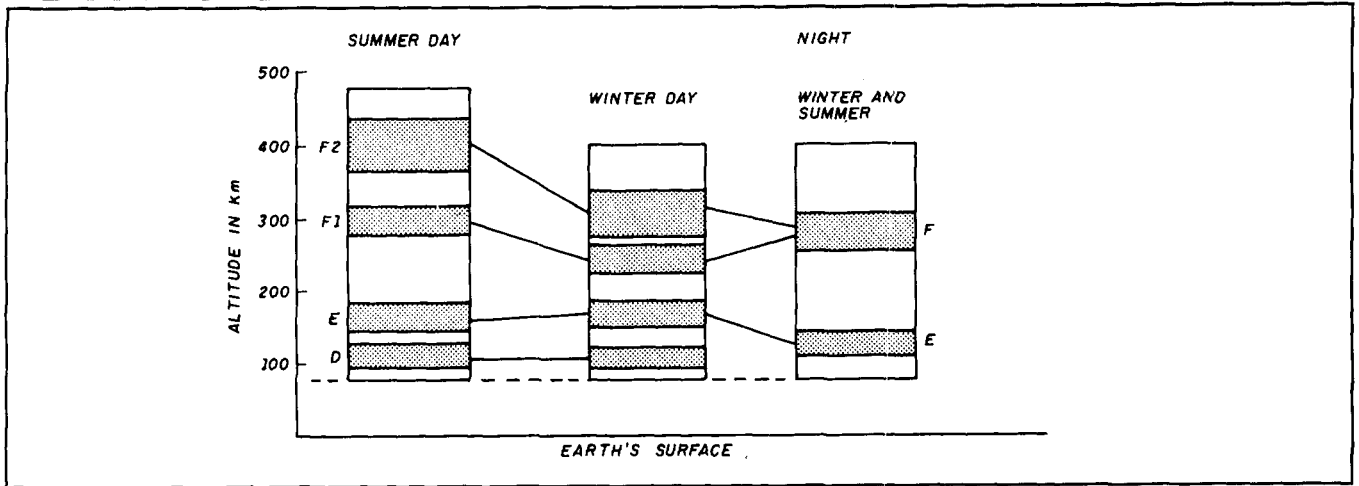
**FIGURE 1****Altitude changes for D, E, F1, and F2 layers depending on season and time of day.**

netic fields, which in turn excites other electrons under the influence of the ultraviolet radiation in sort of a chain reaction.

## The ionospheric layers

I've discussed how the ionospheric layers form. I'll describe these layers and their properties only briefly, assuming that from reading other publications you are generally familiar with the position and properties of each layer.

Sir Edward Appleton was responsible for defining and classifying the ionospheric layers in 1924. According to Appleton, the most important layers for communications are the D, E, F1, and F2 layers. The first layer identified was named E for the word electric. The other nomenclature followed in place. **Figure 1** shows how these layers change altitude and combine, depending on seasonal and time of day parameters.

### The D layer and the lowest usable frequency (LUF)

The D layer is predominant between 55 to about 90 km (34 to 55 miles) and is a daytime event. At night the D layer disappears totally because the sun's radiation is stopped by the earth's shadow at these low altitudes. This layer is not very good at reflecting electromagnetic energy. Because gases are relatively dense at these altitudes, the ions produced in this layer encounter quick recombination processes (a lower number of free electrons) which produce energy losses rather than RF reflections and refractions.

In addition, the reflectance of this layer (if any) tends to be of a high angle because of its low altitude. Signal absorption occurs during the day at the lower HF frequencies. The frequency at which the D layer begins to allow HF waves to continue on to the higher reflective layers is known as the lowest usable frequency (LUF). This frequency varies with the sun's activity and can be shifted so high as to render a total blackout for all HF waves during periods of sunstorms.

### E layer and sporadic E propagation

The E layer extends from about 90 to 125 km (55 to 77 miles). With its lower air density and higher angle of

reflectance, the E layer acts as a better reflector or refractor than the D layer for relatively short paths. Because of its higher altitude, the E layer tends to produce results from some time before sunrise to after sunset, with minimums around midnight. Therefore, the E layer is primarily a daytime layer. Sporadic ionized patches of up to 150 km (93 miles) in diameter sometimes tend to form at the bottom of the E layer (about 100 km or 62 miles), providing powerful reflective and refractive properties for waves up into the very high frequency (VHF) range. It is believed that this phenomenon is caused by the interaction of gaseous winds in the atmosphere with the earth's magnetic field. It is called sporadic E because it only lasts for a few hours and occurs randomly. When present, sporadic E is responsible for spectacular communications at distances of up to 1,000 km (621 miles) for HF and especially VHF frequencies. Sporadic E clouds appear to drift with the upper winds, generally in a westerly direction and at speeds of about 150 km per hour (90 miles/hr). This type of propagation occurs to a greater extent at lower earth latitudes, commonly 20 to 40 degrees. Up to 100 hours of sporadic E propagation has been reported yearly in the United States during the months of May through August.

### F layer, the maximum usable frequency (MUF), and the optimum frequency of transmission (FOT)

The F layer is used for long haul skywave communications. Its altitude is between 150 to 500 km (93 to 310 miles). Consequently, the F layer is almost always exposed to the sun's radiation. It is composed of two well-defined sublayers, F1 and F2. The F1 layer is the lower of the two, and extends from 150 to about 250 km (93 to 155 miles) during the day. The F1 layer behaves much like the E layer; that is, it achieves its maximum ionization at noon and disappears almost completely at night. Its altitude changes seasonally between 350 km (220 miles) during the day in the winter to about 500 km (310 miles) during the summer daylight hours. The nighttime altitudes are between 250 to 420 km (155 to 260 miles). Because of this, skip distance varies with seasons and time of day. Due to its height, the F2 layer is



always present but may be blocked to skywave communication by the absorption of the D and E layers. Efficient reflections and refractions can be obtained from the F2 layer year round.

The F2 layer is partly responsible for determining the optimum frequency of transmission. The art of predicting the FOT at any given time is dictated by complex calculations related to how the F2 layer impacts the maximum usable frequency (MUF) and how that relates to the lowest usable frequency (LUF) determined by the D layer. In practice, the FOT is taken as 85 percent of MUF. The MUF determination is also obtained from complex calculations based on standards set by the Comité Consultatif International des Radiocommunications (CCIR). Some of these standards, along with empirical data and exhaustive calculations, can be found in computer programs which readily predict propagation for the long term. They provide a means of planning radio communication systems and frequency schedules for months in advance while anticipating their variability under both quiet and disturbed conditions. Short term forecasting uses information derived from solar observations for day-to-day management of radio circuits. Long term forecasting takes into account the irregular behavior of the slow arriving particles known as the solar wind, and their variable interaction with the earth's magnetic field in the magnetosphere and the ionosphere. I'll discuss some of these programs in part 3 of this article.

## The grayline and auroral propagation

One of the more interesting propagation modes is the grayline. The grayline is a path created along a 500 km (310 miles) wide area separating day from night, usually called the terminator. Enhanced north-south propagation along this path is possible depending on the earth's diurnal tilt (arc varies up to 47 degrees relative to the poles in one year). The HF spectrum affected by this type of propagation is generally from 2 to 10 MHz. Simple computer programs (which I will not discuss here), that anticipate how this tilted line crosses different areas on earth, can predict with some certainty when and where communication can be established. In grayline propagation, the D and E layers are actively providing strong absorption to the waves being transmitted on the day side of the line. On the nightside these layers are nonexistent, with a MUF which is usually below the frequency of interest. The energy is then channeled up toward the reflecting layers by these two conditions, in much the same way that light would be radiated upward from inside a narrow canyon. The energy is finally reflected back to earth by the F layer on the short or long paths along this grayline. Grayline propagation is useful for HF communications.

Another interesting propagation phenomenon is based on the aurora. During a magnetic storm, the solar wind particles, and particularly the electrons arriving in the ionosphere, become trapped by the earth's magnetic field in the polar regions. Here is how the entire process happens. As the earth spins, its crust moves faster than its core. This is a motor-like mechanism responsible for creating the magnetic field which surrounds the earth. As discussed earlier, the magnetic field around the earth is known as the magnetosphere. The magnetosphere with its well-known Van Allen belts is impacted in turn by the solar wind. The interaction of the solar wind (for example, electrons) with

the magnetosphere turns into electricity. It has been estimated that more than a million megawatts are being generated at any given time, making gases glow in the dark or become fluorescent. If you believe the earlier theory that different gases concentrate at different altitudes, then electrons spiraling down the magnetic lines of the magnetosphere in the oxygen region will glow red or green. At the lower levels, the nitrogen molecules will produce violets and blues. Other gases, like hydrogen (in lesser amounts) will produce oranges, and yet a different kind of red. This is the aurora. HF signals are generally absorbed by the aurora. A strange fading occurs making the signals flutter drastically at a high rate (arctic flutter). It is possible to bounce signals off the aurora curtains with occasional success. A new kind of propagation known as the Auroral E has been used recently at VHF frequencies. This is a mode which is similar to sporadic E, and has been used at frequencies of up to 144 MHz. **JTR**

## REFERENCES

1. Kenneth Davies, "Ionospheric Radio Propagation", National Bureau of Standards Monograph No. 80, April 1, 1965.
2. D.R. Dorsey, "Radio-wave Propagation — A Tutorial", Proceedings of RF Technology Expo 88, Anaheim, California.
3. Lucien Boithias, *Radiowave Propagation*, McGraw-Hill Book Company, 1987.



## HAM BOOKSTORE RADIO

GREENVILLE, NH 03048

(603) 878-1441

FAX (603) 878-1951



Please enclose \$3.75 shipping & handling

### LOW BAND DX'ING COMPUTER PROGRAMS

by John Devoldere, ON4UN

Just about every interest or need is covered—from antenna design and optimization to general operating programs. Antenna programs include: shunt and series input L network design, feedline transformer, shunt network design, SWR calculation, plus 11 more! General Ham programs include: sunrise/sunset, great circle distances, grayline, vertical antenna design program, sunrise calendar plus 9 more! The best value in computer software available today. © 1986.

- UN-Apple IIe/IIc \$39.95 ea.
- UN-MS (MS-DOS) \$39.95 ea.
- UN-CPM/Kaypro \$39.95 ea.
- UN-C-128 (COMMODORE) \$39.95 ea.
- UN-MAC (MACINTOSH) \$49.95

### LOW BAND DX'ING

by John Devoldere, ON4UN

Now Available! The new, 2nd edition of the definitive book on Low Band DX'ing. Based upon years of practical on-the-air experience, learn the secrets of how ON4UN has been so successful on the low bands. Extensive coverage is given to transmit and receive antennas with clear concise explanations and plenty of illustrations—dipoles, inverted V's, slopers, phased arrays and Beverages—they're all in this book. Also covered: propagation, transmitters, receivers, operating, software and an extensive Low Band bibliography. Going to be a best seller! Get yours today. © 1987 2nd Edition. 200 pages. **Softbound \$9.95**

AR-UN

### ON4UN PRACTICAL YAGI DESIGN (MS-DOS)

by John Devoldere, ON4UN

This comprehensive Yagi design program is based upon tested antennas, not theoretical un-proven models. Contains 100 different HF antennas, designed, tested and optimized by ON4UN. Also contains a number of classic designs by noted antenna experts W2PV, W6SAI and others. Includes mechanical design of elements and of the rotating mast. You can also add to the database your own designs. Fully detailed "Read.me" file is designed to help the user get maximum results from the program. © 1989.

- ON-YAGI (MS-DOS) \$59.95

# Ham Radio Bulletin Board

## Dear Readers:

Welcome to the *Ham Radio* Bulletin Board. The "Bulletin Board" is our new forum for sharing some of the more technical correspondence we receive here at HR, additional information on articles we have run, or any other pertinent bits of news. This new feature will appear in the magazine whenever we have messages for you, or you have messages for us. You'll find the "Bulletin Board" interesting, thought provoking, and informative.

**Terry Northup, KA1STC, Editor**

## Enhancing accuracy using insulating spacers

### Hear HR:

I really enjoyed the article in the January 1990 issue of *Ham Radio* on "Copper Pipe Transmission Lines." However, I would like to add a little information that will enhance the accuracy of the results.

The impedance values in **Table 1** or **Equation 1** are based only on air as the dielectric separating the inner and outer conductors. Many times it is necessary to use insulating spacers or beads in conjunction with air in order to maintain the concentric relationship between the conductors. When non-air or non-vacuum insulating material is introduced, this effectively raises the dielectric constant to some value greater than 1 (the value for air) and also effectively lowers the value of the characteristic impedance.

With this in mind, the following general rules should be used when insulating spacers are introduced with air dielectric:

1. Use the thinnest insulator spacer dimensions possible and the smallest number of spacers possible (the total spacer volume must be much less than the total air volume). Use low loss insulating material.
2. Always select a characteristic impedance value from **Table 1** that is slightly larger than the desired characteristic impedance.

**Hilton A. Turner, Jr., KB8LS,  
Kokomo, Indiana**

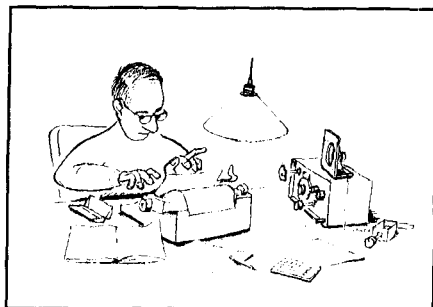

## Being creative at little expense

I found a great and pleasant bit of nostalgia in Charlie Tiemeyer, W3RMD, and his article in the December 1989 issue of *Ham Radio*. The article is on page 42 and is titled "The Five Band Junkbox Transmitter."

Many times during my Ham career I have whipped up a "rig" of this type, but with one addition!

Taking tips from articles in *QST* (Hyde, April 1955, page 51, and McCoy, September 1956, page 22) I always added a simple output indicator. The sketch I've included is self-explanatory (see below). I have built it into the transmitter or separately in a coffee can.

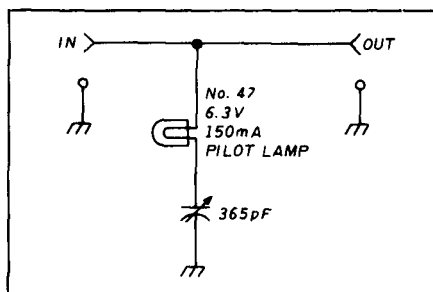

To use, simply set to minimum capacity and tune the transmitter normally. Next, increase the capacity slowly until the lamp barely lights. Then retune the transmitter for maximum brilliance of the lamp. This represents maximum output even though the meter may not agree.

Be my guest to add this device to your readers' fund of knowledge.

Do issue more articles of this nature. The beginners to our craft need to know that a fortune is not necessary to enjoy Ham Radio!

**Gerald R. Skinner, K4LVZ,  
Winter Park, Florida**

## Theory and principle

### Dear HR:

The article in the November issue ("A Low-Noise Design Primer," page 80) by Bob Lombardi, WB4EHS, on the subject of noise was very interesting but I would like to correct an historical reference.

Thermal noise in electrical circuits was discovered by J.B. Johnson in the course of research on telephone lines. The theoretical explanation of the noise (**Equation 1**, et sequence in Lombardi's article) was developed by H. Nyquist. Both Johnson and Nyquist published their work in the journal *Physical Review* in 1927 and 1928.

In physics it is common to refer to the noise, itself, as "Johnson noise" in honor of the discoverer. Nyquist's result is usually called the "Nyquist theorem" because he derived it from fundamental principles, specifically from the Second Law of Thermodynamics and the quantum theory of radiation.

It might interest your readers to know that the importance of Nyquist's result ranges far beyond the direct application of his theorem. His theory was generalized (in the early 1950s) to apply to such diverse phenomena as fluctuations in dielectrics and in magnetic materials, to scattering of electromagnetic radiation and neutron scattering. Even today, the Nyquist theorem and its generalizations are among the few exact theoretical connections between the science of equilibrium thermodynamics and electronic circuits (which never operate at thermal equilibrium).

**Walter A. Simmons, Ph.D, AH6HU,  
Honolulu, Hawaii**

## Article update

Here's an update to the article "Keeping an Eye on Your Sideband PEP," by John Fielden, GW5NAH (SK), that appeared in our September 1989 issue. The original article refers to balancing out op amp offsets but doesn't suggest how it might be done. For those of you not familiar with such techniques, the following method is suggested.

Apply a small DC voltage (about 2 to 4 mV) to the input of the module and

adjust RV3 to get the same voltage at the output. An accuracy of  $\pm 100 \mu V$  is quite sufficient. You can't make this adjustment with a zero input voltage as the output can't swing below about 1 mV. The settings of RV1 and RV2 don't matter for this adjustment, nor is the actual voltage used critical — as long as it doesn't exceed a few mV. Once the offset adjustment is completed, set RV1 and RV2 for the correct sensitivity as described in the article.

Probably the easiest way to get the small voltage needed is to connect the input of the module to the supply voltage via a resistor of 1 meg or so. You can use RV1 and RV2 to get a suitable voltage for the offset adjustment.

**Bob Wilson, WA1TKH,**  
Consulting Technical Editor

### ALL AMATEUR WIRE AND CABLE from the **WIREMAN**

#### CERTIFIED QUALITY

The only wire and cable designed by amateurs for amateurs.

#### featuring:

- CO-4XLIIA ..... The top of the "POOR MAN'S HARDLINE" type, with the most braid and non-contaminating jacket.
- CO-FLEXI 4XL ..... Brand new!!! As above—same super low loss (1.3db/100' @ 2 meters), but now flexible enough for rotors, tip covers, etc. No more jumpers!!!
- CO-213/U ..... An enhanced version of MIL SPEC, with 24 more braid wires, better flex characteristics, MIL SPEC IIA jacket
- CO-8X ..... The old standby mini-8, with silver-gray reflective jacket
- CO-8XIIA ..... As above, plus silky black MIL SPEC IIA non-contaminating jacket
- CO-8XMM ..... New heavy duty mini-8, hi-temp, low corrosion, crush resistant, IIA jacket for marine and mobile use
- CO-COPPERCLAD ..... Designed for antennas (there is a difference) in 18, 16, 14, 13 awg, solid, stranded, multistranded, insulated, etc.
- CO-TWIN LEAD ..... 450, 300, 72 ohm transmission line
- CO-ROTOR ..... 12 Standard and custom rotor cables

Also hard line, guy wire, shielded audio magnet, buns, ground, braid, ground rods, buss bars, connectors, wire antennas, baluns, kits, antenna accessories

Wholesale and retail — any amount — Dealers OK

Catalog \$1 refundable order

**1-800-727-WIRE (9473)**

803-895-4195 (tech help and ragchew)  
803-895-5811 (FAX)

CERTIFIED COMMUNICATIONS ("THE WIREMAN")  
261 Pittman Road, Landrum, SC 29356

✓ 129

### PC SSTV V2.0 \$149.95

Turn your IBM PC or compatible into a complete slow scan TV system. You don't need another computer to send and receive images in up to 64 shades of gray. Works with most popular graphics cards and printers.

#### Includes:

Demodulator Software Modulator Tutorial Cassette 75 Page Manual

#### Requires:

Ham transceiver PC with 640K Parallel Port Graphics Card Tape Recorder Serial port  
Slow Scan Formats: 8, 12, 17, 24, 36, 48, 72 sec.



Software Systems Consulting  
150 Avenida Cabrillo, Suite C  
San Clemente, CA 92672  
(714) 498-5784

## WE SHIP WORLDWIDE

# Barry Electronics Corp.

WORLD WIDE AMATEUR RADIO SINCE 1950  
Your one source for all Radio Equipment!



SEE You April 11th  
METROPLEX (Speech), Ft. Lee, NJ

KITTY SAYS: WE ARE NOW OPEN 7 DAYS A WEEK.  
Saturday & Sunday 10 to 5 P.M.  
Monday-Friday 9 to 6:30 PM Thurs. to 8 PM  
Come to Barry's for the best buys in town.



**DRSI**  
ONV Safety belts-in stock



IC-R71A, 751A, 781, 28H, R-7000, R1, R72, R100  
IC-765, 275AH, 3210A, 475AH, 735, IC-901, IC-228H, IC-25, IC-2400A/2500A

### KENWOOD



TS440S/AT, R-5000, TS-940 S/AT, TM 231A/431A, TM-2570A/50A, TR-751A, Kenwood Service Repair, TM-731A, TS-1181/11A, TH205AT, TH225A, TM-631A, TM-331A, TS140S, TS680S, RZ-1, TS-790A, TS950SD, TH-75A, TH2616A/T

AMPLIFIERS STOCKED:  
HF Concepts  
Mirage  
TE Systems

MARINE RADIOS  
ICOM MS, MS6, M700T, M800  
AVIATION PORTABLE ICOM A-20

Budwig ANT. Products IC-32AT

NEL-TECH DVK-100 Digital Voice Keyer  
FLUKE 77, 83, 85, 87 Multimeters

### Panasonic

VoCom/Mirage/Alinco  
Tokyo Hy-Power/TE SYSTEMS  
Amplifiers & 58 HT Gain  
Antennas IN STOCK

G&G ELECTRONICS ART1,  
Air Disk, SWL, Morse Coach

Professional Soldering Station 48 Watts \$79

METRON KW HF Mobile Amplifier Stocked

Alpha Delta Products Stocked

EIMAC 3-500Z 572B, 6JS6C 12B7A & 6146B

AEA 144 MHz

AEA 220 MHz

AEA 440 MHz

ANTENNAS

BIRD Wattmeters Elements In Stock

AR 900 Hand Held Scanner 100 ch. Covers 27-54, 108-174, 406-512, 800-950 Mhz

Computer Interfaces Stocked: MFJ-1270B, MFJ-1274, MFJ-1224, AEA PK-88, MFJ-1278T, PK-232 MB, WIFAX, DRSI PRODUCTS

MOTOROLA AUTHORIZED DEALER KACHINA COMMUNICATIONS DEALER

AUTHORIZED SONY DEALER

DIGITAL FREQUENCY COUNTERS OPTOELECTRONICS model 1300 H/A, 0-1300MHz 2210 H, 0-2200 MHz

Long-range Wireless Telephone for export in stock

BENCHER PADDLES BALUNS, LOW PASS FILTERS IN STOCK

MIRAGE AMPLIFIERS ASTRON POWER SUPPLIES Belden Wire & Cable, Int'l Wire OPTO KEYS STOCKED

New TEN-TEC Corsair II, PARAGON, OMNI V

IX Towers, Antennas, Mobile Radio mounts stocked, Call

AMERITRON AUTHORIZED DEALER

MAIL ALL ORDERS TO: BARRY ELECTRONICS CORP., 512 BROADWAY, NEW YORK CITY, NY 10012 (FOUR BLOCKS NORTH OF CANAL ST.)

### New York City's LARGEST STOCKING HAM DEALER COMPLETE REPAIR LAB ON PREMISES

#### "Aqui Se Habla Espanol"

BARRY INTERNATIONAL TELEX 12-7670

MERCHANDISE TAKEN ON CONSIGNMENT

FOR TOP PRICES

Monday-Friday 9 A.M. to 6:30 P.M. Thursday to 8 P.M.

Saturday & Sunday 10 A.M. to 5 P.M. (Free Parking)

IRT/LEX: "Spring St. Station" Subways: BMT- "Prince St. Station", IND: "F" Train-Bwy Station

Bus: Broadway #6 to Spring St. Path-9th St. 6th Ave. Station.

#### COMMERCIAL RADIOS STOCKED: ICOM, Motorola, MAXON, Standard, Yaesu

We serve municipalities, businesses, Civil Defense, etc. Portables, mobiles, bases, repeaters.

ALL SALES FINAL

We Stock: AEA, ARRL, Alinco, Ameco, Ameritron, Antenna Specialists, Astatic, Astron, BAK, BAW, Bencher, Bird, Butternut, CDE, CES, Cushcraft, Daiwa, Eimac, Henry, Heil, Husler, Hy-Gain, Icom, KLM, Kantronics, Larsen, MJF, J.W. Miller, Mirage, Nye, Palomar, RF Products, Saxton, Shure, Tempo, Ten-Tec, TUBES, Yaesu, Vibroplex, Duplexers, Repeater, Scanners, Radio Publications, Under, Kenwood, Maxon, RFC.

WE NOW STOCK COMMERCIAL COMMUNICATIONS SYSTEMS

HAM DEALER INQUIRES INVITED PHONE IN YOUR ORDER & BE REIMBURSED

COMMERCIAL RADIOS stocked & serviced on premises.

Amateur Radio Courses Given On Our Premises, Call

Export Orders Shipped Immediately. TELEX 12-7670

FAX: 212-925-7001

### U.S. AMATEUR RADIO MAIL LISTS

Labels, floppy disks, CD-ROM, mag tape.

- Newly licensed hams
- All upgrades
- Updated each week

#### BUCKMASTER PUBLISHING

Route 3, Box 56

Mineral, Virginia 23117

703/894-5777 visa/mc 800/282-5628

✓ 131

## THE 450TRON

COMPACT ANTENNAS FROM 160-10 METERS

**NO TUNERS!  
NO RADIALS!  
NO RESISTORS!  
NO COMPROMISE!**

**FOUR EXCELLENT REVIEWS JUST DON'T HAPPEN BY CHANCE.  
CALL US FOR A FREE CATALOGUE.**

\*See review in Oct. 73, 1984 \*Sept. 73, 1985  
\*March 73, 1986 \*Dec. 88, CQ

**BILAL COMPANY**  
137 Manchester Dr.  
Florissant, Colo. 80816  
(719) 687-0650

✓ 132

# Ham Radio Techniques

Bill Orr, W6SAI

## THE YAGI OPTIMIZER

The year was 1946. There was plenty of exotic DX on the 20-meter band: AC4YN, XZ2KN, W6VKV/I6, ET1JJ, AC3SS, YI5AL, and lots more. The problem was to work it. And more often than not, I was beaten out in a DX pileup by my good friend and aggressive competitor Paul, W6MJB, a local DXer with a keen sense for the jugular.

"The reason he beats you out is that he has a four-element beam and you only have a three-element beam," observed W6VFR.

"The reason I beat you out is that I'm a better operator than you," said W6MJB with an engaging smile.

Very frustrating. Oh! Paul had put the hex on me for sure. Did he have a better antenna? Was he a more experienced DX chaser than I? Or both? I never resolved that problem.

But that was part of the fun. When, on a rare occasion, I did manage to snooker W6MJB, it really made me feel good. Maybe my antenna was as effective as his, after all!

Much has happened since those good old days, and a lot of the Black Magic once invoked in designing and building beam antennas has now become a science. Here's a case in point. A few weeks ago I was looking through a dusty old log book and found the dimensions and data for W6MJB's mighty four-element DX antenna. I entered the pertinent information in my modern computer and compared the results with similar data about the old three-element beam I used when chasing Paul around the 20-meter band. The results? Both beams performed about the same as far as gain and front-to-back ratio were concerned! There was no discernible difference in overall performance between the two antennas. Maybe Paul was right — he was a better operator than I was!

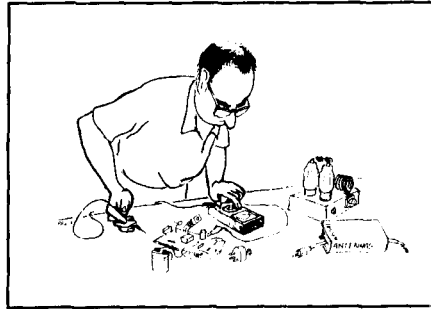

### The Yagi Optimizer (YO)

Is a four-element beam a better performer than a three-element beam? What is the optimum boom length for a given number of elements? What is the effect of element taper? Is it better to lengthen the boom when adding an extra element, or to drop an extra element into an existing array in order to achieve a little more gain? What is the relationship between gain and front-to-back ratio? Is it necessary to sacrifice one to enhance the other? Do maximum gain and highest front-to-back ratio occur at the same frequency? These are good questions, ones that can finally be answered with the Yagi Optimizer program for the home computer.

The Yagi Optimizer Program\* developed by Brian Beezley, K6STI, requires an IBM PC compatible computer with at least 512K of memory. You need a CGA, EGA, or HGC display. A math coprocessor is recommended, as is a hard disk, but neither is required. You should use DOS 3.00 or later to enable full access to all features of the YO program.

YO analyzes and optimizes a given Yagi antenna. It will model arrays of up to 50 elements. The model is examined in free space and the accuracy (compared with the MN program discussed last month) is typically within 0.1 dB for forward gain, a few dB for front-to-back, and within a couple of ohms for input impedance.

Optimization may be done at a spot frequency within a band, or at the low,

middle, and high frequencies of the band of interest. You may choose the parameters, aiming for maximum gain, best front-to-back ratio, a given value of input impedance, or a combination of these parameters.

### Is there a maximum gain Yagi?

Before discussing program details, it's interesting to contemplate the possibility of achieving a maximum gain Yagi. A popular question among HF and VHF operators is: How much gain can be achieved for a given number of elements or a given boom length? YO will give interesting answers to such questions.

Yes, Virginia, there is a maximum gain Yagi. YO will find it for you by crunching through variations in element length and spacing that would be impossible to compute a decade ago. For example, I entered typical dimensions for a 24-MHz three-element Yagi built on a 12-foot boom into the computer. Starting with these basics, the program was directed to search for a maximum gain Yagi that retained a good front-to-back ratio while maintaining the same boom length. The results are shown in **Figure 1**. The program examined 184 length/spacing combinations to arrive at the optimized design. The array has 6.04-dBd gain at the design frequency of 24.95 MHz, and a front-to-back ratio of over 28 dB. Input impedance is about 22 ohms.

This is a good compromise design. Can the gain be increased by holding the boom length constant, but allowing element length and spacing to be varied? Yes. Setting YO in action again, I found that the program quickly examined 262 designs in sequence and arrived at the maximum gain design shown in **Figure 2**. This Yagi provides 7.82-dBd gain with a front-to-back ratio of only 7.55 dB. Input impedance is about 1.7 ohms. And look at the spacing!

A beam of this design is a theoretical concept. The radiation resistance is so low that substantial ohmic losses exist

\* Brian Beezley, K6STI, 507-1/2 Taylor, Vista, California 92084.

FIGURE 1

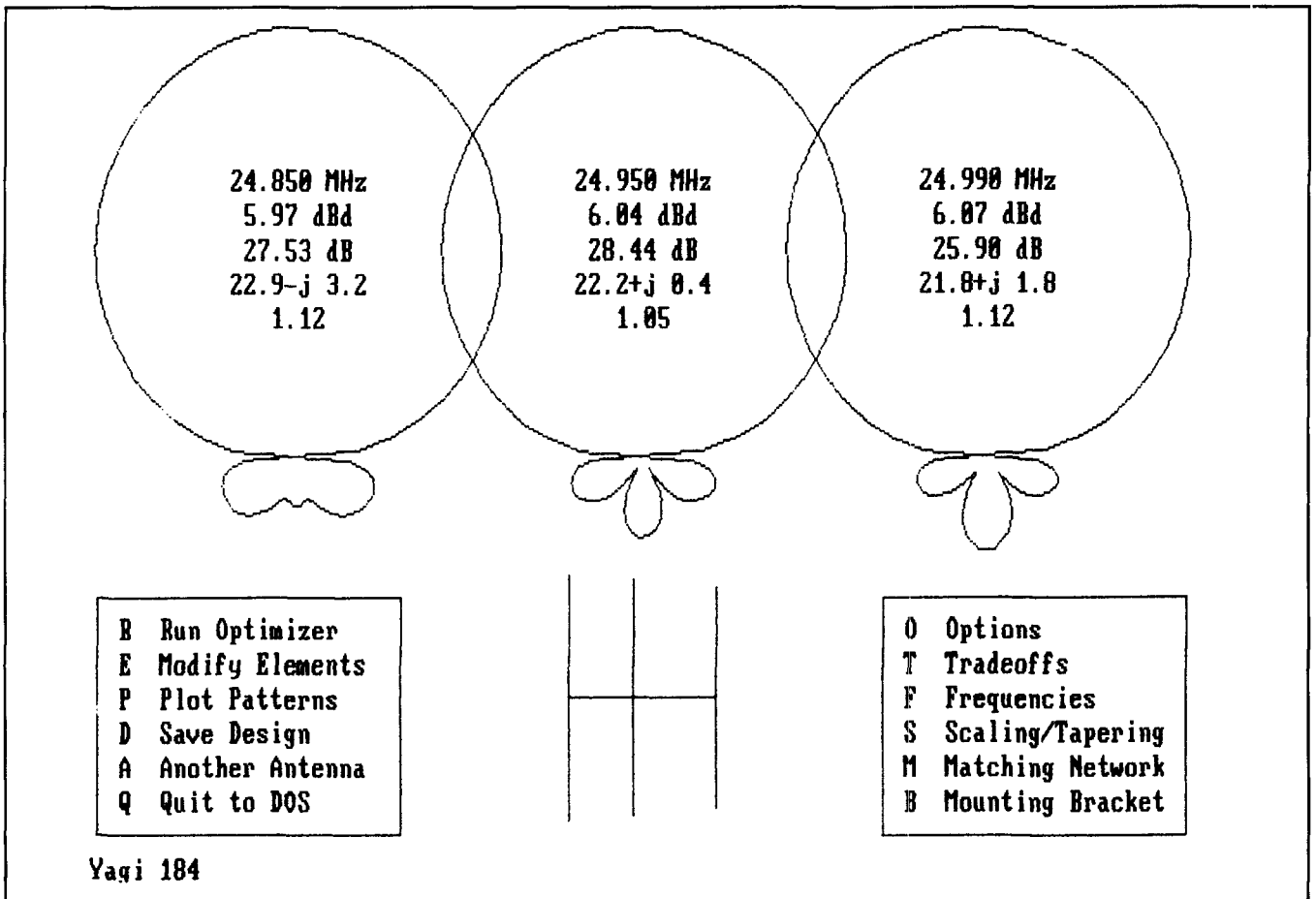

24-MHz Yagi optimized for good combination of gain and front-to-back ratio. The figures in the patterns indicate frequency, gain, front-to-back ratio, input impedance, and SWR. Beam is optimized at three frequencies. Below the patterns you see a representation of the Yagi. Monotaper dimensions are (length and position in inches): reflector, 118.25/-72.96; driven element, 112.75/-9.23; director, 105.8/72.96. Boom length is 12 feet 2 inches.

in the array, and it's difficult to design a network that would match the low impedance load to a coax line. The real life gain of such an oddball design is questionable. Front-to-back ratio is poor and wind vibration would upset antenna parameters unless the driven element and reflector were suitably braced.

What's the upshot of this optimization? The design has gained 1.78 dB at the loss of nearly 21 dB of front-to-back ratio. At the same time, the feedpoint impedance has become impossibly low. Exotic results, but the beam is impractical. Optimization has been carried to an extreme.

### Practical results with the YO program

Running the YO program quickly shows the folly of being too eager to achieve forward gain at the expense of other important antenna parameters.

The YO program emphasizes that maximizing forward gain results in poor front-to-back ratio, low input impedance, possible sidelobes, and small SWR bandwidth. But because of the tradeoff capability, the program lets you automatically optimize a combination of gain, front-to-back, and either input impedance or SWR. The combination of parameters to be optimized and their relative importance are determined with a Tradeoff Menu.

### The Tradeoff Menu

In most cases, maximizing forward gain at the expense of other parameters isn't practical. To obtain a good combination of parameters, set a ratio of forward gain to front-to-back of 9:1. This means that YO will weigh front-to-back by 10 percent and forward gain by 90 percent. (Other ratios may be chosen at your discretion.) This ratio, however, places 1 dB of gain

equal to 9 dB of front-to-back ratio. If YO can change the design in such a way that the front-to-back ratio increases more than 9 times as much as the forward gain decreases, it will do so.

Experience has shown that this ratio yields a very practical design. Once this optimization has been completed, you can then optimize the design for input impedance and bandwidth tradeoffs. Your strategy is to obtain the most uniform antenna performance across the band. Obviously, the final design depends considerably on the width of the Amateur band; a 10-meter optimized design is quite different from a design optimized for the narrow 12-meter band.

### The optimization method

The Yagi Optimizer uses a modified "Method of Steepest Descent." Readers with a calculus background



should recognize the technique immediately. Parameters of each element are changed by a small amount, while other antenna dimensions are held unchanged. The program calculates the sensitivity of the objective to each variable. The collection of the element sensitivities leads to an iteration where all the variables are updated, each in proportion to its respective sensitivity. The process is repetitive, and terminates either at user command or when no further improvement in the objective is possible.

This technique doesn't guarantee the very best set of antenna dimensions out of all possible dimensions. That nirvana can be accomplished only by an exhaustive and impractical search over all possible dimensions. The definition of "best" is user defined. As an analogy, imagine that you're climbing to the very top of a mountain range of multiple peaks, in a dense fog. You might arrive at a peak, but it might not be the highest one. Familiarization with the program and examination of various antennas in the program library will quickly guide you into a comfortable relationship with program tradeoffs. The program lets you change element lengths and positions by keyboard entry. This is a great way to get the "feel" for how each element affects the overall antenna performance. Common sense is a great help in Yagi optimization.

## YO matching networks and other stuff

YO contains models for several matching systems including the Gamma Match, the T-match, the "Hairpin" Match, and the Beta Match. The program allows you to determine the effects of element taper and mounting brackets. It's also possible to quickly scale any Yagi design to a new frequency, while maintaining essentially

the same performance characteristics. Finally, the program provides pattern plots which may be printed using a dot matrix printer with Epson compatible graphics. There are other interesting "bells and whistles" in this program, but I won't cover them here.

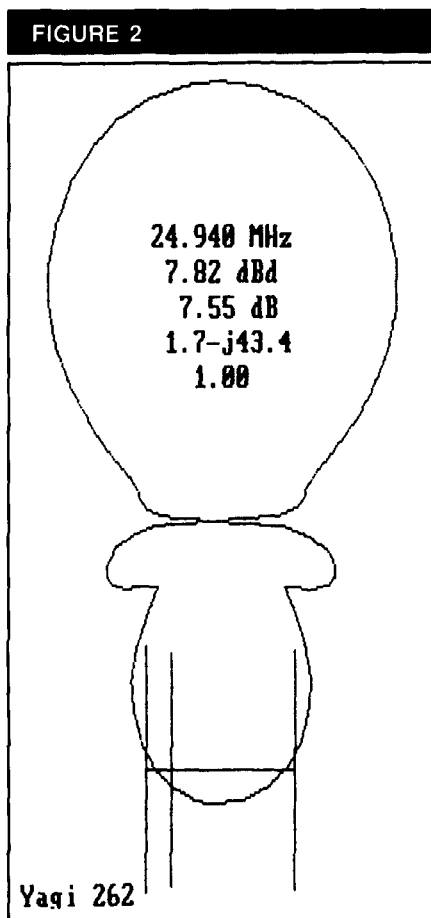

Same Yagi as in Figure 1 optimized for maximum gain without regard to front-to-back ratio. Beam is optimized at only one frequency. Monotaper dimensions are (length and position in inches): reflector, 115.251/0; driven element, 108.008/23.663; director, 111.006/142. Boom length is 11 feet 10 inches.

## The YO file format

The initial antenna configuration must be entered in a Yagi file in a specific format. The elements are specified in order, beginning with the reflector (see Table 1). One-half of each element, from the center of the boom to the element tip, is normally required. For monotaper elements, you may use the whole element length.

You place a title for the antenna on the first line. One or three analysis frequencies go on the second line. The program assumes you are using megahertz if you don't specify frequency units. On the third line enter the number of elements and the dimension units. In this example, inches are used.

The next line asks that you list the taper diameters, starting with those closest to the boom. The maximum number of taper sections you can use is seven. The first taper section in this example represents the element mounting plates.

On the remaining lines, list the element positions followed by the length of the taper sections, beginning with the section closest to the boom. (As an alternative, you may use element spacings instead.)

It's possible to accommodate different taper schedules for different elements. Various examples are given in the documentation that accompanies the program.

*It's important to note that if you start out with a poor Yagi and optimize it, you'll get an optimized, poor Yagi. A modicum of common sense is vital in running a program of this type.*

Used together, the MN and YO programs let you design and fine tune a Yagi array. You'll end up with a design that can be built, placed in final position, and used with a minimum amount of top-of-the-tower adjustment. I like that. As I've said before, I'm a coward when my feet are off the ground.

## A final word

Here are some notes of caution. These antenna analysis programs and other programs of this type require that you have a good working knowledge of MS-DOS or PC-DOS. The programs aren't tutorials for running the complex data operating systems used by the IBM-type computers. Most of my early cockpit problems with antenna programs were due to poor insight into DOS management. Once I overcame

**TABLE 1**

YO format for 4-element beam.					
K7HYR's maximum gain Yagi					
	24.890	24.940	24.990	MHz	
4 elements, inches					
	1.617	1.250	1.125	0.875	
0.000	2.938	15.062	66.000	33.305	
124.000	2.938	15.062	66.000	28.248	
248.000	2.938	15.062	66.000	26.815	
372.000	2.938	15.062	66.000	28.313	

this hurdle, it was smooth sailing from then on. I'd also like to note that IBM clones are equal, but some are more equal than others. You may find occasional pitfalls when using a particular clone with an idiosyncrasy that doesn't quite match the IBM machine the author used to prepare the program. Luckily, these "glitches" can be worked out as time goes by. In my case, a suggested print command on a different antenna program refused to provide a readable copy. A friend who is a knowledgeable computer programmer provided me with the solution in a few moments.

I believe that antenna modeling is a powerful tool for Amateur Radio. From time to time I hope this column can offer antenna designs that have been refined by computer analysis for the best possible operating characteristics. Antenna analysis is here to stay, but don't throw away that SWR meter just yet! **lp**

**NEW OSCAR**

**BRIDGES HAMISPHERE**

- Coming soon to a shack near you.
- Signals from space.
- Catch some free.
- We know how.
- You can too!
- Join AMSAT
- Free brochure for SASE

**AMSAT**  
PO BOX 27  
WASHINGTON, DC 20044

## YAGI OPTIMIZER

The YO program automatically optimizes Yagi dimensions for maximum forward gain, best pattern, and minimum SWR. YO updates radiation patterns at the central design frequency and band edges during optimization. A scale drawing of the Yagi changes shape as the design proceeds. YO is extremely fast, and can compute several trial designs per second. After optimization, high-resolution patterns may be displayed or printed in several formats. YO includes a powerful gain-F/B-SWR trade-off mechanism, minimization of all sidelobes, frequency scaling, and full EGA color. YO has models for gamma, T, hairpin, and beta matches, element tapering, and element mounting plates. A library of Yagi designs and extensive documentation are included. YO is intuitive, graphical, and highly interactive.

YO 3.0 features improved accuracy, faster computation, optimization of single Yagis over ground, and stacked Yagis in free space. YO 3.0 is 2-4 times more accurate and 20-65% faster than YO 2.0. Optimize a Yagi at its exact installation height for improved F/B and SWR. Optimize take-off angle. Account for antenna interaction by optimizing an identical pair of stacked Yagis for maximum gain and low sidelobes.

YO 3.0 is \$130. YOjr 1.0 (basic features) is \$65. Add 6-1/4% for California orders, \$5 for overseas. For IBM PC.

Send check or international money order to:  
Brian Beezley, K6STI, 507-1/2 Taylor, Vista, CA 92084

NEW!

The classic "Antenna Bible"  
now in a thoroughly-revised, much-enlarged  
edition

## ANTENNAS

2nd edition

by John Kraus, W8JK  
Ohio State University

Covers both theory and its applications to practical systems. With design formulas, tables and references. Over 1000 illustrations.

"Modern, complete, a classic", *Microwave Journal*.

917 pages, hardcover. \$51.95

Add \$2.50 per book for shipping and handling U.S., \$5.00 elsewhere.

CYGNUS-QUASAR BOOKS  
P.O. Box 85, Powell, Ohio 43065  
Tel. 614-548-7895

**TOWERS** • TELESCOPING CRANK-UP  
• GUYED STACK-UP  
by ALUMA • TILT-OVERS

Easy to install. Low Prices. Crank-ups to 100 feet.

Over 36 types aluminum towers made—specials designed and manufactured—write for details.

EXCELLENT FOR AMATEUR COMMUNICATIONS

Mobile Truck Type

Roof Top Aluminum Type

Mobile Trailer Type

SPECIAL Four Section 50 Ft. Van Mounted Crank-Up Aluma Tower

**ALUMA TOWER CO.**  
BOX 2806HR  
VERO BEACH, FL 32961-2806  
(407) 567-3423 FAX 407-567-3432

## NEW FOR THE 1990'S! TWO METER ANTENNAS AND MORE . . .

MODEL RA8-2UWB\*

**NEW**

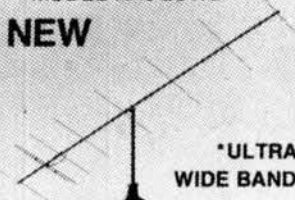

\*ULTRA  
WIDE BAND

The perfect mate for your  
all mode transceiver!  
Gain: 11.1dBd  
Bandwidth: ► 4MHz  
VSWR: ◀ 1.5:1 144 to  
148 MHz  
F/B Ratio: 22 dB  
Length: 11ft. 9in.  
Maximum Power: 400 Watts

The Ultimate in Performance

Gain: 13.7 dBd  
Beamwidth: 31 DEG.  
VSWR: ◀ 1.13:1  
F/B Ratio: 21 dB  
Length: 24ft. 8in.  
Wind Survival: 90+ MPH  
Maximum Power: 2000 Watts

MODEL FO15-144

**NEW**

Design by K1FO

See our products on display at  
**THE DAYTON HAMVENTION FLEA MARKET**  
or  
Send for our **NEW CATALOG**

# RUTLAND ARRAYS

1703 WARREN ST., NEW CUMBERLAND, PA 17070  
(717) 774-5298 • 7 - 10 PM EST

"WE DESIGN AND BUILD OUR ANTENNAS  
FOR PERFORMANCE NOT PRICE"

✓ 125

## FROM BEVERAGES THROUGH OSCAR

A bibliography 1909 to 1988

\*52,880 references in 92 chapters!

The only complete reference guide to Amateur articles in the world! Revised and up-dated from the softbound edition, this microfiche reference lists 80 years worth of information from 297 different sources that include QST (since 1945), the RSGB's magazine RADCOM (since 1979) and all issues of **HAM RADIO**, **CQ**, and **73**. Includes 5,000 key-word index and author and callsign cross references. Unbelievable value. Worth much more than is being charged!

FBTO-microfiche

**\$49.95**

Please enclose \$3.75 shipping & handling



**HAM  
RADIO**

GREENVILLE, NH 03048

(603) 878-1441  
FAX (603) 878-1951

# SUBSCRIBE

—AND RENEW—

## TOLL-FREE



# HAM RADIO

1 YR - \$22.95 2YRS - \$38.95

3 YRS - \$49.95

Prices U.S. only



MASTERCARD

BILL ME

VISA

Please have your charge card ready

DATATEL 800™

# 800-341-1522

Weekdays 8 AM - 9 PM EST • Saturdays 9 AM - 5 PM EST  
IN MAINE CALL COLLECT (207) 236-2896

**OUR 800 NUMBER IS FOR SUBSCRIPTION ORDERS ONLY!**

For Errors or Change of Address CALL *ham radio*  
direct at (603) 878-1441 8-5 EST

# THE SUPER-DISCHARGER

## A simpler, easier to build test load for your NiCds

By W.C. Cloninger, Jr., K3OF, 4409 Buckthorn Court, Rockville, Maryland 20853

In a previous article<sup>1</sup> I discussed testing NiCds (nickel cadmium batteries) to determine their useful capacity. The process consists of charging the NiCds fully and then discharging them into a load at the mAh-times-1 rate. The multipurpose resistive load described<sup>1</sup> works well but requires close attention and several adjustments to maintain a reasonably constant load. Several full charge, full discharge cycles (1.0 volt per cell nominal minimum discharge voltage) can substantially improve the capacity of many NiCds.

During many NiCd discharge cycles, I've often wished that I had a constant current load that didn't vary with decreasing voltage. As a first attempt at a constant current load, I short circuited an existing current-limited power supply that uses a 723 regulator. It showed promise, but the input voltage versus load wasn't nearly as flat as I had hoped. This was probably due to the IC and the number of associated components. Then I discovered that it was best to keep things uncomplicated.

### Enter the Superdischarger

The circuit is simple, infinitely variable within its design range, smaller than the resistive load, doesn't require the special large resistor used in my earlier project,<sup>1</sup> and has a reasonably flat input voltage versus current load. The Superdischarger is shown in **Photo A**. It was specifically designed to discharge AA NiCds at 500 mA and sub-C, C, and D cells at 1.2 A (1200 mA). The load range of the Superdischarger extends from about 480 mA to just over 1.5 A.

### Theory of operation

The Superdischarger is a current-limited power supply with an output load that will cause current limiting. A dead short of the output is the easiest "load" I could think of.

First, here's a quick lesson in one method of power supply regulation.<sup>2</sup> **Figure 1** shows a basic zener-regulated

PHOTO A

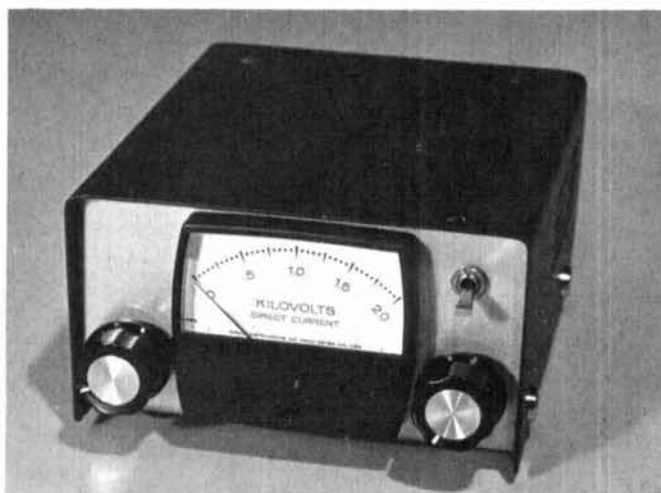

The Superdischarger. The meter really indicates 0 to 2 A (but the price was right!). The two knobs are for coarse and fine-load adjustment.

FIGURE 1

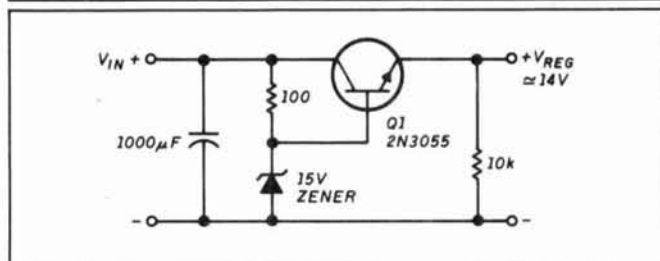

A basic zener-regulated power-supply circuit. It is not good for current loads over about 2 A.

power supply circuit using a single pass transistor. The maximum current output of this circuit is a couple of amperes, due to component losses and the gain factor of Q1. **Figure 2** is the same basic design; however, it uses a Darlington pair for the pass transistor. This circuit is good for maybe 5 A, but neither of these circuits has current limiting. I have seen both of these circuits used in commercial power supplies,

usually less expensive ones.

**Figure 3** shows how current limiting is added to either power supply circuit. When the voltage drop across  $R_{sc}$  reaches about 0.65 volt, Q3 begins to conduct and removes current from the base of Q2, reducing the output to a fixed level. This is the method of current limiting used in the Superdischarger.

These circuits have been published many times and are suitable for some voltage regulation applications. Better power supply circuits may use the LM723 voltage regulator<sup>3</sup> (Astron, Drake P7, and others). Don't forget the "three-legged" fixed or variable regulators if they suit your needs.

### Back to the Superdischarger

Because I needed only current limiting, I didn't use the zener diode. I now have an unregulated but current-limited "power supply" (see **Figure 4**). As the input voltage will vary with the voltage of the NiCd battery pack tested, voltage regulation isn't desired. My final design uses the Darlington pair because it will provide a 500-mA load down to 2.0 volts (2 AA cells). It won't maintain a 1.2-A load at 2.0 volts. You can use a single pass transistor, but the minimum voltage for a useful load is closer to 4 volts. There is one possible "advantage" to the single pass transistor version. You can

**FIGURE 2**

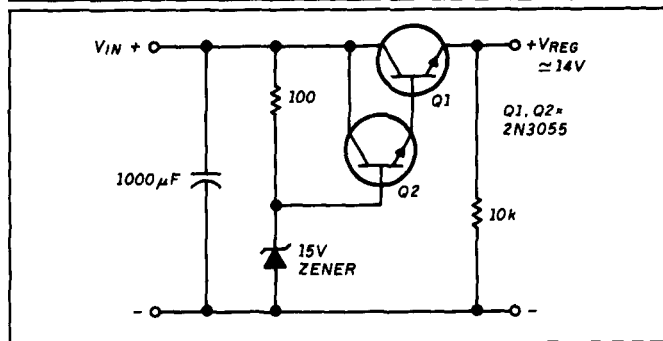

An improved zener-regulated circuit using a Darlington pair, which improves usable current output to about 5 A.

**FIGURE 3**

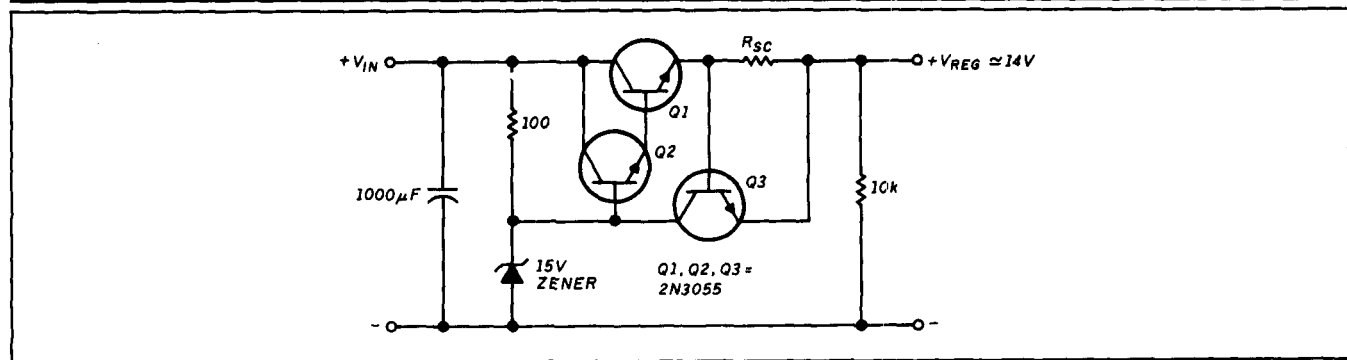

Current limiting is added to the power supply circuit with  $R_{sc}$  and Q3. All transistors are 2N3055, but only Q1 requires a heat sink.

**FIGURE 4**

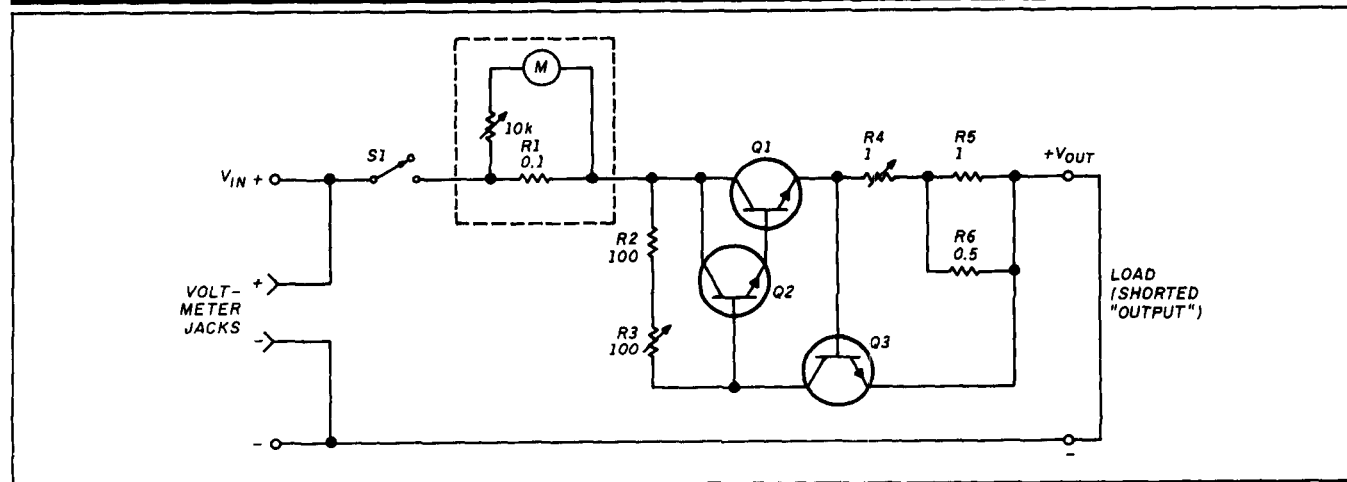

The Superdischarger circuit will provide a 500-mA to 1.5-A load over a range of 3 to 15 volts. Potentiometer R3 is optional, but permits fine load adjustment. A 0 to 2 A meter would eliminate the meter network (0.1-ohm and 10-k resistors) and the 200- $\mu$ A meter. S1 turns the load on and off.



# ★ ALL NEW KITS ★

## 2 MTR & 220 BOOSTER AMP

Here's a great booster for any 2 meter or 220 MHz hand-held unit. These power boosters deliver over 30 watts of output allowing you to hit the repeaters full of quieting while low noise preamp remarkably improves reception. Ramsey Electronics has sold thousands of 2 mtr amp kits but now, we offer completely wired and tested 2 mtr as well 220 MHz units. Both have all the features of the high priced boosters at a fraction of the cost.

- PA-10 2 MTR POWER BOOSTER (10 X power gain)  
Fully wired & tested • \$69.95  
PA-20 220 MHz POWER BOOSTER (8 X power gain)  
Fully wired & tested • \$69.95



- 30 WATTS OUTPUT
- LOW NOISE PREAMP
- LOW COST
- RUGGED CAST ALUMINUM CASE
- ONE YEAR WARRANTY



## PERSONAL SPEED RADAR

Complete kit \$G.7  
**\$89.95**

New low cost microwave doppler radar kit (clocks cars, planes, boats, horses, bikes, baseballs, models, runners or diode tuned. 50 mi audio output. Runs on 9VDC, has RF gain control. This kit is very easy to build. Lots of fun and educational—ideal for the beginner or the pro. The optional matching Case kit features a rugged ABS plastic case with screened graphics. Includes all machined aluminum knobs for a well finished professional look.

## RADIOS

### 20, 40 & 80 METERS HAM RECEIVERS

Sensitive all mode AM CW SSB receivers for 3.5-4.0 or 70-75 MHz. Direct conversion design using NE602 IC as featured on GGT and ARRL handbooks. Less than 1 uV sensitivity. varactor diode tuned. 50 mW audio output. Runs on 9VDC, has RF gain control. This kit is very easy to build. Lots of fun and educational—ideal for the beginner or the pro. The optional matching Case kit features a rugged ABS plastic case with screened graphics. Includes all machined aluminum knobs for a well finished professional look.

- |                             |         |                             |         |                             |         |             |         |
|-----------------------------|---------|-----------------------------|---------|-----------------------------|---------|-------------|---------|
| 20 MTR<br>RECV KIT<br>HR-20 | \$24.95 | 40 MTR<br>RECV KIT<br>HR-40 | \$24.95 | 80 MTR<br>RECV KIT<br>HR-80 | \$24.95 | Case<br>CHR | \$12.95 |
|-----------------------------|---------|-----------------------------|---------|-----------------------------|---------|-------------|---------|

### QRP TRANSMITTER KITS, 20, 40 & 80 METERS

Operate a mini ham shack. These little CW rigs are ideal mates to our 40 and 80 meter receivers. Features include smooth variable tuning, in-wall output and excellent keying characteristics. Runs on 12 VDC and is VOX protected. See how far you can stretch your signal with one of these mini rigs. Optional ABS cases are available.

- |                            |         |                            |         |                            |         |             |         |
|----------------------------|---------|----------------------------|---------|----------------------------|---------|-------------|---------|
| 20 MTR<br>QRP KIT<br>QR-20 | \$29.95 | 40 MTR<br>QRP KIT<br>QR-40 | \$29.95 | 80 MTR<br>QRP KIT<br>QR-80 | \$29.95 | Case<br>CHR | \$12.95 |
|----------------------------|---------|----------------------------|---------|----------------------------|---------|-------------|---------|

### AIRCRAFT RECEIVER KIT

Hint: exciting aircraft communications—picks up planes up to 100 miles away. Receives 110-136 MHz AM air band. varactor tuned superhet design with AGC, ceramic filter and adjustable touchtone. Runs on 9V battery. 50 mW audio output. Low sensitivity. Optional matching ABS plastic case lets you take it anywhere. Features screened graphics and machined aluminum knobs for a real professional look. Compact—great for aircraft or for just plain hanging around the airport.

- |                        |         |                             |         |
|------------------------|---------|-----------------------------|---------|
| Complete<br>KIT: AIR-1 | \$24.95 | Receiver Case<br>KIT: CAS-1 | \$12.95 |
|------------------------|---------|-----------------------------|---------|

### SHORTWAVE RECEIVER KIT

A fantastic receiver that captures the world with just a 12" antenna! Receives 1.4-11 MHz on 2 MHz bands. varactor tuned superhet design with AGC, RF gain control, and 50 mW audio output. Uses new Spectra mixer chip for less than a microvolt sensitivity. runs on 9V battery. This is a fascinating scout, school or club project, and will provide hours of fun to the most serious DX'er. Add the optional case kit and you have a real nice looking shortwave set!

- |                       |         |                             |         |
|-----------------------|---------|-----------------------------|---------|
| Complete<br>KIT: SW-1 | \$24.95 | Receiver Case<br>KIT: CSR-1 | \$12.95 |
|-----------------------|---------|-----------------------------|---------|

### PACKET RADIO

Commodore 64/128 packet radio interface. Uses famous German Digicom software. Features EXARC chip set for reliable operation. runs HF or VHF tones. Includes FREE disk software. PC board. all necessary parts and full documentation. Complete kit: PC-1 \$49.95

### FM COMMUNICATIONS/ 2 MTR, 10 MTR & 220 RECEIVERS

- Sensitive superhet FM receiver tunes any 5 MHz segment of band. Listen to ham operations, high band police calls, weather or mobile phone calls. Easy to build receiver features varactor tuning, IC mixer stage, ceramic IF filters and dual conversion design with adjustable squelch. Less than 1 uV sensitivity, runs on 9 V battery, with 50 mW audio output. Optional ABS case with screened graphics and machined aluminum knobs provide a nice professional look.
- |                      |         |                        |         |                         |         |                         |         |
|----------------------|---------|------------------------|---------|-------------------------|---------|-------------------------|---------|
| 2 MTR<br>KIT<br>FR-7 | \$29.95 | 10 MTR<br>KIT<br>FR-10 | \$29.95 | 220 MHz<br>KIT<br>FR-20 | \$29.95 | Receiver<br>KIT<br>CR-7 | \$12.95 |
|----------------------|---------|------------------------|---------|-------------------------|---------|-------------------------|---------|

## NEW MINIKITS—NEW MINIKITS

### BROADBAND PREAMP

A sensitive all purpose preamp ideal for scanners, TV sets, VHF UHF rigs, counters, etc. Features low noise 4 db NF. 20 db gain. 100 - 10KHz - 1 GHz operation. Runs on 9-12 VDC. 50 mW audio output.

- |                       |         |
|-----------------------|---------|
| Complete<br>KIT: SA-7 | \$14.95 |
|-----------------------|---------|

### LIGHT BEAM COMMUNICATORS

Transmits modulated infrared light up to 30 feet without lenses up to 1/4 mile using mirrors. Uses 30 kHz carrier for hum free operation. Transmits thru windows, etc. Ideal for "bugs" or listening to RI remote controls. Transmitter has sensitive microphone receiver. Uses PIN detector and drives speaker or output. Units operate on 9-12 VDC.

- |                         |        |
|-------------------------|--------|
| Transmitter kit<br>LB-T | \$8.95 |
| Receiver kit<br>LB-R    | \$9.95 |

### HIGH POWER FM WIRELESS MIKE

A high power unit that will transmit up to 1/2 mile to any FM broadcast radio. Sensitive input accepts any type of mike. will pick up normal voices. 10 feet away using the available minicrystal. mike cartridge. Operates on 9-12 VDC.

- |                                   |         |
|-----------------------------------|---------|
| FM 4 kit                          | \$12.95 |
| Sensitive microphone<br>Cartridge | \$2.95  |

# RAMSEY ELECTRONICS

Quality Test Gear & Electronic Kits for Professionals and Hobbyists



### PR-2 COUNTER PREAMP

The PR-2 is ideal for measuring weak signals from 10 to 1,000 MHz • flat 20 db gain • BNC connectors • great for softening RF • ideal receiver/TV preamp • 3 db NF

- |                |
|----------------|
| <b>\$49.95</b> |
|----------------|
- wired includes AC adapter  
PR-2 kit \$39.95



### PS-2 AUDIO MULTIPLIER

The PS-2 is handy for high resolution audio resolution measurements, multiples up in frequency • great for PL tone measurements • multiplies by 10 or 100 • 0.01 Hz resolution • built-in signal preamp/conditioner

- |                |
|----------------|
| <b>\$69.95</b> |
|----------------|
- wired  
PS-2 kit \$49.95



### PS-10B 1.5 GHz PRESCALER

Extends the range of your present counter to 1.5 GHz • 2 stage preamp • divide by 1000 circuitry • super sensitive 150 mV typical • BNC connectors • 1.5 GHz in 15 MHz out • drives any counter

- |                |
|----------------|
| <b>\$89.95</b> |
|----------------|
- wired includes AC adapter

## COM-3



**\$2795.00** THE COMMUNICATIONS SERVICE MONITOR THAT WORKS HARDER FOR LESS.

Introducing COM-3... the new service monitor designed by service technicians for service technicians. It works harder for less... giving you advanced testing capabilities at a very affordable price. FEATURES • Direct entry keyboard with programmable memory • Audio & transmitter frequency counter • LED bar graph frequency/error deviation display • 0.1-1000 uV output levels • High receive sensitivity, less than 5 uV • 100 KHz to 999.9995 MHz • Continuous frequency coverage • Transmit protection, up to 100 watts • CTS tone encoder, 1 KHz and external modulation

## MINI KITS—EASY TO ASSEMBLE—FUN TO USE

<p><b>TONE DECODER</b> A complete tone decoder on a single PC board. Features 400-5000 Hz adjustable range • 20 turns pot. volt age regulation. 50 K. Useful for touch-tone burst detection. FSK, etc. Can also be used as a stable tone encoder. Runs on 5 to 12 volts</p> <p>Complete kit: TD-1 <b>\$5.95</b></p>	<p><b>COLOR ORGAN</b> See music come alive! 3 different lights flicker with music. One light each for high, mid-range and lows. Each individually adjustable and can be turned off. Runs up to 300 W. Runs on 110VAC.</p> <p>ML-1 kit <b>\$8.95</b></p>	<p><b>VIDEO MODULATOR</b> Converts any TV set video monitor. Super stable, tuneable over ch 4-6. Runs on 5-15V accepts std video signal. Best unit on the market. Complete kit: JM-7</p> <p><b>\$12.95</b></p>	<p><b>FM WIRELESS MIKE</b> Transmits up to 300 to any FM broadcast station. Uses any type of mike. Runs on 3 to 9V. Type FM-7 has added sensitive mike preamp stage.</p> <p>FM-1 kit <b>\$5.95</b> FM-2 kit <b>\$7.95</b></p>
<p><b>40 WATT 2 mtr PWR AMP</b> Simple Class C power amp features 8 times power gain. 1 W in for 8 out. 2 W in for 16 out. 5 W in for 40 W out. Max output of 50 W. Incredible voice. Complete with all parts, less case and 1 R relay.</p> <p>PA-1: 40 W pwr amp kit <b>\$27.95</b> TR-1: RF sensed T-Relay kit <b>6.95</b></p>	<p><b>VOICE ACTIVATED SWITCH</b> Voice activated switch kit provides switched output with current capability up to 300 mA. Can drive relays, lights, LED or even a tape recorder motor. Runs on 9VDC.</p> <p>VS-1KIT <b>\$6.95</b></p>	<p><b>LED Blinky KIT</b> Alternately flashes 2 jumbo LEDs. Use for name badges, buttons, warning panel lights. Runs on 3 to 15 volts.</p> <p>BL-1KIT <b>\$3.95</b></p>	<p><b>MAD BLASTER</b> Produces LOUD ear shattering and attention getting siren like sound. Can supply up to 15 watts of obnoxious audio. Runs on 6-15VDC.</p> <p>MB-1KIT <b>\$4.95</b></p>
<p><b>UNIVERSAL TIMER</b> Provides the basic unit required to provide a source of precision timing and pulse generation. Uses 555 timer IC and includes a range of parts for most timing needs.</p> <p>UT-5KIT <b>\$5.95</b></p>	<p><b>WHISPER LIGHT</b> An interesting kit. Small micro pick up sensors and converts them to light. The louder the sound, the brighter the light. Includes micro controller up to 300 W. Runs on 110 VAC.</p> <p>WL-1KIT <b>\$6.95</b></p>	<p><b>SIREN</b> Produces upward and downward wail. 5 W peak audio output. runs on 3-15 volts. uses 3-4.5 ohm speaker.</p> <p>Complete kit: SM-3 <b>\$3.95</b></p>	<p><b>NEW</b></p>

<p><b>SUPER SLEUTH</b> A super sensitive amplifier which will pick up a pin drop at 15 feet! Great for monitoring baby's room or any general purpose amplifier. Full 700 mV input. runs 6 to 15 volts. uses 8-15 ohm speaker.</p> <p>SN-3KIT <b>\$5.95</b></p>	<p><b>TELEPHONE TRANSMITTER</b> Low cost with professional performance. Features include: self phone line powered, tuneable from 76 to 100 MHz polarity anti-interference. Compact size (1.8 x 1.1) easily installs anywhere on the phone line or inside the instrument itself.</p> <p>TB-6KIT <b>\$14.95</b> TB-6 Assy <b>\$9.95</b></p>	<p><b>FM RECEIVER</b> For built-in applications or hobby experimentation. Full featured super-heterodyne receiver. microvolt sensitivity 10.7 MHz IF. Integrated circuit detector. 50 mW audio amplifier. 9V external power source. operation on standard FM broadcast band as well as large portions on each side. compact 8" squares. for bug detection or reception.</p> <p>FR-1KIT <b>\$14.95</b></p>	<p><b>FM MINI MIKE</b> A super high performance FM wireless mike kit. Transmits a stable signal up to 300 yards with exceptional audio quality by means of its built-in electret mike. kit includes case, mike, on/off switch, antenna, battery and super-instructions. This is the finest yet available.</p> <p>FM-3KIT <b>\$16.95</b> FM-3 wired and tested <b>19.95</b></p>	<p><b>MICROWAVE INTRUSION ALARM</b> A real microwave doppler sensor that will detect a human as far as 10 feet away. Operates on 1.3 GHz and is not affected by heat, light or vibrations. Drives up to 100 mA output, normally open or closed. runs on 12 VDC.</p> <p>Complete kit: MD-3 <b>\$16.95</b> Case kit: CSS-7 <b>\$2.95</b></p>
--	---	---	--	--

## FREQUENCY COUNTERS

Ramsey Electronics has been manufacturing electronic test gear for over 30 years and is recognized for its lab quality products at breakthrough prices. All of our counters carry a full one year warranty on parts and labor. We take great pride in being the largest manufacturer of low cost counters in the entire USA. Complete specifications. Our counters are full featured, from audio to UHF, with FEET high impedance input, proper wave shaping circuitry and durable high quality epoxy glass plated thru PC board construction. All units are 100% manufactured in the USA.

CT-70 7 DIGIT 525 MHz	CT-90 9 DIGIT 600 MHz
<b>\$139.95</b> WIRE INCLUDES AC ADAPTER	<b>\$169.95</b> WIRE INCLUDES AC ADAPTER
CT-50 8 DIGIT 600 MHz	CT-125 9 DIGIT 1.2 GHz
<b>\$189.95</b> WIRE INCLUDES AC ADAPTER	<b>\$189.95</b> WIRE INCLUDES AC ADAPTER

MODEL	FREQ RANGE	SENSITIVITY	ACCURACY	DIGITS	RESOLUTION	PRICE
CT-70	20 Hz - 550 MHz	< 50 mV @ 150 MHz	±1 PPM	7	1 Hz / 10 Hz / 100 Hz	139.95
CT-90	10 Hz - 600 MHz	< 10mV @ 150 MHz < 100mV @ 600 MHz	±1 PPM	9	0.1 Hz / 10 Hz / 100 Hz	169.95
CT-50	5 Hz - 600 MHz	LESS THAN 25 mV	±1 PPM	8	1 Hz / 10 Hz	189.95
CT-125	10 Hz - 1.25 GHz	< 25mV @ 50 MHz < 10mV @ 500 MHz < 300mV @ 800 MHz	±1 PPM	9	0.1 Hz / 1 Hz / 10 Hz	189.95
CT-90 WITH OPT-1	10 Hz - 600 MHz	< 10mV @ 150 MHz < 100mV @ 600 MHz	0.1 PPM	9	0.1 Hz / 1 Hz / 10 Hz	229.95

TELESCOPE whip antenna—BNC plug  
High impedance probe, light loading ..... 18.95  
Low pass probe, audio use ..... 18.95  
Direct probe, general purpose use ..... 13.95  
Trit ball for CT-70, 90 & 125 ..... 3.95  
Nicaid pack for CT-70, 90 & 125 ..... 8.95

**PHONE ORDERS CALL 716-924-4560**  
FAX 716-924-4555  
RAMSEY ELECTRONICS, INC. 793 Canning Parkway, Victor, NY 14564

TERMS: satisfaction guaranteed • examine for 15 days: if not pleased, return in original form for refund • add 6% for shipping and insurance for a maximum of \$10.00 • foreign add 15% for surface mail • CDD add \$2.00 (CDD in USA only) • returns under \$20.00 add \$2.00 • 10% minimum add \$10.00 value for \$10.00 duty parts warranty on all kits • 1 year parts & labor warranty on all wired units.

even short circuit Rsc and the whole circuit will draw only about 2.5 A at 14 volts. Remember what I said about **Figure 1** having a limited regulating capacity. I'm not sure that a single pass transistor version could ever self-destruct if a reasonable amount of heat sinking is used. The power transistors used are so cheap, why not use the Darlington pair?

## Construction

Drill the project box and cut holes for the components. Pop rivet a terminal strip to the bottom of the box. You'll use this to support several of the components.

Mount pass transistor Q1 directly on the rear of the project box. I found that no additional heat sink was required (see **Photo B**). The Superdischarger does get warm, but not hot, for a 1.2-A load at 13.8 volts (about 16 watts of power dissipation). Solder Q2 directly to Q1; no heat sinking is required. Now solder Q3 to the terminal strip along with a couple of resistors and connecting wires as shown in **Photo C**.

The meter was a hamfest special. It senses the drop across R1 to give the proper current indication. R2 is 2 watts or larger; R3 and R4 are 5-watt wirewound potentiometers. They cost about \$10 each, new. My meter was large, so I had limited room to mount the potentiometers on the front panel, and used the miniature Mallory VW series pots. I suggest using a 2 or 3-watt wirewound pot. Normal sized pots are about \$5. I recently found several at a hamfest for \$1.50 each. R3 is optional and provides the fine adjustment of the load. R4 provides all the load adjustment you really need, but I'm just a fanatic!

Provide input connectors to suit your needs. I added tip jacks to the back panel. I plug the leads from my voltmeter into these jacks to check the voltage during the discharge process. The project box from Radio Shack has a nice steel top, but the aluminum chassis is quite thin. The Cinch-Jones connector I chose requires considerable effort to use, so I pop riveted a piece of aluminum angle stock to the top and attached the rear panel to it with sheet metal screws (see **Figure 5**). The top now acts as part of the heat sink.

## Use and operation

Connect your NiCd battery to the Superdischarger, monitor the voltage, switch on the load, and adjust R4 to

**PHOTO B**



Back panel showing input jack and meter jacks. Q1 is mounted directly to the chassis (insulated if you wish) and requires no additional heat sink.

## PARTS LIST

	Radio Shack part no.	Price
S1—SPST switch		
R1—0.1 ohm (optional depending on meter)		
R2—100 ohm, 10 watt	271-135	\$ 2/0.99
R3—100 ohm wirewound pot (optional)		
Mallory VW-100 (5 watts)		about 10.00
Clarostat 58C1 (100 ohms, 3 watts)		about 5.00
R4—1 ohm wirewound pot		
Mallory VW-1 (5 watts)		about 10.00
Clarostat 58C1 (1 ohm, 3 watts)		about 5.00
R5—1 ohm, 1 watt	271-131	2/0.99
R6—0.5 ohm, 1 watt	271-139 (0.47 ohm)	0.49
Q1—2N3055 NPN, TO-3 case	276-2041	1.99
Q2, Q3—TIP3055 NPN, TO-220 case	276-2020	1.59
Metal cabinet	270-253	5.69
Terminal strip	274-688	4/0.89
1-inch knobs	274-416	4/1.79
Meter and hardware to suit your needs		

**FIGURE 5**

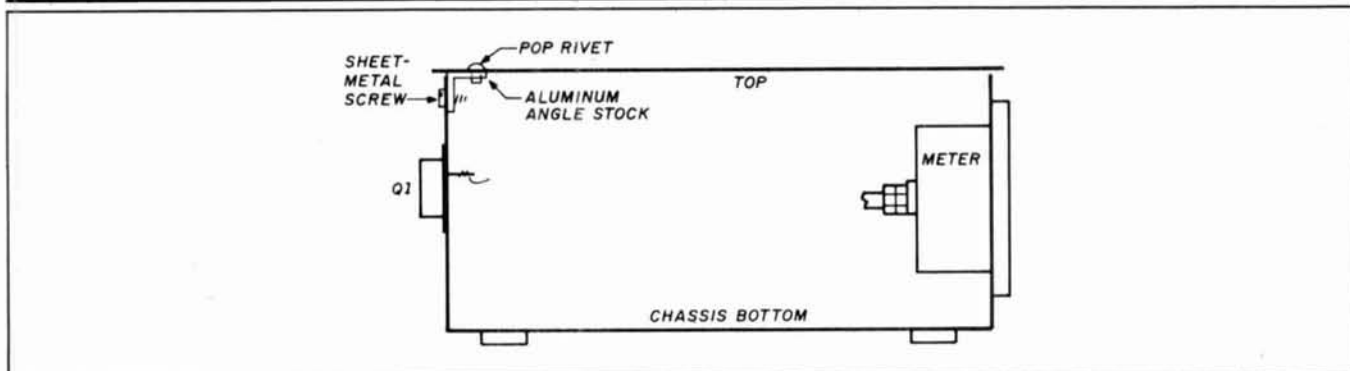

Sectioned view of the project box shows the aluminum angle stock and sheet-metal screws used to secure the top to the back panel for added strength and heat sink.

EVERY ISSUE of  
**HAM  
RADIO**



now available on microfiche!

The entire run of *Ham Radio Magazine* (March, 1968 thru last year) is ready to ship to you in one, easy to use format.

Our 24x microfiche is easy to read and very compact. We offer a hand held reader for \$75, and a desk model for \$220. Libraries have these readers.

As a bonus, you will receive *Ham Radio Horizons* (3/77 thru 12/80) free.

Everything is included, front cover to back - ads too!

Annual updates will be offered for \$10.

Send \$205 payment  
(visa/mc accepted) to:

**BUCKMASTER**  
BUCKMASTER PUBLISHING  
Route 3, Box 56  
Mineral, Virginia 23117  
703/894-5777 visa/mc 800/282-5628



**PacComm**

- Advanced Technology
- Enduring Value

**New! MICROSAT PSK**

The 1st Non-Kit Satellite Modem!

Featuring high performance  
at low cost!

Only **\$219<sup>95</sup>**

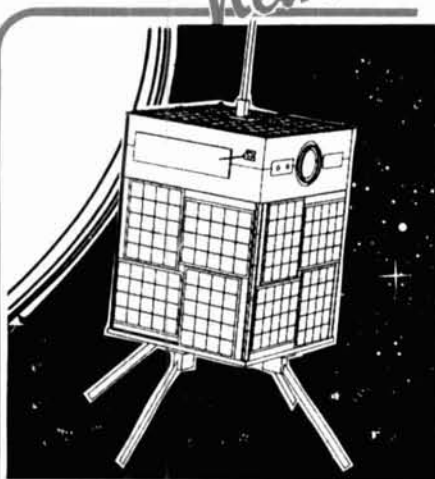

- Completely assembled and tested - *not a kit!*
- Supports 1200 baud MSK transmit and PSK receive for MICROSAT access
- Supports 1200 baud PSK transmit and receive for terrestrial use
- Receives 400 baud satellite telemetry signals
- Doppler shift compensating radio tuning interface
- Easily attaches to any TNC modem disconnect header, cable provided
- Telemetry signals output via RS-232 port

AVAILABLE  
IN  
DECEMBER

For complete info & specifications  
Call (813) 874-2980 To Order, Call  
Toll Free: 1-800-223-3511  
Major Credit Cards Accepted!

PacComm • 3652 West Cypress Street • Tampa, Florida 33607

Please send more info on the MICROSAT PSK Modem  FREE Catalog

Name \_\_\_\_\_ Call \_\_\_\_\_  
Address \_\_\_\_\_ Ph# \_\_\_\_\_  
State \_\_\_\_\_ Zip \_\_\_\_\_ Card# \_\_\_\_\_ Exp. Date \_\_\_\_\_

**MONEY BACK GUARANTEE!** Add \$4.00 shipping/handling per order. FL residents add 6% sales tax.  
Major Credit Card give number, expiration and signature. FAX: 813-872-8696

✓ 120

**Ace Systems**

**OPTO lambic Keyer**



- Ultra compact 5" x 5 1/4" x 1 1/2"
- OPTO isolated output
- Battery or DC powered
- Full function lambic Keyer
- Adjustable speed and weight
- One Year Ace Systems Warranty

- See Your Ace Dealer -

- Amateur Electronics Supply
  - Barry Electronics
  - KJI Electronics
  - Madison Electronics
  - Oklahoma Comm. Center
  - R. F. Enterprises
  - R & L Electronics
  - Rivendell Electronics
- Ace Systems • RD 1 • Box 83 • Wilcox, PA 15870  
(814) 965-5937

✓ 121

**BLACK DACRON® POLYESTER  
ANTENNA ROPE**

- UV-PROTECTED
- HIGH ABRASION RESISTANCE
- REQUIRES NO EXPENSIVE POTTING HEADS
- EASY TO TIE & UNTIE KNOTS
- EASY TO CUT WITH OUR HOT KNIFE
- SIZES: 3/32" 3/16" 5/16"
- SATISFIED CUSTOMERS DECLARE EXCELLENCE THROUGHOUT U.S.A.

LET US INTRODUCE OUR DACRON® ROPE TO YOU • SEND YOUR NAME AND ADDRESS AND WE'LL SEND YOU FREE SAMPLES OF EACH SIZE AND COMPLETE ORDERING INFORMATION.

Dealer Inquiries Invited



synthetic  
textiles, inc. 2472 EASTMAN AVE., BUILDING 21  
VENTURA, CALIFORNIA 93003  
(805) 658-7903

✓ 122

**SYNTHESIZED  
SIGNAL GENERATOR**

MADE IN  
USA



MODEL  
SG-100F  
\$429.95  
delivered

- Covers 100 MHz to 199.999 MHz in 1 kHz steps with thumbwheel dial
- Accuracy +/- 1 part per 10 million at all frequencies
- Internal FM adjustable from 0 to 100 kHz at a 1 kHz rate
- External FM input accepts tones or voice
- Spurs and noise at least 60 dB below carrier
- Output adjustable from 5-500 mV at 50 Ohms
- Operates on 12 Vdc @ 1/2 Amp
- Available for immediate delivery • \$429.95 delivered
- Add-on accessories available to extend freq range, add infinite resolution, AM, and a precision 120 dB attenuator
- Call or write for details • Phone in your order for fast COD shipment.

**VANGUARD LABS**

196-23 Jamaica Ave., Hollis, NY 11423  
Phone: (718) 468-2720 Mon. thru Thu.

✓ 123

PHOTO C

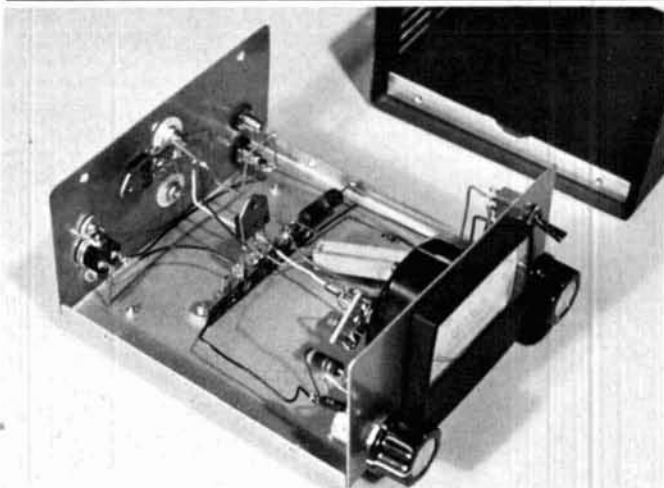

Simple point-to-point construction is used. Q2 is mounted directly to the terminals of Q1. Q3 is mounted on the terminal strip.

500 mA or 1.2 A as needed. Make slight adjustments to keep the load constant as the battery voltage drops. Calculate the capacity of your battery by multiplying the time (hours) by discharge rate. If your AA cells give 500 mA for 1 hour, their capacity is 500 mAh or probably 100 percent of what they're rated (I won't discuss the 1-hour versus 10-hour ratings here).

I find that I'm easily distracted during the discharge cycle and tend to forget about the battery, so I use a kitchen timer and set it to go off every 5 minutes. I can then adjust the load and log the voltage and time, so I can plot a discharge curve if I wish. I also check and log individual cell voltages if I'm not discharging a sealed NiCd pack.

Now if I had a Superduper Discharger, which would automatically turn off the load at a preset voltage, log the time, graph the results... **HP**

REFERENCES

1. W.C. Cloninger, Jr., K3OF, "Get The Most From Your NiCds," *Ham Radio*, December 1988, page 88.
2. Paul J. Dujmich, WA3TLD, "Power Supply Regulation — Using Common Sense," 73, January 1978, page 140.
3. W.C. Cloninger, Jr., K3OF, "723 Voltage Regulators," *Ham Radio*, March 1989, page 42.

## GREAT GIFT IDEA

### HAM RADIO LOG BOOKS

back by popular demand!

Room for over 2100 QSO—that's over twice as many as the other log books. For contesters, each page contains 30 QSO's for easy counts. You also get the latest up-to-date frequency spectrum chart. ITU callsign list and ARRL DXCC list. Spiral bound to lay flat on your desk. Unquestionably the best log book value around. © 1988.

HR-LB.....Spiralbound \$2.95  
 HR-3LB Special Buy 3 Price. Save 22%.....Get 3 offer \$6.95

**HAM RADIO BOOKSTORE**  
 GREENVILLE, NH 03048 (603) 878-1441

Please Add \$3.75 for shipping and handling.



**G5RV**  
**MultiBand Antenna**  
 10 thru 160 Meter  
 Factory Wired & Tested  
 Introductory Price  
**\$39.95 Plus \$4 Shipping**

Authorized TenTec Dealer **K4BWC**

**OMEGA ELECTRONICS**  
 4209 Live Oak Road  
 Raleigh, NC 27604  
 919-832-1025

Visa & Master Card

**LOGWRITE™**

Bring your station into the computer age with LOGWRITE, the menu driven, user friendly logging program written by Ed Troy (NG3V). LOGWRITE is the perfect accessory for the complete ham station. It simplifies your operation and gives you the competitive edge in contesting and DX'ing. LOGWRITE works with all IBM PC's and compatibles.

LOGWRITE's unique split screen feature allows for simultaneous logging and text processing. Logging features include:

- Instant call sign or prefix search
- Print, Edit, or View records
- Plenty of room for notes & addresses
- Automatic time/date stamping

Text processor features automatic word wrap, backspace correct, and scrolling. Throw away your pen and paper!

To order your copy of LOGWRITE, complete with instruction manual, send \$24.95 (Pa. residents add \$1.50 sales tax) to:

Aerospace Consulting  
 P.O. Box 536, Buckingham, PA 18912

Or call (215) 345-7184 to order with Visa/Mastercard. (Please specify 3.5 or 5.25 inch floppy.)  
 FAX (215) 345-1309

Factory Authorized Dealer & Service For  
**KENWOOD**  
**YAESU**  
**ICOM**

Call Us For  
**Great Prices & Great Service**

TOLL FREE ORDER LINE 1-800-344-3144  
 Continental U.S. & Texas

MEMBER OF THE **HAM CENTER** SAN ANTONIO, TEXAS  
**SALES AMATEUR RADIO SERVICE**

5707A Mobud San Antonio, Texas 78238 (512) 680-6110  
 FAX (512) 647-8007



# OUTSTANDING 144-MHZ EME ACHIEVEMENT

**Over 100 initial  
EME contacts with  
a two-Yagi station**

*By Bill Takacs, KB8ZW, 16724 Snyder Road, Chagrin Falls, Ohio 44022*

**O**n a recent trip to Holland I had the pleasure of visiting PA0JMV's remarkable 2-meter, two-Yagi earth-moon-earth (EME) station. What Joe Mutter has done with two Yagis is almost unbelievable. Looking over his QSL cards and logs made me a believer. Joe has managed over 100 initial EME contacts with his two-Yagi station. He has worked 67 countries, 28 states, 55 four-Yagi stations and 2 two-Yagi stations. Photos A through D show this remarkable EME station.

## Antennas

Joe has kept to basics, and the numbers on VK3UM's EME program will demonstrate why this is possible. His antennas are modified homemade 16-element arrays, patterned after KLM's, stacked horizontally at the peak of his roof. Nineteen and one-half feet of coax from each antenna goes to a quarter-wave power divider and to a preamp coax relay. Another 20 feet of coax goes from relay to hamshack, giving 0.7-dB loss into the transmit coax. The preamp is part of a coax relay, with the connector on the relay incorporated as the input circuit of the preamp. He also uses a 70-dB isolation relay. The preamp measures 0.2 noise figure with a 3SK129.

## Azimuth and elevation control

As demonstrated by his azimuth and elevation system, Joe believes in keeping things simple. Azimuth is obtained by turning a big steering wheel which rotates a mast that extends to the roof. The brake is a simple wing clamp affair that tightens the mast. A 12-inch, 360-degree compass rose on the floor gives azimuth readings. I questioned the elevation and Joe said, "Wait, let me get my elevation shoes." Puzzled at this comment, I waited while Joe disappeared downstairs. When he came back up with his elevation

PHOTO A

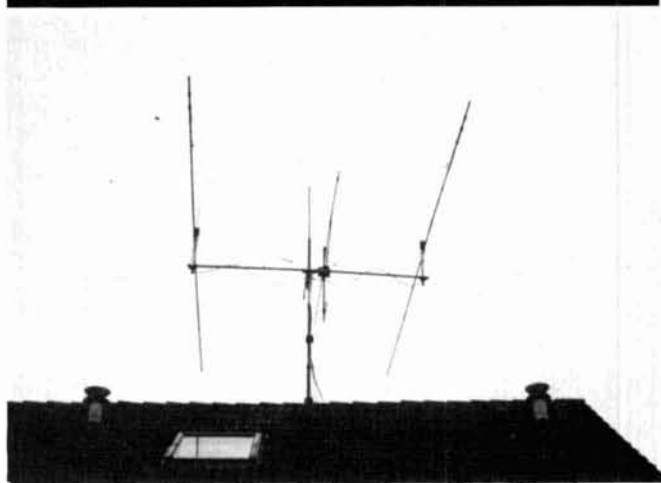

Twin 16-element Yagis perform very well for PA0JMV's EME experiments.

PHOTO B



Antenna azimuth control.

# COMET

ANTENNAS FOR THE PROFESSIONAL AMATEUR

## "NEW" DUAL & TRI BAND SUPER "LINEAR" ANTENNAS

MODEL	FREQUENCY	GAIN	POWER	LENGTH	USE
CA-2X4Z	146 MHz 446 MHz	8.2dB 11.5dB	200W	15' 4"	BASE/REPEATER
CA-2X4FX	146 MHz 446 MHz	4.5dB 7.2dB	200W	5' 11"	BASE/REPEATER
CA-2X4M	140-155 MHz 440-460 MHz	4.5dB 7.0dB	150W	5'	MOBILE
CA-2X4SR	146 MHz 446 MHz	3.8dB 6.2dB	150W	3' 4"	MOBILE
CX-901	146 MHz 446 MHz 1.2 GHz	3.0dB 6.0dB 8.4dB	150W	3' 6"	BASE/REPEATER
CX-801	146 MHz 446 MHz 1.2 GHz	3.0dB 6.8dB 9.6dB	100W	3' 3"	MOBILE
CA-630TN	146 MHz 446 MHz 1.2 GHz	2.15dB 2.15dB 5.5dB	150W 50W	1' 5"	MOBILE

### NEW! ULTRA COMPACT SWR/POWER METERS



CM-200 144-150 MHz  
 CM-300 200-250 MHz  
 CM-400 420-460 MHz  
 CM-420 140-460 MHz  
 CM-900 850-950 MHz  
 CM-1200 1250-1350 MHz

DEALERS INQUIRIES WELCOME

### CALL YOUR DEALER

N.C.G. CO.



1275 N. Grove St.  
 Anaheim, CA 92806  
 (714) 630-4541  
 FAX (714) 630-7024

### THE BEVERAGE ANTENNA HANDBOOK



FULLY  
 REVISED

### BEVERAGE ANTENNA HANDBOOK

by Vic Misek, W1WCR New Edition

W1WCR has spent countless hours developing new antenna ideas and optimizing the SWA (Steerable wave antenna) Misek delves deep into the secrets of the single wire Beverage with helpful hints and tips on how to maximize performance based upon wire size, height above ground, overall length and impedance matching. Also includes information on center fed Beverages constructed out of several wire types. **SMALL LOT OWNERS** — Beverage for you too! Called the Micro-SWA, it is just 60 ft long. You get excellent directivity and null steering capabilities. Transformer design information for both termination and feedline matching is completely revised. 1987 80 pages.

VM-BAH Softbound \$14.95

Please enclose \$3.50 shipping & handling

**HAM RADIO BOOKSTORE**  
 GREENVILLE, NH 03048 603-878-1441

## New from AOR

2000 Channels  
 5MHz to 2000MHz



AR2515

Covers 5MHz to 2000MHz in AM/FM/Wide FM modes. Continuous coverage.

- 2000 Channel Memory
- 1984 Scan Frequencies & 16 Search Groups.
- Scan/Search speeds up to 36 channels or increments per second.
- Built in RS 232 computer interface
- 25 Day Satisfaction Guarantee. Full Refund if not Satisfied.
- Size: 3 1/2"H x 5 1/4"W x 7 1/4"D. Wt: 2lb 10 oz
- Supplied with AC & DC power cords. Telescopic antenna.

Total Price: Freight Prepaid (Express Shipping Optional).  
 \*Upgrades of AR2002's to AR2515 specs Available  
**\$695.00**



COMMUNICATIONS

10707 E. 106th St. Indpls., IN 46256

Toll Free 800-445-7717

Visa and MasterCard

(COD slightly higher)

In Indiana 317-849-2570 Collect FAX (317) 849-8794

### VHF-UHF POWER DIVIDERS



RF power dividers provides the best way to feed in-phase 2 and 4 antenna arrays to maximize system gain and at the same time reduce losses to a minimum. Covering 144 thru 1296 MHz, this series of VHF/UHF power dividers are premier RF devices designed for a long service life with low SWR and broad operating bandwidth.

Extruded aluminum body with a durable enamel finish in addition to silicon sealing at connector flanges results in a ruggedized unit for all array installations. Available with N-type connectors only, these units are unconditionally guaranteed for 2 years.

MODEL	CONFIG.	PRICE
144-2P	(2 ports)	\$54 00
144-4P	(4 ports)	\$61 00
220-2P	(2 ports)	\$53 00
220-4P	(4 ports)	\$60 00
430-2P	(2 ports)	\$51 00
430-4P	(4 ports)	\$59 00
902-2P	(2 ports)	\$51 00
902-4P	(4 ports)	\$59 00
1296-2P	(2 ports)	\$52 00
1296-4P	(4 ports)	\$60 00

SHIPPING NOT INCLUDED

STRIDSBERG ENGINEERING, CO.

P.O. Box 7973 • Shreveport, LA 71107 • USA  
 Phone: (318) 865-0523

### Electronic Repair Center Servicing

Amateur Commercial Radio

The most complete repair facility on the East Coast.

Large parts inventory and factory authorized warranty service for Kenwood, Icom and Yaesu.

**SEND US YOUR PROBLEMS**

Servicing "Hams" for 30 years, no rig too old or new for us.

**HAMTRONICS, INC.**

4033 Brownsville Road

Trevose, Pa. 19047

215-357-1400



116

**PHOTO C**



**EME enthusiast Joe Mutter, PA0UMV.**

**PHOTO D**



**PA0JMV adjusts antenna for elevation control.**

shoes, he demonstrated his system. To adjust the elevation, Joe opens the skylight, climbs onto the tile roof (hence the shoes), and tightens or loosens a tent guy line arrangement until proper elevation is achieved. The system is simple but effective. (I'd sure hate to do this at night during one of our northern Ohio winters.)

**Electronics**

Other equipment consists of a homebrew transverter with a GaAsFET 3SK124 to a Schottky mixer to 28 MHz. The power amp is made up of two 4CX250Rs driven by a BLY88. The power after a low pass filter is just over the kilowatt level. There are two HF transceivers; one is a JRC JST135 and the other a Yaesu FT102 plus FV102DM. Audio is processed through a homemade audio filter that is adjustable to 20 Hz.

**Background data**

Joe's interest in EME was sparked in 1973 when the United States Naval Research Lab (W3KE) started experiments with their big dish. He called them and was heard 459 plus sideband using a pair of F9FTs. They didn't transmit, so he made no two-way contacts. The day after, Joe's father looked at what he had built and asked him to "remove those dangerous looking things." In 1975, Stanford Research Institute organized an EME test weekend. This station was equipped for two-way contacts, but Joe decided that, with its 150-foot dish, it wasn't really an Amateur station. He had called W6PO the day before and asked him for a try. This was Joe's first 2-meter EME QSO. The next day he worked WA6LET without any problems.

Shortly after this, Joe's radio activity went to low-key operation. But in 1986, after some encouragement from SM2CEW, Joe again became interested in EME. A contact with W5UN using a ten-element CueDee and a kilowatt infected Joe with the EME bug, and brought him to where he is today. 

**Foreign Subscription Agents  
for Ham Radio Magazine**

Ham Radio France  
SM Electronic  
20 bis, Ave des Clarions  
F-89000 Auxerre  
France

Ham Radio Canada  
C.A.R.F.  
P.O. Box 356  
Kingston, ON  
Canada K7L 4W2  
Prices in Canadian funds  
1 yr. \$38.00, 2 yrs. \$67.00  
3 yrs. \$90.00

Ham Radio Japan  
Katsumi Electronic Co., Ltd.  
27-5 Ikegami  
4 Chome, Ota-Ku  
Tokyo 146, Japan  
Telephone (03) 753-2405

Ham Radio England  
c/o R.S.G.B.  
Lambda House  
Cranborne Road  
Potters Bar  
Herts EN6 3JW  
England

**Say You  
Saw It in  
Ham  
Radio**

**1990 U.S. CALL DIRECTORY  
(on microfiche)**

Call Directory - by callsign .....\$10  
Name Index - by last name .....\$10  
Geographic Index - by state/city .....\$10  
All three - \$25  
\$3 shipping per order

**BUCKMASTER PUBLISHING**

Route 3, Box 56  
Mineral, Virginia 23117  
703/894-5777 visa/mc 800/282-5628



# FLEA MARKET

**RATES** Noncommercial ads 10¢ per word; commercial ads 60¢ per word **both payable in advance.** No cash discounts or agency commissions allowed.

**HAMFESTS** Sponsored by non-profit organizations receive one free Flea Market ad (subject to our editing) on a space available basis only. Repeat insertions of hamfest ads pay the non-commercial rate.

**COPY** No special layout or arrangements available. Material should be typewritten or clearly printed (not all capitals) and must include full name and address. We reserve the right to reject unsuitable copy. **Ham Radio** cannot check each advertiser and thus cannot be held responsible for claims made. Liability for correctness of material limited to corrected ad in next available issue.

**DEADLINE** 15th of second preceding month.

**SEND MATERIAL TO:** Flea Market, Ham Radio, Greenville, N. H. 03048.

**BEGINNER'S RADIO CLEARINGHOUSE.** On a space available basis, we are going to offer you, OUR SUBSCRIBER, free of charge, a chance to find a home for your used equipment with a new Ham. Please send us a short description of what you want to sell along with price, name, address and phone number. Please limit your ad to 20 words or less.

**WANTED:** Ham equipment and other property. The Radio Club of Junior High School 22 NYC, Inc. is a nonprofit organization, granted 501(C)(3) status by the IRS, incorporated with the goal of using the theme of Ham Radio to further and enhance the education of young people nationwide. Your property donation or financial support would be greatly appreciated and acknowledged with a receipt for your tax deductible contribution. Meet WB2JKJ and the "22 Crew" at Dayton, we will have two tables for "Classroom Net" members to congregate at. Talk in on 144.30 throughout the Hamvention. Join the "Classroom Net", 7.238 and 21.395 daily. Write us at: PO Box 1052, New York, NY 10002. Round the clock hotline: (516) 674-4072.

**FOR SALE:** ICOM 2400, ICOM IC-901. (201) 991-9280 after 7 PM EST. Also R-7000.

**FREE CATALOG.** Interfaces for IBM compatibles. Digital I/O and Analog input. Control relays, motors, lights, measure temperature, voltage. John Bell Engineering, Inc., 400 Oxford Way, Belmont, CA 94002. (415) 592-8411.

**WANTED:** Manual or copy for Simpson V.T.V.M. Model 266, Gonset Communicator VFO (6.2,220). Buy or swap. Alex Helfman, W2OEG, 83-55 Woodhaven Blvd, Woodhaven, NY 11421.

**DRAKE TR4 TRANSCEIVER**, power supply and speaker, excellent condition. \$325. Mosley CL33 tribander, \$150. Rich Assarabowski, K1CC, 306 Vernon Avenue, Vernon, CT 06066. (203) 875-0166.

**HAM SOFTWARE FOR IBM.** Beam heading, grid squares and more. \$5.95 includes shipping and free catalog. Personal checks accepted. Unicorn Software, 167 Kuntz Road, Hanover, Indiana 47243.

**BATTERY PACK REBUILDING:** Don't pitch it—mail it—for FAST—PROFESSIONAL service! Satisfaction guaranteed! ICOM: BP2/BP3 \$19.95, BP5 \$25.95, BP7/BP8/BP70 \$32.95. KENWOOD: PB21 \$15.95, PB21H \$21.95, PB25/25H/26 \$24.95. YAESU: FNB9 \$19.95, FNB10 \$23.95, FNB4/4A \$36.95, TEN-TEC: \$24.95 "U-DO-IT INSERTS" ICOM: BP3 \$16.95, BP5 \$22.95, BP7/8 \$27.50, KENWOOD: PB21 \$12.95, PB24/25/26 \$19.95, TEMPO: S1-15/SERIES \$22.95, YAESU: FNB4/4A \$32.95, FNB10 \$18.95, AZDEN: 300 \$19.95, "NEW PACKS" ICOM: BP5 \$43.95, BP8S \$58.95, YAESU: FNB2 \$19.95, FNB10S/FNB12 \$44.95, SANTEC: 142/1200 \$22.95. TELEPHONE/PAGER/COMPUTER/COMMERCIAL PACKS—Free catalog. Add \$3.00 shipping/order. PA + 6% VISA/MC add \$2.00. CUNARD, RD 6, Box 104, Bedford, PA 15522. (814) 623-7000.

**VACUUM VARIABLE:** Jennings type UCS 10-300pf 7.5KV, new, \$85. 813, \$33.50; 4-250, \$62.50. ARTTZ VE6GB, Box 3222, Airdrie, Alberta T4B 2B6.

**"SOFTSTART".** Protect your valuable tubes and power supply diodes from DANGEROUS inrush surge currents. Can be retrofitted into most amplifiers. Completely assembled Amateur net for "SOFTSTART" is \$49.95 plus \$5.00 shipping in the 48 states. OMEGA ELECTRONICS, 4209 Live Oak Road, Raleigh, NC 27604. (919) 231-7373.

**FREE LIST** of low cost ham equipment. Write to Jim Braddy, WA4DSO, 3037 Audrey Drive, Gastonia, NC 28054.

**WANTED: BUY & SELL.** All types of Electron Tubes. Call toll free 1-800-421-9397 or 1-612-429-9397. C & N Electronics, Harold Bramstedt, 6104 Egg Lake Road, Hugo, MN 55038.

**UPGRADING AND REPAIRING PC'S.** A comprehensive resource to personal computer upgrades, repair, maintenance and troubleshooting. Covers all types of IBM computers and compatibles. 750 pages. \$27.95. Personal checks accepted. Unicorn Software, 167 Kuntz Road, Hanover, Indiana 47243.

**RADIO SHACK** Color Computer Ham Software and Hardware. Free catalog. Dynamic Electronics, POB 896, Hartselle, AL 35640. (205) 773-2758.

**HAM SOFTWARE** IBM/Compatibles 10 disks \$26.95. MC/VISA/Discover. N5ABV EAPCO/H, Bx 14, Keller, TX 76248-0014. (817) 498-4242. 1-800-869-7208.

**WANTED:** Original 40's and 50's service test equipment manuals. No HP or Tektronix. R. Galloway, 2220 Woodbury Rd, Melbourne, FL 32935.

**WANTED:** B&W 40TVH and 80JCL plugin coils. James Schliest, W4IMQ, PO Box 93, Cedartown, GA 30125. (404) 748-5968.

**VIBROPLEX COLLECTOR'S GUIDE.** Covers all bugs and paddles. Includes history of each key, identification, dating tips, complete patents, and more. \$14.95 plus \$2.00 s/h (foreign, \$5.00 s/h). Detains SASE. Artifax Books, Box 88-IF, Maynard, MA 01754.

**YAGI BUILDERS.** Tube traps, tubing, clamps and universal plate for boom to mast or elements. Six band rotary dipole or Yagi. 10thru 40M. SASE for details. 1-800-833-3794, 1-2 PM EST. Brown Engineering, Inc, 5501 SW 25th Court, Hollywood, FL 33023.

**WANTED:** Schematic/service manual for my Hallicrafter SX117-H44 Hunter Bandit Linear. Bill Webb, K4OPE, POB 5, Paint Rock, AL 35764.

**PRE-1942 TRANSMITTER WANTED.** Any condition or part considered. Examples: Gross, Stancor, Collins, Thordarson, Harvey, Temco, National, Utah, Hallicrafters, Hammarlund, Guthman, Bob Mattson, KC2LK, 10 Janewood, Highland, NY 12528. (914) 691-6247.

**CHASSIS AND CABINET KITS.** SASE. K3IWK, 5220 Harmony Grove Rd, Dover, PA 17315.

**HALLICRAFTERS SR400A CYCLONE III.** 80-100 meters, 550 watts SSB, AC PS with speaker. DC PS. Mobile mounting bracket, manual. Shure 444 mic. \$400. B.A. Fred, KA9QEK, 25W632 Flint Creek Rd, Wheaton, IL 60187. (708) 668-7460.

**RTTY JOURNAL** published 10 times per year for those interested in digital communications. Read about RTTY, AMTOR, MSO'S, PACKET, RTTY DX and Contesting. Plus technical articles concerning the digital modes. \$12.50 per year (foreign higher). RTTY JOURNAL, 9085 La Casita Ave, Fountain Valley, CA 92708.

**CUSTOM MADE EMBROIDERED PATCHES.** Your design, any shape and colors. Free ordering information, price list and random sample. HEIN, 79602 Manitow Trail, Glen Arbor, MI 49636-9711.

**IBM-PC RTTY/CW.** New CompRtty II is the complete RTTY/CW program for IBM-PC's and compatibles. Now with larger buffers, better support for packet units, pictures, much more. Virtually any speed ASCII, BAUDOT, CW. Text entry via built-in screen editor! Adjustable split screen display. In-stand mode/speed change. Hardcopy, diskcopy, break-in buffer, select calling, text file transfer, customizable full screen logging, 24 programmable 1000 character messages. Ideal for MARS and traffic handling. Requires 256K PC or AT compatible, serial port, RS-232C TU. \$65. Send call letters (including MARS) with order. David A. Rice, KC2HO, 144 N. Putt Corners Rd, New Paltz, NY 12561.

**LET THE GOVERNMENT FINANCE** your small business. Grants/loans to \$500,000. Free recorded message: 707-448-0270. (KH5).

**WANTED:** Old, odd and unique bugs (speed-keys). Please help. Smiley, WB4EB, PO Box 5150, Fredericksburg, VA 22403. (703) 373-0996.

**BEAT THE COLD!** Melbourne, FL QTH: 4:2:2 (3100 sq/ft) house, 1.6+ acres, 220V wired shack with coax races built in, RHON/25 pad, workshop, pool, sprinkler system, in the country no restrictions, many tall pines and oaks, easy commute to Cape Canaveral, close to fishing/beaches/shopping, SAE for details and photos, \$209,000. NODH/H.

**AVANTEK ATF10135,** \$12.00, MMIC's, P.C. board, SASE: WA3IAC, 7148 Montague St, Philadelphia, PA 19135.

**"HAMLOG" COMPUTER PROGRAM.** Full features, 18 modules. Autologs, 7-band WAS/DXCC. Apple, IBM, CP/M, KAYPRO, Tandy, C128 \$24.95. HR-KA1AWH, POB 2015, Peabody, MA 01960.

**HF PACKET IMPROVEMENT**—Digicom 64 revision "A" circuit now available. Board plugs directly into cassette port or remote mount via cable, both connectors included. Power derived from computer. Uses 7910 chip—no alignment required. Switch allows HF or VHF operation. Order Kit #154 for \$49.95 or Assembly #k154 for \$79.95, both include FREE DISK. Add \$3.50 s/h. CA add 6.25% tax. A & A Engineering, 2521 W. LaPalma #K, Anaheim, CA 92801. (714) 952-2114. MC or VISA accepted.

**IMRA International Mission Radio Association** helps missionaries. Equipment loaned. Weekday net, 14.280 MHz, 1-3 PM Eastern. Nine hundred Amateurs in 40 countries. Rev. Thomas Sable, S.J., University of Scranton, Scranton, PA 18510.

**HOW TO DESIGN AND BUILD YOUR OWN COMPUTERIZED PRODUCT!** New manual makes it easy! Simple step-by-step details from idea to finished product. Includes introduction to design, choosing the proper CPU, comparison between many CPUs & microcontrollers, circuit layout, sample schematics, programming, debugging, hints, tips, and more! \$8.00 complete. Satisfaction guaranteed. Details free. TRAVY-CO, 107 E. Vallette, Suite 1301G, Elmhurst, Illinois 60126.

**HAM QTH.** Hilltop woodland. Approx. 1500 ft. above sea level. 17.8 acres. Located in NH near Mass. border; perched for single residence, solar exposure, privacy, access road is town-owned, owner-maintained. Phone and power lines within approx. 2500 ft. \$79,000. Call or write for details. (603) 547-2053. C.W. Farr, Broker, Rt 1, Box 223, Greenfield, NH 03047.

**INTERESTED IN PUBLIC SERVICE?** Join your Local Radio Emergency Associated Communications Team. In Pennsylvania call (717) 938-6943 or write REACT, 1160 Old Trail Rd, Ebers, PA 17319.

**RUBBER STAMPS:** 3 lines \$5.00 PPD. Send check or MO to G.L. Pierce, 5521 Birkdale Way, San Diego, CA 92117. SASE brings information.

**ELECTRON TUBES:** Receiving, transmitting, microwave... all types available. Large stock. Next day delivery, most cases. DAILY ELECTRONICS, PO Box 5029, Compton, CA 90224. (213) 774-1255.

**RECONDITIONED TEST EQUIPMENT** \$1.25 for catalog. Walter, 2697 Nickel, San Pablo, CA 94806.

## COMING EVENTS

Activities — "Places to go . . ."

**SPECIAL REQUEST TO ALL AMATEUR RADIO PUBLICITY COORDINATORS:** PLEASE INDICATE IN YOUR ANNOUNCEMENTS WHETHER OR NOT YOUR HAMFEST LOCATION, CLASSES, EXAMS, MEETINGS, FLEA MARKETS, ETC. ARE WHEELCHAIR ACCESSIBLE. THIS INFORMATION WOULD BE GREATLY APPRECIATED BY OUR BROTHER/SISTER HAMS WITH LIMITED PHYSICAL ABILITY.

**MARCH 31-APRIL 1: MARYLAND:** The Baltimore ARC's 1990 Greater Baltimore HamBoree and Computerfest, Maryland State Fairgrounds Exhibition Complex, Timonium. Gates open 8 AM. Admission \$5 for both days. Children under 12 free. For information and space reservations contact GBH&C, PO Box 95, Timonium, MD 21093-0095 or 1-800-HAM-FEST 24 hours a day. In MD dial 301-HAM-FEST on 3rd phone.

**APRIL 7: MINNESOTA:** The Lake Region ARC's Tri annual Hamfest, Otter Tail County Fairgrounds Hockey Arena, Hwy 59 So., Fergus Falls. 8 AM to 3 PM. Registration \$3/advance; \$4/door. 6' tables \$4. For information call (218) 826-6274 or write Keith McKay, N0FKF, Rt 1, Box 46, Battle Lake, MN 56515.

**APRIL 7: MICHIGAN:** The Blossomland ARC's Hamfest, Fair Plain Jr. High School, Benton Harbor. 8-12. Admission \$3. For information Paul Reissmann, W8MWT, B.A.R.A., PO Box 175, St. Joseph, MI 49085 or call (616) 429-6230.



**APRIL 7: WASHINGTON:** The 12th annual Inland Empire and Eastern Washington Section Hamfest, Spokane Youth Sports Bingo Hall, E. 2230 Sprague Ave, Spokane.

**APRIL 7: PENNSYLVANIA:** AARG Hamfest and Computer Show, Lebanon Fairgrounds, Lebanon. Admission \$4. Tailgating \$3/space. Handi accessible. For information contact Homer, WA3YMU, (717) 345-3780, Ron, WB3HNX (717) 345-8667, Paul, WB3HEC, (717) 566-2606.

**APRIL 8: NORTH CAROLINA:** The Raleigh ARS is sponsoring its 18th annual Hamfest and NCS ARRL Convention, Jim Graham Building, NC State Fairgrounds, Hillsboro St, Raleigh. Admission \$4 to April 2. For information contact Rollin Ransom, NF4P (919) 269-4406.

**APRIL 14-15: TEXAS:** The Key City ARC Swapfest and ARRL Convention, Abilene Civic Center, Pine St. 8 AM to 5 PM and 9 AM to 4 PM Sunday. Admission \$5 advance; \$6/door. Tables \$2. Send pre-registration to KCARC, PO Box 2722, Abilene, TX 79604 or contact Bill Jones, N5DOX (915) 698-4606.

**APRIL 15: MASSACHUSETTS:** Tailgate electronics, computer and Amateur Radio flea market, sponsored by the MIT Radio Society and the MIT Electronics Research Society, Albany and Main St, Cambridge. Admission \$1.50. Free off street parking for 1000 buyers. For space reservations or info call (617) 253-3776. Mail advance reservations before April 5 to Richard Brezina, 3 Ames St, Cambridge, MA 02139.

**APRIL 21: OKLAHOMA:** The Lawton-Fort Sill ARC's 43rd annual Hamfest, County Fairgrounds, Lawton. 8 AM to 5 PM. For information contact Claude R. Matchette, 3411 NW Atlanta Ave, Lawton, OK 73505. (405) 357-5870.

**APRIL 21: ARKANSAS:** ARRL All Arkansas Ham Convention, North Little Rock Community Center. Sponsored by the C.A.R.E.N. Radio Club. Admission \$3. For information contact Bob Hancock, KB5IDB (501) 771-2617 or Leon Schlosser, N5GYW (501) 835-4004 evenings.

**APRIL 22: MASSACHUSETTS:** Wellesley ARS Hamfest, Wellesley Senior High School parking lot, 50 State Street, Wellesley. 9 AM to 2 PM. Admission \$2. Contact Gerry Driscoll, NV1T (617) 444-2686.

**APRIL 22: CONNECTICUT:** The 7th annual Southington ARA's Flea Market, Southington HS Cafeteria, 720 Pleasant Street, Southington. 9 AM to 1 PM. Admission \$3. For information Chet, KA1ILH, 628-9346, 5 to 9 PM.

**APRIL 22: ILLINOIS:** The Moultrie ARK's 27th annual Hamfest, Cadwell Road, Sullivan. For information, tables, space call or write Ralph Zancha, WC9V, 502 E. State St. Lovington, IL 61937. (217) 873-5287 evenings.

**APRIL 27: DAYTON, OHIO:** The Dayton-Cincinnati Chapter of the Quarter Century Wireless Association announces its annual QCWA Banquet, Neil's Heritage House. COD bar 6:30. Banquet 7:30. Tickets \$14, reservations required. For tickets or information contact Bob Dingle, KA4LAU, 657 Dell Ridge Drive, Dayton, OH 45429. (513) 299-7114.

**APRIL 27: DAYTON, OHIO:** The Southwest Ohio DX Association will again host the DX dinner at the Stouffer Center Plaza Hotel. Advance tickets only \$23.00 per person. SASE to with check payable in US funds to SWODXA to Scott Lehman, N9AG, PO Box 803, Greenville, OH 45331.

**APRIL 27: DAYTON, OHIO:** The 21st annual B\*A\*S\*H\*, Conference Center (Madison Room) of the HARA Arena. Starts 7 PM. No admission charge. Hot food available. Free entertainment. Also a hot-air balloon launch Saturday, April 28 at 6:45 AM (weather permitting) conducting aeronautical QSO's. Frequencies announced at B\*A\*S\*H\*. Special event cards will be issued. Sponsored by the Miami Valley FM Association, PO Box 263, Dayton, OH 45401.

**APRIL 29: NEW HAMPSHIRE:** "Dayton East", Contoocook (near Concord). Starts 7 AM. Buyers \$1. Sellers \$5. For information K1OPQ (603) 746-5090 or PKT BBS @ WA1WOK-2.

**MAY 4-6: ARIZONA:** The Cochise ARA's annual Hamfest, club training facility, Moson Road, Sierra Vista. Free tailgating. Handi facilities. For information contact N7INK (602) 378-3155 after 6 PM or write CARA, PO Box 1855, Sierra Vista, AZ 85636.

**MAY 5: WISCONSIN:** The Ozaukee Radio Club's 12th annual Cedarburg Swapfest, Circle B Recreation Center. 8AM to 1 PM. Admission \$2/advance; \$3/door. For tickets, table reservations, maps, information send business SASE to ORC Swap, N5415 Crystal Springs Ct, Fredonia, WI 53021. (414) 692-2329.

**MAY 20: ILLINOIS:** The annual Hamfest sponsored by the Kankakee Area Radio Society, Will County Fairgrounds, Peotone. 8 AM to 2 PM. Indoor flea market and exhibitor tables (limited). Large outdoor flea market. ARRL booth. free parking. Food and drink available. Admission \$2.50 advance, \$3.00 at the door. Setup 4 May 20, 6-8AM. Talkin on 146.34/94. More information from KARS, c/o Frank DalCanton, KA9PWW, RR1, Box 361, Chebanse, IL 60922. Tel (815) 932-6703 after 4 PM CST or (815) 937-2452 before 4 PM CST.

## OPERATING EVENTS

"Things to do . . ."

**The Tipton ARS** will operate special event station KC7YL from Fort Pillow State Park in Lauderdale County, Tennessee. 1800Z April 7 to 1900Z April 8. Voice: 28.450, 21.350, 14.325. CW: 28.200 and 21.150. For an attractive certificate send QSL and large SASE to WB4DPL, PO Box 402, Covington, TN 38019.

**The Cornish Radio Amateur Club of England** is sponsoring International Marconi Day to celebrate Marconi's birthday. 0000Z-2400Z April 21 in the General bands. Work 10 stations and send log to CRAC, PO Box 100, Truro, TX1 1RX, Cornwall, UK.

**The Warminster ARC's** 2nd annual DXpedition to Delaware, April 8, operating WA3DFU/3. Freq: 7.275, 14.275, 28.375. CW on request. QSL with SASE to Warminster ARC, Box 113, Warminster, PA 18974.

**The Great River ARC**, Dubuque, IA, will operate special event station WK90 (N9GBW) April 28 at the 36th annual U.S. Boy Scout Pilgrimage. 10-4 local time, lower General band and Novice 10m band, SSB. No SAE, QSL required for certificate.

**Claremont Repeater Association** will operate "Sam's Day" in honor of the 199th birthday of Samuel F. B. Morse. Control op WF6ZZ, Samuel Morse 3d. 1800 UTC to 2400 UTC Saturday April 28. 28.350 and 21.300 phone and 14.050 CW. QSL to CLARA, PO Box 7675, Huntington Beach, CA 92615.

**THROUGHOUT 1990** the Major Armstrong Memorial Amateur Radio Club (MAMARC) will sponsor events commemorating Major Edwin Howard Armstrong's achievements in the field of radio broadcasting. The club is seeking other Amateur operators around the world who are willing to research Major Armstrong's accomplishments and become official MAMARC special events stations. Major Armstrong was a pioneer responsible for the creation of Wideband FM and the inventor of the superhetrody.

**Monthly Ham Exams.** The MIT UHF Repeater Association and the MIT Radio Society offer monthly ham exams, all classes. Novice to extra: next-to-last Wednesday of each month, (April 18) 7:30 pm, MIT Room 1-150, 77 Mass Avenue, Cambridge, MA. reservation requested a couple of days in advance, walk-ins welcome; call the shack (617) 253-3776, or Nick Altenbernd (617) 437-0320. Exam fee \$4.95. Bring copies of your current license (if any) and Certificates of Completion (if any), two forms of picture ID, and a completed form #10, available from the FCC: (617) 770-4023.

**LAUREL ARC** monthly (except December) Amateur exam sessions for all license classes. No fee is charged. Pre-registration is required. Call (301) 725-1212, Maryland Radio Center, 8576 Laureldrive Drive, Laurel, MD 20707.

**AMATEUR RADIO CLASSES:** For those people interested in obtaining a Novice (basic level) Ham license or upgrading to Tech/General, the Chelsea Civil Defense, in cooperation with QRA Radio Club, will sponsor Amateur Radio Communications classes evenings at Chelsea High School starting MARCH 7, 1989. For more information write Frank Masucci, K1BPN, 136 Grove Street, Chelsea, MA 02150. Please enclose your telephone number.

# HAM RADIO BOOKSTORE

GREENVILLE, N.H. 03048  
(603) 878-1441

## NEW BOOKS

### UHF COMPENDIUM Part III and IV

Edited by K. Weiner, OJSHO

This is one of the most long awaited books in Amateur Radio. It represents over two years of work and contains more than theory — it's chock full of practical, tested designs from some of Europe's most noted hams. Subjects covered include: notch filters, antennas and IF pre-amps, transistor drivers, transmit and receive converters, power amplifiers and much more. This book is guaranteed to be a best seller. Order yours today (this book is imported and supplies will vary due to shipping delays.) 1989 1st Edition

KW-UHF3

Softbound \$29.95

### 1989-1990 ARRL REPEATER DIRECTORY

Includes all the latest repeater listings available. Lists 13,000 repeaters, 2,200 digipeaters, and 475 beacon stations from 14 MHz to 24 GHz. Get your copy of this new book today!

AR-RR

Softbound \$4.95

### ARRL CODE TAPES

Four new sets of code practice tapes from the ARRL. Each set consists of two 90 minute cassettes and gives you almost 3 full hours of practice. Great way to study when you can't get on the air.

AR-1 5-10 WPM

\$9.95

AR-2 10-15 WPM

\$9.95

AR-3 15-22 WPM

\$9.95

AR-4 13-14 WPM

\$9.95

### THE FABULOUS RADIO NBD

by Brandon Wentworth, K6UJ

Here is the story of one of WW II's most important radio stations. Written from the first hand stories and actual experiences of the men who operated NBD. Includes technical descriptions of the equipment and antennas. Great history reading!

1984 1st edition. 34 pages

BH-NBD

Softbound \$4.95

### NEWNES Radio Amateur and Listener's Pocket Book

by Steven Money, G3FZX

Unique collection of useful information for the Radio Amateur and hi-tech listener. Full of hard-to-find information. Includes codes, symbols, formulae, frequencies, in addition to AMTOR, packet and SSTV. Handy "pocket book" size. 1987 1st edition. 160 pages.

CRC-RA

Hardbound \$19.95

### WIRELESS ANTENNA HISTORY

A vertical design primer

by Walter Schulz, K3DOF

Starts with a well written history of radio's beginnings. Nine chapters cover radio from the first pioneers through the beginnings of radio astronomy. The vertical primer is a complete section on how to design, build and optimize a vertical antenna. Full of explanations and handy hints not found elsewhere. 1988 1st edition. 140 pages

GL-DOF

Softbound \$16.95

### HINTS AND KINKS for the Radio Amateur

edited by KBCH & AK7M

This is the twelfth collection of ideas taken from QST's most popular column. Hints and Kinks. Other's hands on experience can save you hours with suggestions on how to build a better mousetrap. Includes ideas on station accessories, operating cw, computers, antennas, shop secrets and much more! Great new edition! 1989 17th edition

AR-HK

Softbound \$4.95

### N6RJ'S SECOND OP MANUAL VERSION

Now available in slide rule format for non-computerized hams! Fully up dated with all the latest prefixes, zones, postage and other information. GET YOURS TODAY! 2nd edition 1989

CB-20P

\$9.95

Please enclose \$3.75 for shipping and handling

## SHORT CIRCUIT HOTLINE



## MOVING?

Let circulation know  
60 days in advance.

Ham Radio  
Greenville, NH 03048-0498  
603-878-1441

# Elmer's Notebook

By Tom McMullen, W1SL

## ELEMENTARY ELECTRONICS: INDUCTORS AND AC

In past issues I've looked at resistors, capacitors, and magnetic fields around wires and simple coils. I explored them using direct current (DC) as the energy source. Life in the DC world is somewhat simple. Current either flows or it doesn't, and when it flows, it goes from one power source terminal to the other in a straightforward manner. Along the way, it can be restricted by resistors, smoothed by capacitors, divided, combined, and so on. It's all just "plain vanilla" electronic theory. When you enter the world of alternating current (AC), things get a bit more complex. Most of the simple rules apply, but you have to keep one basic rule in mind — alternating current flows from one power source terminal to the other for a short time, *and then turns around and goes back!* Secondary to this is the fact that the voltage isn't constant, but varies from zero volts to some non-zero value (either positive or negative) and then returns to zero twice during each cycle.

### Waveforms

The figures you see on an oscilloscope are generally voltage waveforms, so it's a bit strange to call them AC waveforms. However, if you remember that the voltage you're looking at was probably derived from alternating current flowing through a resistance, it makes sense that the oscilloscope shows a representation of an AC waveform.

A basic AC waveform, like the one provided by most household electric service, is shown in Figure 1. Household AC is generated by mechanical means — a generator that forces a massive winding of wire through a magnetic field. Waveforms generated by electronic circuits (oscillators) can be made with the same shape and cycle period, or with an almost unlimited variety of shapes and cycles.



### Current and voltage relationships

It doesn't matter if the waveform you're examining is made by a mechanical generator or is created by electronic oscillators; the relationship between the voltage and current is what's important.

At the start of each cycle, there's no voltage and no current flow; this is the zero (0) point. As the voltage builds up, current increases. In a circuit with only pure resistance, the current and voltage stay in unison throughout the cycle; when the voltage reaches its peak, so does the current. The complete cycle is said to take place in 360 degrees, and is related directly to the mechanical generator concept where a coil (armature) rotates about its axis while in a magnetic field. Portions of a cycle can be described conveniently by referring to the "degrees" (of rotation) along the waveform. This degree concept also comes in handy when determining how the current is doing compared with the voltage (more on this later).

FIGURE 1

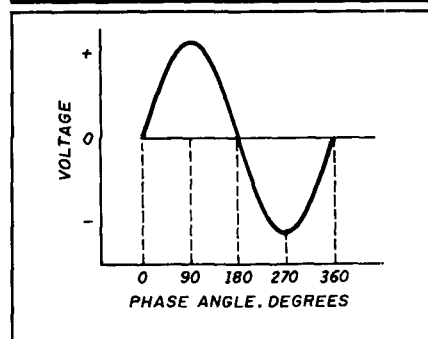

The waveform of common household AC power is a sine wave with equal positive and negative peaks during a cycle. The degree references are explained in the text.

The waveform demonstrated in Figure 1 is called a sine wave. You can generate one on graph paper by plotting the sine of the angle, as shown in Figure 2. Not all AC waveforms are as neat as this, however. They can be distorted by amplifiers, capacitors, and inductors, or they may not have been sine waves to start with. Square, triangle, and sawtooth waves, in addition to random audio (speech) waveforms, are also types of AC. But the easiest way to understand how AC behaves in a circuit is to stick with sine waves.

### Phase shift

In simple resistive circuits, the current flow stays exactly in time with the voltage buildup or decay. When the voltage is at maximum, so is the current flow. As voltage changes, so does the current — in exact proportion. Under these conditions, the voltage and current are said to be "in phase" with each other. However, AC really spends most of its life in a world that's full of reactance (I'll talk about reactance shortly). Both inductors (coils) and capacitors have reactance, but I'll just look at inductors this time and save capacitors for a future issue.

In a past discussion of DC flowing in an inductor, I noted that the current flow created a magnetic field which not only used and stored energy, but created a counter force (called counter electromagnetic force or counter emf) that opposed the current flow during the buildup. When the current flow stopped, the magnetic field collapsed and the energy was released — returned to the circuit in the form of electron flow in the same direction as the original current flow!

The same thing happens when AC flows through a coil, but because of the changing nature of AC, the effects are more noticeable. As the voltage builds up through the 0 to 90-degree portion of the waveform, the current gets behind. Remember, it's current (electron movement) that does the work in a circuit. So while the voltage gets from one end of a coil to the other quickly, the current is busy building up a magnetic field which further slows the current buildup because it creates a



# Out of State 1-800-882-1343

(213)390-8003 FAX 213-390-4393

HOURS M-F 9:00 - 5:30 SAT 9:00 - 5:00 SE HABLA ESPANOL  
QUICK SERVICE CENTER FOR REPAIR NEEDS

3919 SEPULVEDA BOULEVARD, CULVER CITY, CALIFORNIA 90230

## ICOM IC-781



HF Equipment	List	Jun's
IC-781 Super Deluxe HF Rig	\$5995.00	Call \$
IC-765 New, Loaded with Features	3149.00	Call \$
IC-735 Gen. Cvg. Xcvr	1099.00	Call \$
IC-751A Gen. Cvg. Xcvr	1699.00	Call \$
IC-729 New Ultra-Compact Xcvr	949.00	Call \$
IC-726 HF/50 MHz All Mode	1299.00	Call \$
<b>Receivers</b>		
IC-R9000 100 kHz to 1999.8 MHz	5459.00	Call \$
IC-R7000 25-1300 + MHz Rcvr	1199.00	Call \$
IC-R71A 100 kHz - 30 MHz Rcvr	999.00	Call \$
<b>VHF</b>		
IC-228A/H New 25/45w Mobiles	509./539	Call \$
IC-275A/H 50/100w All Mode Base	1299./1399	Call \$
IC-28A/H 25/45w, FM Mobiles	469./499	Call \$
IC-2GAT, New 7w HT	429.95	Call \$
IC-2SAT Micro Sized HT	439.00	Call \$
IC-901 New Remote Mount Mobile	1199.00	Call \$
<b>UHF</b>		
IC-475A/H 25/75w All Modes	1399./1599	Call \$
IC-48A FM Mobile 25w	509.00	Call \$
IC-4SAT Micro Sized HT	449.00	Call \$
IC-4GAT, New 6w HT	449.95	Call \$
IC-04AT FM HT	449.00	Call \$
IC-32AT Dual Band Handheld	629.95	Call \$
IC-3210 Dual Band Mobile	739.00	Call \$
IC-2500A FM, 440/1.2 GHz Mobile	999.00	Call \$
IC-24AT New 2m/440 mini HT	629.95	Call \$
IC-2400 144/440 FM	899.00	Call \$
<b>220 MHz</b>		
IC-3SAT Micro Sized HT	449.99	Call \$
IC-375A All-Mode, 25w, Base Sta.	1399.00	Call \$
<b>1.2 GHz</b>		
IC-12GAT Super HT	529.95	Call \$

## KENWOOD TS-950SD



HF Equipment	List	Jun's
TS-950SD New Digital Processor HF	\$4399.95	Call \$
TS-940S/AT Gen. Cvg. Xcvr	2499.95	Call \$
TS-440S/AT Gen. Cvg. Xcvr	1449.95	Call \$
TS-140S Compact Gen. Cvg. Xcvr	949.95	Call \$
TS-680S HF Plus 6m Xcvr	1149.95	Call \$
TL-922A HF Amp	1982.95	Call \$
<b>Receivers</b>		
R-5000 100 kHz - 30 MHz	1049.95	Call \$
R-2000 150 kHz - 30 MHz	799.95	Call \$
RZ-1 Compact Scanning Rcvr.	599.95	Call \$
<b>VHF</b>		
TS-711A All Mode Base 25w	1059.95	Call \$
TR-751A All Mode Mobile 25w	669.95	Call \$
TM-231A Mobile 50w FM	459.95	Call \$
TH-225A New 2m HT	399.95	Call \$
TH-26AT Compact 2m HT	369.95	Call \$
TM-731A 2m/70cm, FM, Mobile	749.95	Call \$
TM-621 2m/220, FM, Mobile	729.95	Call \$
TM-701A 25w, 2m/440 Mobile	599.95	Call \$
TH-75A 2m/70cm HT	TBA	Call \$
<b>UHF</b>		
TS-811A All Mode Base 25w	1265.95	Call \$
TR-851A 25w SSB/FM	771.95	Call \$
TM-431A Compact FM 35w Mobile	469.95	Call \$
TH-46AT Compact 440 FM, HT	399.95	Call \$
TH-45AT 5w Pocket HT NEW	389.95	Call \$
TH-55 AT 1.2 GHz HT	524.95	Call \$
TM-531A Compact 1.2 GHz Mobile	569.95	Call \$
<b>220 MHz</b>		
TM-3530A FM 220 MHz 25w	519.95	Call \$
TM-331A Compact Mobile	469.95	Call \$
TH-315A Full Featured 2.5w HT	419.95	Call \$

## YAESU FT-1000D



HF Equipment	List	Jun's
FT-1000D Top Performer	\$4399.00	Call \$
FT-747 GX Economical Performer	889.00	Call \$
FT-757 GX II Gen. Cvg. Xcvr	1280.00	Call \$
FT-767 4 Band New	2299.00	Call \$
FL-7000 15m-160m Solid State Amp	2279.00	Call \$
<b>Receivers</b>		
FRG-8800 150 kHz - 30 MHz	784.00	Call \$
FRG-9600 60-905 MHz	808.00	Call \$
<b>VHF</b>		
FT-411 New 2m "Loaded" HT	406.00	Call \$
FT-212RH New 2m, 45w Mobile	499.00	Call \$
FT-290R All Mode Portable	610.00	Call \$
FT-23 R/T/T Mini HT	351.00	Call \$
<b>UHF</b>		
FT-712RH, 70cm, 35w Mobile	536.00	Call \$
FT-811 70cm built-in DTMF HT	410.00	Call \$
FT-790 R/II 70cm/25w Mobile	681.00	Call \$
<b>VHF/UHF Full Duplex</b>		
FT-736R, New All Mode, 2m/70cm	2025.00	Call \$
FEX-736-50 6m, 10w Module	294.00	Call \$
FEX-736-220 220 MHz, 25w Module	322.00	Call \$
FEX-736-1.2 1.2 GHz, 10w Module	589.00	Call \$
FT-690R MkII, 6m, All Mode, port.	752.00	Call \$
<b>Dual Bander</b>		
FT-4700RH, 2m/440 Mobile	996.00	Call \$
FT-470 Compact 2m/70cm HT	576.00	Call \$
<b>Repeaters</b>		
FTR-2410 2m Repeaters	1154.00	Call \$
FTR-5410 70cm Repeaters	1154.00	Call \$
<b>Rotators</b>		
G-400RC light/med. duty 11 sq. ft.	242.00	Call \$
G-800SDX med./hvy. duty 20 sq. ft.	390.00	Call \$
G-800S same/G-800SDX w/o presets	322.00	Call \$



## ALINCO

DJ-160T  
2 METER H.H.

DR-570T  
2M/70CM MOBILE

DR-510T Dual Band Mobile  
DR-110T 2 Meter Mobile  
DJ-500T 2m/440 HT  
DJ-100T Mini 2 Meter HT



## Heath

HW2P  
2m/440  
MICRO-DELUXE HANDHELD

Call About The Complete  
Line Of Pre-assembled  
And Kit Form Amateur  
Equipment



## JUN'S BARGAIN BOX ICOM'FEST

IC-28H, 2m Mobile List \$499.00  
SALE \$379.95

IC-2AT, 2m Handheld List \$319.95  
SALE \$249.95

IC-3210 Dual Band Mobile List \$739.00  
CALL FOR SUPER SALE PRICE

IC-2400 2m/440 Mobile List \$899.00  
CALL FOR SUPER LOW PRICE

WRITE FOR

# FREE BOOK CATALOG

Ham Radio's Bookstore  
Greenville, NH 03048

111



450 MHz SPECTRUM ANALYZER  
Adapted from Nov. 85 QST article  
by Al Helfrick K2BLA  
Complete Kit Only... \$459.95  
Assembled & Tested... \$799.95

FEATURES: Three digit LED center frequency digital readout. 12 position calibrated scan width 1kHz to 50MHz, switchable bandwidth, wide = 300kHz, narrow = 10kHz. Use your low frequency scope for the display portion. Switchable 10kHz video filter. Variable IF attenuator, LOG output calibrated in 10 db steps.  
CA residents add 6% sales tax. SH: \$4.50 (insured). Foreign orders add 15%.  
For more info or price list, send SASE (45¢)

A&E Engineering

2521 W. LaPalma #K • Anaheim, CA 92801 • 714-952-2114

112

"ONLINE" U.S. CALL DIRECTORY

Hamcall service gives you all hams via your computer & modem. Updated each month! Only \$29.95 per year. Unlimited use - you pay for phone call.

BUCKMASTER PUBLISHING

Route 3, Box 56  
Mineral, Virginia 23117  
703/894-5777 visa/mc 800/282-5628

113

FIGURE 2

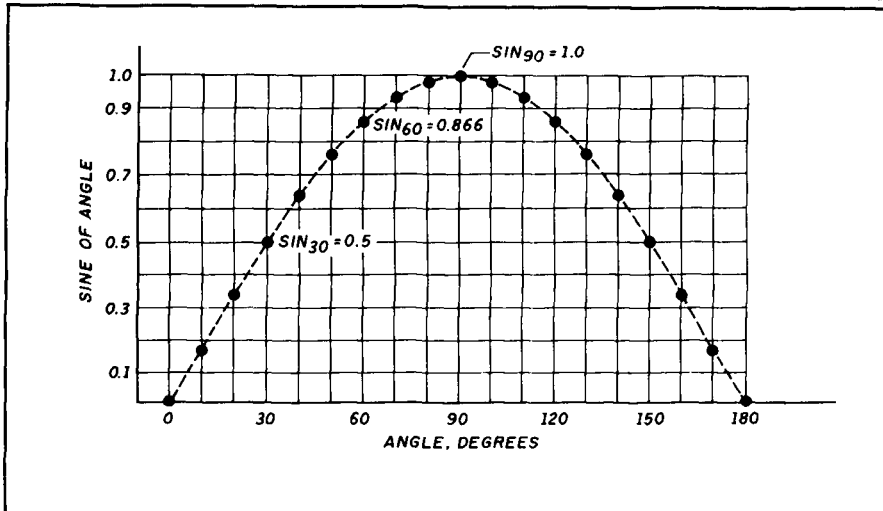

A sine wave can be drawn on quadrille paper by plotting the sine of the angle.

counter emf that's pushing back.\* As a result, current lags behind voltage, as shown in Figure 3. The voltage and current are now "out of phase" with each other. Remember when looking at Figure 3 that time progresses to the right. Although the current is delayed in time with reference to the voltage, it's far easier to express the delay in degrees. This is because the time for one cycle varies, depending on the frequency. For household power, a cycle occurs 60 times per second, or one cycle equals 0.016666 second. At a frequency in the Amateur 80-meter band, a cycle might occur 3.6 million times per second, or approximately 0.000002 second for one cycle. If you use degrees, you don't have to worry about how small the fraction of a second is.

The number of degrees the current lags the voltage depends on the inductance value and the frequency of the AC. If the inductance is very small, say ten or 12 turns of wire on a plastic form, and the AC frequency is very low, like 60 cycles per second (60 Hz), the current lag is undetectable. However, with those same ten turns of wire and a frequency of 500 million cycles per second (500 MHz), the inductance has a very great effect on the current — so great that no alternating current can flow through the coil. (This is the principle behind an RF choke.)

Aha, you caught me trying to sneak a term past you! Inductance. Let's

\* Don't misunderstand what's being delayed here. The counter emf opposes the number of electrons flowing, but doesn't change the speed of those electrons.

FIGURE 3

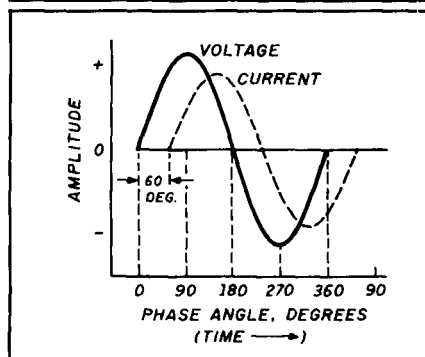

An inductor (coil) causes the current flow to lag behind the voltage, 60 degrees in this example. The voltage and current amplitudes are not drawn to scale.

define it before continuing. Inductance is the tendency of a wire or coil to oppose any change of current flow through it. It does this by using the magnetic field to first oppose a current increase, and then release the energy stored to oppose the current decrease. The unit of inductance is the henry, abbreviated H; smaller units are the millihenry (mH) and microhenry ( $\mu$ H). The units do not take on the "ies" suffix for plural; it's millihenrys, not millihenries.

Inductance is inductance, and it doesn't matter whether you're trying to make AC or DC flow through it — it opposes both. So you need a way to relate its opposition to the frequency involved, because you've seen that the inductance of a ten-turn coil doesn't bother 60 Hz, but completely shuts out 500 MHz. The property that relates inductance and frequency is called

inductive reactance,  $X_L$ . Because inductive reactance tends to limit current flow in a circuit, it is expressed in ohms.

$X_L$  can be calculated at the frequency of interest. For example, a coil with an inductance of 1 mH (0.001 H) at a frequency of 4 MHz (4,000,000 Hz) will have an inductive reactance ( $X_L$ ) of:

$$X_L = 2\pi fL$$

where  $f$  = frequency in Hz  
 $L$  = inductance in henrys (H)

thus:

$$X_L = 6.28 \times 4,000,000 \times 0.001 \\ = 25,120 \text{ ohms}$$

Many circuits have resistance as well as inductive reactance, so it's necessary to find some term that combines the two for ease of calculation. This term is impedance. The symbol for impedance is  $Z$ .

Here's where some of you will get cold chills, blurred vision, and sweaty palms — but hang in there, what follows isn't life threatening (unless you're in the middle of final exams). Impedance is the vector sum of the inductive reactance and the resistance in a circuit.

### Oh, no, not vectors!

I know, I hated vectors too. But like much of life, once you understand them, they're not half bad. To simplify the vector concept a bit, look at a vector as the result of two forces working on the same object. Imagine that you're trying to move a ping-pong ball from your end of the table to the other by blowing on it. At the same time, another person is trying to move the ball from one side to the other in the same way. As a result, the ball takes a path at an angle to both the end and the side of the table. The exact path depends on how hard each of you blows. The amazing thing about vectors is that they add the forces involved. If the other person is at the opposite end of the table instead of the side, the ball might follow a straight path but wouldn't get as far. The opposing negative force counteracts your positive force, and the result is the sum of the two. Thus, if two people were at the other end of the table, the vector could be even more negative, and the ball would go off the table at your end. This



FIGURE 4

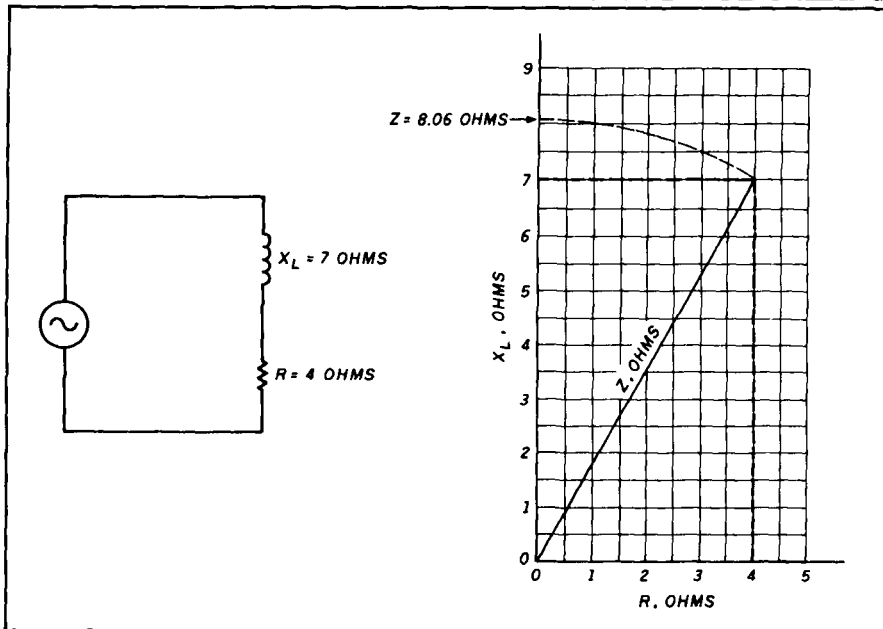

A vector diagram can illustrate the impedance of a circuit with both reactance and resistance.

ability to sum positive and negative forces is important; you'll see more of it in a future column.

Back to the electronic world, before I run out of space. Figure 4 shows an example of a vector used to determine the impedance (Z) of a circuit that has both inductive reactance and resistance. The inductive reactance ( $X_L$ ) is

plotted vertically, and resistance (R) is plotted horizontally. You can do this on ordinary quadrille paper. The hypotenuse represents the impedance, and for this example is approximately 8 ohms.

Impedance can also be calculated by rearranging the formula for finding the hypotenuse in the Pythagorean theorem: "The square of the hypote-

nuse value of a right triangle is equal to the sum of the squares of the values of the other two sides." Or,

$$Z^2 = R^2 + X_L^2$$

Rearranged:

$$Z = \sqrt{R^2 + X_L^2}$$

Using the values from Figure 4:

$$Z = \sqrt{4^2 + 7^2} = \sqrt{16 + 49} = \sqrt{65} = 8.06 \text{ ohms}$$

The vectors can also be used to determine how much the current lags the voltage in a circuit. This is only one of the intriguing things yet to be explored. Stay tuned!

### Conclusion

You've seen how inductance affects alternating current, causing current flow to lag behind the voltage. This is important to engineers when designing power, audio, and RF circuitry. It's also important to you for understanding how a properly designed circuit can provide maximum power transfer between stages of a transmitter, or between your transmitter and an antenna. You'll need another term to help do this — capacitance — which we'll look at in the future. 

## R-4C Enhancements

### MIX-4 Solid State R-4C 3rd Mixer

The Solution to the One Remaining Problem with the Drake / Sherwood R-4C

Noisy 6EJ7 third-mixer tubes have plagued R-4C owners for years. Eliminate frying, crackling, microphonics, and power-line buzz with our newest PC-board module. Easy to install in any R-4C.

Introduced & sold out at '89 Dayton Hamvention.®

### Mobiler's Dream!

Can you use a 6 dB stronger signal? Would an additional 50% more bandwidth be helpful? Our SE-40 mobile antenna is the answer. Handles 600 watts for another 6 dB. SE-40, 40 - 10 meters; SE-75, 75 - 15 meters; SE-160, 160 - 20 meters.

## Sherwood Engineering Inc.

1268 South Ogden Street, Denver, CO 80210  
(303) 722-2257 Monday - Friday 9 A.M. - 5 P.M.

## THE RF CONNECTION

"SPECIALIST IN RF CONNECTORS AND COAX"  
NEW FOR DAYTON 1990

Tired of low quality, unstable VHF/UHF/SHF converters? See the solution at booths 156/157 at the Dayton Hamfest. Linear converters with stable, phased locked LO's. Choice of temperature compensation or ovenized reference crystals. Perfect for lower mounting SHF models. Fully shielded phased locked reference oscillators with dual outputs + 70dbm @ 50 ohms. Phased locked FM only transmitters and receivers.

83-822	PL-259 Teflon, Amphenol	1.75
PL-259/ST	UHF Male Silver Teflon, USA	1.50
UG-21D/U	N Male RG-8, 213, 214, Amphenol	3.25
UG-21B/U	N Male RG-8, 213, 214, Kings	4.00
9913/PIN	N Male Pin for 9913, 9086, 8214 fits UG-21D/U & UG-21B/U N's	1.50
UG-21D/9913	N Male for RG-8 with 9913 Pin	3.95
UG-21B/9913	N Male for RG-8 with 9913 Pin	5.75
UG-146A/U	N Male to SO-239, Teflon USA	6.00
UG-83A/U	N Female to PL-259, Teflon USA	6.00

"THIS LIST REPRESENTS ONLY A FRACTION OF OUR HUGE INVENTORY"

**THE R.F. CONNECTION**  
213 North Frederick Ave. #11  
Gaithersburg, MD 20877

**(301) 840-5477**

VISA/MASTERCARD: Add 4%  
Prices Do Not Include Shipping

# TEN-TEC

All your TEN-TEC needs!  
including *Aries-2* software for the Paragon

## M & N Electronics

RD#1, Box 66 - Orangeville, PA 17859

717-458-6243

SASE for free brochure

(your phone call re-imursed with Radio Order)

# DX Forecaster

By Garth Stonehocker, KØRYW

## DX PROPAGATION SOFTWARE

More and more ham shacks sport computers these days. The popular PCs with up to 640K of on-board computing storage give power that a few years ago was available only in institutions, businesses, and government laboratories. Now Amateurs have new help in logging, operating, and performing computer-aided design of antennas and equipment. Much of the software to accomplish these tasks has been published or advertised for sale in Amateur Radio magazines over the last few years. Today, with the different software packages available, PCs can even be used as aids in propagation prediction.

The early use of lowest and highest usable frequencies (LUF/MUF) predictions was once limited to those who received Amateur Radio magazines or worked where these propagation programs were part of their business activities. (The Institute for Telecommunications Science, with ITS-78 and IONCAP, is one such place.) In December 1982 Navy researchers developed a propagation program called MINIMUF-3. Written in BASIC, this program was made available to Radio Amateurs in the December 1982 issue of *QST*.<sup>1</sup> It calculated the MUF for each hour of the day for any month and the sunspot number for station-to-station paths, by latitude and longitude. The appearance of MINIMUF-3 led to a proliferation of modifications of the MINIMUF program. In most cases the output was changed to do a specific task or produce a more interesting display. *Ham Radio* published such a display modification in February 1987.<sup>2</sup> It showed the MUF as pseudo-concentric contours around a transmitter.

Advertised propagation prediction programs usually cost between \$25 and \$50 and support Commodore, Macintosh, and IBM compatibles. Several of these commercial offerings display the MUF/LUFs on a map of the world. Most have grayline propagation, sunrise/sunset times, and antenna bearings. Typical of these are The DX



Helper by W7HR, The DX Edge,\* and BANDAID/MUFMAP by Heath. Some programs, like MINIPROP by W6EL, include signal level information. The ultimate software for signal and noise levels is W1FN's IONOSOUND. The program determines the signal to noise and reliability of each propagating mode (E, F, or mixed) over the path, at frequencies you select as being most useful for DX. The display simulates an oblique chirp sounder showing the modes. Combining a MUF program with IONOSOUND gives you capabilities similar to those of the ITS-78 and IONCAP programs — with the exception of world noise and antenna patterns. So you can bring the power of the mainframes of a few years ago to your ham shack PC and use it to help find DX openings.

How do you know how "good" these programs are? Play the beacon game. Pick a beacon path close to your DXing path of interest, if possible. If just one beacon frequency is transmitted, the whole diurnal MUF curve for that path will be hard to define. In any case, monitor the frequency until the signal disappears in the afternoon, defining a time point on the curve. If the signal disappears at a later hour the next day, the MUF was probably higher for that time period. Monitor the signal for several days to build up the statistical average. Use the same technique in the morning as the signal arrives. The morning points shouldn't show as much scatter in time as the afternoon's MUF downward curve.

### Last minute forecast

The second and third weeks are the days of high MUFs (high solar flux).

\* Available in C-64 and MS-DOS versions from the HAM RADIO Bookstore for \$34.95 plus \$3.75 shipping and handling.

They may decrease signal strengths but lengthen the nearly daily openings on the higher HF bands, 10 to 20 meters. This month's evening one long hop transequatorial openings to the south could come on the 11th and 19th. Other ionospheric disturbed conditions may exist near the 1st and 28th. The low band east-west paths may have weak signals and QSB caused by the two latter disturbances. The low bands will be best at times of low disturbance.

The perigee of the moon's orbit (for moonbounce DX) is on the 26th, with the moon at full phase on the 10th. There will be a short meteor shower, the Lyrid, on April 20th to 22nd with a rate of five per hour — hardly much help for meteor-scatter DX. But a bigger shower, the Aquarid, starts before the end of April, peaks on the 5th of May, and ends in mid-May. Its rate is 10 to 30 per hour.

### Band-by-band summary

Ten, 12, 15, 17, and 20 meters will be open from morning until late evening most days to most areas of the world. The higher bands open closer to local noon and mainly to southern countries. One long hop openings will probably occur in late evening during high solar flux periods with a mildly disturbed geomagnetic field. The lower of these bands work mainly to the north and south in the evenings.

Thirty, 40, 80, and 160 meters will be open mainly at nighttime. The highest band, 30, is open near dawn and dusk on northern paths. The other band's signals are so absorbed during the day at this high sunspot number (SSN) that DXing is relatively rare. Good nighttime signals are present this time of year with low thunderstorm activity. So, except for an occasional weather frontal passage by your QTH, these conditions should make DXing a joy. Disturbed conditions from the high SSN solar activity may bring weak and fluttery signals from interesting places at night on these bands. **77**

### REFERENCE

1. Robert B. Rose, K6GKU, "MINIMUF: A Simplified MUF-Prediction Program for Microcomputers," *QST*, December 1982, page 36.
2. Henry G. Elwell, Jr., N4UH, "360-Degree MINIMUF Propagation Prediction," *Ham Radio*, February 1987, page 25.

### WESTERN USA

GMT	PST	N	NE	E	SE	S	SW	W	NW
0000	4:00	12	20	12	10	10	10	10	10
0100	5:00	12	20	15	10	10	10	10	10
0200	6:00	12	30	15	10	10	10	10	10
0300	7:00	12	30	15	10	10	10	10	10
0400	8:00	12	17	17	12	12	10	10	12
0500	9:00	15	17	15	12	17	10	10	12
0600	10:00	20	20	12	15	17	10	10	15
0700	11:00	20	20	12	15	20	10	10	17
0800	12:00	20	20	15	15	20	10	10	17
0900	1:00	20	20	15	15	20	10	12	17
1000	2:00	20	30	15	17	20	12	12	20
1100	3:00	30	17	15	15	20	15	15	20
1200	4:00	17	15	10	15	20	15	15	20
1300	5:00	15	12	10	12	20	15	15	20
1400	6:00	15	12	10	10	20	17	17	20
1500	7:00	20	10	10	10	20	17	15	20
1600	8:00	20	10	10	10	15	17	15	20
1700	9:00	20	12	10	10	12	15	17	20
1800	10:00	20	12	10	10	10	12	17	17
1900	11:00	20	12	10	10	10	10	12	15
2000	12:00	30	12	10	10	10	10	10	12
2100	1:00	17	15	10	10	10	10	10	12
2200	2:00	15	15	10	10	10	10	10	12
2300	3:00	12	17	10	10	10	10	10	10

APRIL

### MID USA

GMT	MST	N	NE	E	SE	S	SW	W	NW
0000	5:00	12	20	12	10	10	10	10	10
0100	6:00	12	20	15	10	10	10	10	10
0200	7:00	15	30	15	10	10	10	10	12
0300	8:00	15	30	15	10	10	10	10	12
0400	9:00	20	17	17	12	15	10	10	12
0500	10:00	20	15	15	12	17	10	10	15
0600	11:00	20	20	12	15	17	10	10	17
0700	12:00	20	20	15	15	20	10	10	20
0800	1:00	20	30	15	15	20	10	10	20
0900	2:00	30	30	15	17	20	12	12	20
1000	3:00	30	17	15	15	20	15	12	20
1100	4:00	17	15	12	12	20	15	15	30
1200	5:00	15	12	10	12	20	15	17	17
1300	6:00	15	12	10	10	20	17	15	17
1400	7:00	20	10	10	10	20	15	15	20
1500	8:00	20	10	10	10	15	15	15	20
1600	9:00	20	10	10	10	10	15	15	20
1700	10:00	20	12	10	10	12	17	17	20
1800	11:00	20	12	10	10	10	12	17	20
1900	12:00	20	12	10	10	10	10	12	15
2000	1:00	20	12	10	10	10	10	10	12
2100	2:00	30	12	10	10	10	10	10	12
2200	3:00	20	15	10	10	10	10	10	12
2300	4:00	15	15	10	10	10	10	10	12

### EASTERN USA

GMT	EST	N	NE	E	SE	S	SW	W	NW
0000	7:00	15	20	12	10	10	10	10	12
0100	8:00	15	20	15	10	10	10	10	12
0200	9:00	20	20	15	10	10	10	10	15
0300	10:00	20	30	17	10	15	10	10	17
0400	11:00	20	30	17	12	17	10	10	20
0500	12:00	20	20	15	12	20	10	10	20
0600	1:00	30	30	15	15	20	12	12	20
0700	2:00	30	30	15	15	20	12	12	20
0800	3:00	17	17	17	15	20	12	12	20
0900	4:00	15	15	12	17	20	15	15	30
1000	5:00	12	15	10	15	20	15	15	17
1100	6:00	12	12	10	12	20	17	17	17
1200	7:00	12	12	10	10	20	15	15	17
1300	8:00	12	12	10	10	20	15	15	20
1400	9:00	12	10	10	10	20	15	15	20
1500	10:00	15	10	10	10	15	17	15	20
1600	11:00	17	10	10	10	12	17	17	20
1700	12:00	20	12	10	10	12	12	17	20
1800	1:00	20	12	10	10	10	10	12	17
1900	2:00	20	12	10	10	10	10	12	15
2000	3:00	20	12	10	10	10	10	10	12
2100	4:00	30	15	10	10	10	10	10	12
2200	5:00	20	17	10	10	10	10	10	12
2300	6:00	15	20	12	10	10	10	10	12

# RF POWER TRANSISTORS

We stock a full line of Transistors & Tubes for amateur, marine, and business radio servicing



## Partial Listing of Popular Transistors in Stock

P/N	Net/Ea	P/N	Net/Ea	P/N	Net/Ea
BFR96	\$ 2.75	MRF1946A	\$17.00	LOW NOISE FIGURE	
CC2664A	26.50	PT6619	19.75	MGF1402	\$17.95
ECCG340	3.40	PT9847	22.75	MRF901	1.50
MRF134	16.00	RF120	21.00	MRF911 & 966	2.50
MRF136	21.00	SD1229	12.00	NE25537/25K205	3.25
MRF136Y	47.00	SD1272	12.00	NE4137/35K124	3.25
MRF137	24.00	SD1278-1	13.75	U309 & U310	1.75
MRF138	35.00	SD1405	16.00	2N4416 & J310	1.00
MRF141G	190.00	SD1407	25.00	3N204 & 3N211	2.00
MRF148	34.00	SD1428	29.50	OUTPUT MODULES	
MRF150	79.50	SD1429-3	16.00	(Partial listing only - call for numbers not listed)	
MRF151G	179.50	SFR2072	12.75	SAU4 440 LIN	49.50
MRF153	395.00	SFR3662	29.50	SAV6 158	42.50
MRF156	537.00	SFR3775	13.00	SAV7 144 HT	42.50
MRF171	34.50	SFR3800	17.50	SAV12 144 HT	23.50
MRF172	58.75	2N1522	11.95	SAV15 222	58.75
MRF174	80.00	2N3553	3.00	SAV17 144 50W	66.50
MRF208	16.50	2N3771	3.50	M57713 144 LIN	49.50
MRF212	19.50	2N3866	1.25	M57726 144	59.95
MRF221	12.00	2N4048	11.95	M47727 144	69.50
MRF224	16.00	2N4427	1.25	M57729 440	69.95
MRF237	2.00	2N5109	1.75	M57732L	33.00
MRF238	16.00	2N5179	1.00	M57737 144	48.50
MRF239	17.00	2N5589	13.00	M57741 LM/H	57.00
MRF240,A	16.50	2N5591	14.50	M57745	89.95
MRF245	32.00	2N5641	16.00	M57755	78.75
MRF247	24.75	2N5642	16.50	M57762 1296	69.75
MRF248	35.00	2N5643	19.00	M57764 806	74.00
MRF260	10.00	2N5944	11.00	M57712.M57733 use	
MRF261	10.50	2N5945	10.00	SC1027 90U SAU4	
MRF262	10.50	2N5946	12.50	MHW710-1,2,3	61.00
MRF264	12.50	2N6080	9.00	MHW820-1	76.00
MRF309	60.00	2N6081	11.00	MHW820-2	82.00
MRF314A	33.00	2N6082,3,4	14.75	SPECIAL TUBES	
MRF315A	32.50	2N6097	20.00	6CA7/EL34	13.95
MRF316	64.50	2N6255	2.50	6CL6	11.75
MRF317	63.00	2SB754	2.50	6GK6	9.95
MRF327	62.00	2SC730	4.50	6HF5 GE	14.95
MRF406	13.50	2SC1307	4.75	6JB6 GE	15.95
MRF412	22.00	2SC1729	16.25	6JS6 GE	15.95
MRF421	26.50	2SC1945	5.75	6KD6 GE	18.95
MRF422	36.00	2SC1946	18.75	6L6GC	11.95
MRF427	17.00	2SC1946A	16.75	6LF6 GE	16.95
MRF428	50.00	2SC1947	9.75	6LQ6 6MJ6	15.95
MRF429	39.00	2SC1955	9.00	12B7A	11.75
MRF433	11.00	2SC1957	1.00	5728/T160L	69.95
MRF448	73.50	2SC1969	2.50	Match Set/2	149.75
MRF449	22.50	2SC1971	4.50	Match Set/4	299.50
MRF450	18.25	2SC2028	1.95	75B1A/KT66	16.95
MRF450A	13.50	2SC2029	2.50	811A	15.95
MRF453	18.50	2SC2094	18.50	Match Set/2	37.90
MRF454	14.00	2SC2097	28.00	Match Set/4	75.80
MRF454A	17.00	2SC2097MP	62.00	813	44.75
MRF455	11.25	2SC2099	29.50	833A	89.75
MRF455A	12.75	2SC2166C	2.00	833C	99.75
MRF458	20.00	2SC2221	8.25	845	58.90
MRF475	6.75	2SC2237	7.00	M2057 GE	22.75
MRF476	4.00	2SC2284A	24.75	5894	44.95
MRF477	14.75	2SC2289	13.75	6146B	14.95
MRF479	13.75	2SC2290	14.75	6550A	39.95
MRF485MP	19.75	2SC2290MP	39.50	7581/KT66	16.95
MRF492	14.75	2SC2783	28.50	8950	19.50
MRF497	18.75	2SC3101	12.25	3-500Z	114.75
MRF515	2.50	2SC2312C	4.75	4CX250B	79.95
MRF555	3.00	2SC2379	31.25	4CX300A	142.25
MRF557	5.25	2SC2509	9.00	4CX1000A	459.95
MRF559	2.25	2SC2539	19.75	8877	599.50
MRF607	2.50	2SC2559	28.25	TUMAC TUBES	
MRF629	3.25	2SC2630	23.00	8874	359.50
MRF630	3.75	2SC2640	15.00	8875	399.95
MRF641	20.50	2SC2641	16.00	3CX800A7	339.95
MRF644	23.00	2SC2642	28.25	3CX1200A7	469.00
MRF646	26.00	2SC2694	46.75	3CX1500A7	699.50
MRF648	31.00	2SC2695	31.75	3CX3000A7	719.95
MRF660	13.25	2SC2782	32.75	4CX250B	99.95
MRF843,F	21.00	2SC2879	21.00	4CX350A	199.50
MRF846	37.75	2SC2904	32.50	3-500Z	134.75
MRF873	28.75	2SC2905	34.50	4-400C	159.95
MRF1946	15.00	40582	9.50		

## ADVERTISER'S INDEX AND READER SERVICE NUMBERS

Listed below are the page and reader service number for each advertiser in this issue. For more information on their products, select the appropriate reader service number make a check mark in the space provided. Mail this form to ham radio Reader Service, I.C.A., P.O. Box 2558, Woburn, MA 01801.

Name \_\_\_\_\_ Call \_\_\_\_\_

Address \_\_\_\_\_

City \_\_\_\_\_ State \_\_\_\_\_ Zip \_\_\_\_\_

\* Please contact this advertiser directly. Please use before May 31, 1990

We'd like to see your company listed here too. Contact Martin Durham at 603-878-1441 or FAX 603-878-1951 to work out an advertising program tailored to suit your needs.

READER SERVICE #	PAGE #	READER SERVICE #	PAGE #
112 - A & A Engineering	85	136 - Jensen Tools Inc	59
115 - Ace Communications, Monitor Div	80	111 - Jun's Electronics	85
121 - Ace Systems	77	171 - Kantronics	13
135 - Advanced Receiver Research	59	119 - KComm, The Ham Center	78
173 - AEA	51	Kenwood USA Corporation	2, 5, 7, CIV
118 - Aerospace	78	158 - Madison Electronics Supply	39
165 - Alinco Electronics Inc	31	Maggiore Electronic Laboratory	50
163 - Alpha Delta Communications Inc	32	110 - M & N Electronics	87
128 - Aluma Tower Co	71	140 - Glen Martin Engineering, Inc	56
Amateur Television Quarterly	40	176 - The Meadowlake Corp	62
159 - AMC Sales, Inc	39	172 - MFJ Enterprises	8
164 - American Reliance	32	155 - Mirage/KLM	43
126 - AMSAT	71	108 - Missouri Radio Center	91
142 - Antique Radio Classified	56	154 - Monitoring Times	45
168 - Astron Corp	22	114 - NCG	80
Barker & Williamson	51	Nemat Electronics	32
Barry Electronics	69	Nuts & Volts	62
132 - Bilal Company	67	Omega Electronics	78
Brian Beezley, K6STI	71	107 - OPToelectronics	92
157 - Buckmaster Publishing	40	148 - P.C. Electronics	51
131 - Buckmaster Publishing	67	120 - Pac-Comm Packet Radio Systems, Inc	77
Buckmaster Publishing	77	162 - Palomar Engineers	35
117 - Buckmaster Publishing	81	147 - Periphex Inc	53
113 - Buckmaster Publishing	85	124 - Ramsey Electronics, Inc	75
166 - C&S Sales	28	153 - RF Concepts	45
129 - Certified Communications	67	109 - The RF Connection	87
160 - Coaxial Dynamics Inc	39	RF Parts	90
144 - Communication Concepts, Inc	55	125 - Rutland Arrays	72
161 - Communications Specialists	37	Sherwood Engineering Inc	87
143 - Crystek Crystals	55	141 - Software Systems	56
127 - Cygnus-Quasar Books	71	130 - Software Systems	67
Dayton Hamvention	16	116 - Stridsburg Engineering Co	80
Digital Digest	53	151 - STV/OnSat	48
137 - Doug Hall Electronics	59	122 - Synthetic Textiles, Inc	77
169 - Down East Microwave	19	156 - TE Systems	40
Engineering Consulting	59	139 - Tel-Com	56
149 - GAP Antenna Products	48	145 - US Consumer—Super Ear	55
152 - Ham Radio Outlet	46, 47	123 - Vanguard Labs	77
Ham Radio's Bookstore	45, 50, 65, 72, 78, 80	138 - VHF Communications	59
134 - Hamtronics, NY	61	146 - W & W Associates	53
Hamtronics, PA	80	W5YI Marketing	62
167 - Henry Radio	27	175 - Wilam Technology	62
174 - ICOM America, Inc	CII	Yaesu USA	CIII
170 - ICOM America, Inc	15	150 - E. H. Yost	48

Prices Subject to Change Without Notice

MATCHED & SELECTED TUBE AND TRANSISTOR FINALS IN STOCK FOR AMATEUR AND COMMERCIAL EQUIPMENT

Orders received by 1 PM PST shipped UPS same day.

Next day UPS delivery available - We Export

No extra charge for C.O.D. (cash) or VISA/MC Orders

Ship/Hand. 1 lb. U.S. or Foreign Sm Pkt Air 8 oz. \$5.00

Minimum Order \$20 Quantity Pricing Available

ORDERS ONLY - (800) 854-1927 - NO TECHNICAL

ORDER LINE - INFORMATION - TECH HELP  
(619) 744-0728

FAX 619-744-1943



# RF PARTS

1320 Grand Avenue  
San Marcos, CA 92069



**ORDER  
TOLL-FREE  
1-800-821-7323**

**DEPENDABLE SERVICE  
AT THE RIGHT PRICE . . . EVERYTIME**

MasterCard—VISA—Discover—COD

*Missouri*  
**RADIO CENTER**

**KENWOOD**



**TS-950SD**  
TRANSMIT THE ULTIMATE SIGNAL  
• Digital Signal Processing  
• Dual Frequency Receive  
• Digital AF Filter • 100 Memories  
**CALL FOR DETAILS AND  
ORDER TODAY!**

**YAESU**



**FT-1000**  
THE BEST OF THE BEST  
• 200 Watts Output  
• All Amateur Bands  
• Dual Receive  
• DDS-Direct Digital Synthesis  
**CALL FOR ALL THE DETAILS!**

**ICOM**



**IC-765** NEW HF TRANSCEIVER  
• Built-in Automatic Antenna  
Tuner and Power Supply  
• 99 Memories • 100 W Output  
• 160-10M/General Coverage  
Receiver  
• Band Stacking Registers

**ALINCO**



**DR-570T**  
VHF/UHF TWIN BANDER  
• 45W on 2M/35W on 70cm  
• Receive on both  
Bands at Same Time  
• Extended Receiver Range  
• More Features for the Money  
Than Anyone Else  
**CALL TODAY!**

**KENWOOD**



**TS-140S** AFFORDABLE DX-ing!  
• HF Transceiver With  
General Coverage Receiver  
• All HF Amateur Bands  
• 100 W Output  
• Compact, Lots of Features

**YAESU**



**FT-736R** VHF-UHF BASE STATION  
• SSB, CW, FM on 2 Meters  
and 70 cm  
• Optional 50 MHz, 220 MHz or  
1.2 GHz  
• 25 Watts Output on 2 Meters,  
220 and 70 cm  
• 10 Watts Output on 6 Meters  
and 1.2 GHz • 100 Memories

**ICOM** **IC-725**  
NEW ULTRA-COMPACT  
HF TRANSCEIVER



• USB/LSB/CW, AM Receive  
Optional Module for AM  
Transmit and FM TX/RX  
• 160-10M Operation • 100 W Output  
• Receive 30 kHz to 33 MHz  
• 26 Memories with Band  
Stacking Registers

**AMERITRON**



**AL-80A AMPLIFIER**  
• Full Kilowatt Output  
• 160-15 Meters  
• 3-500 Z Tube for Maximum Life  
• Precise and Easy Tuning  
• Step-Start Inrush Protection™  
**SPECIAL SALE!**

**KENWOOD**



**TH-225A**  
HIGHER POWER 2 METER H.T.

- Now 5 Watts Output
- Odd Off Sets
- Wideband Frequency  
Coverage
- Same Accessories  
as TH-215

**CALL TODAY!**

**YAESU**



**FT-470**  
COMPACT DUAL BAND  
FM HANDHELD  
(2M/70CM)  
21 Memories for Each Band  
Dual VFO's for Each Band  
Up to 5 Watts Power  
Built-in CTCSS  
Built-in 10-Memory DTMF  
Autodialer

**ICOM** **IC-24AT**  
COMPACT DUAL BAND, FM

- 140-150 MHz;  
440-450 MHz
- 5W Output
- Crossband Full  
Duplex
- 40 Double-Spaced  
Memories
- 4 DTMF Code Memories

**CHECK OUT ALL THE FEATURES!**

**ASTRON**



- RS7A . . . \$49
- RS12A . . . \$70
- RS20A . . . \$89
- RS20M . . . \$109
- VS20M . . . \$124
- RS35A . . . \$139
- RS35M . . . \$159
- VS35M . . . \$174
- RS50A . . . \$199
- RS 50M . . . \$219
- RM50M . . . \$259
- VS50M . . . \$232

**uniden**  
HOT WINTER SPECIAL



**HR-2600** 10 Meter Mobile  
**\$229.95** Delivered  
Great Deals On Scanners Too!  
**CALL**



**PK-232**  
MULTI-MODE TNC  
• AMTOR, ASCII, Baudot, CW,  
FAX, NAVTEX, Packet  
• PAKMAIL™ Mailbox With  
Third Party Traffic  
• Two Radio Ports  
**THE ORIGINAL MULTI-MODE TNC**

**ICOM**

**2 Meter Sale**

Your Favorite Mobiles At  
Tremendous Savings!

- IC-228A, 25 watts
- IC-228H, 45 watts
- IC-28A, 25 watts
- IC-28H, 45 watts

**DON'T WAIT—CALL TODAY  
SAVE SAVE SAVE**

**MFJ SALE MFJ**

LARGEST STOCK OF ALL  
YOUR MFJ FAVORITE  
ACCESSORIES  
CALL TODAY FOR  
BEST PRICE



**MFJ-1278**  
Multi-Mode Data Controller  
CALL FOR EXTRA SAVINGS

102 N.W. Business Park Lane Kansas City, MO 64150  
Send SASE For Used List

Call Toll Free—9am - 6pm Mon.-Fri. 9am - 2pm Sat.  
In Missouri Call—816-741-8118

CUSHCRAFT • DIAMOND

**WANTED: QUALITY USED GEAR, CASH OR TRADE**

HUSTLER • HYGAIN

ICOM • KANTRONICS • KENWOOD • MFJ • MIRAGE/KLM • RFOCONCEPTS • UNIDEN • YAESU

# Now Look What Hand Held Frequency Counters Can Do!

## New from OPTOELECTRONICS



Introducing two advanced hand held frequency counters incorporating many unique features usually found only on laboratory bench counters.

These counters are designed for virtually every measurement application from DC through Microwave including measuring RF transmission frequencies at the maximum possible distance.

The UTC 3000 does all of this and is also the world's first Hand Held universal counter timer with Period, Time Interval, and Ratio measurement capability.

- 10 Digit LCD Display with Gate, Function, and Input Annunciators.
- Direct count (1 Hz resolution in 1 Sec) to over 150 MHz.
- 16 Segment Bargraph displays Input Signal Level. Ensures reliable counting, proven effective in locating concealed transmitters.
- High Accuracy, 1 ppm 10 MHz Crystal Time Base is standard with optional 0.2 ppm TCXO available.
- More usable Sensitivity than in any other counter for efficient antenna pick up measurements.
- Four push button selectable Gate times.
- Ni-Cad battery pack and AC adapter-charger included.

**In addition, The Model UTC3000 features:**

- In addition to Frequency, additional Functions include: Period, Ratio, and Time Interval and Average.
- Single Shot Time Interval 100 ns, .1 ns averaged.
- Two input channels with High Impedance and 50 ohm input



Also Available from Optoelectronics, 8 Digit LED Hand Held Frequency Counters:

- Model 2210 10 Hz - 2.2 GHz General Purpose Audio to Microwave \$219
- Model 1300H/A 1 MHz - 1.3 GHz RF Counter \$169
- Model CCB Relative RF Signal Strength Bar Graph Meter With 10 Segment LED Display \$99

- Model 2600H ..... \$325
- Model UTC 3000 ..... \$375
- Model TCXO-30 ..... \$ 80
- Model TAI00S Telescoping Whip Antenna ..... \$ 12

**OPTOELECTRONICS INC.**  
5821 N.E. 14th Avenue, Fort Lauderdale, Florida 33334

1-800-327-5912 • FL (305) 771-2050 • FAX (305) 771-2052

# YAESU

## Power ... and More!

### FT-212RH

#### Frequency Synthesized VHF/UHF FM Transceiver

The compact, versatile FT-212RH is a 45 watt, 2 meter mobile that boasts a lot more than just high power. Inside its sturdy compact frame hides an impressive array of performance features plus high reliability...like 18 general purpose memories; one-touch call channel memory; two scanning range memories; CTCSS on any of the 37 standard tone frequencies may be programmed into any memory channel. Choice of standard, or optional, high performance tone encoding microphones. The FT-212RH and its 35 watt UHF counterpart, the FT-712RH are packed with state-of-the-art refinements... power and more!



- **Frequency Range:** 140-174 MHz on receive (144-148 MHz TX—Modifiable for MARS and CAP). Specifications guaranteed on amateur bands only.
- **Power Output:** 45 watts output with selectable 5 watt low power.
- **CTCSS:** Access any of the 37 standard CTCSS tone frequencies, plus 97.4 Hz can be displayed, selected and programmed into any memory for transmission.
- **19 Memories:** Each memory stores either programmable repeater shift or independent TX and RX frequencies.

- **Automatic Repeater Shift (ARS):** Enables selection of repeater transmitter offset automatically when tuned to a standard repeater subband.
- **Programmable Scanning:** Scans band, band segment or

memories. Scan auto-resume with carrier drop or after 5-second pause.

- **Tuning Steps:** Operator selectable steps in 5, 10, 12.5, 20 and 25 KHz increments.
- **CAT System Control:** Provides for external control of VFO frequency, mode and memory functions from operator's personal computer.
- **Amber Backlit LCD Display:** Automatically controls the brightness of the display back-lighting and pilot lamps.
- **Tone Encoding Microphone:** Choice of standard, or optional high performance DTMF tone encoding microphones.
- **Digital Voice System (DVS-1):** Optional system which allows local and remote digital voice recording and playback.



### FT-4700RH

#### Dual Band VHF/UHF Trunk Mountable FM Transceiver

- **Frequency Range:** 140-174 MHz on 2m (modifiable for MARS and CAP); 430-450 MHz on 70cm.
- **Power Output:** 50 watts on 2m; 40 watts on 70cm. Selectable 5 watts low power on both bands.
- **Full Duplex Cross Band Operation:**
- **Dual Receive:**
- **CTCSS Encode/Decode:**
- **Remote Control Kit Included:**
- **Amber Backlit LCD Display and controls with dimmer switch.**
- **20 Memories:**
- **Dual Antenna Ports:**
- **Programmable Scanning:**
- **MH-15C8 Mic standard; MH-15D8 Mic optional.**

For information on these and Yaesu's full line of products, call our literature desk toll-free at 1 (800) 999-2070.

**YAESU**  
*Performance without compromise.*



# KENWOOD



## TS-950SD

"DX-clusive" HF Transceiver

The new TS-950SD is the first Amateur Radio transceiver to utilize Digital Signal Processing (DSP), a high voltage final amplifier, dual fluorescent tube digital display and digital meter with a peak-hold function.

- **Dual Frequency Receive Function.** The TS-950SD can receive two frequencies simultaneously.
- **New! Digital AF filter.** Synchronized with SSB IF slope tuning, the digital AF filter provides sharp characteristics for optimum filter response.
- **New high voltage final amplifier.** 50 V power transistors in the 150-watt final section, resulting in minimum distortion and higher efficiency. Full-power key-down time exceeds one hour.
- **New! Built-in microprocessor controlled automatic antenna tuner.**
- **Outstanding general coverage receiver performance and sensitivity.** Kenwood's Dyna-Mix™ high sensitivity direct mixing system provides incredible performance from 100 kHz to 30 MHz. The Intermodulation dynamic range is 105 dB.
- **Famous Kenwood Interference reduction circuits.** SSB Slope Tuning, CW VBT (Variable Bandwidth Tuning), CW AF tune, IF notch filter, dual-mode noise blander with level control, 4-step RF attenuator (10, 20, or 30 dB), switchable AGC circuit, and all-mode squelch.

Complete service manuals are available for all Kenwood transceivers and most accessories. Specifications, features and prices subject to change without notice or obligation.

## The Ultimate Signal.

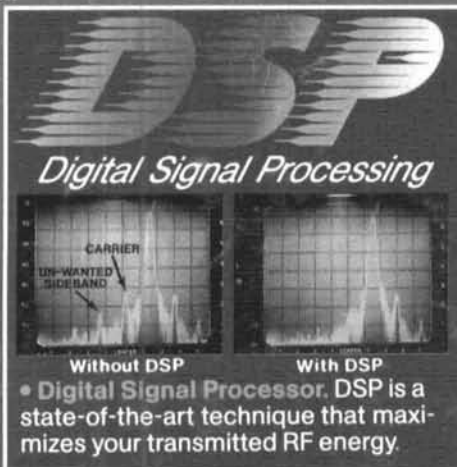

- **High performance IF filters built-in†** Select various filter combinations from the front panel. For CW, 250 and 500 Hz, 2.4 kHz for SSB, and 6 kHz for AM. Filter selections can be stored in memory!
- **Multi-Drive Band Pass Filter (BPF) circuitry.** Fifteen band pass filters are available in the front end to enhance performance.

- Built-in TCXO for the highest stability.
- Built-in electronic keyer circuit.
- 100 memory channels. Store independent transmit and receive frequencies, mode, filter data, auto-tuner data and CTCSS frequency.
- Digital bar meter.

**Additional Features:** • Built-in interface for computer control • Programmable tone encoder • Built-in heavy duty AC power supply and speaker • Adjustable VFO tuning torque • Multiple scanning functions • MC-43S hand microphone supplied

### Optional Accessories

- DSP-10 Digital Signal Processor \*
- SO-2 TCXO \* • VS-2 Voice synthesizer
- YK-88C-1 500 Hz CW filter for 8.83 MHz IF \*
- YG-455C-1 500 Hz CW filter for 455 kHz IF \*
- YK-88CN-1 270 Hz CW filter for 8.83 MHz IF \*
- YG-455CN-1 250 Hz CW filter for 455 kHz IF \*
- YK-88SN-1 1.8 kHz SSB filter for 8.83 MHz IF \*
- YG-455S-1 2.4 kHz SSB filter for 455 kHz IF \*
- SP-950 External speaker w/AF filter
- SM-230 Station monitor w/pan display
- SW-2100 SWR/power meter
- TL-922A Linear amplifier (not for QSK)

\* Built-in for the TS-950SD

† Optional for the TS-950S

KENWOOD U.S.A. CORPORATION  
COMMUNICATIONS & TEST EQUIPMENT GROUP  
P.O. BOX 22745, 2201 E. Dominguez Street  
Long Beach, CA 90801-5745  
KENWOOD ELECTRONICS CANADA INC.  
P.O. BOX 1075, 959 Gana Court  
Mississauga, Ontario, Canada L4T 4C2

## KENWOOD

...pacesetter in Amateur Radio

