

Ideas @ Projects for QRP

Published by free e- magazine AntenTop
Prepared by RK3ZK @ Co
www.antentop.org

TORONTO, CANADA

2006

Ideas @ Projects for QRP is a compilation of articles congenial to QRP published on 2003- 2005 years at free e- magazine **AntenTop**

Your donations to **AntenTop** are welcome! Ever 1 cent (that is nothing for you) is great deal for **ANTENTOP, FREE e - magazine!**

Please, use **Paypal**

<http://www.paypal.com/>



To: igor.grigorov@gmail.com

Thank You,

Igor Grigorov

*Donations for **AntenTop** is Real Help for Hams all over the World!*

The book may be placed **Free** on to amateurs websites or CD only with permission **AntenTop** (antentop@antentop.org).

For copyright see www.antentop.org

No restriction for private and education purpose.

CONTENTS:

Chapter 1
Antennas HF

Chapter 2
Antennas VHF

Chapter 3
Receiving Antennas

Chapter 4
ATU

Chapter 5
Radio Wave Propagation

Chapter 6
Transceivers for QRP

Chapter 7
QRP TX

Chapter 8
QRP RX

Chapter 9
QRP PA

Chapter 10
Keys for QRP

Chapter 11
QRP Story

Chapter 12
Antenna Tools

SUPPLEMENTARY

CHAPTER 1
HF- Antennas

Balcony Antenna // by Harry Lythall, SM0VPO..... 1- 1

Balcony Antenna Extension // by Harry Lythall, SM0VPO..... 1- 2

Multirange Vertical Antennas // by Igor Grigorov, RK3ZK.....1- 4

**Practical Design of Open Sleeve Antennas
for Upper Amateur HF- Ranges // By Dmitry Fedorov, UA3AVR.....1- 7**

Multi- Range Vertical Antenna UA1DZ // by Igor Grigorov, RK3ZK.....1 -8

Hula- Hoop magnetic Loop // by Yuri Kazakevich, EW6BN.....1- 9

**A Helical Loop Antenna for the 20-meters Band
// By Vladimir Kuz'min, UA9JKW.....1-11**

Top Load at Vertical Antennas // by Igor Grigorov, RK3ZK.....1-12

Three Band Universal RZ3AE Antenna // Evgeniy, RZ3AE.....1- 14

**Fast Made a Half – Wave Antenna for 80 Meters
// by Igor Grigorov, RK3ZK.....1- 15**

**Window Dipole Antennas with Capacitive Loads
for the 6 and 10 Meters Bands
// by Igor Grigorov, VA3ZNW.....1-17**

**J - Antenna for 160,15 and 10(FM) meters
// by Valentin Gvozdev , RU3AEP.....1- 27**

Multirange Trap Antennas // by Igor Grigorov, RK3ZK1- 32

A Five Bands Vertical Trap Antenna // M. Chirkov, UL7GCC.....1-47

Dipole Nadenenko // By Radio 1959.....1- 48

RBM Radio // by Igor Grigorov, RK3ZK.....1- 52

Half-Loop Antennas // Jean-Pierre GOUIN & Daniel LAFARGUE.....1- 58

**Old Military HF- Antennas of Communication Cars
// by Igor Grigorov, RK3ZK.....1- 65**

CHAPTER 1
HF- Antennas

Modern Military HF- Antennas of Communication Cars
// by Igor Grigorov, RK3ZK.....1- 70

Field Universal HF Antenna RV3DA // by Igor Grigor'ev, RV3DA.....1- 75

Shunt Vertical Universal HF Antenna // by Igor Grigorov, RK3ZK.....1- 87

CHAPTER 2
VHF – Antennas

Antenna X200 by UA9CR2- 1

“Bottle” Antenna for 145 MHz // by Sergey Mironov, RA1TW.....2- 3

5/8 Lambda VHF- UHF-Antenna // Alex, RA3GBQ.....2- 5

Short ‘Rubber Duck’ for VHF/UHF Hand – Held // by Igor, UA6HJG.....2- 6

Twins Delta Loop for 145 MHz // by Nick V. Derenko, US8AR2- 7

RN1NZ VHF Antenna // by RN1NZ.....2- 9

Folding 3-el YAGI for Mountains // Igor, UA6HJG..... 2- 10

Simple 430-MHz 3-el YAGI for Mountains // Igor, UA6HJG.....2- 11

Simple 430-MHz 4-el YAGI for Mountains // Igor, UA6HJG.....2- 12

4-Ovals Antenna for 430- 440 –MHz // Igor, UA6HJG.....2- 13

CHAPTER 3
Receiving Antennas

Old Receiving Magnetic Loop Antennas // by Igor Grigorov, RK3ZK.....3- 1

CHAPTER 4
ATU

Something about ATU // by Igor Grigorov, RK3ZK4- 1

CHAPTER 5
Radio Wave Propagation

Aliens do LDE! // by Igor Grigorov, RK3ZK.....5- 1

Einstein Wave or just LDE // by Igor Grigorov, VA3ZNW.....5- 3

Nonlinear Propagation of Radio- Wave in Ionosphere
// by Igor Grigorov, VA3ZNW.....5- 6

Black holes in the Air // by Sergey A. Kovalev,USONE.....5-8

EARTH ACUPUNCTURE. *Feedback on one problem...*
By Igor Grigorov, RK3ZK @ Co.....5- 11

Earth Shadow, propagation related to earth shadow
// by Michael Higgins, EI 0 CL.....5- 19

Antenna – Island // by John Doty.....5- 20

Pedersen ray propagation // By Robert Brown.....5- 22

Antennas in the mountains // by Igor Grigorov, RK3ZK.....5- 24

CHAPTER 6:
QRP TRANSCEIVERS

Three transceivers from Oleg Borodin, RV3GM/QRP
Oleg Borodin, RV3GM/QRP

My First QRP Station.....6- 1

GNOMIK- 80-M QRP- Transceiver.....6- 3

Micro- 80 X- Tall QRP- Transceiver.....6- 4

Simple QRP CW Transceiver for the 20 meters
// by Igor Grigorov, VA3ZNW.....6- 6

A Simple SSB Transceiver // Ashhar Farhan6- 9

CHAPTER 7:
QRP TX

80/40 meter CW Transmitter with 6BM8/ECL82
by Jan, SM5GNN.....7- 1

Simple QRP TX for the 40 meters // by U- QRP- C Book # 3.....7- 3

**CHAPTER 8:
QRP RX**

A Regenerative Receiver with 6SN7GT // by Jan, SM5GNN.....8- 1

Simple Regenerative Receivers // by U- QRP- C Book # 3.....8- 2

**CHAPTER 9:
QRP PA**

QRP PA for the 10 meters // by U- QRP- C Book # 3.....9- 1

**CHAPTER 10:
KEYS for QRP**

Keys for QRP- expeditions // by Igor Grigorov, RK3ZK.....10- 1

Home Made Key for FT- 817 // by Yuri Murashev, RX3AEW.....10- 3

**CHAPTER 11:
QRP STORY**

QRP beyond belief // by Igor Grigorov, RK3ZK.....11- 1

QRP Tales // by Alexei Rusakov, UA4ARL11- 3

A QRP- QSO without an Antenna // by RV3GM.....11- 5

**CHAPTER 12:
ANTENNA TOOLS**

Tool for Pulling Guys // by Victor. RN9FAB.....12- 1

Fastening of Guys // by Nick V. Derenko, US8AR.....12- 2

Wooden Struts // by Igor Grigorov, RK3ZK.....12- 3

Parameters of Coaxial Cables.....12- 4

SUPPLEMENTARY

The hAmTX Power Supply // by Paulo Ferreira CT2ILQ.....S- 1

27 and 145 MHz CommunicationS- 4

Wire Metric Diameter/Gauge Standard.....S- 5

Color Code for Resistors and Capacitors.....S- 6

The Complete Smith Chart.....S- 8

HF ANTENNAS

Balcony Antenna

by Harry Lythall - SM0VPO

mailto: sm0vpo@telia.com

Credit Line: <http://web.telia.com/~u85920178/>

Many amateurs are very restricted with the space they have available for HF antennas. I have documented a short antenna for the HF bands, but here is a simple method of mounting it, and a method of further reducing the physical length. I used to use an old CB (27 MHz) half-wave antenna which had a broken matching coil. This I used as a 1/4 - wave antenna for 14 MHz, after removing the matching coil. Today I find that CB antennas have increased in price, so I have found a cheap replacement that can be fitted to the balcony of apartment dwellers.

THE ANTENNA

Above is the side view of a bracket, which can be thrown together in a couple of hours and gives surprisingly results. I use six sections for the antenna itself, each of which is 1 meter long. Each section fits inside the previous section by exactly 10 cm. The last section is adjusted so that total length of the antenna is 5.35 meters. This resonates at 14.1750 MHz. I used the following aluminum tubes:-

section 1 : 31 mm Dia. Wall thickness = 2.0 mm. (bottom section)

section 2 : 25 mm Dia. Wall thickness = 2.0 mm.

section 3 : 20 mm Dia. Wall thickness = 1.5 mm.

section 4 : 15 mm Dia. Wall thickness = 1.5 mm.

section 5 : 10 mm Dia. Wall thickness = 1.5 mm.

section 6 : 6 mm Dia. Wall thickness = 1.0 mm. (top section)

This is shown as item (1) in the drawing above.

THE BRACKET (6) & (2)

The bracket screws on to a handrail of the balcony. In my present situation I have a 7 meter wide terrace with a horizontal handrail, but there are four vertical steel pipes supporting the handrail. The bracket is screwed on to one of these vertical supports (4). The bracket is formed using 3 - 4 mm thick aluminium plate (6) with a 50 mm hole in the center of the top & bottom ends. Bend the plate in two places to prevent the plate becoming weakened. The two ends are each sandwiched in between two nylon blocks (2). Use a chopping board stolen from the kitchen, if you can get away with it. Otherwise, the chopping boards are available from:

IKEA (Sweden)

WOOLWORTHS (UK)

SAFEWAY (USA)

Drill THREE of the nylon blocks, in the center, to fit the

<http://www.antentop.org/> mirror: www.antentop.boom.ru

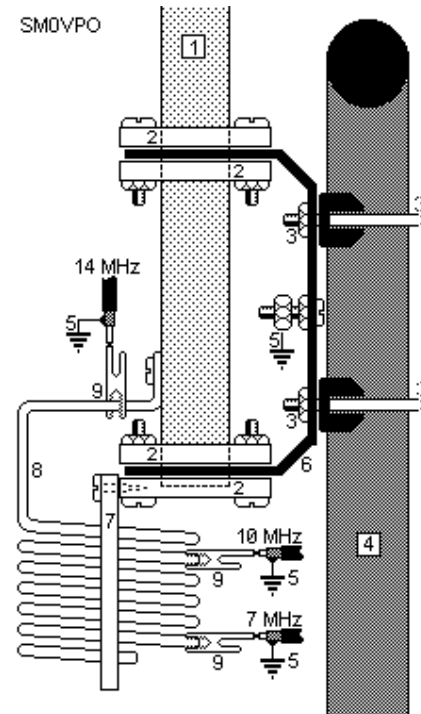

31mm tube (1). The fourth block (bottom) should be drilled with a 5 mm hole to allow water to run out. The bracket is bolted to the balcony handrail, using 35 mm exhaust (muffler) clamps (3).

THE COIL (7) & (8)

This is used to make the antenna resonate at lower frequencies. I wound all my coils using 4mm aluminum wire, but copper hydraulic brake pipe works as well. The coil is 10mm Dia (the same as a tin of DelMonte pineapple chunks)! The coil pitch is 1cm per turn. I used two pieces of plastic conduit (7) to support the coil.

The coil uses about 1 meter of wire/pipe for every three turns. Flatten one end and drill a hole in it for connecting it to the antenna pole (1). If you use aluminum wire, then shorter pieces can be joined together with a brass insert from a car cable connector. Copper tube can easily be soldered.

PROJECTS for QRP

Balcony Antenna

FEEDING THE ANTENNA (5) & (9)

Feed the antenna with 50 ohm coaxial cable, braid connected to the bracket (5) and the center conductor connected to an alligator clip. Select the band using the alligator clip (9):-

0 turns = 14 MHz (20 meter band) (VSWR - almost 1:1)

2 turns = 10 MHz (30 meter band) (VSWR - almost 1:1)

6 turns = 7 MHz (40 meter band) (VSWR - about 1.1:1)

51 turns = 3.8 MHz (80 meter band) (VSWR - about 1.4:1)

53 turns = 3.7 MHz (80 meter band) (VSWR - about 1.4:1)

55 turns = 3.6 MHz (80 meter band) (VSWR - about 1.4:1)

57 turns = 3.5 MHz (80 meter band) (VSWR - about 1.4:1)



Here is a photograph of one of the prototypes in my balcony. In the background you can just make out another one of these antennas, but with a bigger (63 turn) coil.

OTHER INFORMATION

The mounting is very robust, yet the wind resistance is rather low. Both my antennas have stood up to gale force winds; they hardly wobble!! You do not have to use 5.35 meters of for item (1) if you want to work on other bands, such as 18 MHz.

If you intend to use more than 10 watts, then make sure you have a good 1 cm, or more, of insulation between the aluminium pole (1) and the bracket (6).

Have fun with this project. Regards from Harry - SM0VPO **-73!**

Balcony Antenna Extension

by Harry Lythall - SM0VPO

mailto: sm0vpo@telia.com

Credit Line:

<http://web.telia.com/~u85920178/antennas/balcant2.htm>

You may have already seen my HF Balcony Antenna which was designed solely for 14MHz, then a coil was added to cover all the lower HF bands (10, 7 and 3.5MHz). Following an article in RadCom I have now extended this antenna to cover all bands from 3.5MHz through to 30MHz without any switching or tuning. The antenna functions using both Fractal and Meander principles. The height of one turn of the loop gives coverage of the 10-meter band, the old balcony antenna covers 20-meters, an extra element covers 17-meters and the 40-meter long meander gives coverage on the 80-meter band. Here is the measured range of the complete prototype antenna:

Band	Range (MHz)	Worst VSWR	Center VSWR
80 m	3.55 - 3.70	3:1	1.1:1
40 m	7.00 - 7.10	2.2:1	2.2:1
30 m	10.10 - 10.15	2.3:1	2.3:1
20 m	14.00 - 14.35	1.1:1	1:1
17 m	18.07 - 18.17	1.2:1	1.2:1
15 m	21.00 - 21.45	2.8:1	2.5:1
12 m	24.89 - 24.99	2.1:1	2.1:1
10 m	28.00 - 29.20	3:1	1.1:1

As you can see, the VSWR rises on some of these bands but the antenna is still 100% useable on all

bands without an ASCTU (ASTU or ATU). I have not tested the coverage outside amateur bands, I stopped when the VSWR became 3:1 or when the band edge was encountered. So what is the big secret? I have mentioned before in these pages that several 1/4-wave or 1/2-wave antennas can be placed in parallel and fed with a single feeder. The resonant element will have an effect; the others presenting a high impedance. I tried to add two 1/4-wave antennas to cover the original 14MHz plus 29MHz, 18MHz and 3.6MHz. When I tried it I was surprised that the antenna covered as much as 200KHz of the 3.5MHz band and other HF bands were ALL useable. Reports suggest that the effects on 14MHz have introduced a couple of dB's loss, but that is far less than one "S-point". Here is the drawing of the antenna showing the original 14MHz pole (center) and the other two 1/4-wave antennas I have added.

I have shown a graphic likeness of the routing of the additional 43-meters of wire, they are wound on three plywood disks. The top and bottom disks are 100mm diameter and the center spacer disk is 300mm diameter, each drilled with 18 holes. It would have been better to have used nylon food preparation boards (from Ikea) but I didn't really have all that much

confidence this antenna experiment would work so I began with this make-shift arrangement. I must also point out that putting your hand near this antenna will cause changes to the readings, so you may need to make a few minor adjustments in your own individual case. Here are photographs of the finished and working prototype antenna.

The left insert shows the antenna mounted on the old balcony support bracket with the coil removed. The center insert shows a view from the bottom of the antenna. The orange wire is the 420cm 18MHz element. The right insert shows most of the complete antenna from a little distance. Notice how I have cut out material from the center spacer to reduce wind resistance and to help make it look a little less obtrusive for neighbors. The top spacer is identical to the bottom spacer. All three of the elements are connected in parallel at the feed point where I connected my 50-ohm feeder. The old coil is now obsolete and has been removed.

Please note that this antenna idea is also governed by "Harry's Law" of coils:

You cannot wind coils like me and I cannot wind coils like you.

Coil-winding data is a constant that varies from person-to-person.

This means that it may NEED some adjustment in your own environment, depending upon proximity of other artifacts, humidity, groundplane efficiency and even the color of the flag you have fitted to the top of the original 14MHz pole.

Begin antenna assembly by making and fitting the top, middle and bottom spacers. To trim the spacers,

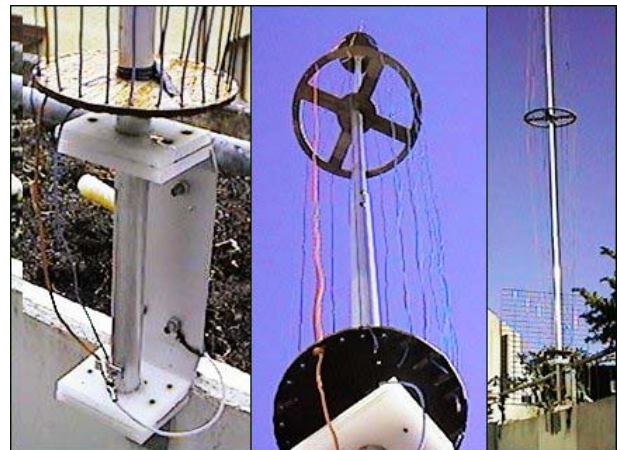
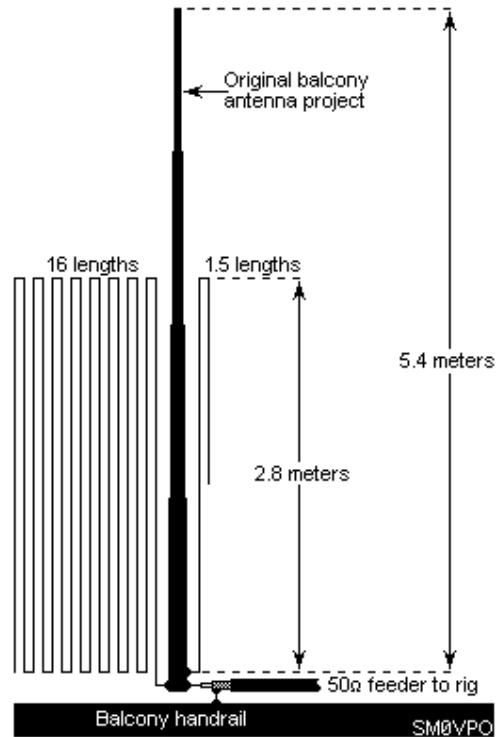

temporarily add a 3-meter length of wire, making a small tight loop at the top to remove the surplus. Check the VSWR at 29MHz and adjust the top-spacer position, re-coiling the surplus wire, until the antenna is resonant with VSWR better than 1.5:1. Fix the spacer positions using hose-clamps or whatever other bright ideas you may have. Now remove the 3-meter wire and sew the 40-meters of wire through the holes. Check the VSWR at 3.6MHz, or whatever part of the 80-meter band you want. Remove wire to achieve resonance. Fit the 1.5-loop, 4.2-meter length of wire for the 18MHz element. This loop only comes 1/2-way down the cage, so add some nylon line and secure it to the bottom spacer. Do not tie anything to the center spacer. The wire I used was 7-ampere multi-strand household mains-wiring cable.

Have fun with this project. Regards from Harry - SM0VPO -73!-

MULTIRANGE VERTICAL ANTENNAS

Igor Grigorov, RK3ZK
antentop@mail.ru

A combined three-band antenna

Three band antenna fundamentals: At a lack of the place for installation of a separate vertical antenna for each of three upper HF ranges it is possible to use a combined three-band antenna that works at the ranges itself. **Figure 1** shows schematic of a combined three-band antenna.

Figure 1 A combined three-band antenna

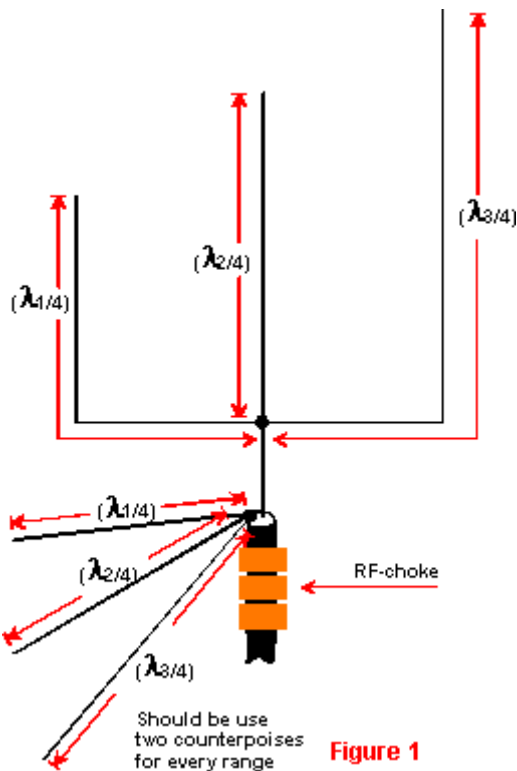

The antenna consists of from three quarter-wave verticals that are resonated for each of working ranges. The verticals are connected in the bottom together. Two quarter-wave counterpoises should be use for each operation range of the antenna A coaxial cable with 50-Ohm characteristic impedance will do well for the antenna. A coaxial cable with 75-Ohm characteristic impedance also would be work with the antenna, but a SWR in the coax will be higher compare to 50-Ohm coaxial cable. **Table 1** shows the combination of ranges where a mutual influence of vibrators against each other is minimum.

Design of the Antenna: Three various designs of the three- range antenna are shown below. **Figure 2** shows a simple design suitable for 6 - to 15-M. The three vibrators are placed on a small distance from

Table 1

6m	10m	15m
10m	15m	20m
12m	17m	30m
15m	20m	40m
15m	17m	20m
20m	30m	40m
30m	40m	80m
40m	80m	160m

each other. The distances between the vibrators are fixed with the help of small plastic insulators. The design has very strong mutual influence for every vibrator against each other.

Figure 2 Simple design of a three ranges antenna

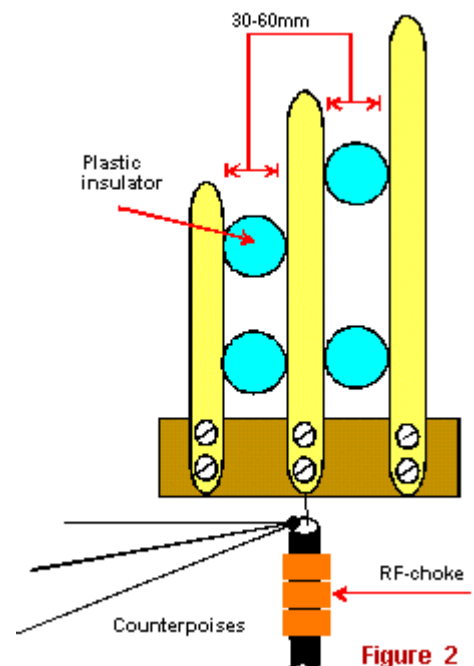

Chapter 1: HF ANTENNAS

Figure 3 shows a simple design suitable for 6 - to 17-M. Antenna has the triangular shape. Special 'sitting' should be used for the antenna design. Vibrators are screwed in the bottom with the help of strong screws. The design has a small mutual influence for every vibrator against each other.

Figure 3 A triangular shape antenna design

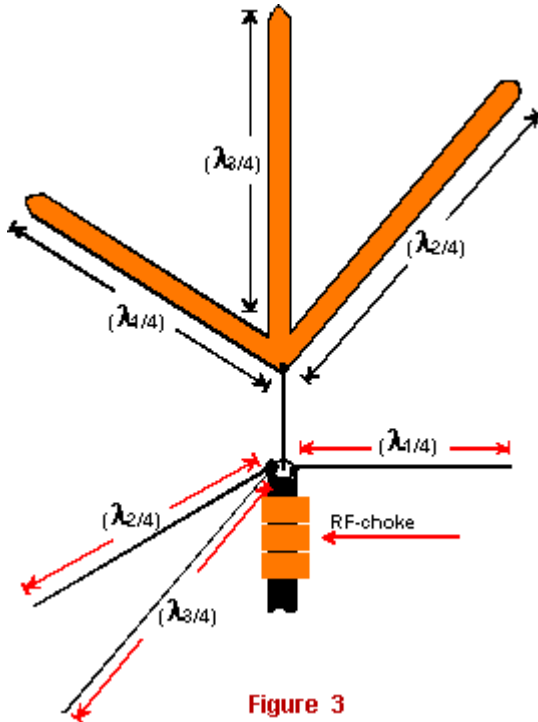

Figure 3

Figure 4 shows a simple design suitable for 6 - to 30-M. Vibrators are screwed to a strong metal angle.

Figure 4 A three range antenna on a metal angle

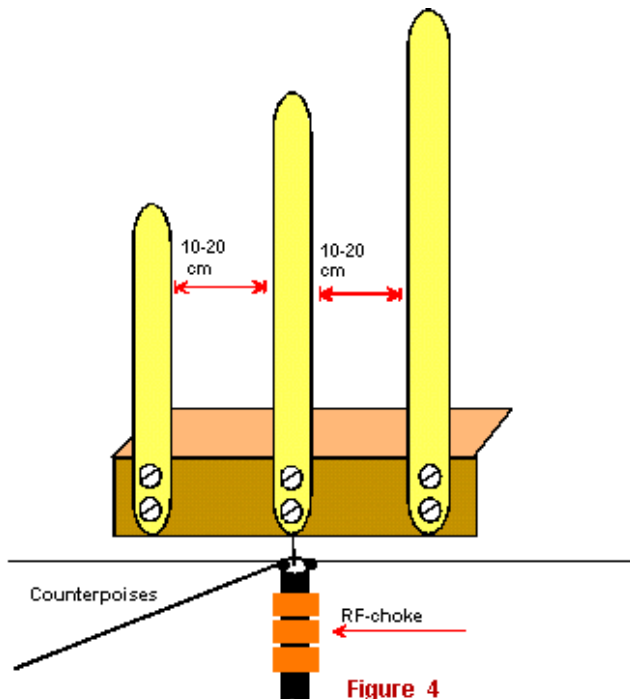

Figure 4

Multirange Vertical Antennas

Distances between the vibrators are 10 -30 centimeters. It is decrease the mutual influence of the vibrators to each other.

Antenna Adjusting: The antenna is adjusted by changing lengths of the vibrators. It is not complicated. One way is to move vibrators relatively the metal base, as it is shown in **Figure 5**. Do it carefully, because the vibrators have mutual influence to each other. It needs to do additional holes on to end of the vibrators for realization of the way. It is possible to do one of the vibrators. This method always gives a good result.

Figure 5 A three range antenna adjusting

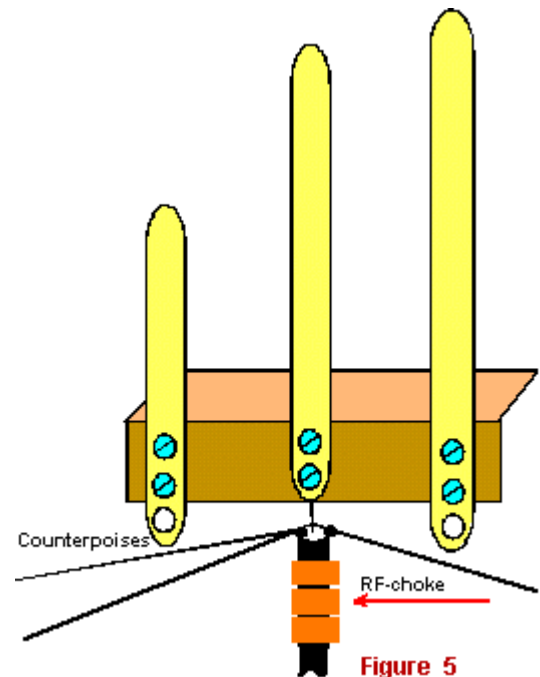

Figure 5

Other way is to change lengths of the upper ends of the vibrators. The vibrators ends made from thick copper or aluminum wire. The wire may be shortened, move in the side, as it is shown in **Figure 6**. But at the way an amateur must have access to ends of the antenna.

A three ranges antenna for the low ranges

Figure 7 shows a simple design suitable for 40 - to 160-M. Vibrators made from a copper wire in diameter 1 to 2 mm. Vibrators have length $(\lambda/4)*1.1$. Each vibrator is matched with coaxial cable with help of its own a 'shortening' capacitor. The shortening capacitor can have 100-pF at ranges of 6- to 17-M, 150-pF at ranges of 20- and 30-M, 200-pF at ranges of 40-80 meters, 250-pF at 160-M. The shortening capacitors should be placed in a whether- proof box.

Figure 8 shows another simple design suitable for 40 - to 160-M. Vibrators made from a copper wire in diameter 1 to 2 mm.

Figure 6 A three range antenna tuning with the help of thick wire

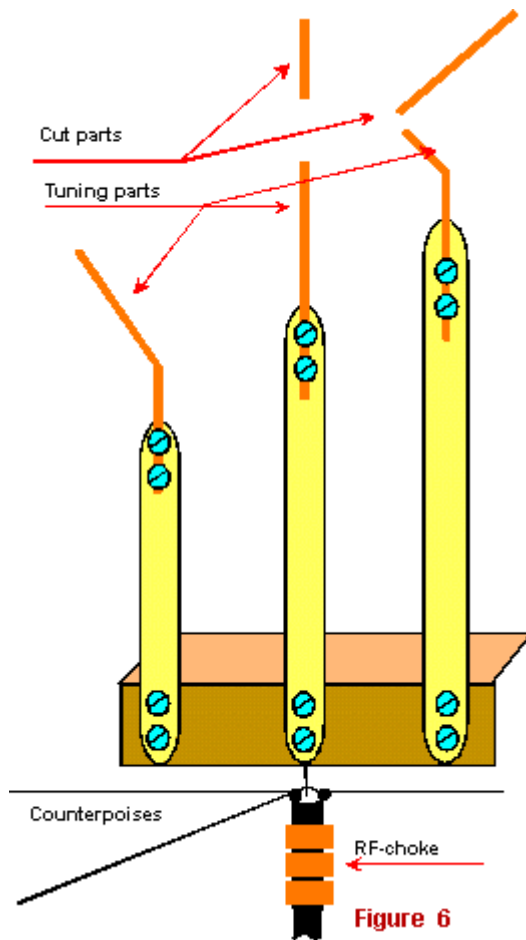

Figure 6

Vibrators have length $(\lambda/4) \cdot (0.5-0.9)$. Each vibrator is matched with coaxial cable with help of its own a 'lengthening' coil. You can use this design if you have a lack of place.

It is not wise to use more than three vibrators for a multi-range vertical antenna, because overall efficiency of the antenna drops in this case. Such multi-vibrators antenna will be too complicated at adjusting.

Remember: Two and more resonance (a quarter wave) counterpoises for each operation range of the antenna should be used. However, if the antenna is placed at a small altitude above a metal roof and the braid of the coaxial cable has a good electrical contact with the metal roof, the antenna could be used without any counterpoises.

RF – choke should be used: An RF-choke on the coaxial cable should be installed at feeding terminals. The RF-choke precludes leaking of RF-currents on to outer braid of the coaxial cable. Without the RF-choke the outer braid of the coaxial cable serves as a radiating part of the vertical antenna. It gets to TV and RF-interferences when the antenna operates on transmission. 10 - 30 ferrite rings (permeability does

Figure 7 A simple design suitable for 40 - to 160-M

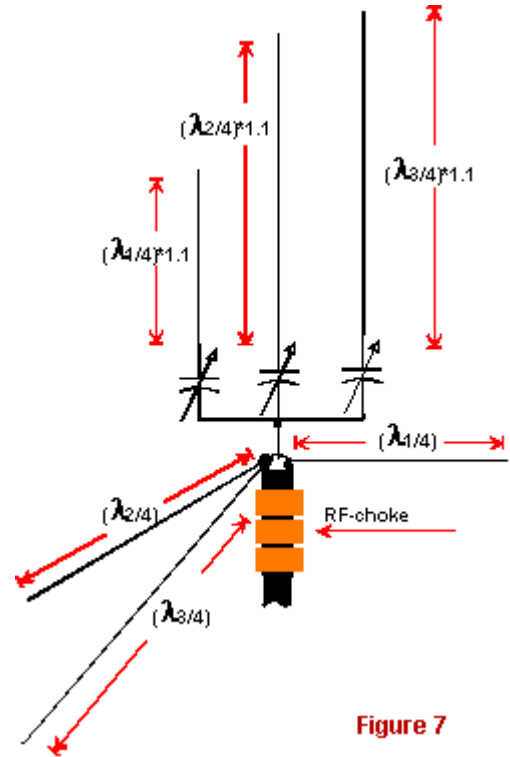

Figure 7

Figure 8 A simple design suitable for 40 - to 160-M with 'lengthening' coil

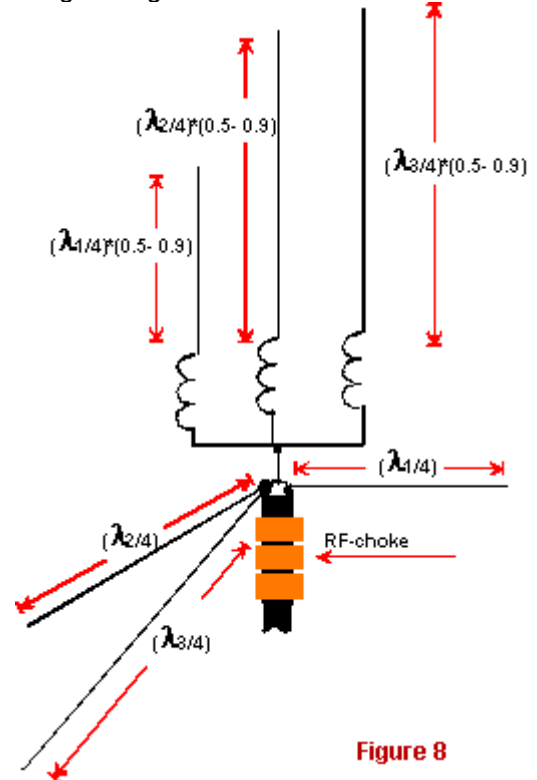
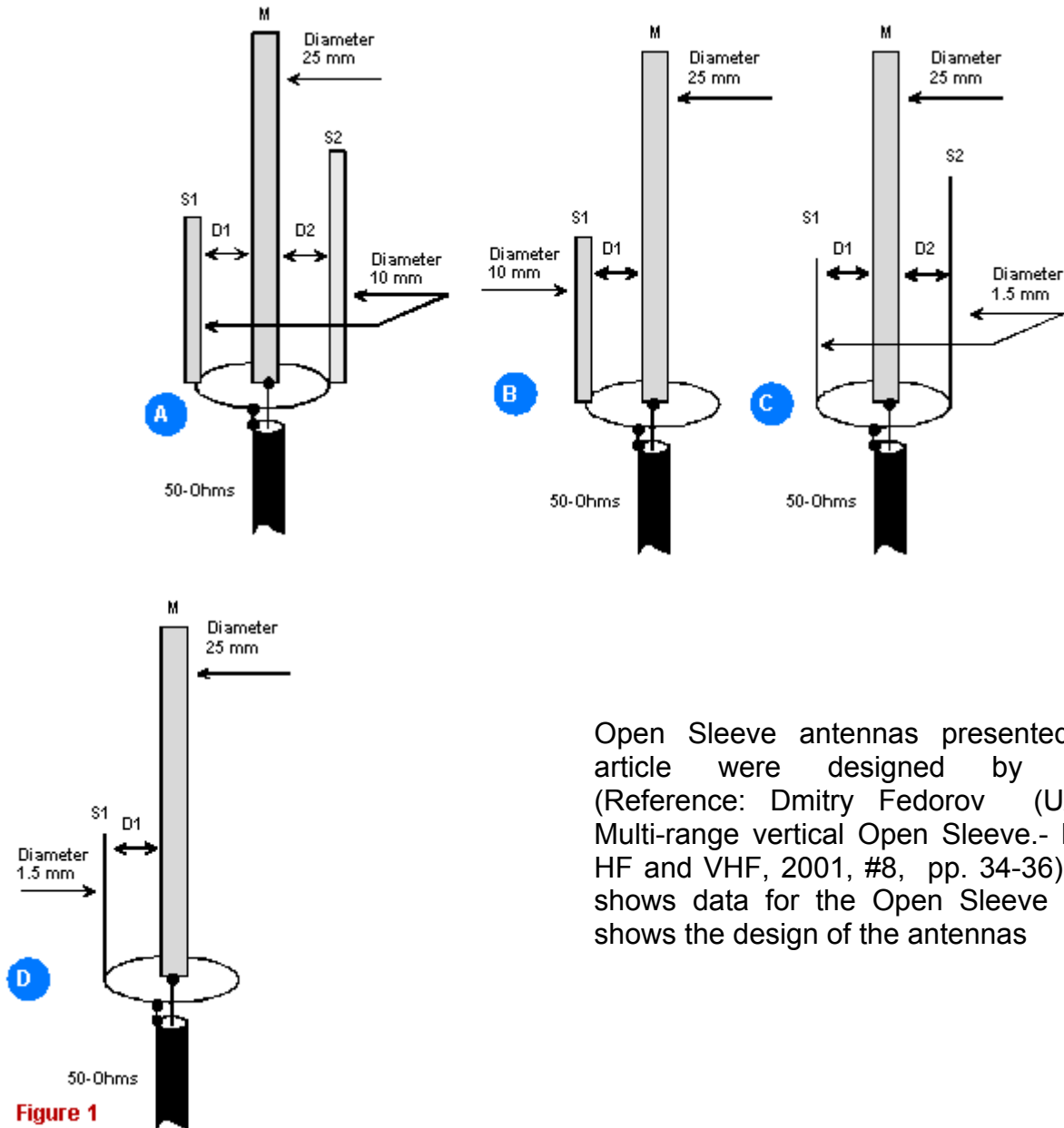

Figure 8

not matter) hardly dressed on the coaxial cable end at the antenna terminal make the RF-choke.

PRACTICAL DESIGN OF OPEN - SLEEVE ANTENNAS FOR UPPER AMATEUR HF - RANGES

By Dmitry Fedorov, UA3AVR



Open Sleeve antennas presented at this article were designed by UA3AVR (Reference: Dmitry Fedorov (UA3AVR): Multi-range vertical Open Sleeve.- Radiomir. HF and VHF, 2001, #8, pp. 34-36). **Table 1** shows data for the Open Sleeve **Figure 1** shows the design of the antennas

Band, m	Length M, mm	Length S1, mm	Distance D1, mm	Length S2, mm	Distance D2, mm	Figure 1
20; 14; 10	5168	3407	220	2573	200	A
14; 10	3630	2527	220	-	-	B
20; 14; 10	5149	3451	220	2601	200	C
14; 10	3432	2567	210	-	-	D

Multi-Range Vertical Antenna UA1DZ

by Igor Grigorov, RK3ZK

Antenna history: Antenna UA1DZ is a very interesting multi-range vertical antenna designed by known Russian radio amateur UA1DZ. The antenna was very popular in use in the former USSR. Russian radio amateurs widely use the antenna at present days also. The antenna works with a low SWR on 40-m, 20-m and 15m. Firstly UA1DZ told about his antenna in the ether, and after that, lots Russian radio amateurs have did the antenna and Antenna UA1DZ became very popularity. First printing papers about antenna UA1DZ appeared in reference [1]. This antenna has gain 3,67 dBi at 40-m, gain 4 dBi at 20-m, gain 7,6 dBi at 15m (reportedly to VA3TTT, reference [2]).

Antenna construction: Figure 1 shows the construction and matching device of multi-range vertical antenna UA1DZ (based on reference [1]). The vibrator of the antenna has the length in 9.3 meters and four counterpoises of the antenna have length in 9.4 meters. Why has the antenna such sizes? Well, for his multi range antenna UA1DZ used an old military vertical antenna and this one had such sizes.

If you have not such old military vertical antenna, of course, it is possible to do home made vibrator and counterpoises! The vibrator and counterpoises must be made from copper or aluminum stuff. Do not use iron wire for HF antenna at all! Iron does not work properly in HF transmitting antennas, especially at upper amateur HF ranges.

Guys must be used with the antenna for providing wind strength. Use acryl cord or iron wire "broken" by insulators to one - meter lengths. Base insulator should have high mechanical and electrical strength because antenna vibrator has a large weight and there is high RF- voltage across the base insulator in transmitting period.

Matching device: It is made on one length of two – wire opened line and two lengths of a 75- Ohms coaxial cable. With the matching device the antenna can work on ranges 40-m, 20-m and 15m with a SWR in coaxial cable no more than 2:1. Two wire opened line "A" does initial matching the antenna input impedance with feeding coaxial cable. The line has characteristic impedance of 450 Ohm and one meter initial length. As usual, the line has ended length about 0.7- meter.

Coaxial cable "B" with characteristic impedance of 75-Ohm and with length 2.5 meters makes further matching for input impedance of the antenna system with feeding coaxial cable. An opened on the end length of coaxial cable "C" makes compensation of a reactive part of the input impedance of the antenna system.

Two wire line (part A) and the matching parts B and C must be placed not less the 50 centimeters above the roof. Parts A and B should be placed in straight line. It is possible to coil the part C in a bay.

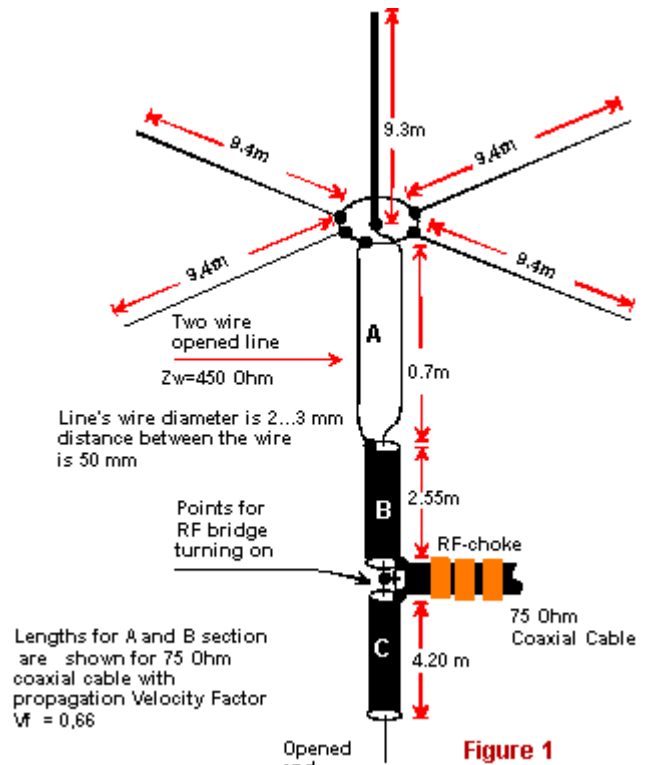

Antenna tuning: The antenna UA1DZ is tuned as follow.

- An RF bridge is turned to input terminal of antenna matching device (see Figure 1).
- Shift antenna resonance frequencies in amateur 40- and 15-m bands by gradually diminishing the length of matching section A. Five centimeters truncation the length of matching section A does frequency shift up to 200 kHz on 21 MHz, and up to 60 kHz on 7 MHz.

It is quite possible to tune the length of matching section A so, that antenna UA1DZ will have the resonance frequencies inside ranges 21 and 7 MHz. If the antenna UA1DZ has resonances on these ranges (40- and 15-m), it will have a resonance frequency inside 20-m range.

Two-wire opened line: It is possible to use either commercial made two-wire opened line either homebrew one. Remind, that two-wire transmission line with aerial dielectric and 450 Ohm characteristic

Chapter 1: HF ANTENNAS

impedance has relation between the diameter of its wires and the distance between these wires nearly 20 (see [Figure 2](#)).

RF – choke should be used: An RF-choke should be installed on the coaxial cable at the antenna terminal. This RF-choke precludes leaking of RF currents on the outer braid of the coaxial cable.

Without such RF-choke the outer braid of the coaxial cable will serve as a radiating part of the vertical antenna. It causes big level of RF interferences when the antenna works on transmission. 10 -30 ferrite rings, hardly dressed on the coaxial cable at the antenna terminal, make the most simple an RF-choke. The place for a RF choke is shown in [Figure 1](#).

Hula- Hoop magnetic Loop

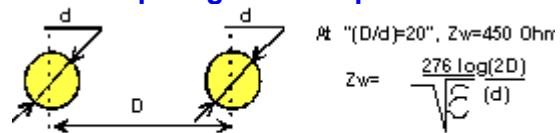

Figure 2

References:

1. RB5IM.: Ground plane UA1DZ. Bulletin UC 1993, C.27.
2. A. Barskiy, VA3TTT: About antenna L www.krasnodar.online.ru/hamradio

Hula- Hoop magnetic Loop

by **Yuri Kazakevich**, EW6BN, , ew6bn@tut.by



After long QRT (birth of my daughter, changing my QTH) I was going again QRV!!!

So, I needed an antenna! But where can I install it? It was not possible to install any antenna on the roof of my house. I had only place for installation of an antenna, the place was my balcony of my house. Well, it was very place. What an antenna can install at the place? I thought, it was only a Magnetic Loop Antenna.

I remembered, when I still went to school, I used a Magnetic Loop Antenna made from old coaxial cable for my work on CB - range 27 MHz. The antenna worked very well. Well, I decided to use a Magnetic Loop Antenna for my very restricted area for a work at 14 MHz.

Lots information about Magnetic Loop Antennas I found in the Internet, in particular in reference [\[1\]](#), it is a free e- book on antennas (in Russian).

I decided to make my Magnetic Loop Antenna on the basis of an aluminum hula - hoop. Hula – hoops in diameter of 77 centimeters and with 17 mm tube

www.antentop.bel.ru

diameter were on sale in my local shop. The hula – hoop tuned at 14 MHz with two capacitor- one variable capacitor 10- 50 pF, and other, bridged to the variable capacitor, a fixed capacitor in 27 pF. The capacitors placed at the top the hoop. For my loop I used gamma feeding, because it has very high efficiency. [Figure 1](#) shows my Magnetic Loop Antenna. I have got 1:1.3 SWR with the gamma match.

The Magnetic Loop Antenna was installed on the third floor of a brick five-floor house. A wooden stick hold the antenna almost in one meter aside from the balcony. It was impossible to do a rotary design of the antenna for my conditions, so I just fixed the antenna on the line West – East. My house is situated at outskirts of the city, so, the West is opened, only one imperfection, a high-voltage power electric line on 110 kV is in 50 meters from my antenna....

On reception the antenna worked perfectly. But, unfortunately, there was a small handicap from the high-voltage power electric line.

Figure 1 Magnetic Loop Antenna

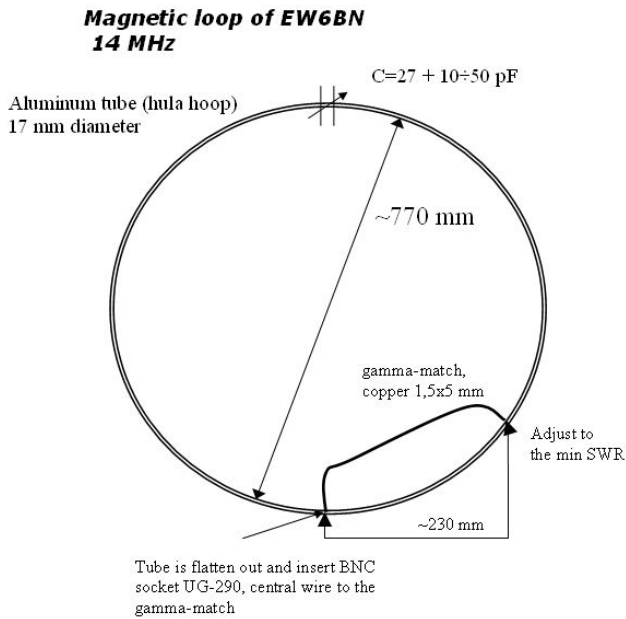

The antenna had very good results at transmission mode. See my first QSOs, that I have made straight away after installation of the antenna.

18:50 UTC, 13 July 2003:

I heard "CQ de G3KXV". I pressed on key – "G3KXV de EW6BN/QRP..."
And ... "EW6BN/QRP de G3KXV" op Vic.
YES, the QSO is made!
I gave RST 579 QSB.
He gave me 569, also QSB, 100-w and a dipole, your mag loop 77 cm doing very well!

Reference:

1. Igor Grigorov: "Antennas for radio amateurs - 1998, Majkop, e-book,
Available free at <http://cqham.ru/ftp/rk3zk/zip>

EW6BN:A Field Operation



19:25, UTC, 13 July 2003:

HB9DRK/QRP stayed on CQ, he received my call, gave me 329, I gave him the info about my mag loop, and HB9DRK/QRP gave me a new rpt 559, he used 5-w and a delta.

Perfectly... My soul was singing, but I had to do QRT for a while...

So, my balcony Magnetic Loop Antenna allows me to be in the ether again and to do interesting QSOs over the World!

A HELICAL LOOP ANTENNA FOR THE 20 METERS BAND

By Vladimir Kuz'min, UA9JKW,
KuzminVI@pn.yungjisc.com

Helical Loop Antenna

Two years back I have moved to Nefteyugansk (Russia, Siberia) where I could not receive the sanction to installation for a full-sized HF- antenna on the roof of my house. , So I began to do experimenters with short indoors antennas. Most success design of my indoor antenna is a design similar to [Fig. 59](#), given in [Reference 1](#).

I have used an inch OD plastic pipe to the form of the antennal. The pipe was bent in a hoop near 1 meter diameter. Antenna has 580 turns (near 61 meters of length) of multicore isolated wire of 3 mm diameter with thickness of isolation of 1 mm. So, the spacing between turns is 2 mm. Antenna has SWR 1:1 to 50-Ohm coaxial cable to 14.100, bandwidth to SWR 1:1.5 is 300-kHz. I use a simple symmetrical device- 3 turns on a TV yoke ferrite core. Space from the antenna to the ceil is near 25 centimeters.

The antenna has quite good directed properties at rotation within 30-90 degrees the force of signals varied to 1-1,5 points on mine S-meter. I use a YAESU FT840 for my work in the ether. Change of polarization (at rotation of the antenna on the vertical side) appreciable changes has not given as well as change of feeding points has not given large change in the force of signals.



Figure 58 & 59 from Reference 1

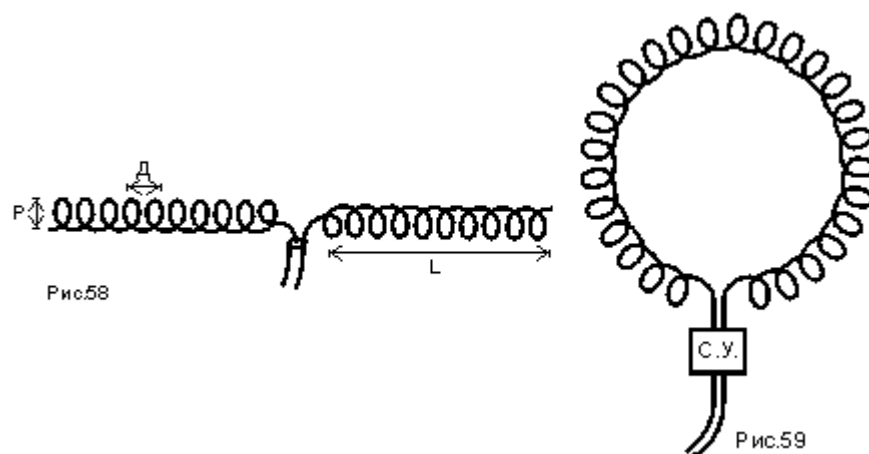

In the last summer I experimented and hung up of the antenna behind my balcony at 1.5 meters from a wall. I have received a significant improvement of the work of the antenna. The antenna does very good operation in the ether, better than others indoors antennas. It gives low industrial noise and kills all TVI.

Reference:

I. Grigorov. Antennas for radio amateurs. - Majkop, 1998.

Get free the book from

<http://www.cqham.ru/>

UA9JKW at his shack



TOP LOAD AT VERTICAL ANTENNAS

All amateurs know if at a vertical antenna a top load it is used, the self –resonance of the vertical antenna would be lower then a vertical without the top load. How a top load does influence to antenna resonance?

At **Reference 1** I found a very interesting table having the data. I have proved the table with **MMANA**, all okey, the table gives very reliable data, so it is possible to use it at many situations. Figure 1 shows different top loads. Data for loaded effect for the top load is shown in Table 1 given at **Reference 1**. K is coefficient: $K = W/L$, where W is a resonance wavelength for the vertical antenna, L is antenna length from the ground to the top load.

As it is seen, the “umbrella” top load (**Figure 1e**) gives the most effect on the resonance of a vertical antenna. For example, if to use an umbrella load for a vertical antenna in five meters height, the antenna quarter wave fundamental resonance wavelength would be changed from 20 to 50 meters!

Reference:

1. Polyakov V. Technique of radio: Simple AM receivers. – Moscow, DMK-Press, 2001.

73! I.G.



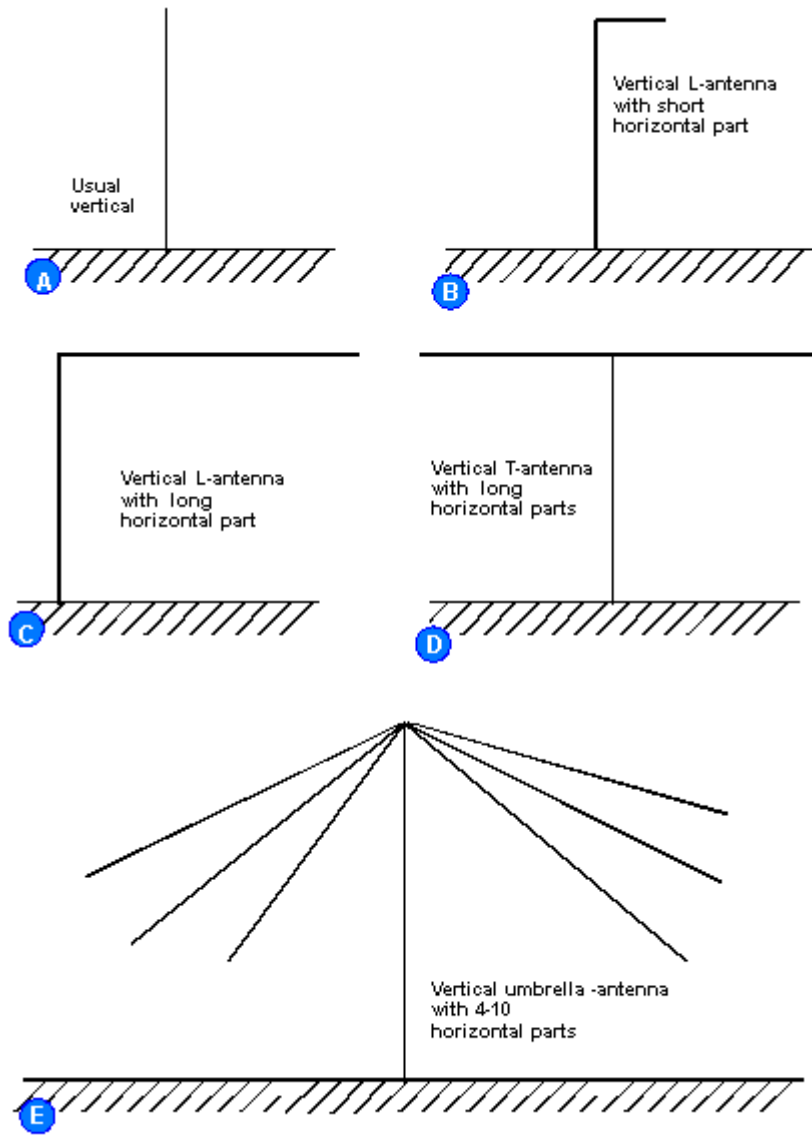

Figure 1

Kind of an antenna	K
Simple vertical Figure 1a	4
Inverted L with short horizontal part Figure 1b	4.5-5
Inverted L with long horizontal part Figure 1c	5-6
T- antenna with long horizontal part Figure 1d	6-8
Umbrella antenna with 4-8 wires Figure 1e	6-10



THREE BAND UNIVERSAL RZ3AE ANTENNA*Evgeniy, RZ3AE*bort3@narod.ru

For several years I use to a simple and rather effective home – made antenna for a work from my balcony, a hotel window, from the ground in a radio- expedition and from my car. I with my friends have made a dozen such antennas and all the antennas work very well. One antenna, in depend of its dimension, works at three old amateur ranges- 10, 15,20 or 15, 20,40, or 20,40, 80.

Antenna description:

Figure 1 shows the antenna. Antenna wire is a tube or copper or bimetal rod of 5-12-mm diameter (#0000—5 AWG). D-E wire is thinner then a-c-b wire in 2-5 times. Antenna is tuned by air (a vacuum capacitor is better!) variable capacitor with air-gap in 2-mm. The capacity is 5- 750-pF.

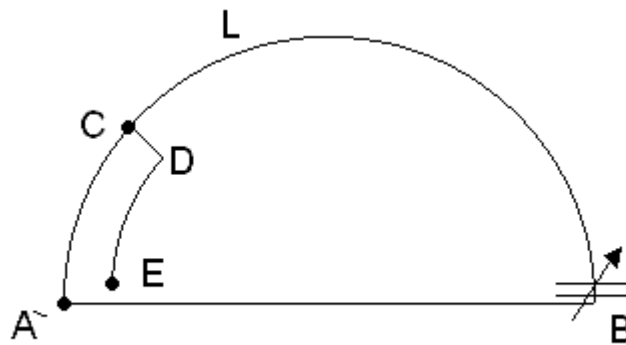
Figure 1 RZ3AE Antenna**Antenna ratio:**

$$L = 1.57AB$$

$$CD = 5-8 \text{ centimeters}$$

$$AC \approx 0.2L$$

Most high frequency for the antenna is: $4(AB+L)$.

Antenna adjustment

To run a QRP power at most high frequency for the antenna. Move a crosspiece CD to find the minimum SWR. Check position of the crosspiece. To run a QRP power for next working band of the antenna. Move a crosspiece CD to find the minimum SWR. Check position of the crosspiece. And so on.

Antenna operation

To stand the crosspiece by manually or by RF-relays for choosing band. The antenna has very high directivity, so, choose needed position for the antenna. Switch your transceiver and enjoy!

Antenna results

I tried the antenna at different conditions and everywhere the antenna works well, from my house, from my car (the antenna is placed at boot of my car), from a field. I use to the antenna with IC-706 MK2G.

I wish all good luck! 73!



Fast Made a Half - Wave Antenna for 80 Meters

By Igor Grigorov, RK3ZK

The antenna was made by me in one of the hot summer days near five years back. I was going for weekend to my bungalow and I decided to take my home- brew 80 – meters transceiver with myself. I had no antenna for the transceiver. So, I needed to do any antenna, but I had no time as no quality stuff for doing this one. I opened my box with old tips... and... Thirty minutes while I have had a new antenna that served me several years!

G-QRP-C
6363



Figure 1 shows the all antenna system. I have done a half wave antenna with “bottle” matching device. As you can see a wire in long of 40 meters (a half wave antenna) is matched with 50-Ohm output of my transceiver with help of a parallel circuit (“bottle” matching device) – it is L1C1 in **Figure 1**. Spool L2 has not electrical connection with antenna circuit. RF energy is transferred from antenna to the spool only by magnetic field, that reduces the level of static interferences at receiving mode. The counterpoise has length of 20 meters of a naked copper wire in diameter of 1,5 millimeters (#14 AWG). I used a wire from an old burned down electrical transformer 220-V/12-V. The counterpoise serves as electrotechnical both as radio ground for the antenna. At operation time of the antenna

the counterpoise is placed on the ground in any position (straight or bending). To short static electrical charge from antenna wire to ground is main task of the counterpoise. Not wise to use a long antenna in field without an electrotechnical ground, because in the first it is unsafe, and in the second, the antenna is very rustle on reception without an electrotechnical ground.

Figure 2 shows the construction of the matching device. I used a half - liter plastic bottle in diameter 60 millimeters from mineral water. C1 is attached at a side of the bottle with help of a strong copper wire in diameter of 1 millimeter (#18 AWG). L1 has 15 turns of copper wire in diameter of 1,5 millimeters (# 14 AWG), length of winding is 70 millimeters.

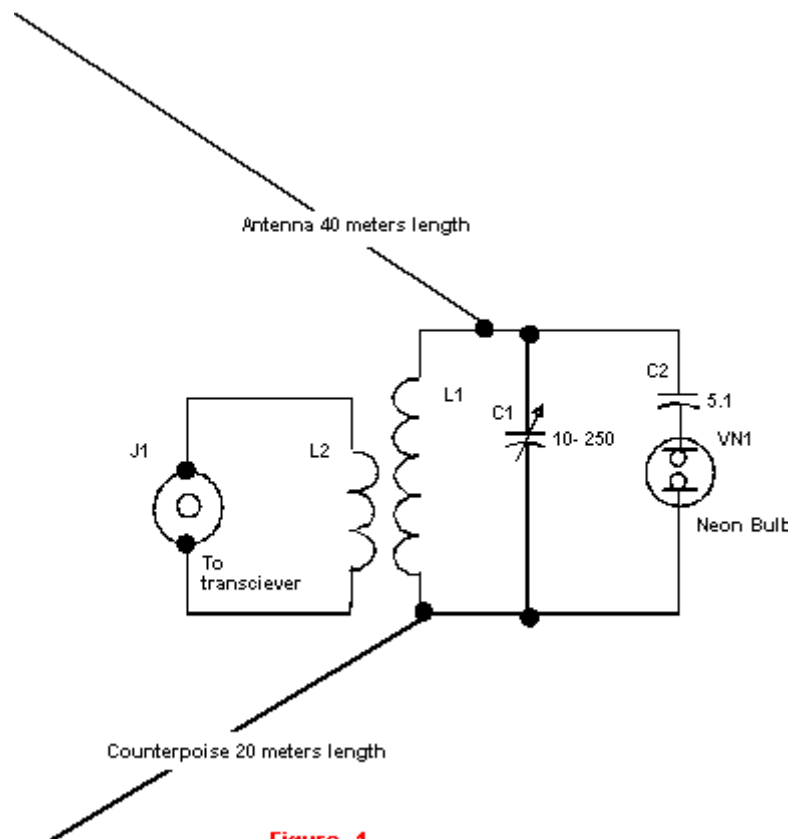

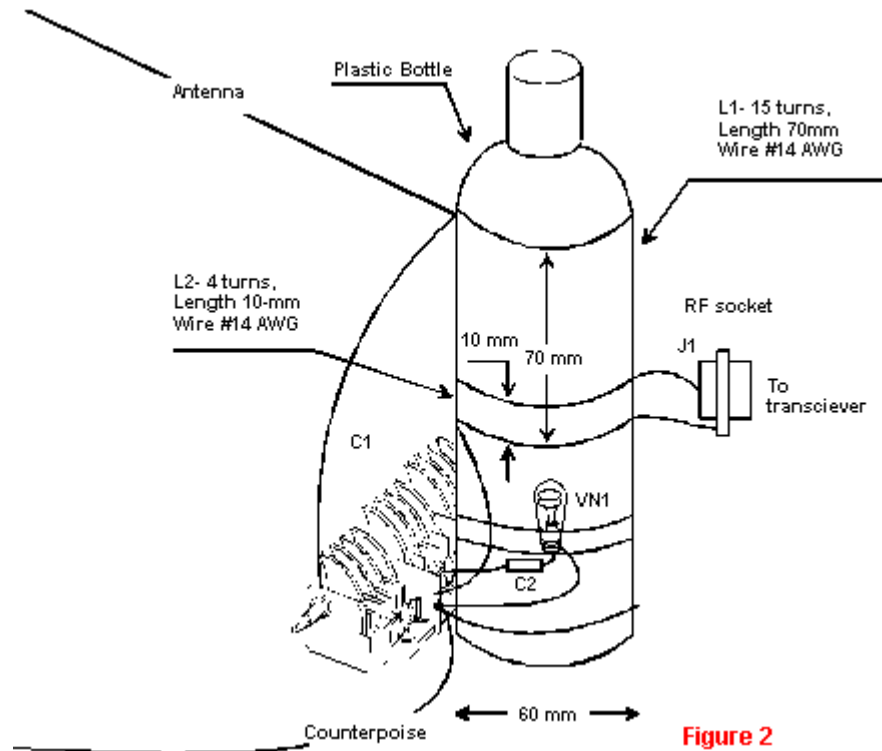

Figure 2

L2 is placed at the bottom of L1. L2 contains 4 turns of copper wire in diameter of 1,5 millimeters (# 14 AWG), length of winding is 10 millimeters. Ends of L2 are directly soldered to J1 RF – socket. VN1 is attached by a piece of Scotch to the bottle. Antenna is tuned by max glow of VN1.

The antenna works very effectively when the upper end of the antenna at lengths of five or more meters above the ground. I don't use an end antenna insulator. A long synthetic rope can simply be attached to the upper end of the antenna. The down end of the antenna could be just near the ground. A coaxial cable having any reasonable length can be between "bottle" ATU and a ham

transceiver. Figure 3 shows the antenna at field operation. Of course, it is very possible to use the antenna for stationary work from a ham shack.

The antenna works very well, and I recommend try it!

73/72!

One more a website devoted QRP!

US1RCH Page
 www.qsl.net/us1rch
<http://www.qsl.net/us1rch/>

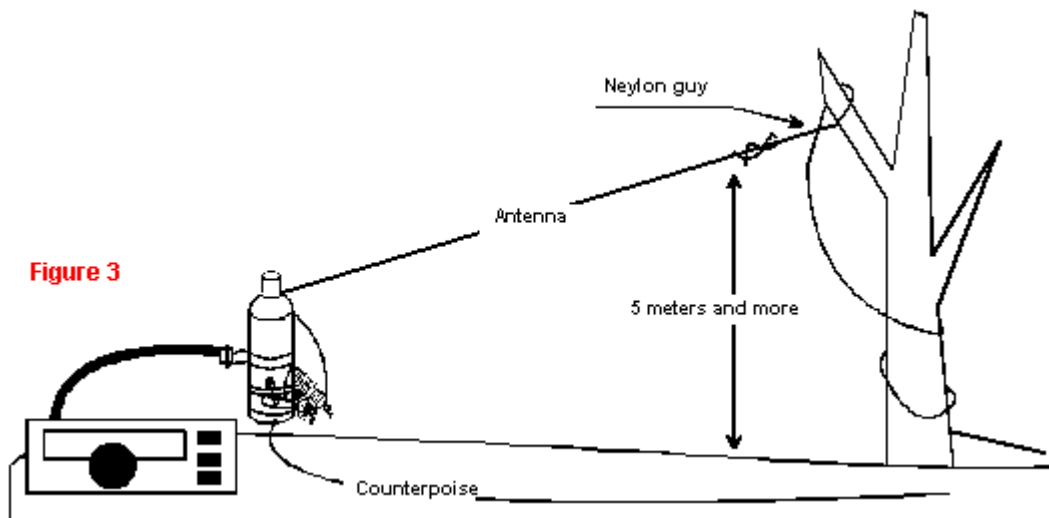

Figure 3

WINDOW DIPOLE ANTENNAS WITH CAPACITIVE LOADS FOR THE 6 AND 10 METERS BANDS

by Igor Grigorov, VA3ZNW
mailto: antentop@antentop.org

It is possible to install a dipole antenna with capacitive loads for the 6 and 10 meters bands at a standard window with sizes 140x150 or 140x210 centimeters. The design of that window antenna for the bands can be simple as well as the antenna impedance can be easily matched with 50-Ohm coaxial cable. That dipole antenna with capacitive loads installed at upper floor of a high-rise building can provide DX- QSOs.

However, a dipole window antenna with capacitive loads for bands lower than the 10-meters, if this one is installed at a standard window with sizes 140x150 or 140x210 centimeters, has low input impedance and narrow bandwidth so the antenna is hard to match. Hence antennas for bands lower than the 10 meters are not discussed in this article.

Types of a Dipole Antenna with Capacitive Loads

There are several ways to install a dipole antenna with capacitive loads at a window. The best way is to install a dipole antenna with capacitive loads by the center of the window. In that case the antenna can be installed at any house as made from a brick or wood as well as made from a concrete. Let's name the antenna "antenna central installation." If a house made of a brick or wood it is possible to install the dipole antenna with capacitive loads by up or down of the window. Let's name the antenna "antenna up or down installation." Of course, a non metal window-frame works better than the metal one.

Feeding Coaxial Cable of a Dipole Antenna with Capacitive Loads

Ferrite rings (5- 20 ring with any permeability) installed at two ends of the coaxial cable going from TX to the antenna prevent RF-currents going from the antenna to TX. Since the rings do balun's job. Fasten the rings at the coax with a Scotch. The coaxial cable going from the antenna to the window-sill should be placed athwart to the antenna. However the coaxial can be placed as you want at your room.

Stuff for a Dipole Antenna with Capacitive Loads

A dipole antenna with capacitive loads can be made of a flexible multi-wire cable as well as of a strand wire. Any wire is good as naked as well as covered by plastic isolation. Diameter of the wire can be near 1- 2 millimeters (12- 18 AWG). Use wire as much thick as possible. Compare to antenna made from thin wire thick antenna has wider bandwidth. It is wise (because it is cheap) to do a dipole antenna with capacitive loads without end insulators. The antenna can be installed with help of a rope or plastic (as well as fishing) cord. A dipole antenna with capacitive loads of up or down installation can be installed directly (with help of nail or staple) at plastic or wooden window frame.

Window Dipole Antennas with Capacitive Loads for 6-meters Band

Figure 1 shows a schematic (Figure 1a) and design (Figure 1b) of a window dipole antenna with capacitive loads of central installation. Figure 2 shows a schematic of a window dipole antenna with capacitive loads of up or down installation. The design of the antenna is similar to design shown at Figure 1b. The design of the both antennas is simple. Two ropes are installed at two ends of the window. Capacitive loads fastened to the ropes by thin wires or ropes. Third rope is installed at the center of the window. Antenna central insulator (made from a piece of any plastic or PC board) is fastened to the rope.

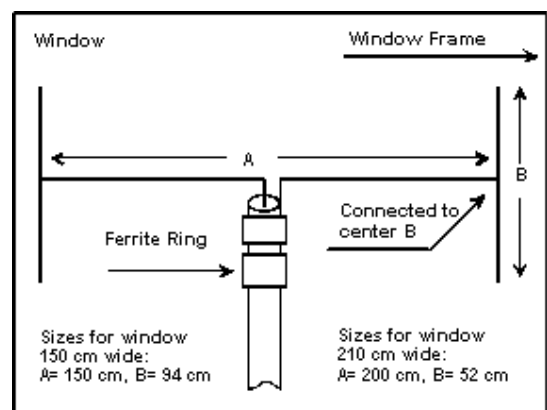

Figure 1A

Figure 1 A window dipole antenna with capacitive loads of central installation

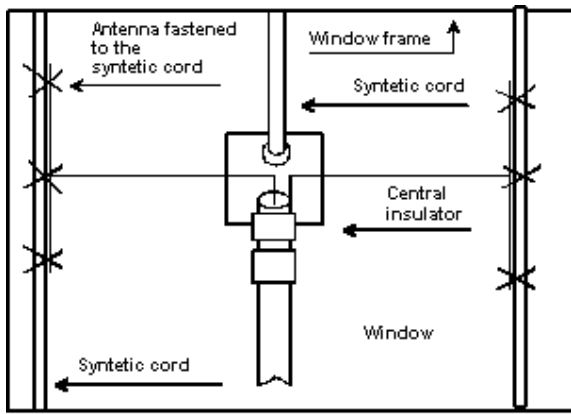

Figure 1B

Figure 1 A window dipole antenna with capacitive loads of central installation

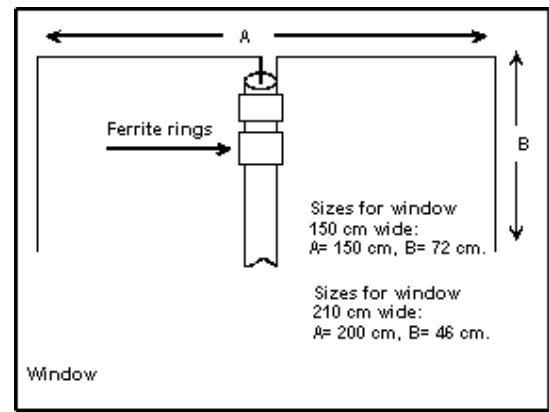

Figure 2

Figure 2 A window dipole antenna with capacitive loads of up or down installation

Adjustment of the both antennas is simple. A SWR-meter or HF- bridge (see References [1]) is connected to feed points of the tuned antenna. Gradually shorten 'moustaches' (symmetrically each moustache) of the antenna to minimum SWR or when antenna input impedance is active (has no reactive component) at needed frequency. At shortening moustaches the moustache wires roll up to a little coil.

Parameters of the Window Dipole Antenna with Capacitive Loads of Central Installation

Theoretical parameters of the antennas (copper, wire in 1-mm (18- AWG) diameter) were simulated with help of MMANA (see References [2]).

Figure 3 shows the input impedance of the antenna installed at window 150-cm wide. Figure 4 shows the input impedance of the antenna installed at window 210-cm wide. Theoretical input impedance for 'narrow' antenna is 42- Ohms, for 'wide' antenna is 60- Ohms. The data are very good matched with my practical measurement of the antennas. A 50- Ohm coaxial cable should be used for feeding of the antennas. This one can be connected directly to antenna feed points, as it is shown at Figure 1. A 75- Ohm coaxial cable is possible to use for the antenna installed at wide (210 cm) window. Figure 5 shows a SWR at 50- Ohm coaxial for 'narrow' antenna shown at Figure 1. Figure 6 shows a SWR at 50- Ohm coaxial for 'wide' antenna shown at Figure 1. Theoretical gain for the antennas is near 1,5- 1,7 dBi.

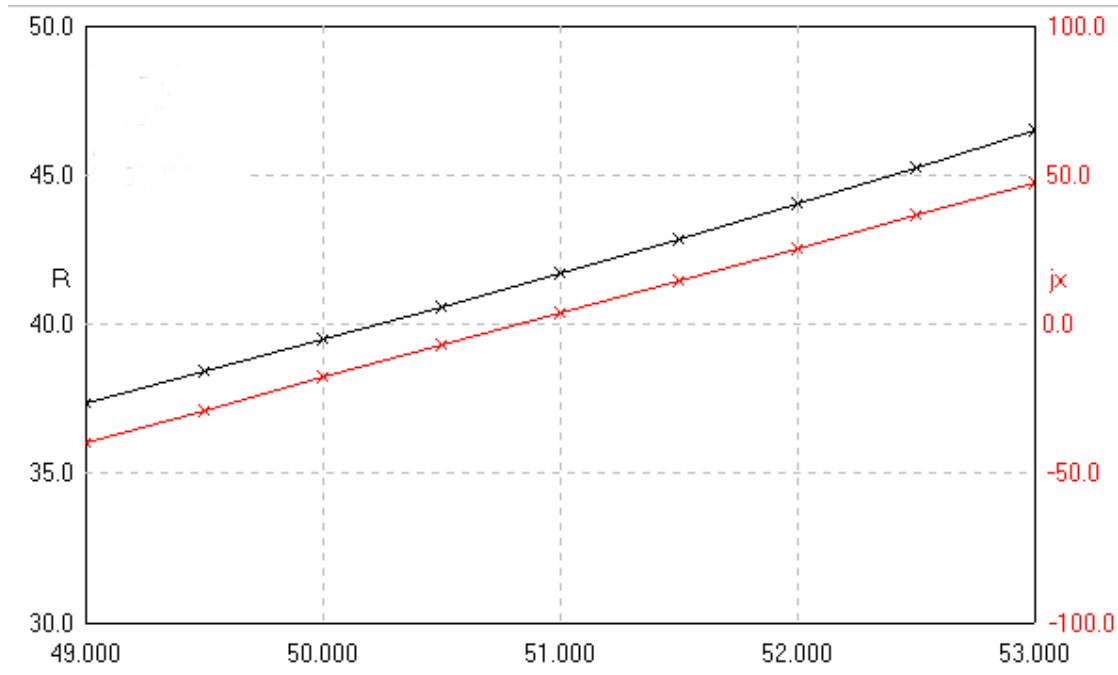

Figure 3 Input impedance of 'narrow' antenna

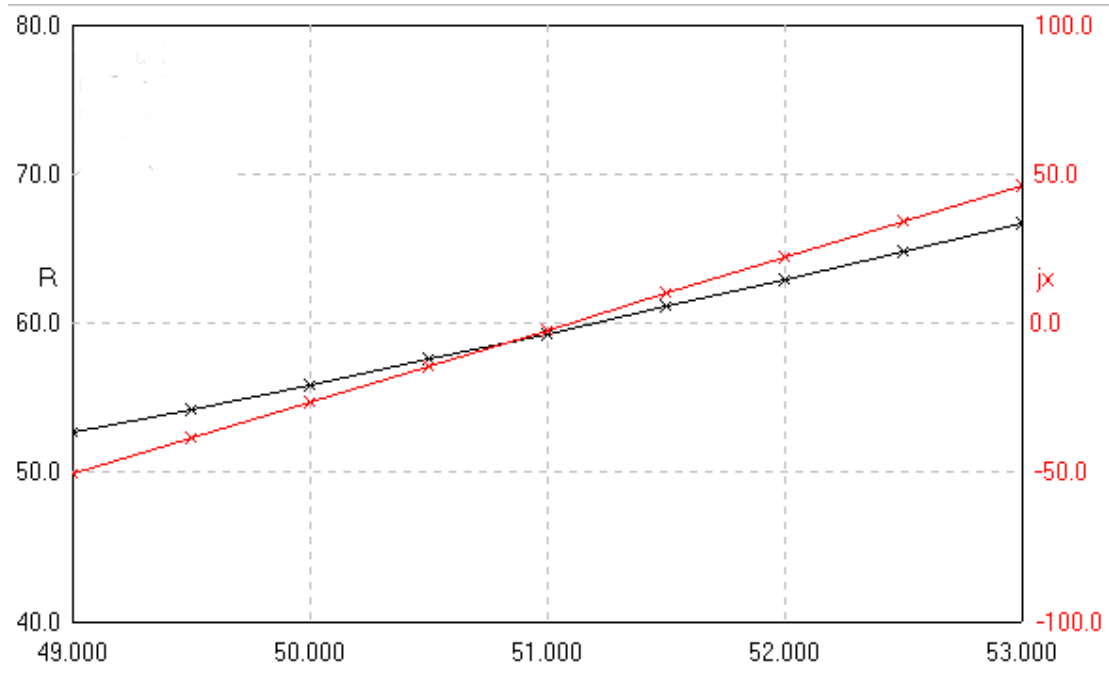

Figure 4 Input impedance of 'wide' antenna

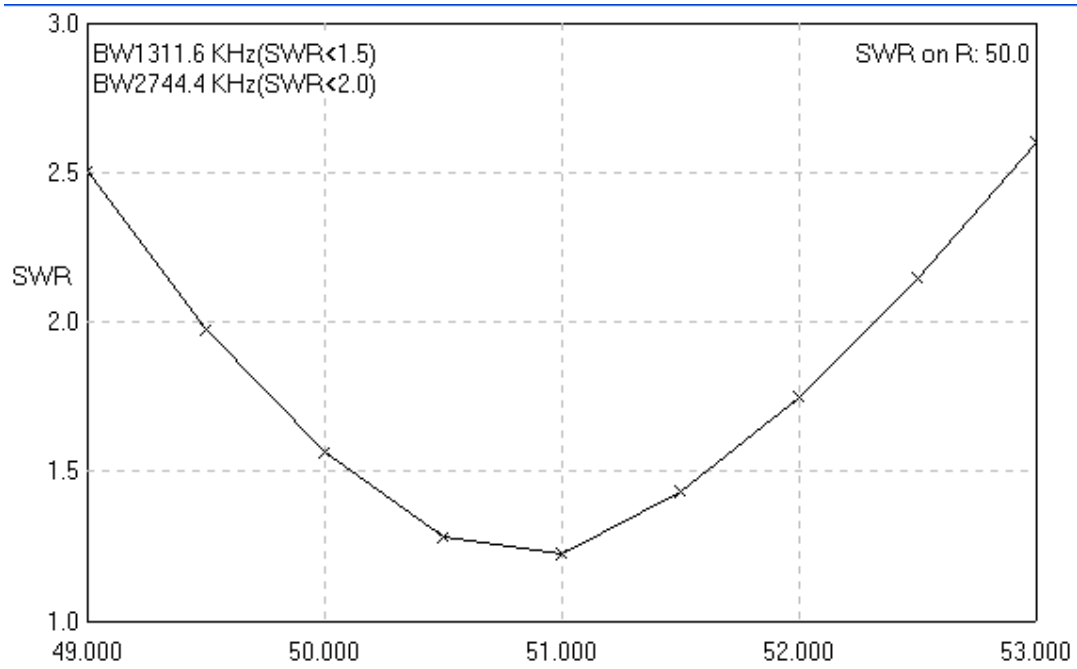

Figure 5 SWR at 50- Ohm coaxial for 'narrow' antenna



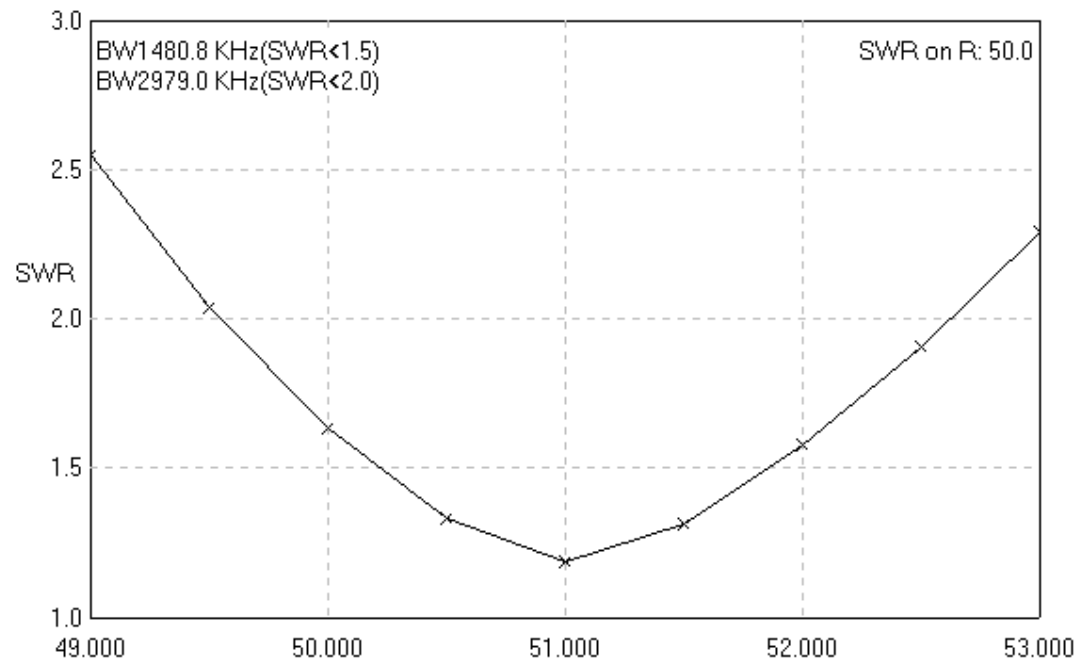

Figure 6 SWR at 50- Ohm coaxial for 'wide' antenna

A 'narrow' antenna of central installation has theoretical pass band 1300 kHz at SWR 1,5:1 at 50- Ohm coaxial cable, and pass band 2744 kHz at SWR 2:1 at 50- Ohm coaxial cable. A 'wide' antenna of central installation has theoretical pass band 1480 kHz at SWR 1,5:1 at 50- Ohm coaxial cable, and pass band 2979 kHz at SWR 2:1 at 50- Ohm coaxial cable. It is quite enough for working at 6- meters band especially since the real antenna has pass band wider the theoretical.

Parameters of the 6- meters Band Window Dipole Antenna with Capacitive Loads of Up and Bottom Installation

Theoretical parameters of the antennas (copper, wire in 1-mm (18- AWG) diameter) were simulated with the help of MMANA. **Figure 7** shows input impedance of the antenna installed at window 150 cm wide. **Figure 8** shows input impedance of the antenna installed at window 210 cm wide. Theoretical input impedance for 'narrow' antenna is 43- Ohms, for 'wide' antenna- 60- Ohms. The data are very good matched with my practical measurement of the antennas.

A 50- Ohm coaxial cable should be used for feeding of the antennas. This one can be connected directly to antenna feed points, as it is shown at **Figure 2**. A 75- Ohm coaxial cable is possible to use for an antenna installed at wide (210 cm) window.

Figure 9 shows a SWR at 50- Ohm coaxial for 'narrow' antenna shown at **Figure 2**. **Figure 10** shows a SWR at 50- Ohm coaxial for 'wide' antenna shown at **Figure 2**. Theoretical gain for the antennas is near 1,5- 1,7 dBi.

A 'narrow' antenna with capacitive loads of up or down installation has theoretical pass band 1377 kHz at SWR 1,5:1 at 50- Ohm coaxial cable, and pass band 2697 kHz at SWR 2:1 at 50- Ohm coaxial cable. A 'wide' antenna with capacitive loads of central installation has theoretical pass band 1393 kHz at SWR 1,5:1 at 50- Ohm coaxial cable, and pass band 2876 kHz at SWR 2:1 at 50- Ohm coaxial cable. It is quite enough for working at 6- meters band especially since the real antenna has pass band wider the theoretical.

Window Dipole Antennas with Capacitive Loads for 10-meters Band

Figure 11 shows schematic a window dipole antenna with capacitive loads of central installation. **Figure 12** shows schematic a window dipole antenna with capacitive loads of up or down installation. Antenna central installation can be installed at window 210-cm wide. Antenna up or down installation can be installed at window 150 or 210-cm wide.

The design of the both antennas is similar to design shown at **Figure 1b**. Two ropes are installed at two ends of the window. Capacitive loads fastened to the ropes by thin wires or ropes. Diagonal capacitive loads are spread by thin ropes. Third rope is installed at the center of the window. Antenna central insulator (made from a piece of any plastic or PC board) is fastened to the rope.

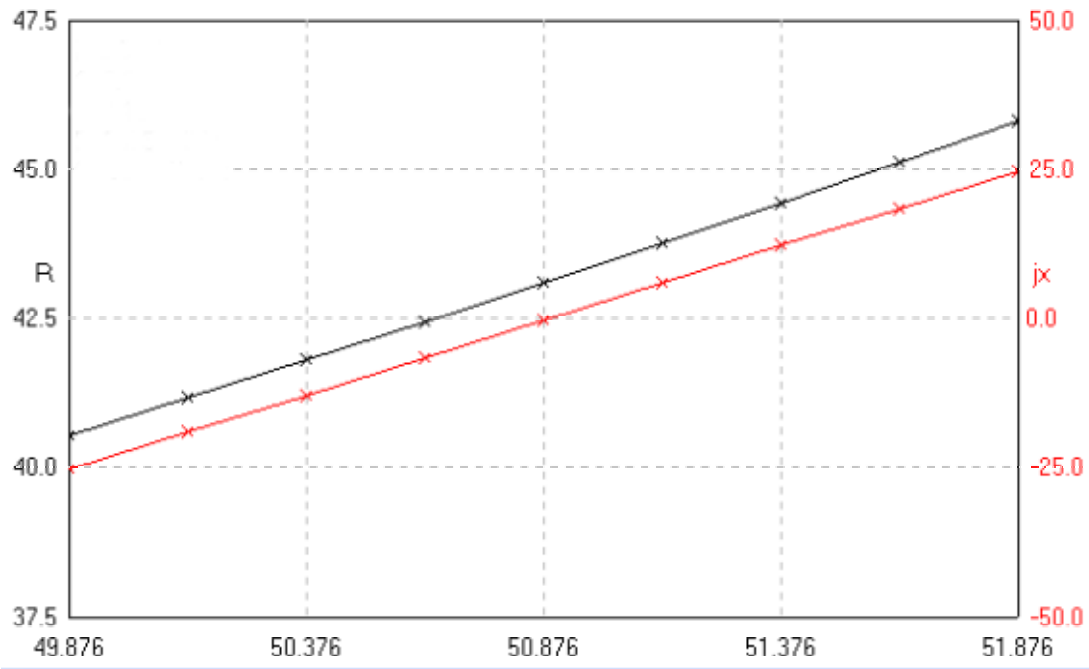

Figure 7 Input impedance of 'narrow' antenna

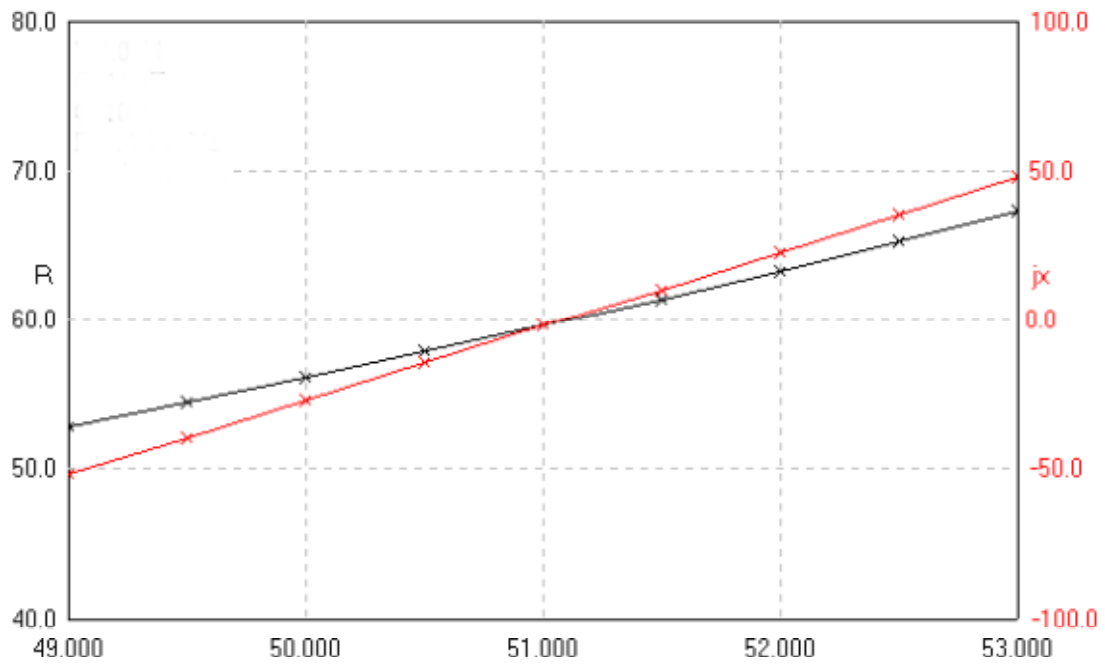

Figure 8 Input impedance of 'wide' antenna

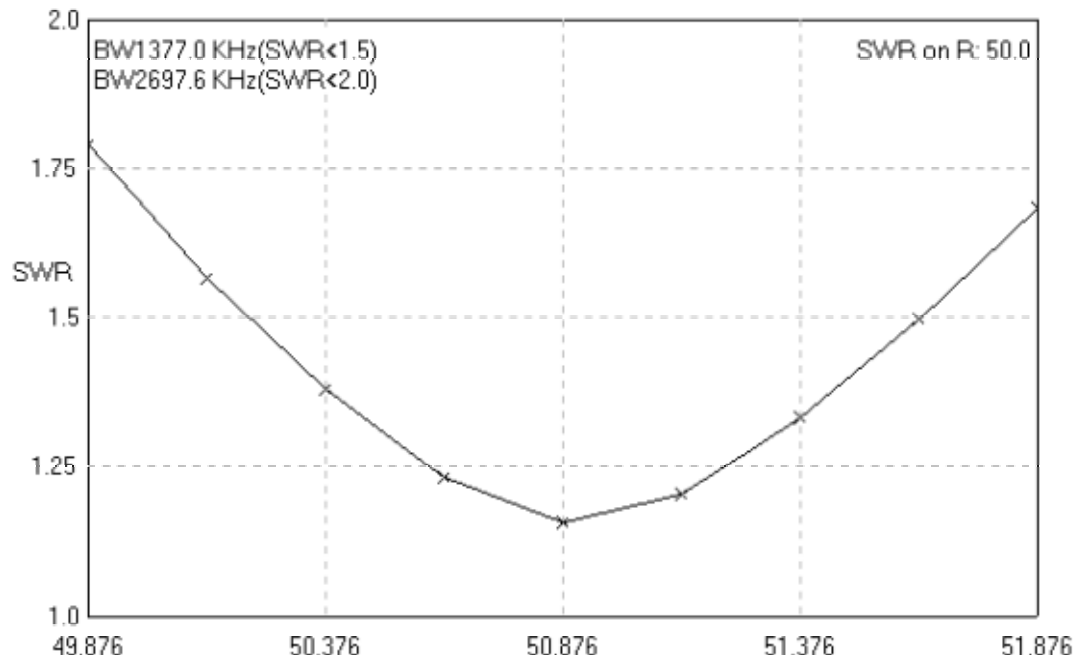

Figure 9 SWR at 50- Ohm coaxial for 'narrow' antenna

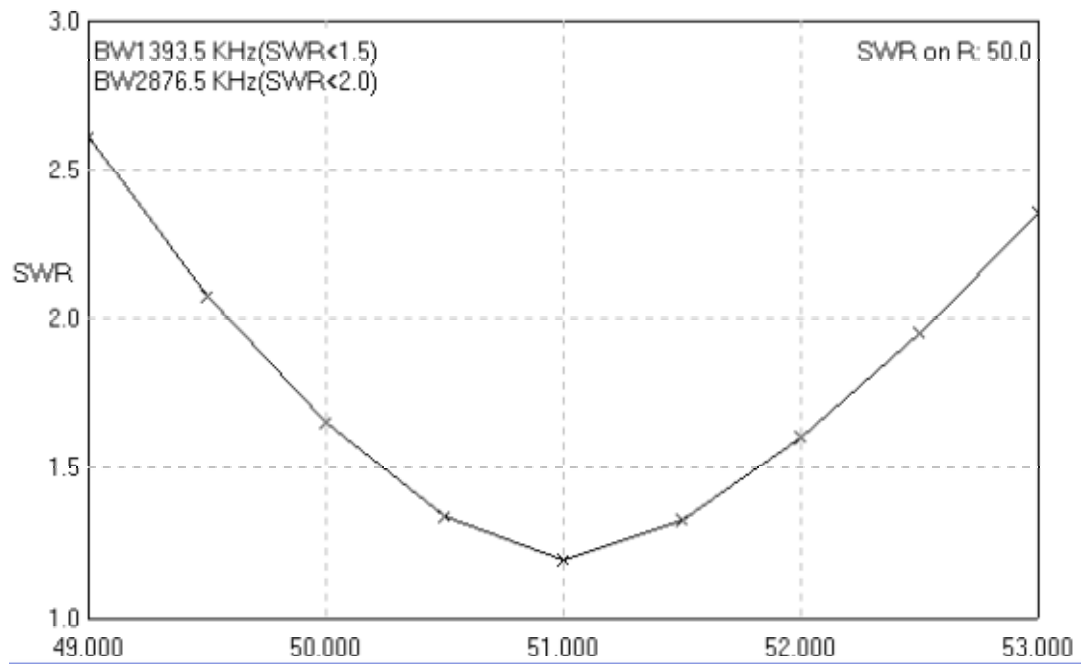

Figure 10 SWR at 50- Ohm coaxial for 'wide' antenna

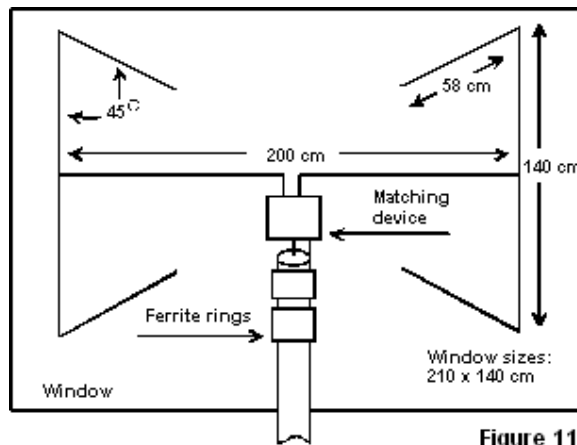

Figure 11

Figure 11 A window dipole antenna with capacitive loads of central installation

Adjustment of the both antennas is simple. A SWR-meter or HF- bridge (see References [1]) is connected to feed points of the tuned antenna. Gradually shorten moustaches (symmetrically each moustache) of the antenna to minimum SWR or when antenna input impedance is just active (have no reactance) at needed frequency. At shortening moustaches the moustache wires roll up to a little coil.

Input Impedance of 10-meters Band Window Dipole Antennas with Capacitive Loads

Theoretical parameters of the antennas (copper, wire in 1-mm (18- AWG) diameter) were simulated with the help of MMANA. Figure 13 shows input impedance of the antenna shown in Figure 11. Theoretical input impedance of the antenna is 22- Ohms. Practically measured input impedance of the antenna was 30-Ohms. Losses in neighbor objects add the 8 Ohms. Theoretical gain for the antennas is near 1,5- 1,7 dBi.

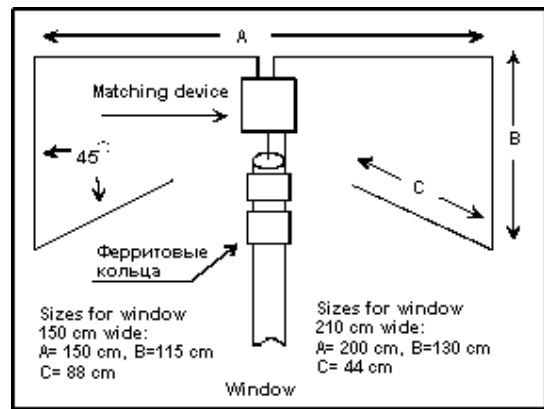

Figure 12

Figure 12 A window dipole antenna with capacitive loads of up or down installation

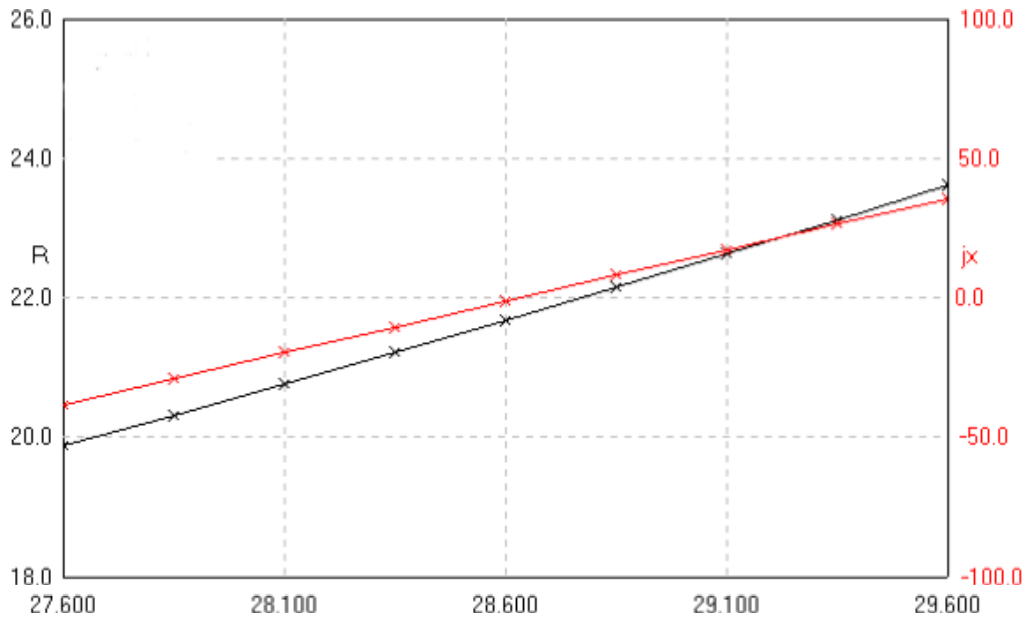

Figure 13 Input impedance of the antenna shown in Figure 11

Feeding of 10-meters Band Window Dipole Antennas with Capacitive Loads

Since 10- meters band window dipole antenna with capacitive loads has low input impedance a matching device must be installed between the antenna and feeding coaxial cable.

MMANA allows to simulate such matching device. **Figure 14** shows schematic of that matching device as well as data for different antennas. Of course, it needs adjust a little the L and C to particular antenna.

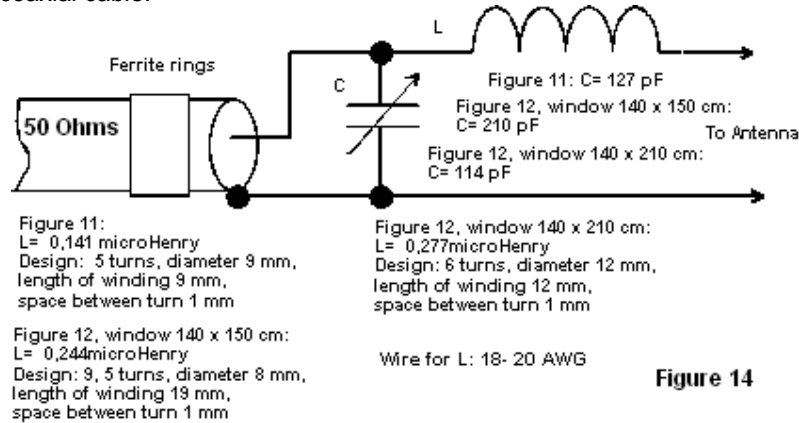

Figure 14

Figure 14 Matching device for antenna with capacitive loads

SWR of 10 – meters Band Window Dipole Antennas with Capacitive Loads

Figure 15 shows a SWR at 50- Ohm coaxial connected through a matching device (see **Figure 14**) to antenna shown at **Figure 11**. SWR was simulated by MMANA.

The antenna has theoretical pass band 375 kHz at SWR 1,5:1 at 50- Ohm coaxial cable, and pass band 750 kHz at SWR 2:1 at 50- Ohm coaxial cable. It is not enough for working at all 10- meters band. However, due the losses at neighbor subjects the pass band of the antenna is wider the theoretical one.

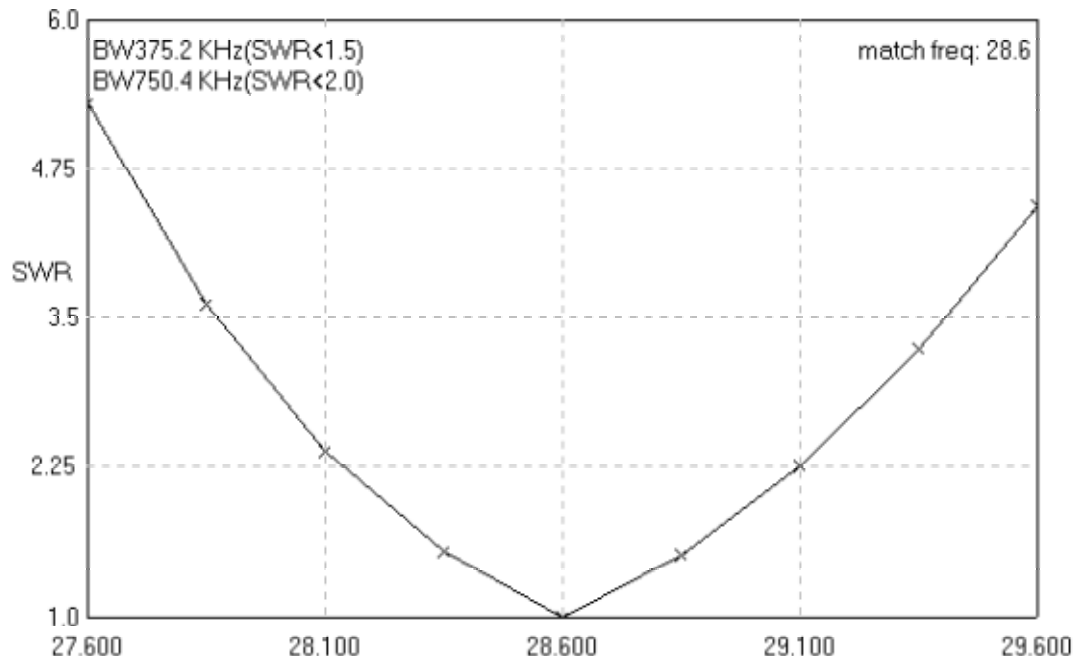

Figure 15 SWR at 50- Ohm coaxial connected through a matching device (see **Figure 14**) to antenna shown at **Figure 11**

Parameters of the 10- meters Band Window Dipole Antenna with Capacitive Loads of Up and Bottom Installation

Theoretical parameters of the antennas (copper, wire in 1-mm (18- AWG) diameter) (see **Figure 12**) were simulated with help of MMANA. **Figure 16** shows input impedance of the antenna installed at window 150 cm wide.

Figure 17 shows input impedance of the antenna installed at window 210 cm wide. Theoretical input impedance for 'narrow' antenna is 12- Ohms, for 'wide' antenna- 26- Ohms. Practically measured impedance is higher on 8- 10 Ohms the theoretical due losses at neighbor subjects. **Figure 18** shows a SWR at 50- Ohm coaxial connected through matching device (see **Figure 14**) to 'narrow' antenna (see **Figure 12**).

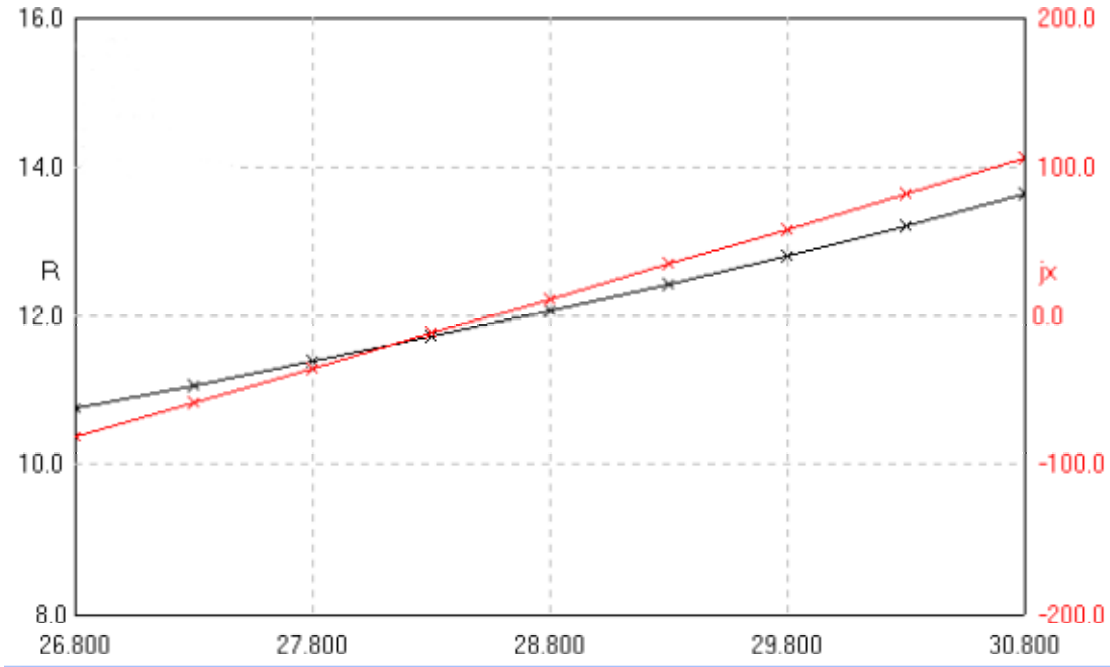

Figure 16 Input impedance of the antenna installed at window 150-cm wide

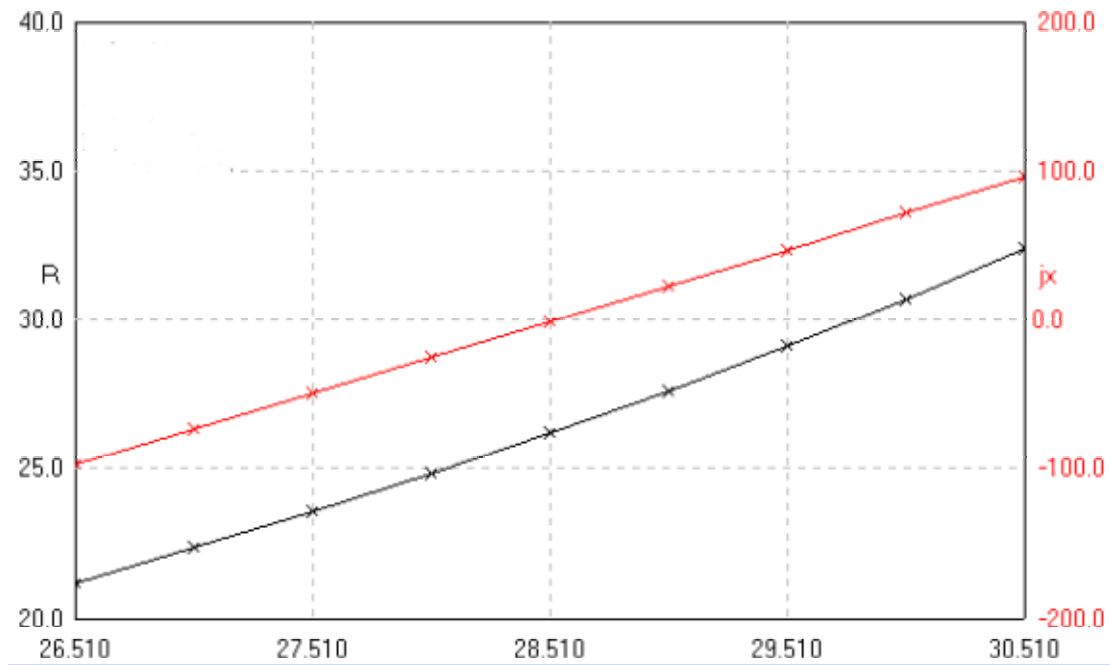

Figure 17 Input impedance of the antenna installed at window 210-cm wide

PROJECTS for QRP

Window Dipole Antennas with Capacitive Loads

Figure 19 shows a SWR at 50- Ohm coaxial connected through matching device (see **Figure 14**) to 'wide' antenna (see **Figure 12**). SWR was simulated by MMANA. Theoretical gain for the antennas is near 1,1-1,3 dBi

A 'narrow' antenna with capacitive loads of up or down installation has theoretical pass band 157 kHz at SWR 1,5:1 at 50- Ohm coaxial cable, and pass band 314 kHz at SWR 2:1 at 50- Ohm coaxial cable. A 'wide' antenna has theoretical pass band 425 kHz at SWR 1,5:1 at 50- Ohm coaxial cable, and pass band 733 kHz at SWR 2:1 at 50- Ohm coaxial cable.

So those antennas can work only at a part of the 10 meters band. For working at all 10- meters band matching device can be retuned for needed frequency. However, the 'wide' antenna often works at all 10 meters band without retuning the matching device due losses at neighbor subjects.

References:

1. Igor Grigorov. Antennas. Matching and Adjustment. – Moscow. RadioSoft, 2002. ISBN 5-93037- 087-7
2. <http://dl2kg.de/>

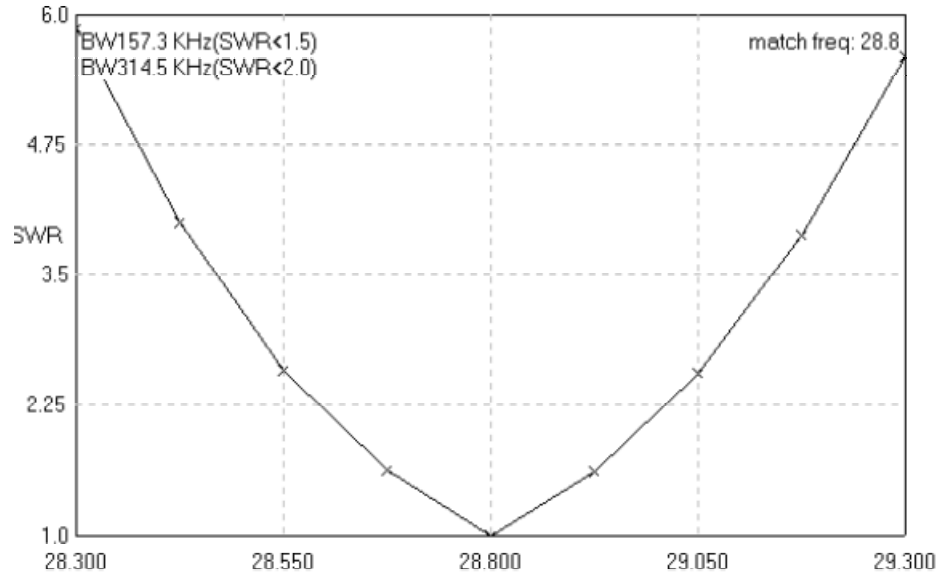

Figure 18 SWR at 50- Ohm coaxial connected through matching device to 'narrow' antenna

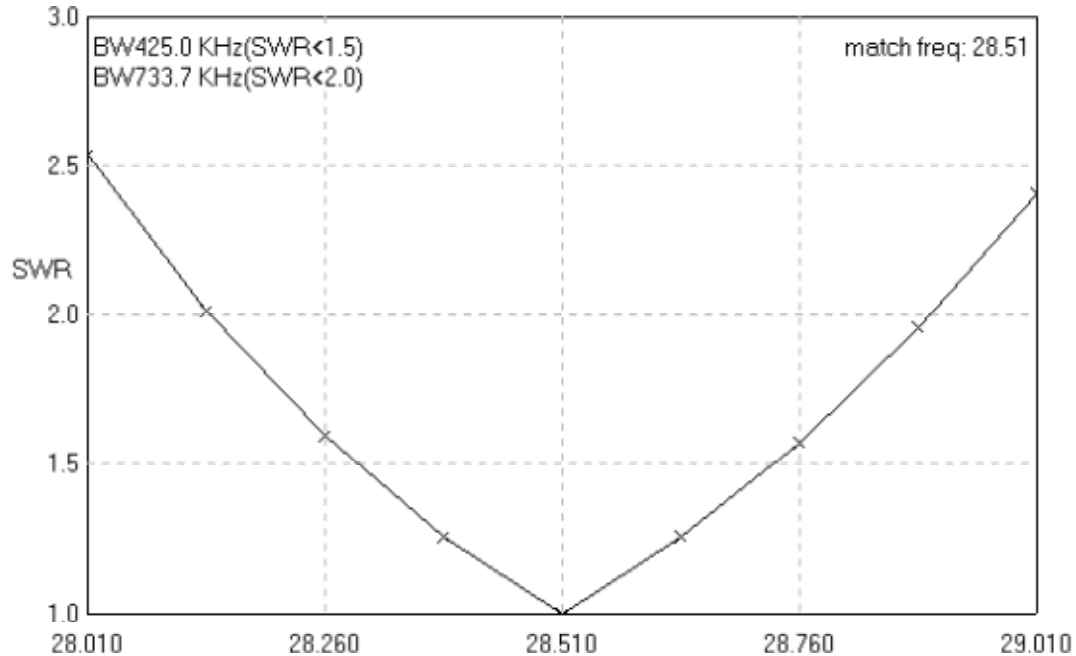

Figure 19 SWR at 50- Ohm coaxial connected through matching device to 'wide' antenna

J- Antenna for 160, 15 and 10(FM) meters Unusual Look to Usual Things

by Valentin Gvozdev , RU3AEP, <http://www.vgvozdev.narod.ru/gvozdev@excite.com>

Introduction

After getting my first amateur license I had to think, what antenna to build for a top-band (160 m), I realized, that conditions are too bad for it. I live in a 7-floor house, which has a roof with a high slope (about 35-40 degrees), which is very dangerous to operate on it. Also, the house is almost completely surrounded by wide streets and electrical wires going along them. After long thinking, I concluded, that there is only one possibility to make an antenna - to hang up a long wire from my roof to the roof of another house. Unfortunately, any dipole-type antenna was unacceptable, because in this case my apartment would have been too far away from the feed point of the antenna, and the condition of right angle (90°) between feeder and antenna itself could not be satisfied. Fortunately, in that time I have read about one very old, but not frequently used antenna - so called Zeppelin-antenna with a matched feeding.

Classical design with an opened line

Actually, this is shortly described in well-known book ("Antennenbuch"), written by DM2ABK (Karl Rothammel), but has been recently developed by Sergey Makarkin (RX3AKT), a radioamateur from Moscow, who has published a good article in "Radio-Design" journal (N2, 1998).

Classical design is presented below (**Figure 1**). As it can be seen, there is feeder with rather high impedance (~300-600 Ohm), and 1/4-wavelength matching line. From one end, this line is shortened, and here its impedance is just a zero (current is high, but voltage is almost zero). Another end of this line is connected to the long wire, which has length exactly 1/2 wavelength. At this point, the impedance is very high (several kilohms). That is why, a big voltage exists here during a transmission. This is quite suitable for a wire feeding, because a 1/2-wavelength has high impedance when fed from the end.

Figure 1. Classical Zeppelin-antenna design

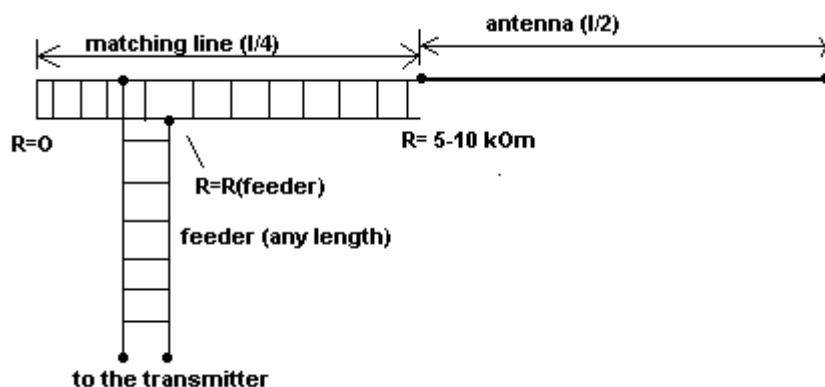

The feeder from the transmitter with a specific impedance R_f is connected to the matching line in the point, where impedance of the latter is equal to that of the feeder. Such point is usually located not so far from the shortened end. If everything is done properly, feeder may have any length and SWR is closed to 1:1 in rather narrow band, central frequency of which is determined by the geometrical size of matching line and antenna.

Classical design with a coaxial cable for 160 meters

This design can be used almost without change, but instead of symmetrical feeder a coaxial cable can be used to connect the whole system to the unsymmetrical output of the transmitter (**Figure 2**). Using of a coaxial cable instead of an open line has one big advantage – in contrast with the symmetrical transmission line it is almost insensitive to the environment, weather conditions and can be placed really everywhere.

Such antenna with feeding 'from the end' is much more easy to make, that a simple dipole. Here, antenna wire bears only itself, and this reduces the mechanical strength and thickness of the wire to be used. Also, you may use your window as one the point of antenna fixing. In this case, all the cable will be inside your shack and antenna could be tuned precisely in comfortable conditions. If the beginning of antenna is

outside the apartment, most part of matching line can be used as the continuation of the feeding cable.

On **Figure 2** there is a design, that I implemented for using on 160 m amateur band, and which, to my mind, is a perfect solution for the people, who cannot mount a classical dipole.

Figure 2. Long wire antenna for 160 m with a coaxial matching line.

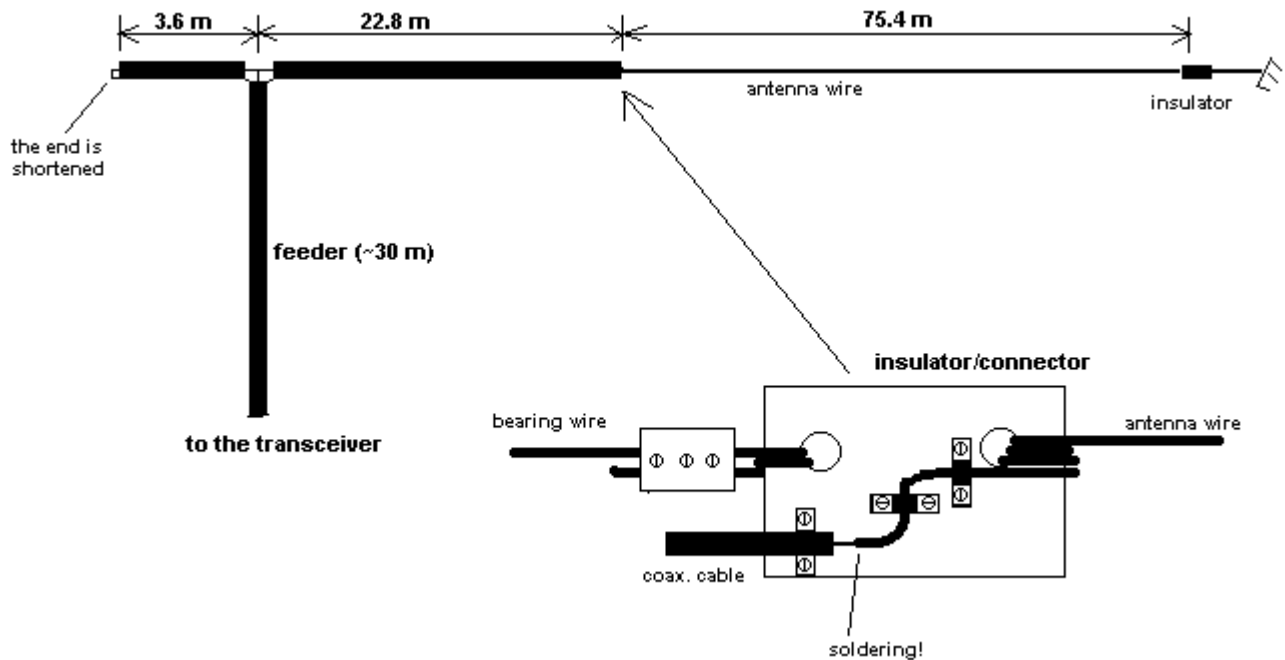

In my case, all coaxial cables have 75 Ohm impedance, the antenna wire, as well as two bearing wires are made from very hard bimetallic insulated cable (outer diameter is about 3 mm). The trickiest part - the connector between cable and antenna - is shown on **Figure 2**. It should be noted, that voltage on it is quite high, and so everything should be well insulated from each other. It is good idea to place this connector somewhere indoors, otherwise rains and snow may cause decreasing of insulation efficiency and antenna performance. This antenna uses a tuned line made from the coaxial cable, and for proper operation of the whole system the antenna wire should have the length equal to the $\lambda * 0.95/2$, and the coaxial line must resonate on the working frequency.

closed to $\lambda / (4 * \text{sqrt}(d))$ (sqrt - Square Root, d - dielectric constant of the insulator used in the coaxial cable). SQRT(d) value is typically about 1.52 for most cables with polyethylene-based dielectric, that is why, 'shortening coefficient' is about 0.66. But the practical value will be a little different from that.

It is a good idea, to connect the shortened end of the matching line to the ground (cold water pipe, heating system, building elements etc.) to provide adequate safety and to reduce possible TV/RF interferences while transmitting.

The lengths indicated on **Figure 2** are mine values, and they can be used as the approximate reference. Exact numbers depends on the antenna environment and should be determined experimentally. It should be noted, that in 'ideal' case it is not a simple task, because in such system three values have to be varied (one is antenna length, and another two are lengths of the parts of the matching line). But as it appeared from my experience, for practical purposes the most important thing is to choose correct total length of the matching line, which must resonate on the desired frequency.

Tuning and adjusting of the antenna

To do this, I suggest to use the following technique. To make your line resonate on the middle of the band (1890 kHz), you first have to make the line about 1 m longer, that estimated length of the tuned line (for example, 24 m), making shortened segment about 3.6 m. Then, connect the 2-3 kilohms resistor to the "open" end of the line, and

To achieve what was declared in the previous paragraph, first of all the precise length of the matching line should be determined. Theoretically, it should be

the transceiver through SWR meter - to the feeder. The resistor here serves as a loading instead of the antenna wire.

After assembling of the system, put RF power (1-2 W or even less is enough) on some frequency inside 160 m band into line and watch the SWR. If the line is completely out of resonance, SWR will be closed to infinity, and no power will be dissipated on the resistor. Then, the frequency should be found, which gives the sharp minimum of the SWR. It has to be around 1800 KHz. Here, the SWR is usually less than 1.5:1, and the full power of the transceiver is dissipated on the resistor, which means, that the matching line works well. When touching the 'hot' end

of the loading, it may be seemed, that is really very hot – this is due to the high HF voltage, which causes skin burning (be careful to do it, even by low power of RF source!).

For better understanding of these processes is useful to look to the results of simulation of this system using Pspice simulation software. The equivalent schematics (Figure 3) includes voltage source V1 in series with 75 Ohm resistor (which emulates output resistance of the transmitter), two coaxial lines T1 and T2 and loading R2. Since Pspice does not allow to set lengths of the transmission lines directly in length units, they are set in wavelengths (NL) on the specified frequency (in our case, F=1.89 MHz).

Figure 3. Equivalent schematics for matching line, used for simulation.

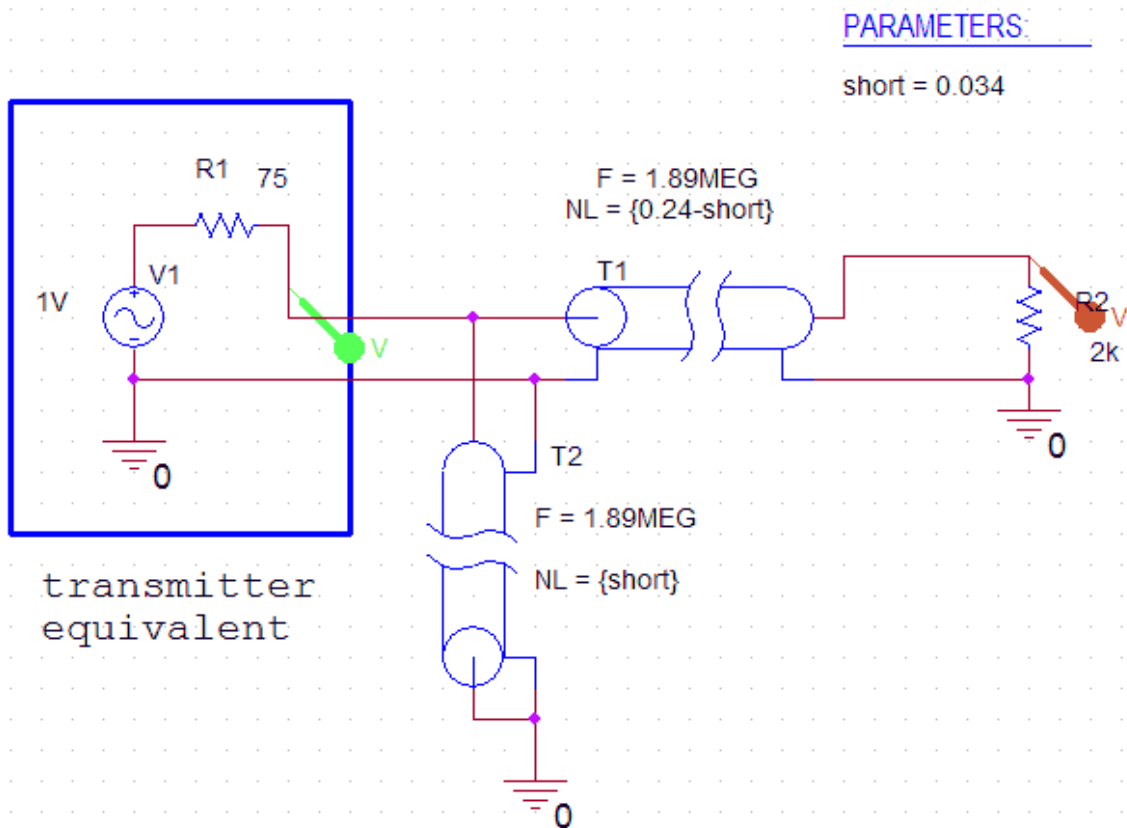

Calculated frequency response is presented on the Figure 4. Here, the colors of the traces correspond with the colors of the voltage markers on the schematic. As it can be seen, on the resonant frequency about 1.95 MHz there is sharp voltage maximum on R2 (red trace), which reaches 2.6V – it is about 5 times more, than the voltage on the transmitter's output (green trace). Also it should be noted, that on the resonant frequency voltage on R1 (green trace) is closed to one half of source voltage (in our case, 1V). Practically, it means, that there is good matching between transmitter and the "antenna" and most of generated power is dissipated on the loading.

After the resonance has been found, it should be shifted up to the desired frequency. To do this, the end of the cable should be cut carefully in several steps, watching the resonance frequency each time, which must increase with each cut. After you achieve the desired frequency, the matching line is almost ready, and you can mount the whole antenna system in the chosen place. It should be noted, that the minimum of the SWR in mounted antenna is usually 20-30 kHz down, compared to the value achieved by the tuning on the resistor.

Figure 4. Frequency response of the matching line in range 1 – 2.5 MHz

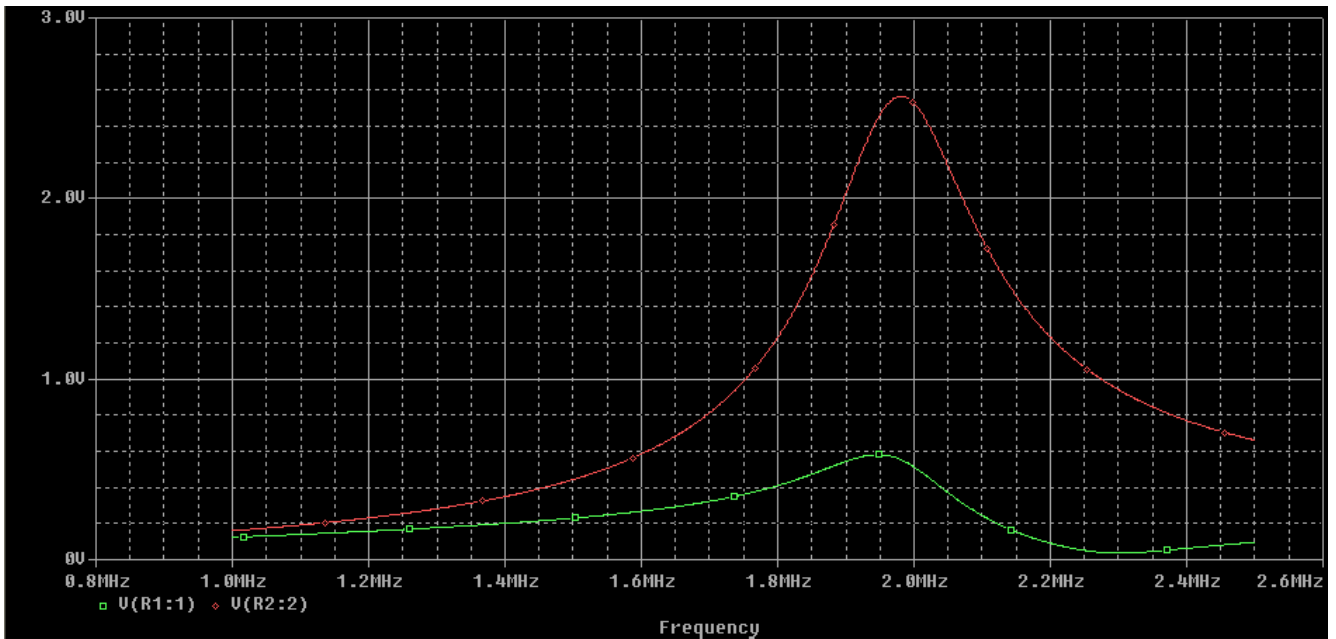

In my case, the antenna for 160 m band had a minimum of SWR at 1875 kHz (about 1.3:1), on the edges of the band SWR increased to 2.0...2.5:1, since the design is a narrow-band one. Compared to my previous dipole, which hanged on the low height (about 5 meters over the ground) along the building, this antenna exhibited much better transmission efficiency and higher signal to noise ratio while receiving.

The same design for 10 meters - cheap and simple.

About 2 years after getting my first amateur license I upgraded it to the higher license class, which allowed me to operate on 10 meters SSB. In that year, there was a perfect propagation on 10 meters band during the daylight time, and I needed an efficient antenna to work on it. Probably, in some time I will have something like rotatable multielement Yagi on my roof, but now it seems to me inaccessible as the Moon due to many factors. After some time I decided to repeat what I built for 160 meters for 10 meters, proportionally reducing all geometrical sizes of the antenna wire and matching line.

Since the wavelength on 28500 KHz is just 10.52 m, a half-wavelength dipole should be about 5 meters, and the total length of the coaxial matching line will be $10.52/(4*1.52) = 1.73$ m. The feeder is connected to the line 23 cm away from the shortened end. These sizes are relative small and the whole antenna system may be placed without being mounted on the roof, for example just from your window to the neighboring tree.

I made the antenna from a 2 mm copper wire with a plastic insulators at the ends, using 75 Ohm coaxial cable for feeder and matching line. There was nothing

difficult to tune the system - I hanged the antenna across my apartment and adjusted the length of the matching line as described above for 160m design using 1.80 m as the starting value. The only thing that should be noted is that the actual resonance of the line is very sensitive to the length variations, so on the final steps the cable should be cut in 1 cm (!) portions or even less to not miss the desired resonance position. After I hanged the antenna on the designated position, SWR was less then 1.5 on all frequencies ranging from 28200 to 29000 KHz.

This antenna is really very simple and cheap, but nevertheless, I allowed me to establish many connections with Europe and even Far East using just about 10 Watts of power. I really enjoyed working on 10 meters ether in local communications and transnational QSOs, and this was made possible just by several hours of time, dedicated to the antenna building and tuning.

About working on other bands – some facts and theory.

Though LW antennas with a feeding through coaxial transformer, which were described above, seem to be monoband, this appeared not completely true. As I found out, the whole system has many resonant frequencies, and some of them, are inside or near amateur bands and can be used for working on these bands.

As it could be expected, operation on the frequencies, which are twice more that 'native' ones, is impossible. When using an antenna for 160 m, on 80 m band observed SWR is closed to infinity and the transmission efficiency is not more that by using a

random wire with length of several meters... Simply it can be understood, that on doubling the working frequency the matching line is completely out of resonance, and works as a “short” for the transmitter. But everything has advantages, and this fact means not only impossibility to work on 80 m, which is definitely bad, but also deep suppression of 2- nd harmonic by working on 160 m, which is really well.

Almost the same situation is on 40 m band. Here the active component of input impedance of the antenna (measured by noise bridge) is also quite low (several Ohms), and no resonance exists inside or near amateur frequencies.

But if you try to work on this antenna on 15 and 10 meters bands, the situation is more optimistic. In my case, on 21430 KHz the SWR was about 1.3:1 and increases to 2.5:1 when moving down to 21000 KHz. Measured impedance was about 55 Ohm with a low capacitive reactance. From first sight, it is quite strange, but nevertheless, antenna behaved well on this band, and using just 10 W of power, I was able to make long-distance QSO's even with North America. The most interesting fact was, that this was “true”

resonance of the antenna, without any participation of the feeder (SWR did not change significantly when the feeder length was alternated).

In contrast to this, on 10 meters band the antenna behaves very poor – the air seems to be “empty”, and even common industrial noise is received with a level comparable to internal noise of the receiver. Compared to the special 10 meters antenna (see above), the signal of distant correspondents were weaker by 10-20 dB (!), and on transmission even my neighbors gave me reports like 53-54. However, when frequency was moved up to 29 MHz and higher, the efficiency improved dramatically.

To understand this phenomenon, some calculations were performed. First of all, it was found, that frequency response of the matching line with a resistive loading (see Figure 3) in range 1.5 – 32 MHz has many maxima, and one of them is inside 15-m amateur band (Figure 5, red trace). Another maxima is near 29.5 MHz – in the upper part of 10-m band.

Figure 5. Frequency response of the matching line in whole HF range

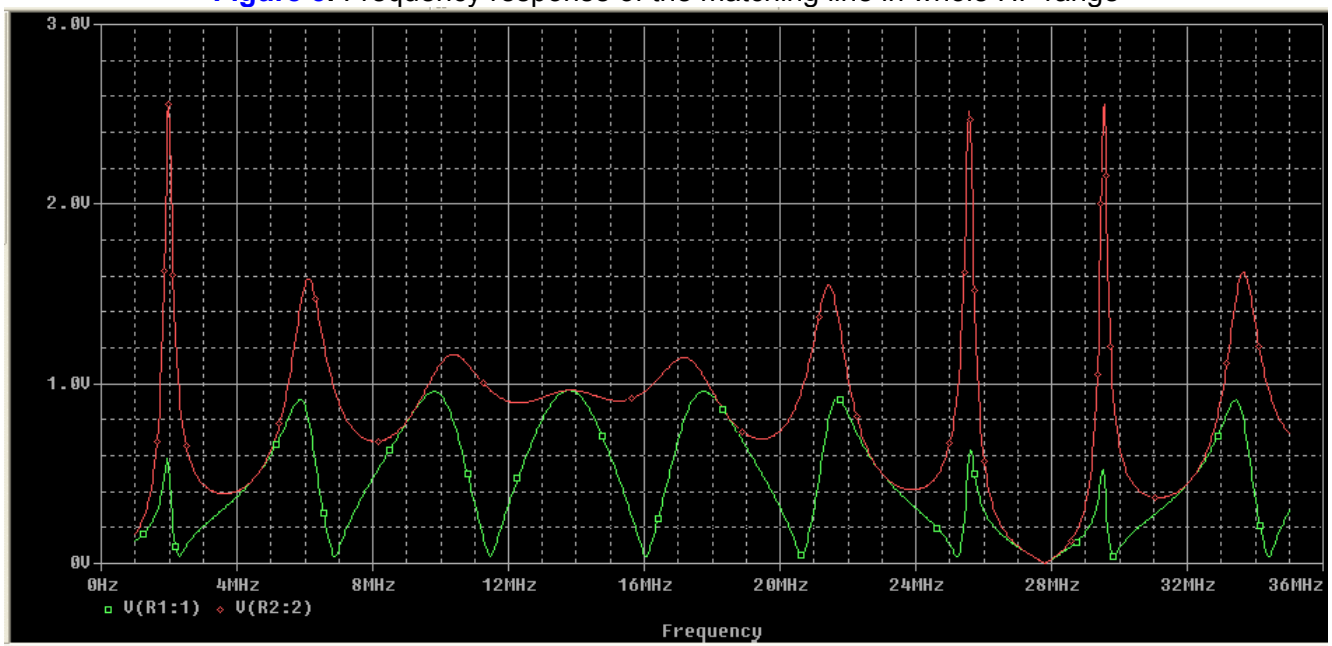

I guess, that these results may be assumed at least as a qualitative explanation of the antenna behavior. I say “qualitative” because the whole system can not be adequately represented by a matching line with a resistor at the end – impedance of the antenna wire also should be taken into account. However it is clear, why besides ‘native’ band, antenna works well on 21 MHz, and why on frequencies about 28500 there is a minimum of performance, which rapidly increases when moving up to 29 MHz.

Conclusion

As a conclusion is can be said, that LW antenna with a coaxial matching line (J-antenna), which is designed for 160 m band, can do perfect job on 15 meters and on a part of 10 meters band also without any switching and tuning devices. Of course, the efficiency on ‘upper’ bands is be substantially lower, that on ‘native’ one due to RF losses in the matching line (which actually works with a very high SWR). But to my mind it is still acceptable, especially in the case, when there are no conditions to mount huge and efficient antennas.

MULTIRANGE TRAP ANTENNAS

Multirange trap antenna: history and fundamentals

Recently multirange trap antennas are widespread among radioamateurs. As matter of fact, the type of antennas was invented in the USA by H. K. Morgan, US patent # 2229856, 1938 (by reference [1]). Probably the first article about a trap antenna was published in reference [2] at 1940. So, what is the antenna and how is it work? Let's see it on the example of a ham vertical trap antenna in order to simplify a problem. **Figure 1** shows us a schematic of such antenna.

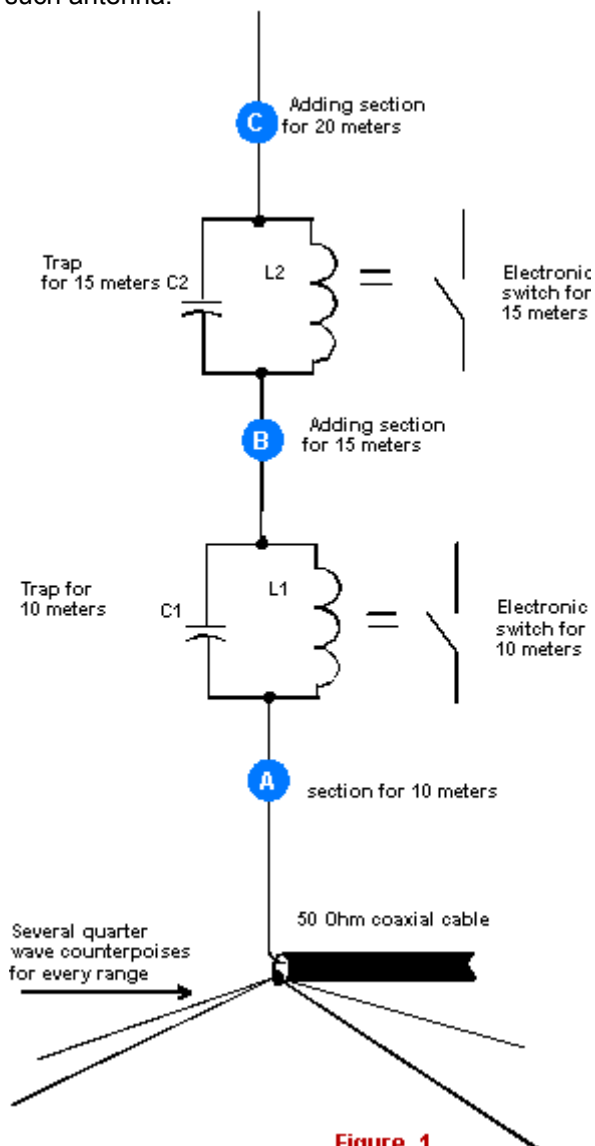

Figure 1 A ham vertical trap antenna

10 meters: Section A is tuned for operation on 10-meters by its length. Trap L1C1 turn off upper antenna parts behind the trap from operation of the antenna when 10 meters range is used.

15 meters: By length of the Section B we tune the antenna parts "Section 1 plus L1C1 plus Section B" to resonance to 15-meters. Trap L2C2 turn off upper antenna parts behind the trap from operation of the antenna when 15 meters range is used.

20 meters: By length of the Section C we tune the antenna parts "Section 1 plus L1C1 plus Section B plus Section C" to resonance to 20-meters.

And so on for other ranges: In the similar way the antenna would be tuned for others ham HF- ranges. You see, it is possible to do an antenna for any number of HF- ranges! But there are several lacks. Upper parts of the antenna behind a proper trap do not use (or, practically do not use) for radiation. Another lack is that the antenna wire is broken at several places by trap circuits. Every trap circuits should be tune in to own resonance frequency. Trap circuits must have high temperature stability, because the antenna is used at the open air. Traps work at a resonance mode so a high level of RF voltage is across trap capacitors at transmission mode. Thereof it needs to use a high quality capacitor for every of the traps.

Vertical trap antenna WA1LNQ: One of the most popular sample vertical trap antenna is the antenna WA1LNQ [2]. The antenna is used on 10 and 15 meters. **Figure 2** shows the scheme for the antenna.

The antenna made from two insulated from each other metal tubes by length of 240,7 (section A) and 62,9 (section B) centimeters and in OD 18 to 25 millimeters. The length of an insulating insertion is 5,8 centimeters. Over the insulating part is spooled the trap spool. A copper tube in diameter of 3 to 5 mm is used for the spool, and the spool contains 2 turns with step 1 turn on 25-mm of winding. Average diameter of the trap spool is 55-mm. As a trap capacitor is used a length of a 50-Ohm coaxial cable with an initial length equal to 80 centimeters.

Tuning of the Antenna WA1LNQ: At first, tune the antenna in 10-m range. At the tuning the length of the coaxial cable, that makes the trap capacitor, is gradually shortened to minimum SWR in 10 meters. After this, tune the antenna to minimum SWR at 15 meters. It is possible to do by a small changing of the length of the upper section B.

Below you can see input impedance, SWR and DD of the antenna W1LNQ. The figures are obtained with the help of Free Antenna Simulation Program

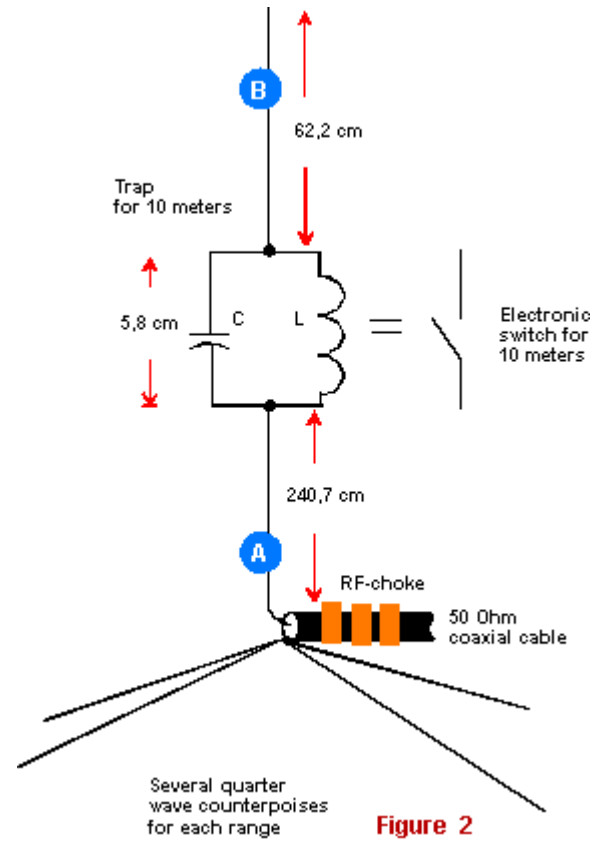
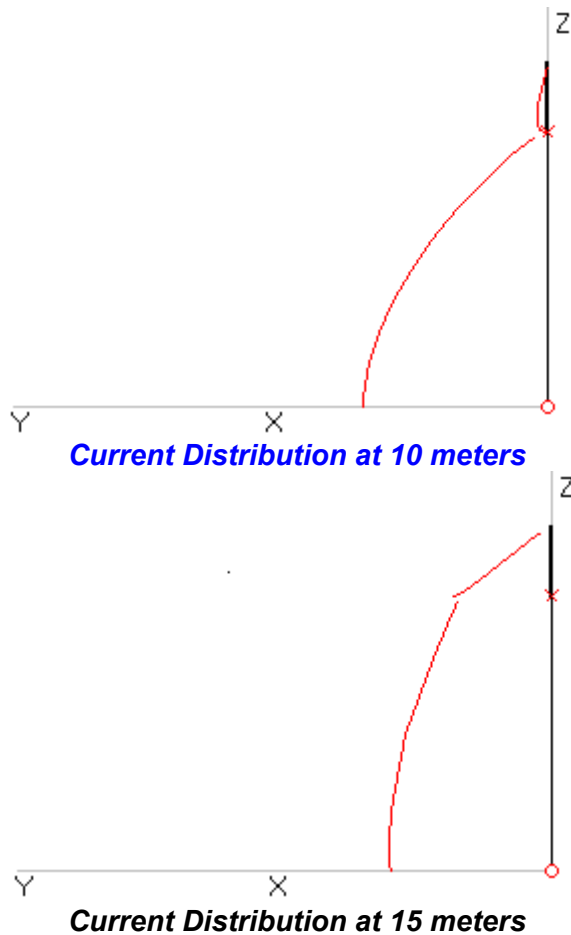
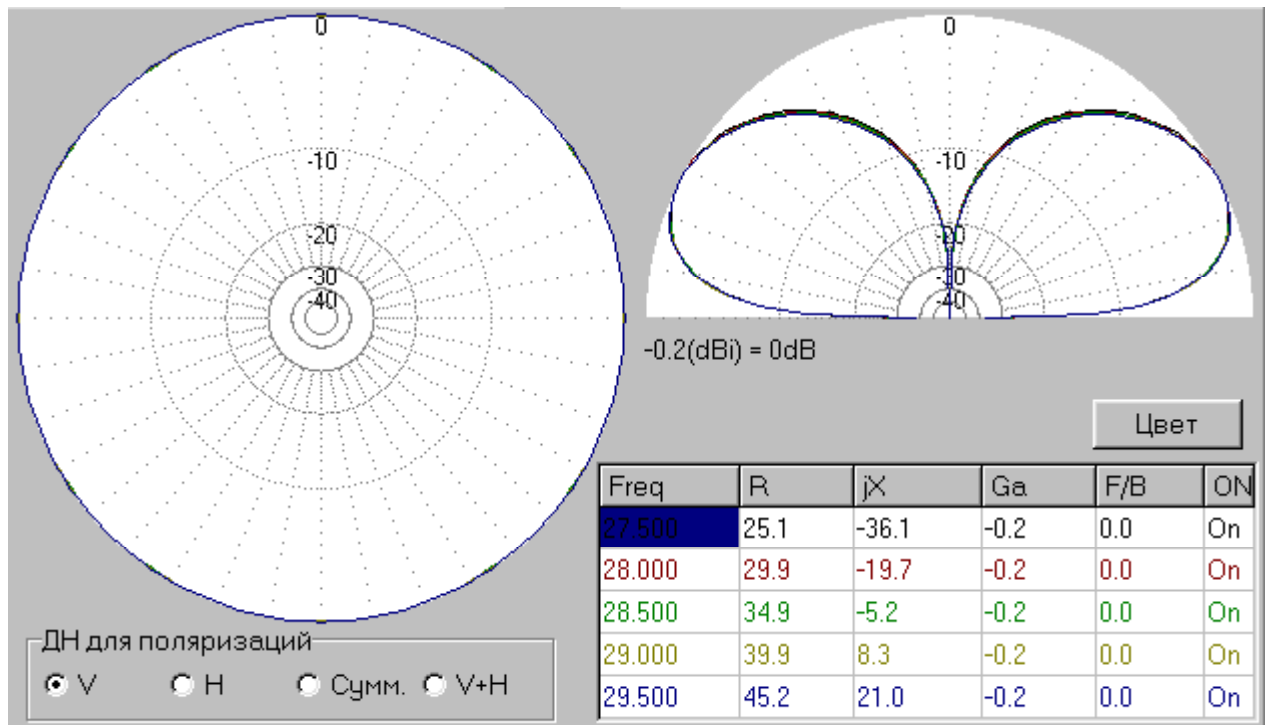

Figure 2 Antenna WA1LNQ

Diagram Directivity and Input Impedance at 10 meters W1LNQ Antenna



MMANA (MININEC based). Section A has diameter of 24 millimeters, section B has diameter of 18 millimeters.

Antenna input impedance. Vertical Trap antenna: You can see that only first antenna part, it is section A at Figure 1, has length in $\lambda/4$. So, the input

SWR at 10 meters W1LNQ Antenna

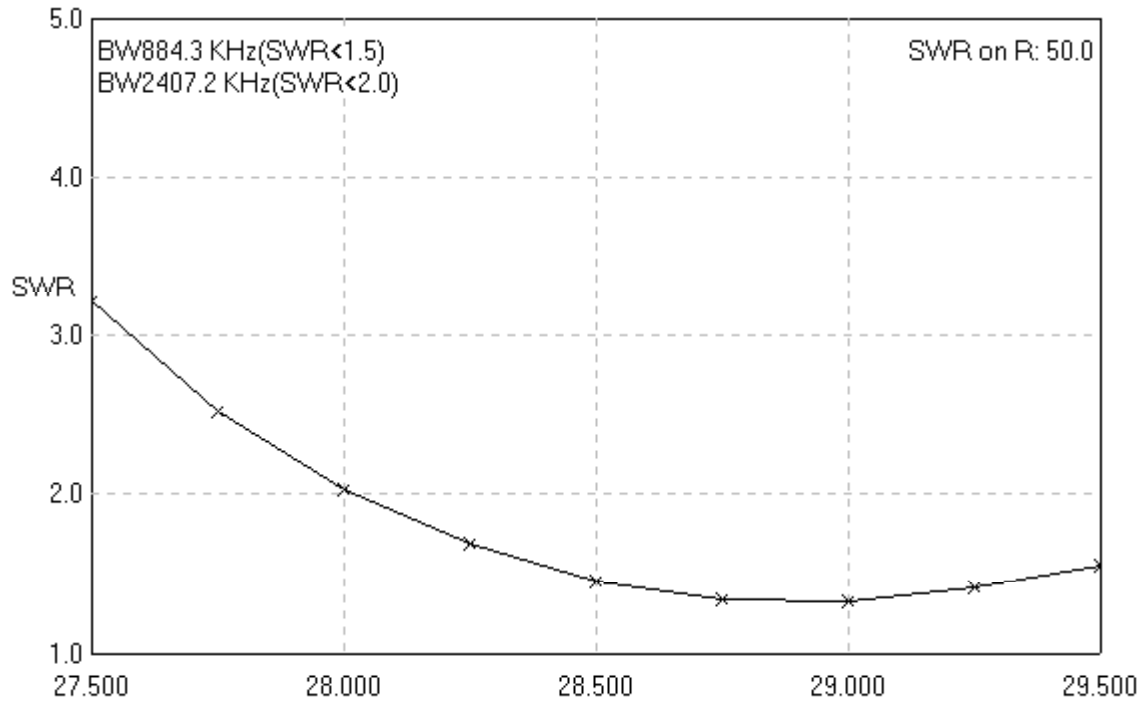
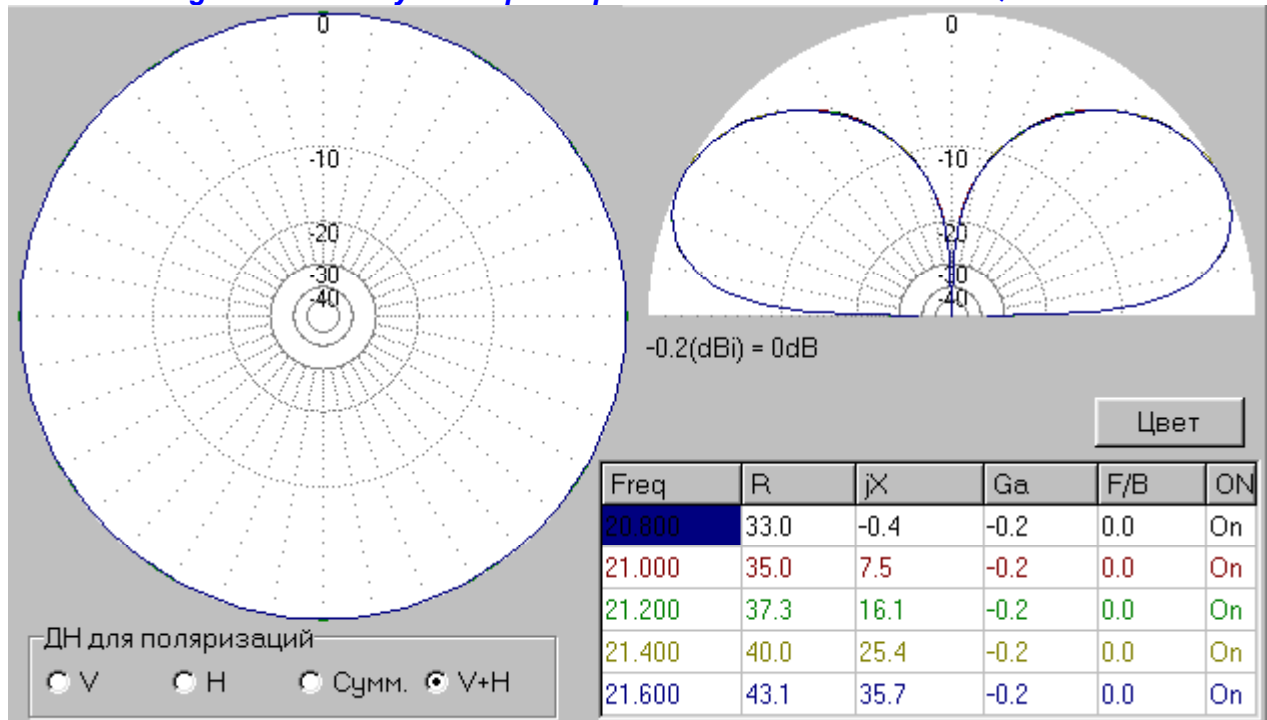

Diagram Directivity and Input Impedance at 15 meters W1LNQ Antenna



impedance of the antenna at 10 meters is close to 40-Ohms, and 50-Ohms coaxial cable can be used for feeding of the antenna at the range. However, physical length of antenna consisting of another following section plus the previously section (or sections) is less than $\lambda/4$. Inductors of the traps work as a lengthening spools for the proper section. Input impedance of the antenna working at lower than 10 meters range is less than 30 Ohms in the theory, but in practice, the input impedance for 15 and 20 meters range is close to 40 Ohms because losses in antenna parts and antenna

ground. So, a 50-Ohms coaxial cable can be used for feeding of the antenna at all of the ranges. For a proper work a vertical trap antenna must have several counterpoises for every of operation ranges, especially for low amateur HF ranges 40-, 80- and 160-m.

Antenna input impedance. Dipole Trap antenna: Morgan trap antenna [1] was done as a dipole. It is known, that a $\lambda/2$ (physical length) dipole antenna has input impedance close to 75 Ohms, see Figure 3A. A shortened by a lengthening spool dipole

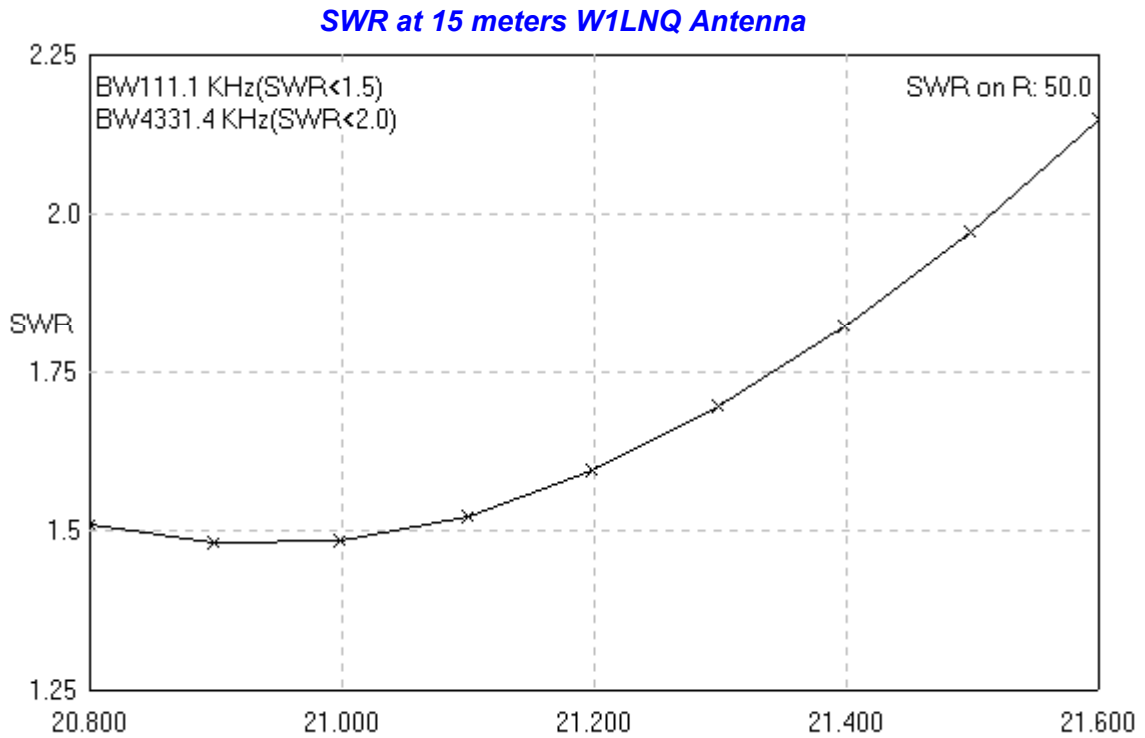

antenna with electrical length in $\lambda/2$ (having physical length bit less than $\lambda/2$) has input impedance less than 75 Ohms and maybe, close to 60- 50-Ohms, see **Figure 3B**. So, for feeding a dipole trap antenna a 50-Ohms coaxial cable can be used with a high efficiency.

number of traps more than one. The reason is that the antenna sections should be electrically insulated from each other. It is hard enough to do a mechanical strength design of such antenna in radio amateur conditions. Radio amateurs usually prefer a W3DZZ antenna. The antenna has only one trap, and, as it seems by many hams, works at several amateur ranges. What is a W3DZZ?

A dipole trap antenna is very easy for tuning and has high efficiency, however, radio amateurs very seldom make as a vertical as dipole trap antenna having a

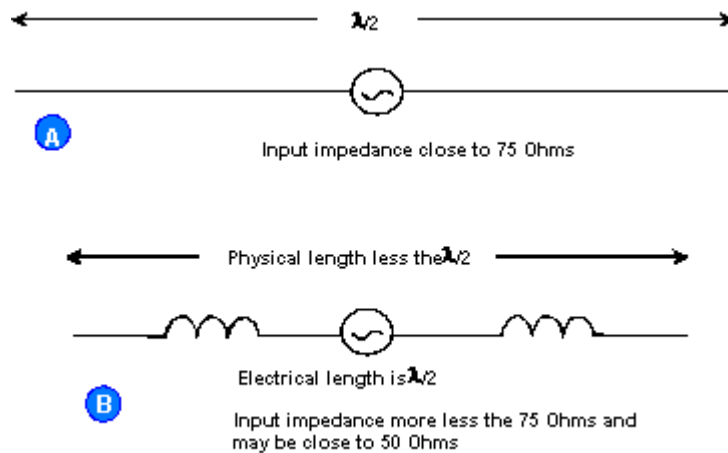

Figure 3

Figure 3 A shortening and full size dipole antenna

Antenna W3DZZ: In 1955 C. L. Buchanan, W3DZZ, developed a multirange dipole antenna with only one trap, see reference [4]. Recently the antenna is known as “antenna W3DZZ.” **Figure 4** shows schematic of the antenna W3DZZ.

Antenna W3DZZ works in several amateurs range with low SWR in its feeder. Proper choosing data of the trap turns the trap or to lengthening inductor at low range (ranges) or to shortening capacitor at high range (ranges), or to only a trap at a proper range. For the antenna shown at **Figure 4**, trap LC is the trap for 40

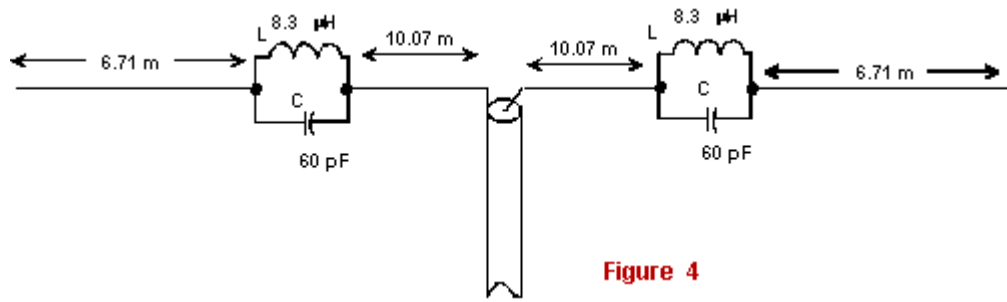

Figure 4

Figure 4 Antenna W3DZZ

meters, lengthening inductor for 80 meters, and shortening capacitor for 20, 15 and 10 meters. The antenna (Figure 4) does not work at WARC bands. However, the antenna does not work properly at 20, 15 and 10 meters. You can see data obtained with [Free Antenna Simulation Program MMANA](#)

(MININEC based) for the W3DZZ (see Figure 4). Antenna wire has diameter of 2 millimeters. You can see, that a SWR at 20, 15 and 10 meters is too high. It is impossible to find such length of the antenna and data for trap that the antenna works at all of the ranges! So, an ATU and a good coax is need for the antenna if you work at 20, 15 and 10 meters.

SWR at 80 meters W3DZZ Antenna

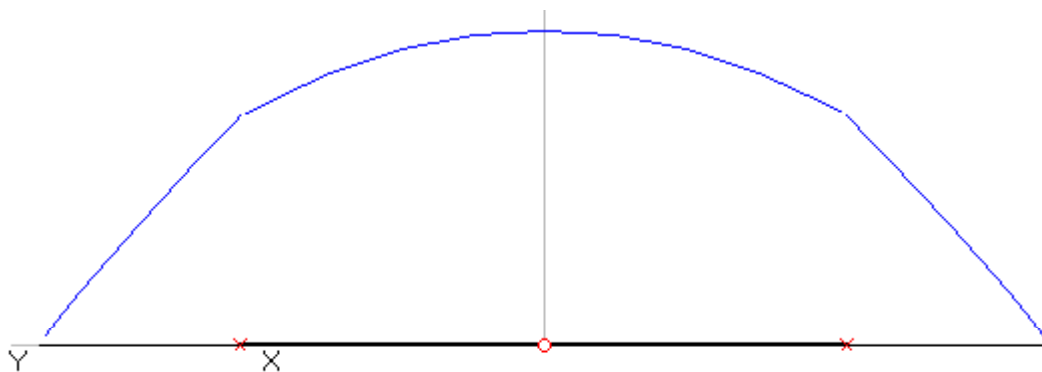
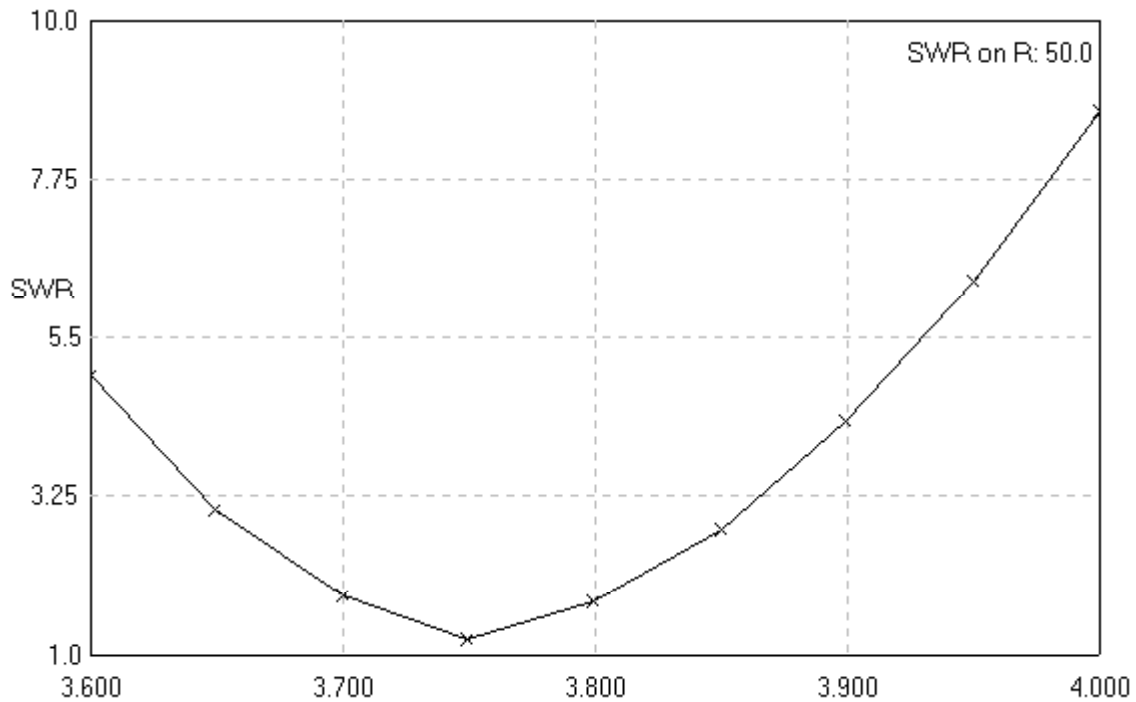

Current Distribution at 80 meters W3DZZ Antenna

Input Impedance at 80 meters W3DZZ Antenna

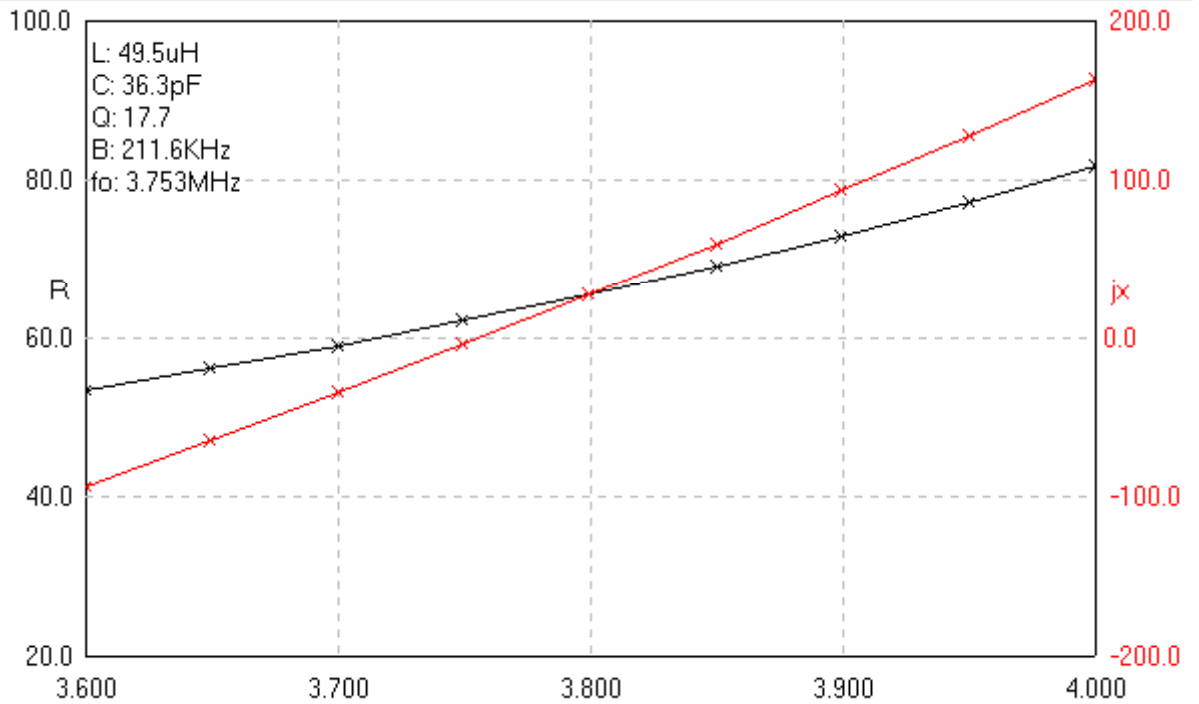

SWR at 40 meters W3DZZ Antenna

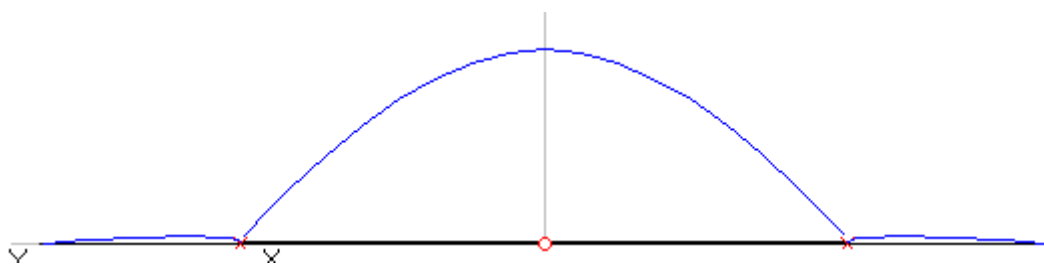
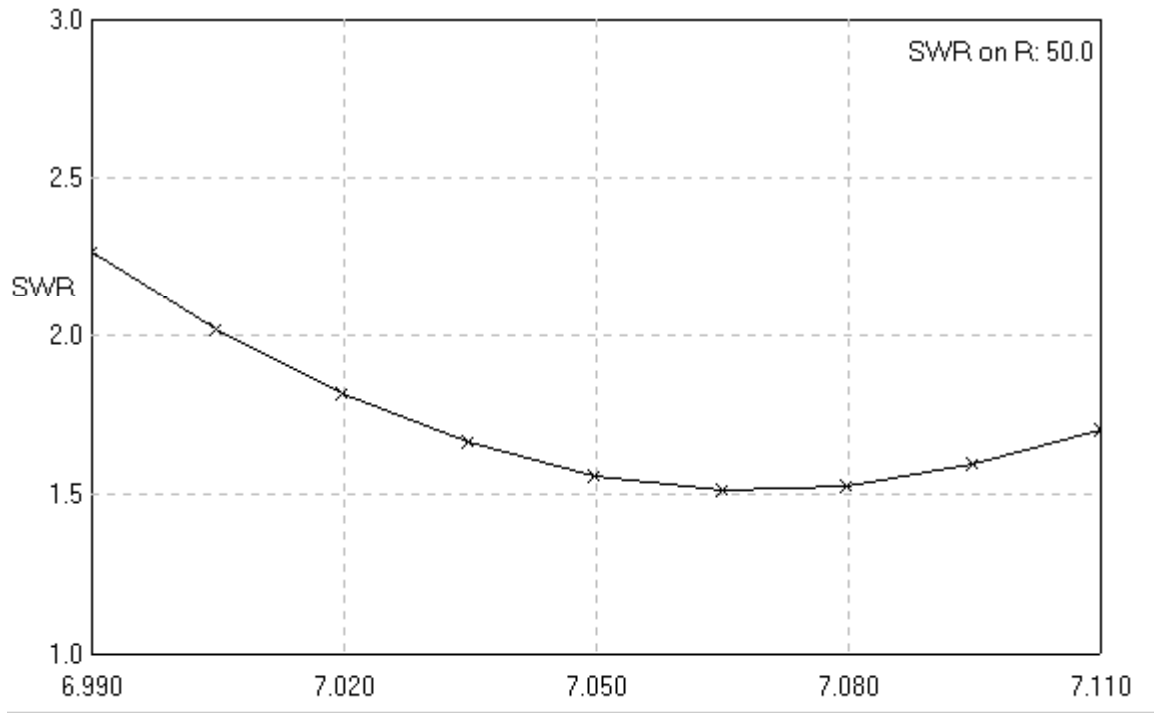

Current Distribution at 40 meters W3DZZ Antenna

Input Impedance at 40 meters W3DZZ Antenna

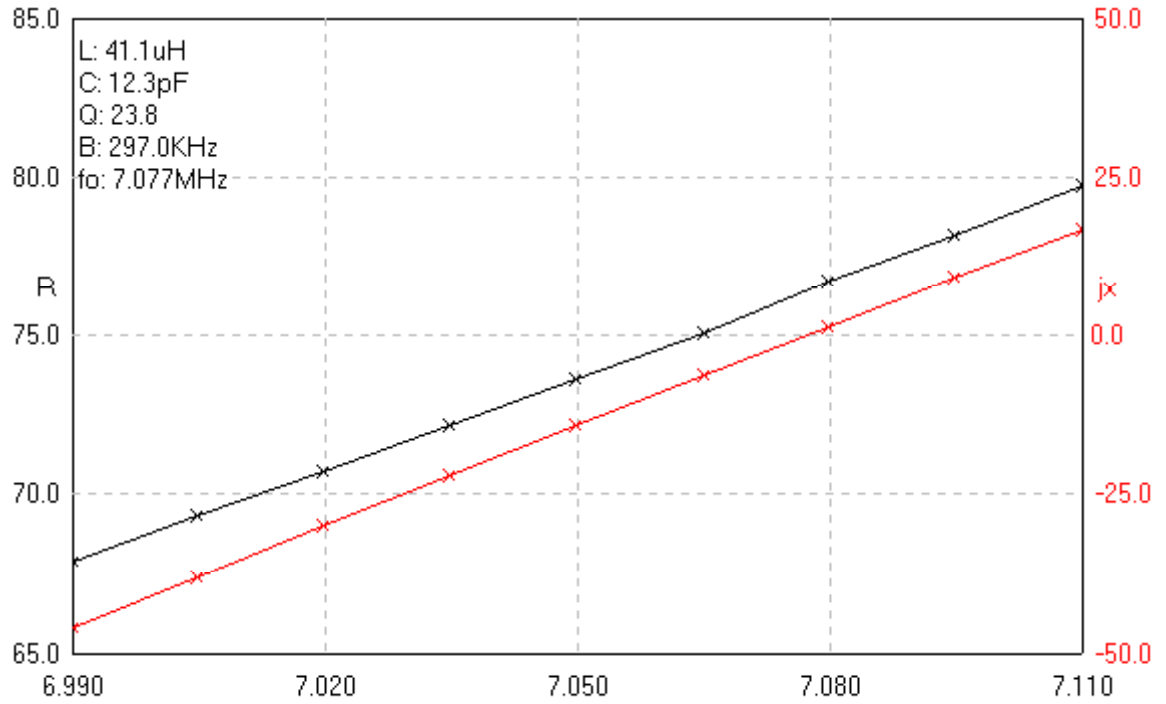

SWR at 20 meters W3DZZ Antenna

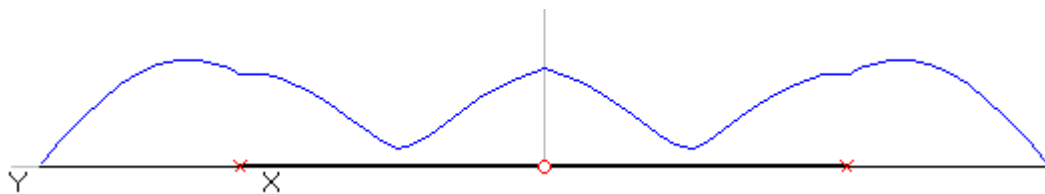
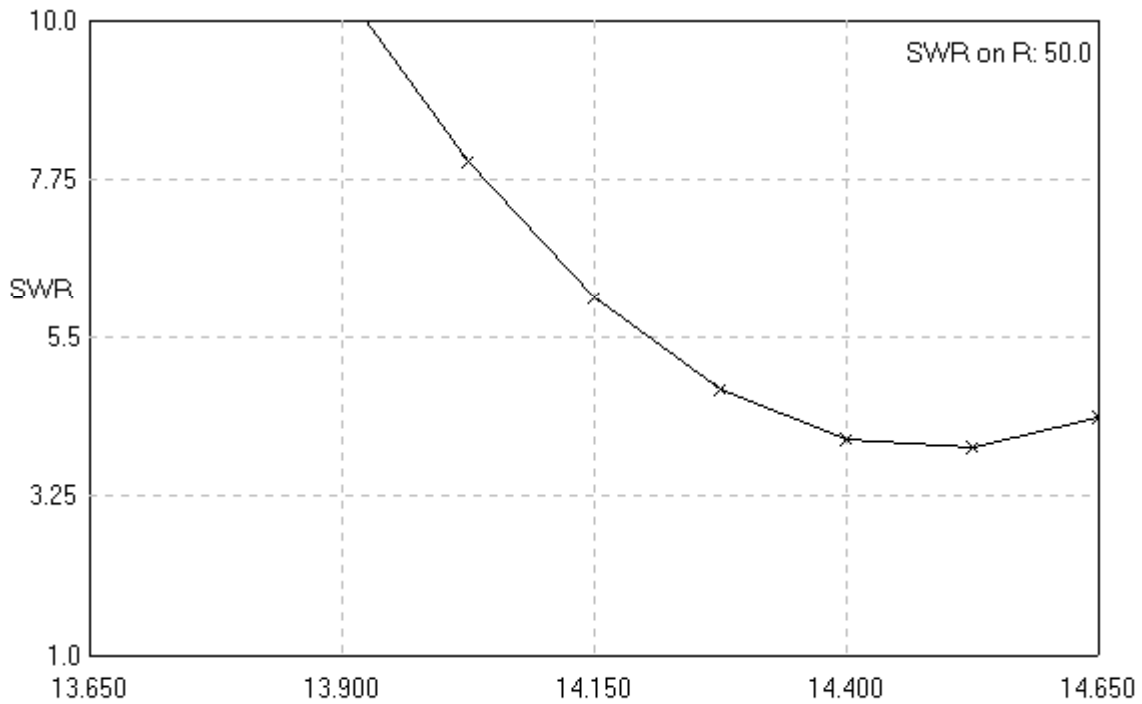

Current Distribution at 20 meters W3DZZ Antenna

Input Impedance at 20 meters W3DZZ Antenna

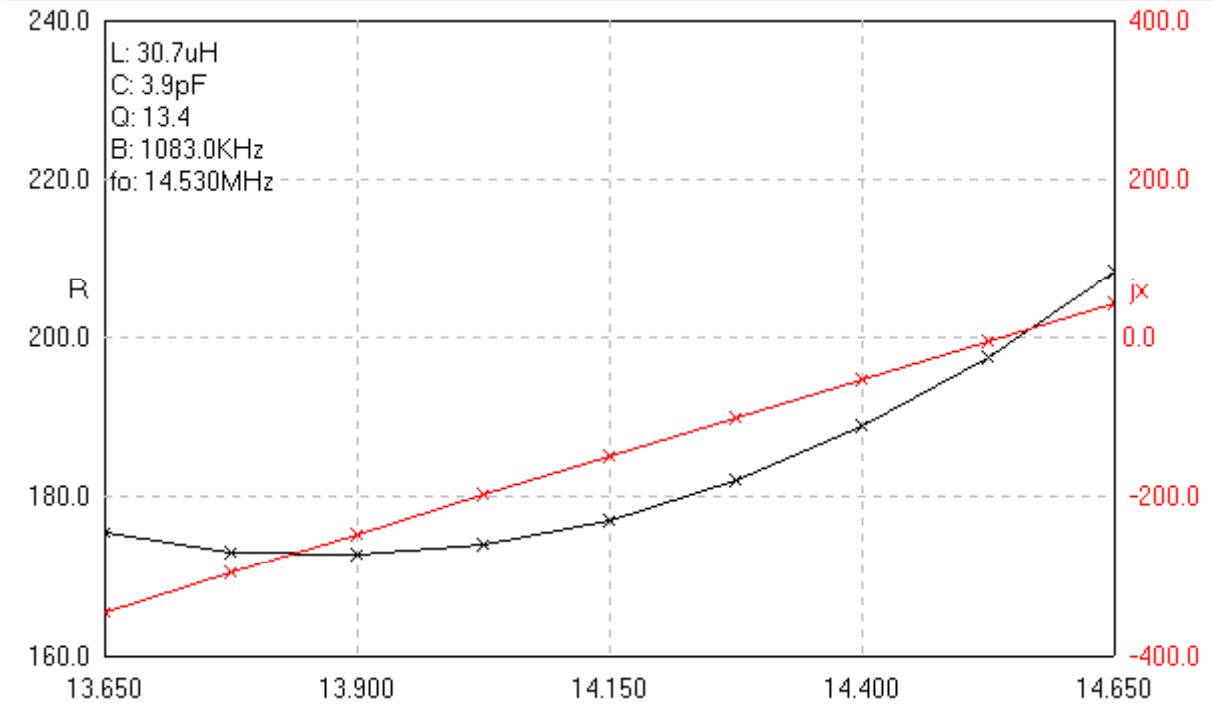

SWR at 15 meters W3DZZ Antenna

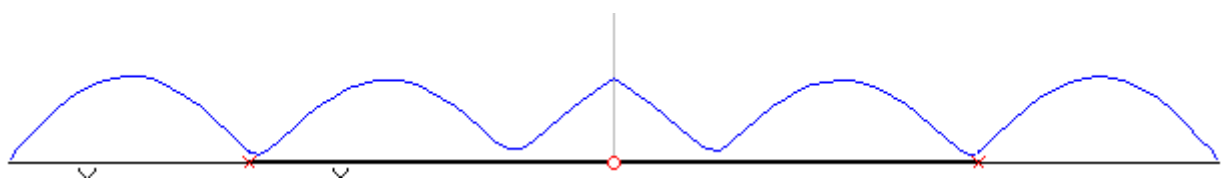
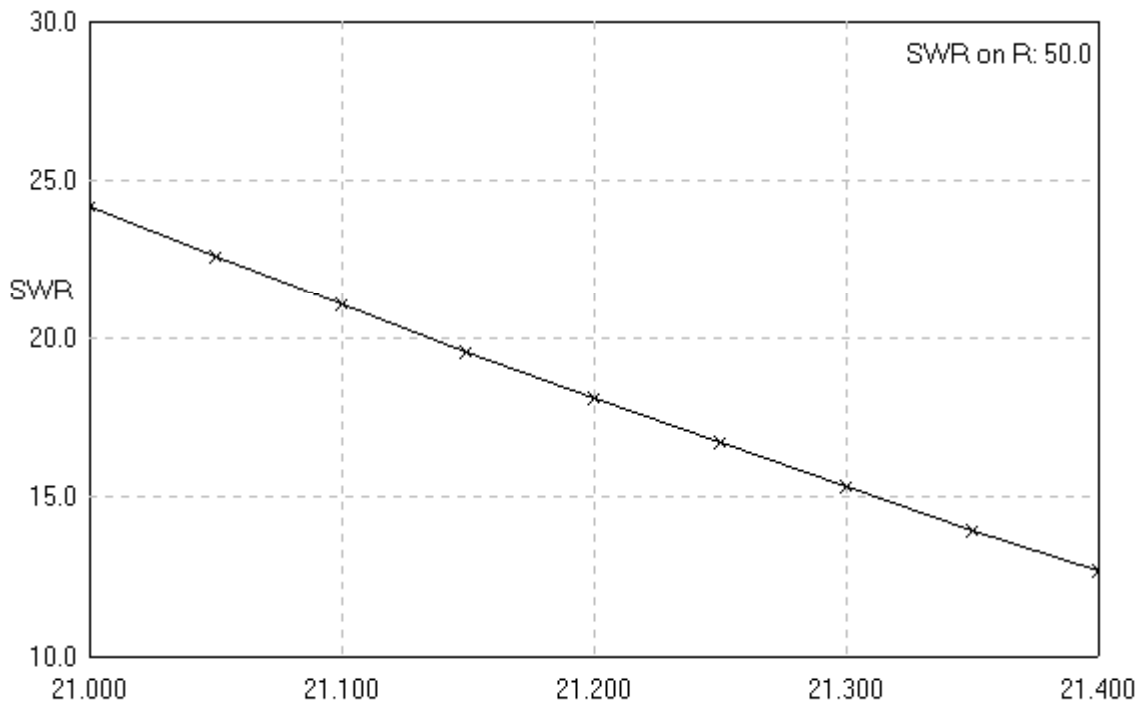

Current Distribution at 15 meters W3DZZ Antenna

Input Impedance at 15 meters W3DZZ Antenna

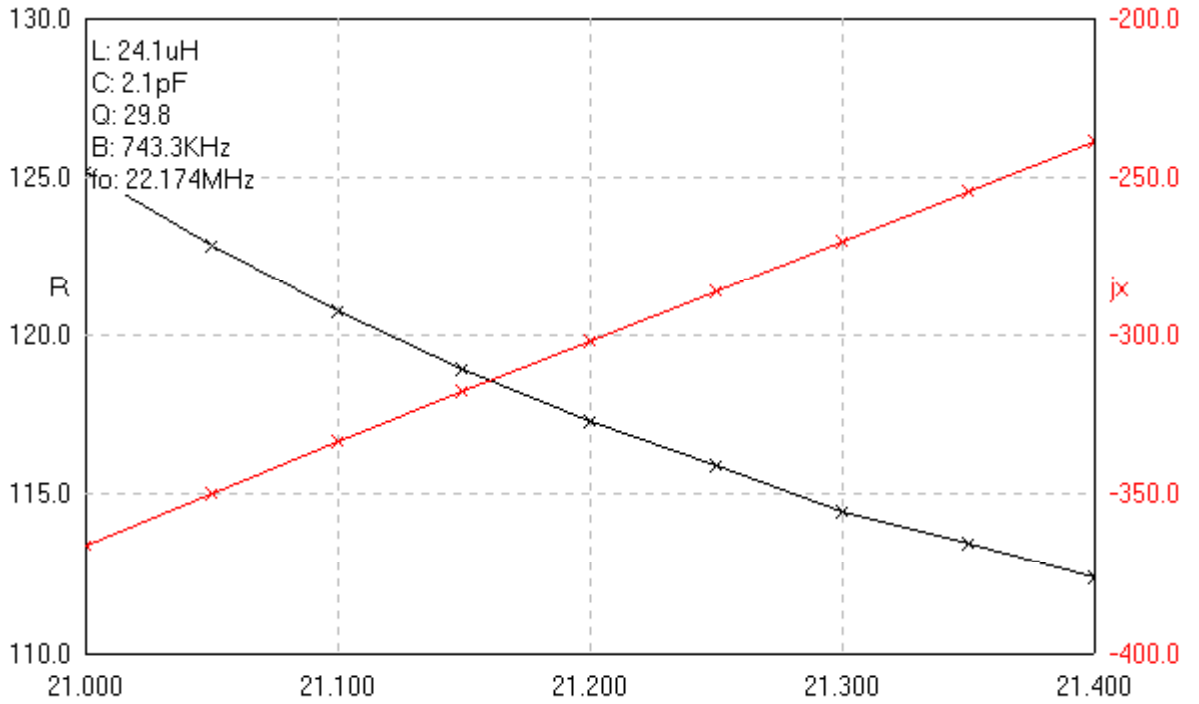

SWR at 15 meters W3DZZ Antenna

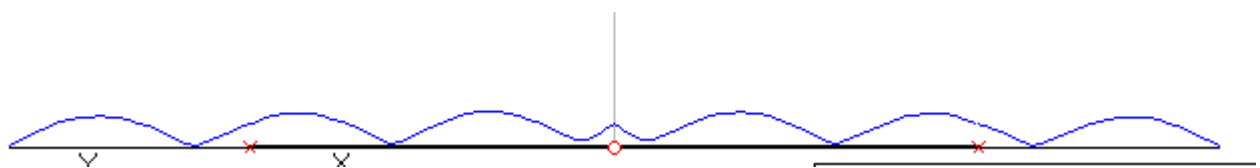
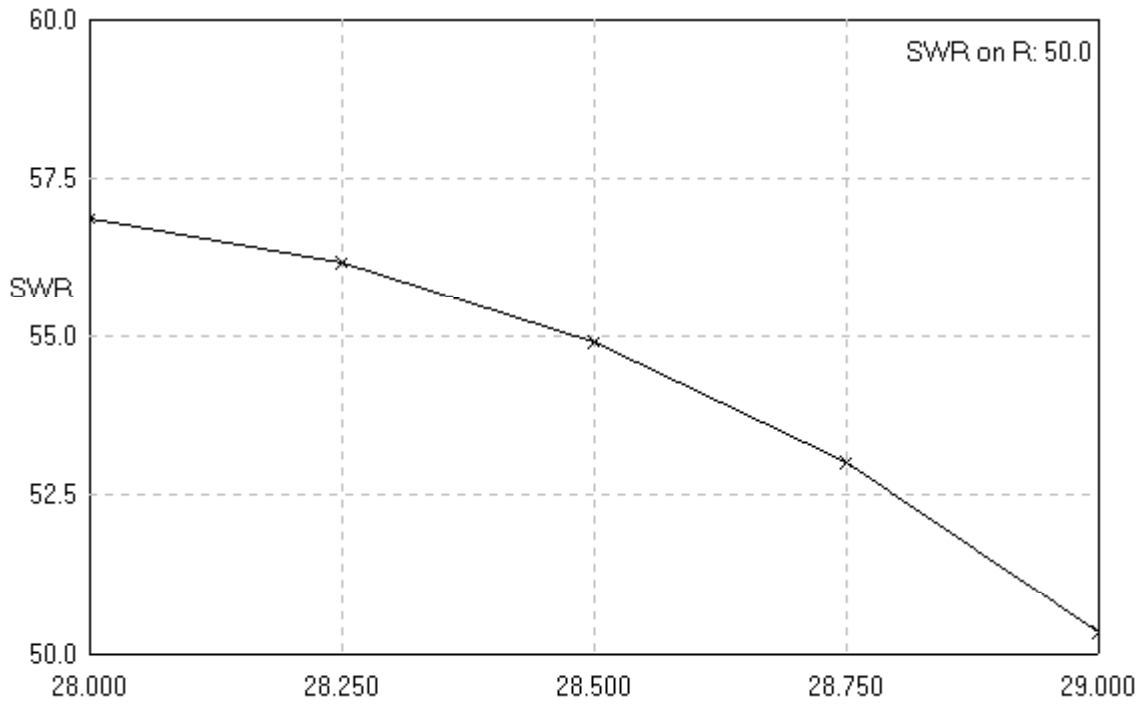

Current Distribution at 10 meters W3DZZ Antenna

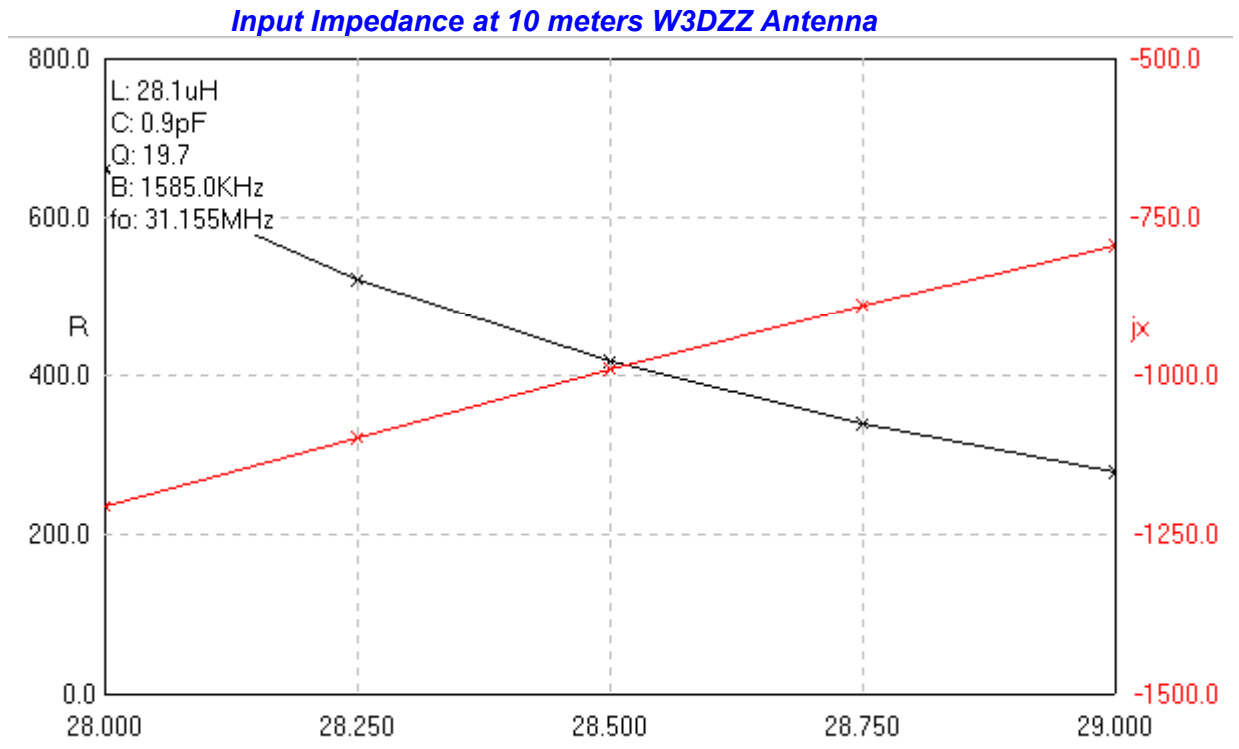

Antenna W3DZZ has input impedance close to 60 Ohms at 80 and 75 at 40, , so, a 75-Ohms coaxial cable can be used for feeding of the antenna.

Hams make antenna W3DZZ also in a vertical installation, where the antenna has input impedance close to 30- 40 Ohms (in twice less the dipole design), so a 50-Ohms coaxial cable can be used for feeding of the antenna at all of the ranges. For a proper work a vertical trap antenna must have several counterpoises for every of operation ranges, especially for low amateur HF ranges 40-, 80- and 160-m.

LC trap design: Trap spool has 8.3- μ H and contains 19 turns of silvered copper wire of diameter in 3-mm. Diameter of winding is 50-mm. Length of winding is 80-mm. The trap should be tuned to resonance to the frequency 7,05 (7.2 for USA) MHz. It is possible use a GDO for the tuning. A capacitor at 3-pF is bridged to trap capacitor when the trap is tuning to the resonance. The capacitor is simulated a stray capacitance of the antenna sections.

Antenna tuning: At first, with the help of a GDO tune trap to 7,05 (7.2 for USA) MHz. Trap is tuned separately from antenna. At second, get a minimum SWR on 40 meters by length A. At third, get a minimum

SWR on 80 meters by length B. At thus, you can get SWR (well, see in the above figures, the SWR is not so at 20, 15 and 10 meters.

Four band vertical one-trap antenna:

Hams often use a shortened sample of the W3DZZ antenna intended for 40, 20, 15, and 10 meters. At radio amateurs literature there are several description of the antenna, as at dipole as at vertical installation. However, the first description, which I found off for a vertical four band trap antenna, was made by K2GU in reference [5]. **Figure 5** shows the schematic of the antenna.

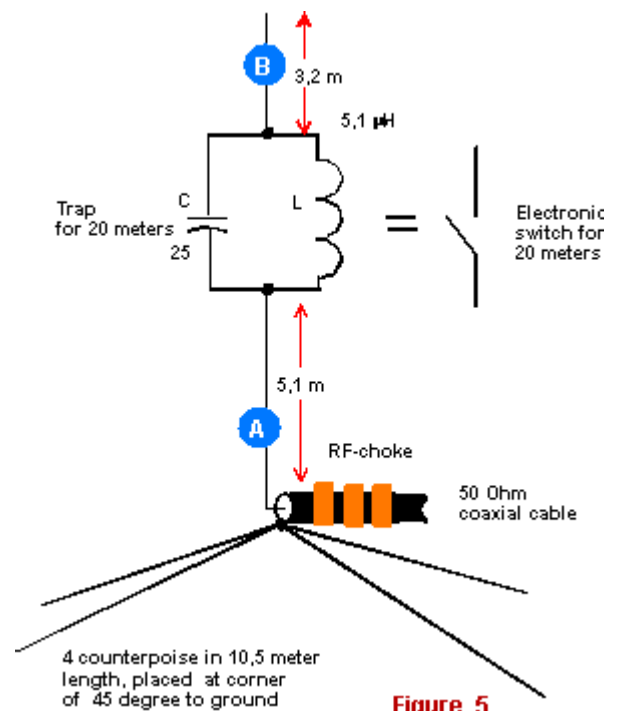

Figure 5

Figure 5 A four-band trap vertical antenna

20 meters: Section A is tuned for operation on 20-meters by its length. Trap LC turn off upper antenna parts behind the trap from operation of the antenna when 10 meters range is used.

40 meters: By length of the Section B we tune the antenna parts "Section 1 plus LC plus Section B" to resonance to 40-meters.

15 and 10 meters: The trap serves as a shortening capacitor at that ranges.

Below you can see input impedance, SWR and DD of the antenna W1LNQ. The figures are obtained with the help of Free Antenna Simulation Program MMANA (MININEC based). Section A has diameter of 20 millimeters, section B has diameter of 10 millimeters. You can see, that a SWR at 15 meters is too high. It is impossible to find such length of the antenna and data for trap that the antenna works at all of the ranges. So, an ATU and a good coax is need for the antenna if you work at 15 meters. A 50-Ohm coaxial cable can be used for feeding of the antenna at all of the ranges.

Diagram Directivity and Input Impedance at 40 meters FOR 4B- W3DZZ Antenna

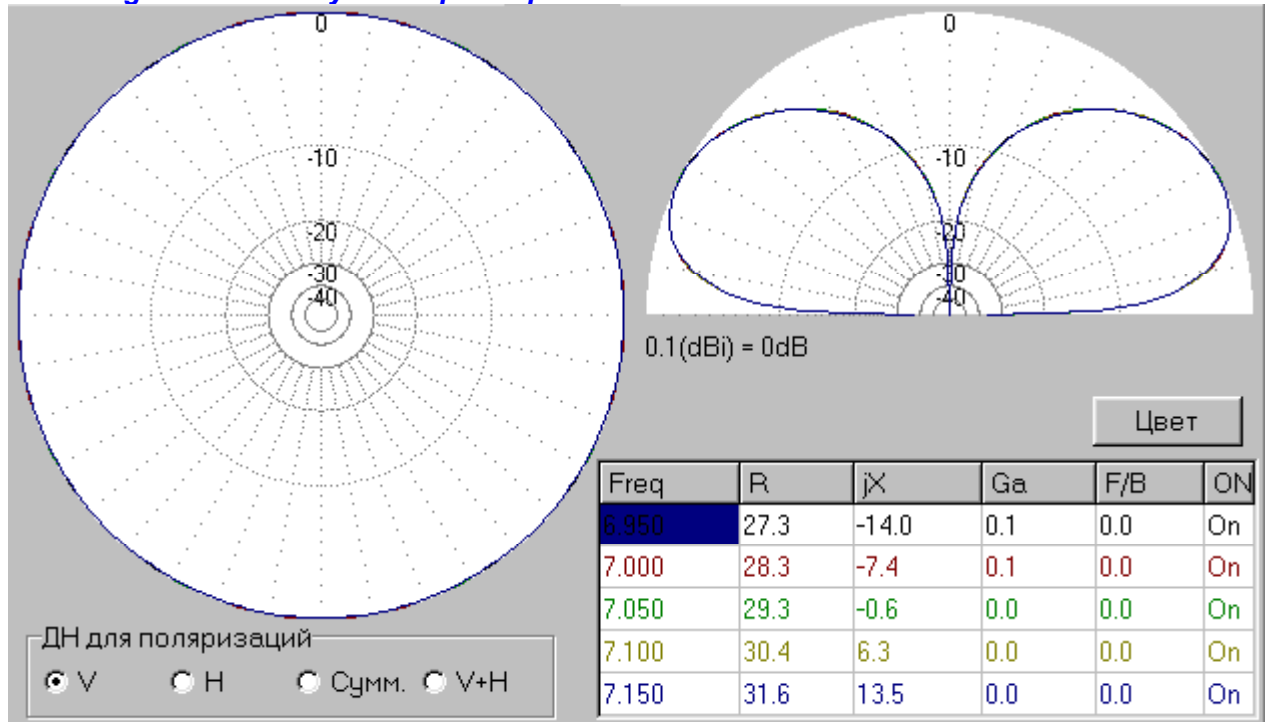

SWR at 40 meters FOR 4B- W3DZZ Antenna

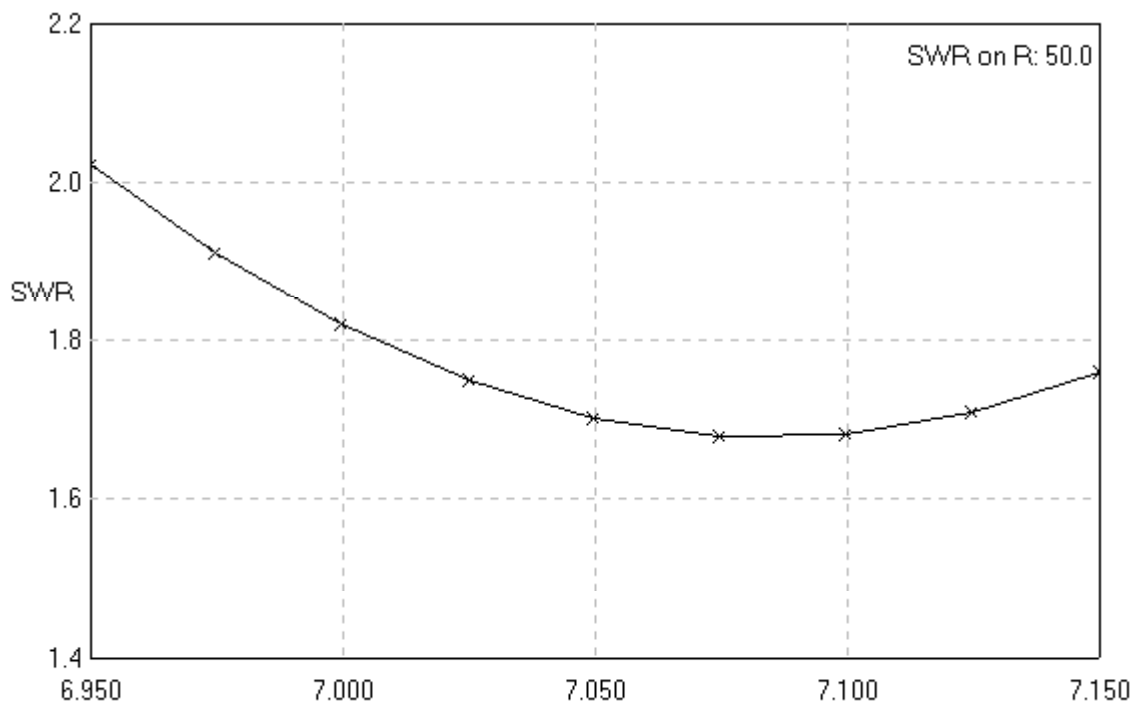
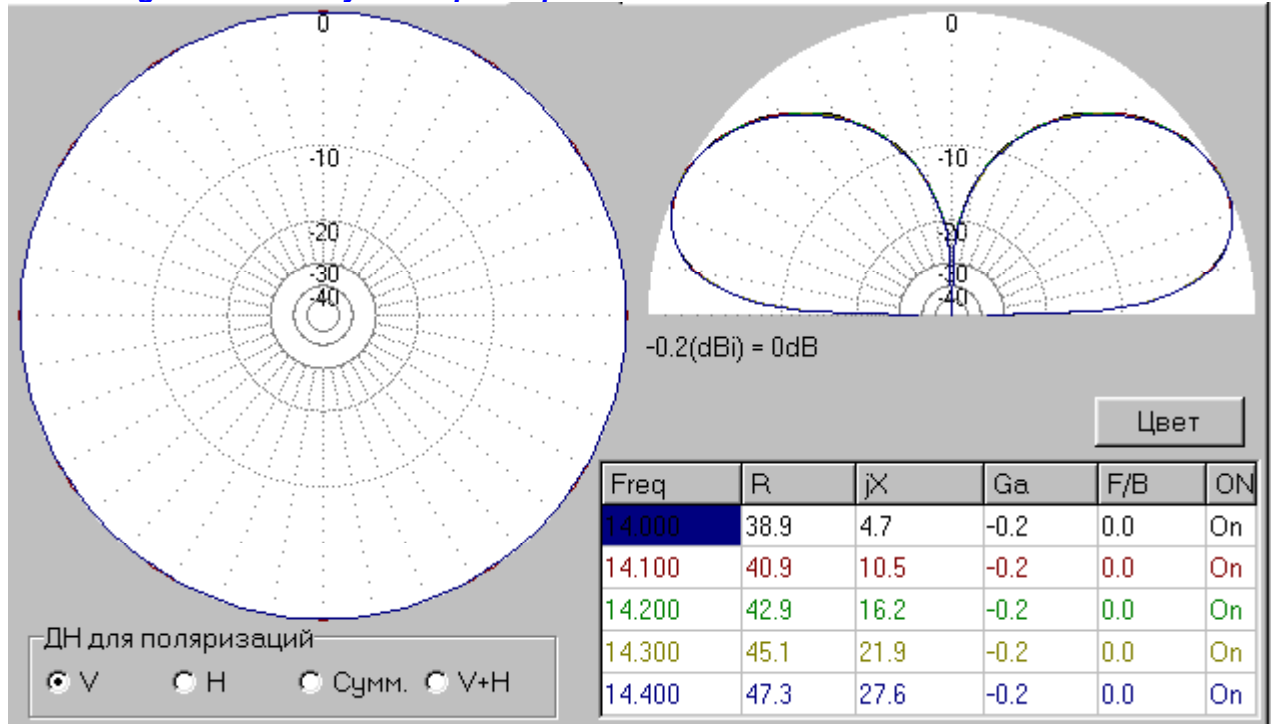
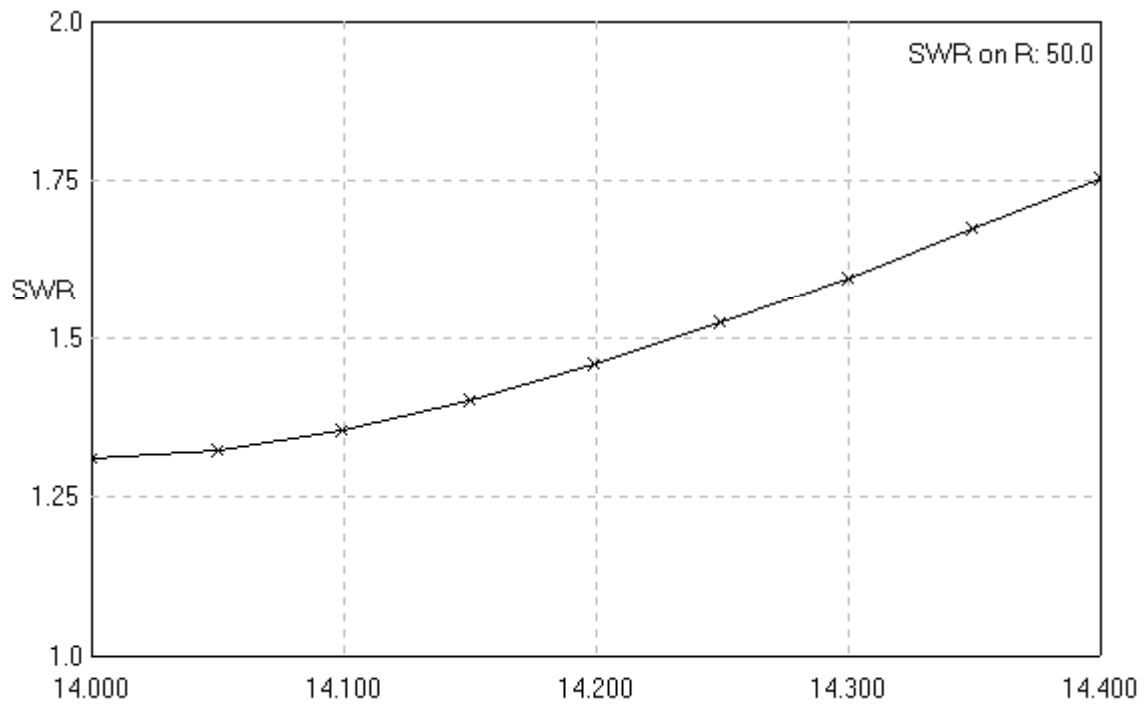

Diagram Directivity and Input Impedance at 20 meters for 4B- W3DZZ Antenna



SWR at 20 meters FOR 4B- W3DZZ Antenna



Current Distribution at 40 meters

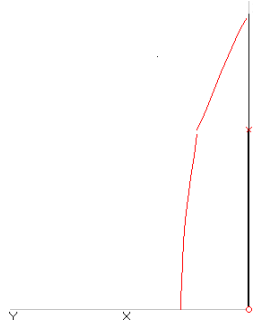

Current Distribution at 20 meters



Diagram Directivity and Input Impedance at 15 meters for 4B- W3DZZ Antenna

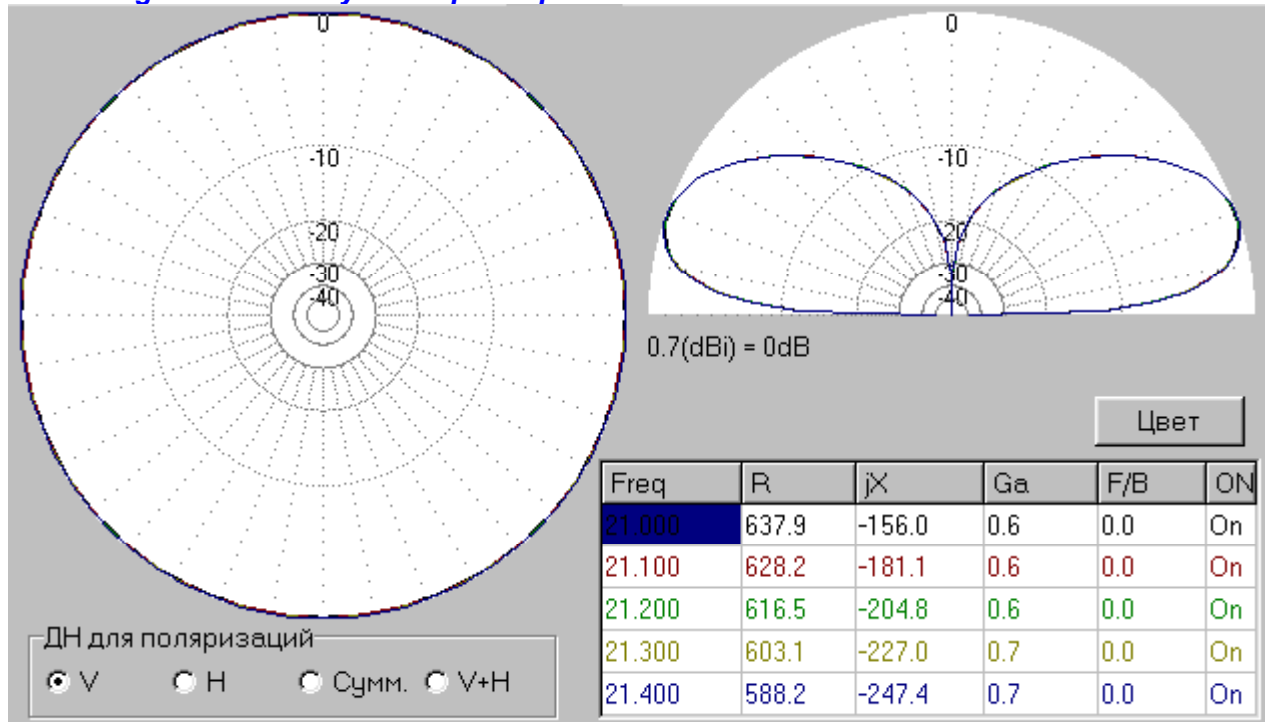

SWR at 15 meters FOR 4B- W3DZZ Antenna

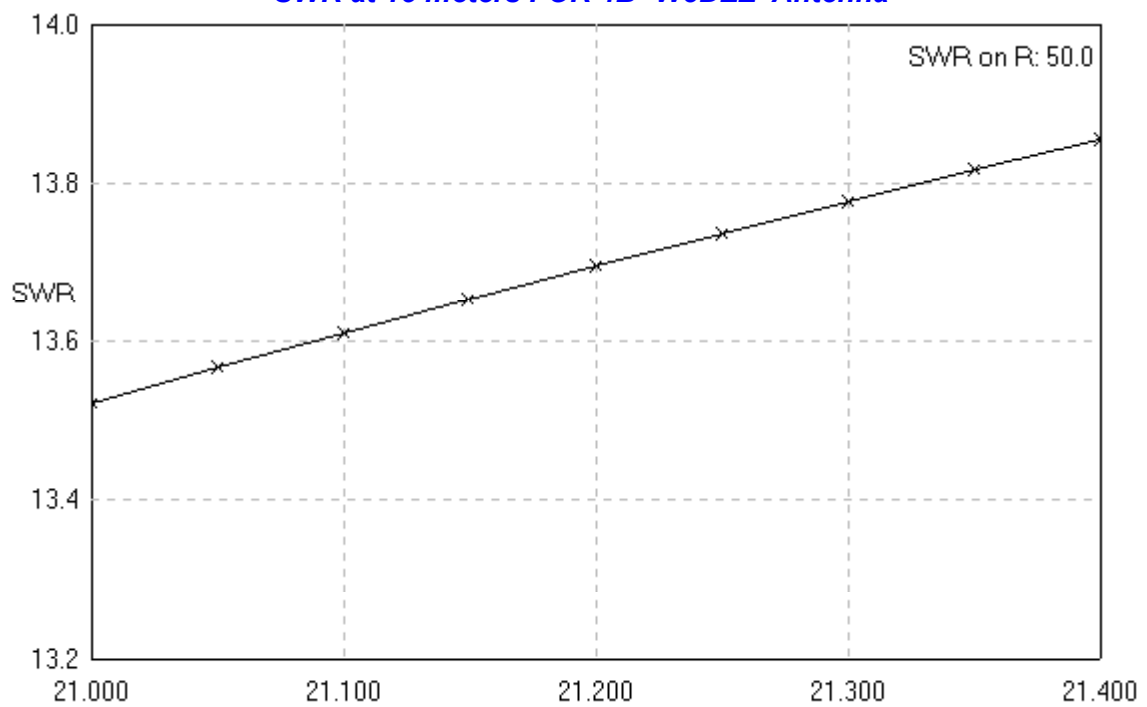

Current Distribution at 15 meters

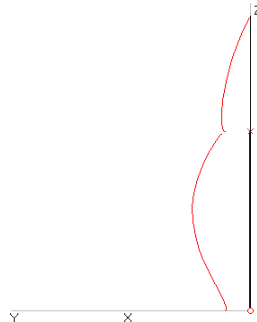

Current Distribution at 10 meters

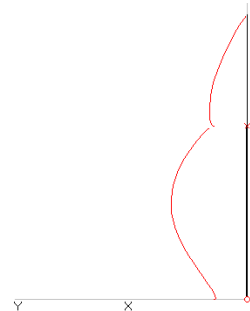
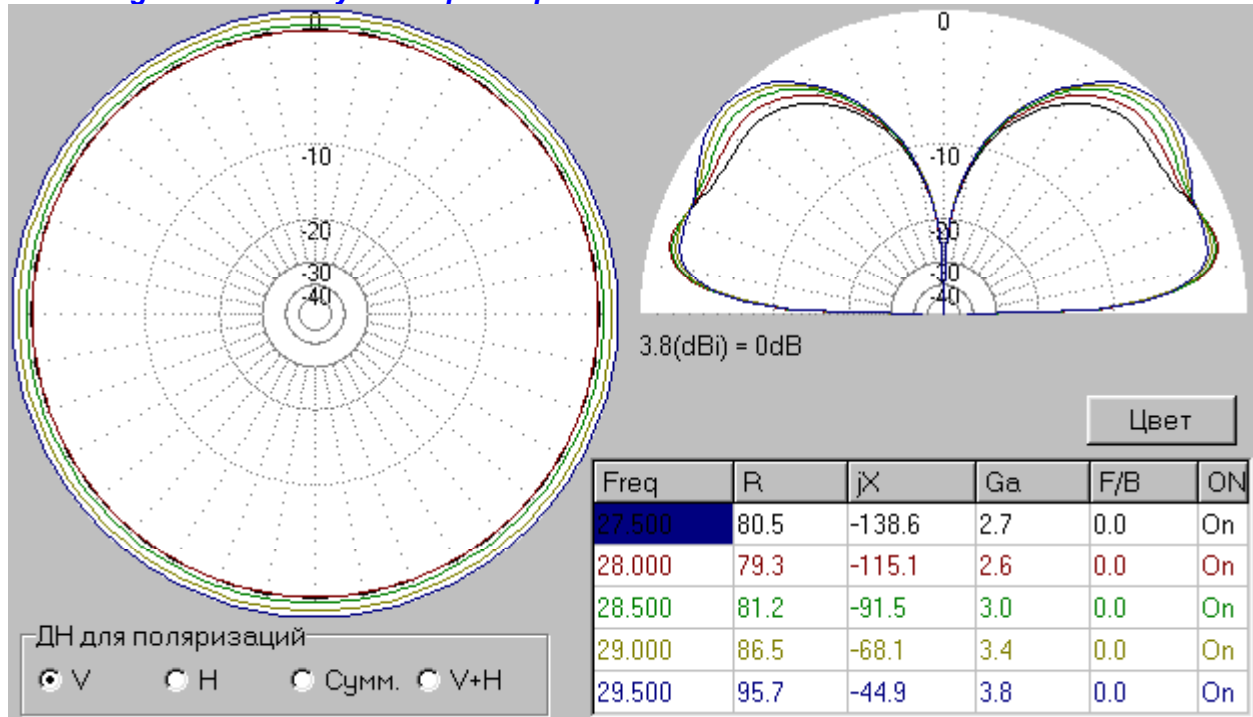
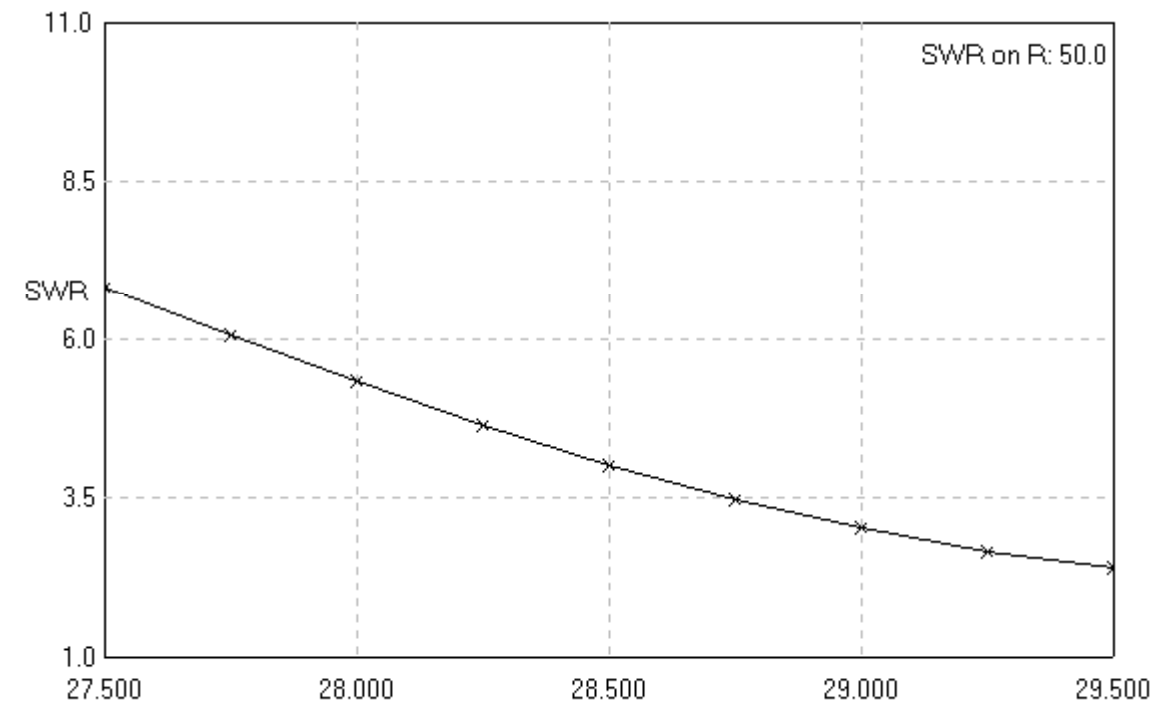

Diagram Directivity and Input Impedance at 10 meters for 4B- W3DZZ Antenna



SWR at 10 meters FOR 4B- W3DZZ Antenna



Trap design: Trap spool contains 10 turns of copper wire diameter in diameter of 2-mm, form of the spool has diameter of 60-mm, distance between turn is 4 mm. The LC circuit should be tuned to frequency of 14.2-MHz. It is possible use a GDO for the tuning. A capacitor at 3-pF is bridged to trap capacitor when the trap is tuning to the resonance. The capacitor is simulated a stray capacitance of the antenna sections. It is necessary to safe trap capacitor from the atmospheric effect.

Antenna tuning: At first, with the help of a GDO tune trap to 14.2-MHz. The circuit tune separately from antenna. At second, tune length A to a minimum SWR in 20 meters. At third tune length of the Section B to minimum SWR at 40 meters.

Common notice for vertical multi range trap antennas

Counterpoises: For a proper work a vertical trap

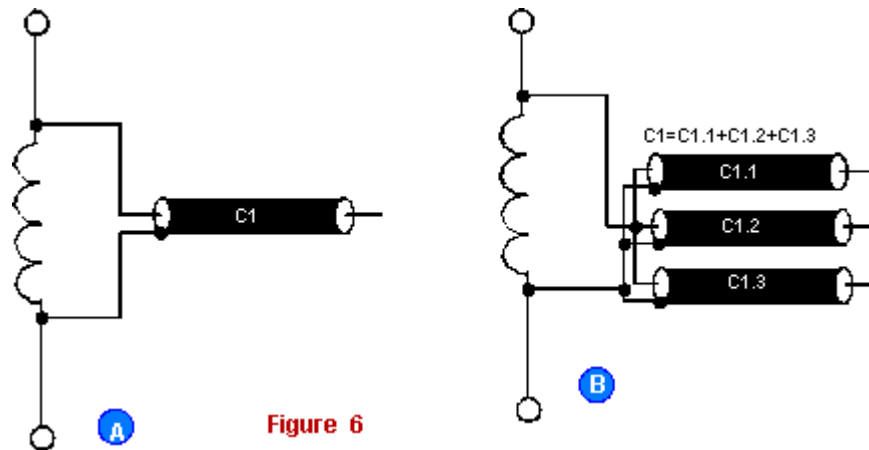

Figure 6 A coaxial cable capacitor

antenna need resonance (a quarter wave) counterpoises for each operation range. Use not less than two counterpoises. If the antenna is placed at a small altitude above a metal roof and braiding of feeding coaxial cable have good electrical contact with the metal roof, the antenna can be used without any counterpoises.

Antenna feeding: Quite possible to use a 50- Ohm coaxial cable for vertical trap antenna feeding. Also it is possible to use a two wire line for dipole and vertical trap antenna feeding. In this case it need ATU between the line and the transceiver.

A trap capacitor: A high voltage is at a trap capacitor when the antenna works to transmission. So it need a high voltage capacitor trap to be used at a trap. Such capacitor is costly and rather rare. Hams often use a length of a coaxial cable instead of a high-voltage capacitor. A 50- Ohm coax has near 100-pF/meter, a 75- Ohm coax has near 70-pF/meter. Coaxial cable capacity can be find off from a data sheet for the coaxial cable or is metered practically. **Figure 6** shows a coaxial cable capacitor. For a capacitor with a small capacity (up to 30-pF) it is possible to use whole coaxial cable length, see **Figure 6A**. For a capacitor with a high capacity cut the coaxial cable on to several lengths, as it shown in **Figure 6B**. As a high-voltage capacitor in trap it is possible to use a bilateral PC-board by width of 1 to 3 millimeters. In this case capacitor get more bulky the made on coaxial cable basis. It is possible to tune the PC – capacitor on necessary capacity by slitting a foil on one of two sides of this capacitor. Do not forget about atmospheric protection of the trap capacitor.

Other way for trap design: It seems to me in the end of 70s in different radio amateur literature were appeared articles about using “coaxial cable trap” for W3DZZ. There is very simple method for trap making. **Figure 7** shows the trap. It is wise way for trap design, but radio amateur should have an experience using the method. In different radio amateur literature there are a lot of data for design of the trap, but classical methods are described at reference [6].

References:

1. By Alois Kruschke : Rothammels Antennenbuch.- Franckh – Kosmos, V GmbH@Co., Stuttgart, 1995, 11 edition.
2. Jay Rusgrove, WA1LNQ: The Cheapie GP // QST, 1976, February, p31.
3. Morgan h. K. : Multifrequency Tuned Antenna System. - Electronics, vol. 13, August 1940, pp. 42-50.
4. Buchman C. L., W3DZZ : The multimatch Antenna System. // QST, March 1955, pp.22-23, 130.
5. The Radio Amateur's Handbook, 1970, by ARRL publication.
6. The ARRL Antenna Book, 19 Editions // ARRL Amateur Radio, 2000.

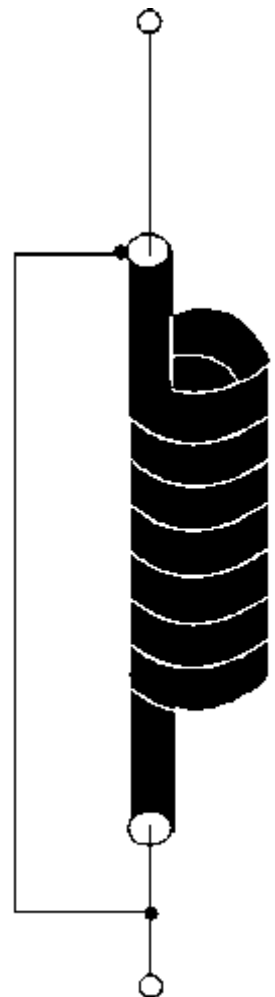

Figure 7
Figure 7 A coaxial cable trap

A FIVE BANDS VERTICAL TRAP ANTENNA

M. Chirkov, UL7GCC

The classical **W3DZZ** antenna in vertical installation designed by UL7GCC and shown at the **Reference 1** is well known in Russia. **Figure 1** shows the antenna. Diameter of sections A and B is 40- 50-mm. How is it work?

40-m band: The trap LC cut out the upper section B from the antenna. So only section A works as a radiator, and the section A has length in 10.1 meters, i.e. has electrical length in $1/4\lambda$. Vertical radiator having with the length of $1/4\lambda$ has a quarter-wave resonance and works in very effectively way. At the band the circuit LC works as a **trap**.

80-m band: On the 80-m band the antenna has summary physical length of this two sections A+B a little less than $1/4\lambda$. $A + B = 16.47$ meters, less then 20 meters OF quarter wave length for the 80-m band. A short vertical radiator has a capacity part in its input

impedance. But the circuit LC at the 80-m range has an inductance part in its impedance. The inductance part compensates capacity part of the electrically short vertical, and the antenna has a low SWR at the 80-m range too. In other words, the inductor of the LC works as a usual lengthening spool.

10-, 15- and 20-m ranges: Visa versa, at the 10-, 15-, and 20-m the LC has a capacity part at its impedance that goes the electrical length of the antenna to 1.75λ at 10-m, to 1.25λ at 15-m and to 0.75λ at 20-m.

Do not forget, verticals like counterpoises, so use several $1/4\lambda$ counterpoises for each bands.

Reference

M. Chirkov, UL7GCC: Multi range vertical // Radio #12, 1991, p. 21.

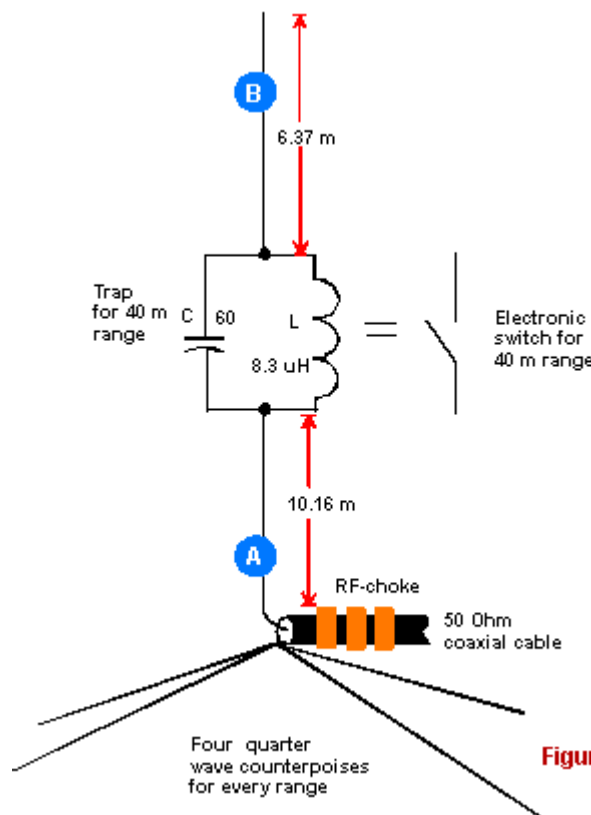

FREE magazine edited by hams for hams

www.antentop.bel.ru

DIPOLE NADENENKO

Soviet radio amateurs well know the broadband dipole named in Russia "dipole Nadednenko." The antenna is widely used at serve radio centers of Russia. Russian radio amateurs also are used the dipole. Below we take up a design of the antenna.

Dipole struts can be both as metal as wooden. As usual, struts has the shape as a circle, wooden struts has the s polygon. Wires are attached to struts any possible way. ' ends of shoulders carefully are welded. As usual, a 300-wire line is used for feeding of the antenna. Antenna rad with horizon polarization.

The dipole contains several wires at each shoulders shaped as a cylinder. Figure 1 shows the dipole Nadenenko. For working at 40- 10 meters the sizes are: L= 8 meters, L1= 3 meters, L2= 1 meter, 2R= 1 meter. Diameter of wires is 1.5- 3 millimeters.

By Radio 1959

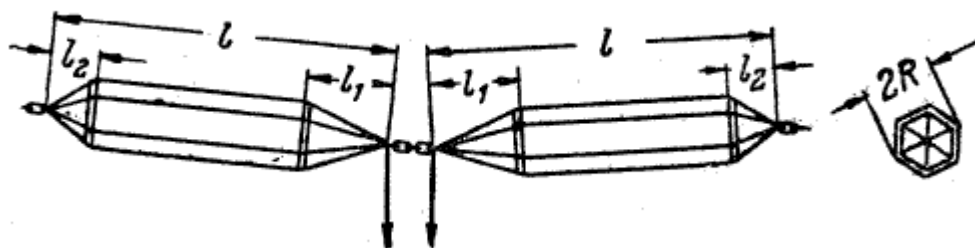
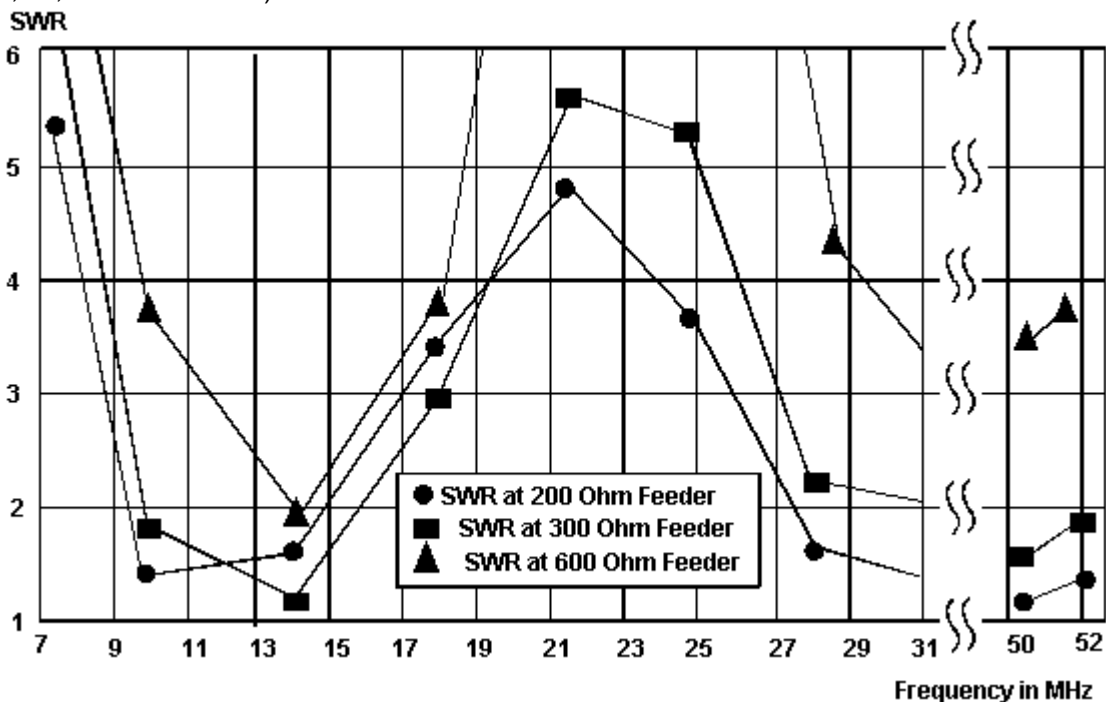
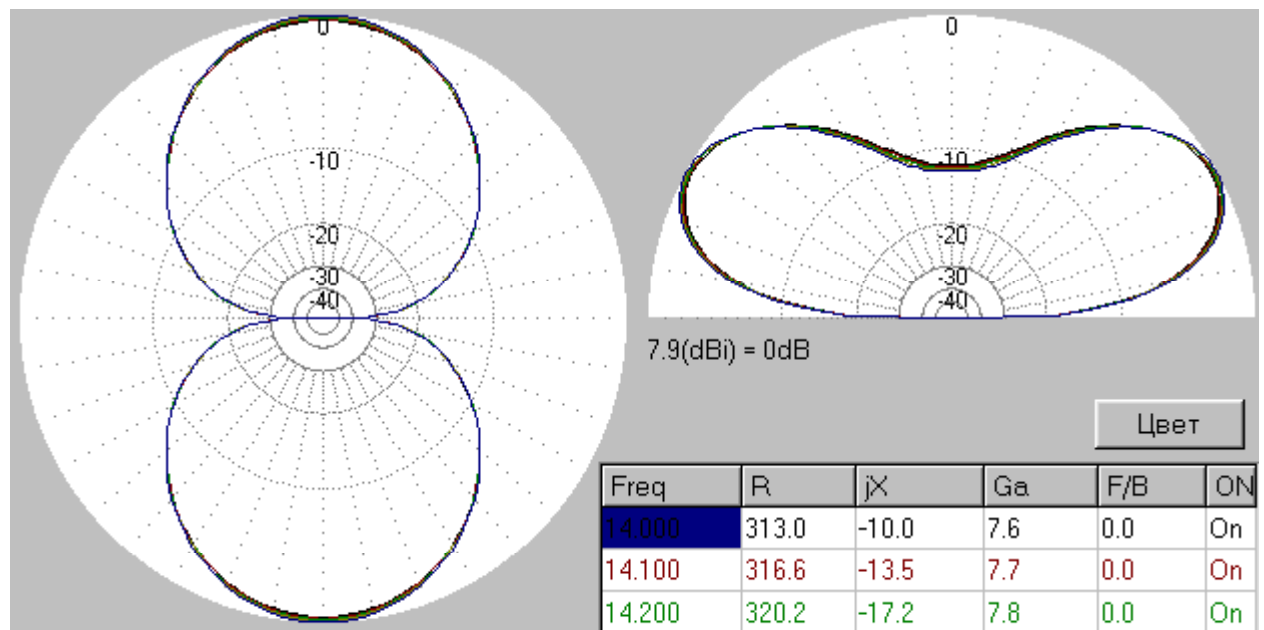
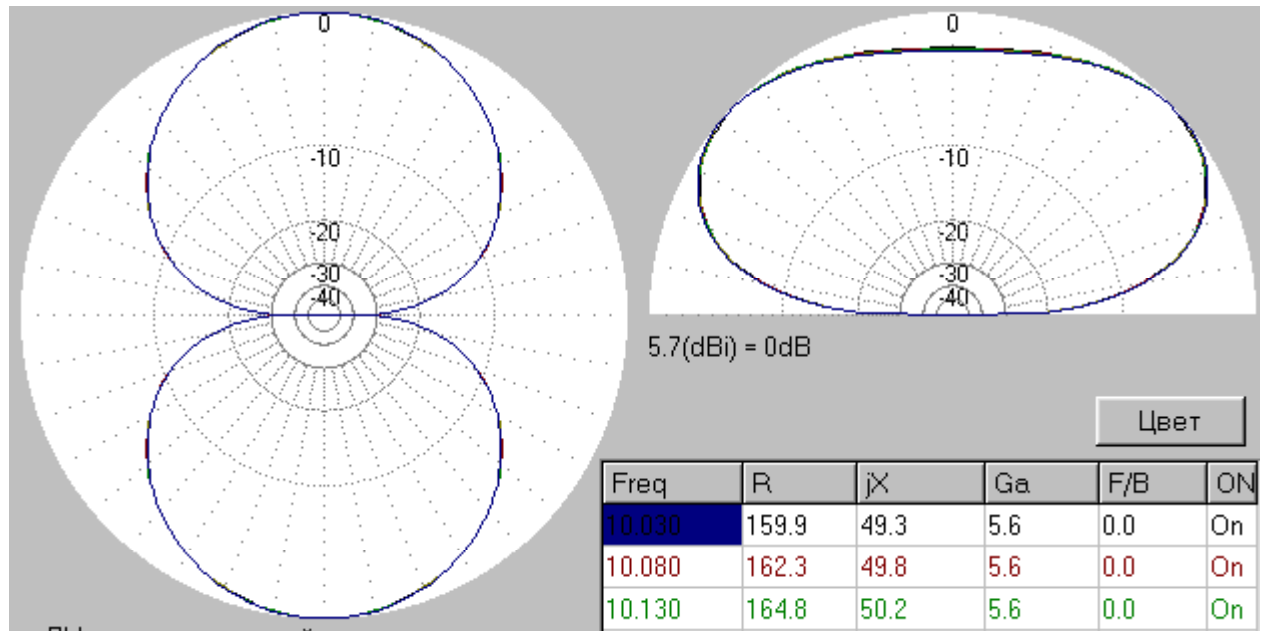
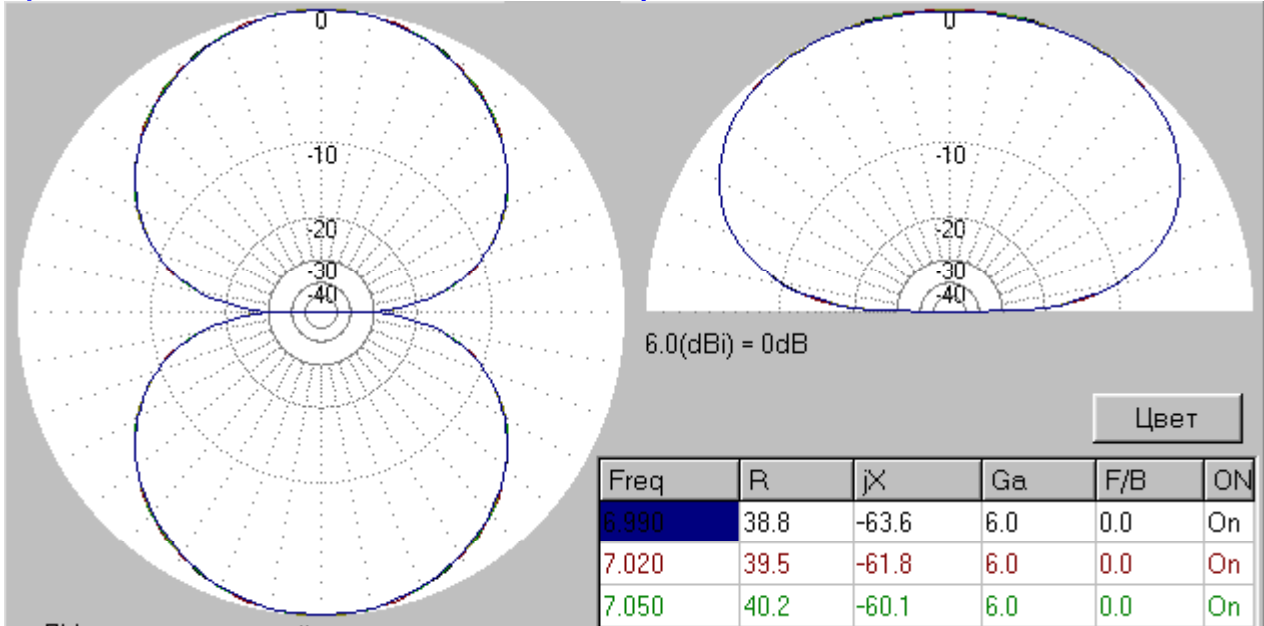

Figure 1

Calculations of input impedance and DD (*for horizon radiation*) of the dipole Nadenenko located at 10 meters above real ground with above mention dimensions (L= 8 meters, L1= 3 meters, L2= 1 meter, 2R= 1 meter, diameter of wires is 2 millimeters) are shown below. You can see, it is possible to use a 50-Ohm coaxial cable with a 1:4 transformer if restricted bands (30, 20, 10 and 6 meters) are used.

The data is obtained with help of a free antenna program MMANA (MININEC based). Left diagram is a section of the volumetric diagram directivity of plane X-Y at a zenith corner of the maximum radiation. The right diagram is section of the volumetric diagram directivity of plane X- Z. Also at the right down corner of the pictures is a table with antenna impedance.





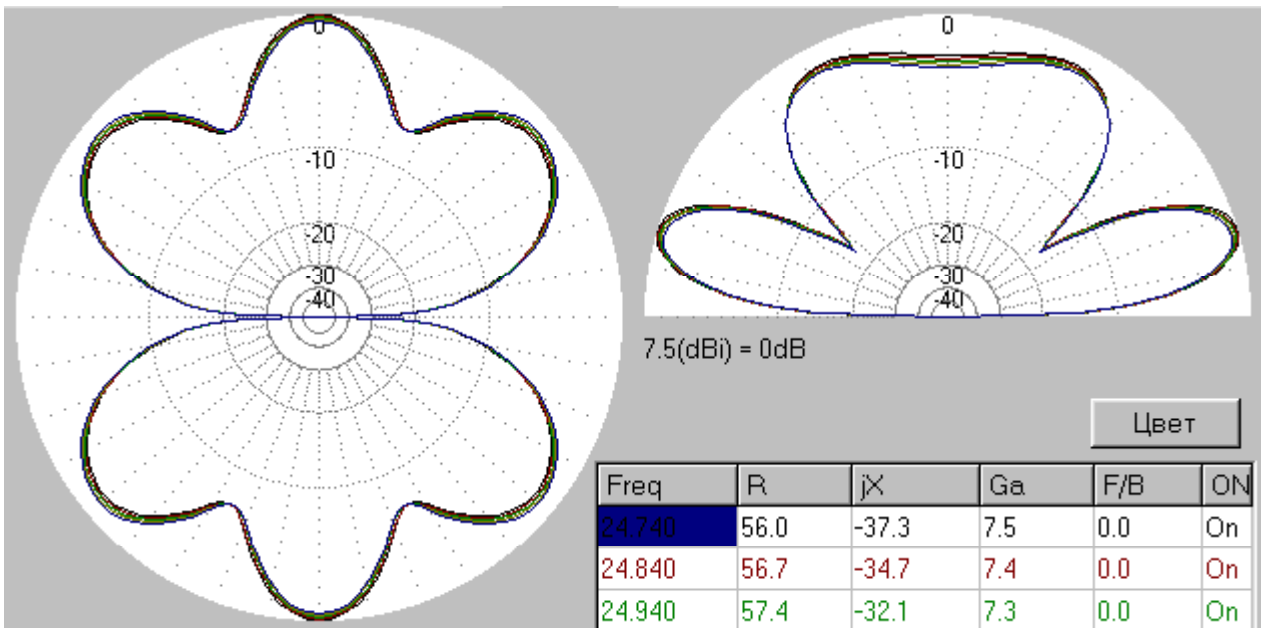
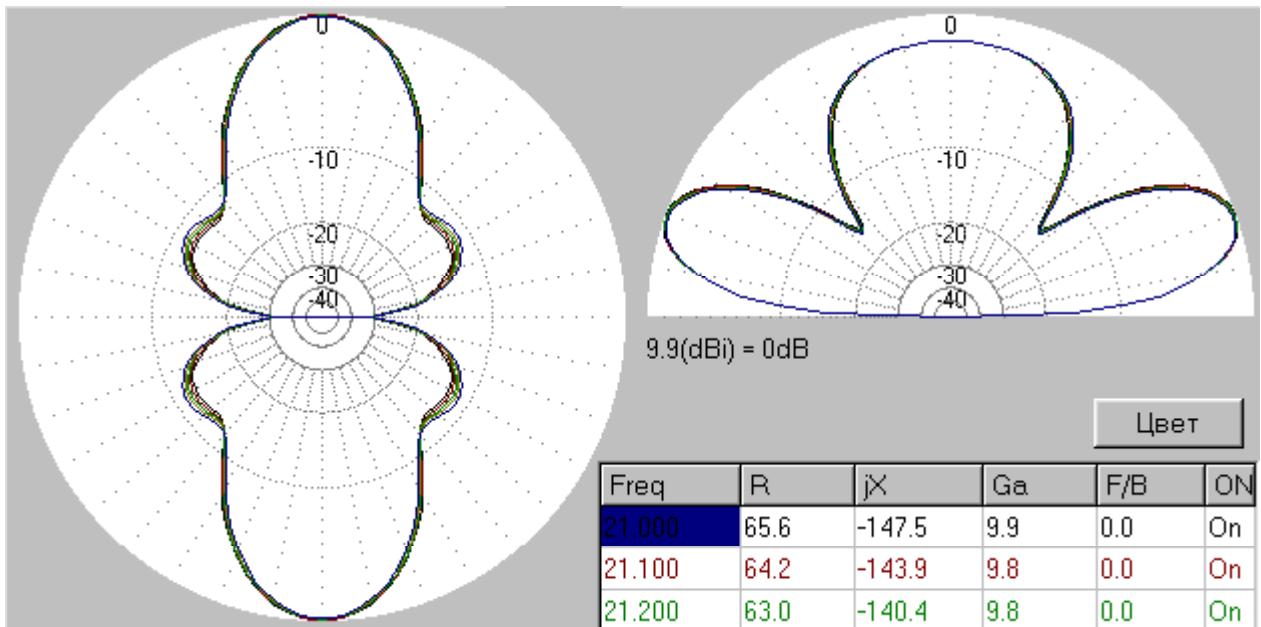
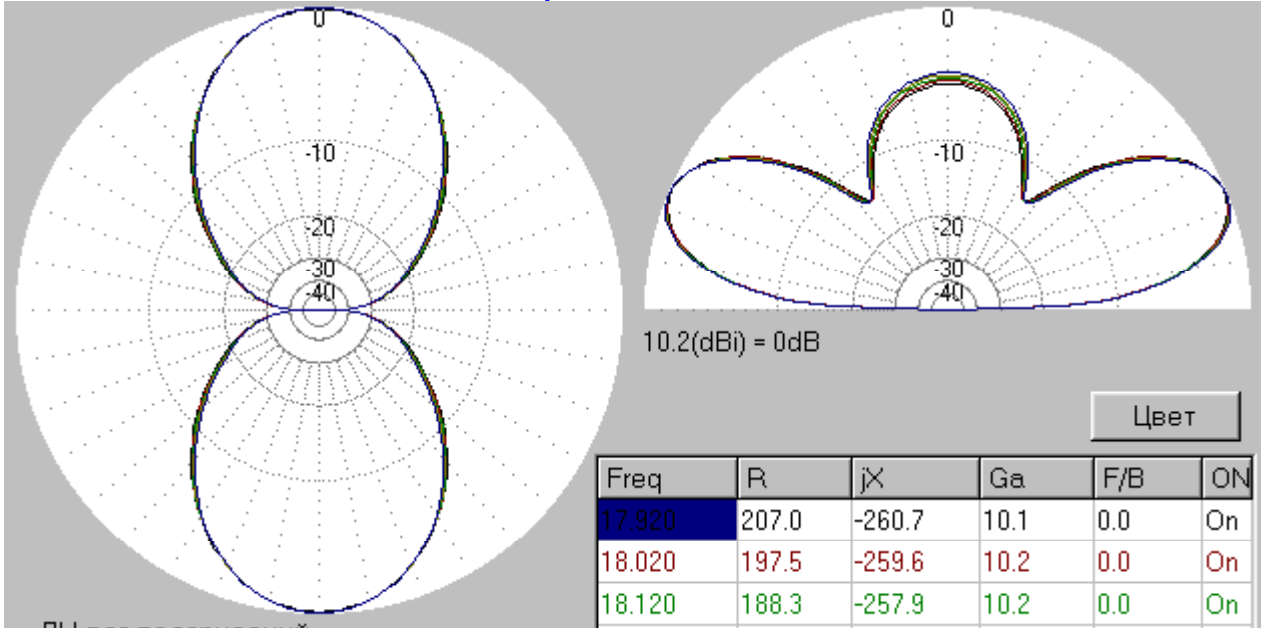

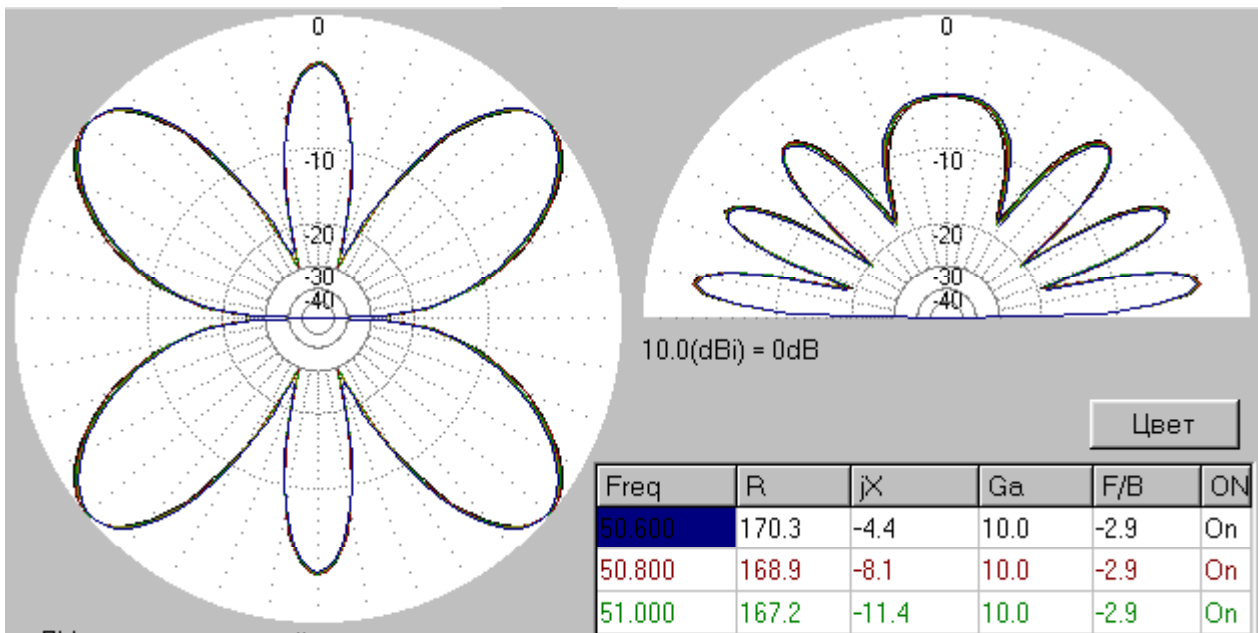
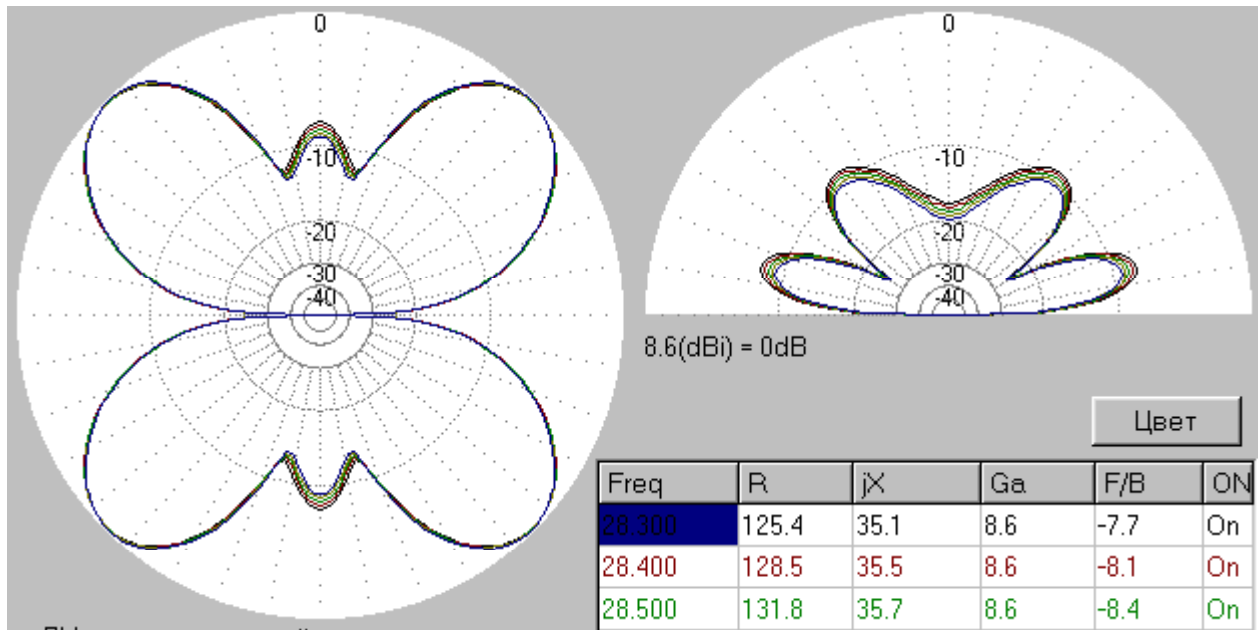

<http://www.cqham.ru/>



<http://www.antentop.bel.ru/>

RUSSIAN MILITARY WW-II RADIO "RBM"

Radio RBM is one of the most famous Russian military radio that was used in the WW-II and after the war as a surplus radio. RBM took place in the WW-II, after the war RBM was used as trial radio for military teaching centers. Lots of Russian hams know well the radio. I want to give some information about RBM and its antennas at ANTENTOP.

73! I.G.

History: Radio RBM, firstly named as RB (Radio, Base), was designed before the WW-II, in the 1938, in the Research Center of Communication of Red Army, by a special research group guided by colonel Sosunov. Special variant of RB named as RB-40, that had low weight because it was made in an aluminum cabinet was produced from end of 1939 for spy and partisan. It was made near 1000 RB-40, but then its producing was stopped because the aviation need aluminum. In the 1942 some modifications were done in the radio, and RB was named as RBM (Radio, Base, Modified). In the 1943 both with RBM was produced RBM-5 that has 5 watts power compare to 1 watt that RBM has. After WW-II other modification of RBM named as RBM-1 was produced. RBM-1 was produced until end of 50s. Some samples of RBM-1 was produced for export (*see picture with Latin letters on the front panel*).

Composition: RBM -1 consists of from two boxes, one is the transceiver other is its supply unit.

Transceiver has dimension of 345x195x260-mm, weight of 13 KG. It works at two frequency ranges, I- 5.0- 2.75 MHz, II - 2.75-1.5 MHz, has CW and AM modes. Transmitter made on vacuum tubes

Transmitter has 1 watt output(in reality 1.5 watts), plate current 35-mA and heater current 1-A.

Receiver has sensitivity of 10- μ V at AM and 3- μ V at CW, plate current 10-mA and heater current 0.5-A.

Transmitter and receiver use common units as: an antenna and output audio transformer, that does modulation for transmitter at AM mode and audio at receiving mode.

Power supply has three batteries of BAS-80 for plate and a NiCad accumulator 2NCN-24 for heater, weight of 14 KG. The Power Supply run the radio during 24- 36 hours.

Purpose of RBM is to do reliable simplex communication at any conditions. Distance of the communication depends on antennas that use with the radio.

WW- II. USSR, Leningrad Front, 1943. Radio RB



Export Sample of RBM-1



Short Whip Antenna does communication near 10 kms on AM and near 15 kms on CW.

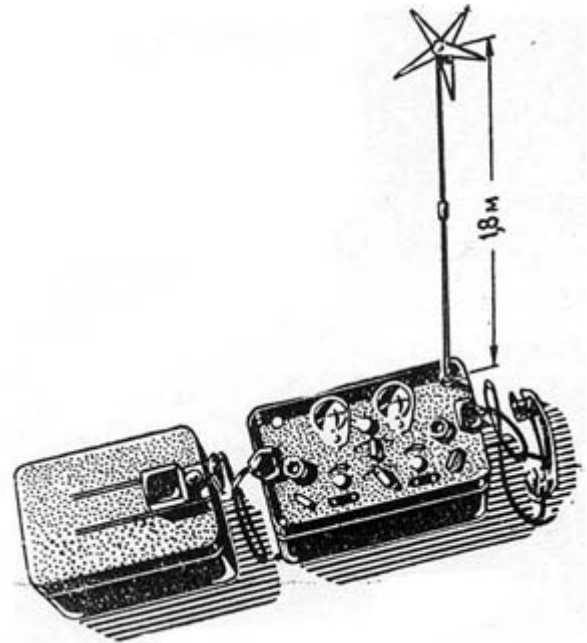
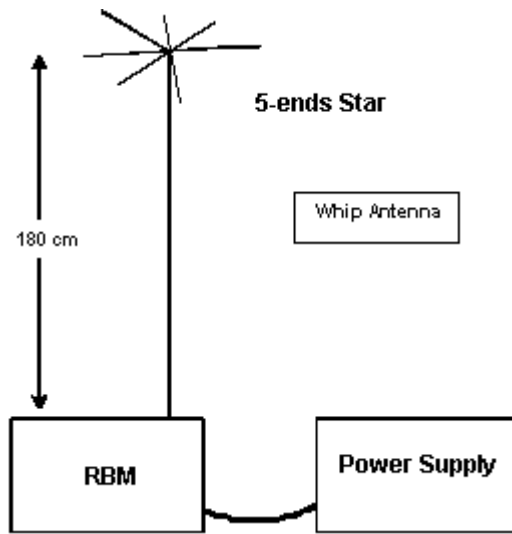

I live near village Prohorovka, Russia, where at July-4- August 5, 1943, The greatest tank battle of WW - II was. As I know, near 500 samples of RB radio took place in the battle

*German tank Elefant/Ferdinand
Destroyed by a tank mine.
Prohorovka, July, 1943*

*USSR tank KV-1
Destroyed by a German tank Tiger.
Prohorovka, July, 1943*



Russian RBM-1

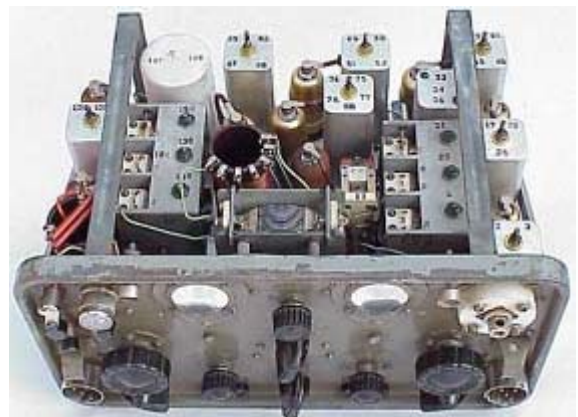

Schematic of RBM-1

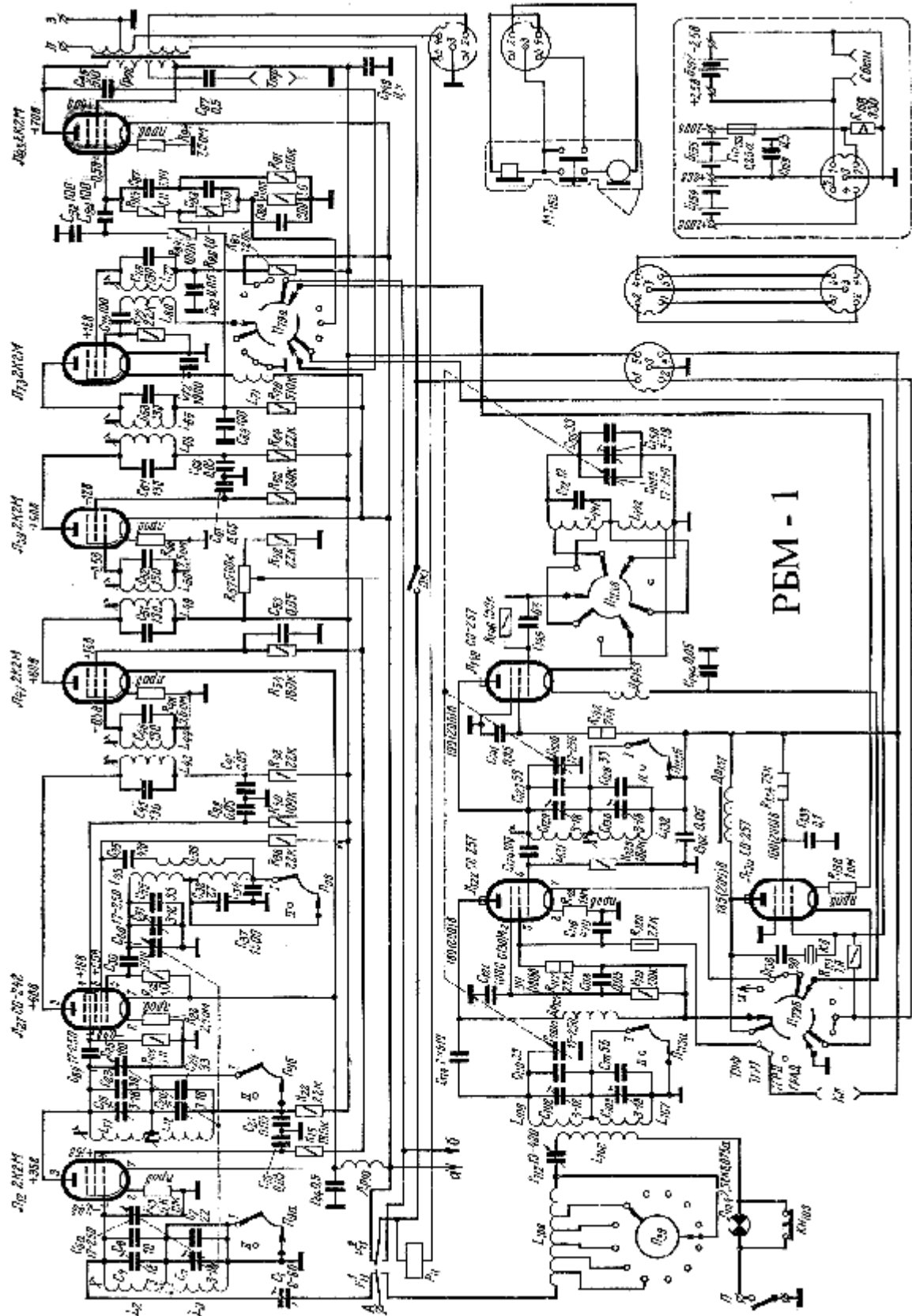

Ground Dipole Antenna does communication near 17 kms on AM and near 35 kms on CW.

Mast Antenna does communication near 30 kms on AM and near 50 kms on CW.

Note: The distance of communication is shown for daytime at middle level of interferences. At nighttime and at high level of interferences the distance of communication is decreased in two times.

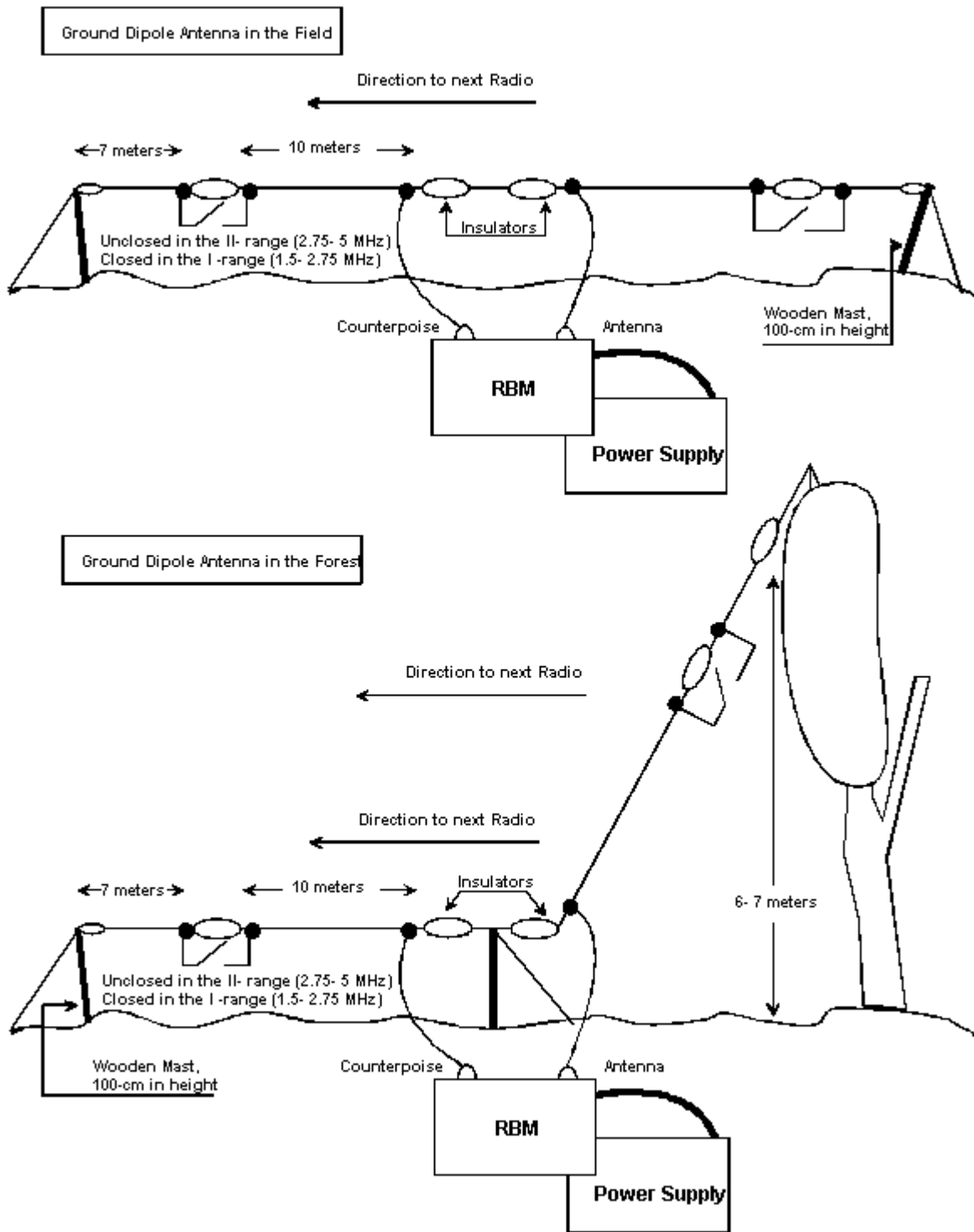

Picture from Russian Manual

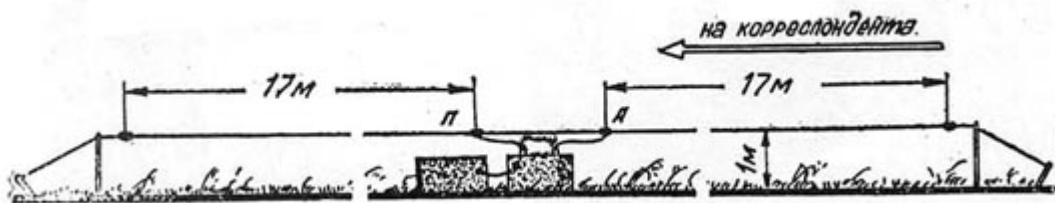

Picture from Russian Manual

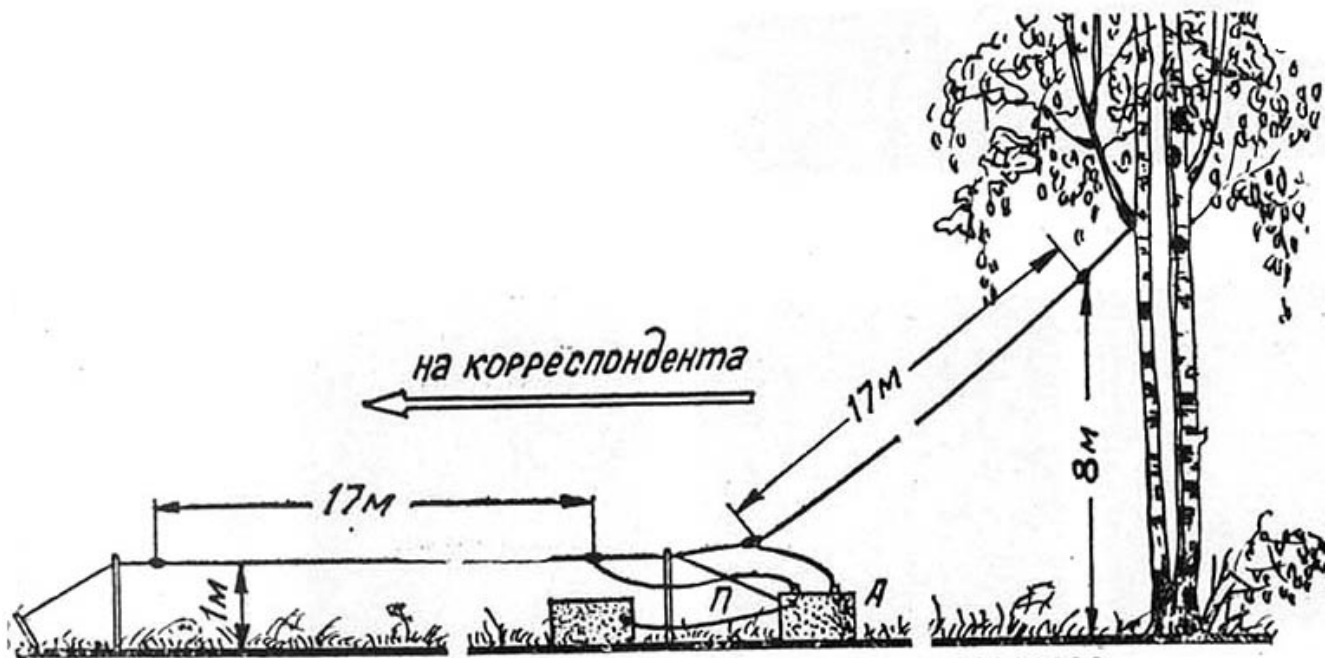

Winter, 60s, XX- century, Russia



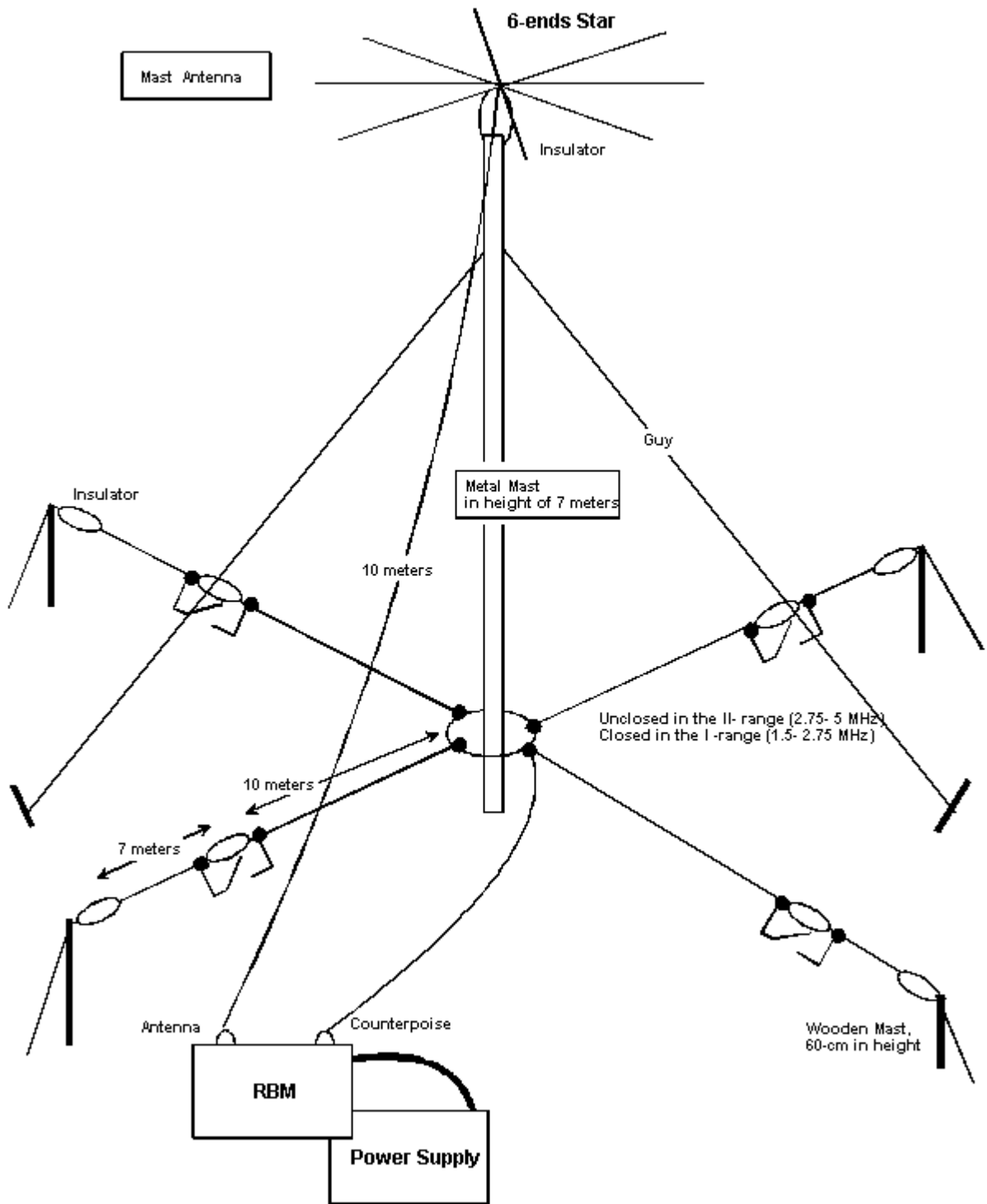

Credit Line:

Radio Magazine, USSR

RBM Radio. Manual for user. 1952.

<http://www.cqham.ru/>

<http://www.olderadio.onego.ru/>

<http://www.battlefield.ru/>

<http://www.antentop.bel.ru/> mirror: www.antentop.boom.ru



HALF - LOOP ANTENNAS FOR HF COMMUNICATIONS IN ALE AND FREQUENCY HOPPING



<http://perso.wanadoo.fr/starec>

Jean-Pierre GOUIN & Daniel LAFARGUE

STAREC S.A.
7, chemin de Vaubesnard
91410 Dourdan FRANCE
e-mail: starec@wanadoo.fr

Credit Line: Starec

<http://perso.wanadoo.fr/starec>

The present describes a HF loop antenna and its agile coupler which can be adapted to the new designs of ALE and FH (frequency hopping) radiosets. The original specification in 1993 was : "a small mobile antenna and coupler for HF voice and data communications in driving from 0 to 600 km without silent zone, in association with a 125 Watts CW radioset.

Frequency range 2-12 MHz Channel tuning time < 5ms Bandwidth > 3,5 kHz in a military environment" Following on from this product other versions with wider frequency range (3-15 MHz, 3-30 MHz, 2-30 MHz), a higher power and various dimensions and shapes for fixed, land-mobile and naval applications have been developed.

1. GENERALITIES

1.1. on the HF tuned loops

The HF transmission tuned loop antennas which are designed for HF transmission have small dimensions ($< 0,1\lambda$) compared to the wavelength, in order to conduct a quasi constant current and to be considered as magnetic dipoles. Their radiation impedance and efficiency mainly depends on their surface which creates a magnetic flux in the near field and an electromagnetic field in the far field. Their diameter, height or width (round or square shape) run from 1 to 3 meters, and their radiating surface generally do not exceed 5 m^2 in order to coincide with the small dimensions required.

These types of antennas differ from open antennas (like whips, horizontal dipoles, log-periodic antennas,) by their impedance which is reactive and can be adapted by capacitor only. Their radiating resistance is low ($< 1 \text{ m}\Omega$) at the lowest frequencies of the range. As the efficiency is given by the ratio radiating resistance/ total resistances of the tuned circuit, it is necessary to minimise the radiating element resistor, using a good conductive metal (aluminium, copper), and to use low loss capacitors.

These conditions being fulfilled, the loop antennas deliver a high current and have a high selectivity with a high quality factor (Q-factor), typically 10 times higher than the Q-factor of the best traditional couplers designed for 5 to 10 meters whips or 10 to 40 m dipoles.

1.2 On fast frequency tuning

For future fast ALE procedures the tuning target time is 50ms, while the "low speed" frequency hopping (F.H.) procedures already require a 5ms tuning time, with all calculations and control exchange times being included or already done. This can't be done using electromechanical tuning. Digital switching devices are cost effective today at low and medium powers. Their switching time run in milliseconds using low loss vacuum relays, and in the microseconds using electronic relays like PIN-diodes. But the PIN-diode technology cannot be used in loops for transmission, due to their inability to withstand the high currents and due to the losses they bring (0.5 to 1 W) which would drastically decrease the overall efficiency at the lowest frequencies. Vacuum relays, including REED relays, are the only technologies available to switch the capacitors of a transmission tuned loop antenna efficiently.

1.3 On the power requirements

Based on the experience of 2 previous generations of tuned loop antennas, and the proprietary propagation simulations, it was calculated that two 100W radiosets and 4m^2 loops having a -15 to + 5dBi typical gain figure from 2 to 12 MHz would insure voice and data communications at any distance from 0 to to 600 km at least.

This mission cannot be fulfilled by any 5 to 10 m whip antenna on a medium soil, even in association with a 400W/1 kW radio set: a vertical whip or a bent whip on a vehicle in move do not transmit and receive enough energy to cover the typical 50-250 km silent zone.

Chapter 1: HF ANTENNAS

A 125W radioset combined with a tuned loop antenna is sufficient to fulfill the mission requirement using the Near Vertical Incident Signal (NVIS propagation). This will be further improved due to frequency management and the new generations of HF modems which will bring a lower threshold of sensibility.

II DEVELOPMENT OF A NEW MOBILE TUNED FRAME ANTENNA

II.1 Principle

The mobile tuned loop antenna is a "half-loop" set-up vertically on a metal surface which achieves a full loop equivalence. The metal surface like a mobile platform (truck or shelter, ship's cabin,...) must have a good electrical continuity. This half-loop is half the size of a full loop and makes installation possible on small vehicles on the move.

The half-loop is folded and joined at each end to the platform's earth. One end is loaded by a variable capacitor.

A feed rod ("the feed coil") links the radioset RF access to a precise point of the half-loop. It is equivalent to a fixed reactive element, and the whole system acts as a loss-free autotransformer whose primary circuit can be set to 50 W.

II.2 Modelisation of the antenna

The modelisation purpose is the definition of the electrical circuit and the parameters of the antenna. It is made by the wire methods of moments.

The radiating element is represented by a radiating impedance (R_r , L_a) with a loss resistance R_p

The tuning capacitor is represented by a serial circuit (C , R_c), C being the capacitor value and R_r its loss resistance.

The 50 Ω matching is figured by a loss-free transformer M with a matching ratio K , and a parallel or serial inductance L at the RF input.

Establishment of the equivalent circuit parameters:

-The radiating element (R_r , L_a) is calculated by an electromagnetism software based upon the method of moments.

- The radiating element loss R_p is determined according to the antenna material and section

- The capacitor's losses R_c are determined through the manufacturer's data

- The matching ratio K is a function of the primary to secondary radiating surface ratio

Half-Loop Antennas

- The inductance L is a function of the spiral surface comprised between the feed bar and the platform.

Two types of antennas have been compared, type A and type B, differing by the positions of their capacitors.

II.3. Modelisation of the antenna type A

The capacitor is positioned in the secondary of the transformer, at the end of the line (**FIG 1**).

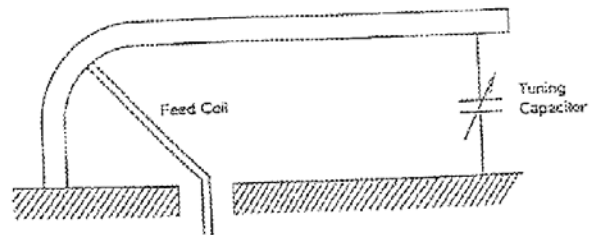

Figure 1

The electrical equivalent scheme is given **FIG 2**

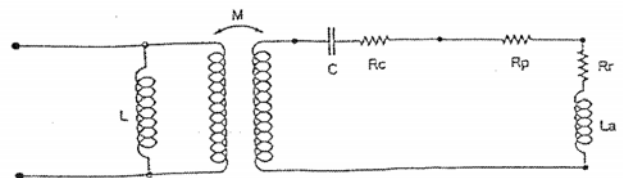
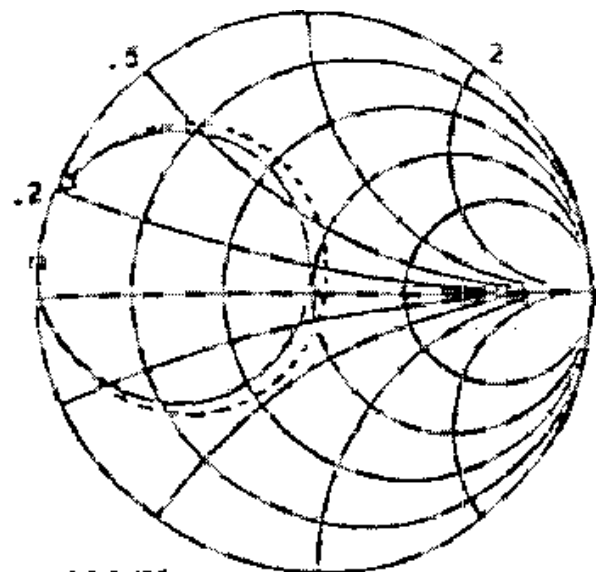

Figure 2

The results are computed by a specific C.A.D. radiofrequency device and compared to the values measured on full scale antenna mock-up.

As an example, **FIG 3**, **FIG 4**, **FIG 5** show the



F1: 2.00 MHz
F2: 2.10 MHz

Figure 3

impedances at various frequencies on the Smith charts, with computed values (in full line) and measured values (in dotted lines). These charts underscore the performances of a resonating cavity like a R, L, C parallel device, and confirm the impedance values computed by the method of moments.

The calculated and measured values are compared at various frequencies (FIG 6, FIG7) The bandwidth is measured at VSWR \leq 2.5:1 , when the real and the imaginary terms of the impedance are equal.

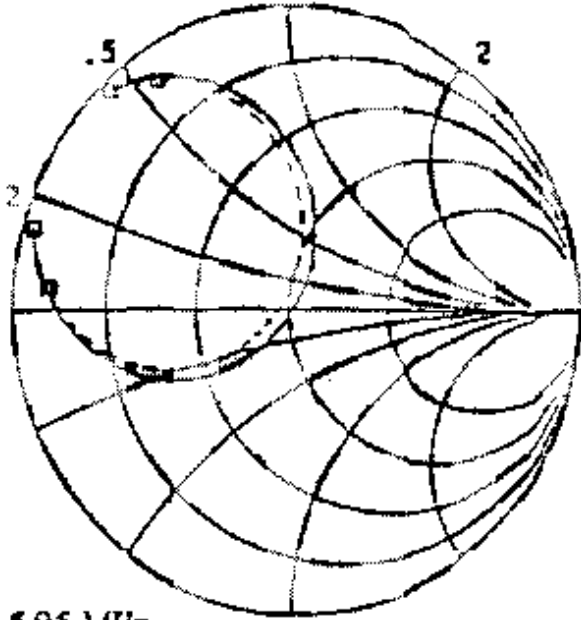

F1: 5.95 MHz
F2: 6.05 MHz

Figure 4

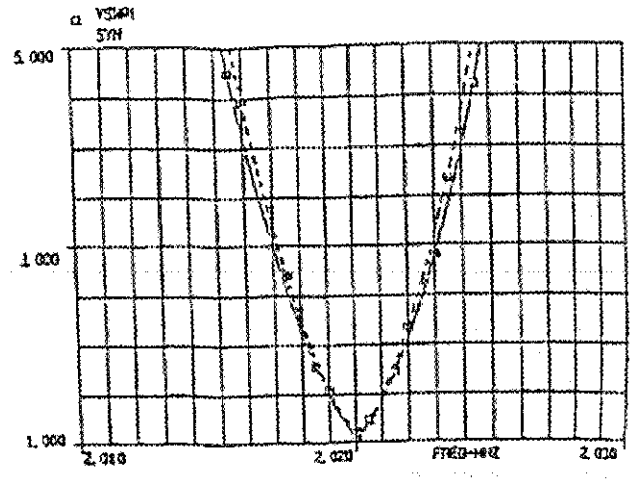
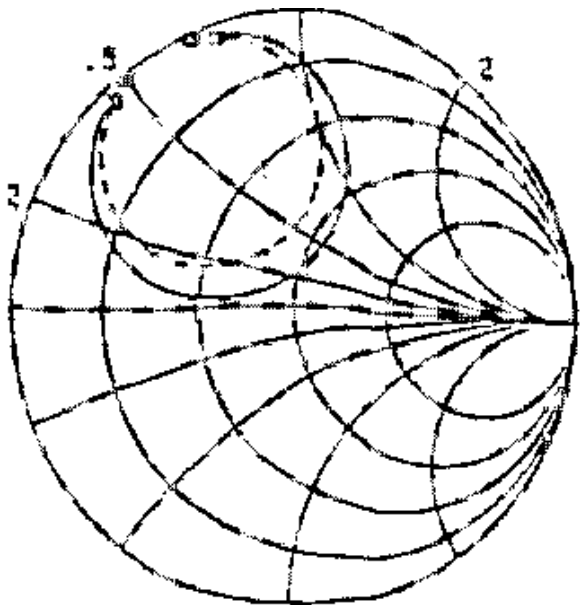

Figure 6



F1: 11.50 MHz
F2: 12.50 MHz

Figure 5

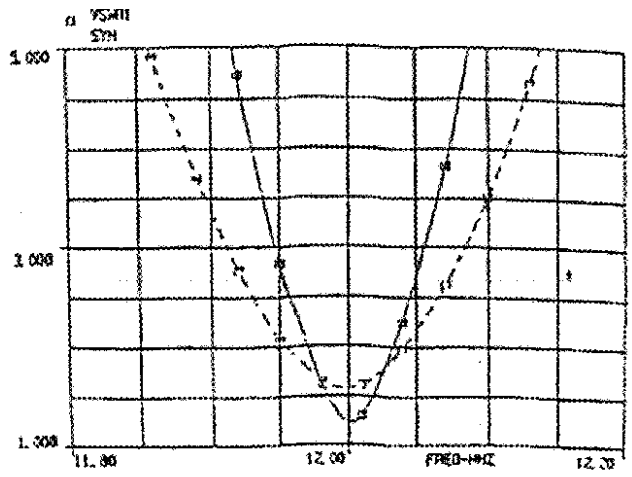

Figure 7

The results have validated the antenna equivalent circuit.

This scheme helped to optimize the dimensions of the radiating element, considering the efficiency and bandwidth requirements. The approximative values are, from 2 to 12 MHz:

$R_r = 0,5m\Omega$ to 3Ω with a $2,2m^2$ antenna surface

$R_p = 0.01$ to 0.02Ω

$C = 3500$ to 60 pF

$R_c = 0.05$ to 2Ω

Chapter 1: HF ANTENNAS

The equivalent circuit aided in the calculation of the voltages and the currents developed over each electronic component.

II. 4. Modelisation of the antenna type B

The tuning capacitor is positioned in the primary of the autotransformer (FIG 8).

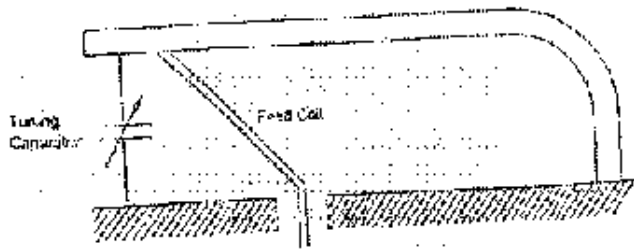

Figure 8

Its equivalent electrical scheme is given on FIG 9.

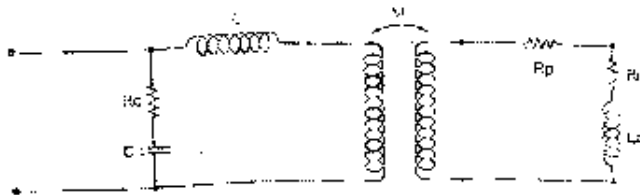

Figure 9

The Type B antenna is modeled in the same way as the Type A antenna, and using the same physical parameters. An additional capacitor may be added in the feed rod to optimize the radioset matching impedance.

II.5. Compared performances type A and type B antennas

Comparative simulations

The compared simulations gave a clear advantage to the Type A antenna type. As an example, FIG 10 shows a +12 dB gain advantage for the Type A antenna at 12 MHz

Comparative measurements

The comparative simulated results were confirmed by the comparative measured bandwidths. Using 2 antennas having the same radiating surface, the compared measured bandwidths were 5 to 10 times

Half-Loop Antennas

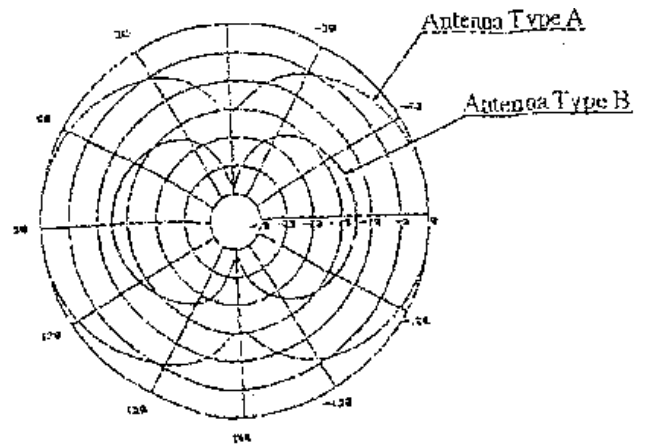

Figure 10

higher for the Type B than for the Type A antenna. In a tuned circuit, bandwidths (B) are inversely proportional to the quality factor (Q), and Q is proportional to the efficiency (h); when $Q \gg 1$, $h \times B = Rr/2p La = \text{constant}$. If h_a and h_b are the Type A and Type B antenna efficiencies, and B_a et B_b their bandwidths respectively, the applying formulas are $h_a B_a = h_b B_b$, and $h_a / h_b = B_b / B_a$. When the measured bandwidth ratios is $B_b / B_a = 10$, the efficiency ratio becomes h_a/h_b is 10.

Explanation

Observing that Type B antenna optimizes the tuning in the primary circuit, and that the Q-factors of primary and secondary are quite different, the energy transfer in the secondary is not maximized. On the contrary, in the Type A antenna the tuning brings a maximum Q-factor and the current is the highest in the radiating resistor.

Conclusion

The Type A antenna design brings the best antenna efficiency.

II.6 Improvement of the design

Increasing the bandwidth

Trials on vehicles were made under strong rain. Modifications of the tune positions were observed at the highest frequencies (FIG 11)

Such modifications can give an operational problem with no possible reset in transmission (in FH mode principally).

This shifting problem was resolved by widening the bandwidth by using two radiating elements in parallel and electrically linked. The simulation of this structure

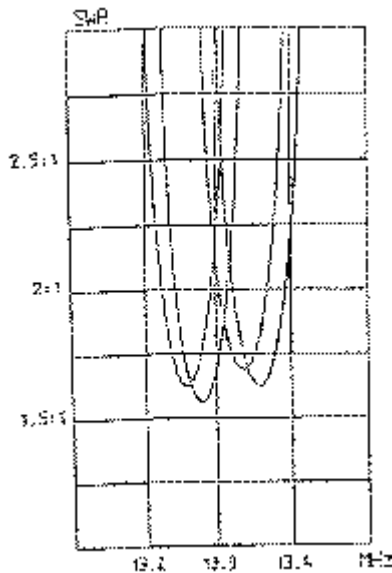

Figure 11

modification concluded in a +10 to +15% extended bandwidths and in +0.5dB to +1dB extra efficiencies all over the frequency range.

II.7. Realisation of a fast tune design

The 2-12 MHz. antenna was developed for the required efficiency and a minimum 3.5 kHz bandwidth independently of the variations in the environment.

With a 2.2m² radiating surface the half-loop reactance is 2mH at 2 MHz and 3.5mH at 12 MHz.

The tuning principle consists in switching capacitors in parallel to create a series of bandwidths with mutual covering at a VSWR < 2.5:1. (FIG 12)

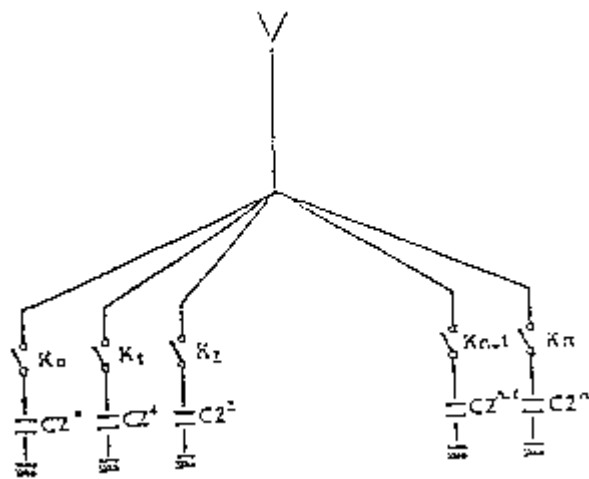

Figure 12

Principle of the capacitor switching

The capacitors which are necessary to tune the antenna reactance are scaled from 3300pF to 60 pF at 2 MHz and 12 MHz respectfully, with a 1,5 pF accuracy at the highest frequencies.

A logarithmic series of n switchable capacitors in parallel defined by $C_i = 2 C_{i-1}$ with $C_1 = 1.5$ pF give all discrete value multiple of 1,5pF:

$$C = S \cdot k_i \cdot C_i \text{ from } i = 1 \text{ to } n, \text{ with } k_i = 0 \text{ ou } 1$$

C1, which is the smallest used capacitor, defines the accuracy of the C capacitor

The highest individual capacitor value is in theory $3300/2 = 1650$ pF in order to get 3300pF by the addition of all capacitors, and n must be higher than 10.

The total number of capacitors is chosen equal to 12 to take into consideration the dispersion of the components whose values are guaranteed with a $\pm 5\%$ precision, and to recover the possible missing frequency bands.

A special software was created to define and memorize the $k_i C_i$ arrangements which are necessary to get all discrete capacitor values and recover the possible missing frequency bands. It memorizes the calculated values and the measured values. A calibration at the first installation or in operation in case of a major environment change can be done in less than 6 seconds.

Measured results

The prototype of the antenna achieved a VSWR 2.5:1.

Typical figures are given FIG13.

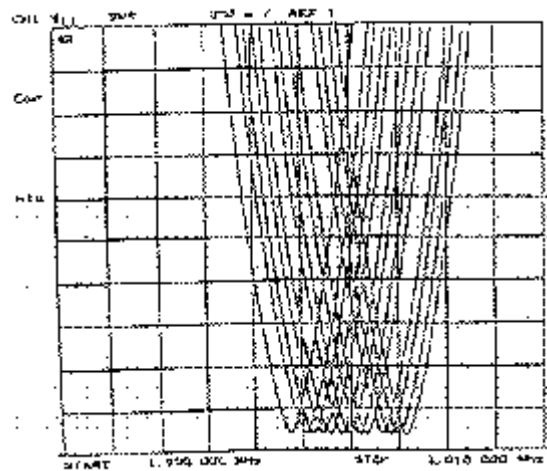

Figure 13

II.7. Qualification

A 2-12 MHz demonstrator was built with acceptable dimensions for land mobile applications (height=90cm, length=2.4m, width=30cm). All adjacent bandwidths were covered within the 2.5:1 VSWR specification.

Its efficiency was measured every 0.5 MHz on a test station by substitution of a reference whip. These values were not more different than ± 1 dB from the values deducted from the Q-factor measurements.

A second version with a 2-30MHz frequency range was developed. It was qualified for military environment with mechanical tests (chocks, vibrations) and climatic tests (-40C +70C, rainfall, salted fog, windspeed, ice, dusts, etc...) according to MIL SPEC standards. It is now in service in quantities in the French Army.

III FIELD TRIALS

Extract from the field trial made by Thomson-CSF in October 1994 for the French Army:

"From 0 to 600 km, all Q/S and S+N/N measurements have confirmed a behaviour without fault of the half-loop. It always gave results much higher than that of the guyed 5m whip whatever the climatic conditions were (rain, intensive fog...). We tried to use the station in the most extreme environment conditions noting the link results, while driving under the rain, under the high voltage cables either parallel or perpendicular to the road, measuring signal/noise in highly industrialized towns (like Clermont Ferrand) , on the country roads through humid forests, etc..."

"The results were independent of these environmental conditions, the reception signal/noise being only slightly affected under the very high voltage cables.

"...The half-loop antenna brings the best results in terms of link budget and listening comfort".

Thomson-CSF also confirmed that the half-loop antenna on a moving car allows fast data transmissions without fault in the silent zone of the whip antenna, and that it improves the probability of successful synchronisation of the new procedures in bad ionospheric conditions.

Other field trials were successfully conducted in France and several foreign countries in the Middle East and America.

IV RADIO INTERFACES

Mobile and naval half-loop antennas and fixed/semi-fixed loop antennas using the same electronic components and softwares are working today with various radiosets for military and civilian applications as well, in frequency hopping, ALE or fixed frequency modes. A modular and universal interfacing unit makes it possible to fit the antenna at the radio set RF output using the control interfacing designed for its antenna coupler.

The control exchanges can be done in RS232 or multiwire cable according to the speed. The frequencies can be provided in clear, as a channel number or not provided at all. A frequency counter is necessary in this last configuration.

(Continue on the next page)

MILITARY TACTICAL ANTENNAS

STAREC has been involved for a long time in the design of specialized antennas, a wide range of which has been proved in operation with French and foreign Armed Forces.

This equipment is mainly used in fixed or mobile weapons or telecommunication systems, such as shelters, trucks, battle tanks, forward armoured vehicles, etc. STAREC is involved in the RITA, ROLAND, PR4 G, HF Carthage programs.

Agile half loop on vehicle



<http://perso.wanadoo.fr/starec>

V APPLICATIONS

The chart below present the "not so wellknown" specificities and applications of the HF tuned HF/125W loops and half-loops.

GENERAL CHARACTERISTICS	APPLICATIONS
<p>Very small dimensions for HF (1.5 to 3m rectangle or diameter) Can be radomed</p>	<p>Difficult installations (on roof, small areas, ship,...) Half-loop capability to communicate from a moving vehicle. Discrete stations (fixed and mobile)</p>
<p>Small surface on ground.A ground plane is not necessary for loop</p>	<p>Easy and low cost installation.</p>
<p>Low take-off angle propagation andGround wave radiation (8-shaped pattern)+Near Vertical Incidence Skywave (NVIS) Directivity: + 2dB in free space and +5dB or +6 dB on a conductive ground Gain: - 12/-15 dBi at lowest frequencies to+ 2/+ 5 dBi at highest frequencies.</p>	<p>Communications up to 1000km with 125W, without silent zone in azimuth nor petal nulls in elevation. Communications of the ships along the coasts and over mountains. One antenna only gives the equivalent services of a NVIS antenna (like horizontal dipole) and a vertical whip (at longer ranges). Achievement of an ALE fully automated mobile station: no more need to change antennas at halt alongside the classic silent zone of whips.</p>
<p>High selectivity in the lowest range. High reduction of outband transmissions. High reduction of received noise and improvement of the Signal/Noise ratio(typically 6 to 10dB in reception compared to the wider band antennas like tuned whips or dipoles) High rejection of the strong wideband signals like high voltage lines spurious, indirect effects of lightening, etc... 2 tuned loops are highly isolated (particularly when they are perpendicular with one frame in the central axis of the other one).</p>	<p>Compared to the whip antennas: Better listening comfort, reduced Bit Error Rate (BER) of data transmissions or FH synchronisation signals. Extra filters can be avoided in many applications. Operational in industrial zones and areas of frequent lightning. Simultaneous transmission and reception on the same narrow site (head of a star chained network, duplex station, HF-HF relay,...)</p>
<p>Fully capacitive tuning unit, without coil nor magnetic signature effect</p>	<p>Interesting for certain ships</p>

HF/125W fast tuned frame antennas can find a number of applications for point to point, ground to air and ship to shore applications at any distance to 1000 km.

OLD MILITARY HF - ANTENNAS OF COMMUNICATION CARS

Igor Grigorov, RK3ZK
antentop@mail.ru

I have a small collection of information about old military HF antennas used over the World. Presently, three old military automobile HF antennas are described at the article. The antennas are written "as it is," i.e., I give all information, that I have had. I know, the information is not complete at all, but, nevertheless, the information is interesting and it can help somebody to make own 'car antennas.'

Tuned dipole

Tuned dipole exhibited in **Figure 1** was used in army of the USSR. Scheme for the antenna is shown in **Figure 1a**. Tuned dipole made from a strong tube that has diameter 15 to 30 mm. The tube is installed at height of 1-1,5 m above the roof of an automobile and goes out approximately on 1 meter for overall

dimensions of the automobile, as it is exhibited in **Figure 1b**. Tuned dipole has high radiation both at low and high (mostly) angles. It allows the antenna to make links by earth and reflected from ionosphere wave.

Figure 1 Tuned dipole

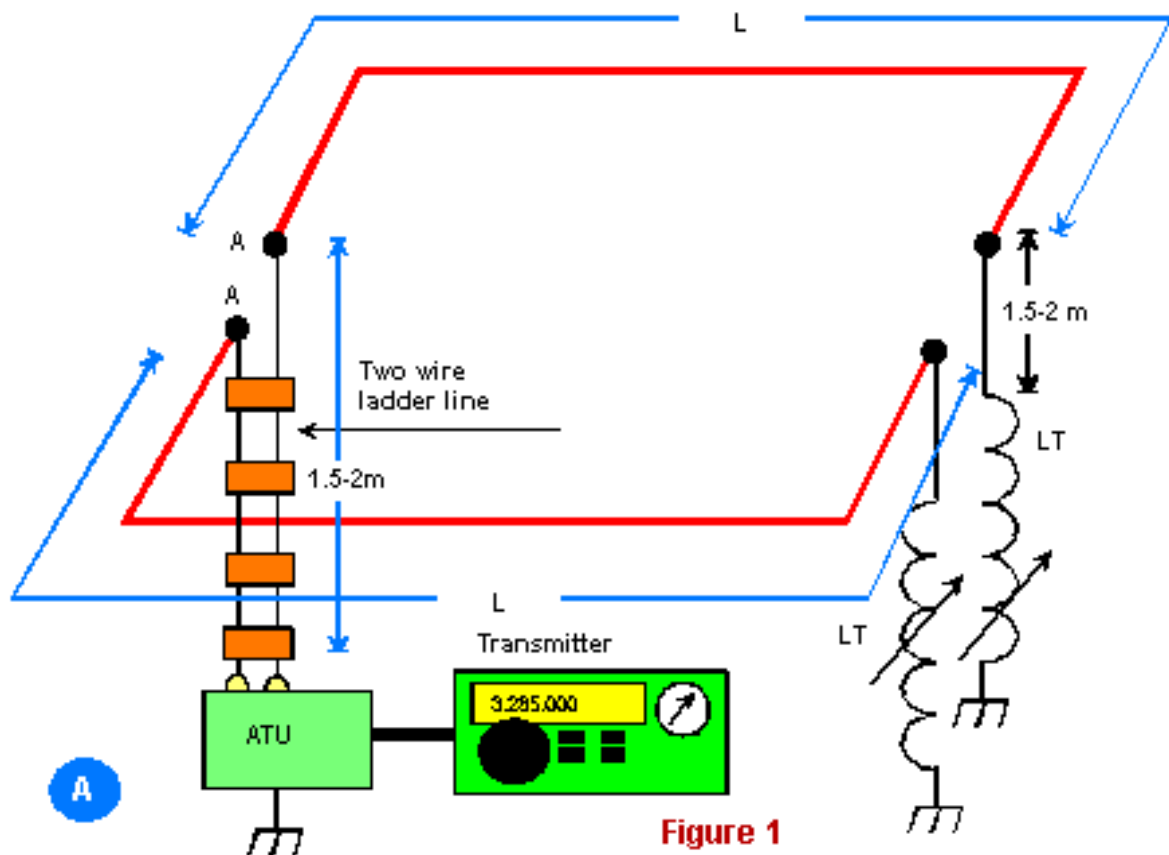

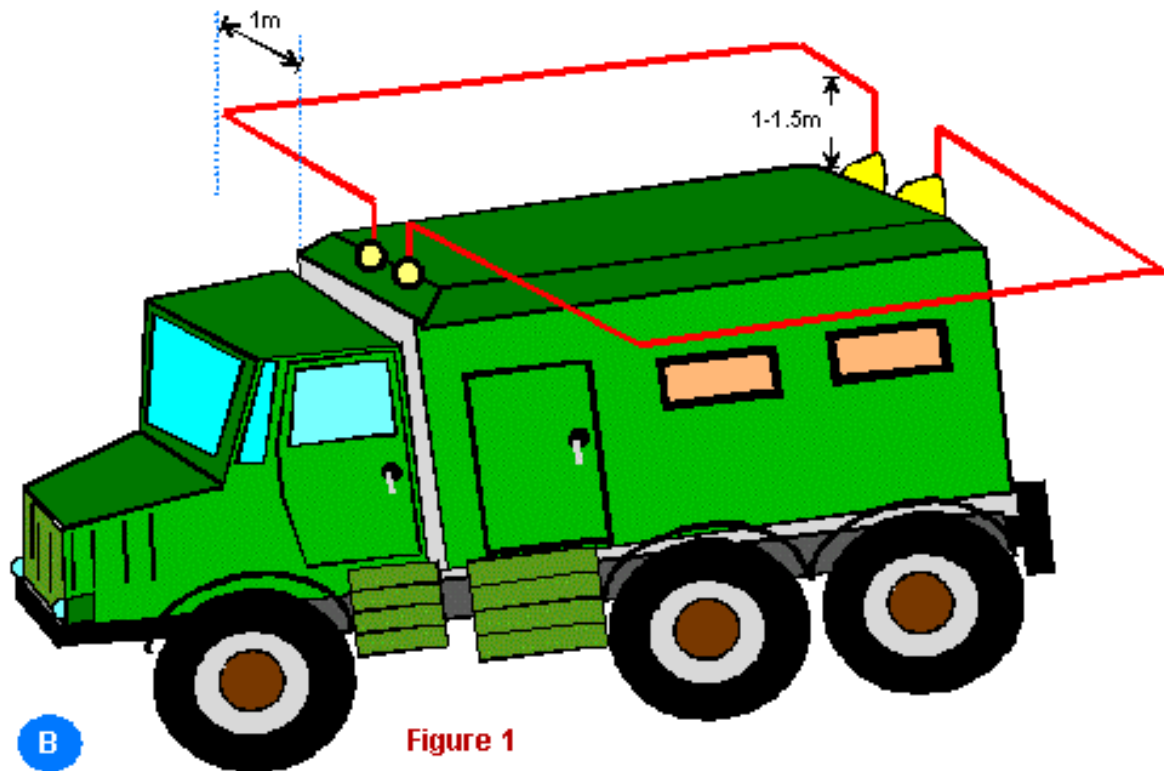

Figure 1

Length 'L' of the antenna (see **Figure 1a**) depends to dimensions of a car, where the antenna is installed, usually the length close to 6 meters. The antenna feeds with help a short length of a two-wire line, usually the length is equal to 2- 3 meters, an ATU is used. Antenna is adjusted with help of a symmetrical variometer 'LT' installed at opposite ends of the tuned dipole. The antenna is tuned on maxima of RF current to points 'A'. In such case the antenna ensures maximum effective work. But in the manual of the antenna is pointed, that the antenna in some cases can be tuned on maxima of RF voltage on points 'A'. Such set-up for the antenna is possible if the communication car is placed on a good conducting surface (it can be moist salty soil) or by operation from natural shelters - holes, ravine. Inductances of antenna variometer vary from several microhenry up to 300 microhenrie. The antenna works good at 2-25 MHz.

At usage of this antenna in military communication car, the antenna gives that advantage, that the roof of the automobile remains free. It enables to install on the roof other antennas, for example, for VHF-UHF ranges

Folded dipole

Folded dipole was in use within the World War – II and till 70s of the 20 century. The dipole is a wire folded by meander and loaded to serial coil plus a capacitor. **Figure 2** shows the disposition of the folded dipole on communication car. The antenna is located at the altitude approximately at 1-1,5 meters above the roof. **Figure 3** shows the scheme of the antenna. Wings of the folded dipole

could reach to 10-15 meters in length. It depends on sizes of the car.

Folded dipole is fed by two-wire ladder line in length about 3 meters. The line is connected to an ATU. The antenna is tuned on maxima of RF current to points 'A'. Folded dipole is tuned in resonance in the operation frequencies with help of loading spools 'LT' together with capacitor 'C', that made as a constructing part of the car.

The antenna is intended for 60-90 meters, and usually does not work at other ranges. . Folded dipole has strongly radiation to the sky and a little to the horizon.

Dipole with low characteristic impedance

Dipole with low characteristic impedance is intended for a work at wide frequencies range and for installation on the roof of a communication car that has small dimensions. **Figure 4** shows the scheme (**Figure 4A**) and disposition (**Figure 4B**) of the dipole on communication car. I must say, that I have seen some photos, where the antenna was installed athwart to the roof, as it is shown at **Figure 4C**. The antenna is located at the altitude approximately at 1 meter above the roof. Wings of the dipole made as a metal grid has shape, crosswire at the cells soldered. The wing of the dipole has the width in (0,5-1,5)-meters and the length (1,5-2)-meters.

Figure 5 shows the scheme of feeding of dipole with low characteristic impedance. The antenna is connected through a two-wire ladder line in about 2 meters length to an ATU. The ATU has a resonance

Figure 2 Folded dipole placed on communication car

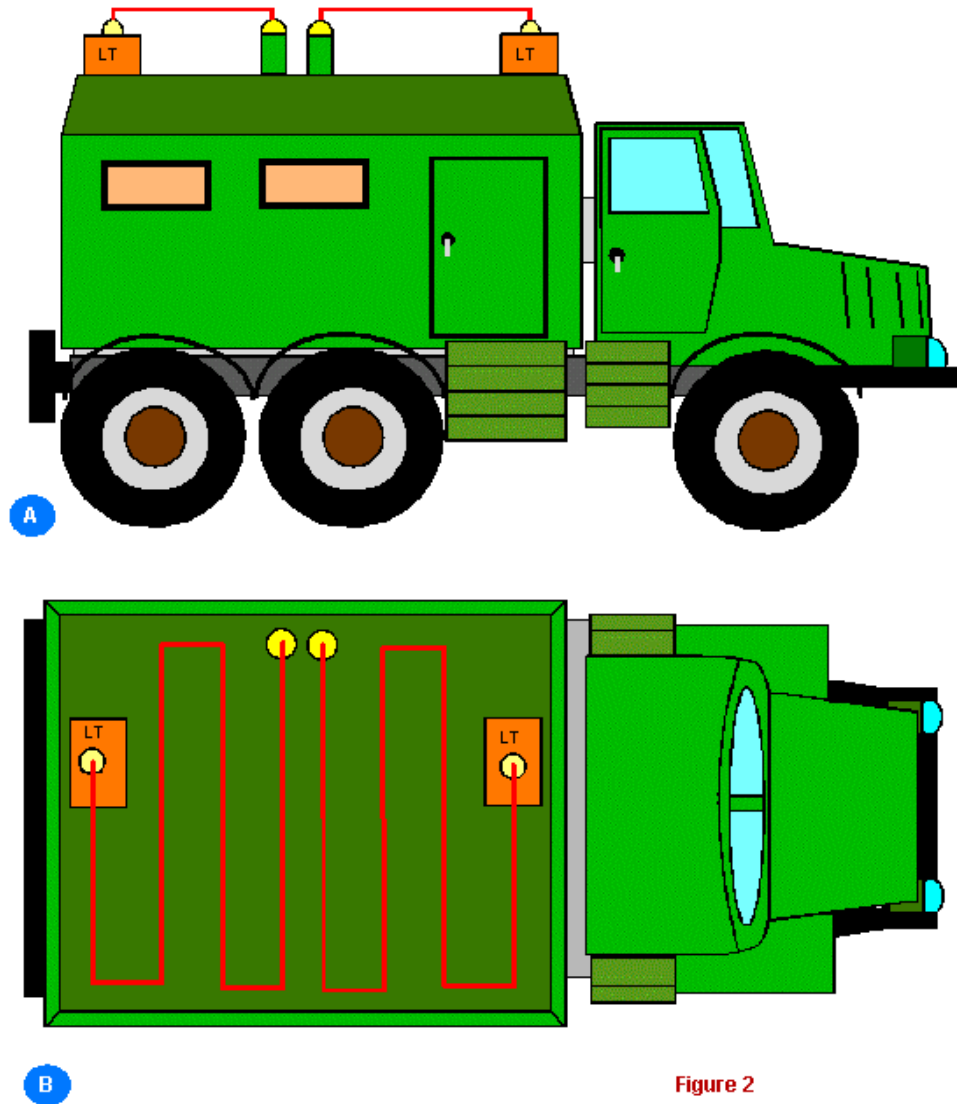

Figure 2

Figure 3 Scheme of the folded dipole

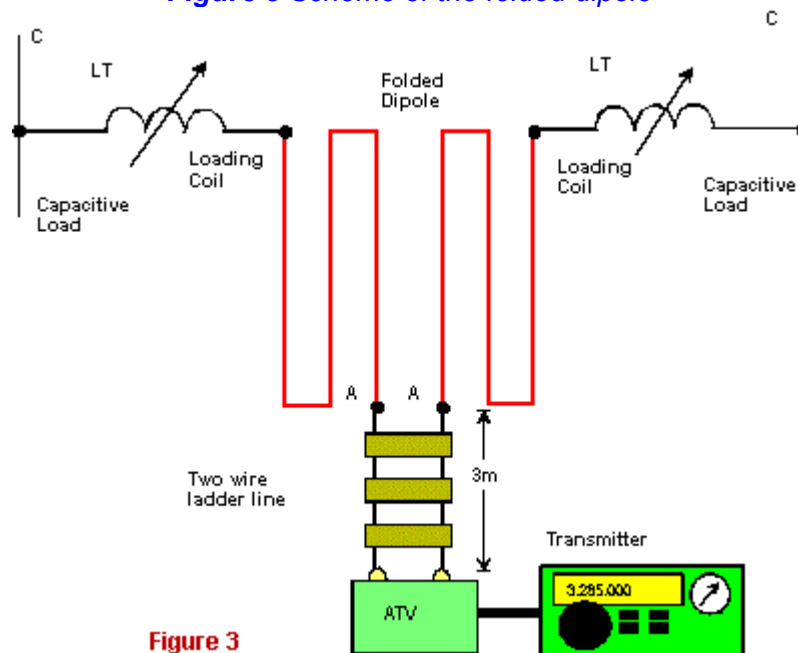

Figure 3

Figure 4 Dipole with low characteristic impedance

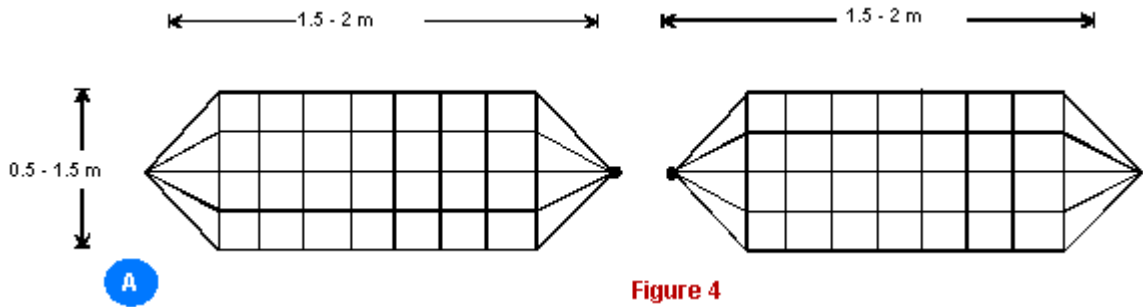

Figure 4

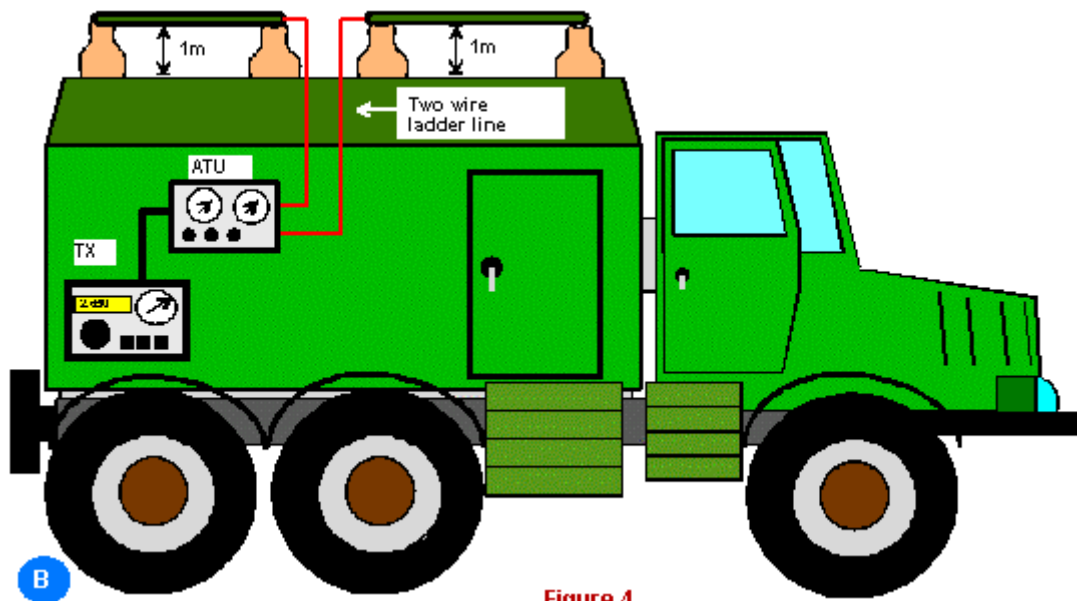

Figure 4

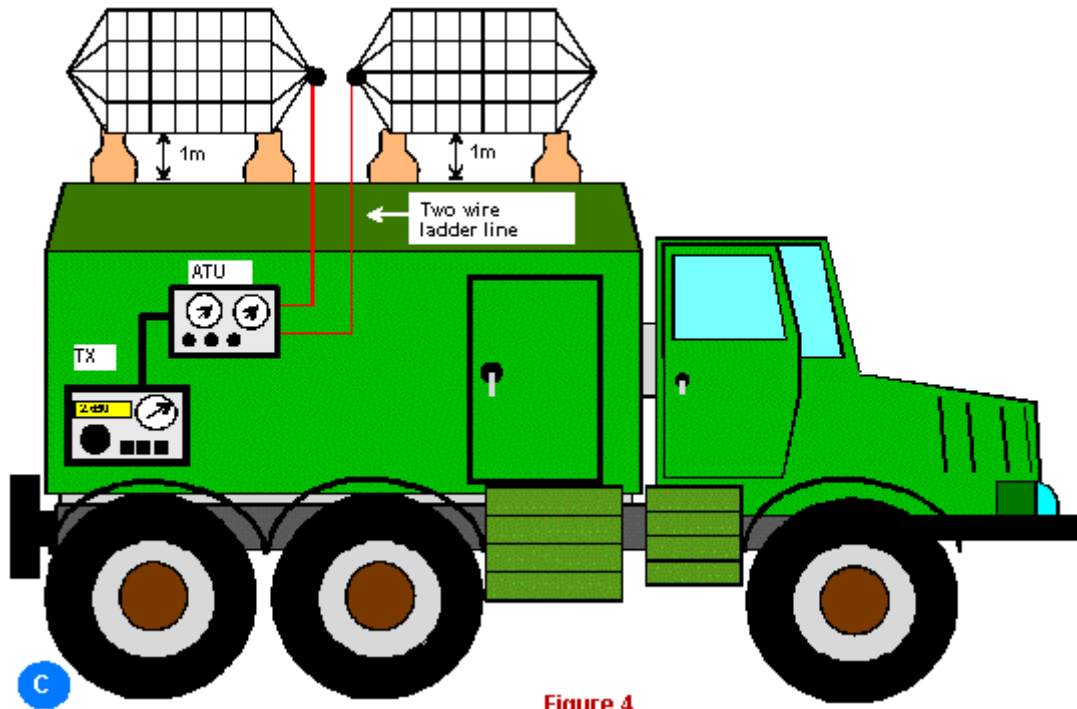

Figure 4

Figure 5 Scheme of feeding of dipole with low characteristic impedance.

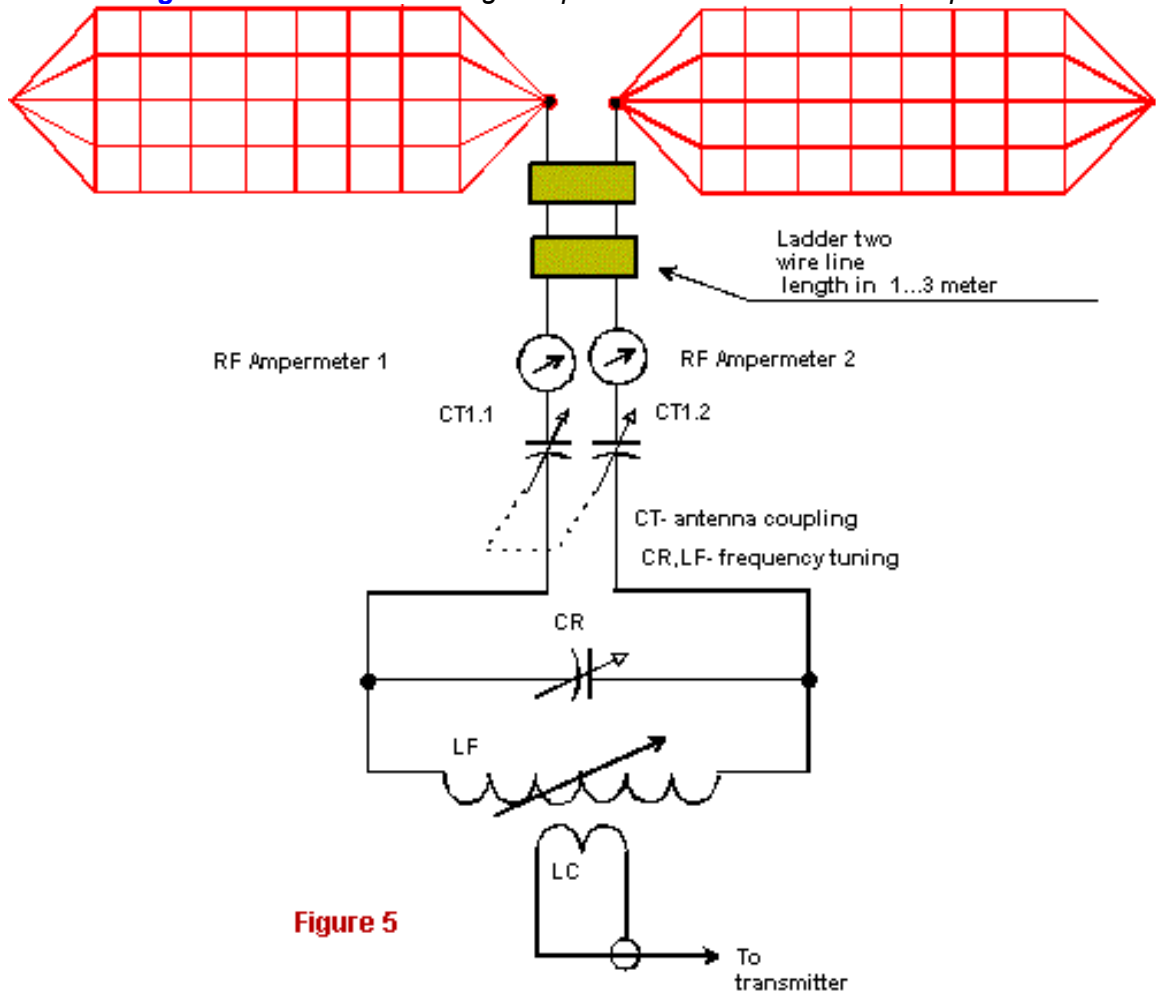

Figure 5

circuit 'LF- CR', that is coupled with help of coupling coil 'LC' with a transmitter. With the help of variable spool 'LF' and variable capacitor 'CR' this circuit can be retune in the frequencies range of 2-20 MHz. In the same frequency range the antenna works. Maxima of RF current in to the antenna is installed with the help of variable symmetrical capacitor 'CT.'

Such antenna was widely used in communication cars during the World War-II and some time after the

war. The antenna ensures the sure communication with zenith radiation in HF range 2- 4 MHz in radius of 200-300 km from the antenna. Also this antenna ensures long-distance communication in HF ranges 5-20 MHz.

But this antenna had the deficiencies: at the first, it has too complicated matching device, at the second the antenna takes too much place in the roof of the car. For these reasons, since of the end of 50s, the antenna practically is not used in military communication cars.

Russian Field Radio Station, 1941, w.w.-II

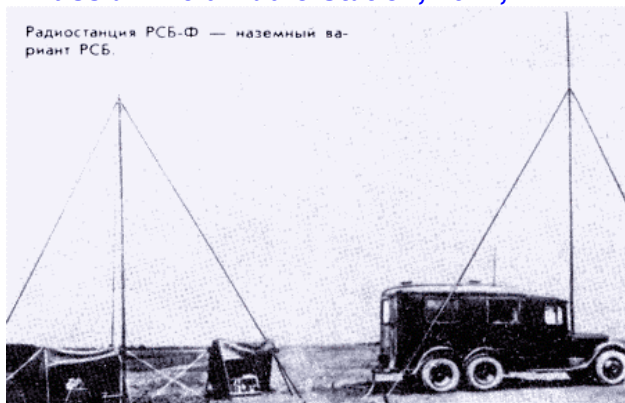

Russian Field Radio Station, 1913, w.w.-I



MODERN MILITARY HF - ANTENNAS OF COMMUNICATION CARS

Igor Grigorov, RK3ZK
antentop@mail.ru

I have a small collection of information about old and modern military HF antennas used over the World. Presently, two modern automobile HF antennas are described at the article. The antennas are written "as it is," i.e., I give all information, that I have had. I know, the information is not complete at all, but, nevertheless, the information is interesting and it can help somebody to make own 'car antennas.'

The basic types of military antennas, which for a long time were used on communication cars, were construed during and before the World War II. After WW-II researches for new antennas for communication cars was renewed. Below we shall consider two new type of car antennas which have appeared in army after the World War-II still are in use on modern communication car. There are magnet antennas and DDRR antennas, that began to be used for communication cars (under my information) rather recently - in the middle of 70s years of the 20 century.

Mag Loop antennas of communication cars for 150-80 meters

As usual a magnet antenna of the range is installed on a communication car as it is shown in **Figure 1**. The magnet antenna ensures sure communication in radius of 200 kms at the daylight time and up to 400 kilometers at the night time.

Figure 1 Magnet antenna on a communication car

The magnet antenna at marching condition is installed parallel to the car roof (see. **Figure 1a**) and does not hinder to ride the car under low bridges or under trees in forests. The magnet antenna stands in operating position with the help of an electric motor or by operator hand. **Figure 1b** shows the zenith magnet antenna in the operating position.

The magnet antenna (item 2, **Figure 1b**) is tuned in resonance on the operating frequency with the help of variable capacitor (item 3, **Figure 1b**), which is weatherproofed by hermetic box (item 4, **Figure 1b**). The variable capacitor is turned with the help of an electric motor. The magnet antenna is drove by a small loop (item 1, **Figure 1b**) that is installed in

corner of the magnet antenna. Driven loop is coupled to the transmitter with the help of a coaxial cable by characteristic impedance of 100 Ohm. The sizes of the army magnet antenna for operation in 150 - 80 meters are exhibited in **Figure 1b**.

Mag Loop antennas of communication cars for meters

Also magnet antennas are used for operation in HF ra 60 meters. Such magnet antenna has smaller contrasted to magnet antenna intended for operation meters. Magnet antenna for 90-60 meters owing to sizes is installed or above the roof of the cabin of comn

car (see **Figure 2**) or at back edge of the car (see **Figure 3**). At this installation of mag loop the roof of the car is free to place other antennas or some more electronic equipment. The sizes of the magnet antenna for operation in 90 - 60 meters are exhibited in **Figure 2** and **Figure 3**.

Figure 2 Magnet antenna above the roof of the car cabin

Figure 3 Magnet antenna on the back edge of the car

The magnet antennas shown in **Figures 1-3** usually are made of an aluminum bent tube in 20- 40 millimeters in OD and 2-3 millimeters thick.

Magnet antennas for 150 -90 meters is not intended for operation when a communication car is moving. But Magnet antennas for 90 - 60 meters can be used when a communication car is moving.

Magnet antenna on a communication car

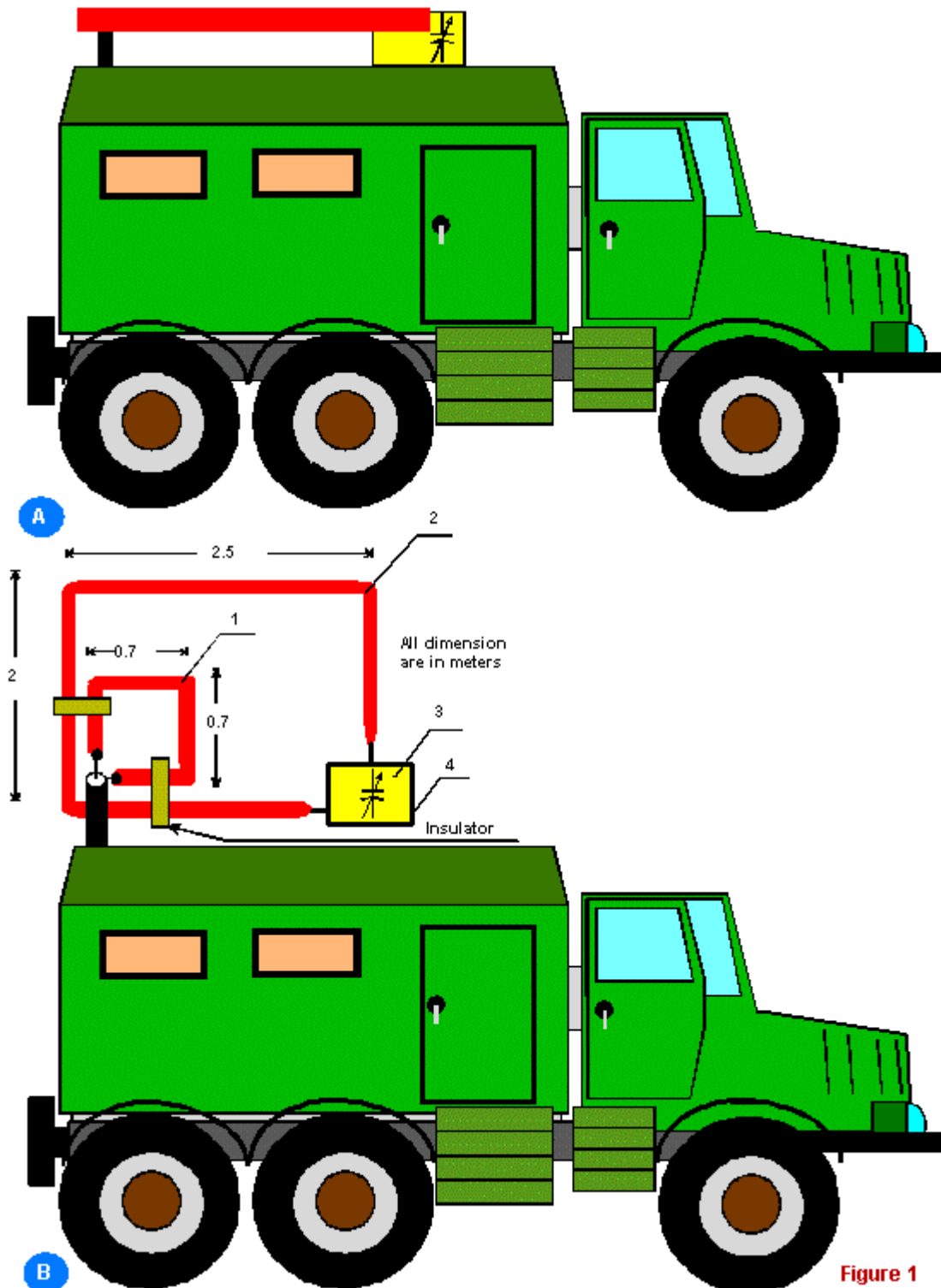

Figure 1

Antennas DDDR in military communication

Antennas DDDR are used in military communication of many countries. Figure 4 shows the schematic of antenna DDDR. Say simple the antenna represents a tube bent in shape of letter "L". The length of the 'L'

is little smaller the quarter wave of the high lower range of the antenna, but the length 'L' not less the lower operation range of the antenna. Antenna DDDR to resonance by the variable capacitor C which is driven by electric motor M. Antenna DDDR, as usual, is made of aluminum tube in 20-40 millimeters OD.

Figure 4 Schematic of Antenna DDDR of communication

Magnet antenna above the roof of the car cabin

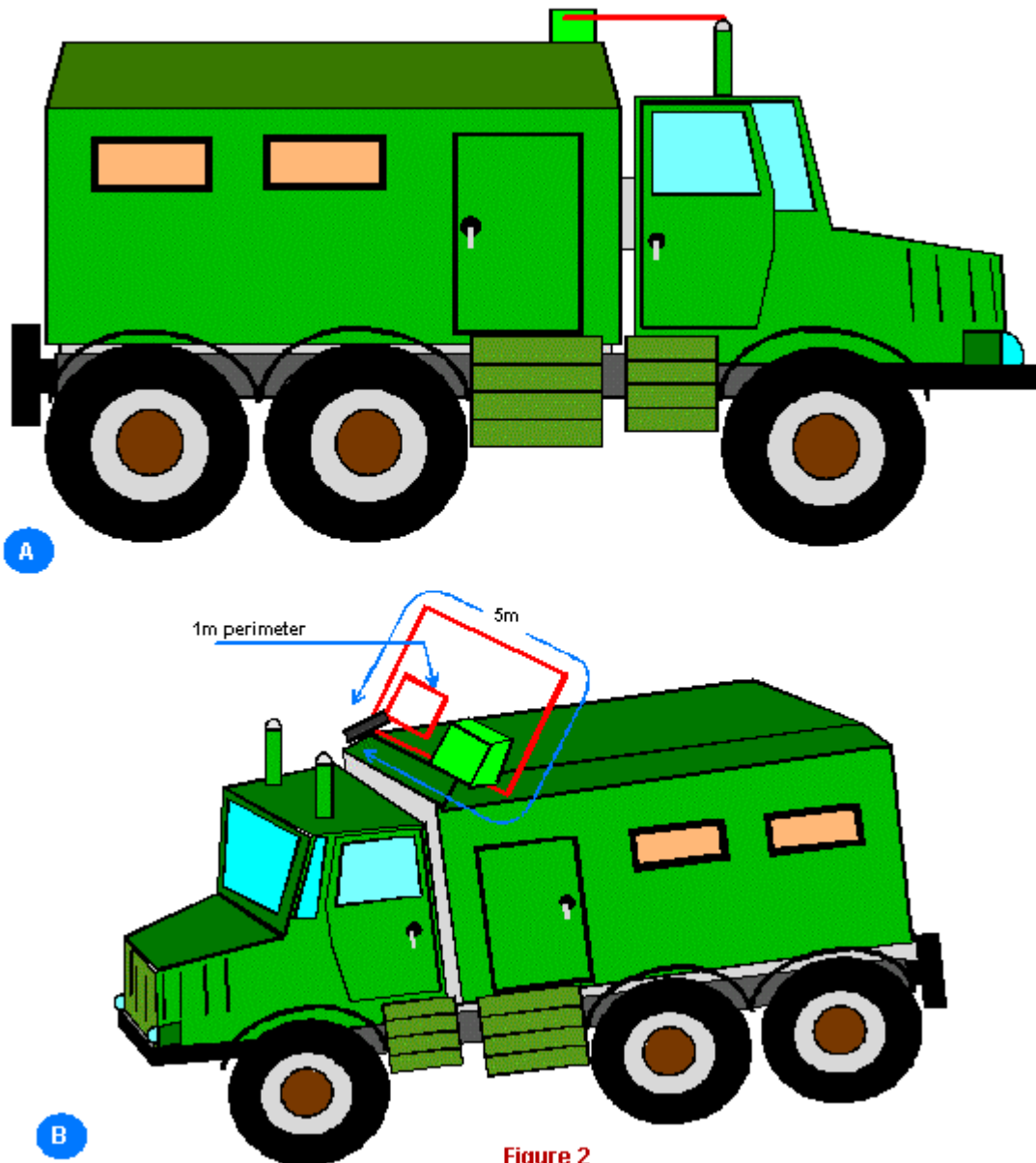

Figure 2

On military vehicles an antenna DDRR usually places on one of edges as it is shown in **Figure 5**. It allows to install other antennas on the roof of the communication car. Antennas DDRR often serve as enclosure of the roof.

Figure 5 Antenna DDRR on military vehicle

Antennas DDRR also are used on some heavy tanks or BMI (battle machine of infantry). On this military vehicle the antenna DDRR serves as a rail for other hand. Antenna DDRR has mechanically strong design, so it is difficult to damage an antenna DDRR in battle.

Seldom use two antennas DDRR that fed with some phase shift to create special diagram directivity. **Figure 6** shows such antenna array.

Figure 6 Array of antennas DDRR

Antenna DDRR is very strong and allows to do comn when the car is moving. Radio amateurs also can use DDRR for the operation in ether at installation on the r car.

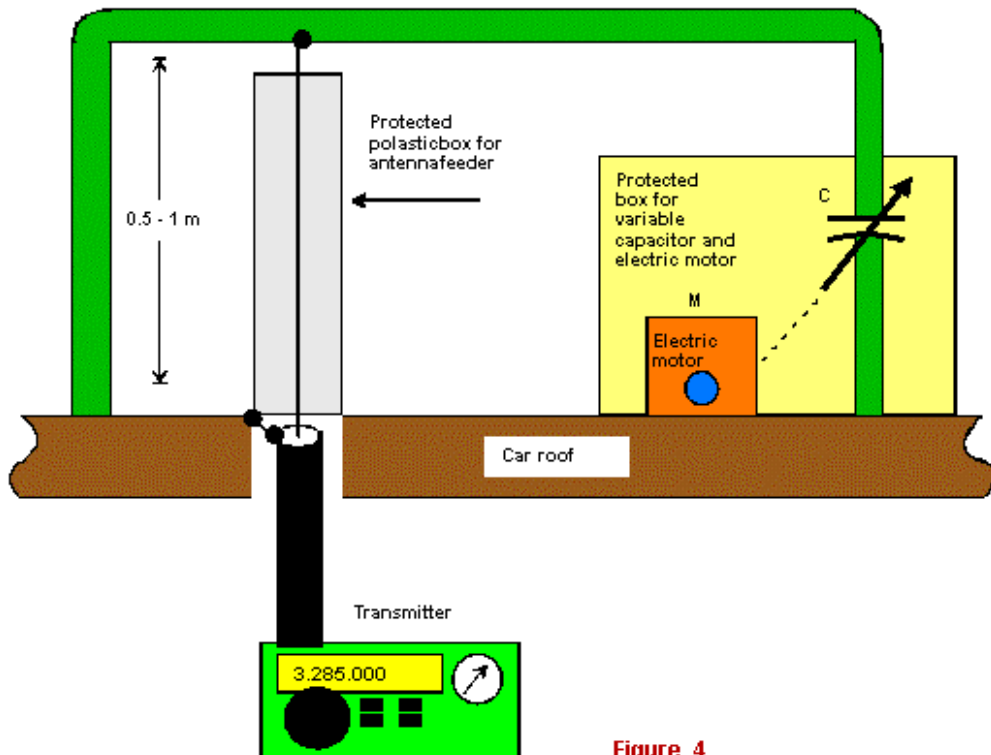
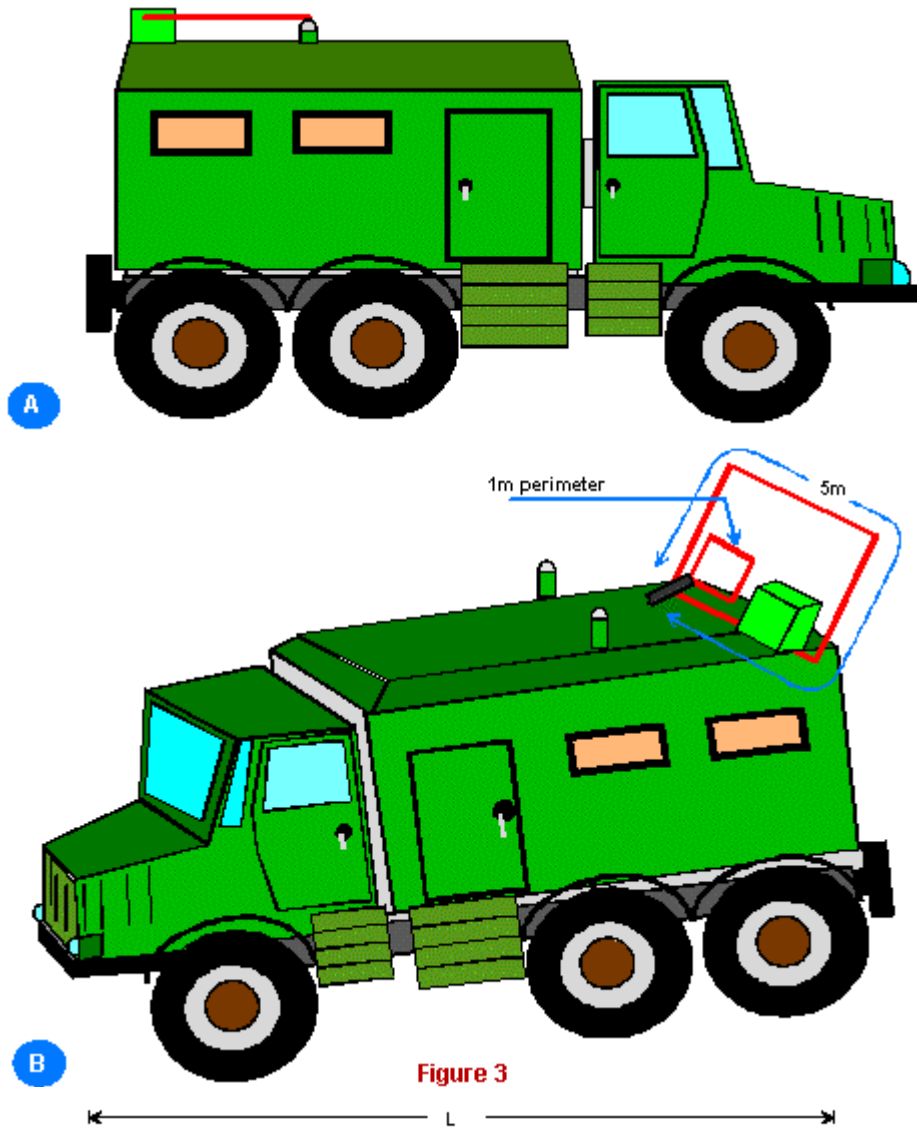

Antenna DDRR on military vehicle

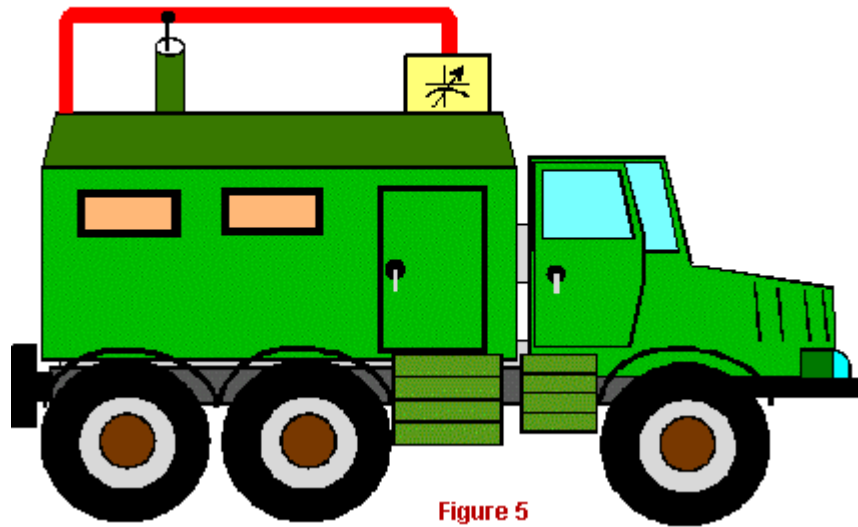

Figure 5

Array of antennas DDRR

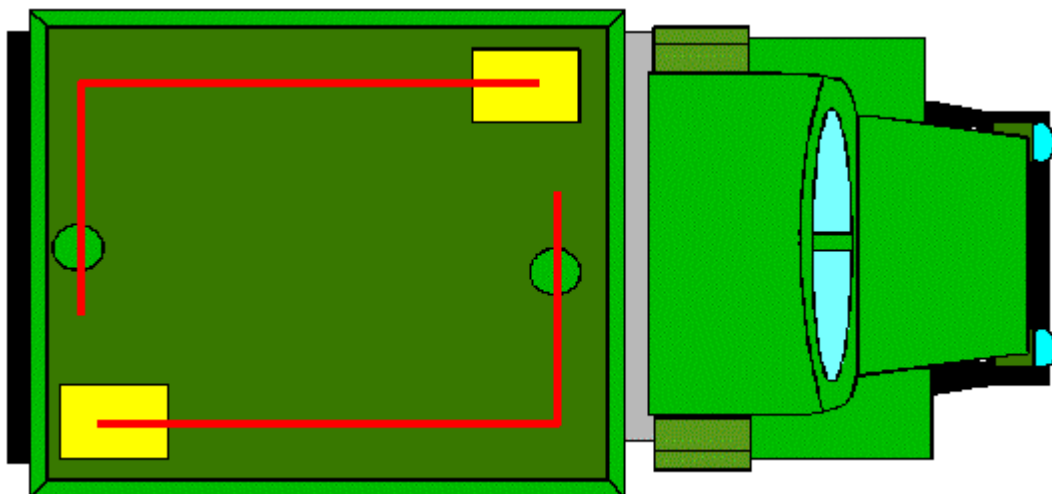

Figure 6

*ANTENTOP is Free e- mag for all radioamateurs over the World.
Feel free to share with friends any issue of ANTENTOP.
Feel free to print, copy to CDs or share in any others ways with any issue of
ANTENTOP.*

73! Igor Grigorov, RK3ZK

<http://www.antentop.bel.ru/> mirror: www.antentop.boom.ru



FIELD UNIVERSAL HF ANTENNA RV3DA

In Russia summer traditionally is the season for radio expeditions. So, the question about a field antenna stands before hundreds of radio amateurs. Certainly, it is impossible to give one answer to this question. A design of an antenna for fields depends on many factors. There are frequency bands used by radio expedition, local factors for antenna installation, time and money and so on. Igor, RV3DA, has developed universal wire antenna. This one with ATU works well on all amateur short-wave ranges, including WARC. There are frequency bands used by radio expedition, local factors for antenna installation, time and money and so on. Igor, RV3DA, has developed universal wire antenna. This one with ATU works well on all amateur short-wave ranges, including WARC.

Igor Grigor'ev, RV3DA

RK3DZD@falcon.ru
<http://www.qsl.net/rk3dzd>

The antenna has a triangular shape, one of the ends of the triangular is grounded. **Figure 1** shows the circuit of the antenna. A good grounding is necessary for successful work of the antenna. However, the antenna provides good work without good grounding also.

The antenna was tested by team of collective radio station RK3DZD in field conditions.

On Eastern Sunday April 11 we have been going to RDA- pedition. About RDA program you can see [page 86, ANTENTOP# 2- 2004](#). Our team (RD3DT, UA3DUS, RZ3DT and RV3DA) and buys settled down at picturesque surroundings of the edge of Tsna river, Egor'evskoe area [MO-62](#) at Moscow oblast.

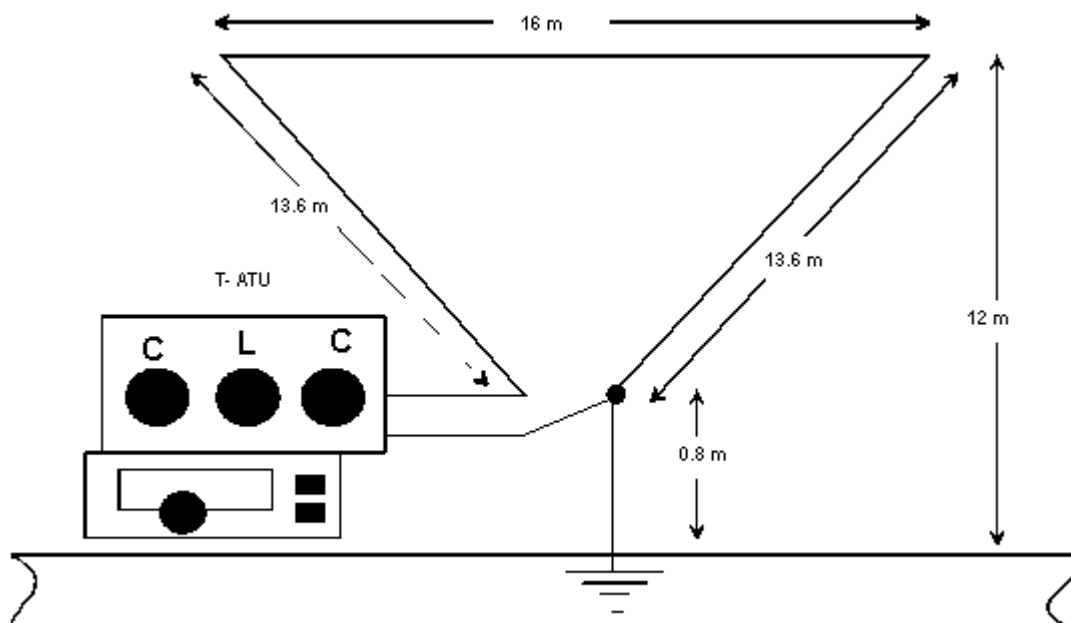
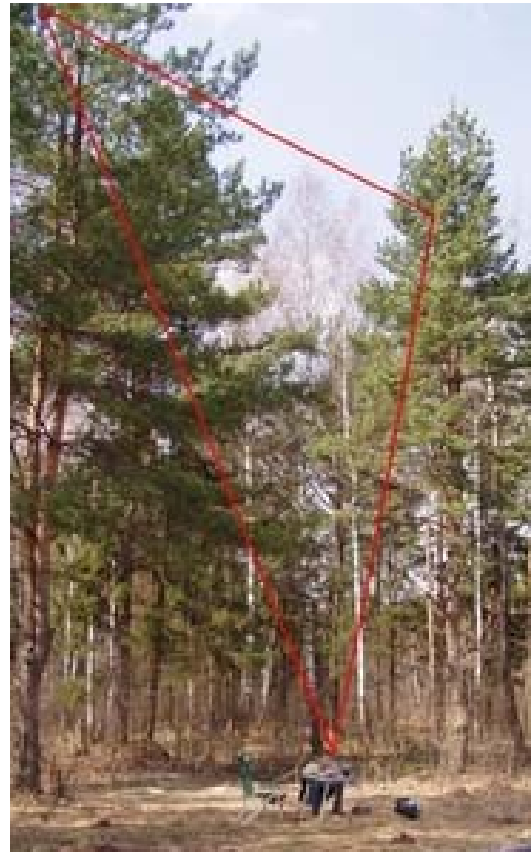

Figure 1

Yuri, RA3DUF, hanged our antenna on the nearest pines. TNX to Yuri, RK3DUF for steeplejack works! You can see a photo of the antenna (antenna colored by red). The antenna had no feeder and was connected directly to a transceiver FT-847 through a home- made T- ATU that was placed at the table. We used an automobile accumulator 55-A/h and gas-generator Honda for feeding our equipment.

Grounding was very bad - a pipe in diameter of 1/2" and in length of 1 meter. The ground was very damp, ten meters father from the antenna a river was. The antenna was hanged between two high pines.

What we have had:

1. 40 meters - is higher than any praises. Really, we ruled by pile- up from tens calling stations. Simultaneously we received as local as DX- stations.
2. 20 meters – the directivity of the antenna did bad effect for us. The antenna was directed to the North - South, that it was not good for us. Southern radio stations simply rattled in the Air!

3. 15 meters- Japanese called us very loudly.
4. On 10 meters was dead (no propagation).
5. 80 meters – we received very loudly many radio station from Siberia (2000- 3000 kms from us) but our sign was received poor in Siberia because, as we think, of poor grounding.

Below given diagram directivity for the antenna obtained with help of free antenna program MMANA (MININEC based). Left diagram is a section of the volumetric diagram directivity of plane X-Y at a zenith corner of the maximum radiation. The right diagram is section of the volumetric diagram directivity of plane X-Z. Also at the right down corner of the pictures is a table with antenna impedance. Please, take attention to the data, you can do decision how you ATU does match of the

73!
Igor Grigor'ev, RV3DA



So our first workplace looked. As usual, we had too little time for preparing before our pedition, so, we

have used "table" T-ATU. Two air variable capacitors and a variable inductor placed on the table without any case. Yury, RK3DUF, did DX- QSO.

Antenna RV3DA at 160-m

Vertical Radiation Pattern

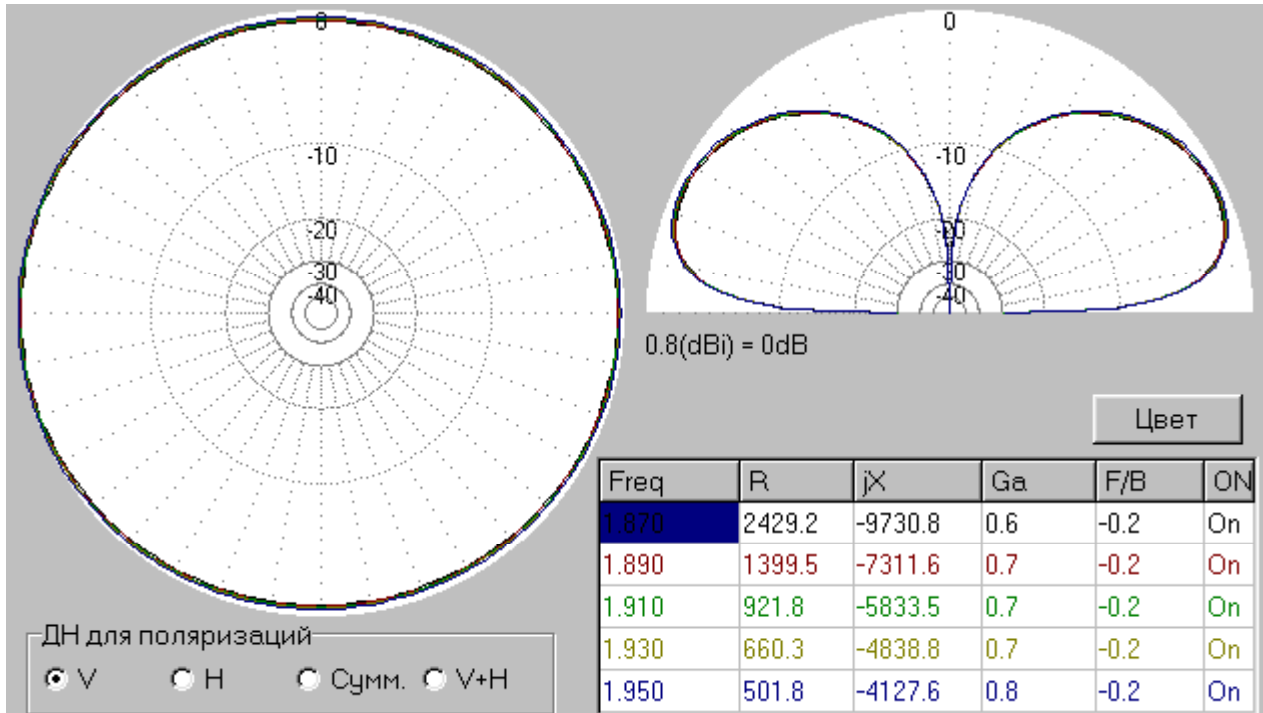

Horizon Radiation Pattern

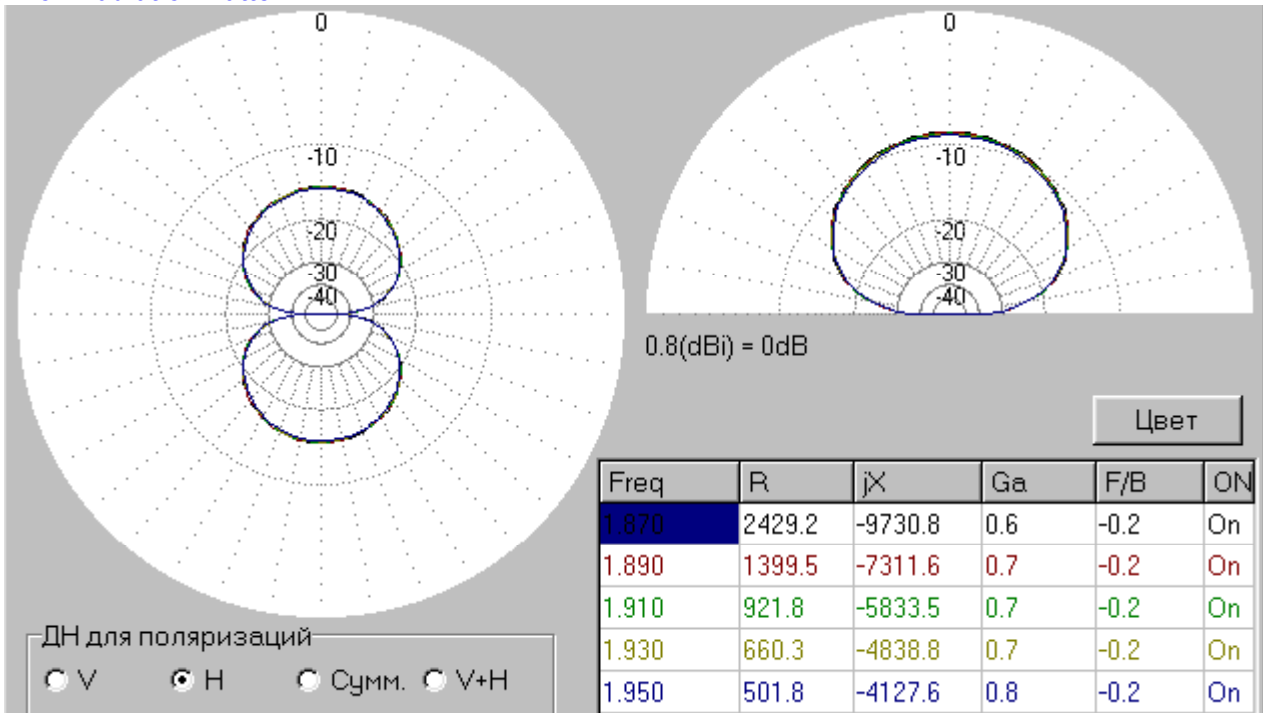

Comments: Antenna radiates mainly radio waves with vertical polarization. A very good pattern with low lobes in the vertical plane. Circular pattern in horizontal plane. It is fine for DX- QSO. But antenna has $Z = 921 - j5833$ -Ohms at 1910-kHz. Not all ATUs do good matching for such load.



Antenna RV3DA at 80-m

Vertical Radiation Pattern

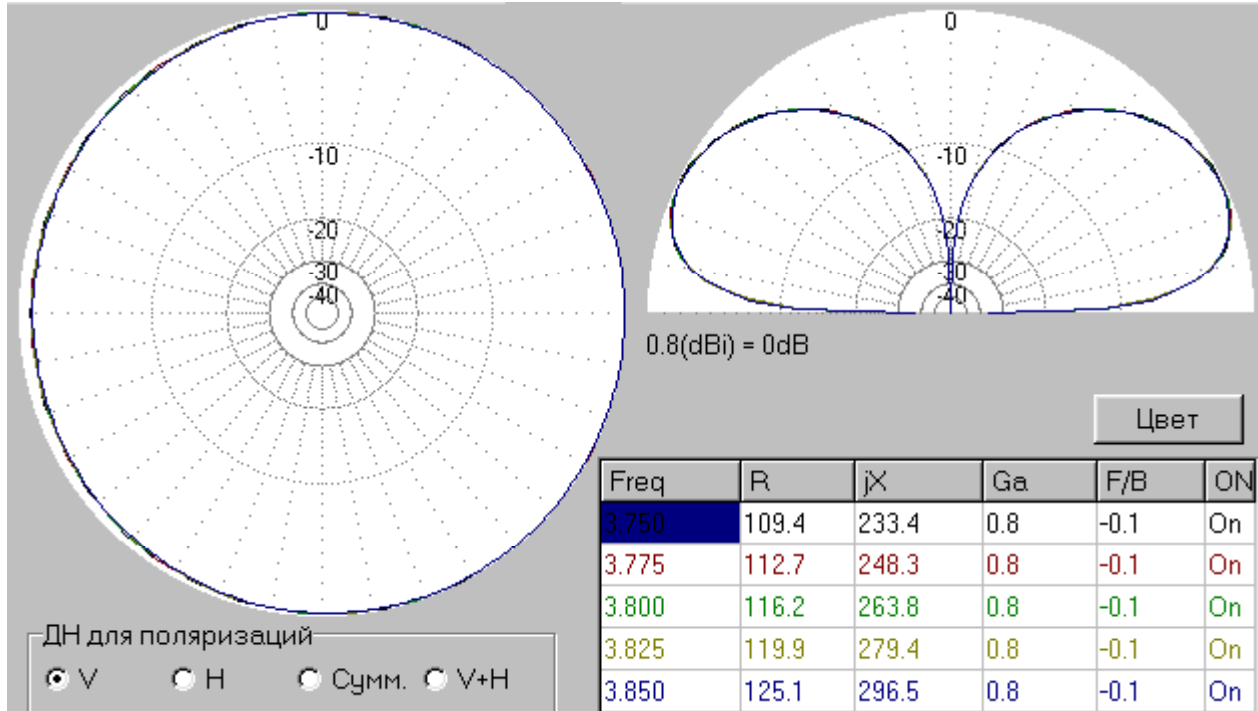

Horizon Radiation Pattern

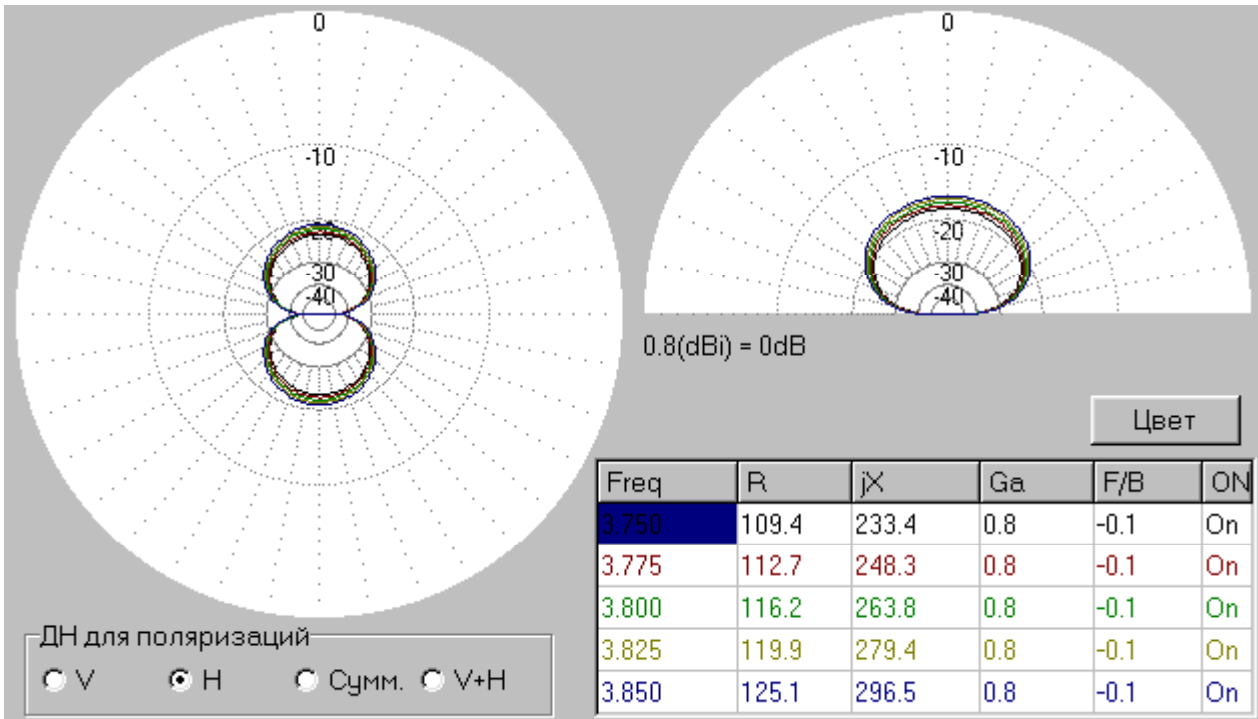

Comments: Antenna radiates mainly radio waves with vertical polarization. A very good pattern with low lobes in the vertical plane. Circular pattern in horizontal plane. It is fine for DX- QSO. Antenna has $Z = 116 + j263$ -Ohms at 3800-kHz. Almost any ATU does good matching for such load.



Antenna RV3DA at 40-m

Vertical Radiation Pattern

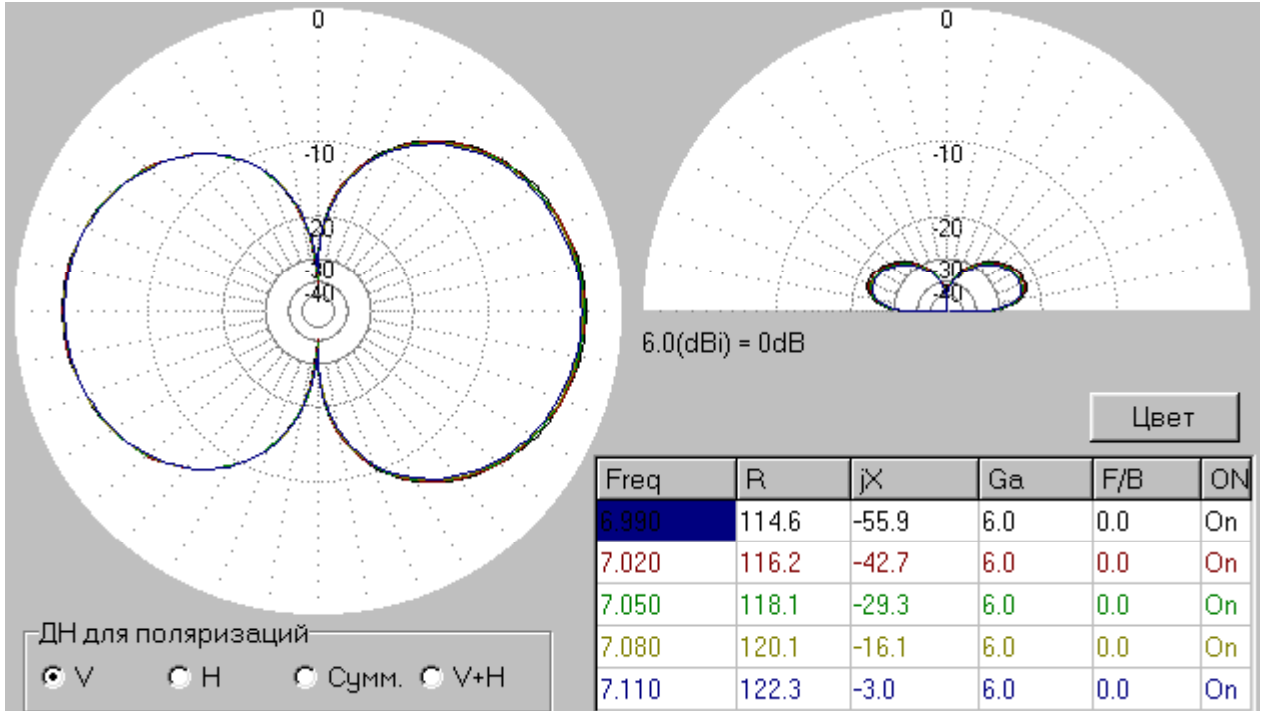

Horizon Radiation Pattern

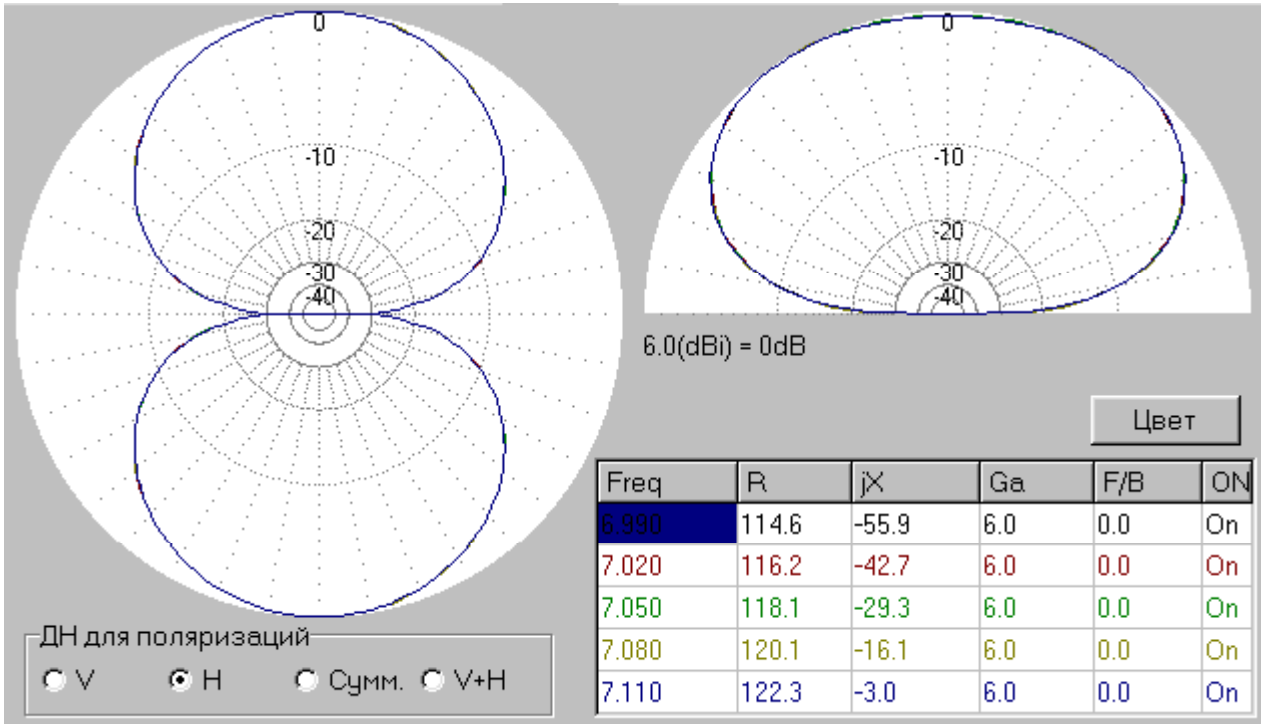

Comments: Antenna radiates mainly radio waves with horizontal polarization. A good pattern in the vertical plane. Antenna has strong zenith radiation that allows to do local QSOs. “Eight-figure” pattern in horizontal plane, so, it demands to choose a proper direction before an installation of the antenna. Antenna is fine for DX and local QSOs. Antenna has Z= 116+ j263-Ohms at 3800-kHz. Almost any ATU does good matching for such load.



Antenna RV3DA at 30-m

Vertical Radiation Pattern

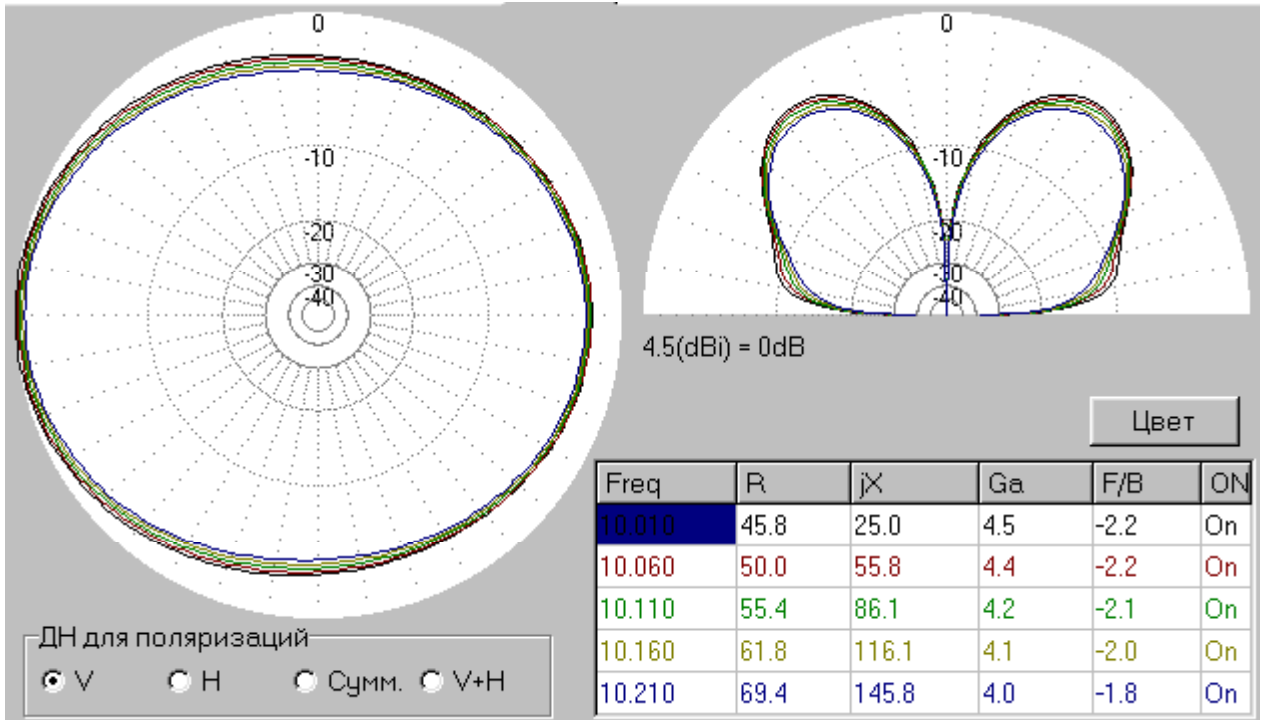

Horizon Radiation Pattern

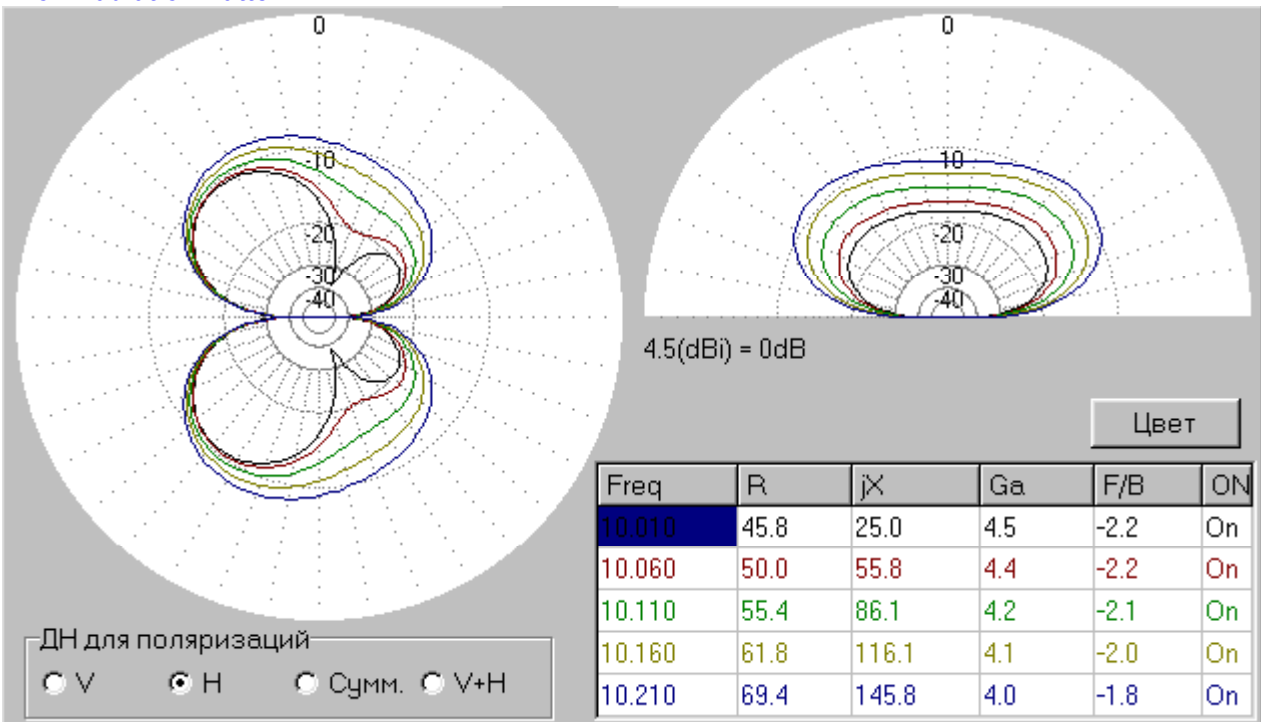

Comments: Antenna has strong vertical radiation. Not bad pattern in the vertical plane. Antenna has strong radiation at high corners that allows to do local QSOs. Antenna has almost circular pattern in horizontal plane. Antenna provides DX and local QSOs. Antenna has $Z = 55 + j86$ -Ohms at 1010-kHz. Any ATU does good matching for such load.



Antenna RV3DA at 20-m

Vertical Radiation Pattern

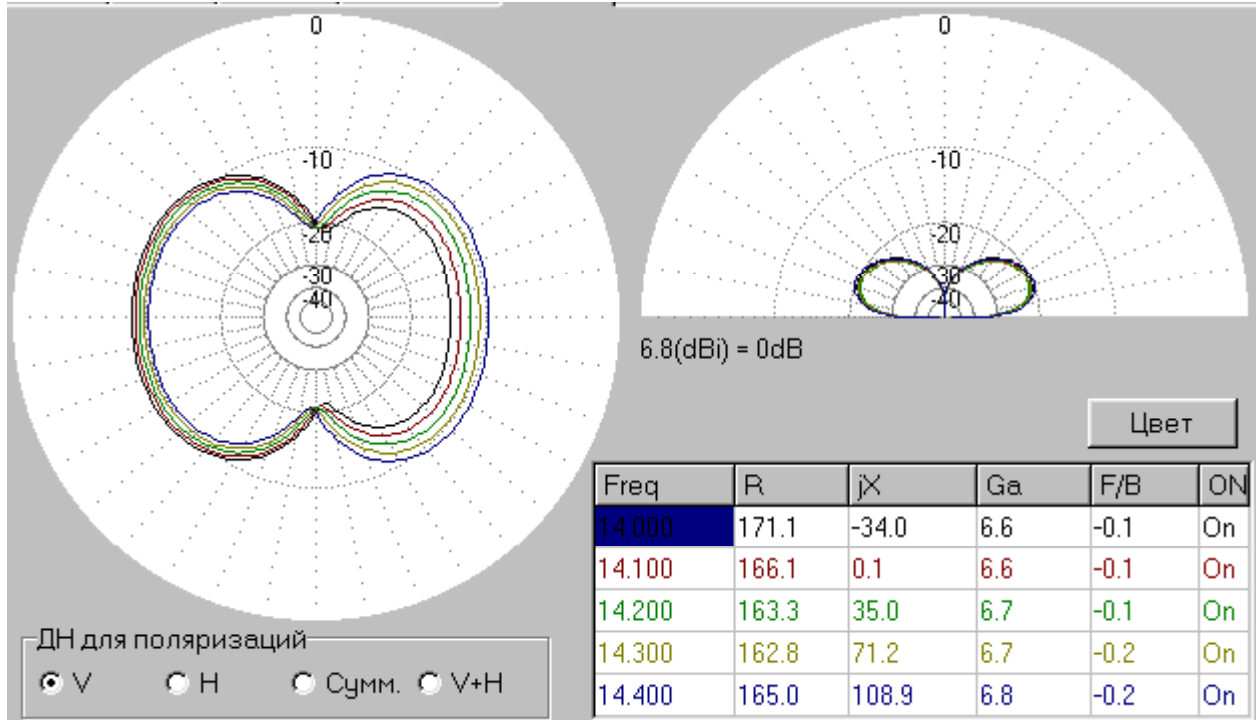

Horizon Radiation Pattern

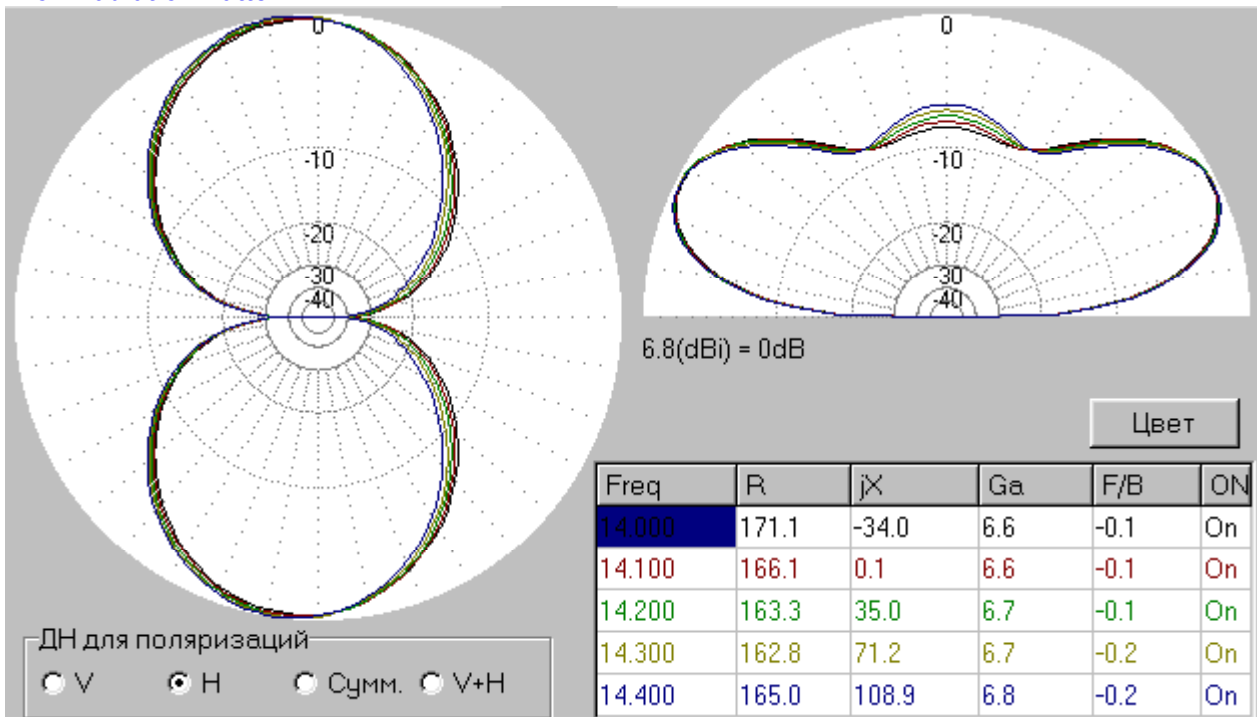

Comments: Antenna has strong horizon radiation. A good pattern in the vertical plane. Antenna has a strong radiation at low corners that allows to do DX QSOs. Antenna has almost “eight-figure” pattern in horizontal plane, so, it demands to choose a proper direction before an installation of the antenna. Antenna provides DX QSOs. Antenna has the resonance at 14100-kHz at 166 Ohms. Any ATU does good matching for the antenna.



Antenna RV3DA at 17-m

Vertical Radiation Pattern

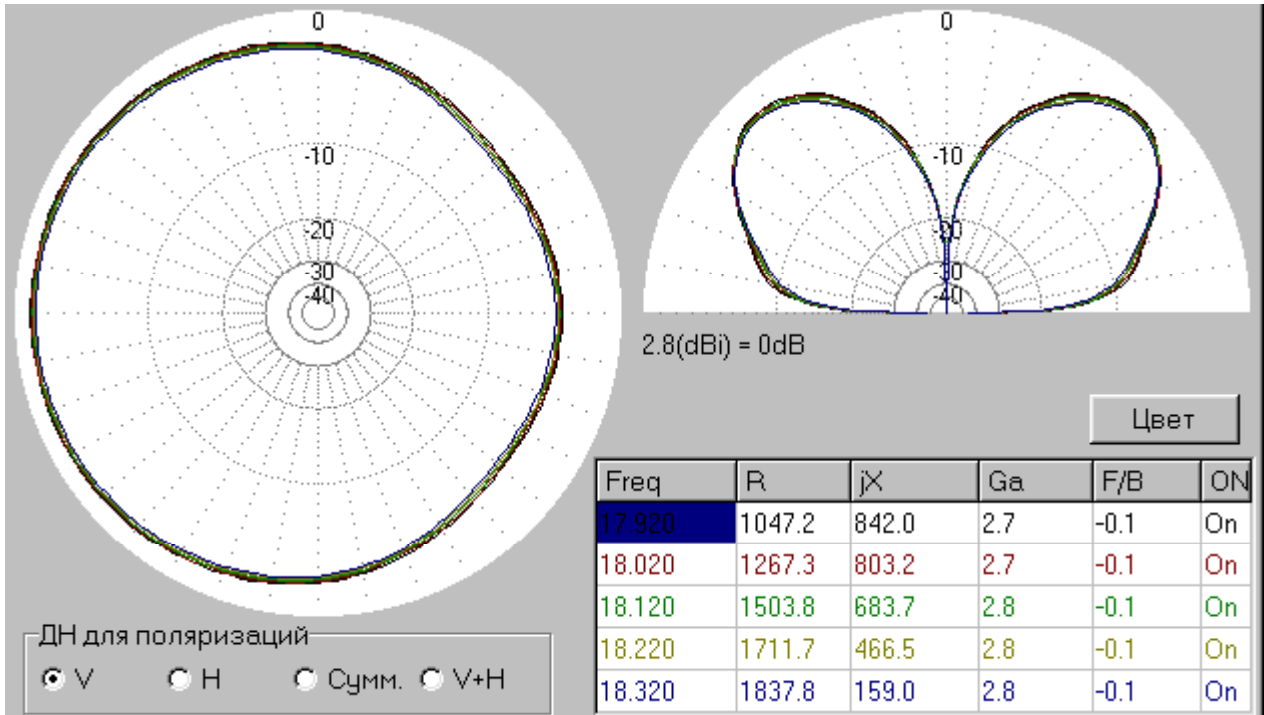

Horizon Radiation Pattern

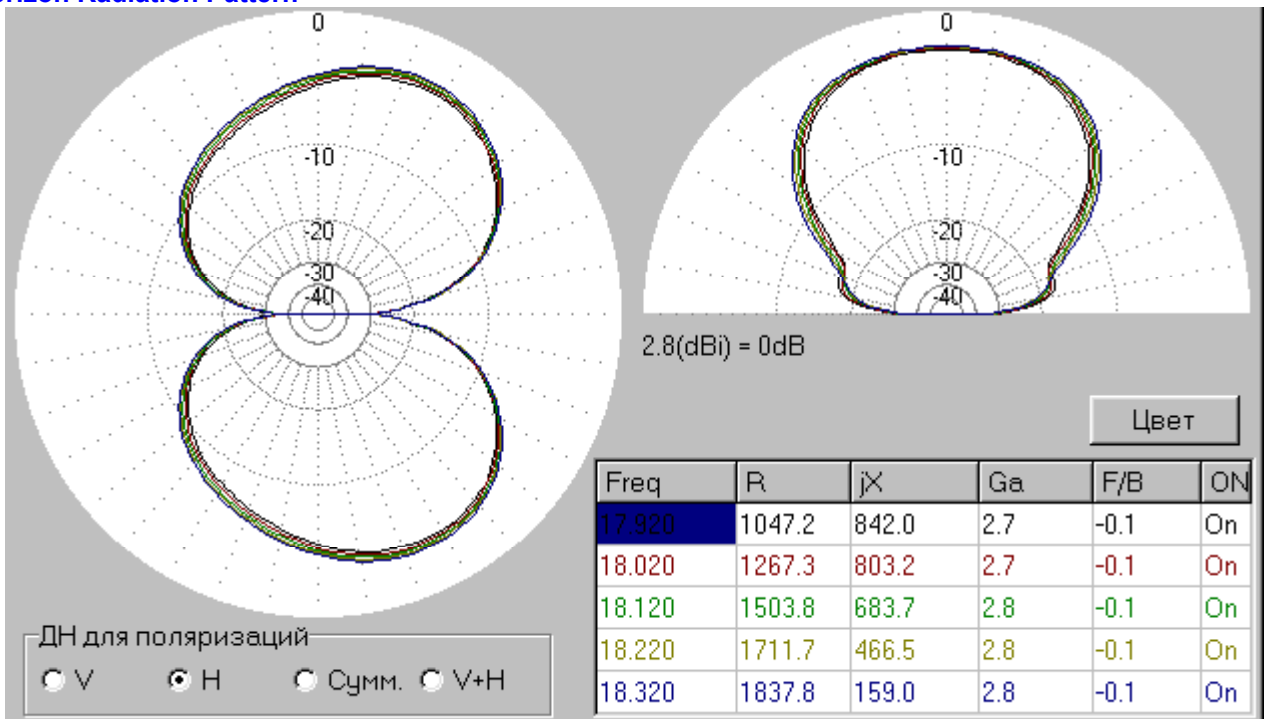

Comments: Antenna has both, a strong vertical and strong horizon radiation. For the vertical radiation antenna has a good pattern in the vertical plane, and almost circular pattern in the horizon plane. Pattern for horizon radiation is not so good as to vertical polarization. Antenna can provide DX QSOs at vertical and horizon radiation. Antenna has impedance 1711+j466-Ohms at 18220-kHz. Not all ATUs do good matching for such load.



Antenna RV3DA at 15-m

Vertical Radiation Pattern

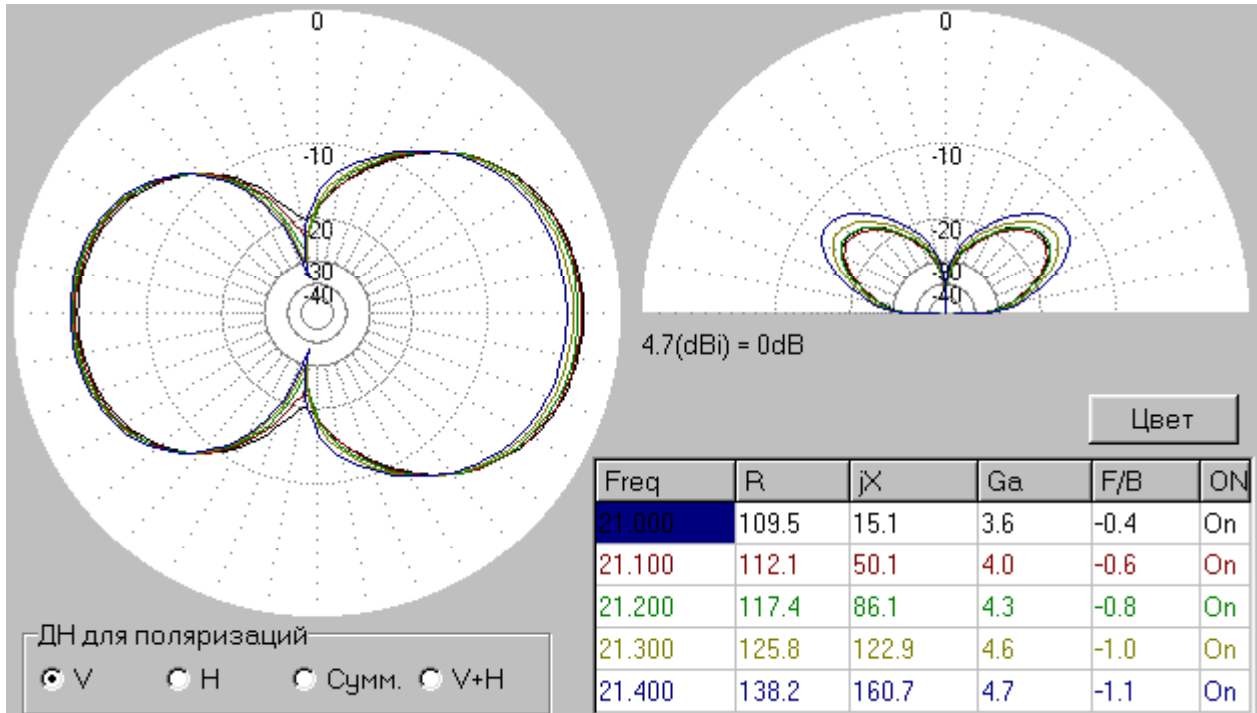

Horizon Radiation Pattern

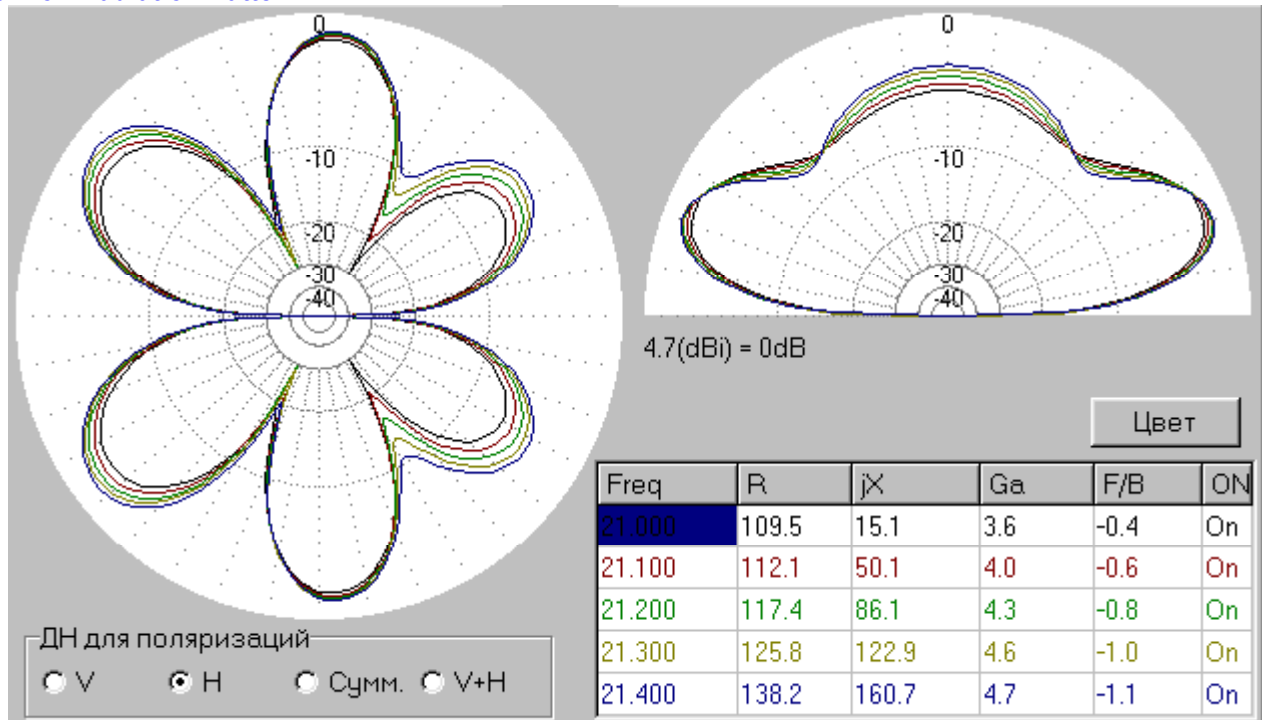

Comments: Antenna has both, a strong vertical and strong horizon radiation. For the horizon radiation antenna has a good pattern in the vertical plane with low lobes, and six-lobes pattern in the horizon plane. Pattern for the horizon radiation is not so good as to vertical polarization. Antenna can provide DX QSOs at vertical radiation. Antenna has impedance 117+j86-Ohms at 21200-kHz. Any ATU makes good matching for such load.



Antenna RV3DA at 12-m

Vertical Radiation Pattern

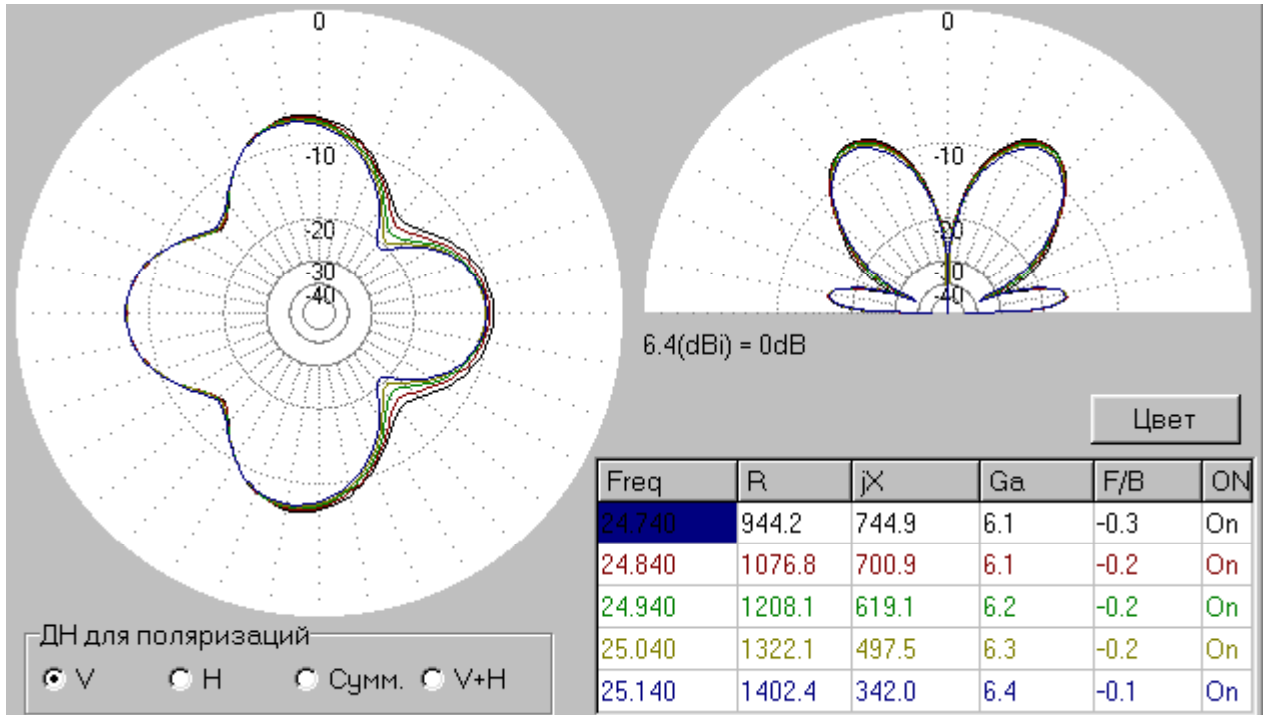

Horizon Radiation Pattern

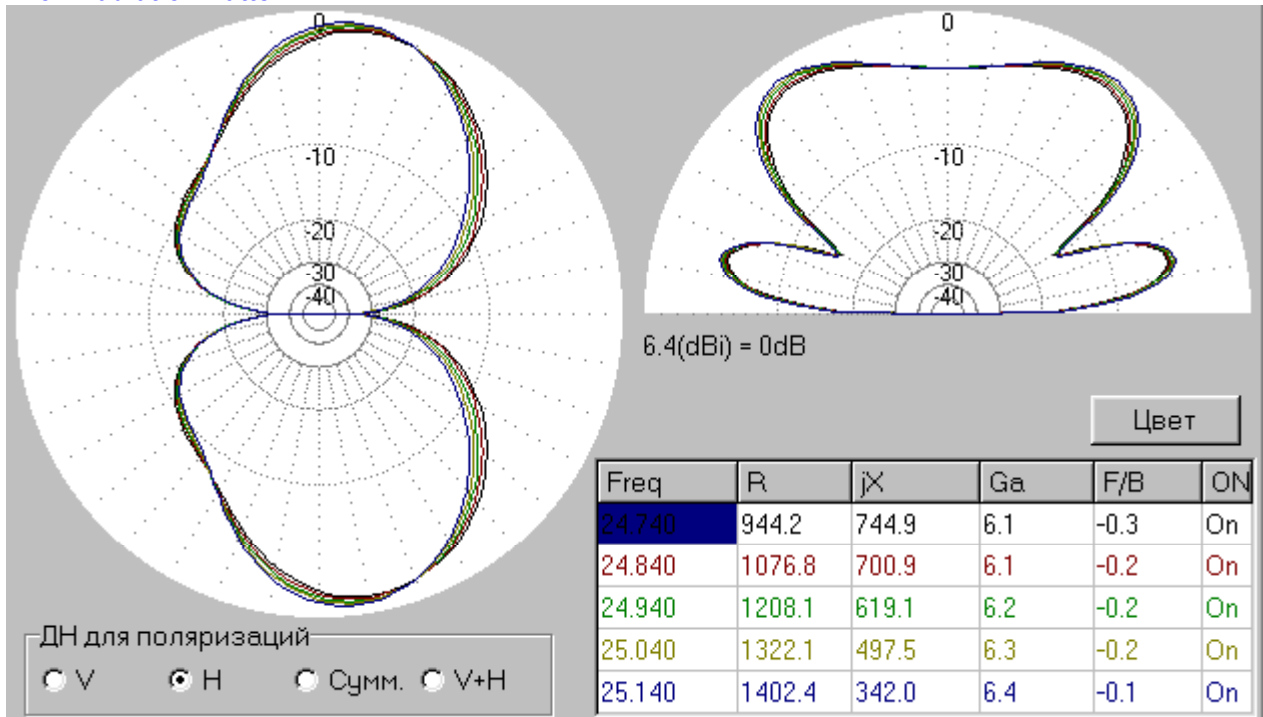

Comments: Antenna has strong horizon radiation. For the horizon radiation antenna has a not bad pattern in the vertical plane, and “eight- figure” pattern in the horizon plane. Antenna can provide DX QSOs at horizon radiation. Antenna has impedance 1208+j619-Ohms at 21200-kHz. Not all ATUs do good matching for such load.



Antenna RV3DA at 10-m

Vertical Radiation Pattern

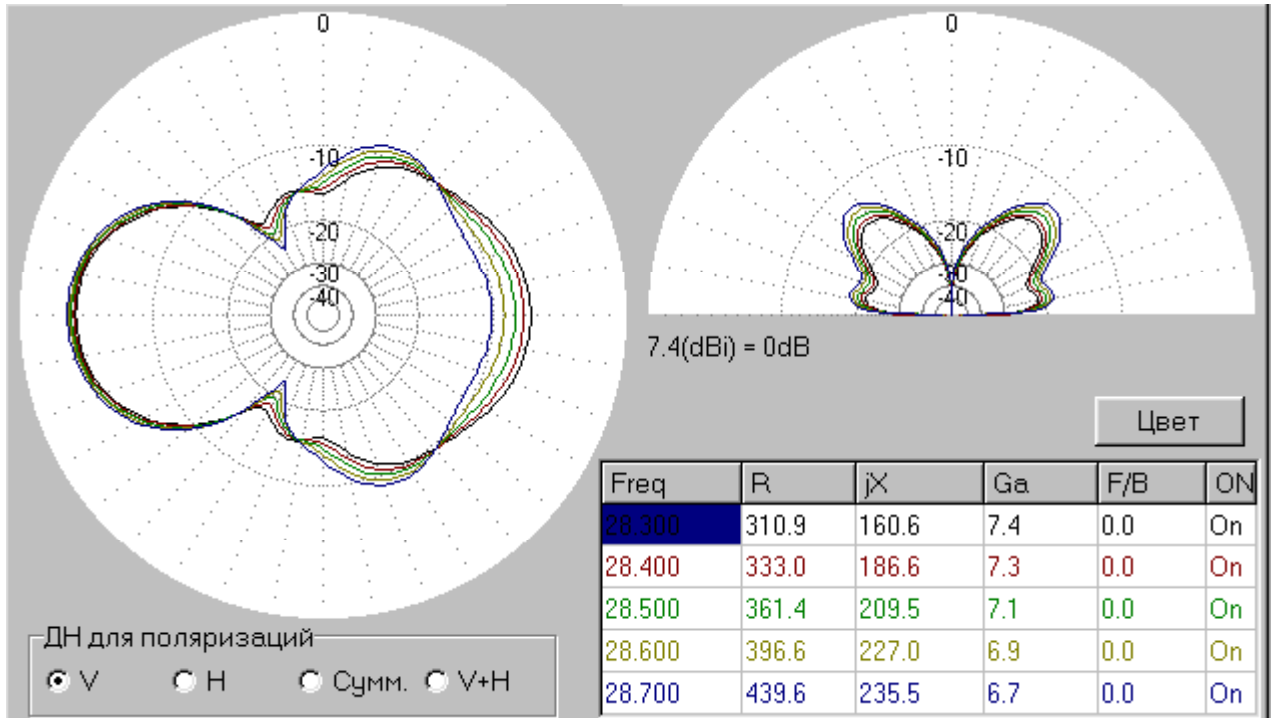

Horizon Radiation Pattern

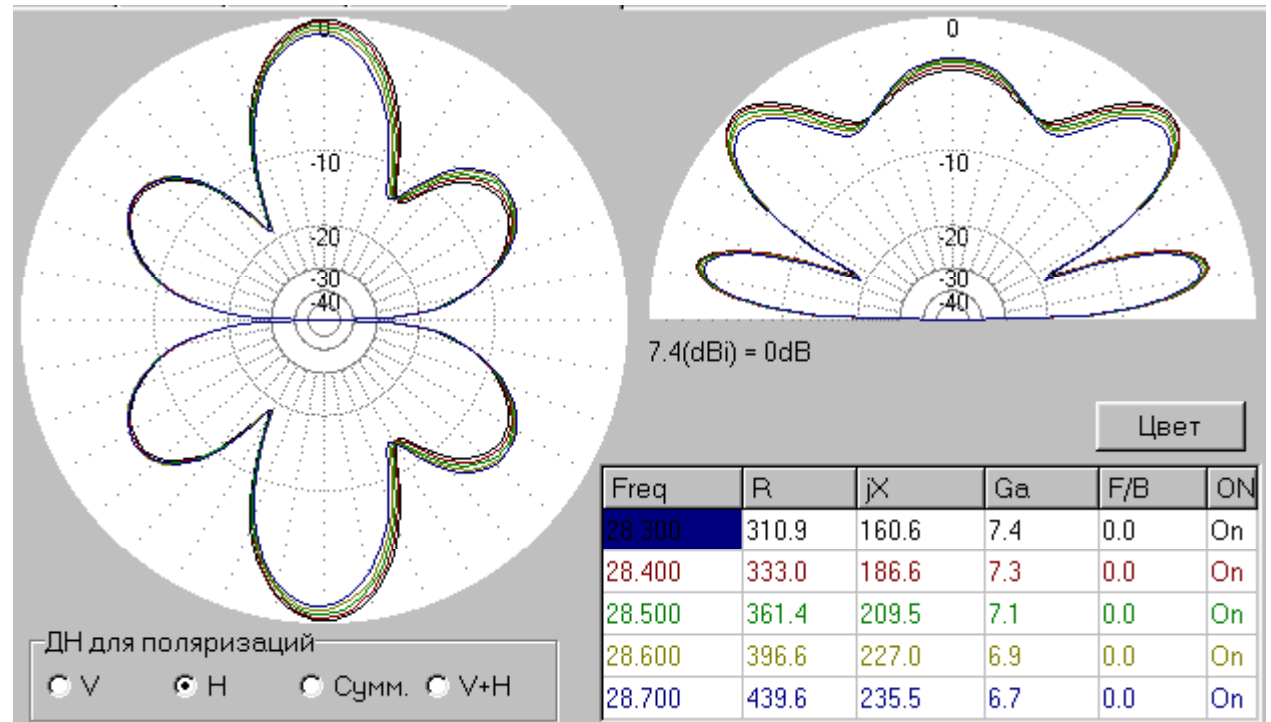

Comments: Antenna has strong horizon radiation. For the horizon radiation antenna has a not bad pattern in the vertical plane, and “eight-figure” pattern dropped to lobes in the horizon plane. Antenna can provide DX QSOs at the horizon radiation. Antenna has impedance 396+j227-Ohms at 28600-kHz. Not all ATUs do good matching for such load.



Antenna RV3DA at 6-m

Vertical Radiation Pattern

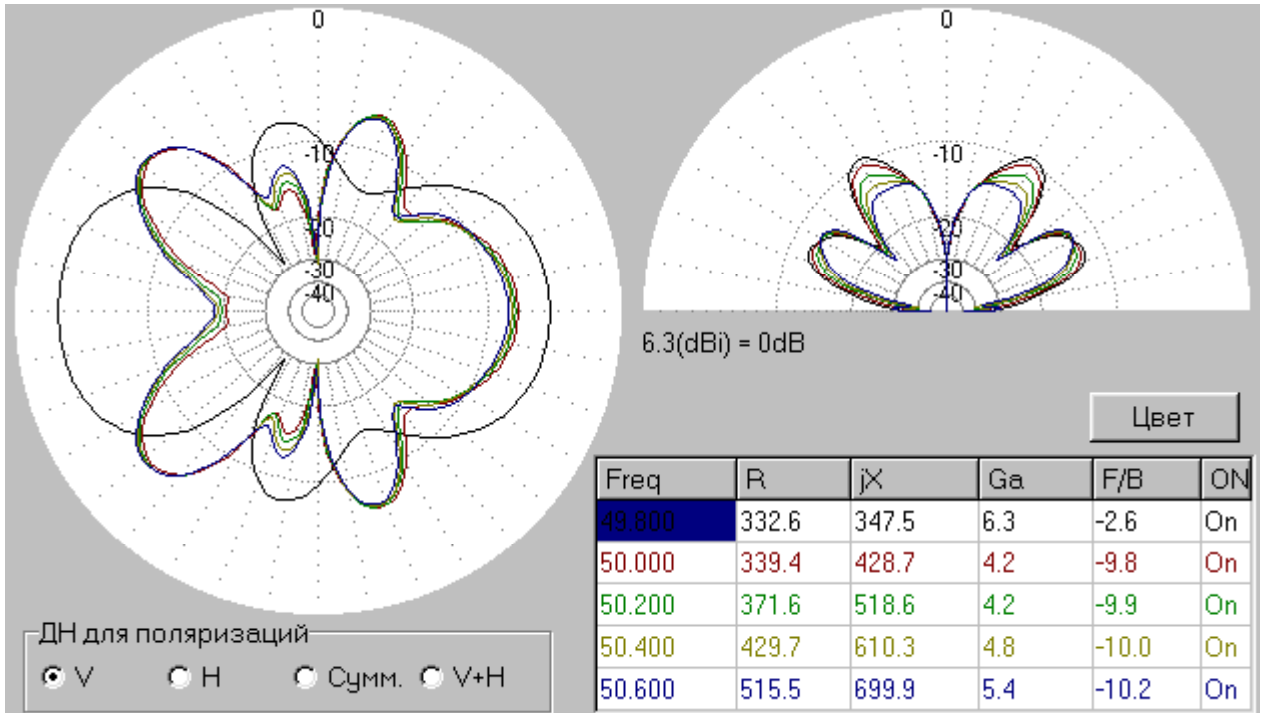

Horizon Radiation Pattern

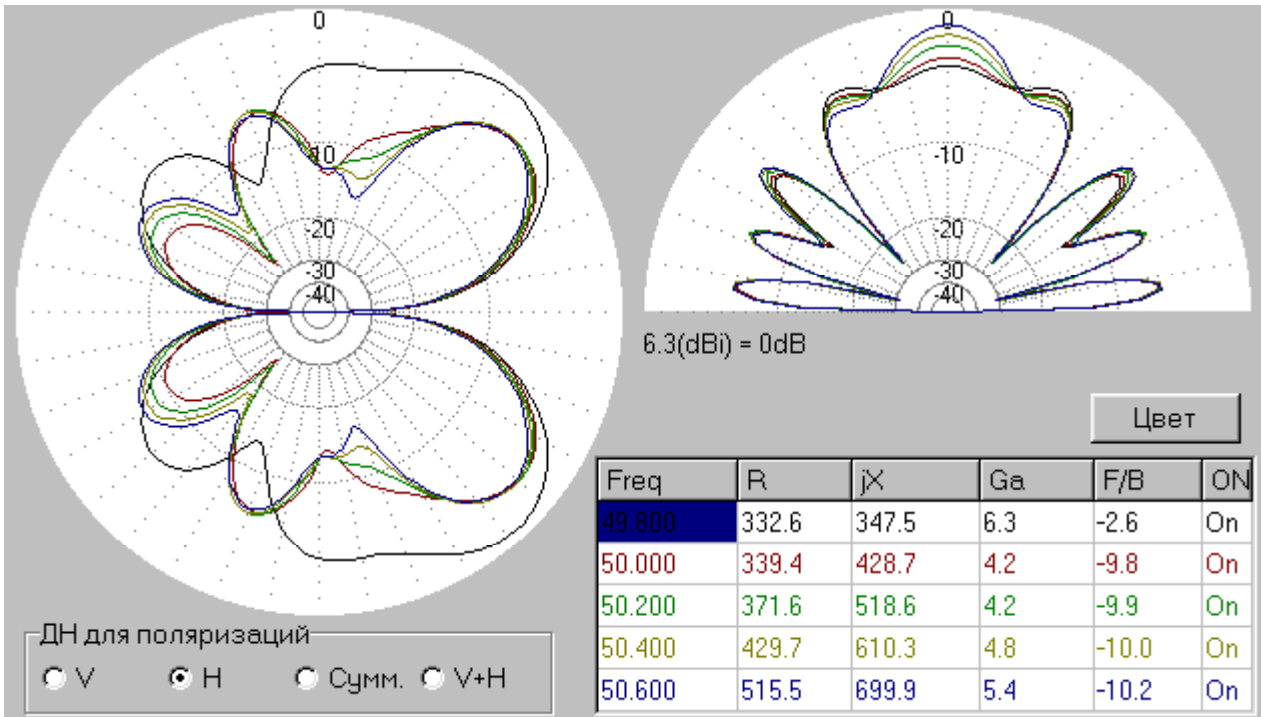

Comments: Antenna has horizon and vertical radiation. For the horizon radiation antenna has a not bad pattern in the vertical plane, and “eight-figure” pattern dropped to lobes in the horizon plane. Antenna can provide DX QSOs at horizon radiation. Antenna has impedance 429+j599-Ohms at 50600-kHz. Not all ATUs do good matching for such load.



SHUNT VERTICAL UNIVERSAL HF ANTENNA

Field universal antenna RV3DA (see pp.:24- 35 of [ANTENTOP- 02- 2004](#)) works well even at a bad grounding. To hammer into the ground a metal rod in 1 meter length is enough for the grounding. Installation of the antenna takes a little time, it is another its advantage. However, if there is an opportunity to provide a good ground, and there is some free time to spend of for installation of an antenna, it is possible to use a **Shunt Vertical Universal HF Antenna**.

Figure 1 shows the schematic of the Shunt Vertical Universal HF Antenna. A detailed description of the theory of a Shunt Vertical Universal is given at reference [1].

Apparently, the circuit of the antenna only a bit differs from field universal antenna RV3DA. The differences are: the loop is isolated from the ground, its terminals are shortened, shunts go down from two tops of the triangle loop to the ground. To ground shunts is possible as to universal antenna RV3DA it is done, i.e., a metal rod in 1 meter length is enough for the grounding. Of course, several counterpoises (three and more) in length of 5 meters (and more) help to improve the antenna operation. Counterpoises can lay on a surface of the ground.

Shunt Vertical Universal HF Antenna radiates mainly vertical radiation. It is required to use the antenna at woodless surrounding or big losses of high-frequency energy will be. Please, take attention Shunt Vertical

Igor Grigorov, Rk3ZK

antentop@mail.ru

Universal HF Antenna has a gain less than universal antenna RV3DA. It is possible to do a design of the Shunt Vertical Universal HF Antenna so, that this one can be easy turned to the field universal antenna RV3DA.

Below given diagram directivity for the antenna obtained with help of free antenna program MMANA (MININEC based). Left diagram is a section of the volumetric diagram directivity of plane X-Y at a zenith corner of the maximum radiation. The right diagram is section of the volumetric diagram directivity of plane X-Z. Also at the right down corner of the pictures is a table with antenna impedance. Please, take attention to the data, you can do decision how you ATU does match of the

Reference:

1. Aizenberg G. Z. Antennas of Short Waves.: Moscow, 'Svyaz", 1985.

73!
Igor Grigorov, RK3ZK

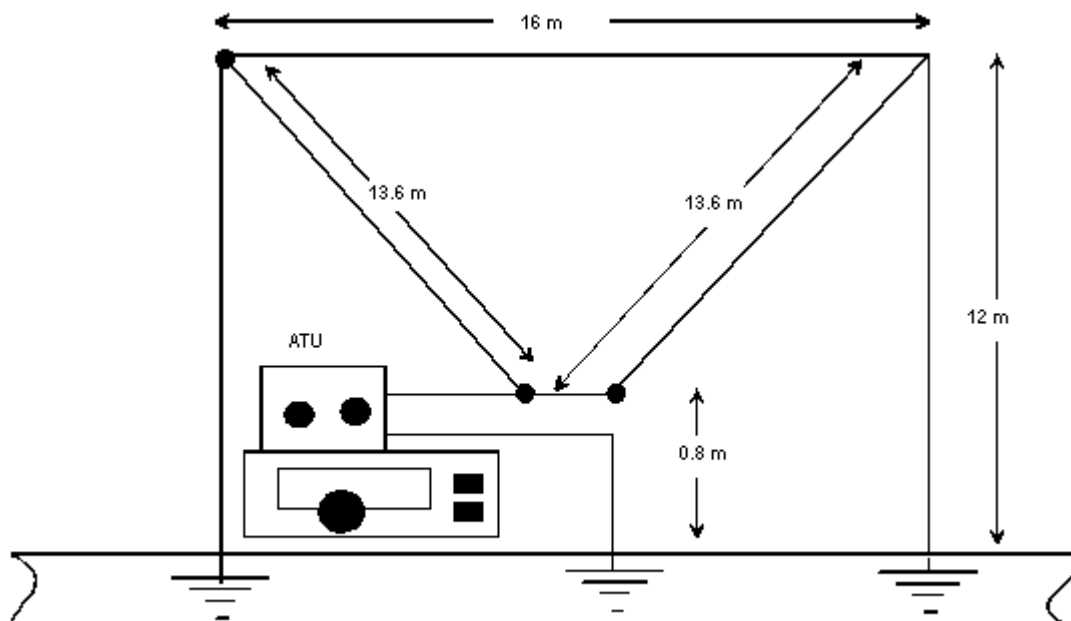
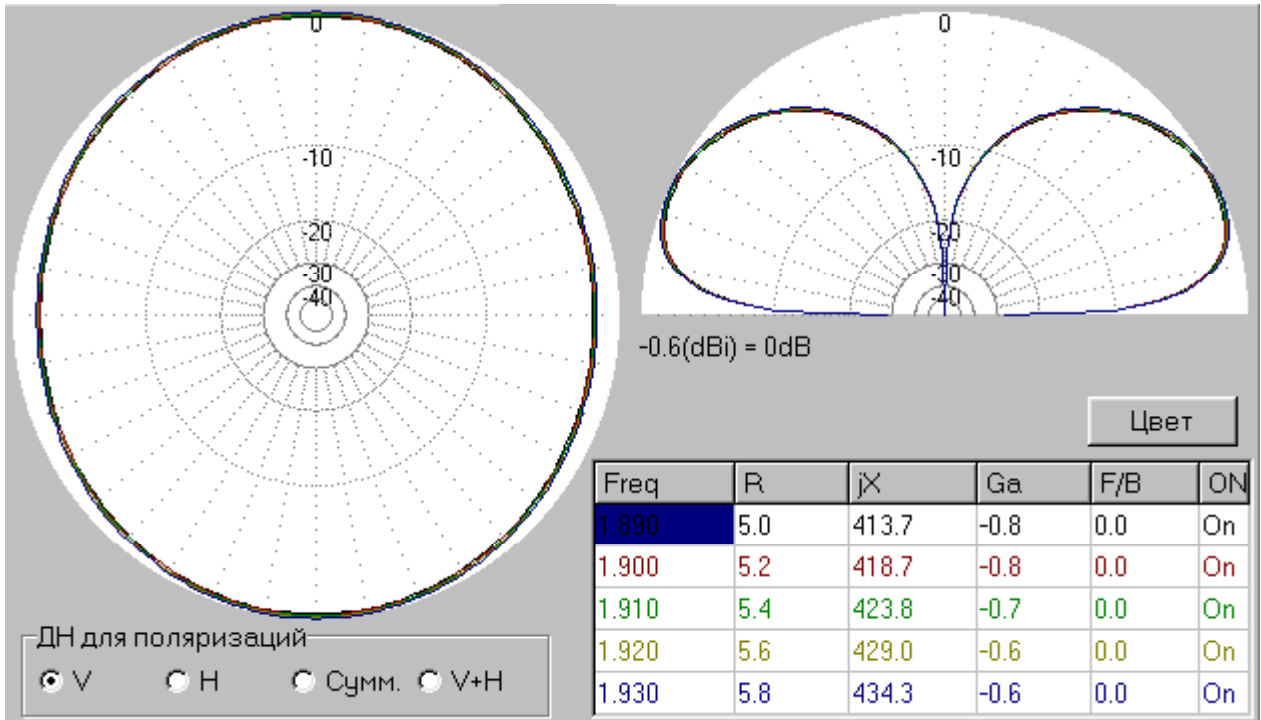

Figure 1

Shunt Vertical Universal HF Antenna at 160-m

Vertical Radiation Pattern



Horizon Radiation Pattern

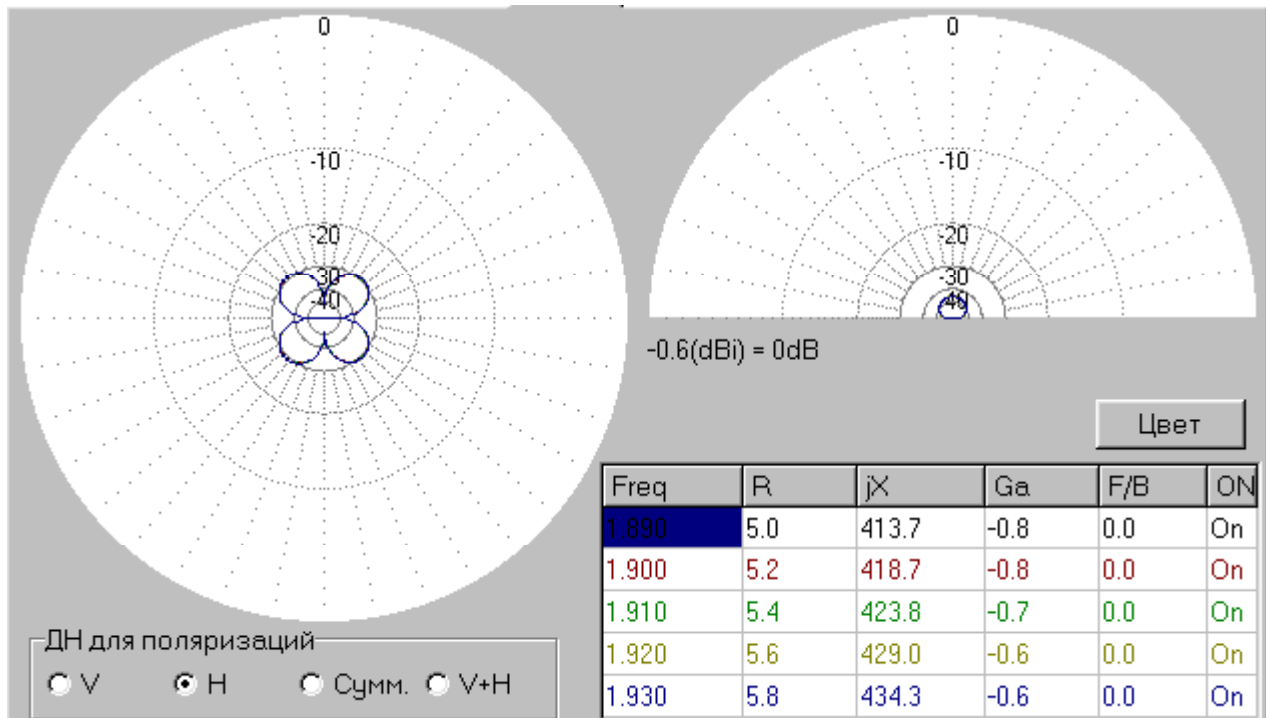

Comments: Antenna radiates radio waves with vertical polarization. A very good pattern with low lobes in the vertical plane. Circular pattern in horizontal plane. It is fine for DX- QSO. But antenna has $Z = 5.4 + j423\text{-Ohms}$ at 1910-kHz. Not all ATUs do good matching for such load.



Shunt Vertical Universal HF Antenna at 80-m

Vertical Radiation Pattern

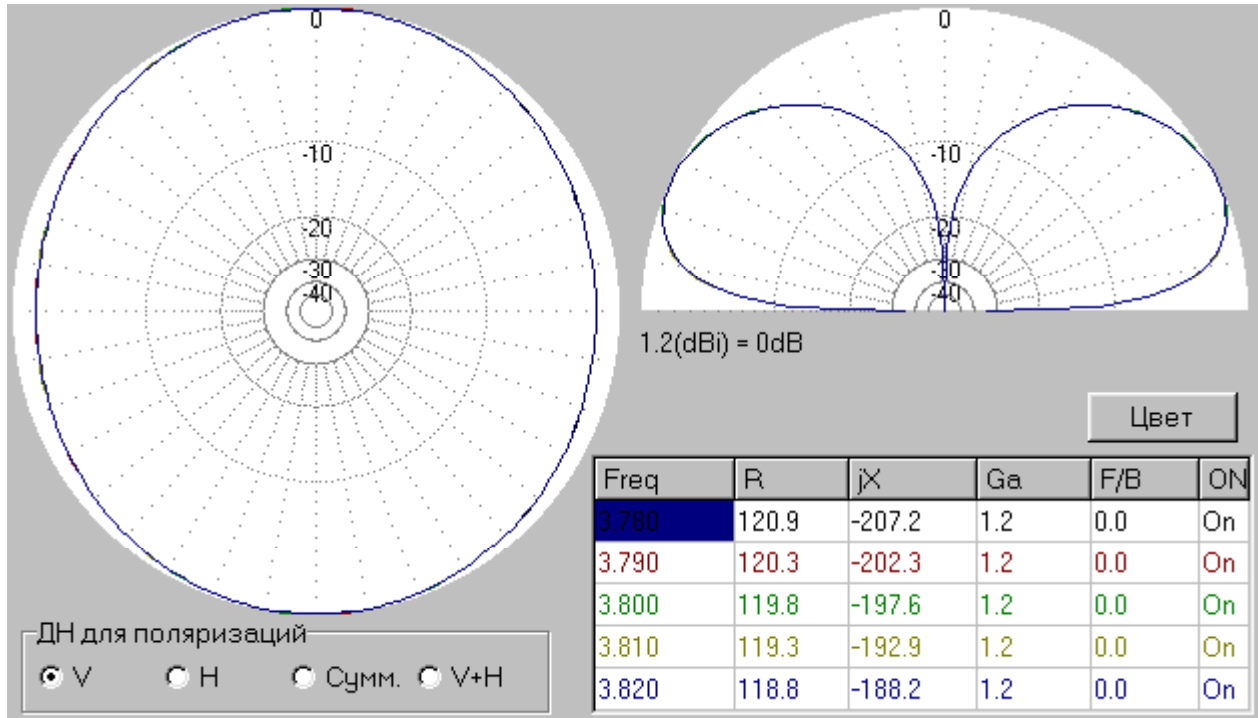

Horizon Radiation Pattern

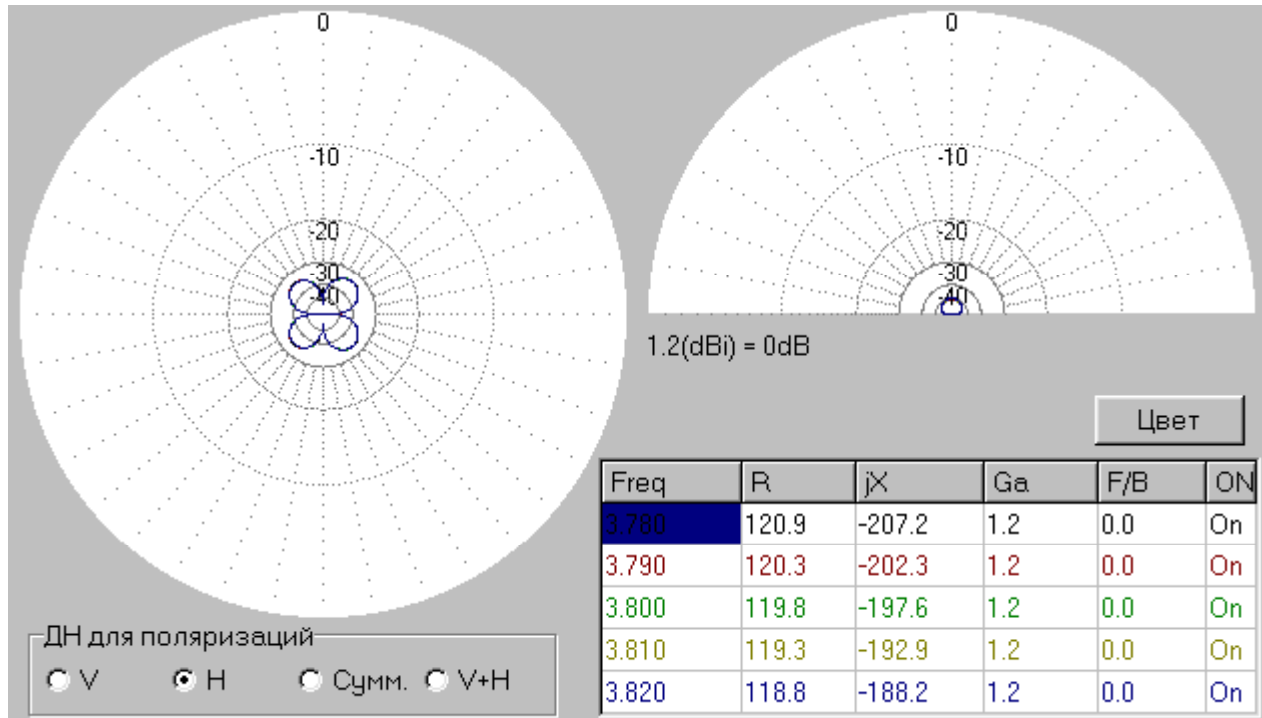

Comments: Antenna radiates radio waves with vertical polarization. A very good pattern with low lobes in the vertical plane. Circular pattern in horizontal plane. It is fine for DX- QSO. Antenna has $Z = 119 - j197$ -Ohms at 3800-kHz. Almost any ATU does good matching for such load.



Shunt Vertical Universal HF Antenna at 40-m

Vertical Radiation Pattern

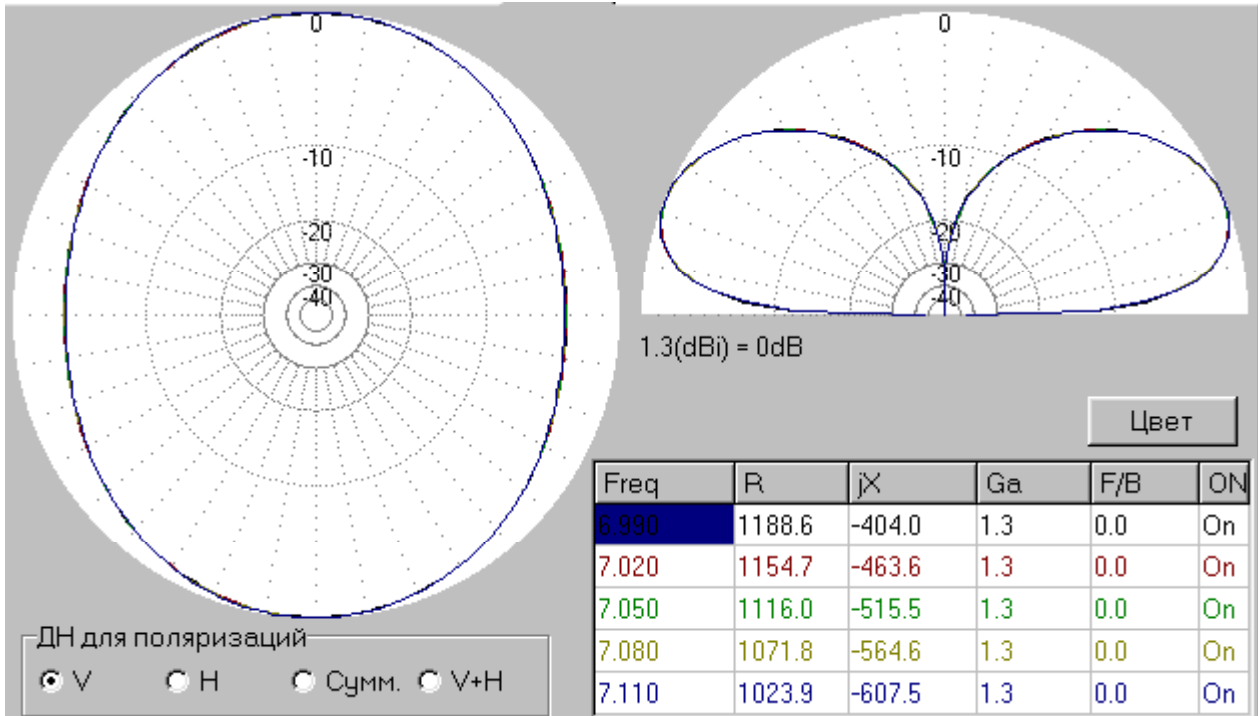

Horizon Radiation Pattern

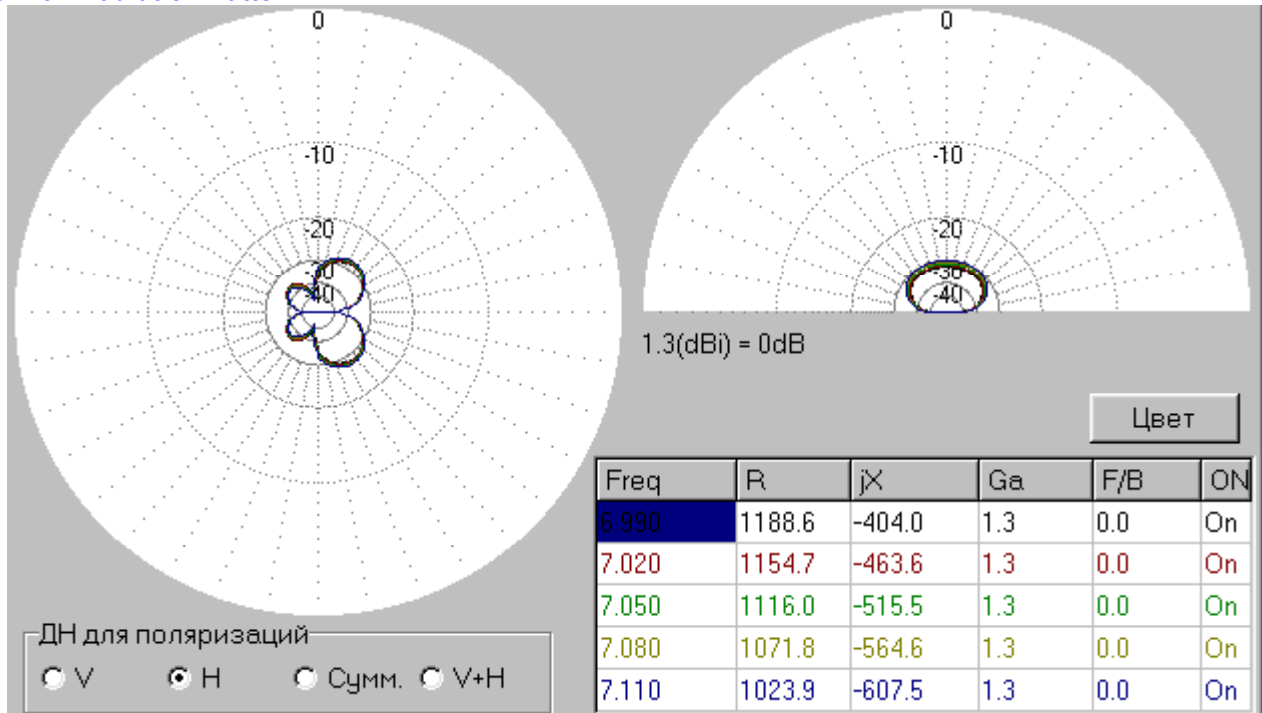

Comments: Antenna radiates radio waves with vertical polarization. A very good pattern with low lobes in the vertical plane. Almost a circular pattern in horizontal plane. It is fine for DX- QSO. Antenna has $Z=1116- j515$ -Ohms at 7050-kHz. Not all ATUs do good matching for such load.



Shunt Vertical Universal HF Antenna at 30-m

Vertical Radiation Pattern

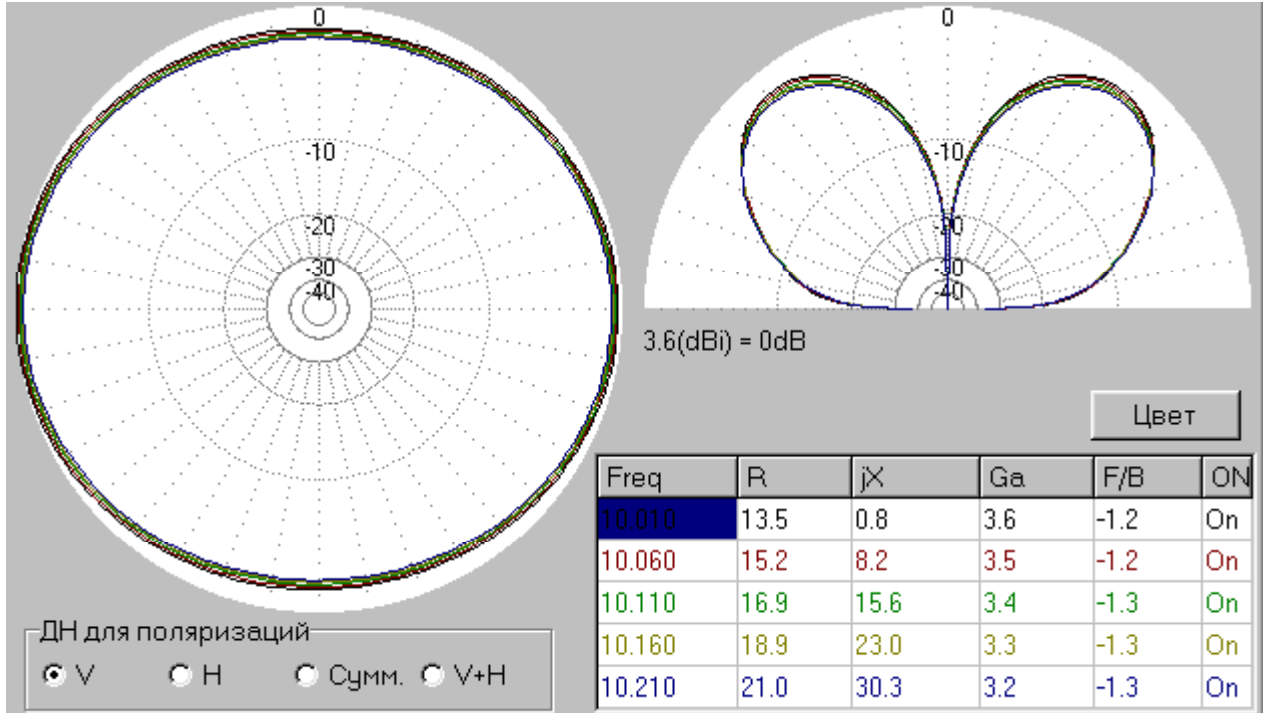

Horizon Radiation Pattern

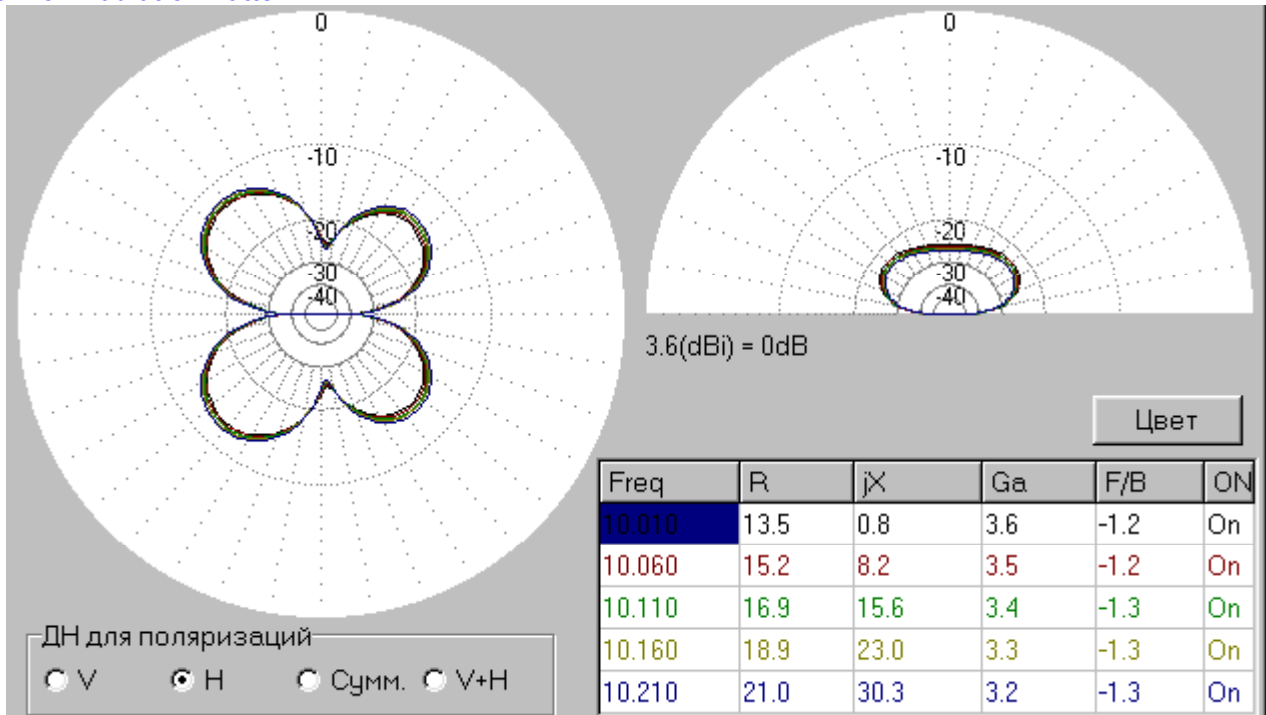

Comments: Antenna has strong vertical radiation. A good pattern in the vertical plane. Antenna has strong radiation at high corners that allows to do local QSOs. Antenna has almost circular pattern in horizontal plane. Antenna provides DX and local QSOs. Antenna has $Z = 16.9 + j15.6$ -Ohms at 10110-kHz. Any ATU does good matching for such load.



Shunt Vertical Universal HF Antenna at 20-m

Vertical Radiation Pattern

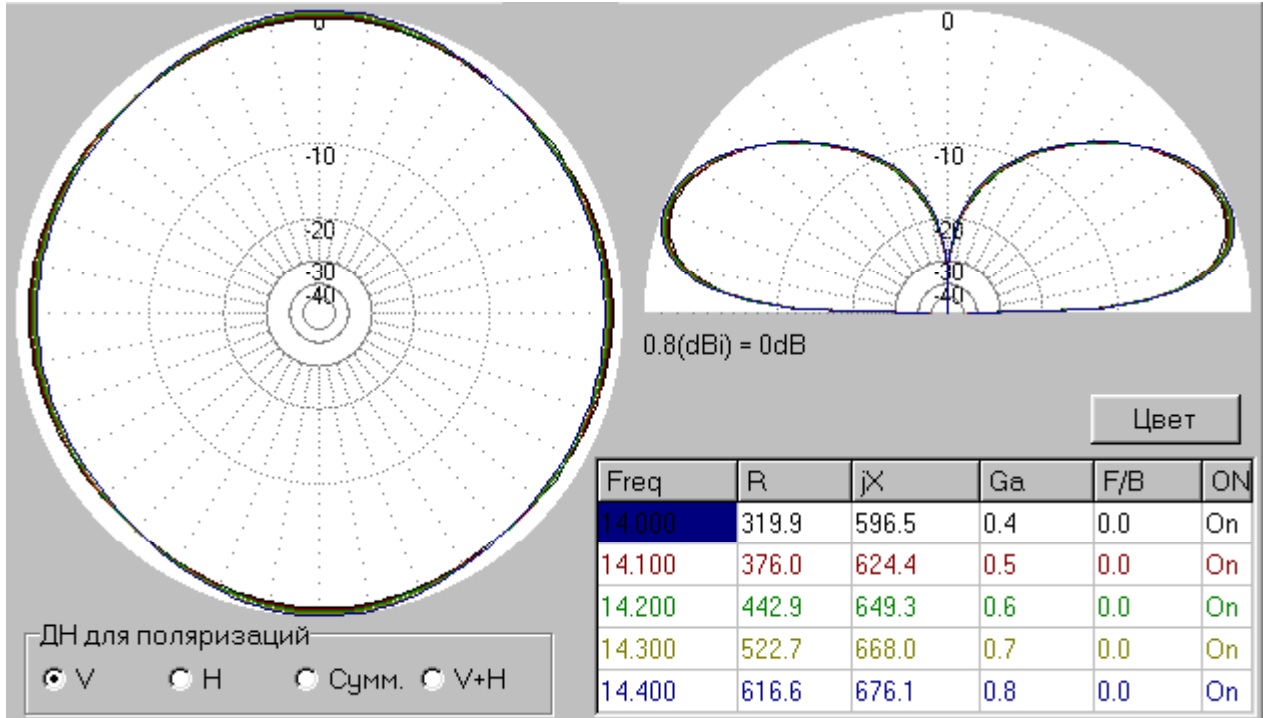

Horizon Radiation Pattern

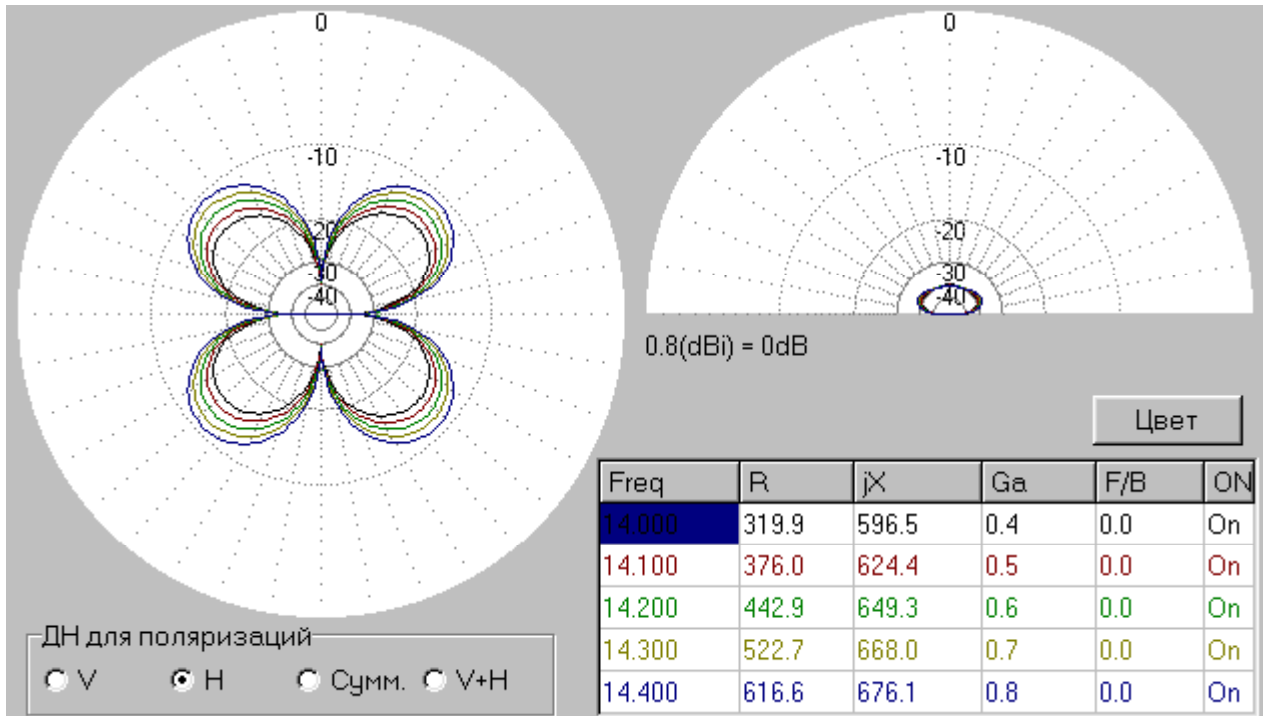

Comments: Antenna has strong vertical radiation. A very good pattern in the vertical plane. Antenna has almost circular pattern in horizontal plane. Antenna provides DX QSOs. Antenna has $Z = 442 + j649$ -Ohms at 14200-kHz. Not all ATUs do good matching for such load.



Shunt Vertical Universal HF Antenna at 17-m

Vertical Radiation Pattern

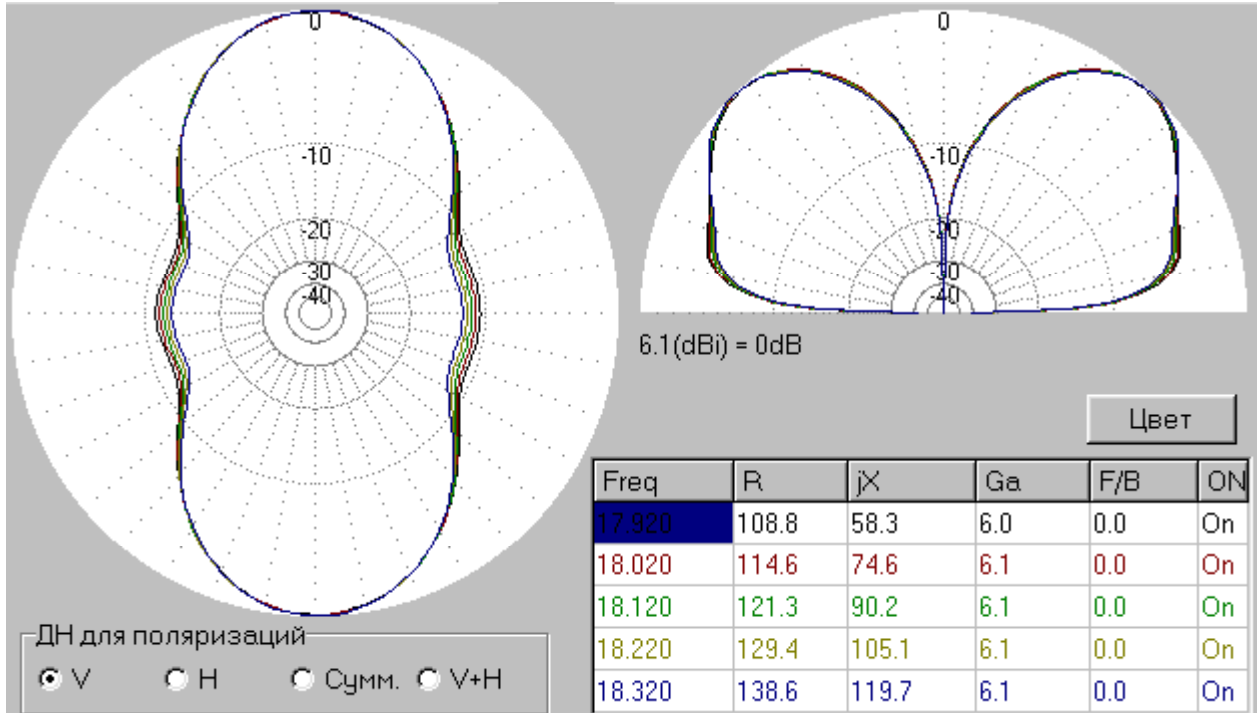

Horizon Radiation Pattern

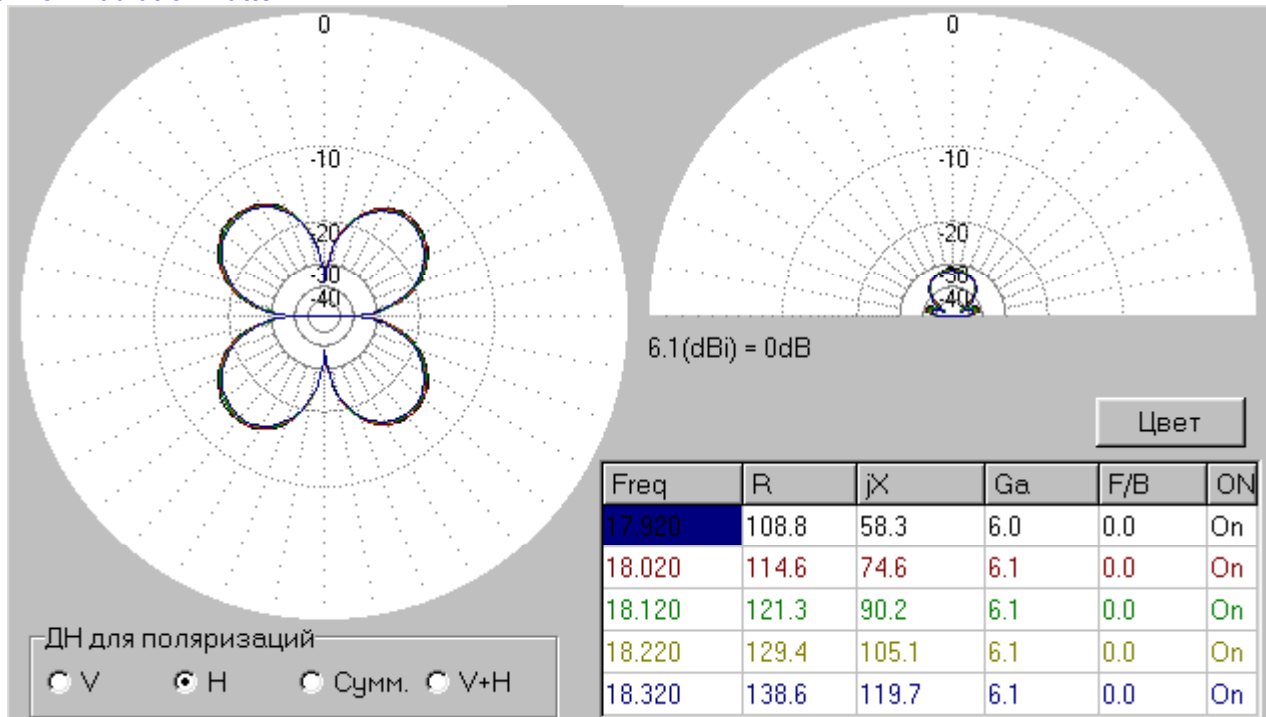

Comments: Antenna has strong vertical radiation. A good pattern in the vertical plane. Antenna has egg shape pattern in horizontal plane, so, it demands to choose a proper direction before an installation of the antenna. Antenna provides DX QSOs. Antenna has $Z = 121 + j90$ -Ohms at 18120-kHz. Any ATU does good matching for such load.



Shunt Vertical Universal HF Antenna at 15-m

Vertical Radiation Pattern

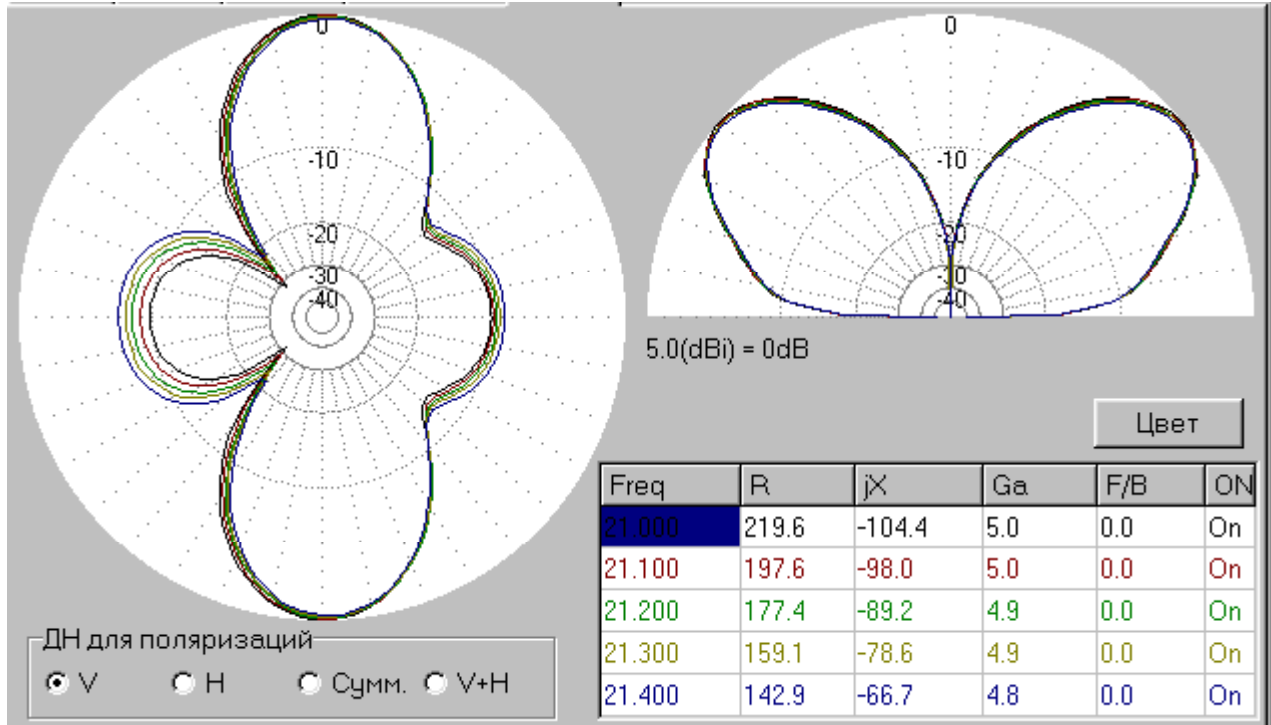

Horizon Radiation Pattern

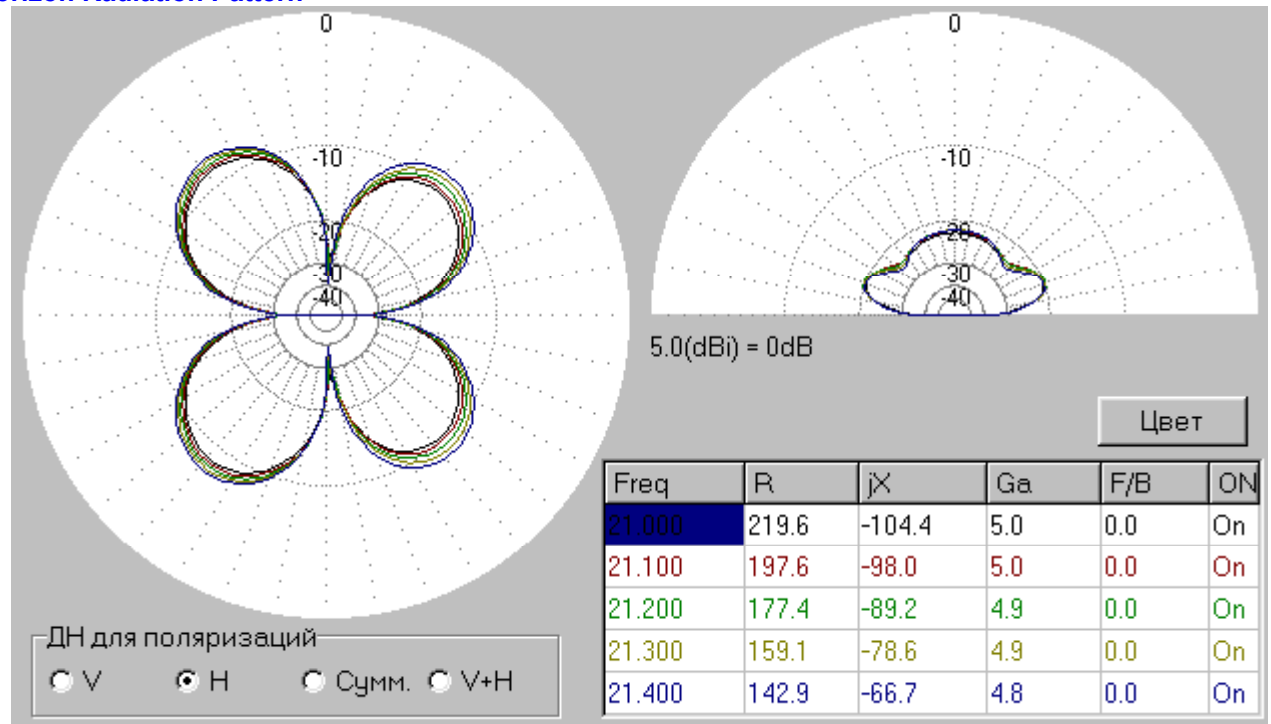

Comments: Antenna has strong vertical radiation. A good pattern in the vertical plane. Antenna has almost egg shape pattern dropped to four lobes in horizontal plane, so, it demands to choose a proper direction before an installation of the antenna. Antenna provides DX QSOs. Antenna has $Z = 177 - j89$ -Ohms at 21200-kHz. Any ATU does good matching for such load.



Shunt Vertical Universal HF Antenna at 12-m

Vertical Radiation Pattern

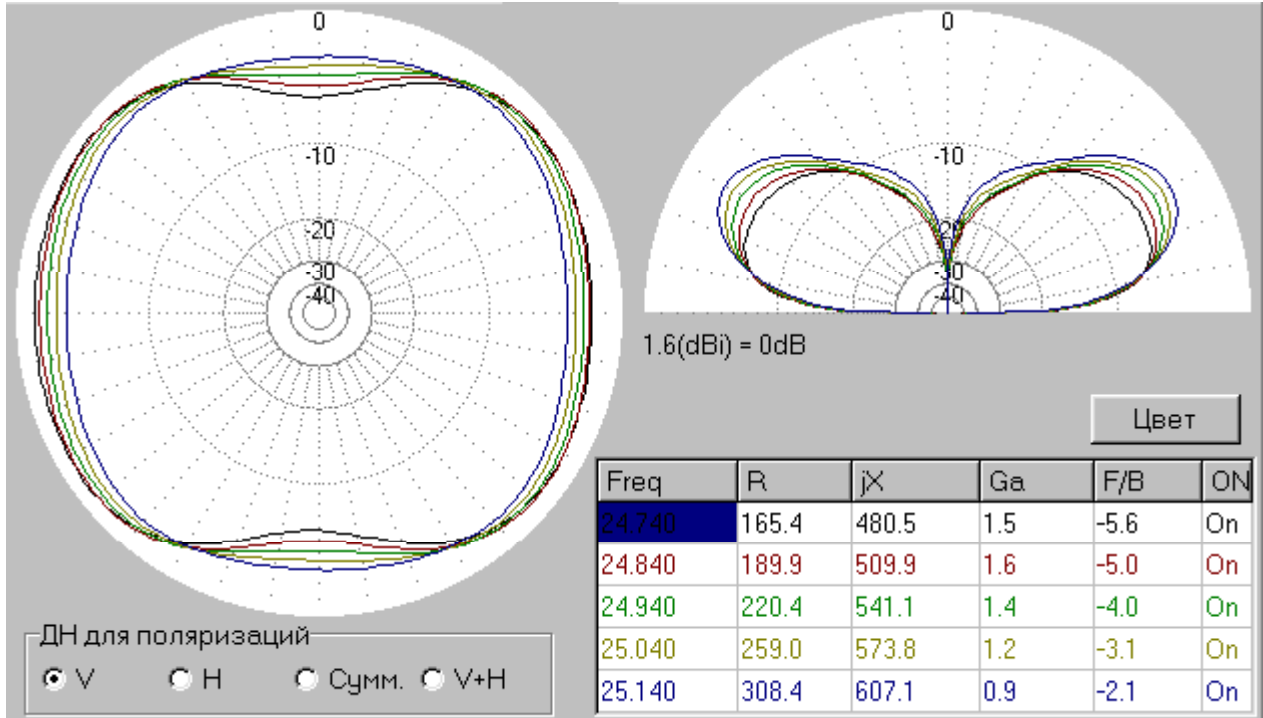

Horizon Radiation Pattern

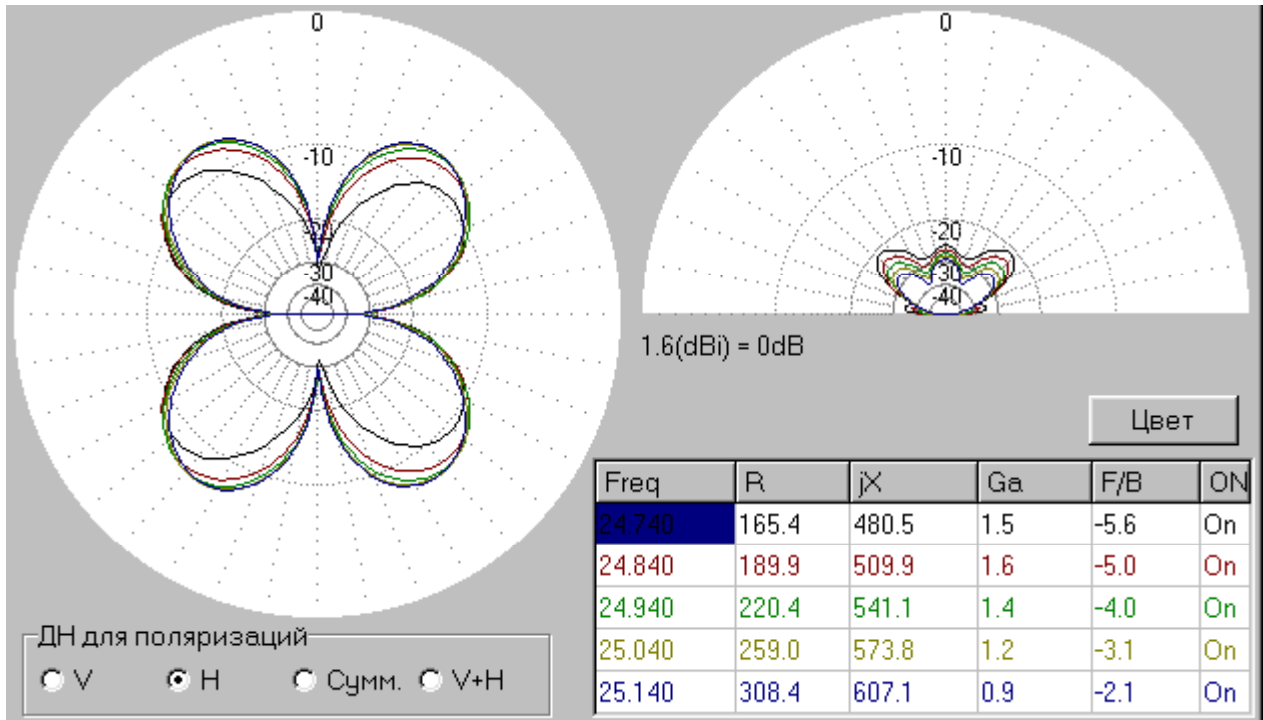

Comments: Antenna has strong vertical radiation. A good pattern in the vertical plane. Antenna has almost circular pattern in horizontal plane. Antenna provides DX QSOs. Antenna has $Z = 259 - j573$ -Ohms at 25040-kHz. Not all ATUs do good matching for such load.



Shunt Vertical Universal HF Antenna at 10-m

Vertical Radiation Pattern

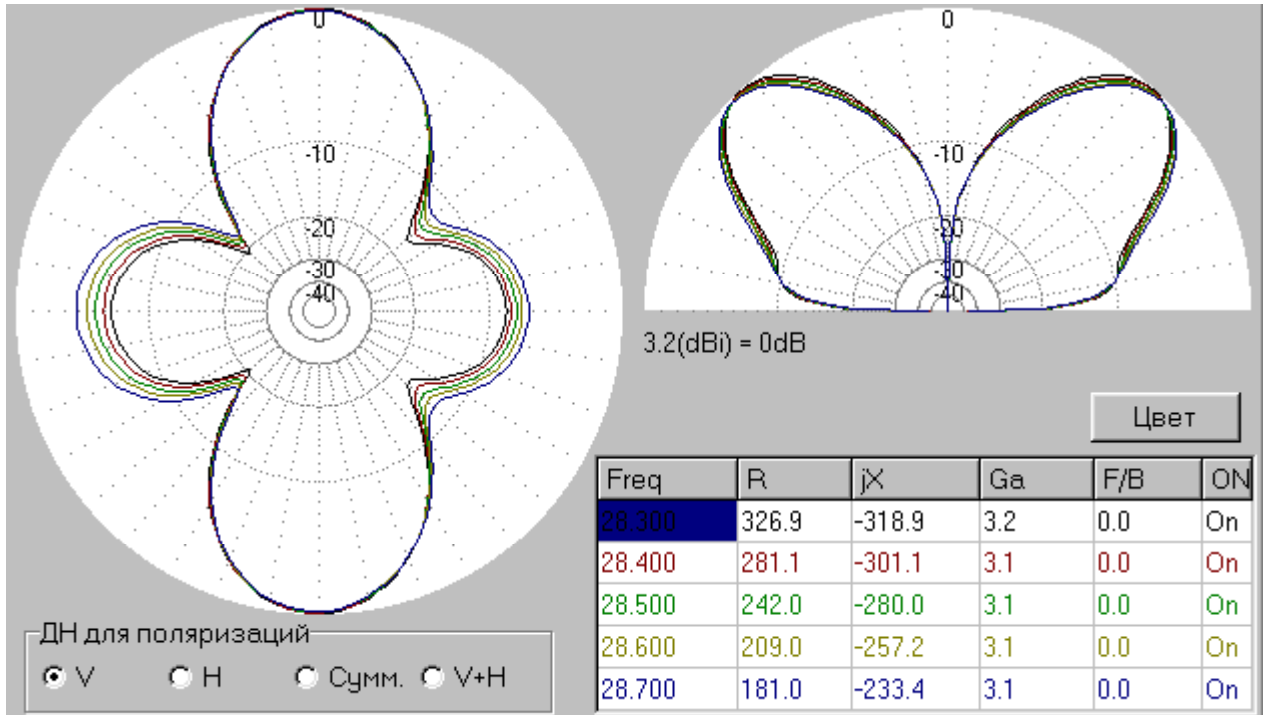

Horizon Radiation Pattern

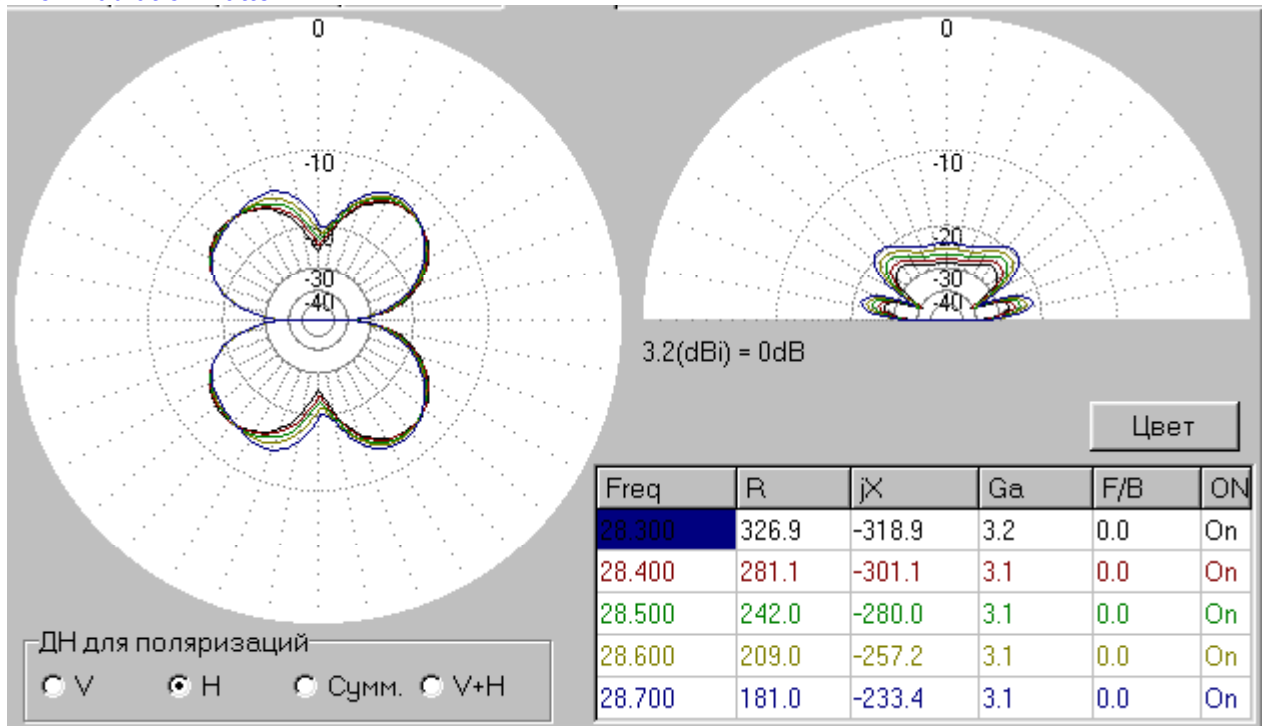

Comments: Antenna has strong vertical radiation. A not bad pattern in the vertical plane. Antenna has a four- shaped lobes pattern in horizontal plane, so, it demands to choose a proper direction before an installation of the antenna.. Antenna can provide DX QSOs. Antenna has $Z = 242 - j280$ -Ohms at 28500-kHz. Any ATU does good matching for such load.



Shunt Vertical Universal HF Antenna at 6-m

Vertical Radiation Pattern

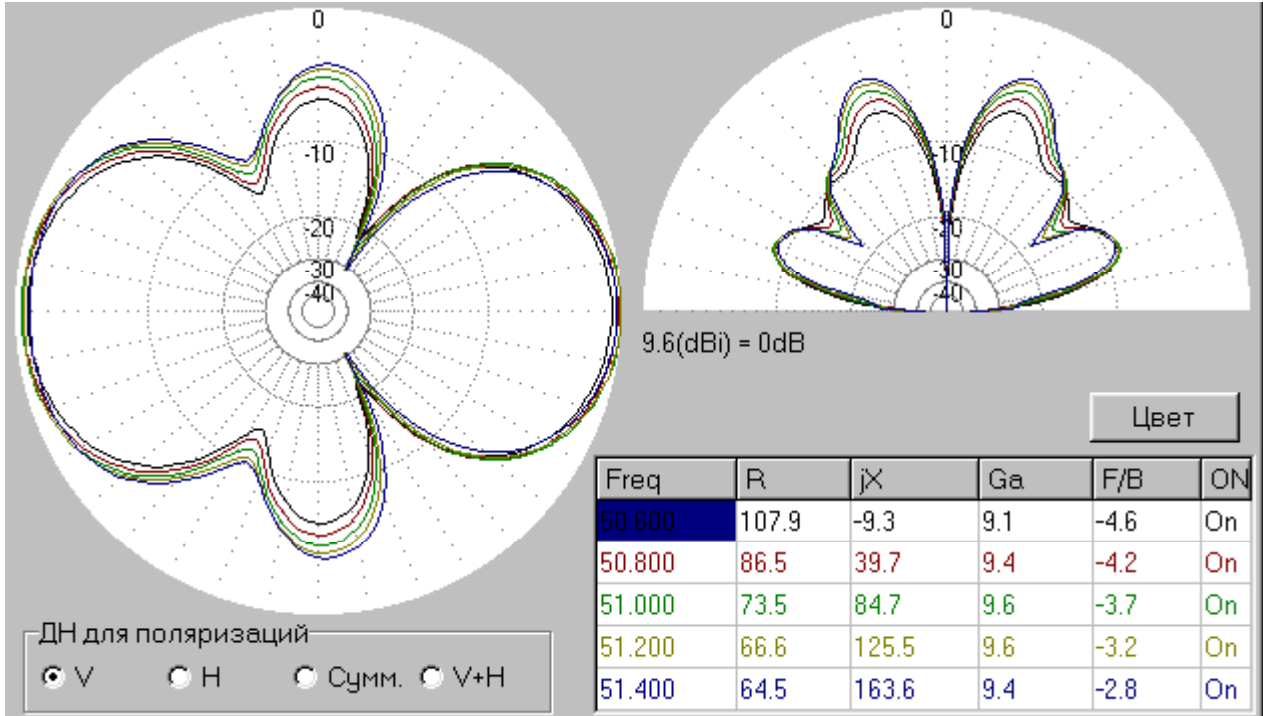

Horizon Radiation Pattern

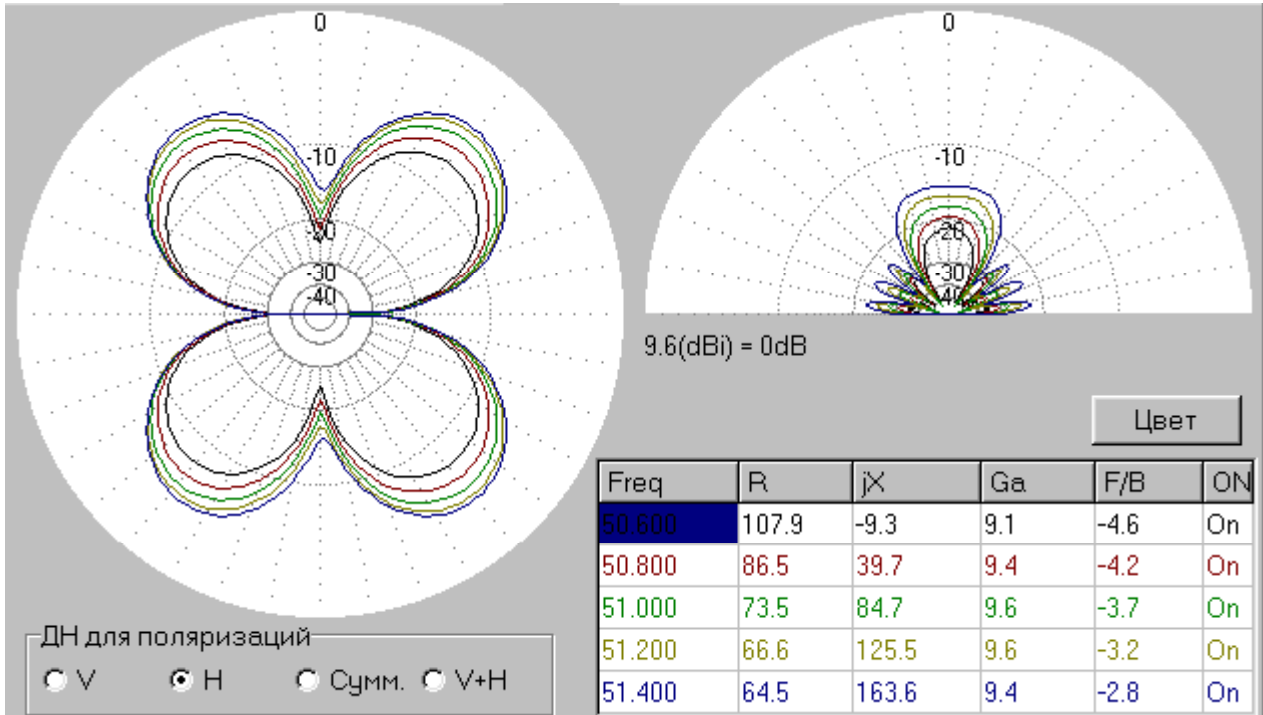

Comments: Antenna has strong vertical radiation. A not bad pattern in the vertical plane. Antenna has an “eight- shape” pattern in horizontal plane, so, it demands to choose a proper direction before an installation of the antenna.. Antenna can provide DX QSOs. Antenna has $Z = 86 + j40$ -Ohms at 50800-kHz. The resonance is at the 6- meters band. Any ATU does good matching for such load.



VHF ANTENNAS

Antenna X200

X200

(Thanks UA9CR for the schematic!)

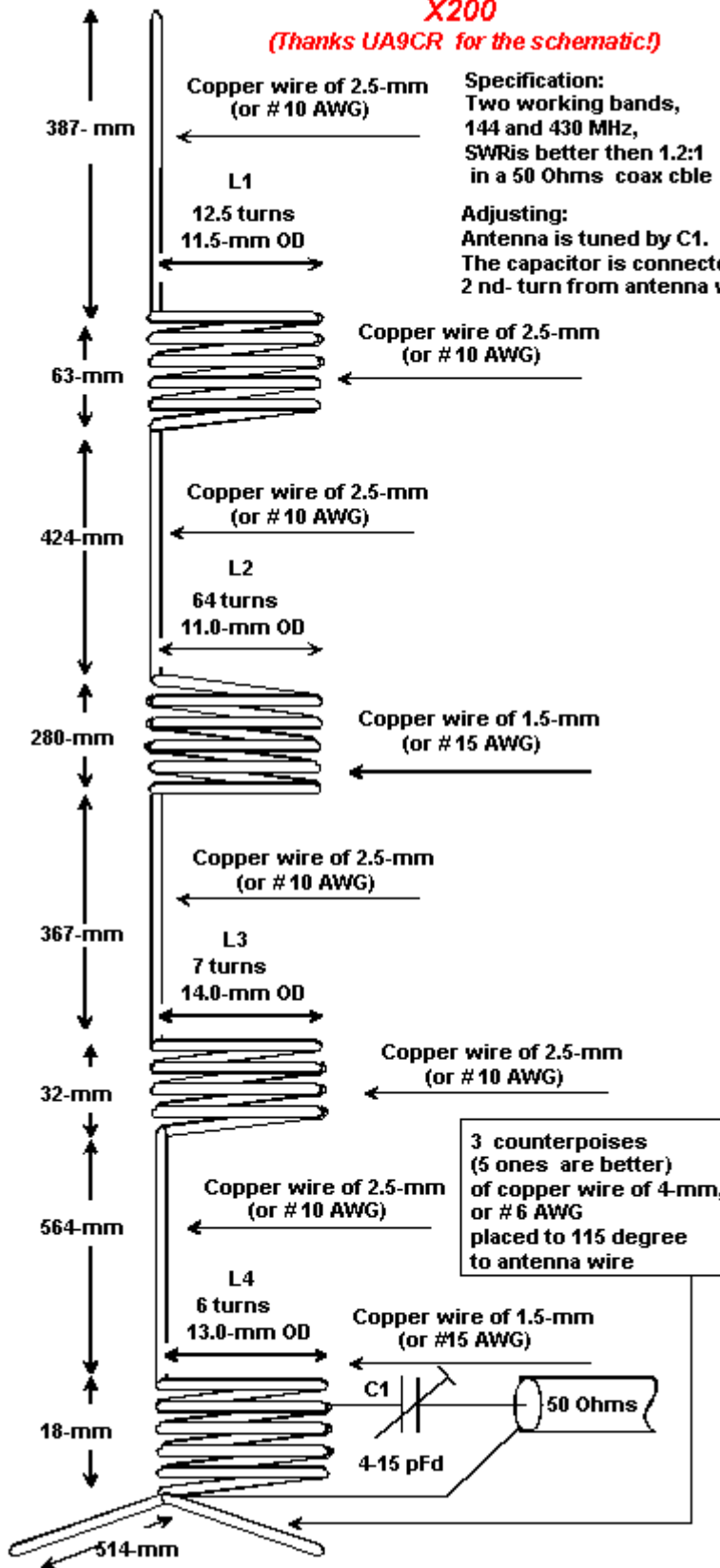

Specification:
Two working bands,
144 and 430 MHz,
SWR is better than 1.2:1
in a 50 Ohms coax cable

Adjusting:
Antenna is tuned by C1.
The capacitor is connected to
2nd turn from antenna wire



Александр UA9CR

Dear Friends,

Most of us are heard about VHF antenna X200. It is very interesting and very reliable two bands antenna.

RV9CX made some modifications for the antenna, so, the new RV9CX-X200 is more suitable for doing at amateur conditions. Go to the next page for the new antenna!

Comments about the antenna please send to Dmitry, RV9CX: rses@rosteck-msi.ru

Also, you can visit to

www.znuki.ru



The site, where are Dmitry and his friends



X200
modified by RV9CX

Specification:
Two working bands,
144 and 430 MHz,
SWR: 1.03:1 at 145 MHz
1.02:1 at 433 MHz
in a 50 Ohms coax cable

Antenna wire and spools
L1, L2, L3, L4, ALL is made
of a whole piece of copper wire
of 2.0-mm diameter (or #12 AWG)

Antenna wire and spools
L1, L2, L3, L4, ALL is installed
inside a plastic fishing - rod

Parameters of L4 is changed
as to original X200. See the
schematic for the parameters.

Adjusting:
Antenna is tuned by C1.
The capacitor is connected to
1.5 th- turn from antenna wire.
If antenna has a good SWR
at 144 and 430, but values of
C1 are differ on the bands,
then you should chose
a tap from L4.

Attention: Without C2 the
antenna works only at 144 MHz.

As RV9CX mentions, the antenn
works fine for 3.5 years without
any care to it!

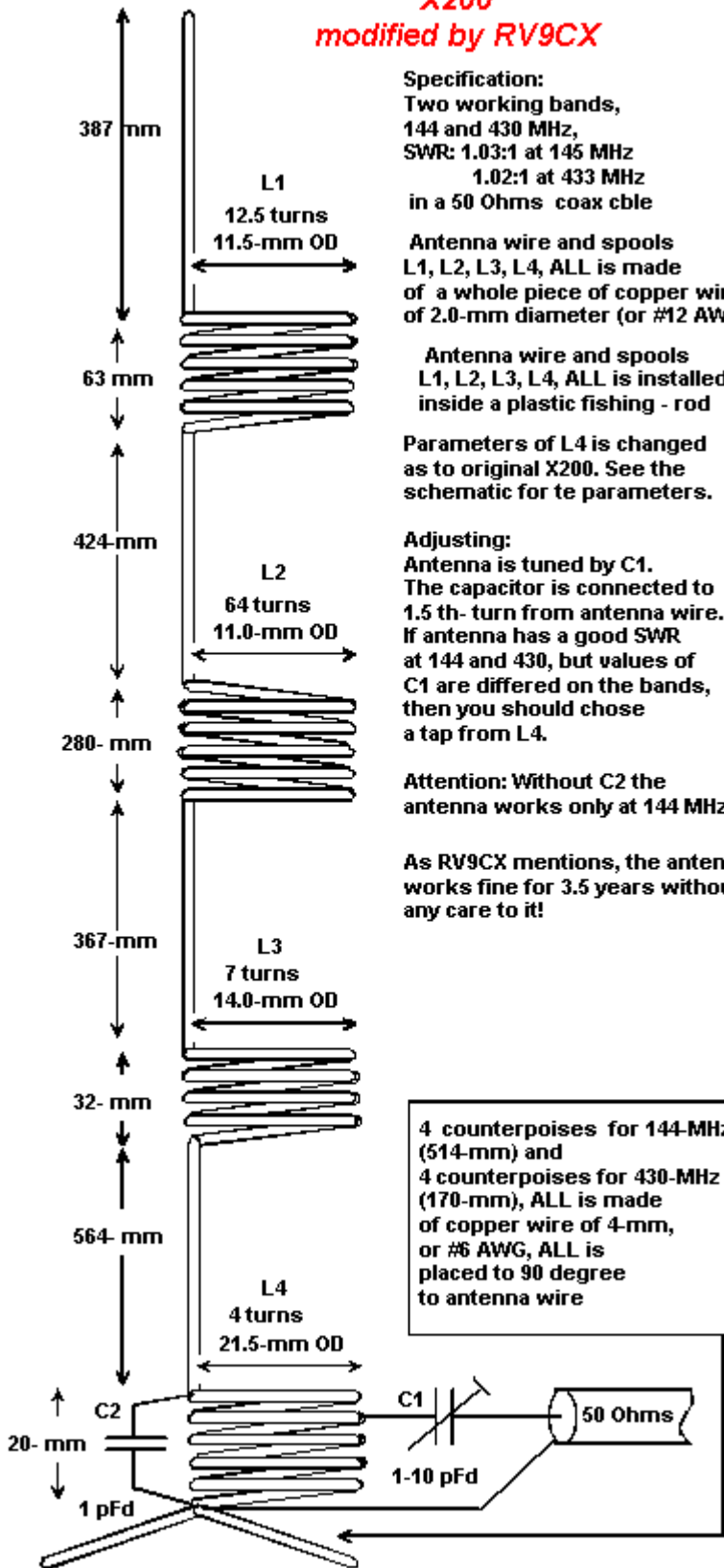

"Bottle" Antenna for 145 MHz

By Sergey Mironov, RA1TW

Any amateur can do the antenna during one hour. To do the antenna takes a half of hour and to tune the antenna also takes a half of hour. So, do not waste time and go to make the Bottle Antenna!

At first take a look at schematic of the Bottle Antenna ([Figure 1](#)).

Specification:

1. Dielectric plate, approximately of 80x250-mm.
2. Vibrator, $(5/8)\lambda$
3. Matching spool
4. Tinned plate, approximately of 25x35-mm.
5. Counterpoises, $(1/4)\lambda$
6. Stud, washers, screw-nuts
7. Coaxial cable

How to do it

1. Take Dielectric plate (1) and install Vibrator (2) on the plate. Use clamps or hard wire for this.
- 145 MHz the vibrator takes the length 1270-mm at the diameter of the vibrator 4...5-mm, and 1200 m at the diameter of the vibrator 10...14-mm.
2. Install Tinned plate (4) on the Dielectric plate. Use Stud, washers, screw - nuts (6).
 3. Do Matching spool (3). The spool has 9 turns of 1.5...2.5-mm diameter (# 14- 10 AWG) copper or silvered plate wire. ID of the spool is 15...18-mm, RA1TW use to old markers as a form for the spools. Length of the spool is 34-mm.
 4. Install the Matching spool on the Dielectric plate. For doing this, the upper end of the spool is fixed to the Vibrator and the down end of the spool is fixed to the Tinned plate. Use solder or fix the ends with the help of screws.
 5. Do counterpoises. Two 105-cm lengths of copper or aluminum wire of 4...6-mm (# 2...6 AWG) are bended as a Greek letter OMEGA looks (see [Figure 2](#)).

Bottle Antenna
Side view

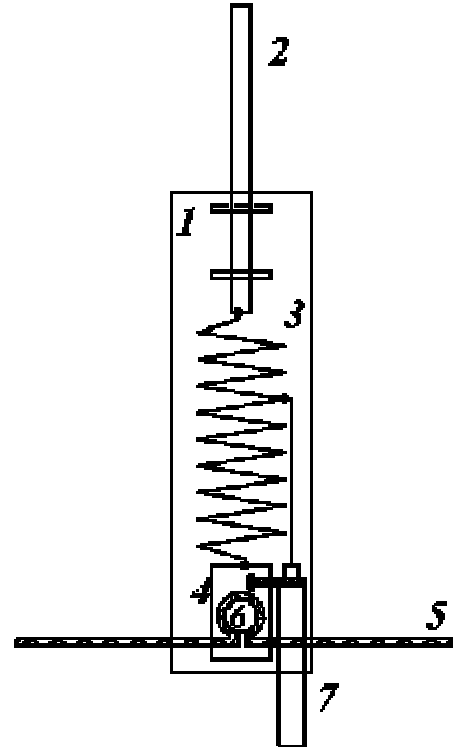

Top view

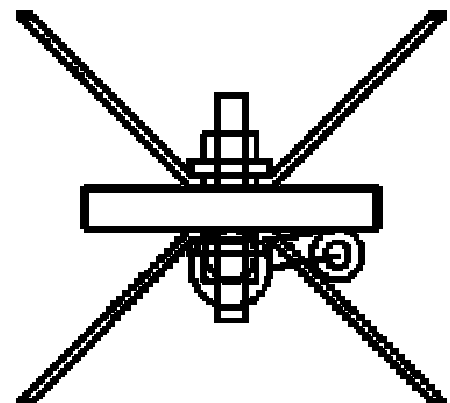

Figure 1

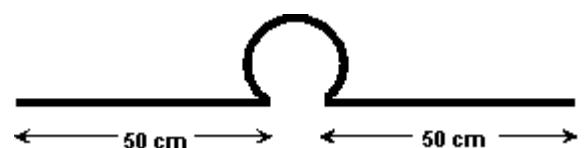

Figure 2. Counterpoises

CHAPTER 2: VHF ANTENNAS

“Bottle” Antenna for 145 MHz

6. Fix the OMEGA- counterpoises to the Stud with the help of the Screw-nuts. The counterpoises should be at 90 degree to the Vibrator and to each other.
7. Fix the OMEGA- counterpoises to the Stud with the help of the Screw-nuts. The counterpoises should be at 90 degree to the Vibrator and to each other.
8. Install Coax (7). Central core is soldered to 3-1/3 tap from the Vibrator, the braid is soldered to the Tinned plate (4).
9. Take a Bottle from dry drink. (I know, RA1TW always prefers a bottle from beer!. I.G.) Do a hole in the screw - top of the Bottle, cut the bottom of the Bottle, cut four slots for counterpoises, and then, install the Bottle (see photo) on the Antenna.

That is all the Bottle Antenna is ready!

Tuning:

The best way to adjust the Bottle Antenna is to use Meter of Amplitude vs Frequency Response characteristics. The device is switched to the Bottle Antenna and we see the frequency characteristic of the antenna. Stretch out the Matching spool or cut lengths of the Vibrator and Counterpoises if the resonance frequency of the antenna is below then 145 MHz. Gripe the Matching spool if the resonance frequency of the antenna is higher then 145 MHz Then select the tap for the best SWR. It is possible to match with the antenna a coaxial cable with any characteristic impedance –50 or 75 Ohms.

RA1TW



Of course, you can adjust the antenna with the help of only SWR – meter or VHF - bridge. There are 8 such home - made Bottle Antennas at Novgorod. All antennas work very well. They provide good communication as inside city as from city to a country for a distance more of 100 kilometers.

Credit line: <http://hamnv.boom.ru>



5/8 λ VHF - UHF ANTENNA

Alex, RA3GBQ, hamradio.lipetsk.ru, natan@lipetsk.ru

To do the antenna one can very easy as well as the costs are nothing. You need a box of a sweets- surprise Chupa- Chups, a piece of an old coax, some wire, epoxies, and a little of job.

So, go to do it!

► Take glass-reinforced plastic rod 5 and upper part of a sweets- surprise Chupa- Chups 10. Insert the rod and wire 4 for matching coil into item 10.

► Take a metal tube, cut a ring 7 and insert into item 10.

► Take a plastic cap 8 from a plastic can, fix a RF-socket 9 on it, solder the wire of the coil 4 to the socket, solder by 3-5 wire the ring 7 to the socket.

► Turn up item 10, fill up it by epoxies 6, and close it by the cap 8.

► When the epoxies are hardened, drill holes for counterpoises 11 at low side of the item 10 and through out item 7.

► Cut a thread into item 5 and onto counterpoises 11.

► Remove braid 3 from a coaxial cable, put on the braid 3 onto item 5 that before is covered a glue. The length of the braid 3 is equal to $5/8\lambda$ for 144 Or 430 MHz.

► Coil the spool 4 (any number of turns) with step between turns of 1-mm, solder the spool to the braid 3.

► Insert 6 $\lambda/4$ counterpoises.

► Meter SWR. Chose a tap from the coil 3 to minimum SWR.

► Put on a can of a pen onto the upper end of the rod 5.

► Put on a shrink plastic tube 1 onto the rod 5.

► Heat the shrink plastic tube.

Get you own antenna!

73!

Sweets- surprise Chupa- Chups

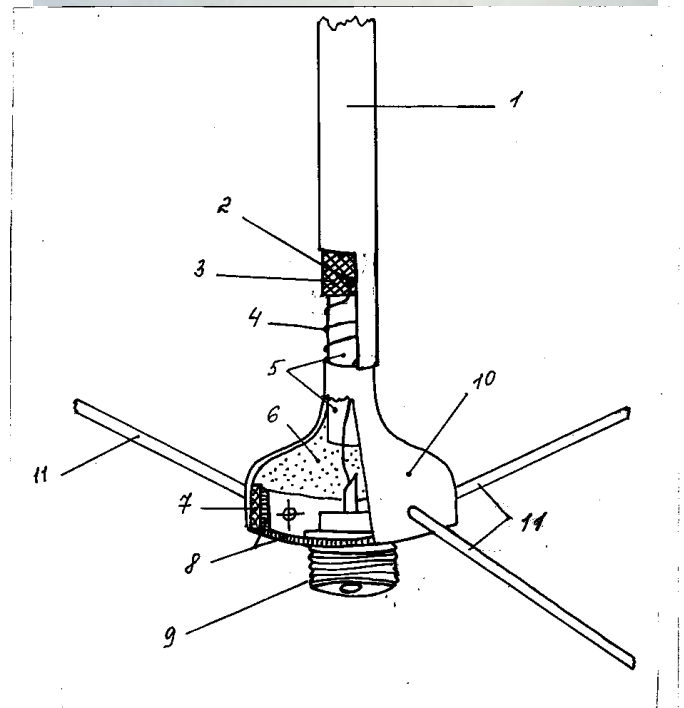

<http://www.antentop.bel.ru/>

FREE e-RADIO magazine

ANTENTOP

www.antentop.bel.ru

SHORT 'RUBBER DUCK' FOR VHF/UHF HAND - HELDIgor, UA6HJG, ua6hjq@mail.ru

All portable hand – held radios have a short “rubber duck” antenna. Some of the rubber duck antennas are rather long and if it is not necessary to communicate on a far distance, the long antenna just hinders to use a hand- held. I decided to make a short rubber duck antenna that is convenient for daily usage and for short distance communication.

Range 144 - 146 MFu**... For Yaesu VX-1R and C - 508**

I have made this antenna for **VX-1R** as it has a small RF-socket SMA. Antenna has length in 43-mm (together with RF-socket). Copper wire of diameter 0.6-mm (# 23 AWG) is coiled up a turn- to turn on a form of diameter of 8-mm. 25.5 turns were coiled. At thus the resonance of the antenna was at 145.3-MHz with SWR 1:1. After winding and checks of the resonance, put on a shrink plastic tube on the antenna, and heat it.

For any stations having BNC socket

Antenna has length in 69-mm (together with RF-socket). Copper wire of diameter 1.3-mm (# 16 AWG) is coiled up a turn- to turn on a form of diameter of 10-mm. 22 turns were coiled. At thus the resonance of the antenna was at 145.3-MHz with SWR 1:1. After winding and checks of the resonance, put on a shrink plastic tube on the antenna, and heat it.

Range 430 - 440 MFu

The design of an antenna for a range of 433-MHz does not differ from the previous design, only it need to reduce the number of turns of the coil. Antenna has length in 42-mm (together with RF-socket). Copper wire of diameter 1.3-mm (# 16 AWG) is coiled up a turn- to turn on a form of diameter of 8.5-mm. 6 turns were coiled. At thus the resonance of the antenna was at 435.3-MHz with SWR 1.8:1. After winding and checks of the resonance, put on a shrink plastic tube on the antenna, and heat it.

These designs were checked with hand-held radios VX-1R, C-568, FT-50 and C-508. At range of communication in city 1-2-kms the home- brew rubber duck almost do not lose to commercial – made ones.

73!**145 MHz 'Rubber Duck'****430 MHz 'Rubber Duck'**Credit Line: <http://www.cqham.ru/>

Figure 1



The antenna is made from a copper or aluminum wire in diameter of 4 mm. A copper or brass tube also will do well. The wires fastened by collars to a dielectric plate in 4 mm thickness. I use a plate from PC stuff. The plate fastened by collars to the antenna metal mast.

A coaxial cable is connected to points "A" and "B" (the central core to "A", the braid to "B").

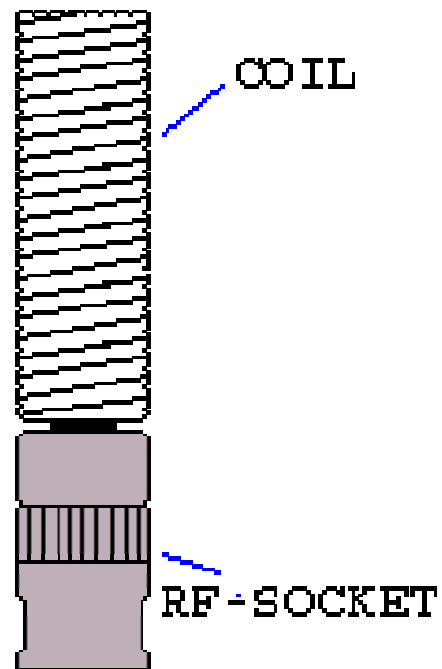
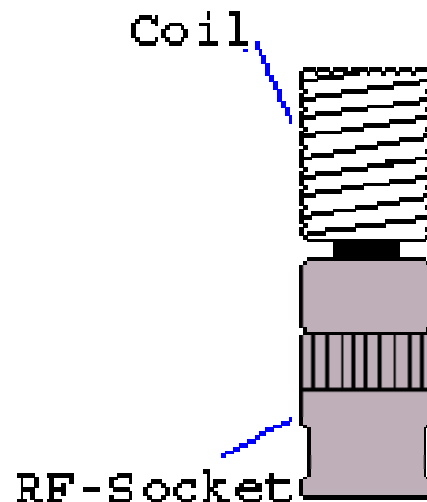
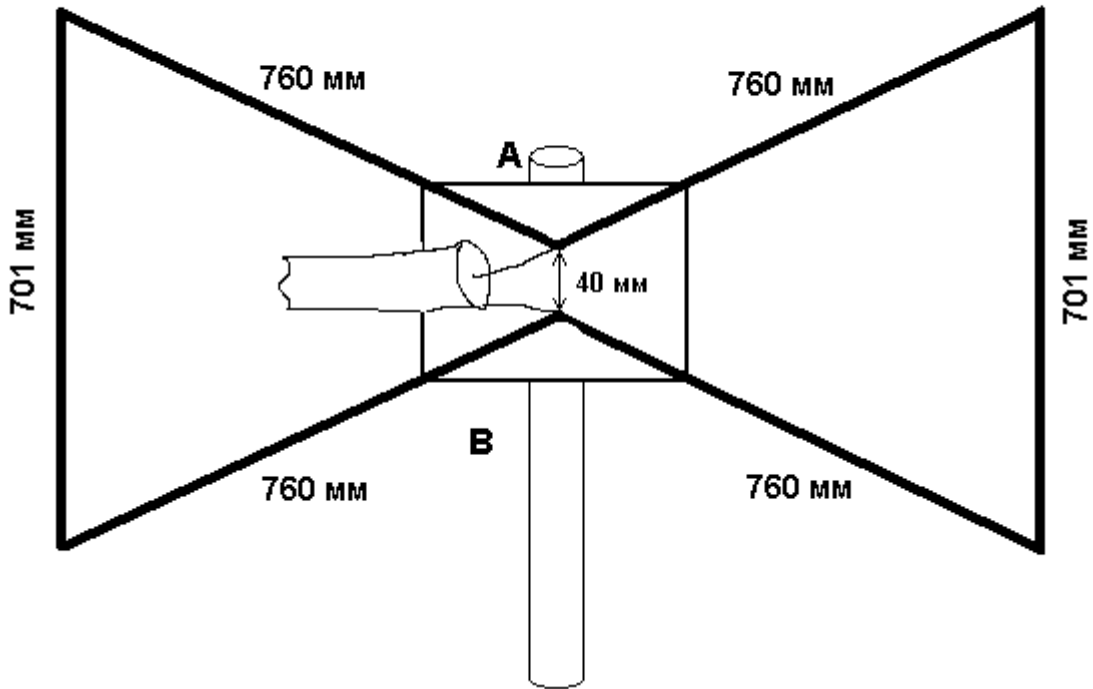
Below, there is a file of the antenna in [MMANA](#).

(MMANA available FREE at www.qsl.net)

The great collection Antenna Files at: <http://www.qsl.net/dl2kq/mmana>

Twins Delta For 145_50 MHz

```

*
145.5
* wire *
7
0.0, 0.6845, -0.3505, 0.0, 0.6845, 0.3505, 0.002, -1
0.0, 0.6845, -0.3505, 0.0, 0.0, -0.02, 0.002, -1
0.0, 0.6845, 0.3505, 0.0, 0.0, 0.02, 0.002, -1
0.0, 0.0, -0.02, 0.0, -0.6845, -0.3505, 0.002, -1
0.0, 0.0, 0.02, 0.0, -0.6845, 0.3505, 0.002, -1
0.0, -0.6845, -0.3505, 0.0, -0.6845, 0.3505, 0.002, -1
0.0, 0.0, -0.02, 0.0, 0.0, 0.02, 8.000e-04, -1
*** sources ***
1, 1
w7c, 0.0, 1.0
*** load ***
0, 1
*** Autosegment ***
400, 40, 2.0, 1
*G/H/M/R/AzEI/X*
0, 5.0, 0, 50.0, 0, 0, 0
    
```

Enjoy!

FIVE ELEMENTS VHF ANTENNA RN1NZ FOR 145 MHz

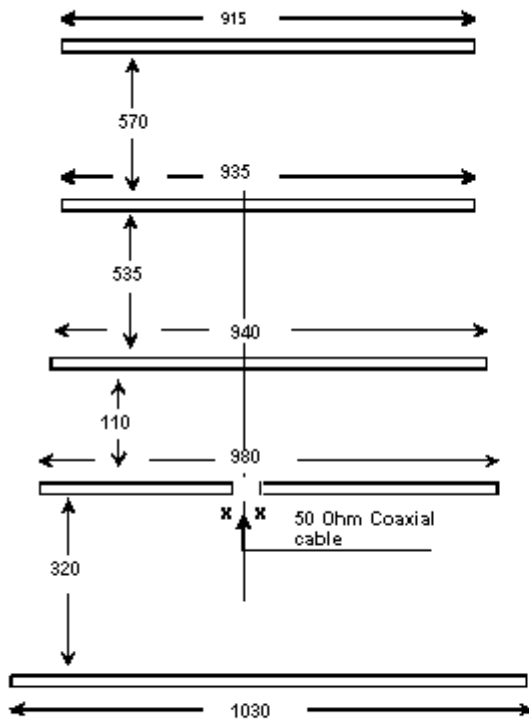

Visit and take for FREE the great
Microwave Antenna Book
 By Paul Wade W1GHZ (ex N1BWT)

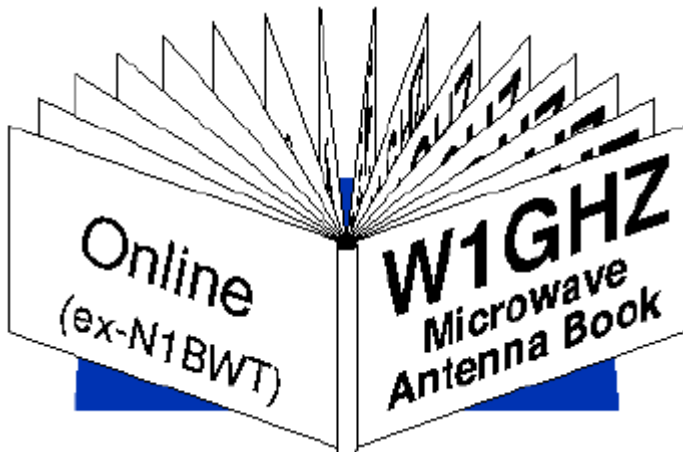

<http://www.qsl.net/n1bwt/contents.htm>

Table of Contents:

Part-I: Practical Antennas (8 Chapters!)

<http://www.antentop.bel.ru/>

Gain: 8.5 dBi
 SWR: Less then 1.5:1 at 144...146 MHz
 Front/Back Ratio: more then 18 dB
 Input Impedance: 50 Ohm
 All elements have diameter of 4-mm (or #6 AWG)
 Traverse has diameter of 15-mm and lenfth of 1600-r
 Antenna elements are electricly insulated from the traverse

Antenna Construction

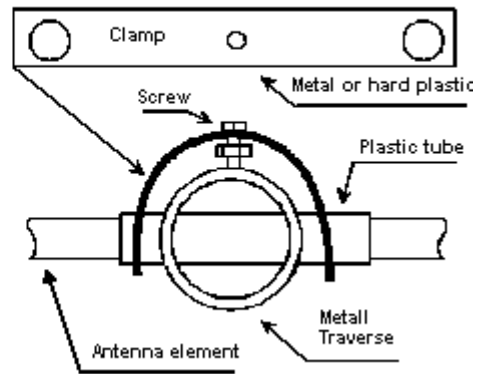

RN1NZ
rn1nz@onego.ru



Credit Line: RN1NZ @ Radio #4, 2002, p.65

For more info see:
www.radio.ru/



Part-II: Antenna Measurement (2 Chapters!)

Part-III: Computer Analysis of Antennas (2 Chapters!)

FOLDING 3-EL YAGI FOR MOUNTAINS

Igor, UA6HJG, ua6hjq@mail.ru

This antenna was developed specially for mountains trip from my experience of radio communication in mountains. The antenna is optimized to the maxima forward gain. At work you can hold the antenna by the "tail" and direct the antenna to your correspondent using vertical or horizontal polarization.



Figure 1 shows the design of the antenna. Antenna boom is made of a plastic water pipe of 1000-mm of length and of 22-mm OD. Antenna reflector and vibrator both are made of aluminum wire of 5-mm of diameter. Antenna vibrator is made of bimetallic wire of 5-mm of diameter. The vibrator is soldered to PC-board that is the central insulator for the vibrator.

Figure 1

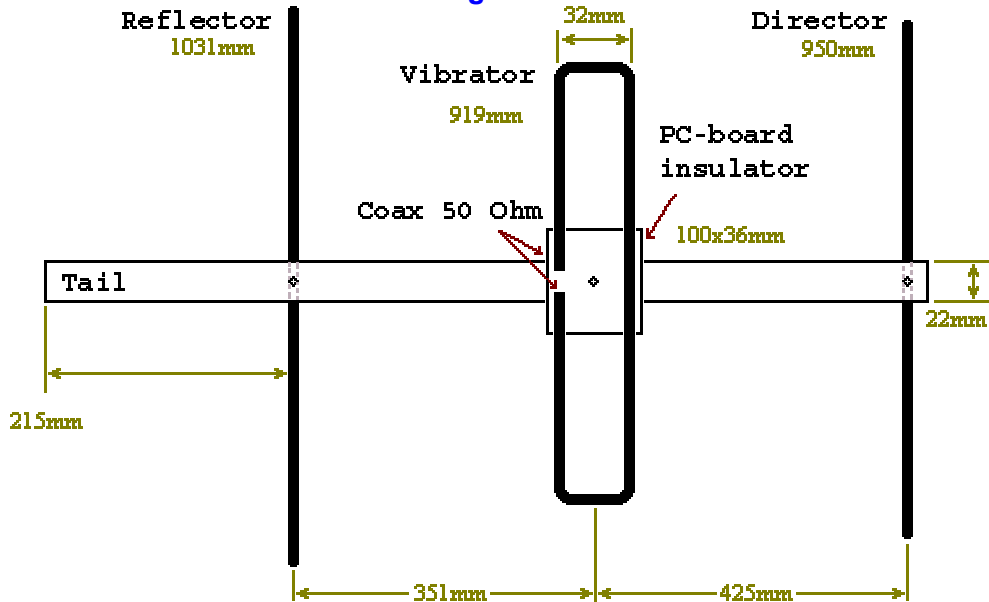

A 50-Ohms coaxial cable is used with the antenna without any symmetrical devices. The cable goes along the boom and get out from the tail. For antenna folding you can loose screws, turn antenna vibrator along the boom, and again strength the screws. Antenna director and reflector is removed from the boom and hide inside the boom.

Coaxial cable has the length of 1100-mm. The cable is laid inside the boom and get out from the tail. It is need to protect from weather the place where the coaxial cable is soldered to the vibrator. RF socket also must be protected from weather and dirty at transportation of the antenna. Antenna has weight of 0.4-KG. Practical measured (by device SWR-121) SWR is: at 144.7=1.3:1, 145.2=1:1, 145.7=1.6:1.

Antenna has gain compare to half-wave dipole 6-7 dB. In general to measure the real gain of an antenna in the amateur conditions is practically not easy matter. I use a comparative method that shows

advantage one antenna above other one. The essence of this method is simple. You take a dipole as the exemplary antenna and do compare the dipole with the experimental antenna.

Being on the southern slope of Elbrus- mountain at height of 4000 meters I use the method with help of Turkish ham station TA7T. The distance between me and TA7T was approximately 500-kms. I hardly heard TA7T by my exemplary dipole but I had 59 with the YAGI. It is near 10 dB in real gain!



SIMPLE 430 - MHz 3 - EL YAGI FOR MOUNTAINS

Igor, UA6HJG, ua6hjq@mail.ru

I want to pay attention that UHF antennas for mountain climbing has the own specificity. So, antennas having the gain more the 6-9-Db-dB are not necessary in mountains at big height (from 3000 meters and is higher), as well as you do not need mast for the antennas. Also I prefer not knock- down antenna design. .

This antenna was developed specially for high-mountainous trip proceeding from my previous experience. At the first place I stand following characteristics: gain, weight, reliability. The antenna is optimized of the maxima forward gain. The design is made not knock- down that is



Figure 1

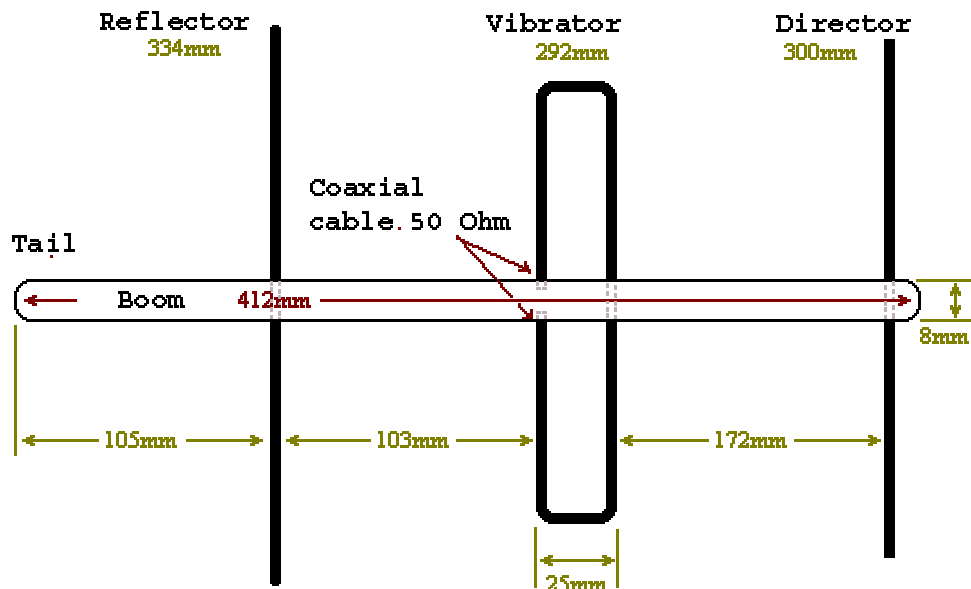

very conveniently as the antenna is always ready to operation. You can hold the antenna by its tail and direct the antenna to your correspondent at operation.

Figure 1 shows the design of the antenna. The boom is made of an ebonite rod of 412-mm length and of 8-mm diameter. Antenna elements are made of a copper wire of 2- mm (#12 AWG) diameter. 50 Ohms coaxial cable is soldered to antenna vibrator without any symmetrical and matching devices. The coaxial cable goes along the boom and get out from the antenna tail. Antenna elements are fastened to the boom by epoxies. The antenna can place above or inside a tourist backpack.

The coaxial cable has length of 50-mm. The place of the soldering of the coaxial cable to the vibrator must be protected from the weather. Antenna has weight of 150 gram. 150rp, real gain of 6-7 dB above half-wave dipole. SWR is: at 433-MHz =1.8:1, at 435-MHz =1.4:1, at 438-MHz=1:1, at 440-MHz=1.5:1 (it as measured by device 'SWR-121').

Commentary:

I recommend to use the antenna with low-power UHF radio (10-mWtts) for a range 433-434Mгц. I have 30- 50 kms of distance (at direct vision) using the antenna with such station. Also I recommend to use the antenna with usual UHF radios, be sure, you easy will skip more than 100-kms!

Credit Line: <http://www.mountain.ru>



SIMPLE 430-MHz 4-EL YAGI FOR MOUNTAINS

Igor, UA6HJG, ua6hjq@mail.ru

The purpose of this design is to create an antenna for mountains. The antenna must correspond follow requirements:

1. To have gain not less the 7-dB. Forward Gain is the main characteristic of the antenna.
2. A wide lobe must be. During a QSO you can hold the antenna by the tail and shaking of the antenna should not result to full 'failure' of the communication.
3. Simplicity in making and adjustments. An opportunity of fast repair in field conditions.
4. Antenna weight with coaxial cable both must be up to 500 gram.
5. 50-Ohm coax for the feeding must be used.

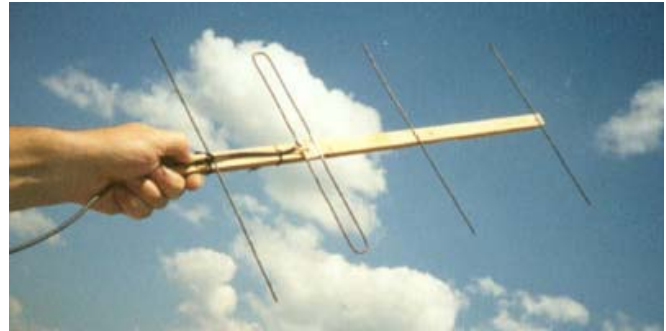
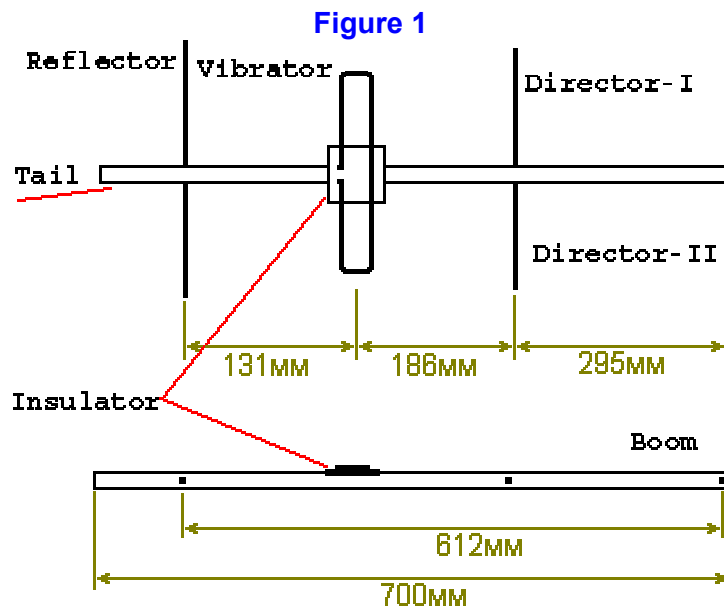

Figure 1 shows a design of such antenna. The boom is made of a wooden strip.. Elements and the vibrator are made of 2-mm copper wire (# 12 AWG).

The sizes of elements:
 Reflector 345-mm.
 Vibrator 285-mm.
 Director-I 312-mm.
 Director-II 306-mm.



The design of antenna vibrator is shown on **Figure 2**. Coaxial cable has 850-mm length and this one goes along the boom. Soldered place must be protected from weather.

Antenna has weight of 290 gram. SWR (metered by SWR-291) is: at 433- MHz =2:1, at 435-MHz =1:1, at 438-MHz =2:1.

The antenna worked very well in the mountains. Also the antenna may be used for stationary work from a fixed QTH.

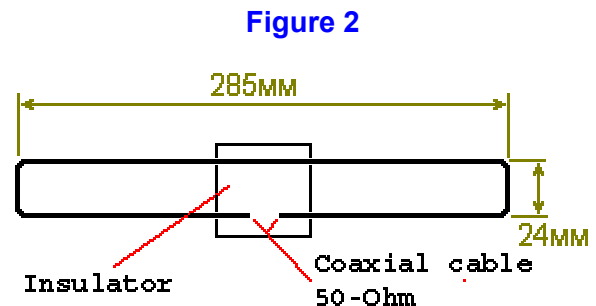

Credit Line: <http://www.mountain.ru>

4-OVALS ANTENNA FOR 430-440 MHZ

Igor, UA6HJG, ua6hjq@mail.ru

I need a good universal antenna for repeaters working at the 70-cm range, packet radio and for routine work. Such antenna must satisfy the following characteristics:

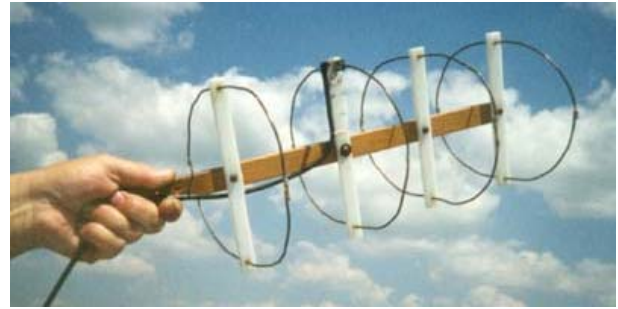

1. Real Gain 9-10-dB.
2. Low SWR at 430-440- MHz.
3. Wide forward lobe.
4. Unpretentiousness to close located subjects.
5. Simplicity in manufacturing and adjustments.
6. Possibility to create phased антенные systems on the basis of the antennas.
7. 50 - Ohm coaxial cable feeding.
8. Stability to heavy icing and to winds in 10-20 meters per second..

4 Ovals Antenna responded all of the conditions. Why an oval? At first, from the antenna theory we know that an oval radiates energy a little bit more effectively than a square. At the second, in practical, it is more easy to do an oval then a square.. So choose the OVAL! **Figure 1** shows a design of the

Figure 1

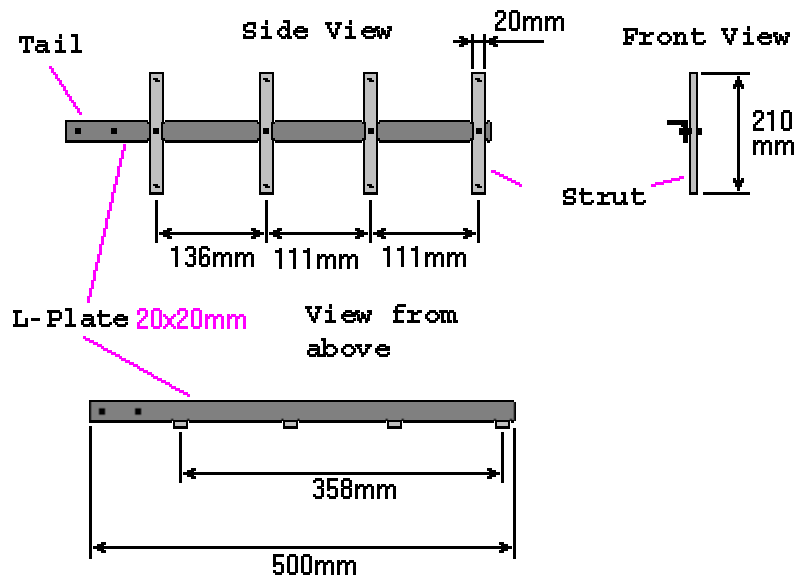

antenna. Boom is made of iron L-plate 25x25-mm. All the four ovals are fastened to the boom by struts made of insulation stuff such as tree, hetinax, etc. Antenna is fastened by the tail, that is behind the struts.

Director-I- 649-mm. (-20MM).

Director- II - 639-mm. (-20-mm).

Perimeter of elements (ovals):

Reflector- 727-mm. (-20-mm for soldering).

Driven Element- 653-mm (+10-mm distance for a RF socket).

Figure 2 shows the design of the Driven Element. RF socket is soldered directly by the ends of the oval. Three holes is drilled at each strut. One holes is in the center for fastened the strut to the boom, two holes are at the ends for bimetal oval. Antenna reflectors and directors have the same design as the Driven Element only difference is its ends soldered together.

Figure 2

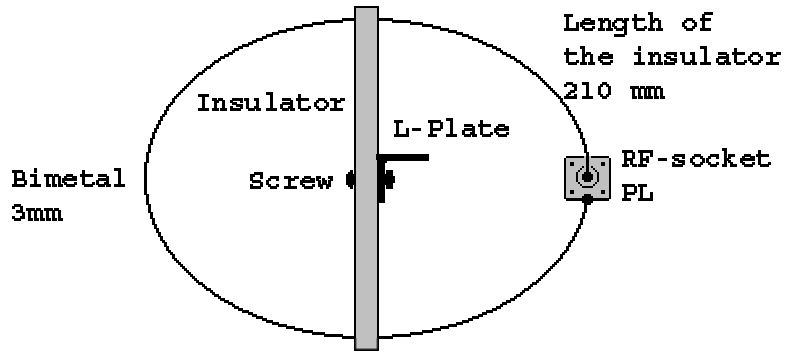

Antenna has weight of 900 gram. SWR is: at 430-MHz =1.2:1, at 435-MHz =1:1, at 440-MHz=1.3:1 SWR was metered by device SWR-121. If you will use boom

made of iron L-plate having not the same dimensions you would do correction lengths of antenna elements. I want to pay attention, that the antenna is more laborious than YAGI, but it work much better.

4-OVALS ANTENNA FOR 430-440 MHz FOR MOUNTAINS

Igor, UA6HJG, ua6hjq@mail.ru

When an antenna is intended for mountains it must follow such additional requirements as:

1. Light weight.
2. To have folding design and to take a little place in a backpack.
3. Antenna should be conveniently to hold in a hand, to fasten to a tree or stick. .
4. Tolerance to a dirty, water and snow.
5. Possibility to repair in field conditions.
- 6.

So, the boom of the trip antenna is made of a wooden

strip drying by oil. Perimeter of all ovals is increased on 20-mm compare to previous design. All struts are made from un- foiled PC-board. Antenna elements are made of 2-mm diameter soft copper wire (# 12 AWG). Soldered parts must be protected from the weather.

Antenna has weight 400 gram. Other characteristics are as the previous design has. The antenna is tested at 1997 and at 2000 in the mountain Elbrus and the antenna shows good result. I made QSOs in distance of 200-300 kms with 59 for both ends!



Igor, UA6HJG, on Elbrus



Elbrus



RECEIVING ANTENNAS

OLD RECEIVING MAGNETIC LOOP ANTENNAS

Igor Grigorov, RK3ZK
antentop@mail.ru

Receiving magnetic loop antennas were widely used in the professional radio communication from the beginning of the 20 Century. Since 1906 magnetic loop antennas were used for direction finding purposes needed for navigation of ships and planes. Later, from 20s, magnetic loop antennas were used for broadcasting reception. In the USSR in 20- 40 years of the 20 Century when broadcasting was gone on LW and MW, huge loop antennas were used on Reception Broadcasting Centers (see pages 93- 94 about USSR's RBC). Magnetic loop antennas worldwide were used for reception service radio stations working in VLW, LW and MW. The article writes up several designs of such old receiving loop antennas.

LW- MW Huge Receiving Loop Antennas for Broadcasting and Direction Finding

In old radio textbooks you can find description of old magnetic receiving loop antennas. As a rule, old magnetic receiving loop antennas had a triangle or square shape, a side of the triangle or square had length in 10-20 meters. The huge square was put on to a corner. The distance from the ground up to lower wires of the magnetic receiving loop usually was not less than 4 meters. Fig. 1A shows a triangular receiving loop antenna consisting of two perpendicular loops, used for direction finding at airports [1], Fig. 1B shows a square receiving loop antenna used on Broadcasting Radio Centers of the USSR at the end of 30s of the 20 Century [15]. Usually the receiving magnetic loop contained from one up to eight turns.

Fig. 2 shows a typical connection of the above mention huge magnetic receiving loop antennas designed for working on one fixing frequency to the receiver. To a resonance the loop A1 is tuned by lengthening coil L1 (sometimes two lengthening coils switched symmetrically to both side of the loop were used) and variable air-dielectric capacitor C1. T1 did connection with antenna feedline. L1, C1 and T1, as a rule, are placed directly near the antenna keeping minimum length for wires from the antenna to the parts. Certainly, there were others circuits for connection magnetic loops to a receiver, but the circuits were insignificantly distinguished from Fig. 2.

Small- Sized Magnetic Loop of a Local Broadcasting Radio Center

Huge loop antennas were used for cities Broadcasting Radio Centers, for local Broadcasting Radio Centers a small- sized loops were used.

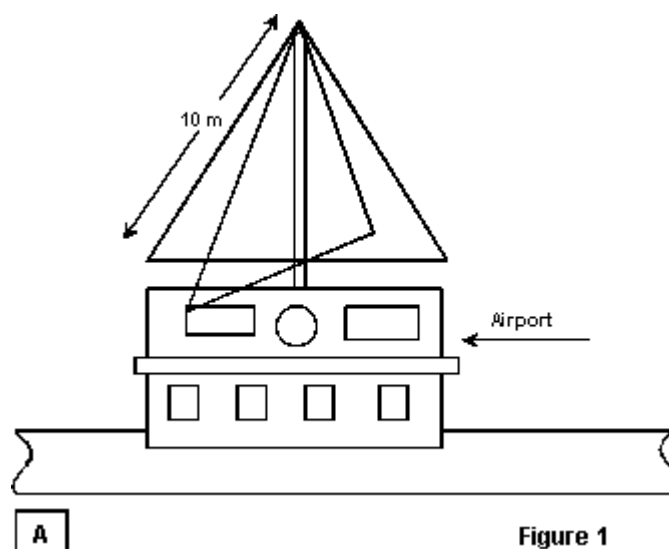

Figure 1

Figure 1 Old huge magnetic receiving loop antennas

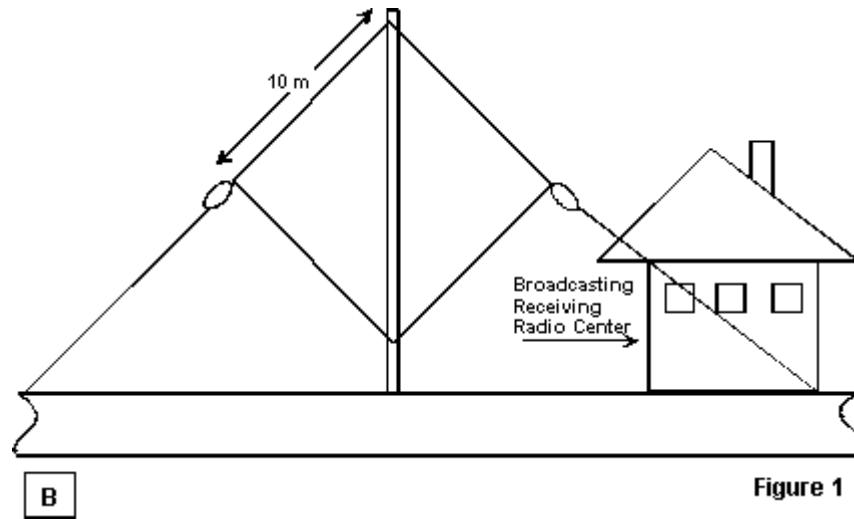

Figure 1 Old huge magnetic receiving loop antennas

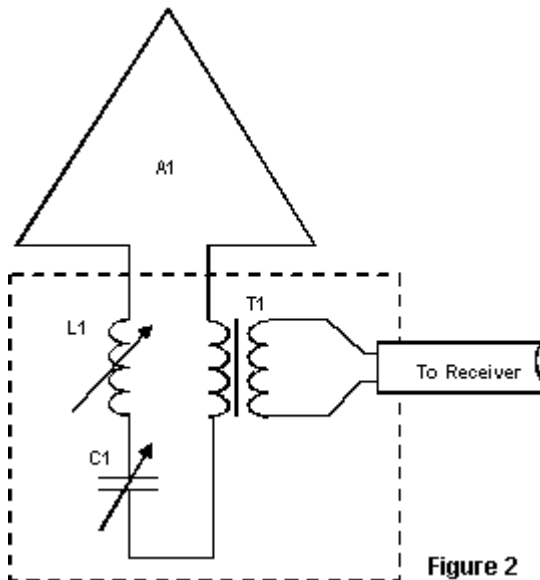

Figure 2 Connection of the reception magnetic loop to a radio receiver

main since the Broadcasting Center was in operation, so, the equipment were in continuous work already more than thirty years. Time to time the tubes of the receivers and amplifiers were changed, it was only that was done. Quality of work of the Broadcasting Center was great.

The most interesting part of this Broadcasting Center was a small-sized (certainly, small-sized in comparison with the antennas shown on Fig. 1) receiving magnetic loop antenna. By nameplate from the antenna I have known, that the antenna was made in 1949 on one of plants of Gorky (now Nizhniy Novgorod), Russia. Fig. 3A shows a design of the small-sized magnetic loop, and Fig. 3B shows the electric circuit of the antenna. Design and circuit, both, were pictured by me from the real loop.

The loop antenna (item 1) had diamond shape, sides had length in 105-cm (it was measured by a roulette), the loop was attached to a wooden cross (item 2), this one was covered by light lacquer. Overall height of the magnetic loop antenna was near to 2 meters. Antenna wires were more than 1-millimeter in diameter and were covered by thick black cotton isolation, a strong thin layer of light varnish covered the isolation.

Such small- sized receiving loop I have seen in an old village Broadcasting Radio Center in Central Russia, where I was occasionally in 80s of the 20 Century. The center was built in the beginning of 50 years of the 20 Century and till now was in work practically without changes. The broadcasting center settled down in a small room on a ground floor.

This rural Broadcasting Center contained a receiver PTS (see page 93- 94 about USSR's RBC) together with a small-sized loop antenna and an old tube audio amplifier, but I could not remember its type. All equipment was produced at the 50s. As I was told, the radio receiver and the audio amplifier of low frequency never were switched off from the

The loop contained about 20 turns of the wire. The turns were rigidly settled down in trenches of plates (item 3), the plates were probably made of an ebonite. The distance between turns on the plates was equal to the diameter of the wire. The loop antenna was coupled to a receiver through a coupling loop (item 4) that contained 4 turns. The coupling loop was connected to a receiver through a feedline (item 5). The feedline has length near 3 meters and looks like a main wire.

A small wooden box (item 6) was in the bottom of the loop. A big three-section (each section has 12-500-pF) variable capacitor with vernier intended for tuning the loop to a resonance was in the box. Also there were taps switch S1 and two trap (L1C2 and L2C3) tuning to hindered broadcasting radio stations. The trap is

switched to the feedline instead of crosspieces between clamping contacts K1K2 and K4K5. These contacts were established inside the box. Feedline contacts K3K6 were installed at a cheek of the box.

However small-sized magnetic loop antennas were used not only to Broadcasting Radio Centers. Earlier, in 30-50 years of the 20 Century such antennas frequently installed inside broadcasting receivers. Some designs of the inner loop antennas are shown below.

Basket Magnetic Loop Antenna

Receiving basket loop antennas were widely used for work with LW and MW receivers of direct amplification since the end of 20s of the 20 Century. As a matter of fact, basket loop antennas are ones of the first types of magnetic loop antennas used by radio amateurs. Basket loop antennas were used both as to stationary receivers as to so called "suitcase receivers", i.e. tube receivers made inside a suitcase and intended to a movable work. Old radio magazines of 30- 50s of the last century contained hundreds designs of basket loop antennas.

Basket loop antennas were earlier so popular because, in the first, ever a radio amateur having a minimal experience of designing easily can make this one, in the second, a basket loop antenna can be made of any improvised material, and in the third, a basket loop antenna made even in home conditions works very effectively. The essence of the design of a basket loop antenna is that at its winding the step between turns is constant and equal to the diameter of the used wire (practically this step even bit more).

A coil, which has been reeled - up with such step, has rather small own parasitic capacity of turns to each other. It is possible to show, that the more parasitic own capacity of a coil is the less its Q is (see, for example, reference [3]). So, at a small own capacity a loop has high Q.

There are several basic points to pay attention at design of a basket loop antenna. A basket loop antenna can be reeled up on a plate from any dielectric stuff having small losses on frequencies where the antenna works. A basket loop antenna of LW- MW ranges can be made of a cardboard, wooden plate, PC- board, getinaks or ebonite. Pay attention, that some grey cardboard made of so-called "not washed" recycling paper (a paper

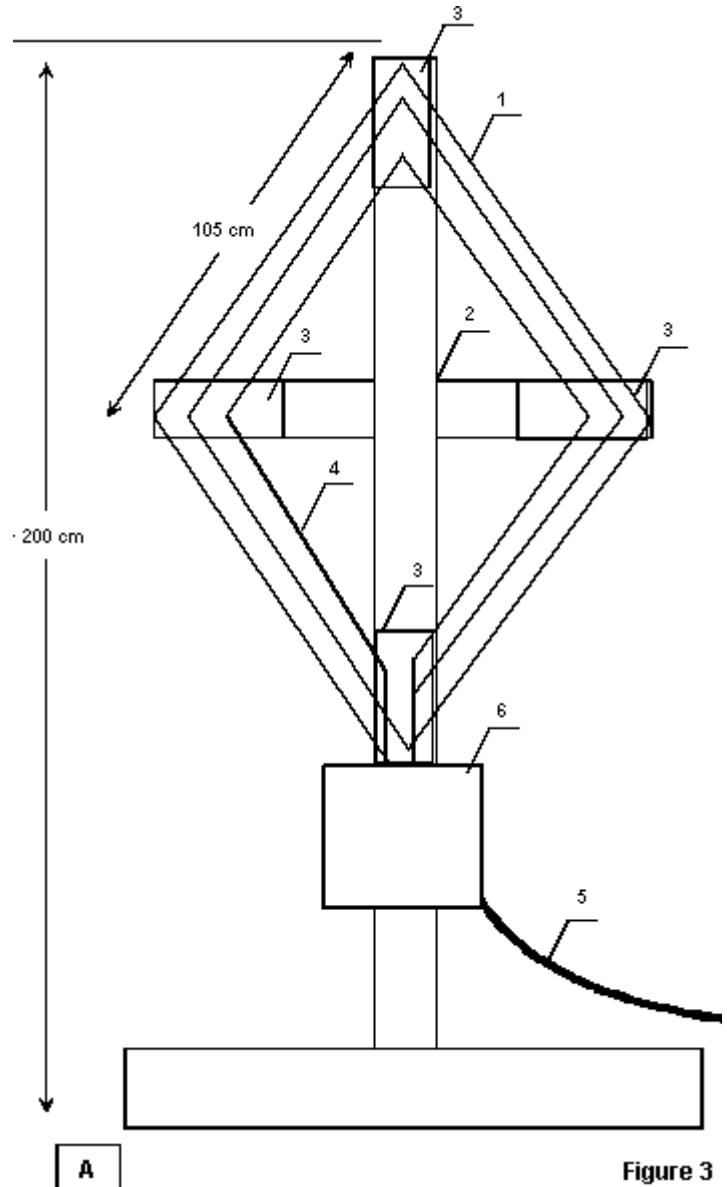

Figure 3

Figure 3 Small-sized receiving loop of a rural Broadcasting Radio Center

that is not washed off typographical paint) can have a big losses at LW- MW ranges, at least, in a microwave this cardboard is strongly heated up. Certainly, do not use the grey cardboard for a form of a basket loop antenna. Odd number slots are made in this dielectric plate, the more slots are done, the winding has more density Number of turns and sizes of an antenna form are depended on frequencies range used.

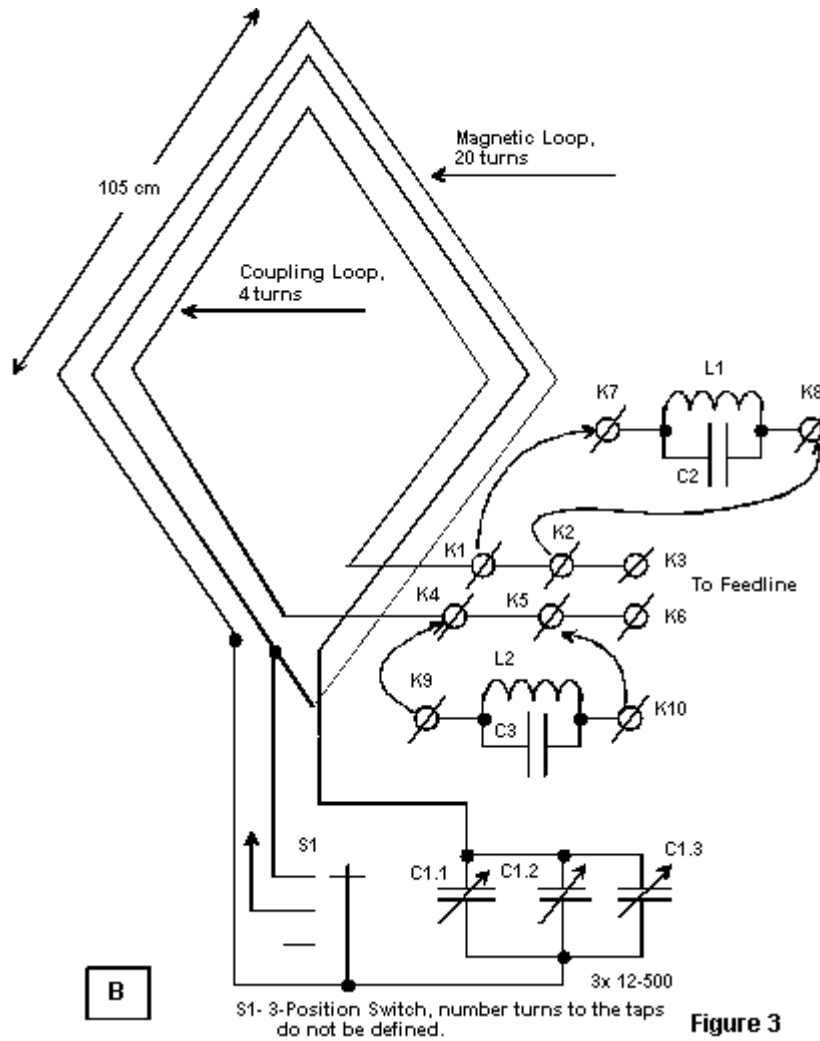

Figure 3

Figure 3 Small-sized receiving loop of a rural Broadcasting Radio Center

Basket Loop Antenna of a Simple Tube Receiver of Direct Amplification

Fig. 4 shows the circuit and design of a basket loop antenna intended for use in a simple three-tubes regenerative receiver for LW- MW. The receiver was described in the reference [5]. For design of the antenna a disk made of a cardboard or plywoods is used. The disk has diameter in 120 millimeters and the thickness in 3 millimeters. Five slots of 45 millimeters in the length of and 2-3 millimeters in width are done on the disk at equal distance one after the other. A special ledge for fastening the loop antenna is made on the disk. Magnetic loop antenna contained 250 turns of an insulated copper wire in diameter of 0,15-0,25 millimeters. Beginning of the reeling is up of the centre of the disk.

Taps are tapped from the loop for tuning the loop to a resonance. Taps are made from 50, 100, 150 and 200 turns. When you doing the taps, do not break off antenna wire, wind wire

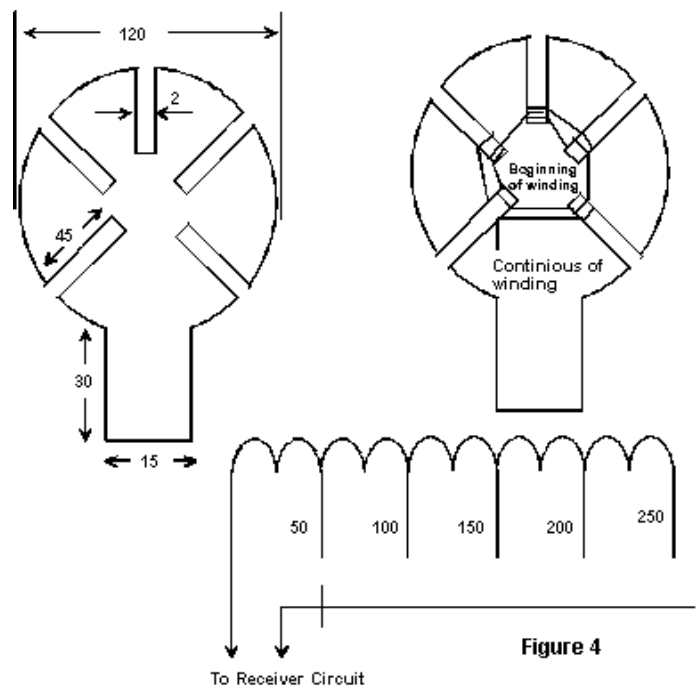

Figure 4

Figure 4 Magnetic basket loop antenna of a regenerative receiver of LW- MW

into a loop in length approximately 200 millimeters, then continue winding.

Basket Loop Antenna of a Simple Suitcase Tube Superheterodyne

Fig. 5 shows a basket loop antenna of a superheterodyne receiver of LW- MW made in a suitcase. The receiver was described in the reference [5]. The basket magnetic loop antenna is placed on a cover of a suitcase in which the receiver is placed. More slots - more density of winding of the loop.

The first section of the antenna contains 29 turns, it is wound by a Litz wire 10x0,07 (10 wire in diameter of 0,07 millimeters), as a last resort, this winding can be made by a wire of 0,4-0,5 millimeters in diameter. The first section starts to reel up from the internal part of the form. The second section of the antenna continues winding the first section, it is wound by a copper insulated wire of 0,2 millimeters in diameter and contains 70 coils. When the antenna works at MW the first section is shortened. At LW both section of the loop antenna are in work.

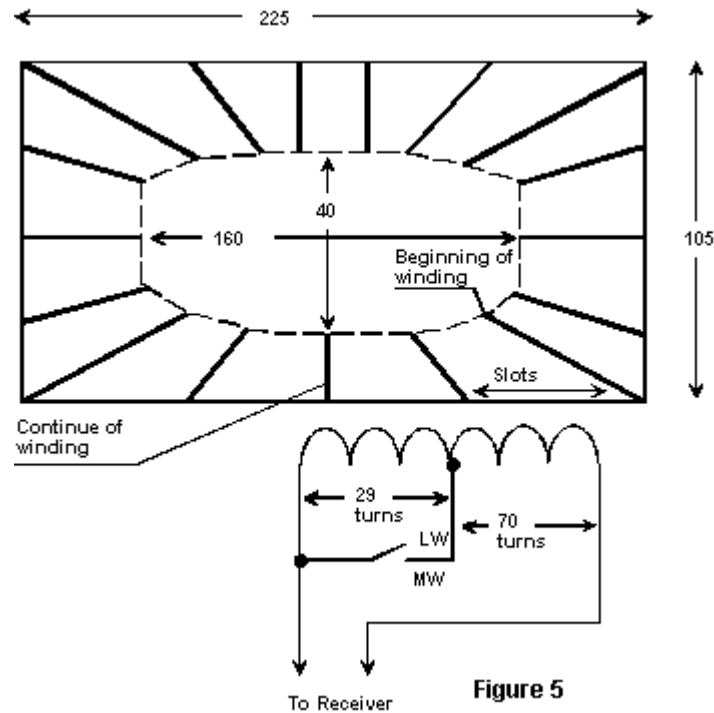

Figure 5 Magnetic basket loop antenna of a superheterodyne receiver of LW- MW

Magnetic Loop Antenna of a Suitcase Tube Superheterodyne

Certainly, not only basket loop antennas were used in old receivers. Simple loop antennas were widely used also. A simple superheterodyne LW- MW receiver made in

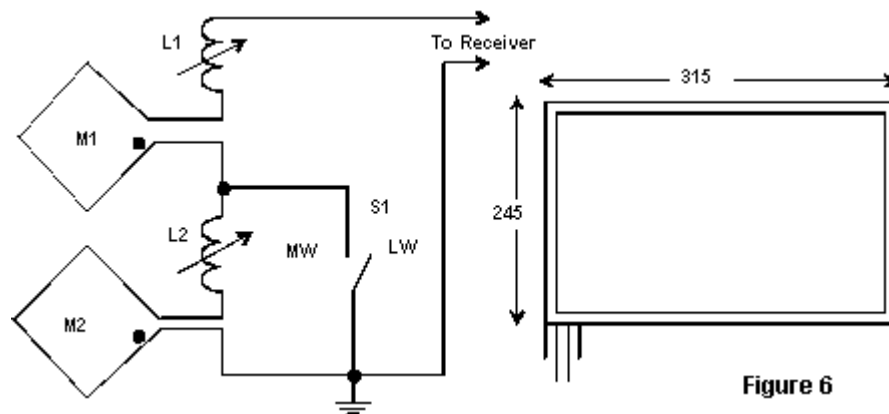

Figure 6 Magnetic loop antenna of a superheterodyne receiver of LW- MW

CHAPTER 3: RECEIVING ANTENNAS

a suitcase and using a loop magnet antenna is described in the reference [5]. Fig. 6 shows the circuit and design of the loop antenna. It was used two magnetic loop antennas, M1 and M2. Lengthening coils are switched in serial with each loop antenna (L1 to M1 and L2 to M2), necessary for exact tuning of the loops to frequencies range needed. Both, M1 and M2 are used at LW. When the loop works at MW, M2 is shortened, and only M1 does receiving.

Magnetic antennas M1 and M2 have sizes 315x245 millimeters, M1 contains 14 turns of Litz wire 30x0,06, M2 contains 50 turns of Litz wire 15x0,05. As a last resort, instead of a Litz it is possible to use a copper insulated wire in diameter of 0,15 millimeters.

Lengthening inductor L1 contains 50 turns, lengthening inductor L2 contains 125 turns, the wire is Litz 15x0,05. These inductors are reeled on a form in diameter of 8 millimeters. The width of winding is 7 millimeters for both inductors.

Short Wave Magnetic Loop Antenna

Magnetic loop antennas were used not only for LW and MW, also the antennas were used for SW. For example, in the reference [5] it was described a SW magnetic loop antenna which was used for 19-75 meters. The loop antenna was simultaneously the input circuit of the receiver. A variable capacitor 12x500-pF does tuning to a resonance of the loop. Fig. 7 shows design of the antenna.

The antenna is made of a copper strip 6x3 (width in 6 millimeters, thickness in 3 millimeters). Such strip is used for winding welding transformers. The loop antenna contains 2 turns, the distance between the turns is 10 millimeters, inductance of the magnetic loop is 3,1- μ H.

Old Receiving Magnetic Loop Antennas

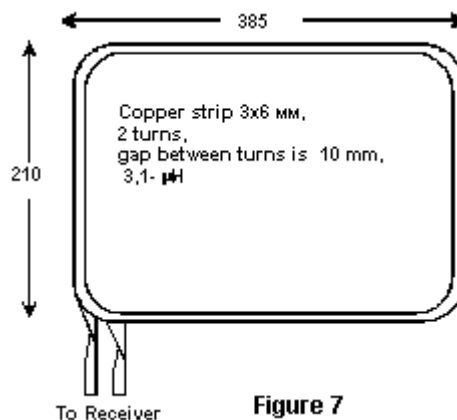

Figure 7 SW magnetic loop antenna

References:

1. Schegolev E. I. Radionavigation. Moscow, GITTL, 1946.
2. Sheinman A. Z. A collective- farm broadcasting center. Moscow, Zhurgazob'edinenie, 1938.
3. Atabekov G. I. Linear electric circuits. Moscow, Energy, 1978.
4. Amateur Battery Radio Receivers. Moscow, MRB, Gosenergoizdat, 1950.
5. Troickiy L. V. Circuits of Amateur Receivers. Moscow, MRB, Gosenergoizdat, 1956.

73! I.G.



<http://urgrp.iatp.org.ua/>



<http://www.antentop.bel.ru/>

ATU

SOMETHING ABOUT ANTENNA TUNING UNITS

*By Igor Grigorov, RK3ZK
antentop@mail.ru*

What an ATU does?

You should not think that an Antenna Tuning Unit (ATU) is a magic thing to do any antenna work well with your transceiver. At installation between the transmitter and feeder the ATU only does matching of output impedance of your transmitter with input impedance of your antenna - feeder system. It means that ATU allows to the transmitter with output of 50 Ohm to work normally with antenna plus feeder having any input impedance. But probably SWR would be enough high in the feeder. If the ATU is installed between antenna and feeder it does low SWR in feeder and provides good operation for the transmitter. But probably the antenna would work not in good way.

So, an ATU provides safe operation for transmitters end stage, if the ATU is between the transmitter and the feeder, additionally an ATU does low SWR in

feeder, if the ATU is installed between antenna and feeder.

As usual modern transceivers and military equipment have inner ATU that does matching end stage with feeder or antenna. Below we take close look to ATU design.

ATU Design

Fig. 1 shows schematic of a “classical” ATU. Such ATU has:

- a Matching Unit, that provides the matching of end stage of the transmitter with antenna - feeder system. Matching Unit is the “heart” of any ATU;
- A SWR meter or HF-bridge, that shows how the matching is done;

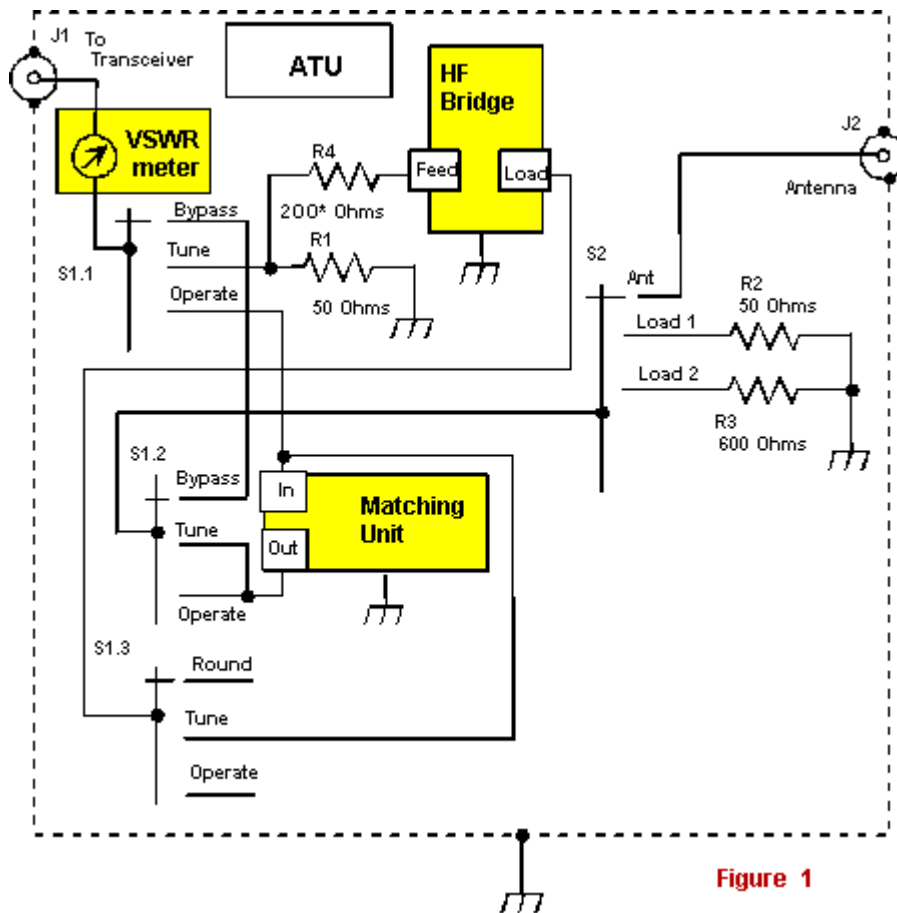

Figure 1

- Dummy loads R1, R2 and R3, that help us to monitor how Matching Unit and SWR – meter (HF-bridge) do work;
- S1 and S2 for proper connection of the above mentioned parts;
- J1 and J2 for transmitter and antenna connection.

So, how the ATU does work?

S1 at “Bypass” position does connection of the transmitter to S2. S2 does connection or to antenna, or to Dummy Loads R2 (50 Ohms) or R3 (600 Ohms). So, at good 50-Ohms antenna the transmitter works straight on the antenna, also is possibility to load the transmitter on 50-Ohms Dummy Load for a tuning of the transmitter or checking of the SWR- meter.

S1 at “Tune” position does connection of the transmitter through inner HF-bridge and Matching Unit to S2. So, it is possible to tune the Matching Unit or on to real antenna (S2 in position Ant) or check how the Matching Unit can tune to 50-Ohms (S2 in position Load 1) or 600-Ohms (S2 in position Load 2) load. When you have your antenna tuned, switch S1 in position “Operate” and just work in the ether.

You can see, it is possible to use or SWR- meter or HF-bridge for tuning the MU on to real load.

As it is visible from this scheme the degree of the matching of the transmitter with used antenna depends only on used Matching Unit. Let’s see what our Matching Unit can contain.

Classical Matching Unit

One of most effective Matching Units is shown on **Fig. 2**. This scheme was widely used by the radio amateurs from early 30s till recently days. As it is visible from **Fig. 2**, the end stage of the transmitter is connected through coupling coil L1 and coupling capacitor C1. L2 and C2 is tuned to resonance to input signal. C3 does coupling with the load (antenna).

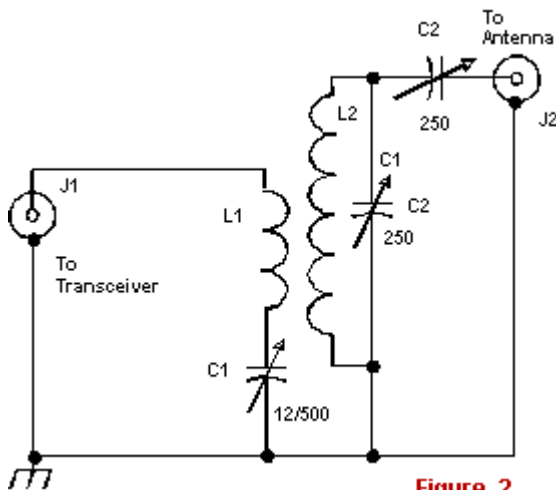

Figure 2

As usual, L1 has from 1/4 to 1/6 from amount of turns of L2. L1 is wound in lower part of L2. L1 should be unbound from L2 by any qualitative isolation. In some designs of the MU, L1 is isolated by means of air. The transmitter is coupled to the antenna only by magnetic field, so the end stage of the transmitter is protected from a lightning. Resonance circuit kills harmonics. The Classical Matching Unit does well match a load from 10 to 1000 Ohms with end stage of transmitter in 50 or 75-Ohm impedance.

C1 should have maximum of capacity up to 1500-pF at operation through 1,8- 28 MHz, and 500-pF would be enough for operation through 3.5- 28 MHz. If L1 has optimal number of turns the C1 is not necessary at all. C2 and C3 should have the greatest possible clearance between their plates.

At constant parameters of L1 and L2 the Classical Matching Unit works with high efficiency only in two multiple amateur HF - ranges, for example, 1,8 and 3,5 MHz, 7 and 14 MHz and so on. At others ranges efficiency is dropped. Old Classical Matching Unit had plug-in coils for all amateur range for keeping the efficiency at high level. L2 should be placed as far as possible from metal walls of the cabinet of the ATU.

To tune the MU is very simple. At first, C1 has the maximum capacity, C2 and C3 have minimum capacity. Then, with help of C2 do tune resonance circuit L2C2 in the resonance to working frequency, then C3 does optima matching with the antenna. After that once more time do tuning C2 and C1. It is necessary to say, that after final tuning of the MU C3 has to have the greatest capacity as it is possible.

Advantages of the MU are following. It does not require too careful manufacture of L1 and L2. The system ensures high efficiency, up to 80 percents. Tuning is done with two capacitors C2 and C3. The lacks are that for high efficiency in the matching unit it is necessary to use one spool to two multiple ranges, and one variable capacitor insulated from case of an ATU.

Classical Matching Unit with a symmetrical output

Recently symmetrical antennas with a symmetrical feeder are applied seldom, but some decades ago it was a usual matter. Classical Matching Unit with symmetrical output is shown on **Fig. 3**. In scheme shown in **Fig. 3** a RF- voltage for antenna - feeder system is removed symmetrically from both ends of L2, and it is only difference from the scheme shown in **Fig. 2**. In practical design L1 should be disposed symmetrically concerning resonance spool L2. Twins capacitors C2.1 and C2.2 should have one axe. It is as well as to C3.1 and C3.2.

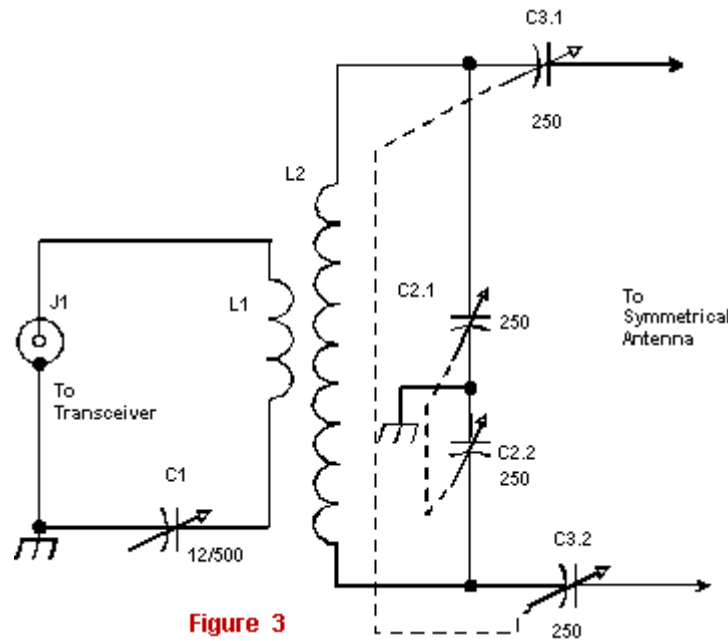

Figure 3

Classical Matching Unit with taps

You can see that C3 is isolated from metal cabinet of the ATU. It is not convenient for practical design of an ATU, so amateurs often use Classical Matching Unit with taps.

Fig. 4 shows such MU with asymmetrical output, Fig. 5 shows Classical Matching Unit with taps with symmetrical output. These schemes (Fig. 4 and 5) cannot give such careful matching, as shown in Fig. 2 or Fig. 3 have provided. But in case if it is need to minimize dimensions of an ATU the schemes can be used.

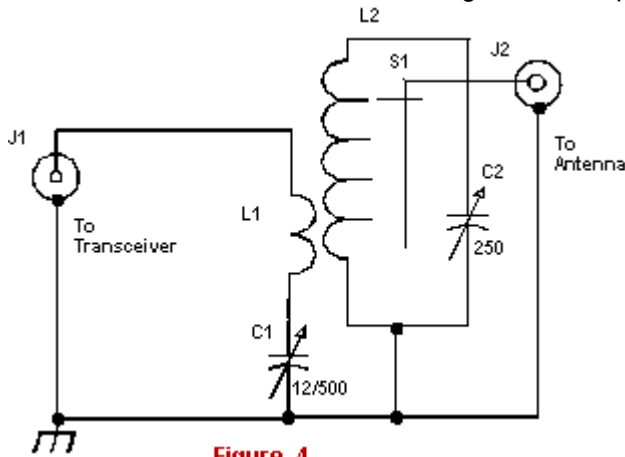

Figure 4

Multi-range Matching Unit with taps

So, if you want to build an ATU having minimum sizes and parts try the schematic shown in Fig. 6. However, the Matching Unit has not high efficiency at upper amateur ranges because of lowering of the Q-factor of L2 and because of not optimal selection of taps from L2. But usage of such simplified multi-range Matching Unit at amateur HF - ranges 1,8-10-MHz is quite acceptable.

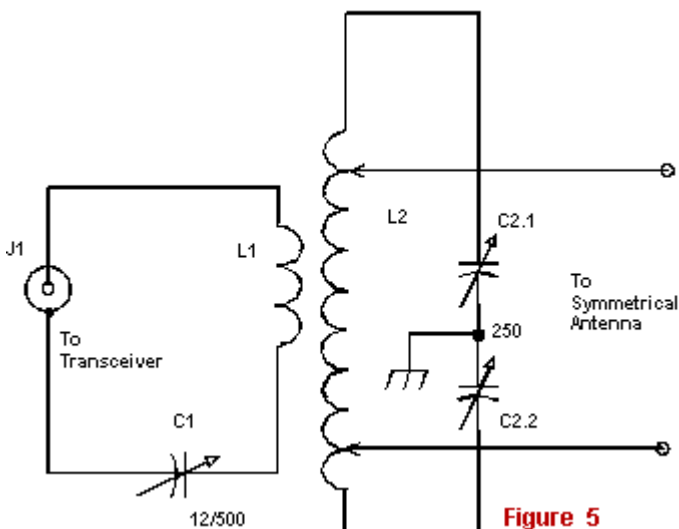

Figure 5

T - Matching Unit

Classical Matching Unit is very effective in the work. However, among radio amateurs and military T-Matching Unit has more popularity then one shown in Fig. 2. It takes place because T-Matching Unit have high efficiency at very wide frequency ranges and T-Matching Unit allows to do easy automatic tuning (that very likely to the military!). Also, T-Matching Unit works very well with for asymmetrical coaxial cables feeding modern antennas. Fig. 7 shows schematic of T-Matching Unit. The MU has rather good parameters. It is possible to do matching a 50-Ohms transmitter to 10- 1000-Ohms antenna. It is possible overlap all HF- amateur bands from 3,5 up to 30 MHz using only one variable inductor at 0.5-30-µH and two variable capacitor at 10- 250-pF. The MU does matching at 1.8-MHz if to bridge C1 and C2 to connect fixed capacitors at 200-pF.

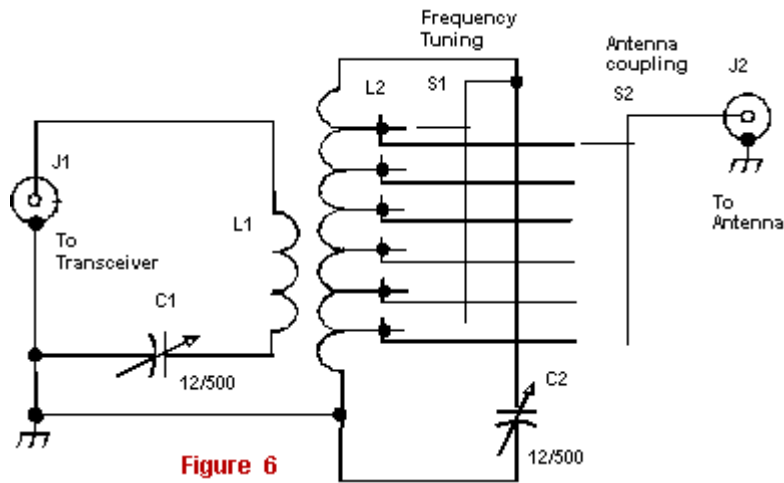

Figure 6

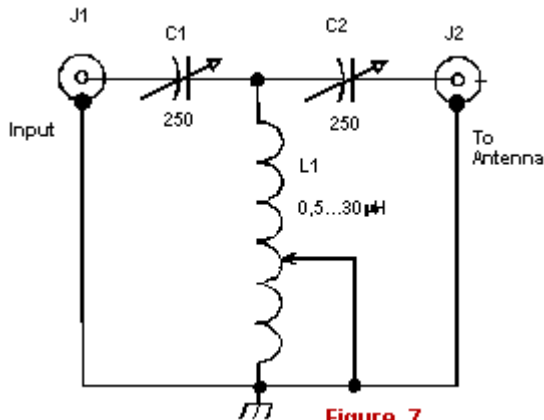

Figure 7

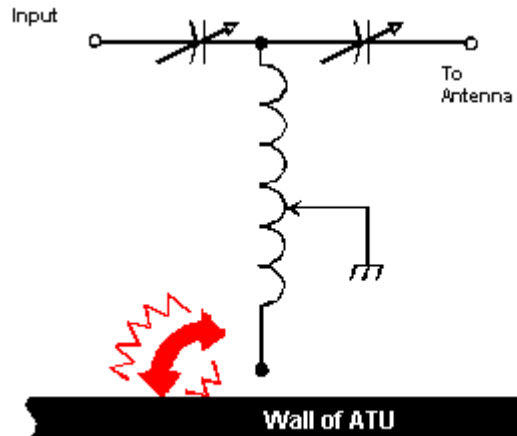

Figure 8

The “cold” end of L1 should be grounded or isolated carefully from the metal case of ATU. Otherwise you probably will have strong arc between the ungrounded end of L1 and a wall of the ATU, as it is shown in Fig. 8. C1 and C2 should be very qualitative with aerial or vacuum dielectric. The clearance between plates of capacitors should be not less than 2-mm/ to 200-W bypass power. Stray capacitance of C1 and C2 to the metal case of ATU should be no more than 25-pF, otherwise the efficiency at 24-28-MHz drop.

Figure 8 Arcing inductor

If you want to connect symmetrical antennas feeding through symmetrical ladder lines to the T- Matching Unit, use symmetrical transformer 1:4 or 1:6. BTW, many of symmetrical antennas, feeding through ladder lines have large reactive component, which bad to transformation by simple transformers 1:4 or 1:6. The T - Matching Unit suppress harmonics up to 10-15 dB.

T - Matching Unit with a “digital” inductor

L1 has to have slide contact to operate the MU in proper way. Sometimes, even extra half of a turn influences to the matching. It restricts usage of an inductor with taps, or demands personal selection taps for real antenna, that certainly, restricts possibilities “tap” MU. Simple decision on this problem by W3TS made, he offered a “digital” inductor that Fig. 9 shows. Really, it is possible with the help of several switches very fine to tune needed inductance. Electronic relays with special chips allow realize automatic ATU. Military also use the method at their automatic ATU.

T - Matching Unit with mirror parts

For practical design of any ATU it is not conveniently to have two capacitors insulated from the ground. AEA corporation (USA) does the MU as Fig. 10 shows. You can see that they changed C to L. Really, schemes of MU figured in Fig. 7 and Fig. 10 are equivalent.

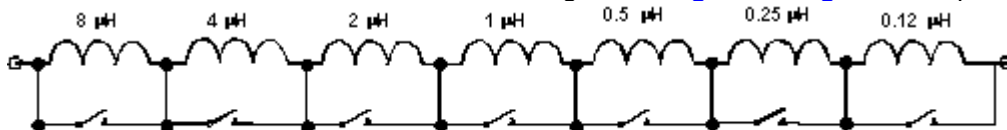

Figure 9

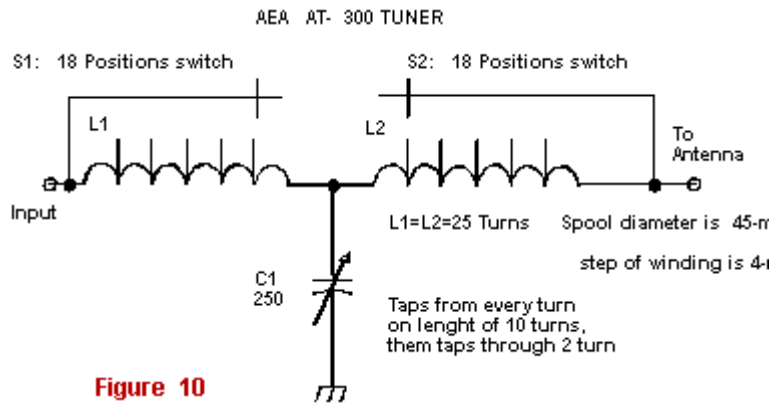

Figure 10

But scheme in Fig. 10 has advantages. At first, it is much easier to use only one grounded high-quality capacitor instead of two ones but insulated from metal cabinet. Secondly, it is wise to substitute expensive inductor with slide control to two cheapie spools with taps.

The MU made by me at home conditions worked well on all amateur ranges from 1,8 up to 30 MHz and did

matching to 50-Ohms transmitter to antenna with resistance from 15 up to 500-Ohms.

The inductors were made as Fig. 11 shows. Form of inductors is made of PC – board with slots for turns. On the plate switch for taps is installed. The plate is disposed not in center of the inductor but little sideways as Fig. 12 shows.

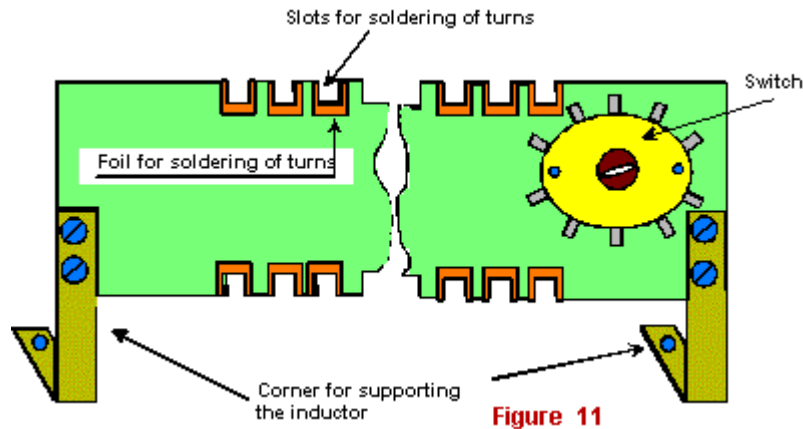

Figure 11

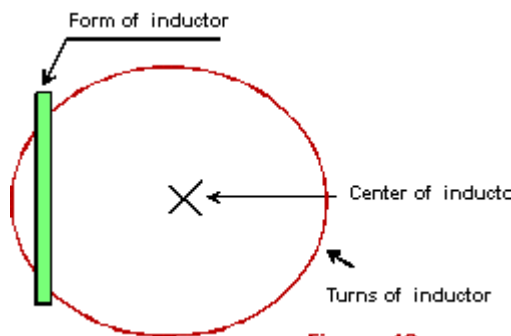

Figure 12

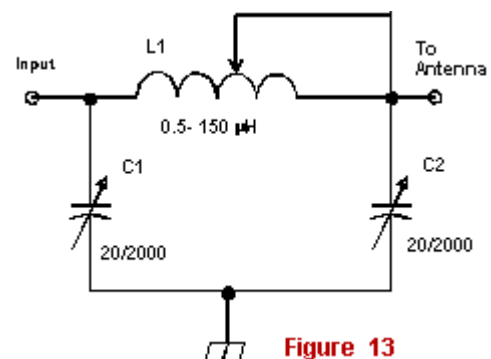

Figure 13

Pi- Matching Unit

Pi - MU is used in radio amateur practice for a long time. It is possible to find Pi - MU and disputes on this subject at radio amateur journals issued on 20s of the 20 century till our time in the Internet. Fig. 13 shows Pi- MU. As usual Pi – MU is used at inner MU at tube and transistor PA or straight at antenna clips..

Pi – MU seldom is used at separate ATU. For matching in a wide frequency ranges loads with resistance 10-1000- Ohms it need to change C and L at Pi – MU too greatly. So, it is impossible to do universal Pi – MU.

It is desirable to use slider inductor because. In case if an inductor with fixed taps is used you can carefully to select the tap for real antenna.

L- Matching Unit

Fig. 14 shows L- MU. This one is a simplified version of Pi – MU. ATU, keeping L- MU often is used for operation with simple tube and transistor transceivers and for matching simple multi- range antennas, which do not contain large reactive component.

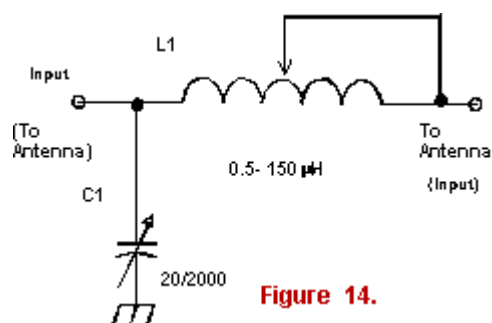

Figure 14.

Parts for the ATU

The data of spools for the MU exhibited on Fig. 2 are shown in Tab. 1, for the MU exhibited on Fig. 3 are shown in Tab. 2.

Table 1 Data for MU exhibited on Fig. 2

Frequency band, MHz	1,9	3,5-3,8	7	10	18	14	21	24	27-30
Diameter of spool, mm	50	30	25	25	25	25	25	25	25
Length of winding, mm	50	30	40	40	40	40	30	30	30
Number of turns	100	30	20	15	10	11,5	8,5	7,5	6,5

Table 2 Data for MU exhibited on Fig. 3

Frequency band, MHz	1,9	3,5-3,8	7	10	14	18	21	24	27-30
Diameter of spool, mm	50	40	25	25	25	25	25	25	25
Length of winding, mm	60	40	40	50	40	40	40	40	35
Number of turns, n	130	35	28	20	15	11,5	11	9,5	8,5

Tab. 3 Data for digital inductor shown in Fig. 9

Inductance, μH	8	4	2	1	0,5	0,25	0,12
Diameter of spool, mm	30	20	20	20	25	10	10
Length of winding, mm	30	20	25	20	20	10	10
Number of turns, mm	20	18	12	8,5	5	6	4

It is possible to use for T –MU any variometer, which is possible to get. Variometer has to have maximum inductance not less than 30-μH and minimum close to zero. If the maximum of the inductance of the variometer is less, for expansion of frequency range of the ATU to include in serial with the variometer a fixed inductor. If the minimum inductance of the variometer does not reach zero, it is essentially cut off the upper range of operation of the ATU.

The design data for spools for digital inductor shown on Fig. 9 are shown in Tab. 3. Significant RF-currents flow through parts of MU - capacitors, inductors, and switches. So all of the parts should be qualitative.

73! I.G.

RADIO WAVE PROPAGATION

LDE, another look to inexplicable effect by Igor Grigorov, RK3ZK



Sometimes we receive strange radio signals delayed compare to sent radio signals. The delaying time may take up to 30 minutes! We do not know yet, where the signals travel in the delaying time. Modern experiments confirm LDE, and scientists keep silence about the inexplicable effect. (More about LDE- just click GOOGLE. Subject LDE)Only supporters of UFO respond to it confidently...

Aliens do LDE! - they say

The following hypothesis was put forward and scientifically proved by professor Ronald Bracewell (see his photo) at Stanford University, the USA, and astronomer Duncan Lunan from Scotland [1]. Having put on axes XY the force of the received in 1927 echo of the signal and its time delay, they detected, that the obtained picture reminds the constellation of Bootis visible from the Earth, though with small distortions. (Constellation of Bootis is shown at photo Bootis) They calculated that the shape the constellation is exhibited in the graph, was visible from the Earth 12,000 years back.

Professor Ronald Bracewell

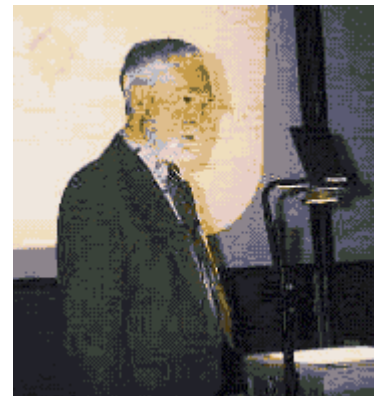

Constellation Bootis

On this graph the aster Epsilon from this constellation Bootis was particularly prominent. These scientists consider that from one of planets of the aster Epsilon (Bootis) 12.000 years ago an interplanetary probe was sent. Having flown up to the Earth and having defined, that on this planet there was a life, it occupied a place in space on elliptic orbit equidistant from the Earth and Moon. Italian - French mathematician Josef Lagrange earlier mathematically justified the possibility of existence of such an orbit [2]. In his name this orbit was called Lagrange orbit, on which the alien space station is supposed to be.

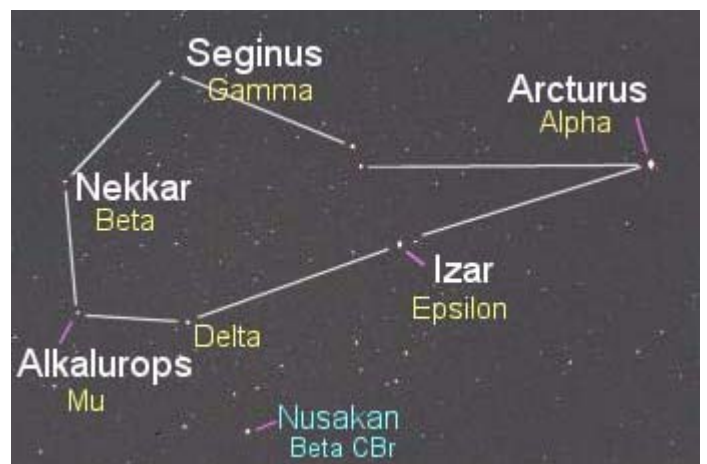

As soon as this alien space station received the first narrow-band radio signals from the Earth, it began to relay them back to the Earth with the coding about the probe. The examination of other known delayed signals allowed the scientists to clarify some other surprising things.

With flow of time the supporters of this theory of LDE origin researched almost all known LDEs. Taking into consideration the time delay and the force of reception of delaying radio signals they attempted to

find some regularity, and from here to find the useful coded information which is kept in the time delay. They attempted to detect this interplanetary probe, using modern means of space observation.

CHAPTER 5: R.W. PROPAGATION

But meanwhile this version (as well as however some others, less fancy) remains unproved, and it exists only in the circle of the supporters of UFO. By means of space observation devices this probe wasn't detected. (Well, one my friend told me, that a Soviet Far -Space Radio Location Station detected the probe at Lagrange orbit, but I do not find prove for the information...) It is impossible to warrant that the regularity which is in the time delay and the force of LDE signals was also found. Certainly, this version with an interplanetary probe cannot be eliminated from consideration, as it was not confuted.

But nevertheless it is interesting if the aliens could not find any other way of attracting our attention to tell us about themselves, as only by relaying delayed in time and different in force radio signals of the earth radios...

Modern researches confirm LDE

R.J. Vidmar and F.W. Crawford at Stanford University, the USA confirmed the presence LDE, but they conclude that we still do not know which of the known mechanisms are valid for LDE. It is or pointed to presence of any natural phenomena promoting LDE and still unknown to us, or ... or gives scores in hands of supporters of extraterrestrial reason of LDE...

Till now LDE is puzzle

Well, in all times it was characteristic for mankind to ascribe supernatural forces to some phenomena, which were not explained by natural forces. We know, ancient Greek believed that the Gods made rains, lightning, a convulsion of volcano.

Concerning to our time, mankind believe that some puzzle things produced by space intelligence and UFO...



www.antentop.bel.ru

Aliens do LDE!

May be the probe looks like this one...



Greek god Zeus



Concerning to our time, mankind believe that some puzzle things produced by space intelligence and UFO...

But in due course many of these before mysterious and inexplicable phenomena were explained by quite earthly laws.

I believe, that in the future it will be possible to explain this mysterious phenomenon, and in tutorials on Radio Propagation the phenomenon will be described without any mysticism only using strict formulas. Perhaps in the future today's schoolboys will be able to do it. The main thing is not to be afraid any mysterious and inexplicable phenomena and to investigate them bravely.

References:

1. www.et.presence.ndirect.co.uk
2. www.ufos.about.com/mbody.htm

Einstein Wave or just LDE

by Igor Grigorov, VA3ZNW

antentop@antentop.org

Talking on an origin and on just existence of LDE go till the recent times. Yes, even just about existence of the LDE. Some scientists persistently do not recognize the existence of LDE and deny obvious authentic facts of reception LDE by many people. I do not know, why these scientists deny the obvious facts, may be because they can not explain this phenomenon. For the scientist if while it is impossible to explain something, if the something is not in frames of the laws existing in the modern science, the something can not exist.

However, lots of people, who do not know that LDE does not exist, have received LDE. After that they ask the scientist to explain the phenomenon, but the scientists tell them: LDE can not be exist...

I want to tell about my first receiving LDE. It was in the spring 1982, when I was studied at Kharkov Institute of Radio and Electronics. When I came in student hostel after my day study, I usually turned on my HF receiver, which was already tuned to BBC station that did broadcasting at 19 meter band. I used an old military receiver R- 311. In one of spring days, when I had switched on the receiver, I heard weak signs of another station on the background of BBC. BBC went to fading after several minutes however unknown weak signs went to strength and while some

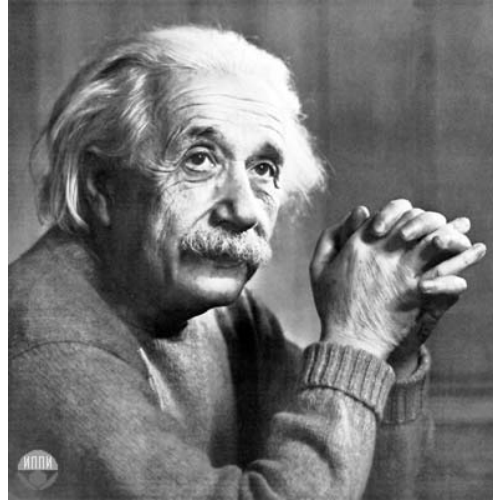

Albert Einstein
(1879- 1955)

times they were louder then BBC. To my surprise the unknown station was also BBC but the signs of the unknown station were delayed on several minutes compared the BBC station. It was LDE!

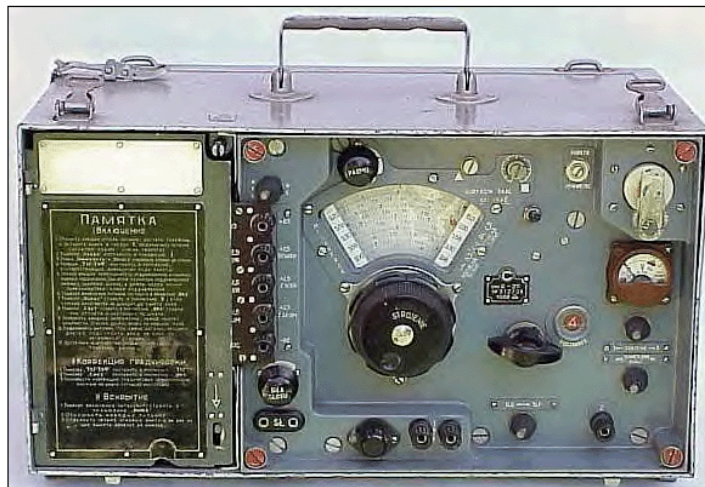

Military USSR's receiver R- 311

CHAPTER 5: R.W. PROPAGATION

Both BBC and its LDE were fading. Often LDE was considerably loudly than the real BBC. I had received LDE near 5- 10 minutes (I did not see at my watch). LDE was gone so sharply, as if was switched off. Just now I received two signals from BBC and LDE but through a second I received only one BBC. What was an interesting there was no interference whistle between BBC and its LDE.

I asked lecturers of Kharkov Institute of Radio and Electronics about the phenomena however I had met with a wall of silence. I had been told that such phenomenon can not be, because it can not be at all. Later I had known that LDE was a closed theme in the Soviet Union. Certainly, no one lecturer did not take a risk to talk to a student on the closed theme of LDE.

Later I have read that LDE with the large time of a delay (from several minutes and more) usually is discretely, and exist a not long time. For example, LDE with delay more the several minutes exists 5- 10 minutes, then such long delay LDE is disappeared. Again it can be appeared only through some time, for example, 10- 20 minutes. LDE with a small time delay, near 1-3 seconds, can exist long time, may be 20- 30 minutes. After the small time LDE is disappeared it can be appeared again through several minutes.

As we know recently there is not any scientific explanation of the LDE.

I would like to offer mine version of an origin the LDE. The version does not break the laws of modern science. This version is based on the Einstein's Theory of Relativity. Further I try to bound up LDE with the Theory of Relativity.

For my explanation of the origin LDE I am based on the Clock Paradox or Twin Paradox. If you do not know what is it Clock Paradox or Twins Paradox, please, use an internet search engine. Any search engine gives you lots link relative to the phrases.

Here I give a very simplified description of these paradoxes. If an object 2 moves with speed close to speed of light compared to an object 1, time at the object 1 goes faster then the time at the object 2. The clock installed on the object 1 shows hours however the clock installed on the object 2 shows minutes. It is so-called Clock Paradox. If one twin is on object 1 and another twin is on object 2, at their meeting it appears, that the second twin (from object 2) is younger than the twin who is on object 1. It is so-called Twins Paradox. **Fig. 1** illustrates the situation.

Einstein Wave or just LDE



Kharkov Institute of Radio and Electronics



LDE was forbidden in the USSR

A question 1, what is light. Till now scientists argue, is light waves or corpuscles. Experiments are confirmed that light has dual nature. In one experiment the light looks like waves. In another experiment light has corpuscles nature. However, if light, that is electromagnetic radiation, can have dual nature, why radio wave, that also is electromagnetic radiation, can not have such dual nature? Of course it can be!

After question 1, question 2. What will be, if compare an observer, who is on the Earth, corpuscles move with speed close to speed of light. May be for us it sounds strange however clock at the man, observing flight of these corpuscles, counts minutes, while the clock located at these corpuscles counts only seconds. The Paradox of Clock works in this case.

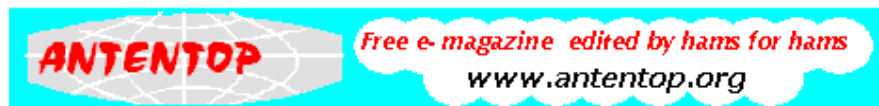

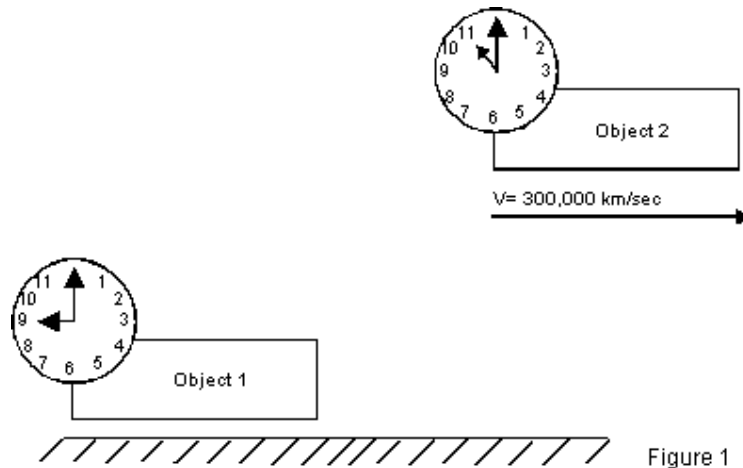

Figure 1

Now we look to the next matter. A radio transmitter works at point A on the Earth. The radio wave from the transmitter comes in point B with a small delay T. Delay T is equal to distance L, which this wave has come, divided on speed of the radio wave (300.000/km/sec), see Fig. 2. Imagine if the radio wave, at presence of some conditions, is propagated also as corpuscles.

Or, radio wave turns in corpuscles, is distributed by corpuscles, which have speed close to speed of light, then the corpuscles again turns in usual radio wave. Let's name this **corpuscle wave** 'Einstein wave'. Let's see to Clock Paradox. Minutes have passed for the observer, who is at point B, but only seconds have passed for Einstein wave.

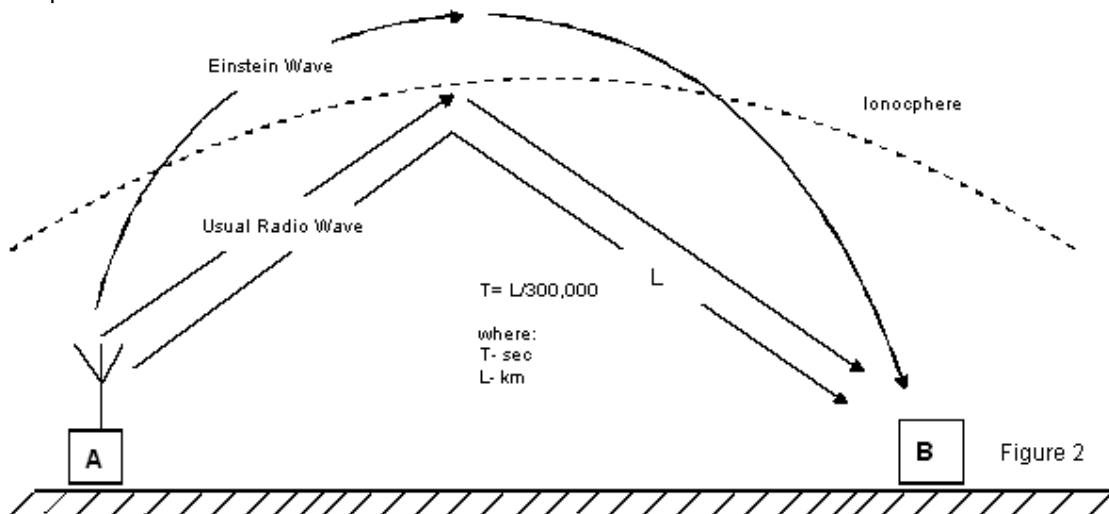
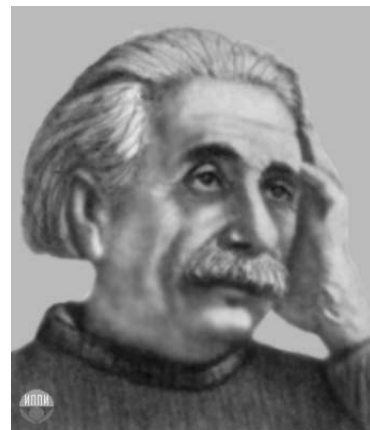

Figure 2

In other words, observer, who is at point B, at first has received an usual radio wave and at second, while some time, has received Einstein wave, that contain the same information that the usual radio wave, that is already received. The delay time can be in millions times more the normal time of propagation of the radio wave.

So, at certain conditions, the observer can receive both a usual radio wave together with its LDE. However, what are the conditions, when radio wave turns to Einstein wave and back to radio wave? It is not known.

Certainly, it only my version LDE, and it is only a version, which does not apply to be true. It is necessary to say, that the Einstein wave sets lots questions. May be more then LDE... **73! I. G.**



Albert Einstein

Nonlinear Propagation of Radio- Wave in Ionosphere

Igor Grigorov, VA3ZNW

E-mail: antentop@antentop.org

There are a lot of interesting phenomena at ionosphere propagation of radio-wave (for example, remember LDE!). One of such phenomenon is **nonlinear propagation of radio- wave in ionosphere**. What is it this effect? A very exactly description of the phenomenon was given by Vladislav, RX3ALL, at a message sent by him in the RU- QRP- C forum on December 19, 2005.

(Below the message is given with some cuttings)

--It was an interesting propagation yesterday night on 20 meters. I turned on my transceiver approximately at 19-30 UTC (22-30 local time). Nobody was at the band. Suddenly I heard a very loud station, it was an Ukrainian ham station/MM, it keyed on CQ.

I give my call/QRP with 5-watts running by my IC-718. Only "QRZ?" I have received. After several unsuccessful attempts to do QSO I increase my power to 10 watts. The Ukrainian station, operator Gene, gave me 599...

A vessel, whence the Ukrainian station has been worked, was at the Atlantic Ocean. Distance between our stations was approximately 7500 kms. I sent CQ near (on frequency) the Ukrainian station, and, in several minutes one station from Argentina called me, after the QSO, another station from Argentina called me! (All calls are in my log.)

BUT! The stations did not hear me on 5 watts, however when I run 10 watts, I have received 579 and 589.



Station **UA3ZNW** at middle 1980s.

Left corner: CW Transceiver and PA for 160, 80, 40, 20

Right corner: PSU 0-16 VDC, 0- 24 VDC, 250- 500 VDC, 6.3 VAC, 12.6 VAC

Receiver for 10 meters

Center: Automatic key, transmitter for 10 meters, receiver for 160, 80, 40 and 20 meters.

AM transmitter for 160 meters.

All equipment are home brew

About 21-00 UTC I worked with Uruguay, CV5D, operator Lu. The same story, at 5 watts no QSO, at 10 watts 579.

After 21-00 UTC the 20 meters band was closed.

Regards, Vladislav, RX3ALL 72!--

Vladislav met with a very interesting phenomenon, which is named (by me) **nonlinear propagation of radio- wave in ionosphere**. The phenomenon is, that at some small power (say 5 watts, as Vladislav had) it is impossible to do a QSO, nobody answers, however, if the power is a little increased (say to 10 watts, as Vladislav did), the QSO is going on 59. As a rule, this phenomenon is observed at DX QSO, if the distant is more than 2000 kms.

I have noticed this phenomenon in 1980s. At the times I had ham call **UA3ZNV** and I often sent CQ at 10 meters using a home brew transistor AM transmitter. 12 Volts from a PSU with manually variable voltage was going to the PA of the transmitter, and I had 3-watts RF power.

So, at the times I have met the same phenomenon as Vladislav met at 2005. When 12 Volts feed the PA, nobody answers, BUT, when 16 Volts feed the PA, I have received 59 from far stations. My transmitter runs 5 watts when 16 volts were across PA. So, it impossible explain, why at 3 watts G4HQR, but at 5 watts – '59.' Usual theory of radio- propagation has no answer on the question.

I have noticed one more interesting effect of **nonlinear propagation of radio- wave in ionosphere**. It is possible to name this phenomenon as a **trigger effect**. The phenomenon is that at some small power (say 1 watt) nobody answers. However if the power is a little increased (say to 2 watts) you have received 59. Then power decreased (say, again to 1 watt) but anyway you have received 59 from your correspondent.

At first I noticed trigger effect at 10 meters band. Since an RF transistor of my PA was overheated at 16 volts, I worried, that it would go out of operation during QSO. In 1980s the RF power transistor costs pretty penny. So, I called my correspondent when my PA was fed by 16 volts, after that reduced voltage to 12 volts, and made QSO. As a rule, the QSO was completely done. The truth, sometimes during QSO my signs were ceased, then I again increased the voltage to 16 volts for a while.

A power radio station located in my city also could be the cause of the trigger effect. For example, I for a long time call DX station, no answer, then power station from my city have made QSO with the DX, after that the DX gives me 59. Such phenomenon often is observed by me in contents, when I try QRP. I call for a long time a far station, no answer, then a powerful station has made QSO with the DX. That is all, the DX gives me 599.

At first I thought that these strange things are only on 10 meters. But then I observed the phenomena on others amateur HF bands, from 160 up to 10 meters. The truth, on the 10 meters these phenomena are more sharply than on low-frequency HF ranges. Lots of hams and professionals also are familiar with the strange phenomena. My attempts to find a science explanation to these interesting phenomena are failed.

Professionals and scientists in personal talking about the phenomena sad me, that it is a whim of propagation or lack of my antenna or lack of the receiver of my correspondent. May be... But by me this effect was marked at various receivers, both self-made and professional, at different antennas, on diverse bands, and at stable (for the time) propagation...

... It seems to me this riddle is still unsolved ...

73/72! I.G.

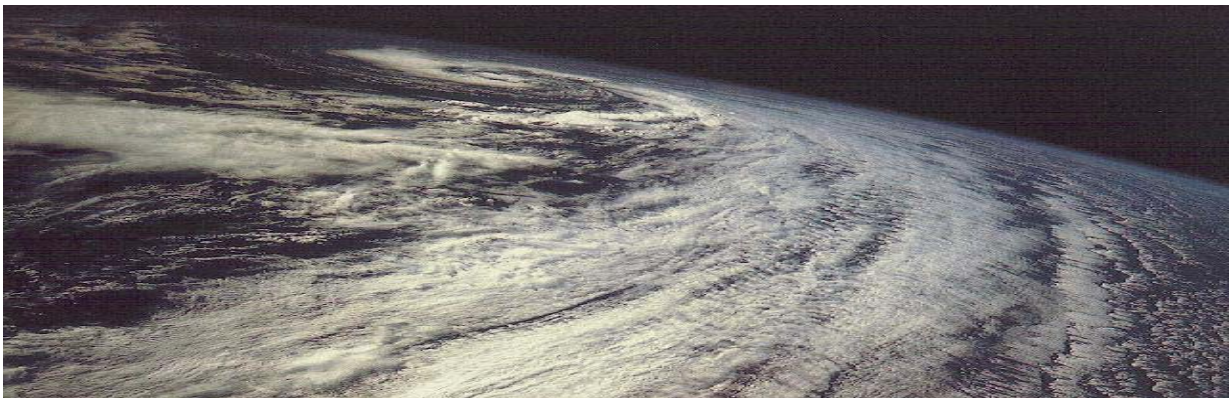

Black holes in the Air

Sergey A. Kovalev, USONE, <mailto:us0ne@vinnitsa.com>

USONE

In the beginning I shall quote Igor Bunich's book "Fuhrer's Pirates". The book describes one strange event, which was while a campaign of German raider "Atlantis" at the end of August, 1941:

" Have been going on the edge of pack- ice of Antarctica "Atlantis" has rounded New Zealand and was going to Kermadec islands, that are in seven hundred miles to the north... skip ... Has passed Antipodes islands, "Atlantis" faced with a strange effect. The ship went in mysterious zone, where ship radio was dead on the all bands. It seemed, all radio world has died out. Even atmospheric static interferences were no present. "Atlantis" has passed almost two hundred miles while the external world gave notice by a radio station from Australia."

I give the quota because I was in the same citation. There was in August, 1989, when I served in an air base "Chindan" near forgotten village Borzay, the Chita region, Russia.

In one of the August days, I come home for dinner (at 13-14 local time), and I decided to listen my receiver **R- 309**. The receiver work fine from 1 to 36 MHz. It was inexplicably for me, but I found out, that there is not any reception! I did not hear even crashes of static. Wow, I turn on my TV "Vesna- 326", also absolutely nothing! Well, nearly one hour have passed, when very weak reception began to appear.

I can not find any explanations for the effect.

By the way, in that day, when I observed the strange effect, the sky had unusually yellowish color. At that time for myself I have explained it, by that probably, in desert of Gobi (Mongolia - China), there was a powerful dusty storm.

Dust was deserted in average layers of the Earth atmosphere. Borzay is in 20 kms from border with Mongolia. But there is the question, why there was no propagation of surface radio waves? I did not hear LW, MW and VHF- TV!

Yours faithfully, Sergey A. Kovalev - USONE

On the next pages there are pasted some facts about the phenomena, collected by Sergey, USONE



Sergey on air base "Chindan", near forgotten village Borzay



R-309



CHAPTER 5: R.W. PROPAGATION

Michael RW6AT:

I faced with the phenomena. It was in the spring 2001, at 12 o'clock in the afternoon, after a strong magnetic storm. All bands, HF and VHF were dead. I even did not hear local VHF station with 50 watts, located near 5 kilometers from me...

Igor UT5UCY:

The similar effect I observed in the summer 1978. One of days of the test (I do not remember what the test was - if it will be interesting I can see old logs) I met with absolutely absence of radio propagation on all bands. I checked my equipment- it was all right... I did not understand, what happened and switched off my equipment. All worked well in another day....

Stanislav UA9XP:

In February 1961, approximately at 22 o'clock, a QSO on 10-M band with my friend, living from me at distance of 350-400meters, failed. Such impression, that our **radio stations A-7B**, failed. But in forty minutes the communication was restored. In the time we saw **northern lights**.

Andrey, RW9WA:

Ten years back I observed similar phenomena in CQ WW SSB. There was very fine propagation, I called a KN6 station, and when I turned to reception - was a death silence in the ether... I checked antennas, transceiver, coaxial cables. Then I made a call to my friend in my town, UW9WW. He also heard nothing, and also disassembled his transceiver! A hour later, static interferences and a very weak reception began to appear.

George UY5XE:

Antipodes islands (IOTA - ZL-f) probably, for the given reasons, till now are a NEW ONE!

Nikolay UT2UZ:

Such failure in radio propagation is very rare, but it happens. About half-year back (2001 year) I faced with full closing at all ranges while forty minutes. May be unusually big solar flash destroyed reflecting layer in ionosphere...

Black holes in the ether

Michael RW6AT



Михаил RW6AT

Northern lights



Radio station A-7B



And very interesting message is on the next page.
Go to the page!

The info was published at:
www.qrz.ru

Great site with great info for hams
(well, in Russian....)

www.qrz.ru



CHAPTER 5: R.W. PROPAGATION

Pavel, UA1CBX <http://north-pole.narod.ru/>

I was a polar radio operator for four polar expeditions. So, I of course met with very strange effects at propagation of radio waves. The closer to geomagnetic poles of the Earth, the more often it happens. HF propagation is almost absence in the winter near the pole. Only very rare stations you can hear there. Especially it is at the northern lights. I often met with an one sided propagation, when I received lots station with 59++, but nobody hear me.

Very interesting event was with me and with Ivan Zhukov. He worked from plane IL-14 on 20-M band on the way to our polar station. There was great pile-up, but I heard nothing. But when the plane lowered to 2 kilometers above ice, Ivan sad, that his radio dead! Our scientist from the polar station did not found any explanation for the effect. Well, I met and with others, very, very strange phenomenon at propagation of radio waves....



Ivan Zhukov faced with the effect on a plane!



Black holes in the ether

Pavel, UA1CBX, near the North Pole



*Soviet Polar station
North Pole – 27, radio shack*



White Bear do not know about hams...



Do you faced with the effect?

Write us about it!

EARTH ACUPUNCTURE

Feedback on one problem...

In 2001 year I have sent a short message to Ukraine ham forum at KPC WebSite (www.krs.poltava.ua), and the message was published in QUA-UARL #46 in that 2001 year. Below I retell the message in few words.

"I think, that our planet, the Earth, has specific spots, which are almost identically to acupuncture spots placed on a human body. I called them "White Spots", "Black Spots" and "Inverse Spots". We have a good radio transmitting or receiving in White Spots, very bad radio transmitting or receiving in Black Spots, and we have some strange things in Inverse Spots." - I guess, that many of hams do not agree with me. They say, "The propagation of radio waves obeys only to known laws. Okey, I do not want to argue with the hams, I only want to show my FEEDBACK. But, before the FEEDBACK, I want to tell once more my observation of the unusual effect, called **EARTH ACUPUNCTURE**."

Igor Grigorov, RK3ZK

Victor Zinenco, the chief of the lab of check- out equipment from one of gas-distillation factory located near Oposhnya town, says:

I know such Spots!

White and black spots at the Poltava region

At September of 2002, I was at Oposhnya, the Poltava region, Ukraine. I met with my old friend Zinenco Victor. He showed me others examples of influence of White and Black spots to activity of radio electronic and mechanical equipment.

Within four years Victor works as the chief of the lab of check- out equipment of one of gas-distillation factory located near Oposhnya. The factory cleans gas and makes gasoline. His lab attends to serve equipment for measuring a gas pressure in gas tubes and for measuring gases volume, passing through the gas tubes. The equipment consists of electronic and mechanical parts.

Photo: Into Zinenco office (Victor and me) and workplace

Photo: Gas Torch near Oposhnya



CHAPTER 5: R.W. PROPAGATION

As Zinenco Victor said, identical equipment were used at all gas wells. The equipment tested thoroughly before their installation. However, in some time, strange things happened to the equipment. In some places the equipment worked reliably very long time. On others gas wells the equipment were broke soon. Interesting things, at some places only mechanical parts of the equipment were broke, at other places only electronic parts of the equipment were broke.

There are places, where both as electronic, as mechanical parts of the equipment were broke. Victor also noted, that the breakages of the equipment were bound to names of places, where the equipment were installed.

Name of a place is very close bound up to character of the place in the Poltava region. For example, there is a terrain with the name "Cool Hole". It is a shallow cavity, near 50 meters in the depth and near 3 kilometers in the diameter. The check-out equipment, installed at a gas-well placed in this terrain, often stopped to work.

A lot of places' names are connected to an evil spirit. There are such places as "Hag Well", "Devil's Ravine", and "Goblin's Forest". At water – wells, disposed at Hag Well, water periodically disappears and then appears again. Devil's Ravine is a pine forest where the pine doubled and tripled at their root. Goblin's Forest is a small forest disposed among small hills. However the natives do not go there because, in spite of the fact that the forest is small, it is very easy to lose the way in this forest. Natives do not recommend use mushrooms and berry from this forest for meals. Even good sorts of it may cause poisoning.

As Zinenco Victor said, equipment installed at gas-wells located at these "evil" places broke very often. Personal from the gas-wells frequently fall to sick.

Photo: Near village Light Windmill



EARTH ACUPUNCTURE

Another deal is with the gas-wells located in good-named places. There are such places as "Happy Village", "Green Village", "Light Windmill". Till now, there is an old wood windmill at the Light Windmill place. Equipment installed at the gas-wells located at these "happy" places work without breakages for a long time.

A lot of evil – named places were renamed for nothing speaking neutral names at the Soviet times. However, natives keep old names in their memory. Among themselves people named villages and places by the old names.

Tat'yana, the wife of my friend Victor, works at the historian museum of Oposhnya. She told me surprising national legends, bound with the names of the places. Her stories and data concerning breakages of equipment, installed in such strange places, assured me that Black and White Spots exist.

We do not know yet, how the strange places influence to electronic and mechanical equipment and also to the propagation of radio waves, but the influence is.

I had another interesting meeting in Oposhnya. I met with few native hams from the town. One of the oldest from them was Ivan Hrapach. His call sign is UTOHI, he is a radio amateur with the 30-year's experience.

He told me a lot of interesting and mysterious things about his activity in the ether from the Poltava region. His stories confirmed my assurance about Black and White places and about Inverse places also as my assurance that the Poltava region contains a lot of such places...

Welcome to Dikan'ka, a mystery place near Oposhny!



CHAPTER 5: R.W. PROPAGATION

And another story from **Alexandr Maxurov**, UA6LTO *Alexandr Maxurov, UA6LTO*, former chief of radio communication department of the *Vorkuta geophysical expedition*

“... Therefore it would be desirable to say some words in support of the idea about acupuncture of the Earth.

1. The theory of “acupuncture of the Earth” is not new, it has been discussed for a long time. Moreover, rather large experimental and factual stuff has been stored in some science departments...

2. Personally I accumulated rich data of this kind. They were stored by me throughout 1988 when I worked as a chief of radio communication department of the *Vorkuta geophysical expedition*. It was a very successful combination to study the problems of radio communication in polar tundra in connection with geophysical component. What a blessing it was that equipment for this purpose was quite good.

Seventeen *field batches* of *Vorkuta geophysical expedition* were scattered in terrain from Nar'yan - Mar up to Salekhard, the main base was in Vorkuta. Batches roam from place to place practically annually, therefore the research area was rather large.

The batches used a short wave radio for communication inside tundra and with the main base in Vorkuta.

But personally for me the question of a particular interest was to find out the relation between geophysical conditions, in which the field batch was, and the quality of a radio communication between “field” and “base”. The same equipment in the field batch- transceivers – “RSO -30”, “Polosa”, “Groza”, “Almaz”, “Angara”, “Carat” (all of them Russian made) and the same antennas behaved completely differently when a field batch moved to a new place.

Transceiver Groza

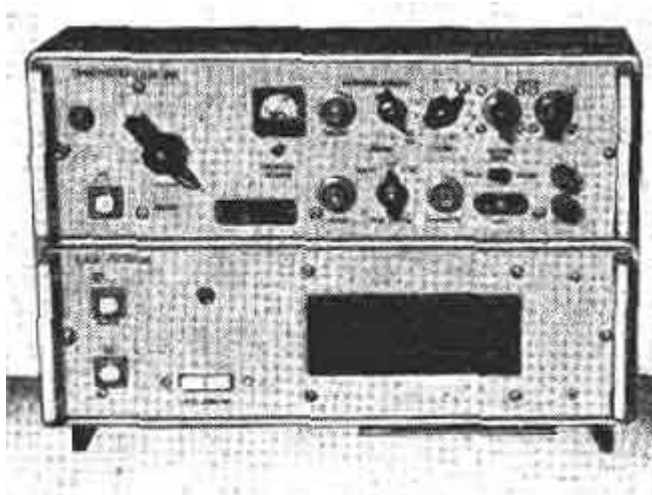

EARTH ACUPUNCTURE

There were also tragedies: the topographers, working around a field batch in radius up to 10 kms and equipped with a hand held HF transceiver “Carat”, sometimes were found frozen in winter. Using quite good radio set they could not contact on frequencies 1600-1800 kHz of the field batch the base radio when they were 5-6 kilometers from the base!

Transceiver Carat



Transceiver Angara



CHAPTER 5: R.W. PROPAGATION

Certainly, any radio amateur after changing QTH, could personally be convinced that his equipment in a new place behaved in a different way. But I in this case speak about another thing: about a pure experiment. A move to another area, where there is another relief of district, other buildings and a level of man-made interference is one thing. But a move of a field batch 10-20 km in one side, with full back-up of disposition of living place, antenna masts and other equipment in Bolshezemel'skaya's tundra (i.e. practically on a flat place) is a different thing.

As a matter of fact, at changing a place on the Earth (or changing the acupuncture of the Earth), the quality of radio communication is changed greatly. Therefore, the quality of radio communication depends on what is beneath our feet!

Besides, if the radio amateur, having changed his QTH, does not always know the qualities of the new place, in my case, practically everything was known:
conductance of soil,
composition of high layers of the earth,
climatic map,
geomagnetic component (you see, the expedition is geophysical!).

In such conditions, during 1988-1992 years I managed to store a large stuff on subjects, which were interesting for me - conformity of geophysical parameters and conditions of radio waves propagation in Trans-polar circumstances. By that time I had already been a radio engineer (I had graduated from the Moscow Institute of Electronic Technology), these data were used by some of my friends for receiving Ms and Ph degrees.

Transceiver Polosa

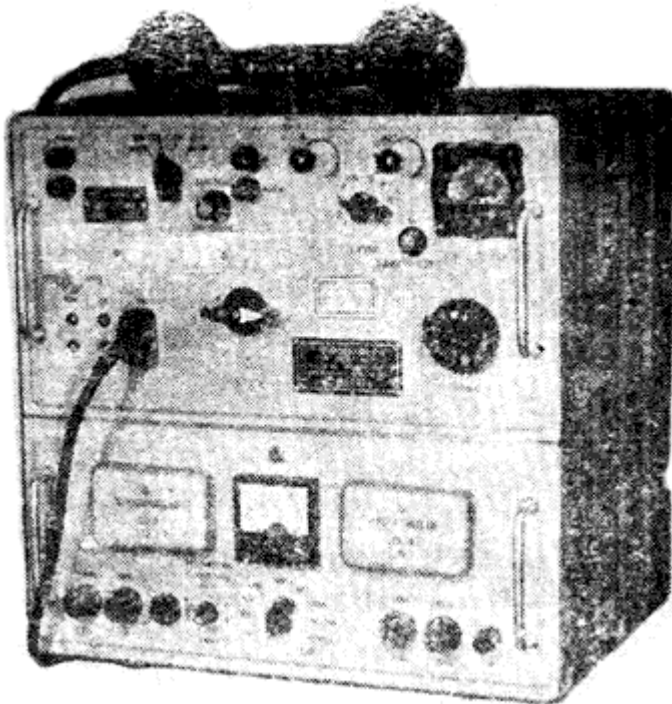

EARTH ACUPUNCTURE

But all the same, in need of a serious special software study, this stuff is still awaiting a serious study...

3. A part of the practical guidelines on the choice of a place for antenna installation and generally for QTH of radio sets I promised the members of club "Arctica" to publish in a special brochure - application to the club bulletin "*Radiotop*"...

I want to support **EVERYTHING** what is written by RK3ZK in his article "Acupuncture of the Earth", as everything mentioned in it has practical affirming by the stuff, stored by me.

Moreover, all radio amateurs who are interested in compiling such "Acupuncture map of the Earth" could contribute to it, having analyzed their own experience and QSOs journal.

Quite often the following may be heard in the ether:

"Your area goes to me on 59 at any propagation!"

It is also necessary to collect in one place data on such "couples" of QTH, which have in common such a notion as "at any propagation". It will be interesting to place them on the geographical map of the Earth and to see what it looks like. Certainly, it will be only the first, not precise approximation...

According to my data, the points, congenial for arranging antennas, are situated in nodes of grid 10 by 10 m, but common negative or positive characteristics of a node, as it is truly noted in the article of RK3ZK, can be expanded to 1-2 kms...

4. As far as the toponymy of the areas is concerned (dependence of the name of the place and its features), there, in the North, it is well-marked and corresponds to reality. You see, in tundra the places can be distinguished by the fact that on one of them reindeers graze, breed and put on flesh, and on the other - die.

5. For the sake of justice, I want to mark, that the following people who worked together with me also participated in gathering the data: Alexandr Babin (UA9XLG) and Vladimir Artyukevich (RA9XQ, exRA9XBF).

73! Alexandr Maxurov, UA6LTO (ex UA9XGB, RA9XO)

INTERNATIONAL RADIOCLUB "ARKTIKA"

www.arktika.boom.ru

International northern radioclub

"ARKTIKA" was founded on Sept. 24, 1989 in Russian Arctic city Vorkuta (North part of UA9X region). Many HAMs from UA1Z, UA0B, UA1P, UA0K, UA0Q, JW, arctic DX-peditions to FJLand North Pole took part in this club organization.

The main aims are:

- to connect all polar radioamateurs and members of an arctic DX-peditions;
- to set up new arctic awards and contests;
- to organize DX-peditions to Russian Arctic area;
- to develop new and digital modes of HAM-radio in north QTH's;
- technical help and HAM-tutorial to young HAMs in small arctic QTH's;
- to set up regional and national arctic ham-ventions;
 - peace, friendship and collaboration in World Arctic area.

To entry into club "ARKTIKA" need:

- live in (or travel to) any QTH under the North Polar Circle and make from this QTH one or more QSO;

- or - take part in any arctic (or antarctic) DX-pedition;
 - or - win 1-3 places in contest "Arctic Cup" in any group;
 - or - win all 3 units of "RAA" program (Diplom, Pennant, Medal).
- No time limit. Any amateur from any country can entry in club.

Needed data: arctic callsign, QTH and time period, when this callsign was active. All members to get "life" membership number and club periodic info-bulletin "Radio-Top". There are 220 members in RC "ARKTIKA" on Sept 2002. RC "ARKTIKA" is very popular in Russia (see "RADIO" magazine #6/2002 - for example), but all info was spreading on Russian language only: <http://www.arktika.boom.ru>

More info by privat e-mail to Club HQ:
UA6LTO@mail.ru



UA6LTO, Alexander MakSurov, President of RADIOCLUB "ARKTIKA"
p.o. box 8, Novocherkassk, 346400, RUSSIA e-mail: UA6LTO@mail.ru

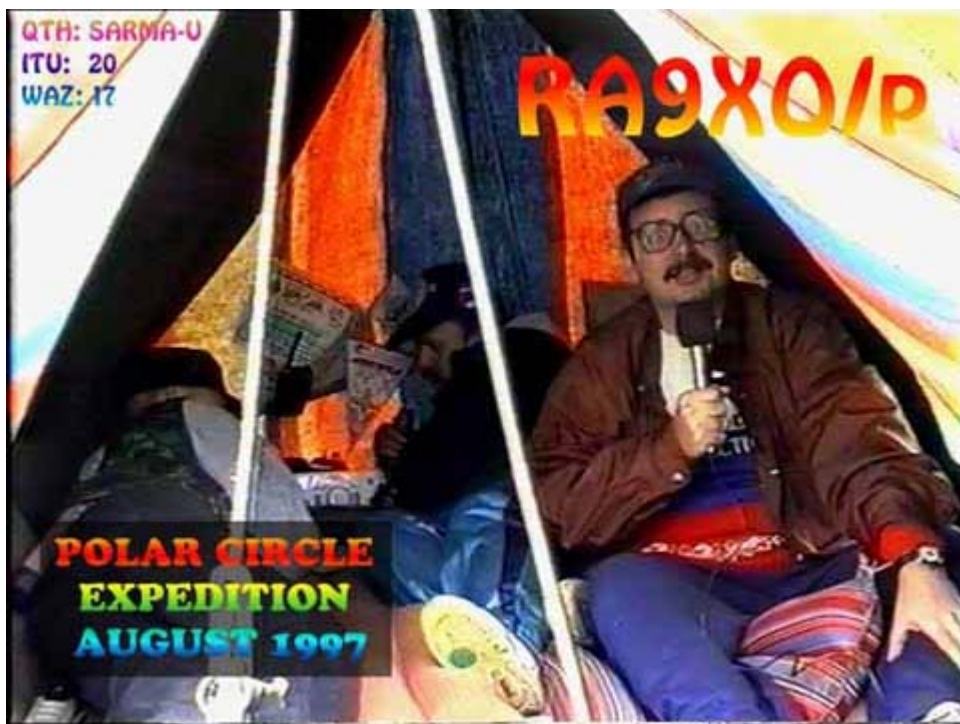

CHAPTER 5: R.W. PROPAGATION

The message, dated on December 18, 2002, was published by Alexander (Ed) Lesnichy (RU6LA) at [The Radiotechnical "Hz" Forum](#). Ed says his opinion on Black and White Spots:

" ... I remember how UB5IF worked, may be, there is anyone, who else remembers he. Twenty years back ago, UB5IF "rattled" on 40-m everywhere. And what is the most surprising, he had only VS1AA antenna (VS1AA is a simple wire antenna) and only 200 watt going to the antenna.

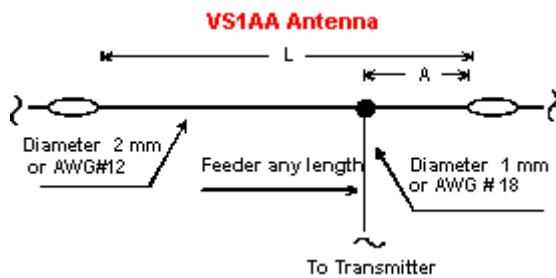

Data for "VS1AA" wire antenna

Ranges, m	L, meters	A, meters
80, 40, 20, 10	41	13,6
40, 20, 10	20,43	6,84

Photo: Ed RU6LA (left) and UA6LFQ



EARTH ACUPUNCTURE

We have had 3 elements YAGI for 40-m and 1000 watts output at that time, but UB5IF worked better us. UB5IF explained his success his correct made VS1AA. During long hours he told to us, how right to do the antenna.

But... Some days UB5IF moved from his old house to a new one. This new house was only several kilometers near his old house. And... He felt silent! His equipment have begun to work as it must work! So, anyone from far radio stations did not answer him. UB5IF remade again and again his VS1AA, then he moved his old VS1AA from his old house to his new house. Useless! New his place, evidently, was a Black Spot!"

73! ED, RU6LA

FEEDBACK from Dmitriy, RK6AOH

Dear Igor:

I completely agree with your article [Earth Acupuncture](#). My experience has proved me in showed me in existence such spots. I have had no time to do a good antenna, and I decided to try a substitute antenna. The antenna had only 3.5 meters length and this one was installed at my balcony, I live at 6-th floor. As antenna ground I used copper foil hidden under wool carpet in my shack.

I turned on my 10-watts transceiver, and... what is surprise! I worked without hard for several thousands kilometers! I heard far stations they heard me, too. But my close neighbors from my hardly heard me, they did not hear the far stations. My friends did not believe me, that I used only 10 watts and 3.5 meters rod.

My work was or very excellent or very poor. Or I hear all, and all hear me, or I hear nothing in the ether. It was very interesting and unusual work in the ether. It was sorry for me, but I had to stop my work in the ether on transmitting for some while... But, when I will work again, I tell you more about my White place.

Yours faithfully Dmitriy, RK6AOH. 73!

Well, I know, there are lots pessimists who did not believe in the Black and White Spots... Okey, may be the next article gives you some feed for the brain.

So, go to next page!

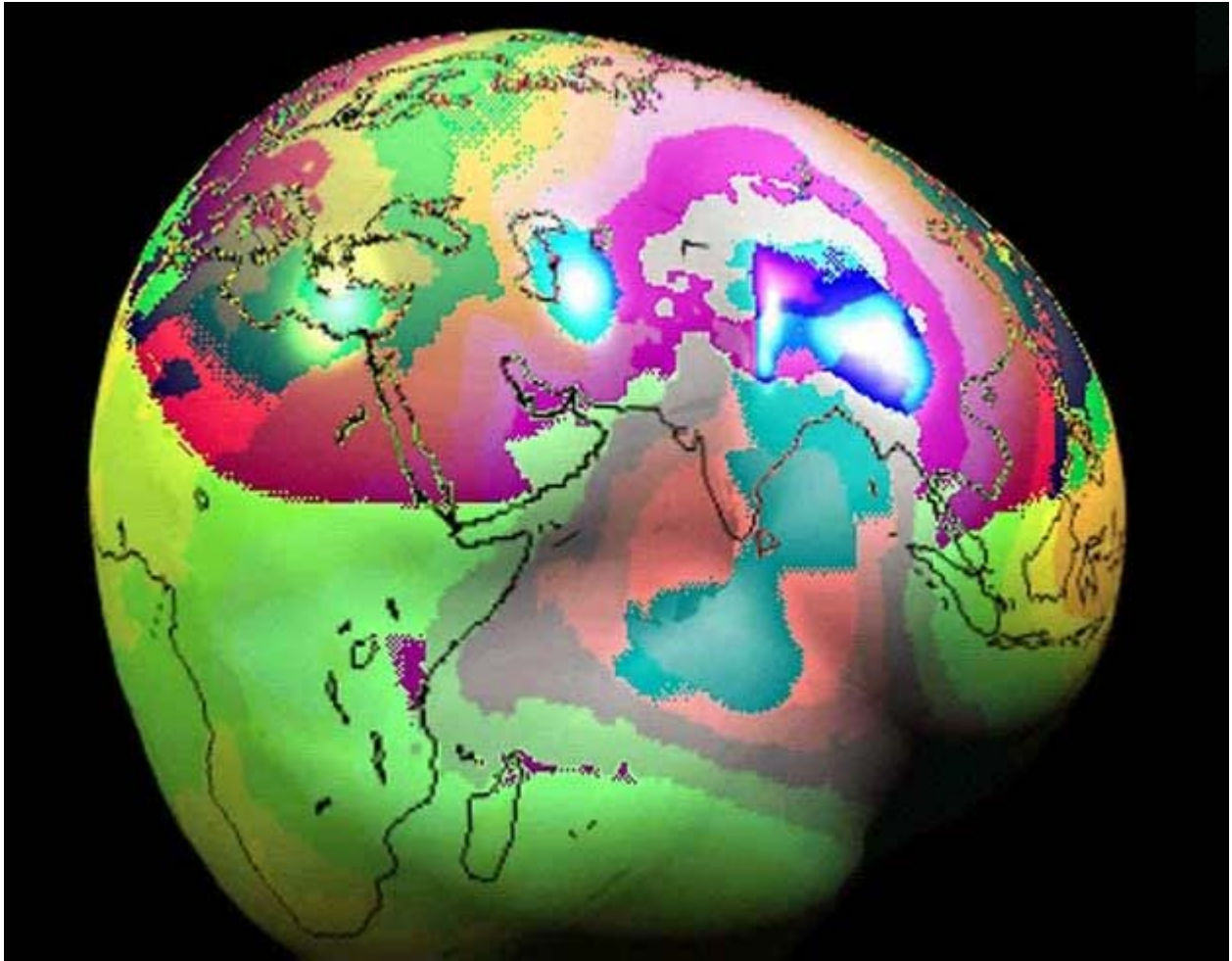
A Gravity Map of EarthCredit: [GeoForschungsZentrum Potsdam](#), [CSR U. Texas](#), [JPL](#), [NASA](#)

Explanation: Is [gravity](#) the same over the surface of the [Earth](#)? No -- it turns out that in some places you will feel slightly [heavier](#) than others. The [above relief map](#) shows in exaggerated highs and lows where the [gravitational field](#) of [Earth](#) is relatively strong and weak. A low spot can be seen just off the coast of [India](#), while a relative high occurs in the South [Pacific Ocean](#). The cause of these irregularities is unknown since present surface features do not appear dominant. Scientists [hypothesize](#) that factors that are more important lay in [deep underground structures](#) and may be related to the [Earth's appearance in the distant past](#). To better map [Earth's gravity](#) and hence better understand its [interior](#) and past, [NASA](#) plans to launch the [Gravity Recovery and Climate](#) (GRACE) satellite in February.

The article was published at:

<http://antwrp.gsfc.nasa.gov/apod/>
<http://astronet.ru>



Well, I Think, it is very an interesting info, and it gives lots feed for though...

Dmitriy gives us own thinking about as the phenomena as about LDE. Go to the next page!

And some conceptions from Dmitriy, RK6AOH, about White Spots and LDE

Now about some researches, supervision and reasons for White Spots and LDE:

- 1) Geological / geophysical conditions at my place:

My QTH contains acid clay ground with sandstone, it is situated between two nearest large breaks of the earth's crust - one in the north, in area Loo – town, the second - in the south, in territory of Georgia.

- 2) Supervision over the phenomenon of a White Spot:

1. The majority "strange" QSOs in the afternoon are spread in the direction conterminous to the direction of magnetic lines of the Earth, in the evening and the night time - on the contrary, in the perpendicular direction, basically to the west, in the direction of the sunset (that is good to match with usual theories of propagation of radio- waves).

2. The phenomenon of a White Spot has arisen at 21:25, June, 21, 2003, in ham range 80-m. I listened to the range because my substitute "antennal" does not allow to work on transfer in effectively way.

As well as always, I herd on the range neighbours' ham stations from 6-th area of Russia, Crimea, Ukraine, common everything, that are in the radius of 300~500 kilometers around me.

Suddenly (again suddenness!) somewhere in middle of the range, a "failure" was appeared. In one second, in the "failure" I began to hear already familiar stations from 9-th area of Russia (4000 kilometers away from me!), all were at first on 35., then 47., then all the station were on 59+!!

The level of signals of the stations grows linearly in

the time. I heard about 5 stations from 9 areas of Russia (it is approximately 4000 kilometers from me!), which worked in a net. Signals from all of the stations had almost equal levels. I did not hear the usual ether's noise. At first I could not understood at once that occurs, and I did not written down the calls. The phenomena took 40- 60 seconds, then click, silence, and again I hear only my neighbours...

- 3) LDE and the connected points

May be radiowaves penetrate through the connected points of the Earth which, probably, form **original liaison channels**, practically on any distances on the Earth. It is possible, that in these **liaison channels**, radio waves are distributed faster, than in natural conditions.

Probably, the "conjugate" points suddenly can disappear and appear and also move over surfaces of the Earth owing to what that of the reasons.

May be, when a radio wave have entered into one conjugate point, another conjugate points is coupled with the first point (that point, where the radio wave have entered). Hence, the radio wave will go to a circle in such having got in such **liaison channel**.

May be, the radio wave can be even go to the **time**, not to the **space**. The modern physics know very little about properties of the time... After disconnection of these conjugate points, the radio wave leaves them in space, forming LDE ...

Depending on properties of the conjugate points there can be LDE with various time delays, from seconds to tens minutes.

Yours faithfully, Dmitry, RK6AOH

If You Can Read in Russian, Go to www.hamradio.online.ru

Huge library with tens FREE e- books at:

www.cqham.ru/lib.htm

The Best Technical Site in Russian!



Earth Shadow, propagation related to earth shadow

by Michael Higgins, EI 0 CL, Email: mhiggins@airtel.net, <http://www.cellcom.ie>

Not well understood it seems but the Earth Shadow has an enormous effect on over the horizon single and multi hop propagation on the HF bands.

Once the Ionized Layers are illuminated by the sun we generally get good refraction above certain frequencies which can and do vary (dependant of course on take off angle and so on). As we approach the poorer part of the 11 year cycle we can see this phenomena better.

With the Earths rotation relative to the sun we naturally and inevitably get areas on Earth which are gradually illuminated and then darkened by the apparently moving shadow (the earth is spinning & rotating too silly) relative to the sun in this case-- also we are moving relative to the other galaxies outside our own solar system.

When darkness comes as a result of this rotation so the refraction characteristics change too.

In the evenings then the East to West HF propagation at MUF (regardless of what it actually is in MHz) is usually better than the West to East.

The shadow appears to move Westwards at appx. 1000MPH at the equator so its quite noticable. (In fact the Earth is rotating Eastwards at the same speed) speaking from Planet Earth



The West to east suffers attenuation (in fact signals not being refracted) or going straight through the less ionized layers-while the East to West signals are better refracted (less attenuated) being refracted by the more existed (by the sun) ionized layers.

Attenuation is my way of describing less than perfect refraction in the above case. Just in case someone loses focus, I'm not discussing attenuation per se or even levels of attenuation. Just the phenomena we like to call by that name.

This phenomena is best observed in the twilight zone.



If we project ourselves well out into space and view the Earth and Sun from a distance we would have a better overview. Observe it and see for yourself even from Earth.

Michael Higgins, EI 0 CL



By the way I have just discovered that the "Black Hole " in our very own Solar system is actually located in Ireland. Try it and see for yourself. It took me many years to discover this.

At first the article was published at www.qrz.com. The article calls a great discussion about the shadow influence to propagation of radio waves. I agree with Michael, there is the influence! And, of course, it must be studied.



73! Igor Grigorov, RK3ZK

www.antentop.bel.ru

Antenna - Island

by *John Doty*, Home: jpd@w-d.org , Work: jpd@space.mit.edu

Sharbot Lake, Ontario, Canada lies a couple of kilometers south of the Trans-Canada Highway, about at the halfway point between Montreal and Toronto. It is perhaps 60 kilometers north of Kingston, which is at the northeast end of Lake Ontario. My grandfather bought a small island in Sharbot Lake in 1948, and I've travelled there regularly since I was 9 months old.

The island is about 150 meters long, but only about 25 meters wide. The long direction lies roughly northeast/southwest direction. There is a cottage near the northeast end. On official maps, the island is known as "Bradley's Island", but on some locally made maps it's known as "Rupert's Island" (Mr. Rupert was my grandfather). It's at 44 deg 46' north, 76 deg 42' west.

The island is wonderfully quiet in the radio spectrum. Our hydro (that's Canadian for AC power, eh?) and telephone connections are via underwater cables: this effectively blocks the noise that normally rides utility cables. There are no nearby cities or powerful radio transmitters. Ignition noise from passing motorboats is an occasional annoyance, but it's not a serious problem.

Even family members who are not radio hobbyists have for many years enjoyed "Medium Wave DXing": it's what you end up doing if you turn on an ordinary AM radio at night on the island. I've often brought my Sony 2001 up there for shortwave DXing. However, before this summer I had never brought a real communications receiver or the makings of a serious antenna system to the island.

This year I brought my Drake R8 and a bunch of antenna wire with me. Initially, I set up two antennas. Antenna #1 was about 120 meters of insulated wire, running nearly the length of the island, at a bearing of about 230 degrees. It was supported by trees at a height of 3-4 meters above the lake, 1-3 meters above the ground. 22 meters of bare copper wire submerged in the lake provided a ground, and an ICE Model 180 matching transformer coupled the antenna through 15 meters of cheap 75 ohm coax to the R8's input #1. Antenna #2 was about 8 meters of wire suspended almost vertically from a tree overhanging the cottage, connected directly to the R8's high impedance input #2. The ground for this antenna was provided by the grounded shield of antenna #1's coax: this arrangement is not good at rejecting noise from the power line, but with very clean power and few noise generating appliances it was usually acceptable (especially as I could always switch to #1). Antenna #1 was intended to be a nonterminated (bidirectional) Beverage, while #2 was intended to be

omnidirectional. The following analysis assumes that #2 *was* omnidirectional.

Tests of the Beverage on shortwave were disappointing: while reception of many stations was excellent, there was very little difference in reception between the Beverage and the vertical. The orientation of the Beverage was such that I expected New Zealand to be in the forward lobe, and Europe to be in the back lobe. S-meter measurements in the 49 meter band revealed little difference between signal strength of RNZI, the Europeans, and other relatively distant stations on the vertical and on the Beverage, while relatively nearby stations such as WSHB and WWCR were substantially stronger on the Beverage. This implies that the Beverage had a strong preference for high angle radiation: this is not the way a Beverage is supposed to behave.

On the other hand, the Beverage showed substantial directivity on medium wave. Furthermore, the directivity was off the ends of the antenna, as it was supposed to be, preferring stations to the northeast and southwest over stations to the southeast (I didn't ID anything to the northwest: there's not a whole lot of civilization in that direction). This was rather surprising, since the Beverage was less than 1/2 wavelength long over most of the standard AM broadcast band! The Beverage was more efficient than the small vertical at MW also, so even signals off to the side were stronger on the Beverage. The front/side ratio was about 10 dB, which was enough to make a significant difference in many cases. For example, in the daytime the dominant station at 900 kHz on the Beverage was CHML in Hamilton, Ontario to the southwest, while on the vertical it was a station I never positively ID'd, but whose community service announcements referred to communities in northern New York, to the southeast. At night 1370 kHz was generally a confused mutter on the vertical, but the Beverage could usually pluck WXXI in Rochester, New York (more south than west, but still in the beam) out of the mess.

Despite the Beverage's directionality, the most distant mediumwave station I heard was best on the vertical: Radio ZIZ, St. Kitts on 555 kHz. A directional antenna only helps if it's pointed in the right direction!

Another surprise was longwave. I'd never really heard any longwave broadcasters before. From my home in Bedford, Massachusetts I can occasionally hear a word or two in between noise bursts and beacons, but never anything listenable. However, from the island I found that I could often hear European longwave

broadcasters at night: I hadn't realized that they could be heard so far from the ocean. Here's my log from around 0300 UT on August 11:

Freq	SINPO	ID
252	22252	Clarkestown, Ireland
234	22252	Junglinster, Luxembourg
216	33353	Roumoules, France
183	24353	Saarlouis, Germany
162	22352	Allouis, France

All of the above were in French except for Atlantic 252 in English.

The Beverage didn't seem to be especially directional down there. I didn't really check it carefully, though: beacons aren't my thing, and the broadcasters were all in about the same direction. The vertical was just too short to adequately feed a 500 ohm input below 200 kHz, so the Beverage was the better antenna down there. The stations above 200 kHz sounded about the same on both antennas, although the signal from the Beverage was, of course, much stronger on the S-meter.

The unusually poor directivity of the Beverage at shortwave, and its unusually good directivity on mediumwave puzzled me. I guessed that the island itself must have something to do with this phenomenon. The ground under a Beverage is an important component of the antenna: could the island be acting differently from a more uniform surface? If the island was perturbing the behavior of the Beverage, could it be acting as an antenna all by itself? I realized then that there was a way to turn the island and the surrounding water into an antenna. A "slot" antenna is just a slot (usually 1/2 wavelength long) in a conductive sheet. The island could act as a slot in the conductive lake water! A slot antenna is usually fed by connecting a transmission line between the sides of the slot at its center. I didn't have enough coax to reach the center of the island, so I just fed it where I'd already put my "ground" connection into the lake, about 25 meters from the northeast end. I disconnected the Beverage, and ran an insulated wire about 15 meters long to the other side of the island. Having no additional uninsulated wire, I used a metal bait bucket as my contact in the water. I connected the feed wire to my matching transformer.

It worked pretty well! The signals from the slot antenna were weaker than those from the Beverage, but below 10 MHz the signal to noise ratio was generally about the same. The slot was a poor performer above 10 MHz. It did not seem to be very directional on shortwave. On medium wave, the slot was noticeably directional, but in a rather different way from the Beverage. At the low end of the standard broadcast band, it seemed to have a "cardioid" pattern, with good response in every direction except northeast. The front

to back ratio was about 10 dB. At the high end, the pattern was more like that of a dipole oriented like the island, with good response broadside, and poor response off the ends. CJCL 1430 in Toronto was especially weak, more than 15 dB down relative to stations off to the side (always using the vertical as a reference). Longwave was also good on the slot. I added Nador, Morocco at 171 kHz to my list of stations logged down there.

Although my antenna experiments were a bit of a bust at shortwave (nothing beat the simple vertical, no matter where the signal was coming from), shortwave reception was nevertheless very good at this quiet site. My home site in Bedford is also pretty quiet at shortwave, however, so there were few surprises in what I was able to hear. One exception was the main transmitter site of Radio Japan at Yamata. Asian stations are generally weak and unpredictable in eastern North America, but Yamata seems to be particularly bad in New England. Why this should be I don't know, but I've never positively ID'd it from the Boston area, despite trying for several years from two sites with several different antennas. However, from the island I could hear Yamata on 9535 kHz! For example, at 1720 on August 10, I had it at S4, SINPO 25332 on the vertical. Not a breathtakingly good signal, but *much* better than I'm used to!

I also believe I heard Papua New Guinea on 3220 one night, but I made the log entry on a piece of scrap paper in the dark (to avoid waking my wife), and I can't read the time or date now. It sounded a lot like Steve Byan's recordings. If you think the R8's ergonomics are bad normally, you should try operating it in the dark!

Analysis:

I think the reason that the Beverage lacked directionality at shortwave was that it wasn't arranged symmetrically with respect to the island. I tried to keep the antenna straight. However, the island, although it is long and narrow, is not perfectly straight, so the antenna was not centered on the island. The return current through the ground plays an important role in the function of a Beverage, and the unsymmetrical placement of the wire relative to the more conductive lake water undoubtedly severely distorted the current pattern in the ground. Next time I may try running the antenna as close to the island's centerline as possible: it won't be quite straight, but it just might work better.

The use of an island as a slot antenna turns out not to be a new idea: I found a paper on it in a library at MIT. There was both theoretical and experimental work on the use of large islands as VLF antennas published around 1960. The paper I found (by Harold Staras of

Technion and RCA Laboratories) analyzed large islands in seawater, and concluded that they would make poor VLF antennas. His analysis makes sense, but he used some approximations that are only valid for large islands (kilometers in length) in seawater (much more conductive than fresh) at VLF, so his conclusion does not apply to my case.

For a smaller island in fresh water at LF/MF/HF the theory is much more complex since Staras's approximations don't apply (even with his approximations, the math in his paper was quite heavy). I have no conclusions to offer, except that this is an interesting area for experiment. The theory looks too complex to be a useful guide.

John Doty : "You can't confuse me, that's my job."

Pedersen ray propagation

By Robert Brown <mailto:bobnm7m@cnw.com>

Pedersen ray propagation takes place at the transition from one ionospheric region to another, the lowest being between the top of the E-region and the bottom of the F1-region while the highest at the F2-peak which divides the bottom and topsides of the F-region. This form of propagation happens when a ray which came up from below the transition region has been refracted such that it is finally moving parallel to the earth's surface at the ionospheric boundary and continues that way for some distance.

E-hops or 2,000 km F-hops. Such E-F hops are expected on theoretical grounds because of the nature of the electron density distribution, a deep valley above the E-peak developing after sunset. Experimentally, a valley distribution is well-documented and has been seen for years, by incoherent scatter radars from Puerto Rico to Northern Norway, leaving no room for any dispute.

Pedersen ray propagation results in long hops for signals in the HF part of the spectrum but any change or gradient in the electron density in the top of the F-region, an increase or decrease, will refract the signal away from that direction, down to ground or up to Infinity from the F-peak. In practice, this mode is rather unstable and appears briefly (see p. 181 of Davies' recent book for experience on North Atlantic paths.)

Beyond the theoretical idea, one can explore the computational side of long E-F hops by means of ray-tracing of paths across the ionosphere. Mainframe computer programs developed in Boulder by the Department of Commerce radiophysicists in the 60's and 70's allowed such studies, even including the effects of the earth's magnetic field. Those programs have now been brought down to the PC level in the PropLab Pro program, available for use in amateur circles. (Let me recommend it to you!)

Turning to 1.8 MHz signals, something resembling Pedersen ray propagation can take place at the top of the night-time E-region. In case you have missed it, I have written on this topic several times, pointing out that long E-F hops can take place, covering distances up to 3,000 km instead of the more familiar 1,000 km

Briefly, such ray-tracings show that E-hops on a path are found at low radiation angles incident on the bottom of the E-region. Then, by advancing the radiation angle in small steps, one finds the E-hops become longer and longer til they go over to E-F modes where the path rises to a peak in the F1-region and then retraces itself down through the E-region to ground:

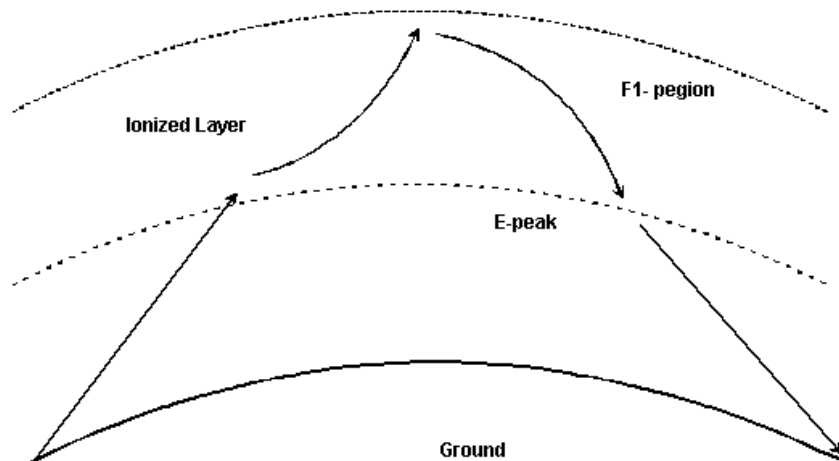

Figure 1

Finally, at slightly higher radiation angles, signals are propagated by F-hops instead of E- or E-F hops:

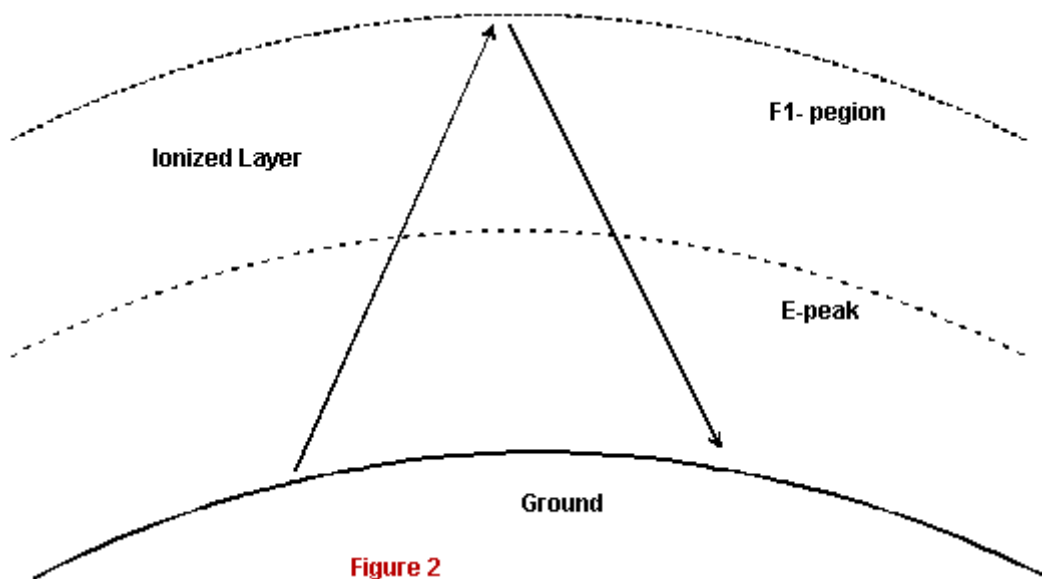

Figure 2

The fact that ray-tracings show 1.8 MHz paths are limited to the lower ionosphere, rising no more than about 200 km instead of to the 300+ km F-peak, stems from a fundamental result of ionospheric theory. Briefly put, only a fraction of the 1.8 MHz operating frequency is effective in carrying Top Band signals obliquely up into the ionosphere. That fraction is found by multiplying the QRG by the cosine of the angle by which the signal goes into the ionospheric region. Thus, for a 30 degree take-off angle, RF approaches the ionospheric layer with a 60 degree angle from the vertical and the effective vertical frequency would be 0.9 MHz.

So signals would peak at an altitude where the local plasma frequency is 0.9 MHz. Of course, that would depend on latitude but would not come close to the height of the F2-peak where plasma frequencies are always greater than 3 MHz, even at solar minimum.

Now everything that I have said above can be verified by using the PropLab Pro program in 2-dimensions. Just pick a path in darkness, start at a low radiation angle, say 10 degrees, and slowly increase the angle, 0.1-0.2 degree at a time. First you will see E-hops, then E-F hops and finally F-hops. Nothing to it!

Those simple paths would apply to Top Band propagation except for the presence of the geomagnetic field. The theory is much more involved now but the results are much the same, at least as far as how high Top Band signals rise in the ionosphere. With PropLab Pro, you can use the same incremental technique and explore paths. I have done it thousands of times!

What you see when you take the program to 3-dimensions is about like before: first, E-hops at low radiation angles, then E-F hops, then either F-hops at a slightly higher angle or a DUCTED PATH, slightly skewed, where the ducting amounts to a string of E-F hops in series. But that is Pandora's Box (in more ways than one) and I will have to stop right here.

This is obviously a complicated matter and I won't belabor the subject further. Simply let me say that HF ideas are quite out of place when it comes to Top Band propagation and a whole new approach is required if you still think that way. But this is not news; it has been around propagation circles for 50 years!

If you're interested in these matters, I have an article in the Spring '98 issue of Communications Quarterly as well as a shorter one in the Top Band Anthology published recently by the Western Washington DX Club. Background material may be found in issues of The DX Magazine, 1996 and onward. I had hoped these ideas, old as they are, would not continue to remain well-kept secrets but that seems to be the case.

Finally, I hope I haven't offended anybody. I didn't invent these ideas; I am the "messenger" and am just trying to tell it like it is, REALLY IS! With that I will hold my peace.

73,

Bob, NM7M

FAQ on WWW: <http://www.contesting.com/topband.html>

Submissions: topband@contesting.com

Antennas in the mountains

By Igor Grigorov, RK3ZK

Those radio amateurs who are going on a high-mountain radio expedition must know about the following thing. Clouds and snow do harmful effect to antennas in the mountains. During my previous mountain trips I ran into this effect.

However, the harmful effect very obviously arose on Ai - Petri plateau during the UR- QRP-C radio expedition. This effect essentially corrected the schedule of our radio expedition. All members of the radio expedition observed the effect and they could confirm the truth of my observation.

Clouds against antennas

So, it happened in May, 2001, during the radio expedition of the UR-QRP-C on Ai - Petri plateau. We used a special call sign EM5QRP. For work on short waves we installed two antennas. One antenna was a usual long wire in length of 55 meters. The second antenna was a GPA-30 vertical multirange antenna, made by the Fritzel corporation. More detailed information concerning our antennas, ways of their installation and accommodation of the expedition in Ai-Petri shelter can be found in reference [1] (in Russian).

Though the main part of Ai-Petri plateau is only 1200 meters above sea level, clouds would often cover the plateau. They constantly fall down to Ai-Petri plateau from the sky. Then the wind slowly moves the cloud over the plateau in various sides. It occurs that the weather changes dramatically within five minutes. The Sun shines, then a cloud falls down to the plateau, it rains, the wind blows away the cloud, and the Sun shines again.

The cloud does not choose a side where it moves on the plateau. The wind controls the cloud. If the cloud moves over the plateau aside our antennas, it does not influence the work of our radio expedition. But, if the cloud "sits" directly on our antennas, the work of our radio station becomes impossible. We named this harmful effect as "Ai-Petri effect".

How it was opened

At first I thought that the reason for periodic deterioration of reception and transmission on the radio station of our radio expedition was due to bad contacts in antenna's terminal of ATU (an Antenna Tuning Unit). The wires of the antenna and grounding were repeatedly and carefully cleaned and plugs were tightly twisted. It felt as if we observed the "imaginary effect" caused by these actions.

It was like you turned off contacts, cleaned wires, stretched twirled contacts, and the work of our radio station again renewed. But in spite of periodical cleaning of the contacts, reception and transmission on our radio station vanished away and appeared again. Obviously, the true reason for periodic

Clouds down

deterioration of work at our radio station was not in bad contacts ...

Dielectric cloud around the antenna

Dielectric permeability of a cloud differs from that one of the air, which is equal to 1. Therefore, if a cloud sits on the antenna, antenna's electric length changes. It results in a change of resonant frequency of the antenna. Input resistance of the antenna also changes.

Usually, a cloud is sitting on an antenna for a rather short time, for one - three minutes. Within the minutes the current in the antenna varies in a few times. ATU's RF ammeter shows these current varies. Certainly, it is impossible to provide constant tuning of the ATU within the minutes!

Screening of the antenna

It turned out that a cloud does another even more harmful effect to antennas than the change of the resonant frequency of antennas in the cloud. The effect is the screening of the antenna by the cloud. The cloud consists of billions of tiny droplets, and each one can bear a small negative (concerning the surface of the ground) charge. Also each of the tiny droplets is not an insulator due to thunderbolt, each droplet has a small conductivity to electricity

CHAPTER 5: R.W. PROPAGATION

Hence, the cloud has a small conductivity to electricity and a negative charge concerning the ground. And this substance covers our antennas. It is like when a metal sheet covers our antennas. Still some minutes ago there might be a magnificent reception. Within a couple of minutes the cloud covered our antennas and the reception is completely stopped. **This effect was observed mainly in the afternoon when the white clouds covered the antennas.**

A black cloud is not dangerous

It was noticed by us, if a black cloud covered our antennas, the reception was present, though it was weak. It remains a riddle for me. The black cloud is usually much denser than the white one. When a black cloud covered me, I was under the impression that I was in fine douche. A lot of microscopic droplets of water gathered round me. The droplets fell on my clothes and hair, got in my nose and ears. It is darkly, that such a black cloud influences the reception much less than a white one.

A night is better than a day

At night a full stopping of the radio reception due to clouds was not observed. Usually only the effect of detuning of the antennas appeared when a cloud sat on antennas or passed through them. At this time reception became unsatisfactory, antenna current varied at transmitting mode. It was necessary to stop work on our radio station temporarily and wait until the wind blew away the cloud from our antennas.

Other amateurs faced the phenomena

Hams who worked in mountain conditions also faced the effect of influence of the cloud on antennas. **Andrey Blinushov/UA3SGV** writes about his amateur radio work during his trip across Hibina Mountains in 2002 [2].

Andrey Blinushov



" On August 11, alpinist group with my guys left our mountain camp for a three-day ring trip, and I danced from impatience - quickly to my transceiver! But within one hour a dense cloud, bearing fine rain suspension, descended the mountain ridge Chasnochorra to the place, where I stayed, and covered our mountain camp. And for all the day - only 14 QSOs! I heard about the radio expedition of EM5QRP on Ai- Petri. When such a cloud sat on their antennas, the radio

Antennas in the mountains

communication broke. It was a surprise for me at that time. Now I have faced such a phenomenon myself..."

Cloud cancels directional antennas

We had to refuse the installation of directional wire antennas, which I had taken with me because of the cloud effect. Really, a greater part of time Ai- Petri plateau is covered with clouds. So, our antennas are also covered with clouds... It was not wise to install directional antennas, which will not function a greater part of the time. Inside a cloud the elements of directional antennas, for example such as YAGI, will not have those resonant frequencies which are necessary for their proper work. Hence, these antennas will have no proper diagram directivity.

Antennas with phased feeding would not help us. Clouds have variable dielectric permeability through their volume, and moreover, these clouds are constantly moving through our antennas. So, the electric distance between elements of the phased feeding of the antenna will be constantly changing. Hence, the diagram directivity of such a phased antenna will change according to unknown law. That is why we could use only simple single-element antennas for work during the radio expedition on Ai- Petri plateau.

Antenna current from clouds to the ground

We noted one more very interesting effect at covering our antennas by a cloud. My ATU, which we used during our radio expedition on Ai- Petri (circuit of the ATU is given in reference [3]), had an RF ammeter in antenna circuit. The meter indicated a hundred milliamperes whenever a dense white cloud quickly passed through our antennas. It was completely useless to hope for any reception in these conditions. Only a steady crash and roar was in our headphones.

If only this useless current, flowing between a cloud and the ground, one could direct for useful needs. For example, it could charge accumulators. This idea sounds fantastic, but such high current is quite capable not only to interfere with reception but also to do some good things, for example, to charge accumulators.

Electrically grounding is mandatory for antennas

It shows that electrical grounding is an important thing for any antenna in the mountains. The antenna terminal at my self-made ATU was electrically connected to ATU's case (I used a resistor by resistance of 100k Ohm / 2 watts), and the case was grounded to the real earth. Cloud current flowed from a cloud to the earth, and did not do us any harm

The antenna terminal of the R-143 radio, which we used for work in our expedition, was not electrically connected to the case of this one. As a result of it, if clouds covered our antennas, this radio station could not work in the ether without ATU. Without ATU, a neon bulb, placed near the antenna terminal of the R-143 radio, shone. Sparks jumped from the antenna terminal to the case of the R-143 radio. It might damage this radio station if the antenna accumulated too big static potential.

The Ai- Petry effect in winter

In December 2001, the UR-QRP-C organized expedition to Ai – Petri plateau. This expedition was



dedicated to the centenary of the first wireless contact of G. Marconi across the Atlantic Ocean.

There were used two antennas for short waves. One of them was an antenna of a Long Wire type. It was 55 meters in length, the top end of which was fixed to the mast of rescuers. The second antenna was a CB-dipole. Each wing of this dipole was 2,7 meters in



length. The dipole was fed through a thick coaxial cable with characteristic impedance of 75 Ohm. The coaxial cable was 8 meters in length. This CB- dipole worked well on ranges of 10-20 meters. Each antenna was connected by its own separate ATU to our transmitting equipment. In winter we also encountered the influence of weather mountain conditions on our antennas. In winter this effect was caused by snow.

Snow has effected the antennas

Almost constantly there was snowfall on Ai- Petri plateau. It was very beautiful when large white

snowflakes slowly fell onto the ground. Alas, each snowflake carried a small negative charge. It caused a weak click in earphones if such a charged snowflake discharged our antenna. The click was much stronger if 10, 20, or 100 snowflakes simultaneously discharged

Ai- Petry Meteo



the antenna, or rather there was a constant crash from weak to a loud one in the earphones. During a strong blizzard, when the snow enveloped our antennas, it was almost impossible to work in the ether because of a loud crash in the earphones.

Snow produced an antenna current

When the blizzard was very strong, there was an atmospheric current between the antenna and the ground. The RF ammeter located on our ATU confidently registered this current. But the current was not so strong as in the spring 2001, when white clouds passed through our antennas. Snow caused a current near 10 milliamperes (reportedly to the RF ammeter of the ATU).

During snowfalls we did not observe a full stopping of radio reception as it was in the spring when a white cloud sat on our antennas. Certainly, it was difficult to work in the ether with strong crashes in the earphones. But a couple of days later we adapted to the crashes in our earphones. Dry snow did not strongly affected our work in the ether. Only damp snow hindered our work.

Damp snow attacks our antennas

Damp snowflakes seldom carried a negative charge. At contact with our antenna such snowflakes did not cause clicks in the earphones. When the snow was damp, there was a silence in earphones, however it was a deceptive silence. Damp snowflakes stuck to our antennas. Gradually the antennas became thicker and thicker in their forms, they looked like thick white exotic snakes.

So, damp snowfall dressed our antennas in a thick "snow sleeve" or a thick dielectric sleeve. Dielectric permeability of snow and especially damp snow is much higher than 1. Hence, this snow sleeve changed the electric length and input impedance of our antennas.

During damp snowfall the antenna parameters constantly changed while snow was sticking to antenna wires because the electric length and input impedance of the antennas depended on thickness of this snow covering. Almost constantly it was necessary to tune the ATU connected to each antenna.

Snow dancing and Antenna shaking

After some time of the damp snowfall the ATU could not tune the antennas. The antenna current "floated" at transmission mode, the reception was very bad.

Then one of us dressed warmly, took a long stick and went out to shake off the snow from antennas. After that the antennas were operable for some time again, up to the next sticking snow. As a rule, it was necessary to shake off snow from our antennas several times a day. But during strong snowfalls it was necessary to shake them almost each hour.

Snow Cloud is going



Near a Snow Cloud



Snake Antennas



There was a lot of snow on Ai- Petri plateau! It was necessary to "float" through that snow to our antennas standing up to belt in snow and in some place up to breast to beat the antennas with a long stick.

Soon snow was in pockets of overcoats, in footwear, in sleeves. At the unsuccessful strike, snow from antennas fell under the collar, in the nose and ears, in the mouth, covered the glasses. The man came back stuck round with snow like a big snowball and ran to our fireplace to warm himself.

CHAPTER 5: R.W. PROPAGATION

Half an hour later our traces near antennas were snowed in. To shake off the snow from antennas it was necessary to make a new path again... again to go through snow up to belt.

Silent night

Certainly, we could shake off snow from our antennas only in daytime. At night our lantern gave us about several meters of good visibility in strong snowfall. It was unsafe to go at this time up to belt or up to breast in snow to any side from our shelter. Therefore, at night we did not work in the ether. Let me remind you, our radio station operated in the ether each night in the spring, 2001.

In the morning our antennas being stuck with snow bent almost to the ground or to be correct to the snow lying on the ground. Thickness of the snow, stuck to our antennas and coaxial cable of CB dipole, sometimes reached 20 centimeters in diameter. Each morning I thought with horror that our antennas would not sustain snow and break. It would be very difficult for us to restore them in conditions of constant snowfall. Metal mast, where upper end of LW antenna was tied, was covered with ice for the second day of our expedition. It was impossible to climb it.

The roof of the shelter was covered with ice and a thick layer of snow. It was impossible to climb this roof. Hence, it would be impossible to restore both the LW

In the morning after snow in the plateau



and the dipole antenna. When the expedition was over and we left the shelter, our antennas stayed hanging in their places...

In the morning it was impossible to tune the antennas covered with snow. Antenna current "floated", reception and transmission was unsatisfactory. Only after shaking the snow off it started to work. And the station EN100GM again was operating in the ether!

Antennas in the mountains

Shaking_of_antennas



In the morning after snow



References

1. I.Grigorov.; Expedition to Crimea mountains www.mountain.ru
2. A.Blinushov. Expedition to mountains Zapoljar'ja. Hibiny - 2002. www.mountain.ru

QRP TRANSCEIVERS

QRP - projects from UR- QRP- C

RU-QRP- C presented for you several QRP- projects of their members.

My First QRP-Station

Three transceivers from Oleg Borodin, RV3GM/QRP E-mail master72@lipetsk.ru

Remember, '70-th when I was a young SWL, I has build my first direct conversion receiver (pict. 1) It was too wonderful for me because he is very simple, just a three transistors are in receiver's circuit and a few any details. I powered this RX by 9 volts battery of pocket broadcast receiver. I has not a good antenna and I used a piece of wire in my room. For the first testing construction I did not made a PCB and build this RX as "space" style on a piece of printed board. It was a 80m band version. Results was shocked me at once!



Before I used for SWL old broadcast receiver by 6 valves with home-made local oscillator. Having heard an ether on my new DC RX and at once forgot about the old lamp receiver. The sound was clear, sensitivity very high and I has heard a lot of DXs during some evenings and nights. After my first fun I has developed PCB and rebuild the RX for the box of printed boards also.

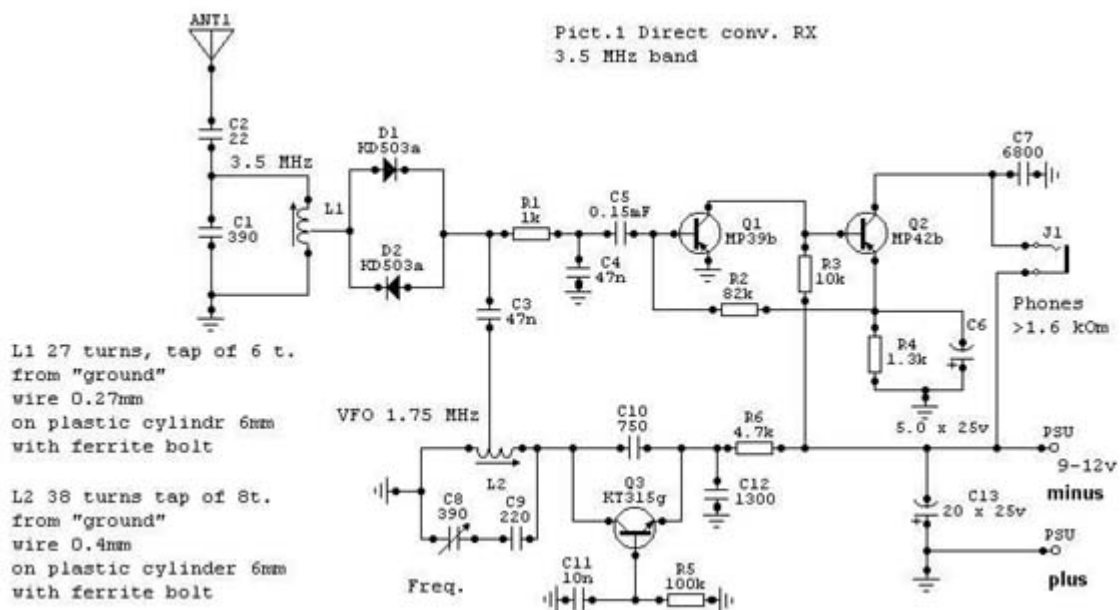

Alongside to this 80m variant receivers under the similar circuit on 40 and 20 m bands are also were constructed. The results were obtained also excellent.

My next step with Direct Conversional was when I get a HAM license. I began to experiment the receiver in hope to transform it into the transceiver. First of all I have decided to submit a VFO signal to the antenna through a keyed amplifier stage (pict.2). It worked well. There was even a frequency shift by transmission

about 1 kHz that enabled to hear stations without additional RIT. But, taking into account, that VFO works on frequency twice below, than the received frequency, power of a transmitting signal in the antenna was rather small, just few decimals of milliwatts. I has just a few nearest QSOs with this QRPp on 80m band only. It is impossible to use this circuit on 40 or 20m bands because the frequency shift is too large (5 to 10 kHz) and your signals will be outside from a signals of your correspondents.

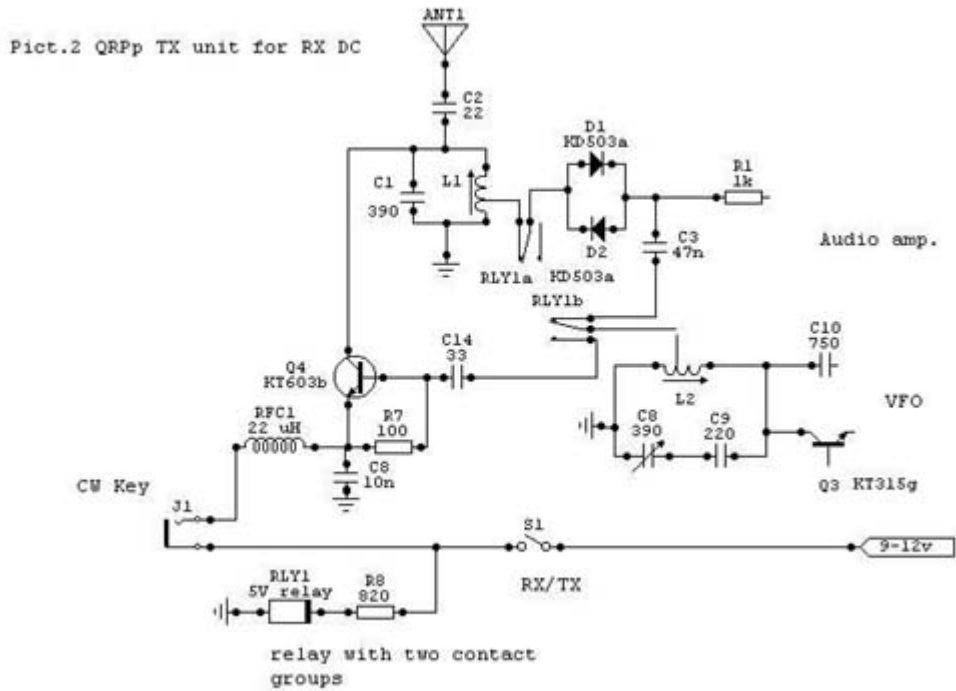

The following version of the transceiver based on receiver (fig. 3) consist in addition keyed freq's doubler and stage of an amplifier. It gives me a good 0.75 watt output at 80 and 40 m bands and 0.3 watt at 20m. I only needed to add the RIT and sidetone.

I has a many pleasure days with this transceivers. I build a three tcvrs for any bands. I did not made a multi-band trcvr because the complicating of commutation bands chains would necessarily be mirrored in quality of the transceiver in the worse side

. The frequency stability would worsen, be sure. Well also it is not necessary to forget that the main advantage of direct conversion equipment is a simplicity.

The kits of parts and PCB of these receivers or transceivers are available at me, send me your orders by e-mail or post.

72! from RV3GM/QRP

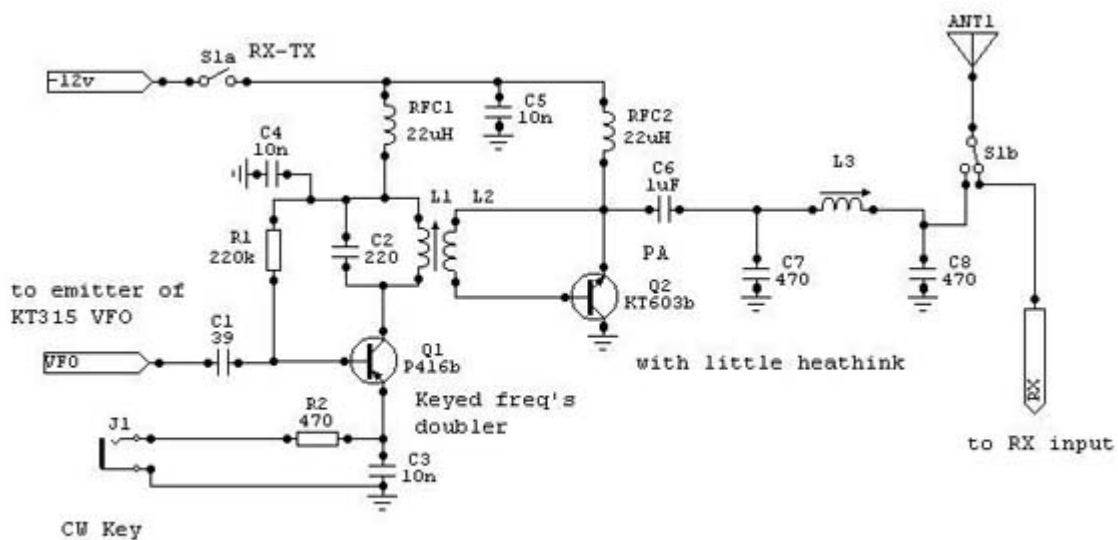

Pict.3 Transceiver's unit for RX DC

GNOMIK - 80-M QRP transciever

Introduction

The goal of this project is to provide to Amateur Radio beginners with a working QRP CW transceiver that they build and learning the knowledge of transmitting and receiving equipment on the most of popular HF band 80 m.

This "Gnomik " transceiver contains two separate units: direct conversion receiver (RX) based on modified DC receiver designed by Vlad Polyakov RA3AAE and transmission unit (PA) based on standard scheme frequency-doubler and amplifier. The RX's heterodyne operate on a half of receiving frequency.

Schemes (example)

History

For the first time "Gnomik" was designed at 1986 year by Oleg RV3GM after he has experimented with RA3AAE DC receiver. Oleg updated receiver with transmission unit and after some modifications "Gnomik "was ready. There are some QSO's from Oleg's Log Book he has operated with "Gnomik":

Band - 80 m		Mode - CW		Antenna - VS1AA (15 m up)	
Date	GMT	CALL	My RST	Report	
07 Apr. 1986	20.35	RB5GFX	549		Kherson (Ukraine)
07 Apr. 1986	21.42	UA3OIX	559		Voronezh, Victor
11 Apr. 1986	18.30	UA4CPX	579		Saratov (on Volga)
18 Apr. 1986	00.27	UA6PCQ	569		Grozny (Caucasus)
20 Apr. 1986	19.03	UA1OB	569		nr Arkhangelsk
26 May 1986	20.37	UM8PGA	579		Naryn (Kirgiz Rep.)
31 May 1986	20.10	LZ2ZA	559		Vama
10 July 1986	19.54	HABOJ	579		Mohora
etc...	etc...				

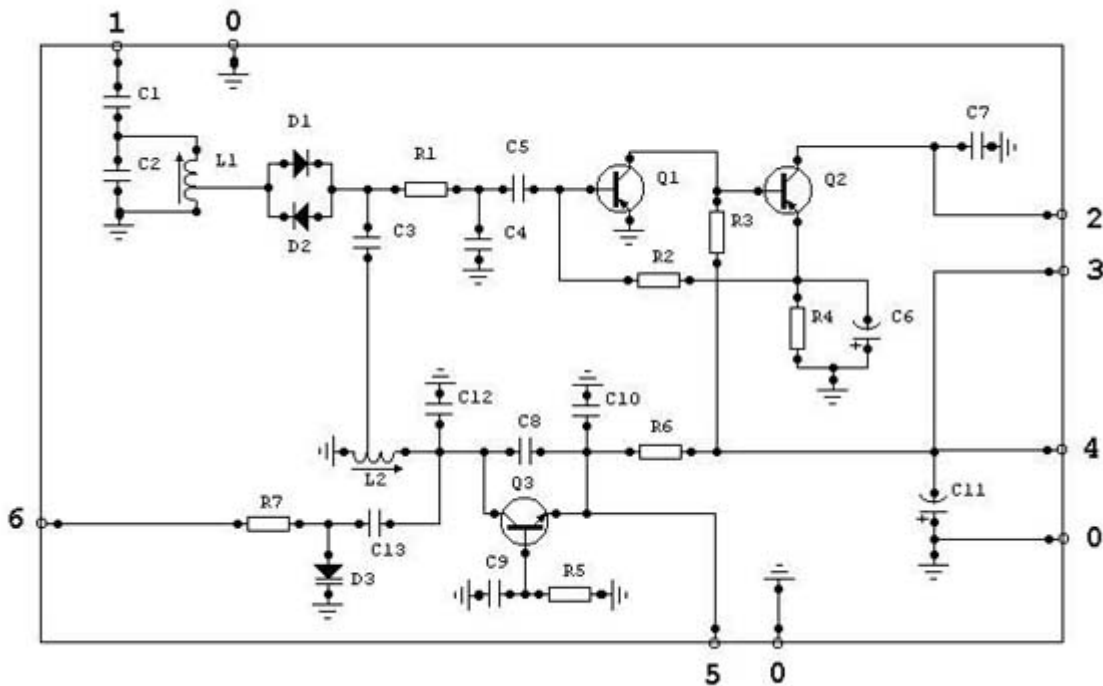

Parameters

Output power of transceiver is 500 mW approximately. Sensitivity of receiver is about 2 uV. Antenna's impedance 50 Ohm. "Gnomik" powered by stabilized DC power supply unit 12:13,8 V @ 150 mA max. current (positive to "ground").

Upgrade

Optionally, you may insert to "Gnomik" some modifications: RIT, side-tone, digital frequency meter, output RF meter, S-meter, Antenna Tuning Unit. That's fine! How you like! But don't forget, that the major advantage of direct conversion QRP equipment is it's simplicity! 72 and good luck!

© 2002. All rights reserved.

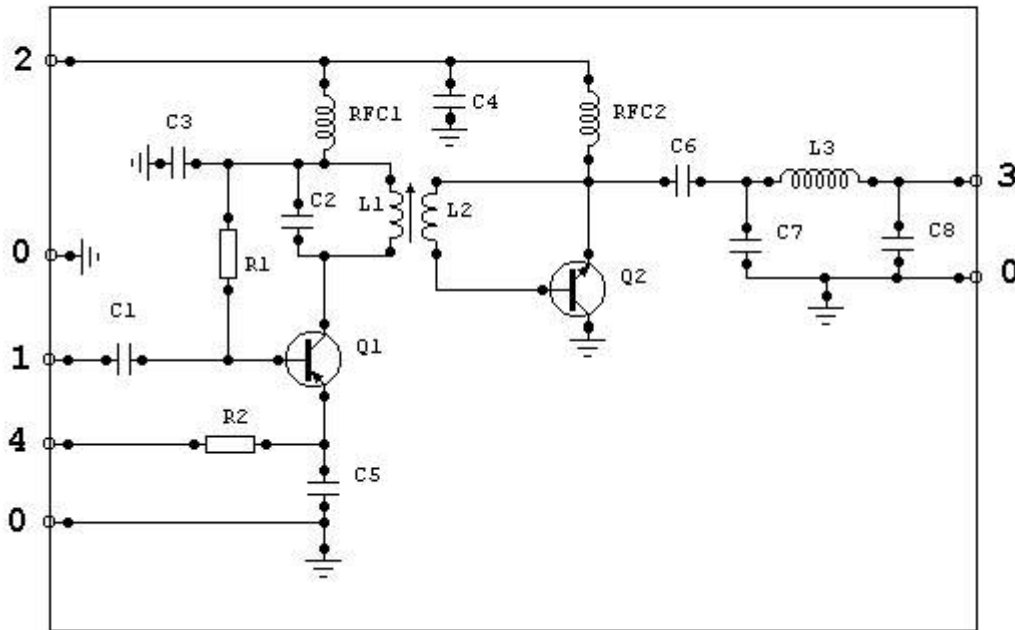

[Kit is available at RV3GM](#)

MICRO-80 - 80-M XTAL QRPp transceiver

Pict.1 Microtransceiver Micro-80

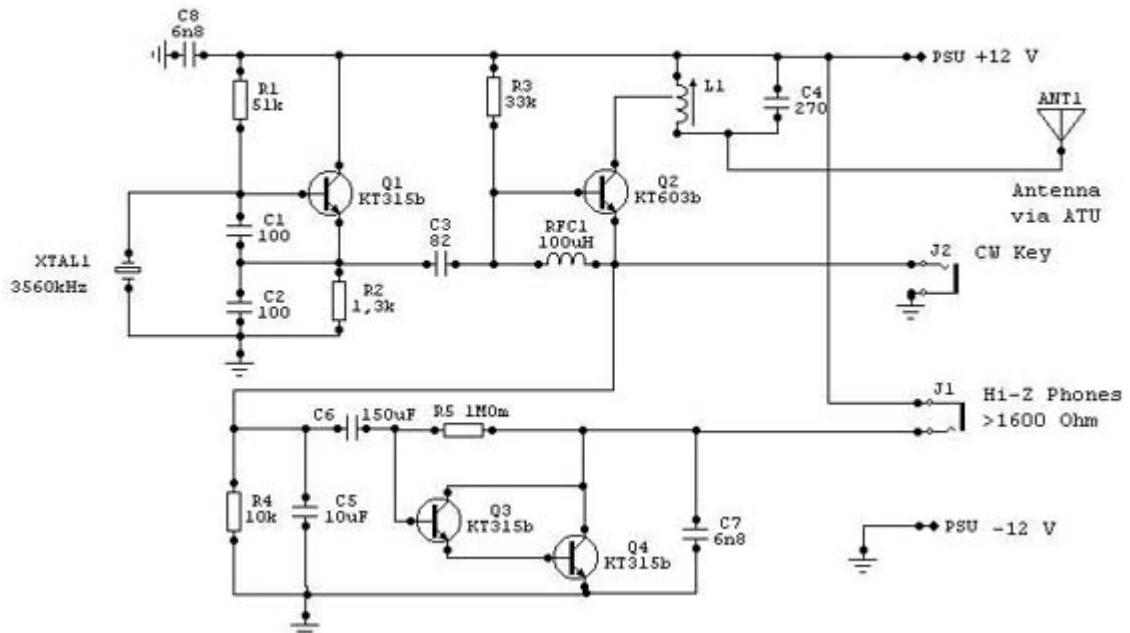

"Micro-80" is the first smallest and the simplest transceiver in the World. This is a prototype of some next wellknow kits "PIXIE", "Tiny Tornado".

n-p-n transistors, 5 resistors, 2 inductors and 7 capacitors are mount on 35 x 50 mm PCB.

This transceiver's kit contains all the components (without xtal only), PCB and assembly manual. Just 4

There are some QSO's from RV3GM Log Book operated with "Micro-80":

[Kit is available at RV3GM](#)

Antenna - Long Wire (36 m up)
 Band - 80 m 300 mW output

Date	GMT	CALL	My RST	Report
02 Mar. 1989	19.05	UA1ARA	569	nr Leningrad
17 Mar. 1989	19.25	UV9CAI	559	Ural
31 Mar. 1989	17.45	YU3CN	559	op. Bojan, QRP 3 w
10 Jul. 1989	20.55	UA1NBW	589	Karelia, Sergey
02 Feb. 1991	21.23	DK0HSC	559	HSC HQ
17 Feb. 1991	19.33	UB5WDQ	569	Lvov, QRP 5 w
19 Feb. 1991	16.35	SM6CGG	549	Boras, op. Arne, QRP 5 w
20 Feb. 1991	19.40	RO4OZ	559	Moldova
etc... etc...				

Credit Line: **My first Station**: SPRAT, The journal of the G- QRP-C, #112, pp.: 4-7. **GNOMIC** and **MICRO-80**: <http://ruqrp.narod.ru>

And some info about RU-QRP-C

RU-QRP-C

RU-QRP Club has organized 1'st August 2002 under the initiative Oleg V. Borodin RV3GM/QRP. By the purpose of creation of Club is the association the Radio Amateurs interested by communications on the small power equipment; propagation of operation on QRP in the purposes of reduction of mutual interferences, study of propagation radio waves, boosting of skill operations in a drain ether; the help initial to the Radio Amateurs in study the RX & TX equipment and antennas, rules of operation in a drain ether; an exchange by experience and hardening friendly between the Radio Amateurs of World Wide.

<http://ruqrp.narod.ru>



The member of Club can become any Amateur interested QRP having the license. For this purpose it is necessary to send to address Club or on to E-mail announcement the any shape with the indicating first name, middle initial, last name, callsign, address E-mails, post address. Briefly to tell about achievement in QRP. It is desirable to point age, experience of operation in drain ether and whenever possible to affix in aspect of files of a format *.jpg interesting photos for a photoalbum. At an entrance to Club necessarily it is required to give datas on the achievements on QRP. Such datas is statistics on wkd/cfm QRP DXCC and 2-way QRP DXCC (separately on sorts of CW, SSB, Digital and per Bands). See special blank on the link "Join to the Club" at the site. Each member of Club receives unique Member's number.

In Club is present library with a collection technical literature on to different aspects QRP. And also the subscription to journals of International QRP of Clubs: QRP Quaterly, SPRAT, OK-QRP etc. Club is submitted on constantly International Internet - Forums QRP-L, QRPp-I, G-QRP, OK-QRP. RU-QRP Club is an associative member of World QRP Federation (W.Q.F.)

On all questions, coupled with activity of Club, with by the offers on improvement Club operations, with the interesting projects welcome to the address: P.O. Box 229, Lipetsk, 398043, Russia (for the answer apply the SASE) or by E-mail master72@lipetsk.ru RU-QRP Club's Chairman Oleg V. Borodin 72! de RV3GM

Club have a good cooperations with QRP-Clubs of other countries: QRP-ARCI, G-QRP, QRPp-I, Hawaii-QRP, Maryland Milliwatt, UR-QRP, OK-QRP etc.



Simple QRP CW Transceiver for the 20 meters

Igor Grigorov, VA3ZNW

E-mail: antentop@antentop.org

It was... Well, when it was... I guess, it was at the end 80s and in the beginning of the 90s. Perestroyka. Gorbachev. Eltcin stand on a tank... Well, it has no matter to our transceiver. At the times I was the director of the cooperative "Vibrissa." Well, it was one- man cooperative, so, I was as the director as the main worker. I did equipment for radio amateurs.

The transceiver was one of my products. I have done near 50 samples of the transceiver. It worked very well. At 1991 I sent the description of the transceiver to the magazine of the "U- QRP- C." The article is used copies of the original schematics published by "U- QRP- C. Reference Book- #3," pages 9- 10. The whole issue of the "References" is on the "CD- Antentop- V007.01"

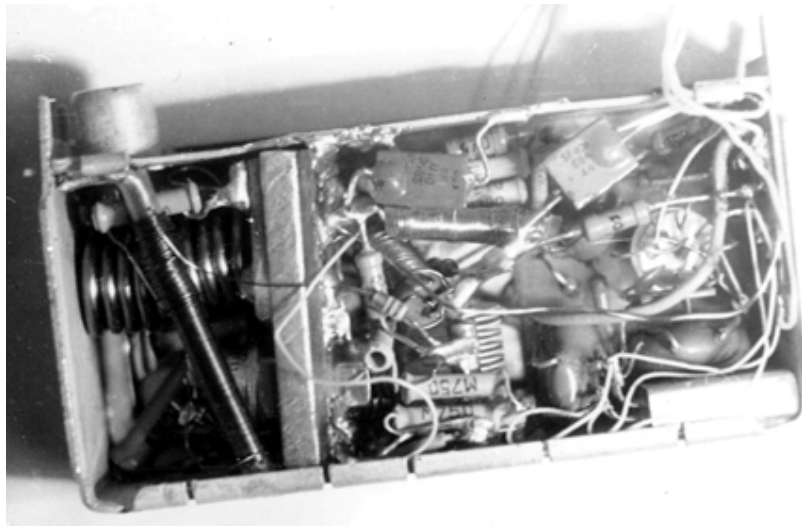

QRP CW Transceiver. View on to Parts



QRP CW Transceiver. View on the PC Board

CW Transceiver 20- Meters

(See schematic on the [page 68](#). Schematic is from the original manual. Was reproduced at "U- QRP- C. Reference Book- #3)

DATA:

RF Power: near 1 watt at 24 V.
 Range of Feeding Voltage: 18- 24 Volts
 Antenna impedance: 75 Ohms (can be any desirable)
 Quartz Stabilization Frequency.
 Shift TX/RX: 400... 700 Hz.
 VXO: 3... 6 kHz (depends on used quartz)

DESCRIPTION:

RX MODE: T1 is mixer. Used power RF MOS transistor, 3 Watts, 250 MHz.. T2 is oscillator, the same as 2N2222. Operational amplifier any available. Here used with gain 100,000.
 TX MODE: Relay P1 turns T1 to TX mode. Parts R12, C16, D1 do frequency shift on 400... 700 Hz (depends on used quartz). It is possible to use quartz both as on 7 as on 14 MHz. T1 is installed on a small heater sink, so long duty TX mode available.

I did tuning of the L1C1C2C3 to match 75 Ohm coaxial, however, it is possible to tune this one on any load in the range of 50- 300 Ohms by C1C2C3.

Transceiver can work without a quartz if you go connections shown in dotted line. Of course, the frequency would be nonstable.

PARTS:

L1- 9 turns, wire 1 mm (18 AWG), diameter 10 mm, inductance 0.5 micro Henry.
 L2-25 turns on Soviet Resistor MLT- 1, wire 0.2 mm (30 AWG), inductance 3 micro Henry;
 L3-60 turns, wire 0.1 mm (38 AWG), diameter 3 mm, inductance 7 micro Henry.
 RFC- inductance 10 micro Henry.

Transceiver was assembled in a box from TV tuner.

References: Polyakov V.T. : To the Ham about the DC Technique. Moscow, 1990.

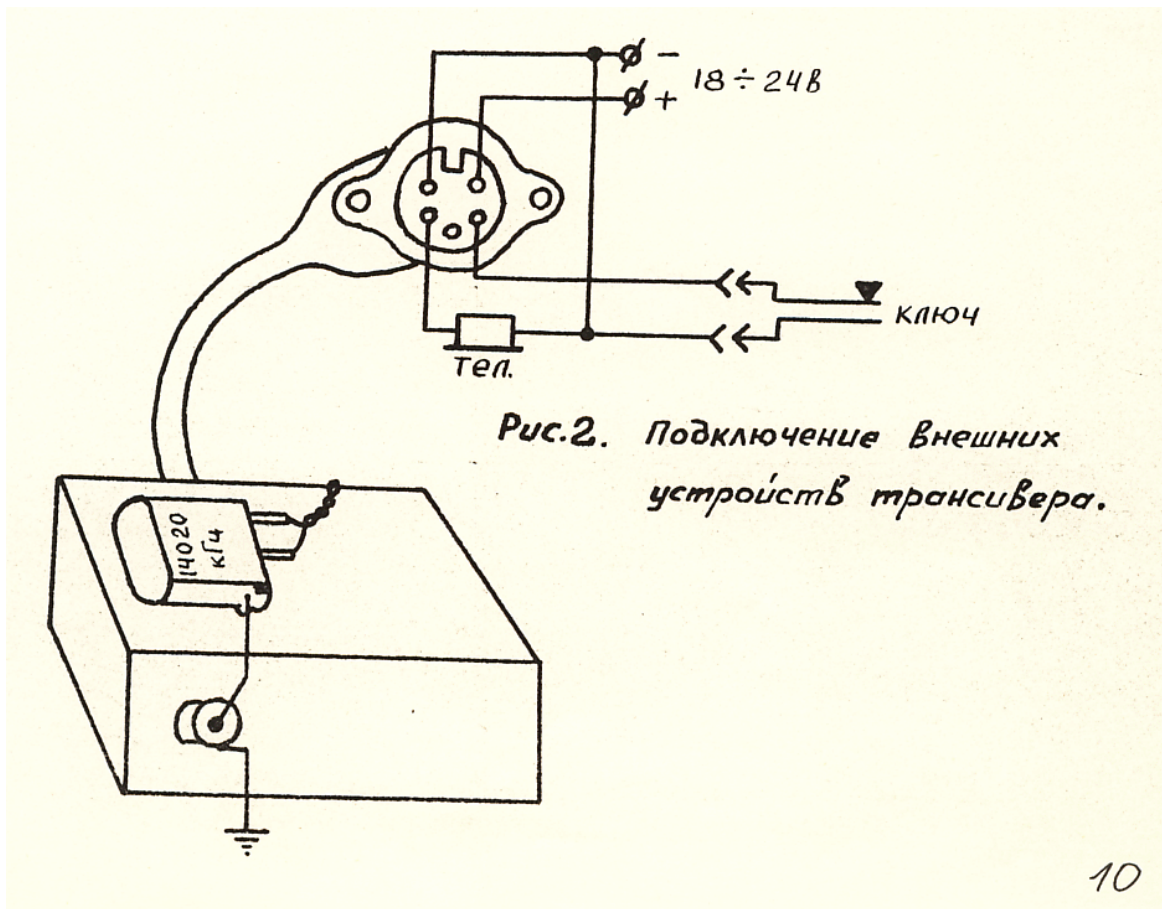

**Cable with Connector. Figure from the original manual.
 Was reproduced at "U- QRP- C. Reference Book- #3**



СМ трансивер на 7 и 14 MHz

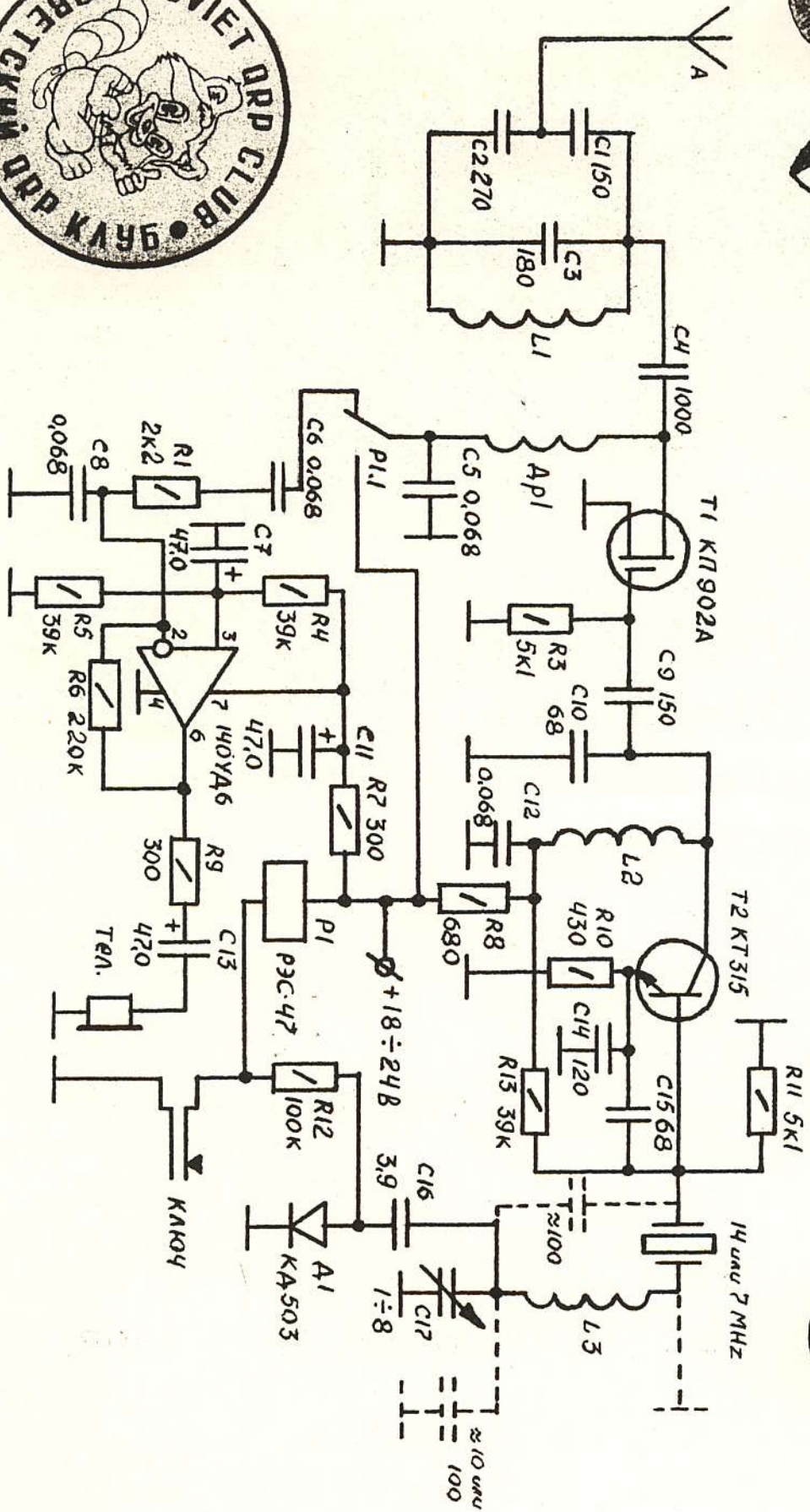

A SIMPLE SSB TRANSCEIVER

Credit Line:

<http://farhan.net.co.nr/>

by Ashhar Farhan

computercorp@hotmail.com

A dual-band transceiver with a crisp receiver and a clean SSB signal is described. It started its life as an investigation of the excellent S7C receiver described in EMRFD. This transceiver was specifically designed to use components that are easily available in TV and Radio spares shops. The receiver sports an above average dynamic range, very clean signal and noiseless performance. Although the components are easily available, and every detail about making it is covered here, this is not a weekend project. The design is elaborate and invites improvisation.

We decided to pursue the following rules in designing this transceiver:

- ▶ Use what is easily available. Very often, we find designs that look good but they use exotic parts like TUF-1 mixers that are simply impossible to get hold of in India and other countries. Instead, we have tried using those spares that are universally available.

- ▶ Keep impedances and gain low: Often, we try coaxing maximum gain out of a stage making it difficult to duplicate and stabilize. We chose to take only modest gain out of each stage, using extensive feedback to make the circuit stable. Most of the interconnections between modules are for 50 ohms termination. In fact, the rig was a number of discrete board connected using RCA audio cables and sockets before we hooked it all up together to work.

- ▶ No PCB. We directly solder the components over a plain copper clad board (un-etched PCB). It is an excellent way to experiment, physically robust and has a quick and dirty appeal. You can usually solder up a whole circuit as you think it out in a few minutes. See the pictures.

- ▶ Broadband. We wanted to be able to use broadband design where applicable. We have found that the television balun cores are an excellent and very cheap (about Rs. 2 per balun, that is 5 cents) way of making broadband transformers.

- ▶ Modest cost. While we didn't want to use very expensive components. We didn't want to compromise the performance either. You will see that we have used 2N3866 exclusively. This was because we found that the BF195/BF194/2N2222 series transistors available in the market were consistently inferior in the HF range and performed below their stated specs. The 2N3866 is commonly

used in cable TV equipment and has a good HF performance: both as a low noise small signal transistor as well as driver up to 1 watt level. 2N3866 is expensive (about Rs.20 each, but well worth the expense). It is used in a number of critical places.

- ▶ Measure what you have built. We used a 12 volt 1.5A power supply, a frequency counter, a test oscillator (to measure the crystals and coils) and a high impedance voltmeter with an RF probe to test and measure the design. All these test equipment were homemade. The transmitter design did require a PC-based oscilloscope. It helped us identify the spurs and harmonics using the in-built FFT functionality. But now that the design is complete, just an RF probe and a 14MHz receiver are enough to align the rig.

- ▶ Quality over quantity. A better signal is preferred to a bigger signal. This is a 6 watt design that will work off a simple 12V, 1.5A supply (using a single 7812).

The ladder crystal filter

A good filter is central to the crispness of a receiver and the quality of the transmitter. There are two types of crystal filters possible, the lattice filter and the ladder filter. The lattice filter requires ordering crystals with 1.5 KHz frequency difference between them. This was ruled out, also procuring readymade filters from BEL India and other sources was ruled out as it is too expensive to do that. Instead, a ladder filter was chosen. The ladder filter offers results as good if not better than a lattice filter. However, the design is crucially dependent upon internal parameters of the crystals used. It is not possible to suggest any generic values for the capacitors to be used in the ladder filter. Rather, a method to measure each of the crystals and calculate the capacitor values has been worked out. We present this here. This design procedure will work only for 10 MHz crystals. 10Mhz is the chosen IF of our filter as the crystals are easily available and it sits comfortably between 7 and 14 MHz amateur bands. We have followed the Butterworth design methodology given in the new ARRL book 'Experimental Methods in RF Design'.

The circuit centers around a four crystal ladder filter. Each lot of crystals from each manufacturer differs from the others. We will describe a way to experimentally calculate the values of the capacitors for the filter. You should probably buy 10 crystals and select 5 of them.

Circuit of the transceiver

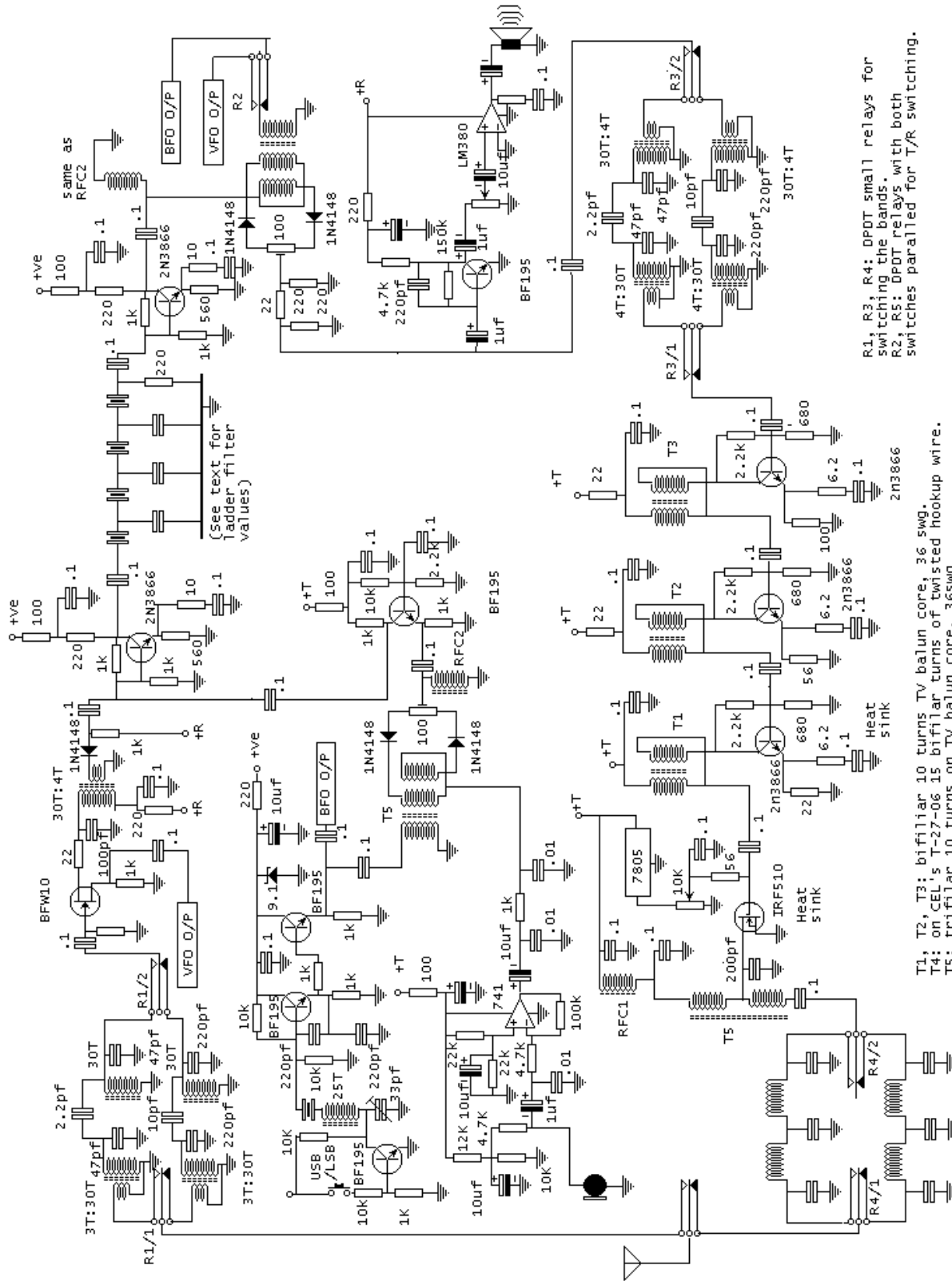

R1, R3, R4: DPDT small relays for switching the bands
 R2, R5: DPDT relays, with both switches paralleled for T/R switching.

(C) Ashhar Farhan, 2003.
 You may reproduce this circuit diagram free of charge. As long as this notice stays.

T1, T2, T3: bifilar 10 turns TV balun core, 36 SWG.
 T4: on CEL's T-27-06 15 bifilar turns of twisted hookup wire.
 T5: trifilar 10 turns on TV balun core, 36SWG
 RFC1: five turns of hookup wire through a PC SMDs toroid.
 RFC2: 25 turns on a 2 watt 100K resistor.

All other coils on 6mm former with ferrite core and shield using 36 SWG. Dont forget the shield.

VFO of the transceiver

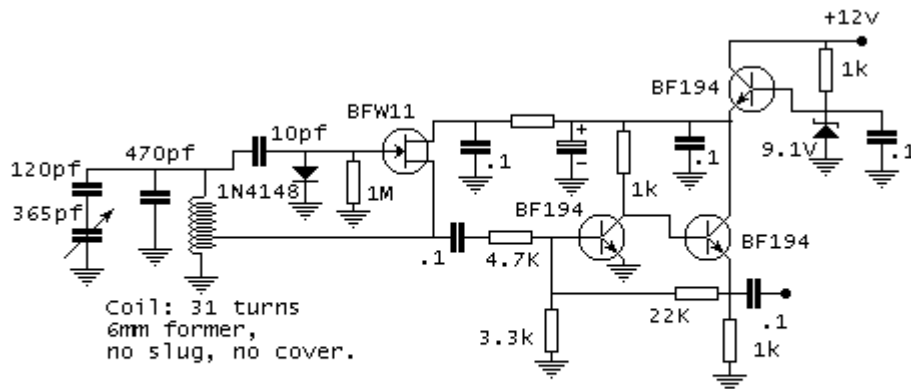

VFO: Use two identical VFOs using two sections of the broadcast gang, switch power supply for each VFO. The 470Pf should be a polystyrene or a 'Styroflex' cap. The 14 Mhz VFO tunes from 4 to 4.4Mzh.

For this purpose, construct the test circuit of **figure 1**. This is a simple Hartley-style crystal oscillator. You will require access to either a frequency counter or a general coverage receiver (ask a neighborhood ham to allow you to bring over your crystals to his shack and test them for few minutes). Mark each crystal with a number and solder it into the circuit (don't use a crystal socket). Connect the 9 volt battery and measure the frequency. If you are using a receiver, find out the frequency on which the crystal is absolutely zero. Note the frequencies with the 33 pf capacitor in series and shorted. You will have a pair of frequencies for each crystal. Select four crystals with pairs of frequencies that match within 50-40 Hz of each other. A fifth (for the carrier) oscillator crystal should be within 100 hz of the other four selected.

Fig1. Test Oscillator for Filtler Design

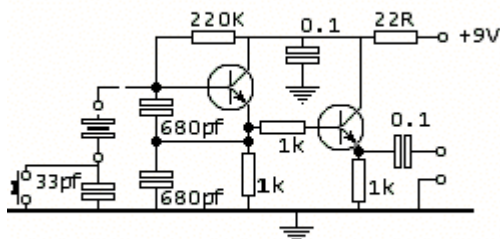

Note: Don't use a switch across the 33 pf, use a small component lead to short the capacitor.

Calculate the value of the capacitors of **Fig.2** like this:

1. Calculate the average frequency shift of the four chosen crystals as F (in KHz).

2. $C1 = 21 * F$, $C2 = 40 * F$. Choose the nearest available fixed capacitor. If you can't find a fixed capacitor within 10% of this value, then parallel two capacitors to achieve the capacitance.

For instance, in the case of the first prototype, we measure an average of 5KHz of shift. Thus, the capacitors calculated were 107pf and 200pf. We used 100pf and two parallel 100pfs as a substitute for 200pf capacitors. These calculations are for 200 Ohms termination. For a complete discussion of this design method, you are referred to the excellent paper by Craver in the Communications Quarterly of 1993, Winter.

Broad-band design without Toroids

It was decided to use broad-band techniques where suitable and keep the circuit free of too many critically tuned circuits. We decided to investigate the TV baluns as cores for broadband transformers. The TV baluns as small ferrites as shown in the picture.

Almost all the broadband transformers are bifilar. Two (the modulator and the transmit mixer cum product detector) are trifilarly wound. They are simple to produce. Making a bifilar transformer:

- ▶ Take two lengths of 36 swg copper enameled wire.
- ▶ Hold them together. Tie one end to a nail.
- ▶ Twist the wires together so that they cleanly have about 8-10 turns per inch.
- ▶ Check that the wires are evenly twisted (although there will be more twists towards the ends).
- ▶ If the balun core is mounted on a PCB, cut it out with a cutter and remove all the original windings.

Designing a 10MHz SSB ladder filter.

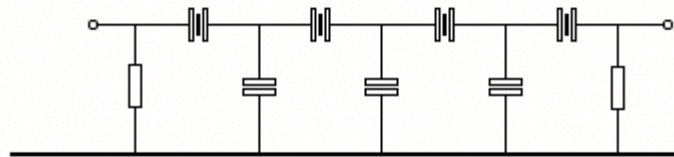

Frequency shift in circuit of Fig 1 was 5KHz
 $C1, C3 = 5 * 21 = 105 \text{ pf}$
 $C2 = 5 * 40 = 200 \text{ pf}$.

We used 100 pf at c1, C3 and 200 pf at C2

- ▶ Pass the twisted pair through one hole to the other side, bend the wire back and pass it back through the other hole (like a U turn). This is one turn, like this, make similar 10 turns.
- ▶ Cut out the remaining ends of the windings leaving about half an inch of the twisted pair on each end.
- ▶ Scrap the enamel off to about quarter inch, and tin the leads.
- ▶ Using a VOM at low ohms setting, identify the two separate windings of the twisted pair. If we call the two wires X and Y, each will have two ends A and B. This you will have four ends AX, BX, AY and BY. Short AX and BY together and use this as the center point of the transformer in the circuits. Use AY and BX as the two opposite ends of the transformers.

Making a trifilar transformer is similar, except that you have to use three wires twisted together. Separate out the three wires as before, use the first two as described above, and the third winding as the secondary.

IF sub-system

The crystal filter and its associated IF circuitry is shared between the receiver and transmitter. Although the crystals are inexpensive enough to be able to afford separate filters for the transmitter and the receiver, we noted that each filter would have a different center frequency. This would make zero-tuning difficult for SSB operation. Therefore, it was decided to share the same crystal filter, carrier oscillator and the VFO between transmit and receive functions.

The crystal filter requires 200 ohms impedance matching at both ends to provide the correct bandwidth and low ripple. A regular practice among hams is to strap a resistor of approximately

the same value as the terminating filter impedance across the input and output ends of the filter. This is incorrect. This looks like a resistor that is paralleled with a reactive impedance of the rest of the circuitry attached to the filter. When the crystal filter is not properly terminated and sees reactive termination, ripple and ringing are introduced. This will spoil the crispness of the receiver and spoil your on-the-air quality.

The crystal filter is terminated on both sides by 'strong' RC coupled amplifiers based on 2N3866. This is slightly unusual. The 2N3866 is used mostly as a VHF power amplifier. It has excellent low-noise characteristics, good gain and using it as a small signal device is now an established practice. The 2N3866 is an expensive transistor. It costs about Rs.20 in the open market. We think it is a good investment.

Using RC coupled broadband amplifiers makes the IF system a 'no-tune' affair. The output of the post-filter amplifier is coupled to a two diode mixer. The two-diode mixer uses a broadband bifilar wound transformer. It is next to impossible to get toroids in India. We have evaluated using TV baluns as substitutes for toroids. These baluns are available at most TV spare shops.

Most designs we have studied couple the RF input to the diode detector through the transformer and inject the BFO at the center of the transformer. This is a wrong practice. The diode mixer requires a minimum of 5mW of energy from the transformer input to operate properly. There should be enough energy to switch on both the diodes. This means about 1.2 v peak voltage. The received signals are rarely this level. As a result, the product detector operates like a regular envelope detector and the diodes act as distortion devices to mix the BFO with the signal. The correct configuration is to inject the BFO across the transformer

An unusual approach is taken here. The IF amplification gain is just enough to maintain good noise figure and recover the losses in the ladder filter. We measured almost 10 dB loss in the filter.

The Receiver

The receiver is minimal. By keeping the number of active devices low (3 devices between the antenna and the audio amplifier), very good fidelity is achieved. The circuit is kept at a low impedance and broadband everywhere except the front-end. This helps in stability.

The front-end uses a low-noise FET. We have used a BFW11 (because the local component shop ran out of BFW10). They have slightly different characteristics. Almost any FET can be used if it is biased properly. The FET should be biased for exactly half the pinch-off voltage. Wes Hayward (W7ZOI) has described the proper way to bias a FET Mixer for proper operation:

- ▶ Short gate and source and measure the current that flows through a 560 ohms resistor connected to +12V through the drain. This gives the exact I_{dss} .
- ▶ Place a 10K resistor between the source and the ground. Keeping the gate grounded and the drain still connected through the 560 ohms resistor, measure the voltage between the source and the ground. This gives you the pinch-off voltage.
- ▶ The FET has to be biased such that the voltage on the source is exactly half the pinch-off voltage and there is half of I_{dss} current flowing through the FET. Such a scheme assures you that the FET is driven between pinch-off and maximum drain by the VFO injected at the source. This gives the proper switching action for the mixer to operate as well as maximum gain. We measured the pinch-off voltage for BFW11s as 2.1 volts and I_{dss} as 5mA. A standard 1K resistor at the source gives the proper bias.

It should be noted here that we first tried a double balanced diode ring mixer at the front-end. It has a number of spurious responses that literally made it impossible to use the receiver. We tried to properly terminate the diode ring mixer by inserting attenuators between the mixer and the Ladder filter's pre-amp. It didn't cure the problem. When we changed to the FET mixer, the noise figure improved, the receiver's dynamic range, while unmeasured, was never found lacking in the last one month of extensive usage at VU2PEP.

The output of the IF amplifier is detected in a balanced detector using just two diodes. Here gain, we break a common myth. You will see most of the HF receivers employing a two diode balanced detector with the BFO fed to the center tap and the incoming signal applied through the primary winding of the detector transformer. This is wrong. The signal applied through the primary winding should strong enough to switch the diodes on and off

(requiring about 0.6 across each diode, that is, 1.2 volts across the winding). This roughly translates to about 5 mW power. The diodes switch the low level signal coupled at the center-tap of the coil to the detector output. Therefore, in our design we have applied the local oscillator through the primary of the transformer and the incoming signal from the IF stage to the center tap.

There is a 100 ohms preset used to null the local oscillator from appearing at the output. This is of importance during transmit where the balanced detector also doubles up as the transmitting mixer. An audio pre-amplifier follows the detector. The capacitor of 220 pf between the base and the collector ensures that the 'hiss' is kept down. The audio amplifier used is an LM380. Almost any audio amplifier can be used. We have tried everything from the PC's ampli-speakers to a Sony amplifier to a TBA810 amplifier. We would recommend using a high fidelity, low cost amplifier like the TBA810 if you plan using a speaker. If most of your work is with headphones (to save your companion from the late night QRM), we recommend the LM386.

The Transmitter

The transmitter starts with the modulator using a 741. There is a three resistor network that biases the electret microphones. We use a Phillips 'walkman' style headphone with built-in microphone for our work. The electret microphone requires a bias that provides 5V as given by the circuit.

The balanced modulator also had two 22pf trimming capacitors for nulling the carrier. They were later found unnecessary (as long as both the diodes are purchased from the same roll) and removed. If you do find balance a bother, feel free to add a 22 pf trimmer to one side and a 10 pf fixed to the other side as indicated in the schematic.

The output of the balanced modulator is routed to the common IF amplifier through a buffer amplifier using a BF195. This serves to keep the carrier leak from the modulator out of the IF string during the reception mode.

The balanced detector of the receiver also doubles up as a mixer during transmit. It is important to balance out the VFO energy at the output by setting the 100 ohms trimmer properly. We noticed a 50mW residual out-of-band output from the transmitter when the VFO is unbalanced. The power chain is an interesting broadband amplifier. You can use this in virtually any transmitter of up to 7 watts (and higher with more than 12 volts supply to the final stage). Three stages of broadband amplifiers feed an IRF510 PA. It is an interesting twist that the driver 2N3866 transistors cost more than the IRF510! The IRF510 should be biased for 80mA of standing current during transmit with the microphone disconnected (no modulation) and carrier nulled by the trimpot of the balanced modulator.

Construction

We heavily recommend constructing over pieces of un-etched PCBs. They are cheaply available everywhere. See the pictures as a guide to component layout. We recommend the following rules:

- ▶ Keep your leads short. Short connections are more important than components that are at right angles to each other. What might look neat to you might look unstable to the RF design.
- ▶ Keep the outputs and inputs isolated from each other. We have taken care to keep the high impedance points down to a minimum. But still, maintain design hygiene.
- ▶ Make one module at a time, test it completely, then move to the next one. Construct the transceiver in the following steps:
 - ▶ Make the VFO. Check the RF output using an RF probe. Check the stability on a regular receiver or a frequency counter. With the tuning capacitor fully closed (the plates inside each other), set the trimmer so that the VFO frequency is exactly 3.9995 MHz (keep 5 KHz margin at the band end)
 - ▶ Make the BFO. Check the output on the RF probe.
 - ▶ Calculate the ladder filter values and make the IF strip along with the audio preamplifier.
 - ▶ Connect the BFO, VFO, IF strip and an external audio amplifier together. When you power on and attach a piece of 2-3 meter long wire to the input of the IF amplifier you should be able to hear the atmospheric noise. Tune the BFO coil by fully screwing the slug in and then slowly tuning it out until the IF noise sounds right (not too shrill and not too muffled).
 - ▶ Wire up the receiver mixer, connect the VFO. Peak the mixer output and the RF input coils for maximum output. Then tune to a weak signal on the band and tune for the best signal. Be careful to tune for best quality of signal and not for maximum loudness. Take a break, spend a day or two listening to the band with your receiver. Nothing is more enjoyable than using a crisp receiver that you have homebrewed.
 - ▶ Wire up the modulator. If you have an oscilloscope, you can check the modulation. The modulated output will be too low for you to be able to measure on the RF probe.
 - ▶ Wire up the linear chain. DON'T solder the IRF510 yet.
 - ▶ Put the transceiver in transmit mode. Whistle into the microphone and peak the transmit mixer output coils for about 6 volts peak RF voltage on the probe at the 56 ohms resistor where the gate of the IRF510 would be.
 - ▶ Solder in the IRF510. ATTACH A DUMMY LOAD. We used four 220 ohms two watts resistors paralleled together.

- ▶ Keep the bias trimmer totally down towards zero. Attach VOM in series with point X in the power amplifier. Apply power in transmit mode and slow increase the bias until you have 80mA flowing through the IRF510.
- ▶ Connect the RF probe across the dummy load.
- ▶ As you whistle, You should get about 20-24volts of peak RF on the probe. When you pull out the microphone from the jack, the RF output should drop to complete zero. What if your transmitter is unstable?

- Don't curse your fate. All transmitters start out as unstable beasts. Relax.
- Start disconnecting power from the stages starting from final IRF510 and working backwards. When you have located the unstable stage, there are a number of things you can do to fix it.
- Try increasing the value of the 10 ohms resistor used in the emitter degeneration OR
- Strap a resistor of about 1K across the output transformer of the unstable stage to 'load' it.
- Move the linear amplifier away from the rest of the circuitry.
- Redo the board. This time spread the stages out. We guess that the linear chain should occupy about 6 inches of space, all laid out in one line.

Substitutions

The BF195 transistors can be substituted with any other HF transistor like 2N2222 etc. The 2N3866s are best not substituted. The circuit works with slight increase in the noise figure if BF195 or equivalents are used in place of 2N3866s in the IF stages. The output power on the transmitter absolutely needs the 2N3866s. Substituting them with other switching transistors didn't give good performance.

The IRF510 should not be substituted with any other transistor. The other IRFs, though rated higher, have higher input capacitance which makes them a bad choice for 14MHz operation.

The LM380/LM386 can be substituted with almost any other audio amplifier. Our first amplifier was Cambridge SoundWorks Sound System. If you turn down the bass, they are an excellent system for the shack. We have tried a TBA180, an LM386, an LM380 and even a glow-bug guitar amp. Feel free to experiment.

Final Notes

The first contact we made using this rig was DF6PW. He reported us 57. Within the first evening we had worked four continents. The rig is regularly used at VU2PEP. People are often surprised at how the transmitter quality is 'just like a commercial rig'. Many refused to believe that it is a seven watt rig.

72/73!

QRP TX

80/40 meter CW Transmitter with 6BM8/ECL82

by Jan, SM5GNN

Credit Line:

<http://www.algonet.se/~janax/ecl82bug.htm>

This is my own variation of the triode/pentode family of glowbug transmitters. It features a Pierce oscillator which runs continuously during transmit to avoid chirp. The PA is grid block keyed and since the negative is there, fixed bias. The bias setting is not critical, grid rectification will provide additional bias and form a sort of regulation network. The PA is biased into class C, adjust bias for about -24V at keydown, measured at the junction of the 3 resistors. Plate current should be around 35-40 mA when fully loaded, depending on crystal activity. Power output is 5 to 8W at 12W input which is a healthy 66% efficiency (not counting the screen current) and a nice blue glow comes from the innards following the keying. My original plan was to use a Pi-L tank to meet the modern demand of spectral purity but with loaded Q higher than normal, not really needed in this power class. The idea with grid blocking was to enable me to use my keyer without any relay in between. It has a negative keying line with a 250V filledstate device behind.

When tuning up, mesh the loading condenser C2 fully and dip the plate with the tuning condenser C1, quickly! Plate current should dip down to around 20 mA. Unmesh the loading condenser C2 until the current just stops rising or maximum 40 mA. Redip the plate. Repeat until the dip is shallow, a few mA. Do not tune for maximum output, the PA is not neutralized and will run beyond maximum tube ratings if this is done. If maximum output goes over 9W or loaded plate current over 40 mA, lower the plate supply or back off the grid condenser a little or mesh the loading condenser a little. The plate current should not exceed 40 mA fully loaded (ah, well, the tube is still available from Russia :^), maximum allowed cathode current is 50 mA for this tube. I have installed a 100 mA meter in the wire going to the plate of the PA. The glowbug is free from chirp and runs smooth. Keyline filtering seems to be unnecessary but check the envelope if you are driving a power amplifier with it. I have found that the grid condenser could be replaced with a 47 pF fixed for FT243 rocks and 15-22 pF for modern tin can rocks.

T/R switch? I use a rotating switch with 3 poles, one for switching the antenna, one for +300V on/off and one for the receiver mute. If you use a regenerative tube receiver, antenna switching isn't really necessary, use a separate short wire as RX antenna or couple lightly to the TX tank. The regen grid leak and coupling condenser should be adjusted for proper recovery between the code elements (full QSK)

or perhaps between words. Only a simple rocker for the +300V is needed.

Spotting? Well, my Heath SB301 gives this away for free. Set the RX in receive mode and engage the T/R switch without keying. You will hear the triode oscillating in the receiver. Tune it in and reset the RX in standby mode again. Advantage, gridblock!

Sidetone? Many ideas here. I use my new keyer's sidetone. My previous keyer did not have sidetone, instead I used my TS-830 as a growler, he, he... Or use a small 50 mA lamp in series with the PA plate as a sidelight :-), at least at QRS speeds.

Circuit layout? Not very critical. Only one tuned element except the rock is present. As a starter, keep the triode circuit on one side of the tube socket and the PA section on the other. Use the middle stud on the tube socket as a common grounding point if there is one. Keep the rock at least 2 inches away from the tube envelope to avoid heating it. The schematic does not show the heater, ground one side and decouple the other side at the socket with a 0.01 ceramic condenser. Heater voltage is 6.3V. If it exceeds 6.6V when loaded by the tube, add series resistance until below for maximum tube life. My own is built in a aluminum cast box with all circuitry inside it except L1, C2 and the output choke. If you use loads other than 50 ohms, some fiddlin' with the tank may be called for. You can also replace the pi tank with a link coupled parallel tank. For data and pinout on the tube, see [ECL82 tube data](http://www.algonet.se/~janax/secl82.htm) (<http://www.algonet.se/~janax/secl82.htm>)

Running rock bound? Not easy. You call CQ. Don't wait on the rock QRG for others unless others knows about you. Sometimes you hear another station calling CQ near your rock QRG. Give him a try, he may hear you. It might be easier to use the QRP QRG 3560 kHz. In US, 3579 kHz is a common rock QRG. Use a 3579R545 kHz color burstie rubbed down a tad. In EU at night, most glowbugs seem to stay around 3560-3565 kHz.

Simple QRP TX for the 40 meters

Credit Line:

"U- QRP- C. Reference Book- #3" 1991 year.

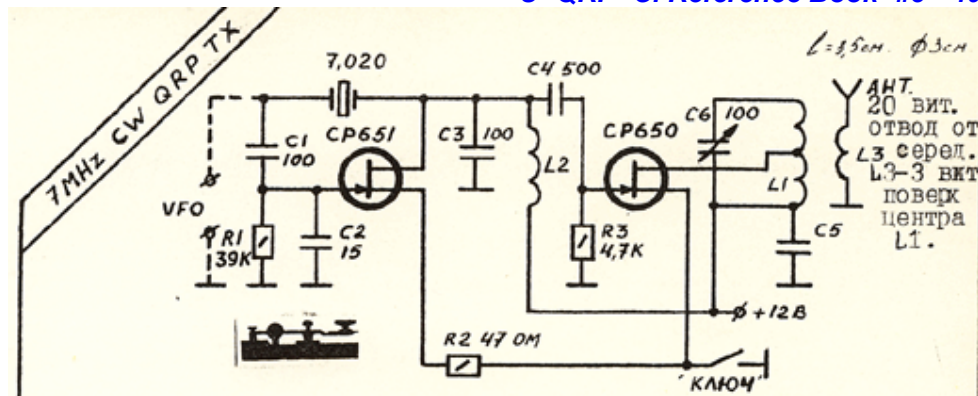

At QRP rubric at Antentop 01- 2005 I use stuff from old Soviet QRP magazine published by the U- QRP- C at 1991. It was named "U- QRP- C. Reference Book- #3," you can see its cover at the right. The schematics, which were published there, are very interesting till now.

The simple QRP TX used two FETs was published at "U- QRP- C. Reference Book- #3," page 4. I have done the TX, it worked pretty well! I have tried it in several ways. Pair low power FETs (300 MHz, 300 mWt) did very good job, near 200- 300 mWts output without problem. I put in parallel up to 5 the same transistors (instead output transistor), it gives near 1 watts, the transistors were without a heat sink. Of course, good results were obtained at first FET (300 mWt, 300 MHz), second MOS, 300 MHz, 3 watts. I have near 2 watts at 24 Volts.

If instead C2 you use a variable capacitor, you can use quartz for 3500 or 1750 kHz. Of course, the transmitter works good at another bands, for 30, 20, 15 and 10 meters, however, the power is dropped. At 80 and 160 meters the TX has good power and clean tone. I did experiments with the TX and RF- generator, I removed the quartz, and put output of the generator to clips 'VFO.' So, I have got very nice small TX, that worked very good.

Data: L1= L2: diameter 30 mm, winding length 35 55, 15 turns, L2 tap from middle, L3 3 turns above center L2.

I strongly recommend you try the simple TX.
73/72! I. G.



First page of the
"U- QRP- C. Reference Book- #3'

Figures of the TX are reproduced from "U- QRP- C. Reference Book- #3.'



QRP RX

A Regenerative Receiver with 6SN7GT

by Jan, SM5GNN

Credit Line:

<http://www.algonet.se/~janax/myregen.htm>

This is my October regenny as it looks right now. It works but more adjustments must be done before I'm happy with it. It's based on the 1950 ARRL handbook design. The original had plate voltage regeneration control but I found out quickly that the throttle condenser approach is the correct way to go. I did not have an interstage transformer so I took a small power supply choke instead.

I also added a volume control, at 40 plate volts, the output transformer into 16 ohms headphones, my ears nearly blew off.

First I heard nothing, then I got Deutsche Welle in on the 41 meter band. After that I found that I had the dummy load connected...

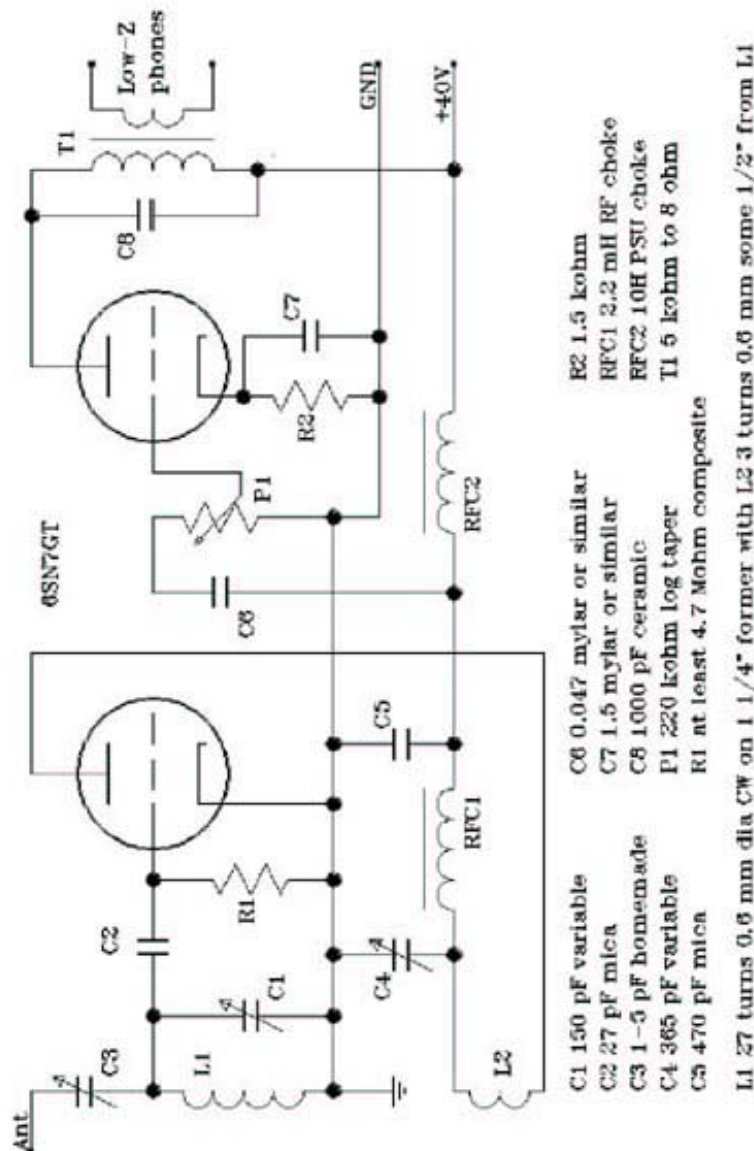

Simple Regenerative Receivers

The simple regenerative receivers were published at "U- QRP- C. Reference Book- #3," page 6. I have done the receivers, they work pretty well!
73/72! I. G.

Credit Line:
"U- QRP- C. Reference Book- #3" 1991 year.

DATA:

Transistor can be any RF FET. Output transformer can be any output transformer from a transistor radio. L1 depends on used band. I used collections inductors wired at form diameter 20 mm with wiring length 25 mm. For 10- 20 meters, L1 contains 9 turns, L2 contains 2 turns near cold end L1. For 20- 40 meters L1 contains 15 turns, L2 contains 3 turns near cold end L1. For 80- 160 meters L1 contains 45 turns, L2 contains 10 turns near cold end L1. Antenna capacitor 120-pF may be 2- 120-pF in value.

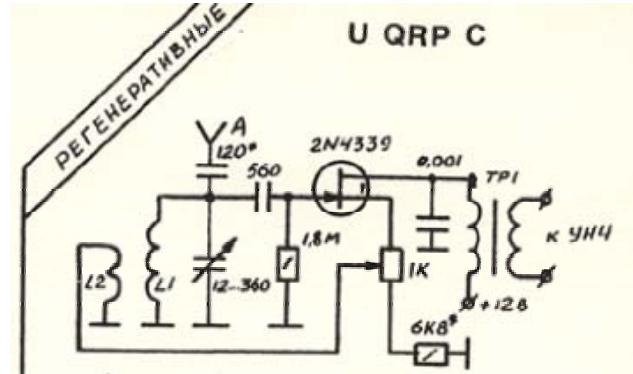

Use the two- tank circuit at input clips of the receivers. It gives you cleaning from unwanted stations and provides your thin Air.

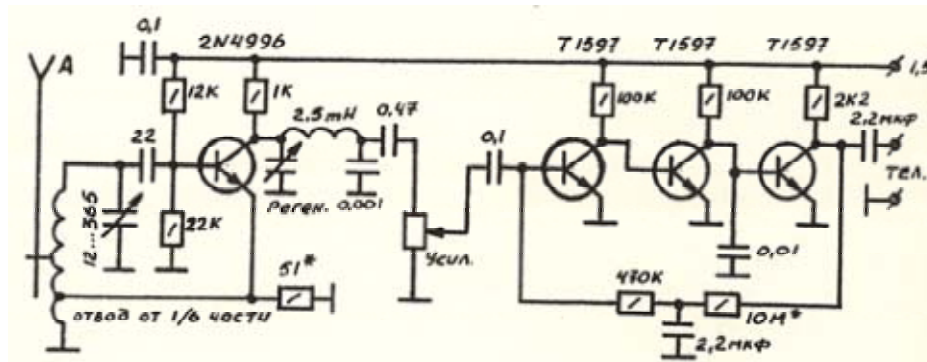
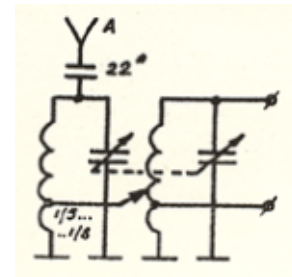

Data for L the same as for above receiver. Tap made from 1/6 parts of the L. Resistor on *51 Ohm should be pickup for used band (or, the same, used L). Inductor for 2.5 mH is home brew, it contains 200 turns onto a ferrite ring 20x12x4 mm, permeability 600. Transistor used in regenerative stage should be good RF transistor with f = 300 MHz, and gain =100 and more. Any audio transistors can be used in audio amplifier.

Hope, you will have fun with the receivers!
73! Igor, VA3ZNW

Figures of the receivers are reproduced from "U- QRP- C. Reference Book- #3."



QRP PA

QRP PA for the 10 meters

The QRP PA was published at "U- QRP- C. Reference Book- #3," page 3. I have done the PA as well as for 10 meters as well as for others high (20-12 meters) amateurs bands. It works well! It gives near 1 watts to 50(75) Ohm load.

73/72! I. G.

DATA (for 10 meters):

L1, L2- RFC, 10 micro Henry.

L3- 7 turns, wire diameter is 0.7 mm (21 AWG), form diameter is 7 mm (used old inductor from IF tract of tube TV, the inductor has a ferrite core), tap from 2 turn from cold end;

L4- 5 turns wire diameter is 0.7 mm (21 AWG), form diameter is 7 mm (used old inductor from IF tract of tube TV, the inductor has a ferrite core);

T1- f= 300 MHz, gain 100

T2- f= 600 MHz, gain 50, 3 watts output. Need be installed at a small heat sink.

Figure PA is reproduced at "U- QRP- C. Reference Book- #3.'

Early 1991 the PA with some modifications was published at different References, one of them:

Polyakov V.T. : To the Ham about the DC Technique. Moscow, 1990.

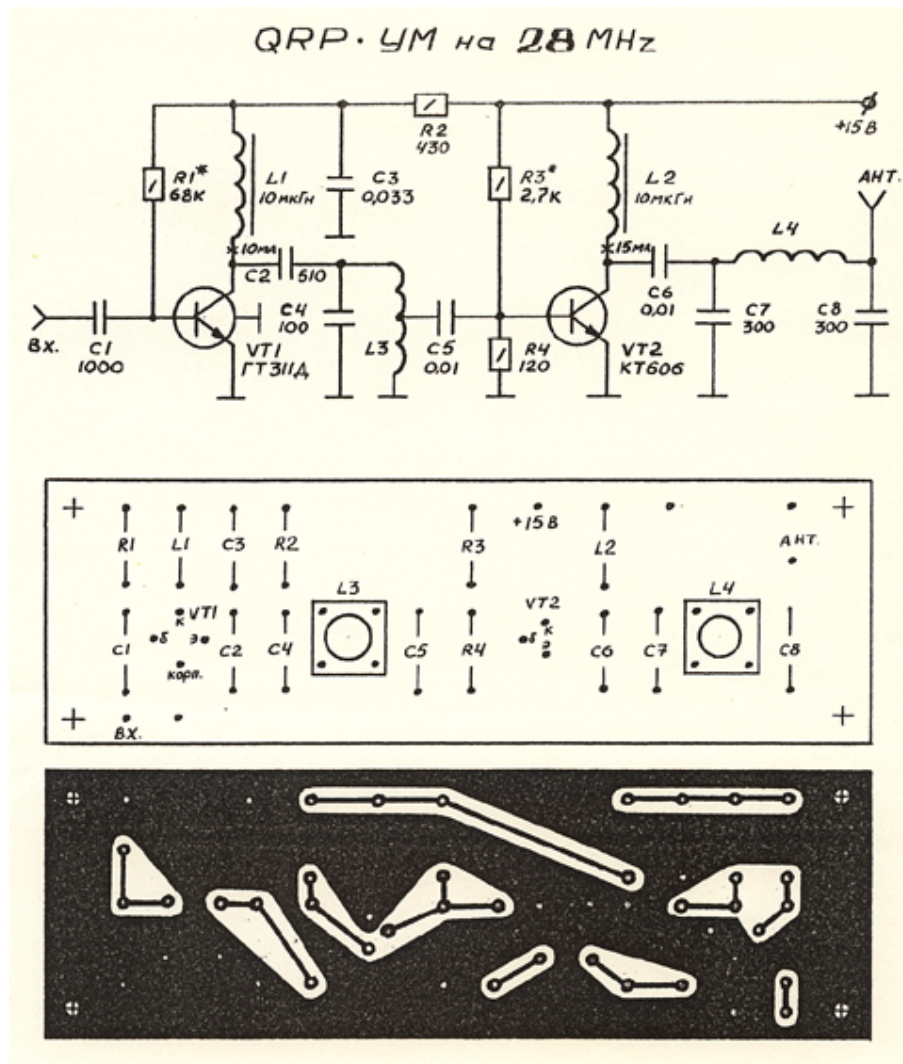

ANTENTOP Free e- magazine edited by hams for hams
www.antentop.org

KEYS for QRP

Keys for QRP- expeditions

by Igor Grigorov, RK3ZK

G-QRP-C # 6363

The two articles were published at SPRAT, the journal of the G- QRP – C # 114 and # 115 accordingly. However, I think, the keys will be interesting for all amateurs.



Telegraph key for a QRP-expedition

It is a problem what a key to use in a QRP-expedition, hand or electronic. An electronic key does not provide a good operation at a QRP-expedition for the following reason. At first, it need in an external feeding for it, at second, as rule an electronic key made on the CMOS (Complementary Metal Oxide Semiconductor) chips is undergo of dampness. From dampness it would leave out of operation in the most improper moment. A standard telegraph key, usual for routine radio amateur activity, is complicated in application in field conditions because the key should be reliably fixed to any fixed base. The matter is not always possible in a field QRP-expedition. Often expedition key is keeping in one hand (or even on a knee) and by other hand working on it. Certainly, it is very inconveniently for

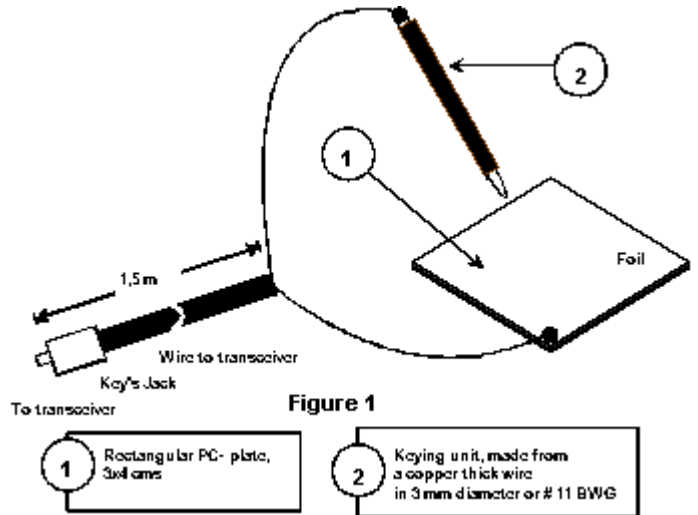

job in the ether and rate of transmission is very low in that case. My special self-made a hand telegraph key has no the defects. Fig. 1 shows drawing for the key.

It consists of from a rectangular part of PC- board (item 1), which is connected to “ground” of a transceiver and a keying unit (item 2), made from a copper thick wire in 3 mm diameter or #11 BWG, or # 9 AWG.

At operating in the ether the rectangular part places in a hand, on a knee or on any fixed basis. The other arm does keying. Ever it is possible to paste this slice of PC – board with help of an adhesive tape to a transceiver case or to floor of a tent. This key was used at operation from any possible most inconvenient positions. For example, laying in a tent, and even laying in a sleeping bag. Certainly, the keying rate is not so high, up to 60 symbols per one minute. But it is quite sufficient for operation from a QRP expedition, where the high speed do not use usually.

Electronic keying for an electronic key

When I used an electronic telegraph key made on CMOS chips during my QRP- expedition, I found out that the key is very sensitive to dampness. Even when I covered a PC- board of the key by paraffin (it is possible easily to delete paraffin with the help of hot water and after that with petrol, if a repair is necessary), the failures in activity of the key continued.

Also I found out that small drops of water influenced on key operation, i.e. the drops covered contacts of the key’s manipulator and go to false operation.

Only reed relays (magnetically operated with hermetically sealed contacts) helped me to solve that

problem and make reliable work of the electronic key in field operation.

Only reed relays (magnetically operated with hermetically sealed contacts) helped me to solve that problem and make reliable work of the electronic key in field operation.

The reed relays were placed on the PC- board of the automatic electronic key, near keying “dot” – “dash” chip. I used old reed relays, taken from burned old relay of a telephone station. Fig. 1 shows the scheme of the unit. The PC- board of the automatic electronic key with the reed relays was covered with paraffin. Manipulator of the key was placed outside the key’s body. The reed relays had a self-made windings. Each winding contained several thousands turns, coiled by copper wire 0.1 mm in diameter or #36 BWG.

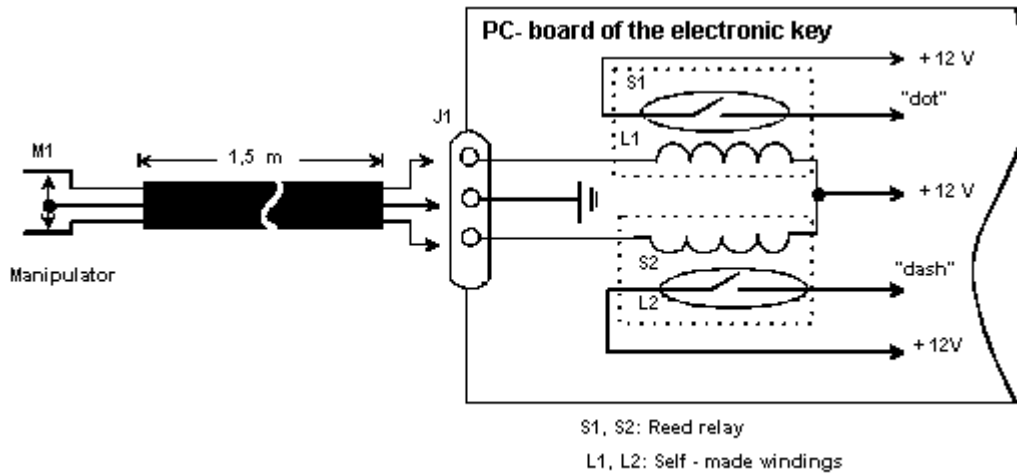

Figure 1

Winding of reed relay consumed current near 3- 4 mA at 12 volts of key power voltage. Such small current did not load much key battery.

The electronic telegraph key, consisted of such electronic keying unit and PC-board covered with paraffin, reliably works even while raining. Also the key was serviceable in the morning when both key PC-board and manipulator were covered with dew.



Home Made Key for FT- 817

Yuri Murashev, RX3AEW

Sorry for pictures' quality – they were taken by my cell-phone. The design of the key is simple, see **Figure 1**. Three copper areas are cut on a small PC-board. Two upper ones are for 'dot- dash,' rest below is 'ground.' Copper strips with thickness in 0.5 mm are soldered to each dot- dash area, a metal end from a glass fuse is soldered to the ground area. Plastic buttons (special dash pots used at furniture) are glued to the copper strips. The PC board is placed to a little nice black box made from a metal.

The box with key board inside the one is fastened by a screw to transceiver's push-to-talk switch. The screw is screwed instead a screw (too much 'screws in one sentence!') that early was hold a clip. The push-to-talk switch has not flat surface, so a pillow made of polyurethane is placed under the 'black box.' Key wires are into push-to-talk switch cable.

While QSO the push-to-talk switch is in the left hand, by the hand do turn RX/TX, keying do by the right hand.

73/72!

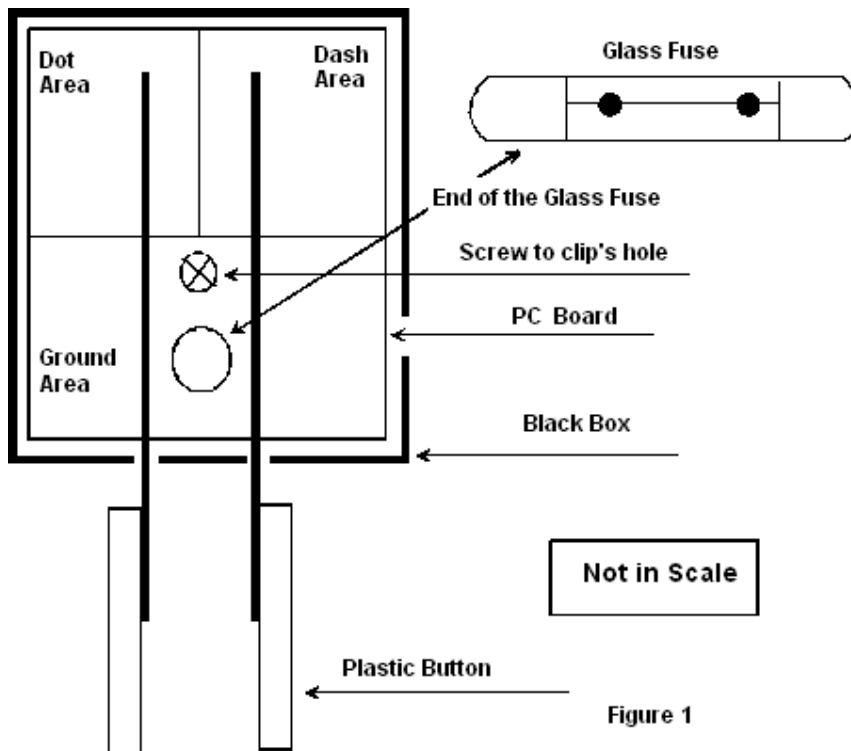

Figure 1

QRP STORY

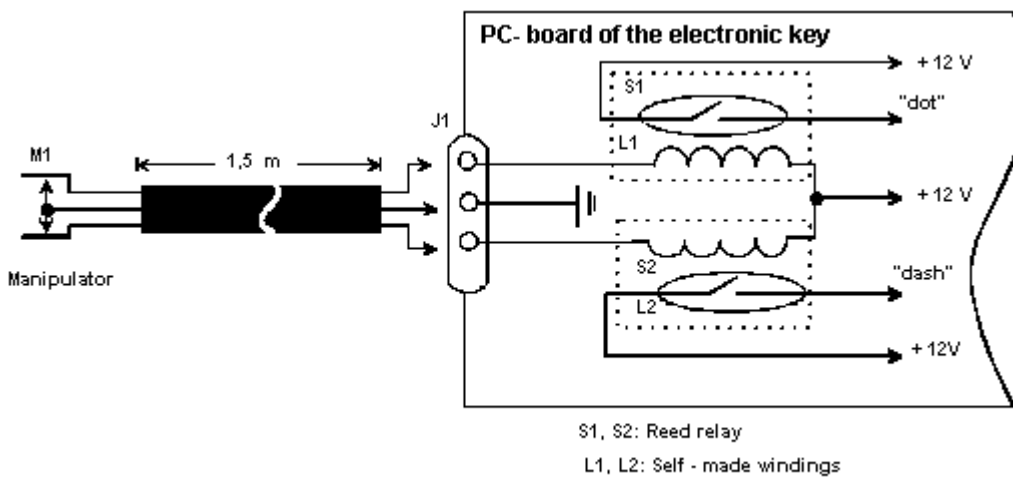

Figure 1

QRP beyond belief

by Igor Grigorov / RK3ZK

G-QRP-C # 6363

The article was published at SPRAT, the journal of the G- QRP – C # 114. However, I think, the keys will be interesting for all amateurs.



Work on QRP is wonderful when with only several watts of power to do a DX QSO. But the surprise is especially great if a radio amateur does not know that he works on QRP... later he looks into his log and does not believe it! About such improbable work on QRP I want to tell.

Photo: December 10, 2002



It took place on the 10th of December 2001, during the QRP expedition on Ai - Petri plateau. This expedition was held in honor of the centenary of Marconi's First Transoceanic radio contact. The UR-QRP Club arranged the expedition. The call EN100GM was used. We used an old military Russian made radio R - 143. It provided 8 watts RF- power at 1.8 to 18 MHz. An ATU (Antenna Tuning Unit) (see reference [1]) was used with the military transceiver. Fig. 1 shows the scheme for the ATU.

By mistake, one of the operators connected our transmitting antenna to jack J4 instead of jack J2. In other words, our antenna was connected to R4, the dummy load, installed inside the ATU. The dummy helped to do right matching a transmitter with the ATU.

antenna, connected to R4, not to the transceiver. It is beyond belief, but we made 21 QSOs! One QSO was made on a range of 40-m, three QSOs were made on a range of 17-m and the others 17 QSOs were made on a range of 20-m. Only casually the mistaken connection was detected when we could not make QSOs on a range of 80-m... Tab. 1 shows the page from EN100GM log with the QRPP QSOs..

So, during several hours we worked in the Air with the

QRP- TALES

By Alexei Rusakov, UA4ARL/qrp (RU-QRP # 005) ua4arl@vistcom.ru

September 13, 2002.

The day before yesterday I decided to hang my ZL-antenna for 20m in another direction - and so sad it was for me, fixing the last point I broke director wire. My antenna made of D6mm antenna-rope had been already used for 2 years and I had no any desire to prolong it's term

Yesterday I switched to two alternative dipoles instead.

Today in the morning I started tuning my new 2-el Beam of D3mm bi-metall directed North-South strictly. On 20m SWR that's 1point2. And just after it I tried SWR on other high bands. On 10m band the SWR was 1point4. And on 15m band [CW] SWR surprised me with 1point1. I'd just only checked SWR not changing tuning from the middle of [CW] on 15m and switched on my soldering iron on in order to changeall temporary contacts for cable [SO-239]s. Frequency, once established, was the same.

Early morning. The band's not opened yet. The sweet noise sound pouring from speaker-phone. I've switched off one of the dipoles and the other was still wired to transceiver. Still soldering. And just that time I'm hearing on that frequency someone asks for "QRL?" and in a half a minutel hear "CQ CQ de 9U0X".

I switch to another antenna - that was [Delta for 40m] and lost him, and while immediately returning to the dipole I have RST 539. I'm hurring to cacth my



luck, trying to repair my hand-made connections, but wires were already cut for soldering and so it's a great deal to screw them all once again. I have two bulks of wire under my legs, and on my knees, so hard to screw because the coax-cable is so thick and hard. So I connect the antenna cables together manually using the newspaper as isolator!!

When the second dipole added the signal up tp 559. I ask him at QRP, he doesn't reply, and QRO I don't use [interestingy].

Three minutes after other HAM's came and one Italian station invites me SKED 18.085 kHz. My [delta-loop] hear nothing and Beam SWR - unlimited. I used my 20m Beam and received RST 559 in answer!!!! And that pal from Italy asked SKED 24 MHz once more. I follow them. Delta-loop is empty and Beam SWR the same as on 18MHz. I call and have 559 in answer!!!! QSO at 08.35z u 08.38z.

9U - Burundi - my new country reached on QRP (204).

Credit Line: : <http://rugrp.narod.ru>

International QRP frequencies:

Band	Frequency, kHz
160	CW - 1843
80	CW - 3560 SSB - 3690
40	CW - 7030 SSB - 7090
30	CW - 10106
20	CW - 14060 SSB - 14285
17	CW - 18096
15	CW - 21060 SSB - 21285
12	CW - 24906
10	CW - 28060 SSB - 28360

<http://www.antentop.bel.ru/>

<http://www.antentop.bel.ru/>



QRP- TALES

By Alexei Rusakov, UA4ARL/qrp (RU-QRP # 005) ua4arl@vistcom.ru

Continued from ANTENTOP- 02-2003

On 25 May 2003 I worked the WPX-CW contest. I started calling CQ-WPX at 0000Z but was only answered about every fifth time. After about an hour I had only 18 QSOs on 80 meters. I started calling CQ just to see how the propagation was. At 0120Z TO5AA was 559. Finally I was able to work Europe a bit.

Yesterday, before the WPX-CW contest I heard someone call CQ. The signal was right at the noise level, so it was impossible to copy. Even my 500MHz filter didn't improve the signal. I fine tuned and the RST finally got up to 339 and I recognized

part of his call sign, 3?2N?, but with QSB. He continued to call CQ but had no response. The RST got up to 559. The call sign was 3D2NC. I gave him a call. No answer. I called again. He said RPT AGN, but there was a European station calling him and he went back the European. On my third attempt he finally came back to me. Sadly he gave me the standard RST 559 for my QRP signal.

At 1101Z I heard no body calling. . I waited for a few minutes more. Then a few stations from Siberia and Europe started calling. They probably heard the pile-up for 3D2NC, whose signal peaked at 569. After about 30 contacts his signal dropped and I couldn't hear him any more. I was interested in how well he was heard in Siberia so I sent an e-mail to UA0_____ asking how well the European station was heard there.

On 20 meters signals from far Europe were 559 and on 15 meters they were 579. The frequency of 3D2 is free now. Is somebody calling QRL ? I waited and heard CQ CQ de A3JJ A3JJ K. Immediately a few stations called him. A3JJ answered a Dutch station and giving "... de EA3JJ". After first QSO the pile-up disappeared.

Today I heard RZ6HX/QRP on 21 MHz.

72! Alexei, UA4ARL/qrp



The RCC had a contest on 26 April 2003. Propagation was poor for both short and long skip, but I did make 150 QSOs. However not many contacts were QRP. After the contest I listened to the upper bands without luck. 15 meters was dead as well as 10 meters. I listened to HF in the evening and it was dead also.

The weather in Volgograd is very unstable now. Friday the high was +19 C, Saturday it was only +5 C.

Victor, RZ4AA, shares QRP experiences with me. He said "After every contest I always hear HF. Usually propagation is better than before the contests. The contesters have gone back to their other rigs and then it is possible to work 5 watts QRP DX without any problems." Last weekend he had about 20 QRP QSOs into South America (LU, CX and PY) using 5 watts and dipole antenna up about 5 meters. He worked one LU station who was also running QRP and they both exchanged RST of 579!

I next listened to 21.00 MSK. I heard the Switzerland contest. The propagation was improving some now. I tuned to the DX window and heard someone transmitting "...ON /QRP. His RST here was 589 and he was talking to Belgium, but I couldn't hear the Belgian station. He told the Belgian station that he was using a K2 txcvr. When he said 73 and gave his call sign, I was surprised to hear VK9XK! I gave him a call and he came back to me on the first try. He gave my RST as 599. His QTH was Christmas Island. Great FUN!

72! UA4ARL/qrp Alexei Rusakov

Credit Line : <http://rugrp.narod.ru>

QRP- TALES

By Alexei Rusakov, UA4ARL/qrp (RU-QRP # 005) ua4arl@vistcom.ru

Continued from ANTENTOP- 03-2003

1st March, 2003

The ARRL phone contest was today but propagation was bad into Volgograd. Even the CW portions were quiet. I checked all the CW portions of the bands this morning and figured that everyone was on SSB. In the evening I went back to check the condition of the bands but 21.060, 24.900 and 28.060 were already gone. While in 15 meters I slid down the band and heard some Europeans. LP's were 549 - 559 while HP's were no louder than 589 here in Volgograd. Around 21.006 there was someone that had a 559 signal with 3 or 4 stations calling him. However, he

didn't give his call sign while I was listening.

I changed antennas from a North delta to an Africa oriented 2 element and the signal went to 579. That is a good sign, I thought. Suddenly DX starting sending CQ CQ C98RF UP. I tuned the signal in with anticipation. I went up 1.5 kHz and called, but without the /QRP. I must have been the only one that answered him because he came back to me on the first try! I then told him that I was running QRP.



After our QSO was over sounded the orchestra of calling stations on the same frequency. I sat and enjoyed listening to the pile-up of DXers. Easy propagation for about an hour and a half then the signals went down to 459.

72! UA4ARL/qrp Alexei Rusakov

Credit Line : <http://ruqrp.narod.ru>

A QRP-QSO WITHOUT AN ANTENNA

October 5, 2003. Robin, M5AEF, had an unique CW QSO with RX3BO from Moscow at 17 meters using only 1 watt output. You say 'it is nothing especial for 17 meters', but what do you say, if you know that Robin did not use any antenna?

Yes, Robin was doing a calibration for his FT- 757, and this one was connected to a dummy load. An antenna did not connected to the transceiver at this time, the antenna was connected to monitoring receiver, that does control for quality of the output signal from FT- 757. So, Robin heard Anatoly, RX3BO, from Moscow and they had QSO with each other. Robin had received 559 from Anatoly for his dummy- load antenna!

Dear Friends,

you can read about a QRP- QSO without antenna also at ANTENTOP – 01-2003.

72/73! I.G,

Some minutes later Robin connected his usual 1,5 lambda antenna to the FT – 757 and did QSO with RX3BO. Robin had received 579!

Don't say me that there are no miracles!

With the best regards!

Oleg ("Master-72") V.Borodin

72! de RV3GM (UE3QRP)

Credit Line:

<http://groups.yahoo.com/group/ruqrp/>



ANTENNA TOOLS

TOOL FOR PULLING GUYS

by Victor. RN9FAB viacon@permonline.ru

For several years I use to a home-brew tool, that I made by myself, for pulling guys. I made it of 8 mm of steel plate. The tool holds any guys, for example,

bimetal of diameter of 4-6 mm, steel rope, wire rope. Picture shows how the tool holds the guy.

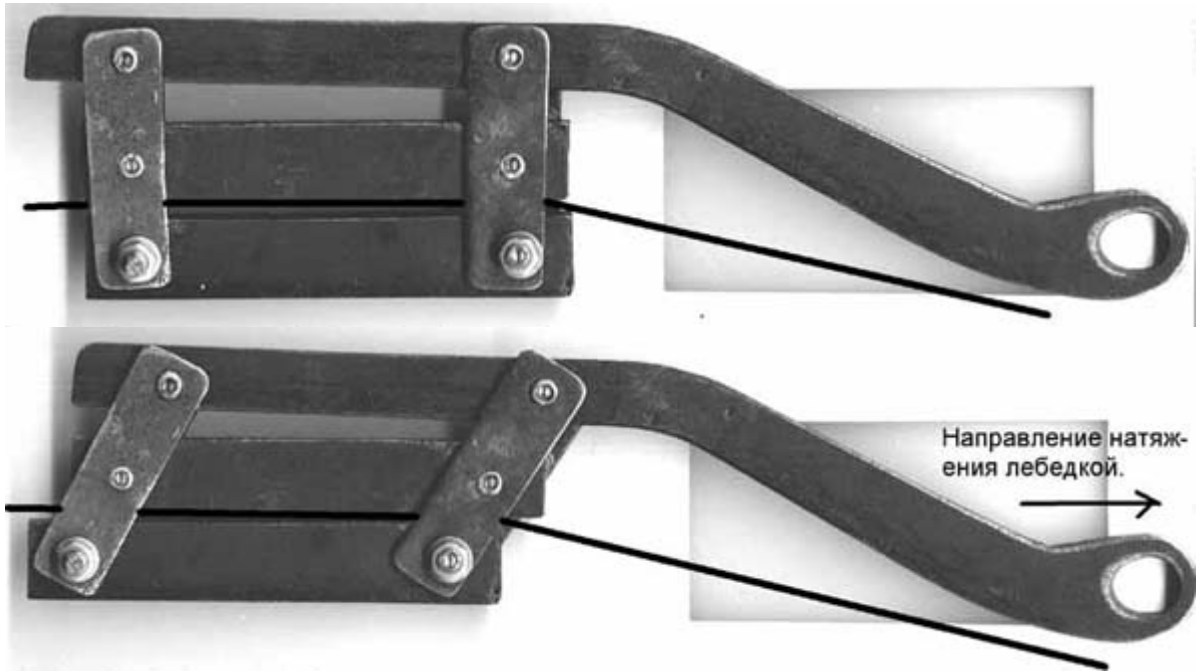

A winch is attached to the hole in the tool and placed by the place where the guy is fastened.

You can very easy move the tool onto a guy. The tool does not bite a guy at pulling. When a guy has been pulled, the tool removed by unscrewing the bottom plate.

Everyone can design the tool to needed sizes, proceeding from own needs. Force of capture is defined by a difference of shoulders of cross levers to which fasten plates. Plates have longitudinal growing-through at the place where it hold a guy.

RECYCLING CHOKES FOR THE LF-BAND

rsgb_lf_group@blacksheep.org

When experimenting on the LF-band chokes with inductances of some mH are often needed. They are not so easy to get in these days. Those in the junk-box from the tube era are often quite big.

Do you have low-energy lamps that are not working any more? Before giving them away to recycling do the following:

Carefully disassemble the electronic part with a screwdriver. Inside there (among some other things) is a choke with an inductance of 1.8-17mH (depending of the power and the make of the lamp). They chokes are very small, approximately

Urban Ekholm, SM5EUF
urban.ekholm@hem-pc.bip.net

12x12x15mm. I have measured the Q of some of them and it was between 10 and 25.

Caution: Yes, of course you have to be careful not to apply any force on the glass part of the lamp. I have taken between 5 and 10 lamps apart and used the method of holding the socket with a glove firmly against a piece of wood. Then using a small screwdriver to carefully bend the socket into two parts. By doing in this way no force is applied to the glass. When the socket is divided into two parts it is an easy matter with a small sidecutter to cut the wires going to the filaments.

Happy recycling !

<http://www.antentop.bel.ru/> mirror: www.antentop.boom.ru

Page 12- 1

FASTENING OF GUYS

by Nick V. Derenko, US8AR

Made in Ukraine



ex UB5AEO, UB4AR <mailto:us8ar@qsl.net>
<http://www.qsl.net/us8ar>
<http://us8ar.narod.ru>

Different ways apply for fastening guys to a mast or to antenna elements. The common way is to drill holes in the tips. It, undoubtedly, results to easing of rigidity of towers and antennas both. At the same time it is possible to apply "sparing" method of fastening of guys.

Takes a kapron cord. From this one do loops for fastening guys, as it is shown at **Figure 1**. (where Dt is - diameter of a tube).

Several loops is put to the chosen place on a mast or on antenna elements and attached to these ones by usual

Figure 1. Loop for fastening guys

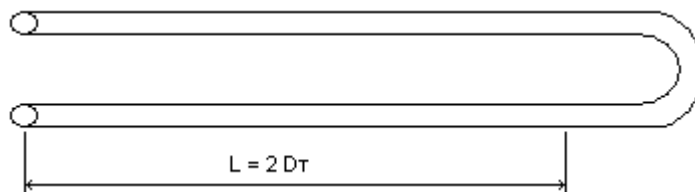

threads. Here we do attach a binding cord as it is shown in **Figure 2**.

Further, using cordlike binding, we adhere loops to a tube as it is shown in **Figure 3**.

Figure 2. Preparing loops for fastening guys

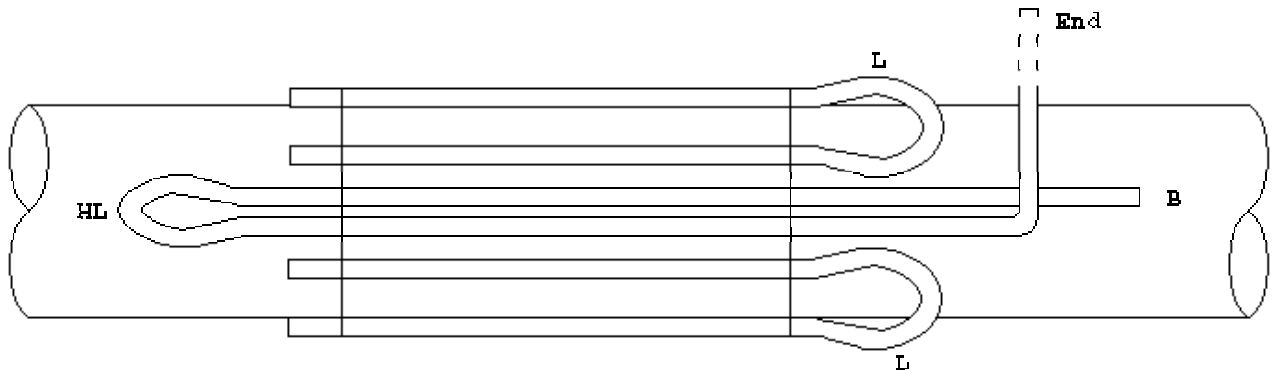
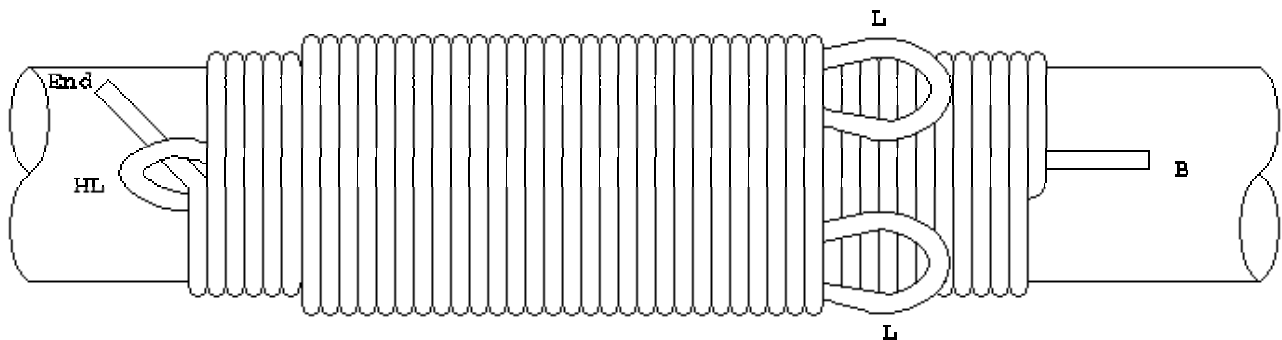

Figure 3. How to bind



At the figures are designated: L - Loop for fastening, B - Beginning of binding cord, End - End of binding cord, HL - Helping Loop.

After the ending of binding we pass the end of binding cord in Helping Loop and strongly pull for the beginning of binding cord. After that do melt of the Beginning and the End the binding rope, and that is all.

WOODEN STRUTS

By Igor Grigorov, RK3ZK
antentop@mail.ru

Made in the USSR

In the far eightieth years of 20 century, on to one of Russian radio transmitting radio center I saw a self-made opened transmission line that fed a transmitting antenna. Struts of the line were made of oak tree. What is wonder at that? These struts were about some tens years old. They were made at the end of 40 years, during restoring of the USSR after World War-II. The struts had been thoroughly boiled in paraffin before installation. Till now these wooden struts, made in great quantity, lie in a tub filled with paraffin. At repair of transmission lines the paraffin is kindled, the insulators are got and used. The wooden struts, despite of their "antiquity", looked rather 'fresh' and had sufficient mechanical and electric strength.



Figure 1 *Wooden compression strut*



Figure 1

Figure 2 *Two-wire line with usage of wooden compression struts*

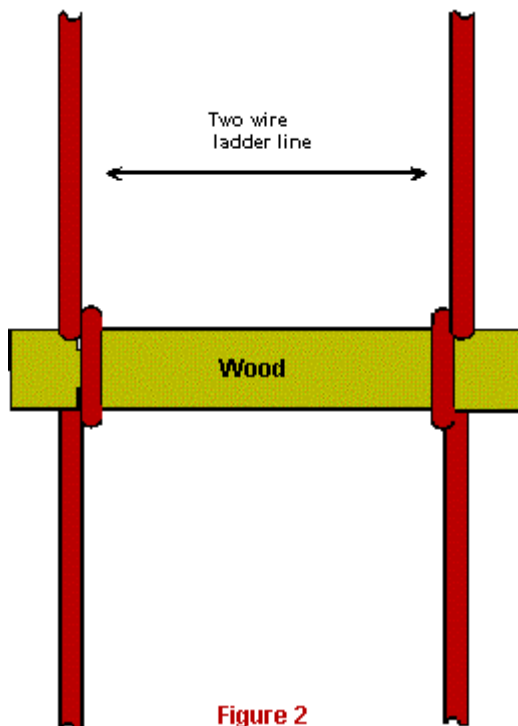

Figure 2

The struts had length 12-15 centimeters, and width about 2 centimeters. Kerfs were made at a small distance from ends of the struts. **Figure 1** shows the wooden strut. Wires of the ladder line were wound around of struts and kept on kerfs. **Figure 2** shows the two-wire line with usage of wooden struts.

<http://www.antentop.bel.ru/>

FREE e-RADIO magazine



www.antentop.bel.ru

PARAMETERS OF COAXIAL CABLESCredit Line: <http://radiotek.nm.ru/>

Coax no	Diameter, mm	Losses (db/100m) at frequency (MHz)					Price (US \$) and producer
		100	200	400	900	1800	
PK 50-17-51	27,5	1,4	2,1	3,1	5,1	7,7	8,0 RU
RFC LCF 7/8	28	1,16	1,69	2,53	4	6,1	15 GM
NOKIA RF 7/8	27,5	1,2	1,8	2,6	4,1	6,2	15 FN
NOKIA RF 1/2	16	2,2	3,2	4,6	7,3	11	10 FN
RFC LCF 1/2	16	2,13	3,1	4,6	6,9	10,3	10 GM
ANDREW LDF4-50A	16	-	-	4,6	7,3	11	10
RFC LCF 3/8	12,1	3,1	4,4	6,6	9,8	14,4	7,0 GM
PK50-7-58	12,1	3,4	4,9	7,1	11,2	17	4,0 RU
12D-SFB-NL	15,6	-	-	5,4	8,7	13,1	8,0 JP
10D-SFB-NL	13	-	-	6,5	10,3	16,4	6,0 JP
8D-SFB-NL	11,1	-	-	8,2	12,9	19,2	4,0 JP
8D-SFAE	11,1	-	-	7	11	16,5	6,0 JP
10D-FB	13	3,2	4,8	7	11,3	17,2	3,5 TW
8D-FB	11,1	4,3	7	10,5	16	24	2,0 TW
8D-FB-LL	11,1	-	-	9,5	14,7	-	2,5 TW
POPE H 100	9,8	4,1	-	8,5	13,2	19,2	2,0 NL
CUSHCRAFT TL93605	11,1	-	-	8,2	12,4	19	3,0 US
BELDEN 9913	11,1	-	-	8,8	14	-	3
SIVA RH 100	9,7	-	5,2	8,2	13	18,5	2,0 IT
LMR-400	11,1	-	-	10,6	16	-	1,5
5D-FB	7,4	6,5	9,6	14,4	21	32	1,0 TW
RG-8/U;	6,0	-	9,0	-	13,5	-	-
RG-8A/U	10,3	-7,0	-10,5	-15,75	24	38	1,5 TW
PK 50-11-31	13	3,8	6,6	9,5?	15	-	4,0 RU
PK 50-11-11	13	4,5	8,5	14,0?	24	-	1,5 RU
PK 50-7-312	11,3	8,5	14	22	36	-	1,0 RU
PK 50-7-11	11,3	8,5	14	22	36	-	1,0 RU
PK 50-7-32	11,3	6,8	11,8	18	-	-	-
RG8-LRP	10,4	-	9	13,5	24	38	1,5
RG-8x	6,15	12,1	17,7	26,5	-	-	1,0 TW, ,5RU
RG213/U, RG213BX	10,3	7	10,5	15,75	27	40,5	1,5 TW
3D-FB	5,3	8,3	12	24	-	-	1,0 TW
RG-58/U	5	14	20	33	-	-	0,3
RG-58A/U	5,03	13,1	18,7	31	-	-	0,3
RG-58C/U	4,95	16	23	35	-	-	0,3
RG-174/U, RG-174A/U	2,8	26	38	57	-	-	0,25

Producer:: RU- Russia; IT- Italy; GM- Germany, NL-Netherlands; US- USA; JP-Japan ; TW- Taiwan.

SUPPLEMENTARY

SUPPLEMENTARY

The hAmTX Power Supplay

by Paulo Ferreira CT2ILQ
paf@dei.isep.ipp.pt

The need for a power supply

When a ham buys (or makes) a radio he usually needs a power supply for it. A cheap alternative to buy one is to adapt a computer power supply. I just said the magic word, cheap. Hams like cheap things because that way they can buy more radios, or wire for antennas, or CW keys, or any other things they like. And a computer power supply can be bought in many places of the world, where one cannot find other radio related items. But a computer power supply is very different from a radio power supply, so we need to check the differences and see what can be done.



The Normal and the modified PSU

A typical PC compatible power supply is usually a switch-mode power supply with at least one fan. So one can expect RF noise and some acoustic noise. The RF noise can be ignored if the objective is to feed a VHF/UHF FM rig, and (some) modern PC power supplies have reasonably quiet fans.

Moving Closer

There are several documents on the internet that give information about transforming one PC PSU in one radio PSU. They have several shortcomings, they are for older AT style PSUs, they usually need changes in the internal circuit of power supply, or in alternative they can supply only small currents.

But, in the recent times there is a new kind of PC power supplies called ATX12V and they are interesting, very interesting. In a simple way, old style AT PSUs had a strong +5V output, and a reasonable +12V output. The ATX standard brought different connectors and a +3.3V output. The ATX12V standard comes from the need of low voltages and strong currents for the actual processors. The motherboard manufacturers place voltage converters on the motherboard and feed the voltage converters at +12V. So its easy to find PSUs with a capacity of between 15 and 25 Amperes on the +12V line (without circuit changes).

The minimum

The trouble is not the maximum current, but the minimum current because switch-mode PSUs have a minimum current limit, if their load is lower than the minimum, they can be damaged (or they shutdown if they are protected).

But the resolution of this problem is simple, we just need to place some resistors on the outputs that have a minimum current requirement. Usually the +3.3v, +5V and +12V outputs have a minimum current requirement. The resistors must have the correct wattage, preferably with a safe margin. Some of the more recent power supplies only have a minimum current requirement on the +12V line, so they are very nice for our needs.

How to proceed

1) Get the ATX12V power supply design guide.

2) Choose the ATX power supply to buy.
 Items to check:

The PSU must have a power switch.

The manufacturer has a page on the Internet?

Does the page has the full specifications?

Is the PSU a "big fan" (120 mm) type PSU?

What are the maximum currents?

What are the minimum currents?

What are the outputs with a minimum current requirements?

Calculations

So lets suppose we have a power supply with a minimum current of 0.5 A on the +12Volts output only. So we need a resistor of $12/0.5 = 24$ Ohms maximum. A good approximation would be a 22 Ohm resistor. The power dissipated would be $12V * 0.5A = 6$ Watts so a good compromise would be a 22 Ohm resistor of 15 Watt at least.

If the power supply has a minimum current on other outputs we need to calculate the resistors for the other outputs using the same method.

Opening the power supply

You may get an electrical shock even if the PSU is disconnected from the mains, so be careful, or you may not need to follow the next steps. One measure of caution that may not work, but may diminish the danger, is to leave the PSU disconnected one full day before opening it.

List of wires and colors

Black Wires - Ground - connect to ground (Ground Output)

Green Wire - Connect to one black (to place the power supply always on)

Grey - Power Ok - unconnected

Purple - +5V standby - unconnected

White - -5v (not used in recent motherboards) unconnected

Blue - -12V unconnected

Orange Wires (+3.3v) - leave opened (no connection)

Red Wires (+5v) - leave opened (no connection)

Yellow Wires (+12Volts) - connect to Positive Output

Resistors to connect

As only the +12V output has a minimum current requirement we only place one load resistor (previously calculated) between the yellow and black wires. The resistor (or resistors) should be placed inside the PSU to benefit from the PSU fan.

Practical resume:

Black = Ground = Connect to Black wire of the radio

Yellow = 12 Volts = Connect to Red wire of the radio

Place the Resistor between Yellow and Black

Orange = +3.3V = Leave open (unconnected)

(Place a resistor between Orange and Black if needed, if the +3.3V Output has a minimum current requirement)

Red = +5V = Leave open (unconnected)

(Place a resistor between Red and Black if needed, if the +5V Output has a minimum current requirement)

Green = connect to Black

All the other wires are unconnected

Practical experience:

I got one power supply (460W nominal with a big 120mm fan) and modified it. Acoustically it is very quiet. Electrically with a VHF/UHF FM rig the RF noise is not detectable. So to operate a VHF rig the PSU is suitable.

One good thing about it (and many others) is an adjustable resistor inside to control the output voltage and that way I could adjust the output voltage up to 13.5 Volts instead of usual 12Volts (with a lot of care because of the deadly voltages inside of the power supply).

To test the RF noise I compared the PSU with a linear PSU, and with a Gel-Cell battery, using one hf radio on several amateur bands, and a 20 meter horizontal long wire antenna.

On the first test, inside the house, the PC modified PSU was a noisier than the linear PSU but not much worse, and the battery was comparable to the linear supply.

Then outside, I placed the radio under the antenna and yes, the "computer" PSU, is usable on VHF and UHF FM, but on HF gives a lot of noise. Surprise, the linear PSU also makes noise, and the battery is very quiet, because almost all the QRM I hear is from the coaxial cable routing from the inside to the outside of the house.

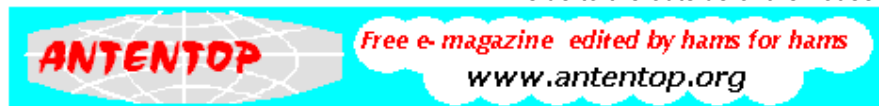

SUPPLEMENTARY

The hAmTX Power Supply

It runs parallel to the satellite receiver cables and that should be the cause of all that QRM... So I need to reroute the antenna cables.

Meanwhile I have a good PSU to use with a typical 50W FM VHF/UHF radio.

Things to try in the future:

The PSU is not suitable for HF use. Could the PSU be improved with additional filters? I have not placed any filter on the output but there is space for the filter inside the PSU box if the fan is moved to the outside.

Links and documentation:

Atx12V Specification:

http://www.enhanceusa.com/documents/ATX12V_v2.01.pdf

Other specifications:

http://www.enhanceusa.com/support_tech.htm

Basic Modification Examples:

<http://www.antennex.com/preview/archive3/powers.htm>

<http://www.qsl.net/aa3sj/Pages/PC-Supply.html>

<http://www.mattsrcstuff.com/PCPS.htm>

<http://www.qsl.net/vk2ep/news/dec2001.doc>

St. Louis switcher

<http://www2.arrl.org/members-only/tis/info/pdf/0205035.pdf>

<http://www.qsl.net/wj5o/project.htm>

<http://www.njgrp.org/qhbextra/6/6d.html>

http://207.195.94.13/sart/radio_library/switcher-supply.pdf

Advanced ones:

Very complete:

<http://www.grp4u.de/docs/en/powersupply/index.htm>

Nice modification

<http://www.qsl.net/vk4ba/projects/index.html>

ATX power supply example

http://pavouk.comp.cz/hw/en_atxps.html

Changing an ATX PSU to 12-24V input (input!):

<http://www.acs.comcen.com.au/atxps.html>

Data sheets and tech pubs:

<http://www.fairchildsemi.com/ds/TL/TL494.pdf>

<http://www.fairchildsemi.com/ds/KA/KA7500B.pdf>

<http://www.antentop.org/>

mirror: www.antentop.boom.ru

<http://focus.ti.com/docs/prod/folders/print/tl494.html>

Nice Articles about switched power supply repair (on a slot machine tech magazine !!)

[http://slot-tech-](http://slot-tech-ftp.serveftp.com:8080/magazine/february02.pdf)

<ftp.serveftp.com:8080/magazine/february02.pdf>

[http://slot-tech-](http://slot-tech-ftp.serveftp.com:8080/magazine/march02.pdf)

<ftp.serveftp.com:8080/magazine/march02.pdf>

Modifying a PC power Supply for Lab use:

<http://web2.murraystate.edu/andy.batts/ps/powersupply.htm>











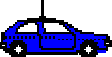

Final version (for now) with fan outside of the box

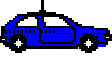

Inside View

HAND-HELD/CAR/TRUCK/HOUSE 27 AND 145 MHz COMMUNICATION

CB- 27-MHz (distance in kilometers)				
				40-50
			15-25	20-30
		8-15	10-20	15-25
	2.5-6	4-10	5-12	8-16
				
	5-12	7-15	8-16	10-18
		12-25	15-30	25-40
			20-35	35-50
				60-80
VHF- 145-MHz (distance in kilometers)				

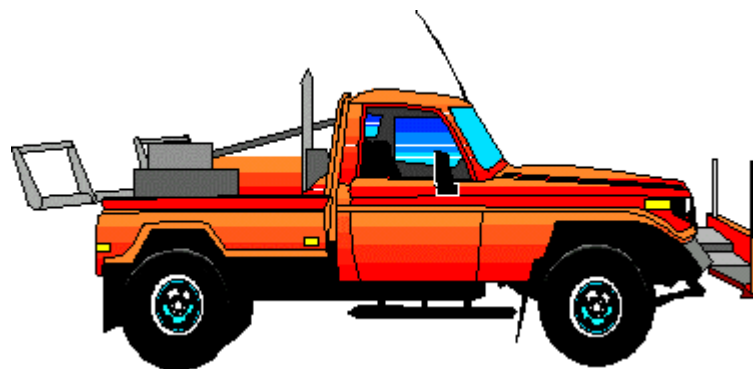

WIRE METRIC DIAMETER/GAUGE STANDARD

Number #		0000	000	00	0	1	2	3	4	5	6	7
Diameter in mm	SWG	10.16	9.45	8.84	8.23	7.62	7.01	6.40	5.89	5.38	4.88	4.47
	AWG	11.68	10.41	9.27	8.25	7.35	6.54	5.83	5.19	4.62	4.11	3.66
	BWG	11.53	10.80	9.65	8.64	7.62	7.21	6.58	6.05	5.59	5.16	4.57

Number #		8	9	10	11	12	13	14	15	16	17	18
Diameter in mm	SWG	4.08	3.68	3.25	2.95	2.64	2.34	2.03	1.83	1.63	1.42	1.22
	AWG	3.25	2.90	2.59	2.30	2.05	1.83	1.63	1.45	1.29	1.15	1.02
	BWG	4.19	3.76	3.40	3.05	2.77	2.41	2.11	1.83	1.65	1.47	1.24

Number #		19	20	21	22	23	24	25	26	27	28	29
Diameter in mm	SWG	1.02	0.92	0.81	0.71	0.61	0.56	0.51	0.46	0.41	0.38	0.35
	AWG	0.91	0.81	0.72	0.64	0.57	0.51	0.45	0.40	0.36	0.32	0.29
	BWG	1.07	0.89	0.81	0.71	0.64	0.56	0.51	0.46	0.41	0.35	0.33

Number #		30	31	32	33	34	35	36	37	38	39
Diameter in mm	SWG	0.30	0.29	0.27	0.254	0.229	0.203	0.178	0.17	0.15	0.127
	AWG	0.25	0.23	0.20	0.18	0.16	0.14	0.13	0.11	0.10	0.08
	BWG	0.30	0.25	0.229	0.203	0.178	0.127	0.102			

Color Code for Resistors and Capacitors

Resistor color code

As usual a resistor is marked by four or five ring strips. Since you can find out the value of the resistors at any installation of this one on a printed-circuit-board. Read

value of the resistor from the end with a narrow strip in Ohms. Read a wide strip the last. **Table 1** shows the decoding of the color marks for resistors. Up to multiplier marks are given in Ohms.

Table 1 Resistor color code

Mark color	1 mark	2 mark	3 mark	Multiplier	Tolerance, %
silver	-	-	-	10^{-2}	10
gold	-	-	-	10^{-1}	5
black	-	0	-	1	-
brown	1	1	1	10	1
red	2	2	2	10^2	2
orange	3	3	3	10^3	-
yellow	4	4	4	10^4	-
green	5	5	5	10^5	0,5
blue	6	6	6	10^6	0,25
violet	7	7	7	10^7	0,1
grey	8	8	8	10^8	0,05
white	9	9	9	10^9	-

Capacitor color code

Recently capacitors as well as resistors have color marks. However different types of capacitors can have different color strips or points at the body. **Figure 1** shows examples of color marks for several types of modern capacitors.

Capacity is specified by two first colors (strip or points) in pF. After that the multiplier shows value of the capacitor. Tolerance, working voltage and also can be specified if it is necessary. **Table 2** shows capacitor color marks. **Table 3** shows lighting calculator for capacitors

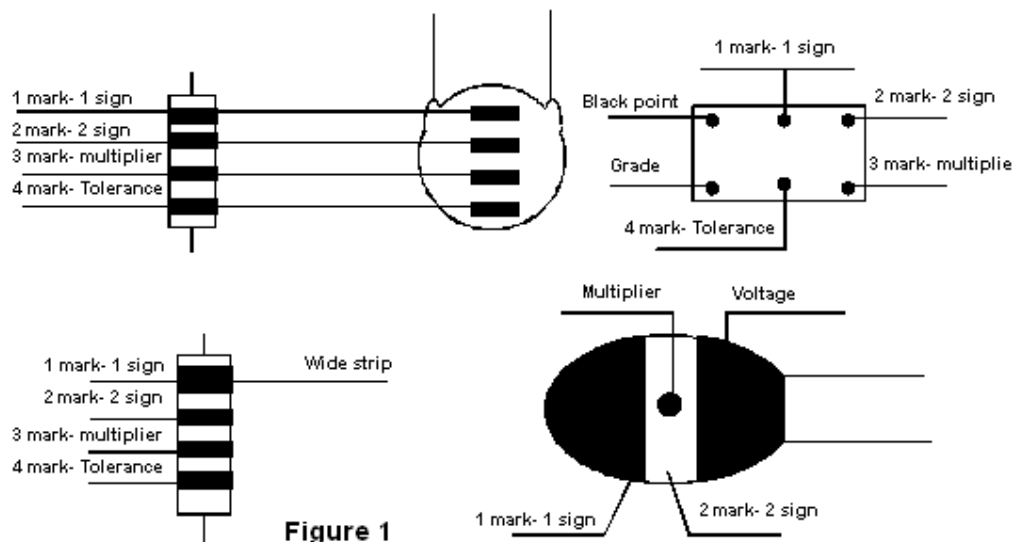

Figure 1

Table 2 Capacitor color mark

Mark color	1 mark	2 mark	Multiplier	Tolerance, %	Voltage, V
black	0	0	1	20	4
brown	1	1	10	1	6,3
red	2	2	10^2	2	10
orange	3	3	10^3	0,25	16
yellow	4	4	10^4	0,5	40
green	4	5	10^5	5	20
blue	6	6	10^6	-	30
violet	7	7	10^7	+50/-20	50
grey	8	8	10^8	+80/-20	3,2
white	9	9	-	-	63
silver	-	-	-	-	2,5
gold	-	-	-	-	1,6

Table 3 lighting calculator for capacitors

Value of capacity (μ F)	1 mark	2 mark	3 mark (Multiplier)
0,010	brown	black	orange
0,015	brown	green	orange
0,022	red	red	orange
0,033	orange	orange	orange
0,047	yellow	violet	orange
0,068	blue	grey	orange
0,10	brown	black	yellow
0,15	brown	green	yellow
0,22	red	red	yellow
0,33	orange	orange	yellow
0,47	yellow	violet	yellow
0,68	blue	grey	yellow
1,0	brown	black	green
2,2	red	red	green



The Complete Smith Chart

Black Magic Design

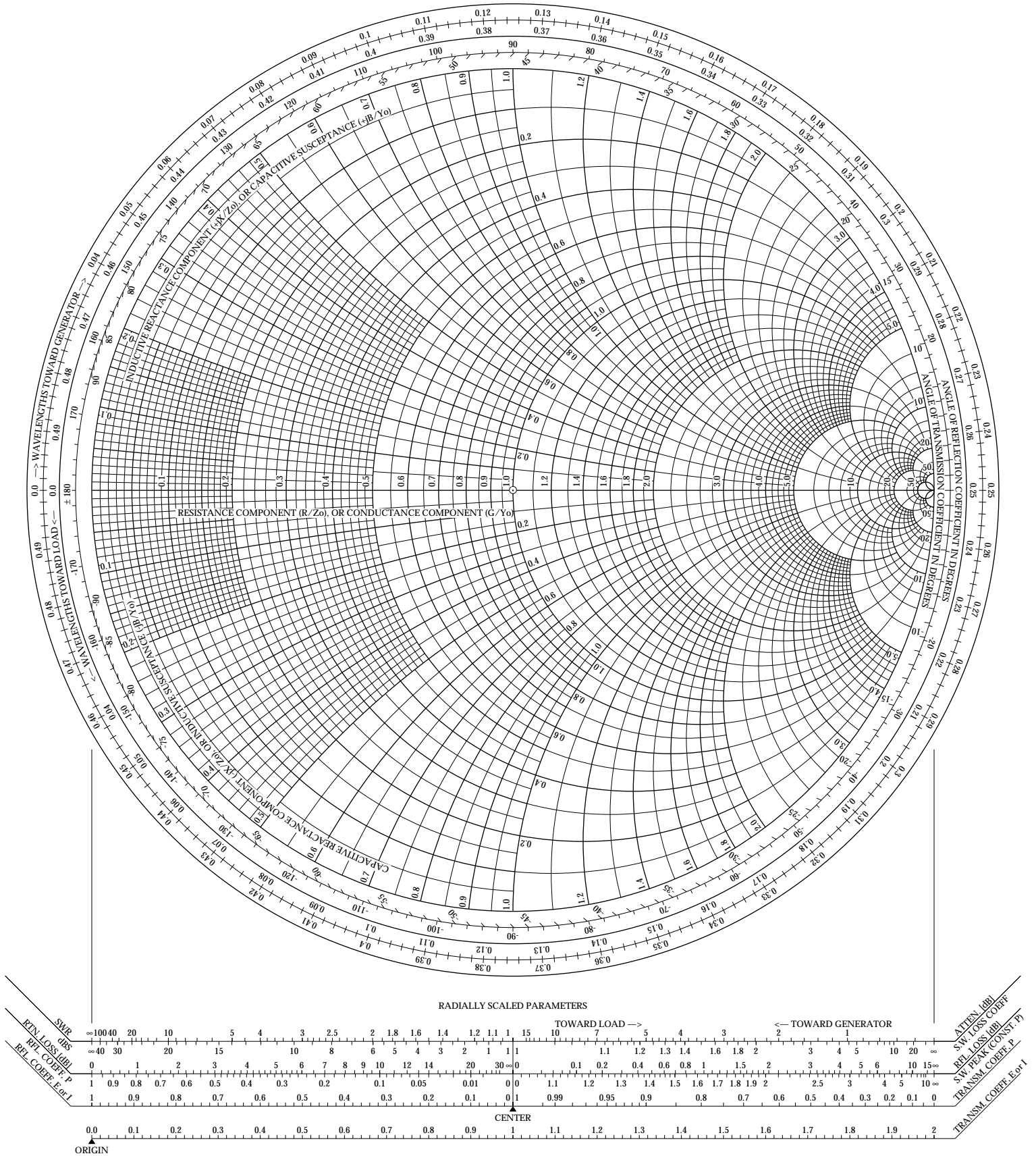

RADIALLY SCALED PARAMETERS

TOWARD LOAD →

← TOWARD GENERATOR

CENTER

ORIGIN

ATTEN (dB)
SW LOSS COEFF
REF PEAK (CONST. P)
TRANSM. COEFF. P
TRANSM. COEFF. E₀₁