K7QO's QRP Lab Notebook

Version 6.31

September 16, 2017

by

Chuck Adams, K7QO

`chuck.adams.k7qo@gmail.com`

Contents

1 Introduction	21
2 Photography	23
2.1 Camera	23
2.2 Lights	25
3 Tools	27
3.1 Soldering Iron	28
3.2 Solder	29
3.3 Solder Spool	30
3.4 Solder Sucker	31
3.5 Solder Dispenser	32
3.6 Hobby Knife	35
3.7 Sears Wire Cutters	36
3.8 Wire Strippers	37
3.9 Chain Nose Pliers	38
3.10 Lead Bender	39
3.11 Super Glue	40
3.12 Clamps	41
3.13 Calipers	42
3.14 PCB Holder	44

4	The New and Improved Lab	47
5	The MUPPET Show	55
5.1	Printed Circuit Board Material	57
5.2	Steel Wool or 3M Heavy Duty Stripping Pads	57
5.3	Copper Foil Layout	65
5.4	Printing PCB Layout	67
5.5	Laminator to Transfer Toner to PCB	69
5.6	Your First Board	69
5.7	Test Soldering to PCB	74
5.8	Resistor Placement on Muppet Board	76
5.9	Soldering IC Sockets and IC components	91
6	The Quartz Crystal Unit	97
6.0.1	Impedance at Resonant Frequencies	101
6.0.2	Crystal Parameters by Measurement	102
6.1	Crystal in Series with a Capacitor	106
6.2	Final Summary	109
7	G3UUR Crystal Parameter Fixture	111
7.1	ESR Measurement	114
7.2	SPICE Simulation	120
8	Simple Crystal Oscillators.	123
8.1	A Simple Colpitts Crystal Oscillator	123
8.2	Second Colpitts Crystal Oscillator	150
8.2.1	Building Order for k7qo-0004	158
8.3	Pierce Crystal Oscillator	159
9	Crystal Matching and Crystal Filters	161

<i>CONTENTS</i>	5
9.1 Conclusion So Far	166
10 The Shear	167
10.0.1 Enco Shear	167
10.1 Same width cutting technique	177
11 Enclosures made from PCB material	179
11.1 PCB Enclosure Fixture	179
11.2 How To Solder PCB Material	183
11.3 Matching Lengths	185
11.4 Simple PCB Fixture	195
12 Digital Multimeter Impedance Measurements	201
12.1 Voltage Measurement	205
12.2 1M Resistor Measurement	206
12.3 Series Voltage Measurement	207
12.4 Impedance Calculation	207
12.5 Velleman DVM1100	208
13 DMM Calibration	211
14 RF Measurement Techniques	221
14.1 Baseline Measurements	221
14.2 Response Curves	224
14.3 RF Generator Calibration Curves	227
15 Measurements	231
15.1 Relative Error	231
16 Varactor Diode Characteristics	233
16.1 New Improved Varactor Fixture	245

17 Regen Receivers	249
17.1 Scout Regen Receiver	249
17.2 The Desert Ratt Regen	250
17.2.1 Some of the History of the Ratt	250
17.2.2 Desert Ratt Build 2013	250
18 Crystal Frequencies	267
19 AADE Toroid Measurements	269
20 VXO Experiment	279
21 New England QRP Club NE4040	281
22 The Inductor	297
22.1 Single Layer Air Core Inductors	298
22.2 35mm film canister coil form	299
22.3 Inductor Measurements with AADE L/C Meter	302
22.4 Q-Dope	302
22.5 Distributed Capacitance of inductors.	303
23 40/20 Meter Transceiver	305
23.1 The VFO	305
23.1.1 Capacitor calculations	309
23.1.2 SPICE Simulation of the VFO	311
23.1.3 Winding the toroid and measurement	312
23.1.4 Transmitter Mixer	313
23.2 First Section Build	316
23.3 Drivers and Final Power Amplifier tests	320
24 Manhattan Style Construction	321

<i>CONTENTS</i>	7
24.1 Printed Circuit Board material	322
24.2 Cleaning Board Material	323
24.3 Making Pads	324
24.4 Mounting pads and components	333
24.5 First Manhattan Project – Crystal Tester	346
24.5.1 Assembly	347
25 The Ugly Weekender II	361
25.1 VFO and Keying board	362
25.1.1 VFO Buffer Amplifier	368
25.2 Ugly Weekender II Receiver	373
26 Why Krylon on MUPPET Boards?	379
27 The K7QO MUPPET Show-and-Tell	385
A AWG Wire Table	401

List of Figures

1	Olympus Camera.	24
2	CFL lamp up close.	25
3	Weller Soldering Iron.	28
4	Radio Shack Solder.	29
5	Weller Solder Spool.	30
6	Solder Sucker.	31
7	Solder Dispenser.	32
8	Solder Dispenser from China.	33
9	Solder Dispenser from US.	34
10	Xacto Hobby Knife.	35
11	Sears Wire Cutters.	36
12	Wire Strippers.	37
13	Chain Nose Pliers.	38
14	Lead Bender.	39
15	Super Glue Bottles.	40
16	Plastic Clamp.	41
17	Mechanical Calipers.	42
18	Digital Calipers.	43
19	WA4MNT PCB Holder.	44
20	WA4MNT PCB Holder.	45

21	The New Lab Workbench.	48
22	Component Storage Shelves on back of the desk.	49
23	Closeup of the Storage Containers.	50
24	Storage Container with Booklet Seal on Top.	51
25	Storage Container with Booklet Seal on Top.	52
26	Homemade Apothecary Drawers by K7QO.	53
27	3M Heavy Duty Stripping Pads.	58
28	Fine Steel Wool.	59
29	Unmodified Board.	60
30	Board Cleaned with 3M Pad.	61
31	Board Cleaned with Steel Wool.	62
32	Cleaned Boards Side by Side.	63
33	ExpressPCB Test Board Layout.	66
34	Test Board Layout for Printing. Not to scale.	68
35	Hammermill Color Laser Gloss Paper.	70
36	Pyrex Dish, Measuring Cup and Spoon.	71
37	K7QO MUPPET 000 Board.	73
38	K7QO MUPPET 000 Board with soldered pads.	75
39	Vector Board and Resistor.	77
40	Bent Leads on a Resistor.	78
41	Preform resistor leads for PCB mounting.	79
42	Resistor in place with one lead soldered.	80
43	Resistor soldered in place.	81
44	Resistor desoldered from its location.	82
45	Resistor soldered into closer pads.	83
46	Resistor soldered to two pads. One at ground potential.	84
47	Weller iron with Ungar tip.	86
48	Solder iron stand.	87

LIST OF FIGURES

11

49	Wash cloth.	88
50	Edge bending of resistor leads.	89
51	Resistor soldered into place with leads outwards.	90
52	Pre-tinned leads outwards from the socket.	92
53	Socket with two pins soldered into place.	93
54	Socket with all pins soldered into place.	94
55	Equivalent circuit of the piezoelectric resonator.	99
56	Simple Fixture for Crystal Parameter Measurements.	103
57	Frequency sweep of a 4.096MHz crystal.	104
58	Frequency sweep of a 4.096MHz crystal.	105
59	Circuit of with crystal in series with C_x	106
60	K7QO fixture for the HB9DUL scheme.	108
61	G3UUR Crystal Parameter Circuit. See text for values.	112
62	G3UUR PCB with K7QO ESR fixture.	117
63	G3UUR Crystal Parameter PCB and K7QO ESR fixture.	118
64	K7QO ESR schematic.	119
65	SPICE simulation of sweeping a crystal	121
66	SPICE simulation.	122
67	K7QO muppet 001 schematic.	125
68	K7QO muppet 001 PCB layout.	126
69	K7QO muppet 001 PCB layout flipped. Not to scale.	127
70	K7QO muppet board for crystal oscillator.	128
71	Toner transferred to board and paper removed.	130
72	Muppet board in etchant.	131
73	Muppet board etched with toner still in place.	132
74	Toner removed with steel wool.	133
75	Board coated with light coat of clear Krylon.	134

76	Some 0.10" male headers from China.	136
77	Male pins on PCB and the female header.	137
78	Green LED with current limiting resistor 4.7K.	138
79	Reverse polarity protection diode, 1N4148.	139
80	NPN transistor in position.	140
81	33K, 150pF and 220pF components in position.	141
82	33K component in position.	142
83	Crystal with socket.	143
84	Crystal with socket soldered into place.	144
85	Here I picked a 10pF cap and it is way too small.	145
86	Here is the finished project.	146
87	Oscillator up and running and connected to freq counter. . .	147
88	HP3400A RF Voltmeter.	148
89	HP3400A RF Voltmeter at 5.1K resistor.	149
90	K7QO-0004 Revised Colpitts oscillator schematic.	151
91	New Colpitts oscillator PCB layout.	153
92	Etched board backlit to show detail	154
93	Power connector and LED powered up.	155
94	Assembled k7qo-0004 muppet board.	157
95	Pierce crystal oscillator schematic.	160
96	Distribution of 100 or so crystals marked 4.096MHz.	162
97	Vector Board and Crystals.	163
98	Vector Board, Notebook and Crystals.	164
99	Harbor Freight 8" Shear.	168
100	Enco Shear SKU130-5700.	169
101	Enco Shear SKU 130-5700 at use-enco.com.	170
102	Enco Shear SKU 130-5700 at use-enco.com.	171

LIST OF FIGURES

13

103 Enco Shear on Workbench.	172
104 Enco Shear on Workbench.	173
105 Enco Shear with Right Triangle.	174
106 Tacks to Hold Material in Place.	175
107 Enco Shear SKU 130-5700 at use-enco.com.	176
108 Right angle clamped down on working surface.	177
109 Number of pieces all cut to same width.	178
110 Fixture for PCB Enclosure building.	180
111 Fixture for PCB Enclosure building.	181
112 Fixture with clamp from Home Depot tool department.	182
113 PCB material for test build.	183
114 PCB material cleaned up nicely.	184
115 Two PCB pieces to be matched.	185
116 First piece in place.	186
117 Second piece to be cut in place.	187
118 Matched PCB material pieces.	188
119 Wire spacer in place.	189
120 PCB material clamped in vertical position.	190
121 Bottom piece clamped into position.	191
122 PCB material soldered together.	192
123 Right angle joining of the two boards.	193
124 Front view of resulting structure.	194
125 Fixture with clamped PCB pieces.	196
126 Two Piece fixture to build Manhattan project on.	197
127 Here you can see the 90 degree angle.	198
128 Fixture front showing that lower plate is hidden from view.	199
129 CEN-TECH Digital Multimeter from Harbor Freight.	202

130	Velleman DVM850BL Multimeter.	203
131	Protek D-930A Digital Multimeter.	204
132	WEB-TRONICS.COM MAS830 Multimeter.	205
133	Velleman DVM1100 Digital Multimeter.	209
134	DMM Check System.	212
135	DMM Check System.	213
136	Velleman in μA scale.	214
137	Velleman in mA scale.	215
138	Velleman reading voltage for 5.000V in.	216
139	Velleman reading resistance for 999.81 Ω	217
140	Velleman reading resistance for 10.0048k Ω	218
141	Velleman reading resistance for 99.9303k Ω	219
142	HP 3400A on top of the Wavetek 3010.	222
143	HP 3400A Meter Up Close.	223
144	HP 3400A Meter Response Curve.	226
145	S&S Engineering DDS and Wavetek 3010 Output.	227
146	NorCal FCC-2, Boyd RSG-30 and BK 2005A Signal Generators	229
147	K7QO Varactor Diode Fixture for AADE Meter.	234
148	K7QO Varactor Diode Fixture in use.	235
149	SMV1662 Varactor Diode Voltage Response Curve.	236
150	MV1662 Varactor Diode Voltage Response Curve.	237
151	MV1662 and SMV1662 Varactor Diode Voltage Response Curves.	238
152	MV2109 Varactor Diode Voltage Response Curve.	239
153	MV209 Varactor Diode Voltage Response Curve.	240
154	MV2301 Varactor Diode Voltage Response Curve.	241
155	V149 Varactor Diode Voltage Response Curve.	242

LIST OF FIGURES

15

156	618 Varactor Diode Voltage Response Curve.	243
157	MV636 Varactor Diode Voltage Response Curve.	244
158	Tinned Binding Contacts	246
159	Completed Underside of Varactor Fixture	247
160	Varactor Fixture attached to AADE L/C Meter	248
161	Desert Ratt build Manhattan style by K7QO.	251
162	Desert Ratt build Manhattan style by K7QO.	252
163	Desert Ratt Muppet board layout by K7QO.	253
164	Power supply connection setup.	254
165	Audio section completed.	255
166	Audio section powered up for testing.	256
167	Schematic and board with LM317L installed.	257
168	Differential amplifier section completed.	258
169	Audio volume control and pre-amp sections.	259
170	Diode detectors, 1N34A diodes.	260
171	Board and schematic photograph.	261
172	Impedance conversion section.	262
173	Board modification to correct error in layout.	263
174	Completed board assembly by K7QO.	264
175	Desert Ratt powered up and listening to shortwave broad- cast station.	265
176	Binding posts of AADE IIB meter.	270
177	Top view of the K7QO fixture.	271
178	Cables with Radio Shack alligator clips.	272
179	0053.	273
180	Cables shorted out to calibrate for zero inductance.	274
181	Toroid to be measured in place.	275

182 FT37-43 in place.	276
183 Arduino female–female jumper cable.	277
184 Cable in place with toroid on it.	278
185 VXO Test Circuit.	280
186 NE4040 audio section.	282
187 NE4040 second mixer section.	283
188 Testing with crystal generator.	284
189 VFO, first mixer and IF filter.	285
190 VFO completed.	286
191 Variable resistor (pot) to tune added.	287
192 Tuning knob.	288
193 Frequency readout.	289
194 Frequency readout.	290
195 Assembled board.	291
196 NE4040.	292
197 NE4040.	293
198 NE4040.	294
199 NE4040.	295
200 Coil form connection wire placement.	300
201 Complete inductor Coil.	301
202 Colpitts VFO.	307
203 LC network for VFO frequency.	310
204 Colpitts VFO simulation.	312
205 VFO and transmit mixer followed by bandpass filter.	315
206 Muppet board for the VFO section.	316
207 The VFO section up and running.	317

LIST OF FIGURES

17

208 The keying section added.	318
209 The transmit mixer section added.	319
210 Stop modification on the punch.	325
211 Stop in place and punch in vise.	326
212 Stop in place and punch in vise.	327
213 Small once ounce cup to catch punched pads.	328
214 Board that has one row punched out.	329
215 Pads from first row punched.	330
216 Punches along two edges of the board.	331
217 Results and a lot of pads.	332
218 Several super glue bottles.	333
219 Ground plane PCB material.	334
220 Radio Shack solder.	335
221 Krylon coating.	336
222 Ground points.	337
223 Manhattan pad and tweezers.	338
224 Pad glued down.	339
225 Tinned pad.	340
226 Header pins on ground plane and pad.	341
227 Capacitance of pad.	342
228 Resistor laying on board.	343
229 Resistor soldered into place.	344
230 Three resistors.	345
231 Crystal tester schematic.	346
232 Q1 Transistor leads bending.	347
233 Q1 mounted to pads.	348
234 R1 and C1 added.	349
235 C2 added.	350

236 C3.	351
237 D1.	352
238 D2.	353
239 C4.	354
240 Q2.	355
241 R3 and LED mounted.	356
242 Power connector.	357
243 Crystal connector.	358
244 Final project powered up with no crystal.	359
245 Powered up and crystal in socket.	360
246 Power connector for the PCB.	363
247 9V zener regulator supply.	364
248 Ugly Weekender Schematic – 001.	365
249 Ugly Weekender Schematic – 002.	366
250 Partial VFO assembly.	367
251 VFO Buffer Amplifier assembly.	369
252 Ugly Weekender Schematic – 003.	370
253 VFO and keying board assembly.	371
254 Ugly Weekender Schematic – 004.	372
255 LM386 audio amp section.	373
256 Audio amp and sidetone oscillator section.	374
257 Completed Receiver.	375
258 Completed Receiver.	376
259 Completed Receiver.	377
260 Jan 2009 Test Board after 6 years.	380
261 Jan 2009 Test Board after 6 years.	381
262 Steel Wool removal of layer of oxide.	382

263 Board after application of thin layer of Krylon Clear. 383

264 2549 and 2550 386

265 2551 and 2552 386

266 2553 and 2555 387

267 2556 and 2557 387

268 2558 and 2559 388

269 2560 and 2566 388

270 2567 and 2568 389

271 2569 and 2570 389

272 2572 and 2573 390

273 2574 and 2575 390

274 2576 and 2577 391

275 2578 and 2579 391

276 2571 and 2589 392

277 2580 and 2585 392

278 2583 and 2587 393

279 2591 and 2582 393

280 2581 and 2584 394

281 2590 and 2595 394

282 2596 and 2597 395

283 2598 and 2599 395

284 2600 and 2601 396

285 2602 and 2603 396

286 2604 and 2605 397

287 2606 and 2607 397

288 2608 and 2609 398

289 2610 and 2611 398

290 2612 and 2613 399

291 2614 and 2615	399
292 2616 and 2610	400

Chapter 1

Introduction

This document is not intended to be printed. I have, after a few years of playing around with different formatting issues and a major move, decided that this document should go with the trend toward ebooks. So, with that in mind, I am doing this document in PDF format. The postscript document format is an ISO standard and is easily displayed on an iPad 2. My reader of choice, thus the reason for my format here.

This document is intended to give you an overview of construction techniques for homebrewing. I will be giving significant detail on such things as creating printed circuit boards. My intent is not to treat you as one would a child. I am just writing like one would a book with a goal to include as much detail, or even more, that I believe you need to be successful at using any of the material here. Tis far better to include it and not need it, than to not include it and you need it.

I recommend that you read through sections of this document several times before building and experimenting. You need to make sure that you have everything you need before you get started. Also to be sure that you have a very good feel and understanding of the material. If you are like me, you hate to start on something, be interrupted and then have to go and find something that you are missing or have overlooked. Plan ahead and you will save a lot of valuable time. All the suggestions within this article are just that — suggestions. Everything here is material that I use almost daily in the lab for the construction of test equipment, receivers, transmitters and other projects that I want to do. Some have been on the bulletin board as to do projects and now

is the time to get them done.

I have built everything here unless otherwise noted. Sometimes I will begin a project and document it the same time to aid me in plotting a course of action. I have made every attempt to avoid errors, but if you should see or find one an email would be appreciated to avoid having someone else make an time consuming error.

There is the real possibility that I start a project, will document it as I go and then get to a point where I get side tracked. Either because I need to do some research and determine the best course of action or I see a side road to travel down a little and then come back. If I am doing this on a project of interest to you, I apologize. Ping me if it is that important and I'll attempt to give you a time scale for it.

I have also added a note on operating. There is a problem at the current time. I don't know the number of so called QRPers. The number is dwindling yearly by significant numbers. There are many causes for this and it doesn't do any one any good to complain. I'm as guilty as any one else. I spend so much time on the Internet reading and looking for stuff as the next guy or gal. And because of that I haven't been on the air much in the last 7 years and my goal is to start today to remedy that fault. So my challenge to you is to push away from the computer and get on the air. First build something and then put it on the air. We need more signals so that the receivers I build and will hear something being transmitted.

Chapter 2

Photography

I know I'm going to get email asking just how I go about taking the pictures that you see here. It's not that difficult. We live in the digital age and with the increase in the general world population use of computers and digital cameras the demand has brought about some very nice equipment to work with. As a QRPer and having grown up poor (so poor that the cockroaches went next door to eat) I'm still frugal, but I'll spend the money when the urge strikes.

2.1 Camera

But you don't have to break the budget on radio equipment to get a camera. All the photos you see here that are of good quality were taken with an Olympus D-535 3.2MP (megapixel) camera, an Olympus FE-140 7.1MP camera and in April of 2013 I discovered a Fujifilm 14MP camera model JV200 that has automatic focus with even distances as close as 2cm to an object. I love it in that I don't have to switch between modes as I do with the Olympus cameras.



Figure 1: Olympus Camera.

2.2 Lights

Lighting is another miracle of modern day technology. The compact fluorescent lamp (CFL) craze is driving the prices down almost daily. Use the 6500K lamps or “daylight” lamps. Their spectral distribution approximates that of direct sunlight. This helps avoid color correction in the camera or having to post process the photos to make them look realistic. The lamps I bought were at Home Depot in the lighting department.



Figure 2: CFL lamp up close.

June 27, 2016: now switching to LED lighting for everything. I use the daylight or bright ones that approximate the spectral emission of the sun. These are lower power requirements and last a very long time, even though they may be more expensive. At least they do not pollute the landfill with mercury that is released when the glass enclosure of a CFL is broken. IMHO.

Chapter 3

Tools

Let me show you some of the tools that you may consider for construction of QRP equipment and rigs. The photos and descriptions here are by no means exhaustive. I have no idea what your interests are, how much money you wish to invest or how long you will have an interest in experimenting. Hobbies are like a yo-yo. We all have ups and downs measured by our activity level. The time and resources we have available are limited.

The majority of the tools listed here are used in both scratch built work and in building kits. The selection here is probably obvious to most builders, but placed here for those new to the hobby of building their own equipment.

3.1 Soldering Iron



Figure 3: Weller Soldering Iron.

The above soldering iron I picked up recently at Home Depot in the tools department. Costs just under twenty dollars US. I have used an older model for decades. The newer model has a smaller diameter tip and but I found that it has the same size threads (#10-24). Don't know how long the tip will last in normal use. I have used the same Ungar PL823 tip for 46 years. Remarkable. Recently found some on ebay. You might look. My original cost me \$1.71 and on ebay they are going for three bucks and up. Well worth the price. IMHO.

3.2 Solder



Figure 4: Radio Shack Solder.

The easiest solder for you to find is the small spool above from your local Radio Shack. I hear that Radio Shack is in trouble and considering chapter 11 proceedings. I'd get some solder now, while the supply exists and your local store is still in business.

If money is no object, then consider getting a one pound spool from Mouser or other electronic supply vendor. See next page.

3.3 Solder Spool



Figure 5: Weller Solder Spool.

The above is a one pound spool of Weller solder. I got the deal of a lifetime in the year 2000 when a supply of spools came up on ebay and I wound up with 20 rolls for under one hundred dollars with priority shipping included using the no weight limit offer from the USPS for their box. Life is good.

Note. The solder consists of lead, tin and silver. I personally recommend and prefer the two per cent silver content. Makes for an extra shiney solder connection. IMHO.

3.4 Solder Sucker



Figure 6: Solder Sucker.

For the removal of a part or solder you will need a solder sucker. I love the one above. Search on ebay and you can find them for under five bucks US with free shipping from Hong Kong and China.

The sucker above is much easier to handle than the larger blue and yellow popular model from years ago.

3.5 Solder Dispenser



Figure 7: Solder Dispenser.

The above is my homebrew solder dispenser that I made from some 1/4 inch board and a wooden dowel rod.

The solder is dispensed through a small hole on the side to keep the solder from tangling. I just love this thing and it has saved me a lot of time and made soldering much easier.

I have a dispenser on order from China (Oct 17, 2014) and will put a picture on the next page after I get it. It would have an easier way to interchange spools for different diameter solder.

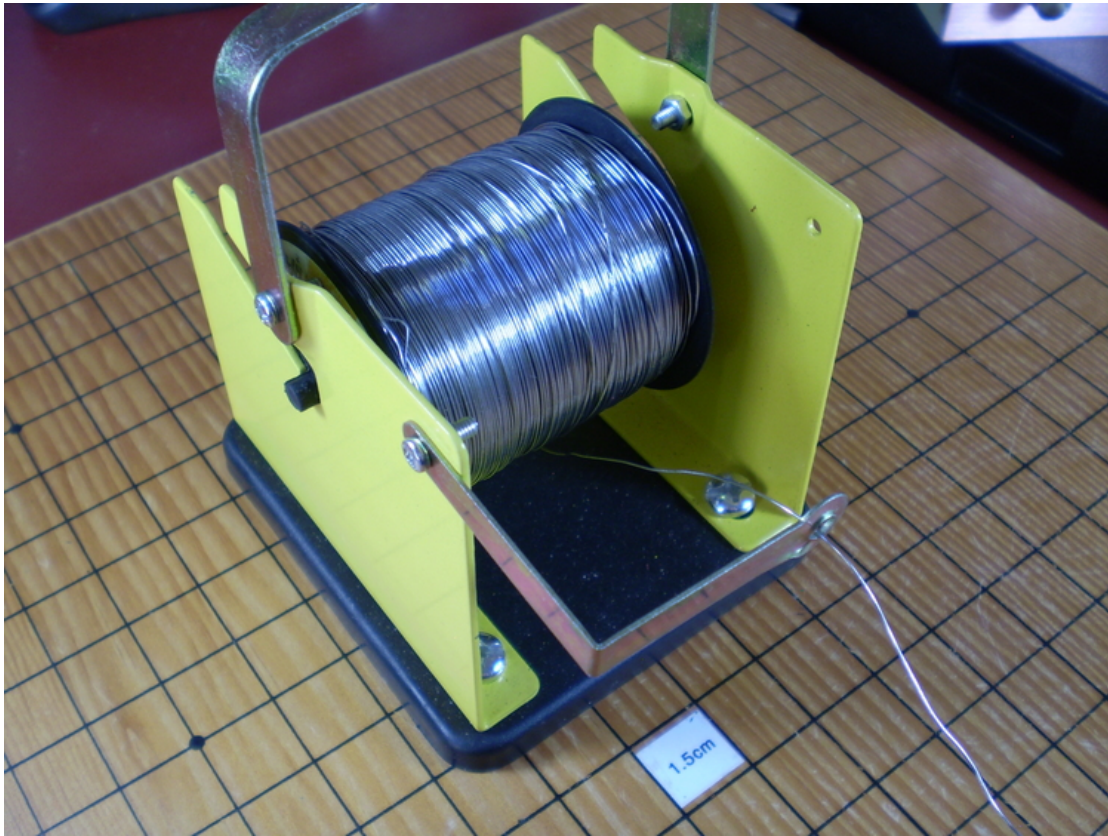

Figure 8: Solder Dispenser from China.

The above item ran about twelve dollars from China on ebay.

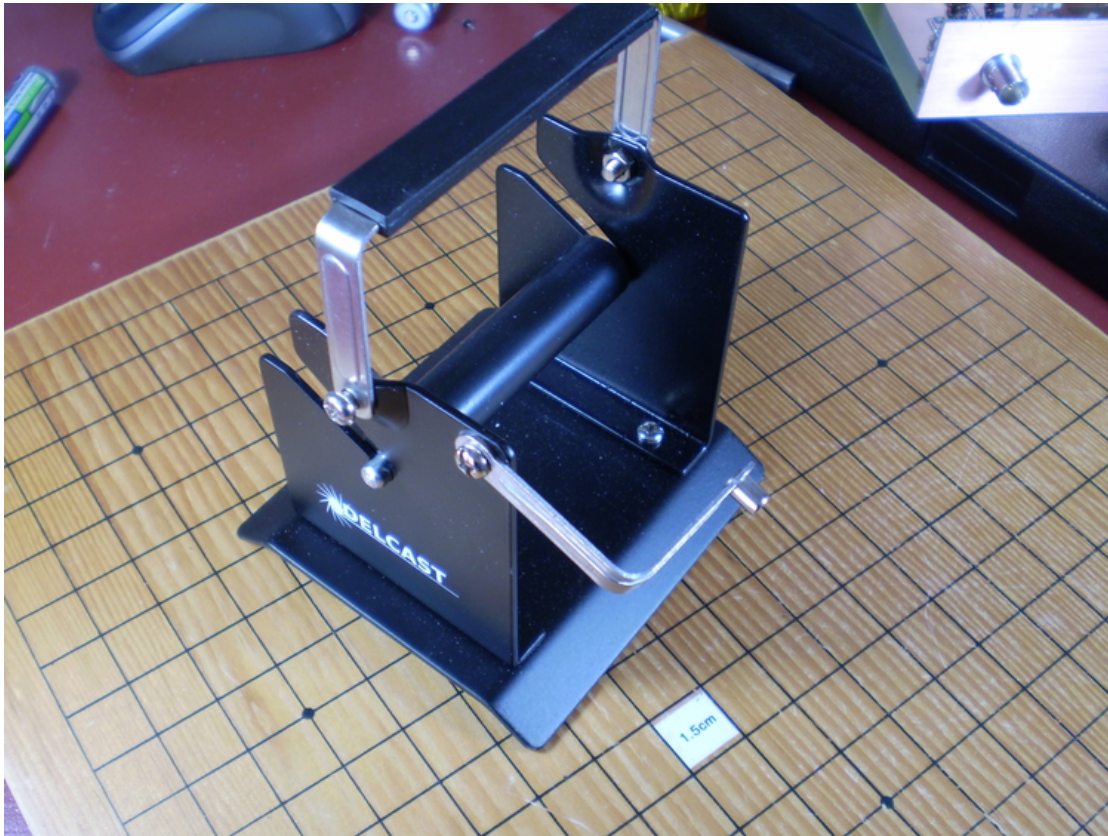

Figure 9: Solder Dispenser from US.

The above spool holder I got from a distributor on ebay that was located in US. Search on ebay for Delcast solder holder and the vendor is [jacobsparts](#) and costs \$6.72 in late Dec of 2014. Now up to \$7.23 in Jan of 2016. But, the shipping is still from from IN.

I love this thing. Keeps the solder spool from rolling off the desk and from developing a rats nest when pulling some off to solder. Also, by just having a few cm coming out of the holder, it acts as a third hand to hold the solder in place for tinning leads on components. You'll know what I mean when you buy one. A must have. Sturdy and well built. Will last a lifetime.

3.6 Hobby Knife



Figure 10: Xacto Hobby Knife.

Above is an Xacto hobby knife with a #11 blade. This knife needs to be treated with a great deal of respect. It can be used as a surgical scapel and thus is very very sharp and dangerous. You have been warned. It has numerous uses.

3.7 Sears Wire Cutters



Figure 11: Sears Wire Cutters.

The Sears diagonal wire cutters are my favorite. Not that expensive and they have a lifetime warranty.

Please, use these only for cutting component leads. Get another pair of cutters for cutting steel wires and other hard metals. You will be happier for the effort.

3.8 Wire Strippers



Figure 12: Wire Strippers.

Wire strippers are used for the removal of insulation from connection wire. There is an adjustment for wire diameter. This is much easier to use than using the hobby knife to remove wire insulation and prevents knicks to the copper wire under the insulation.

3.9 Chain Nose Pliers



Figure 13: Chain Nose Pliers.

Chain nose pliers are not the same as needle nose pliers. Chain nose pliers have a smaller tip. These are necessary for working with fine placement and bending of component leads. The ones above were made in Pakistan and I found these in the beads section of arts and crafts stores.

3.10 Lead Bender

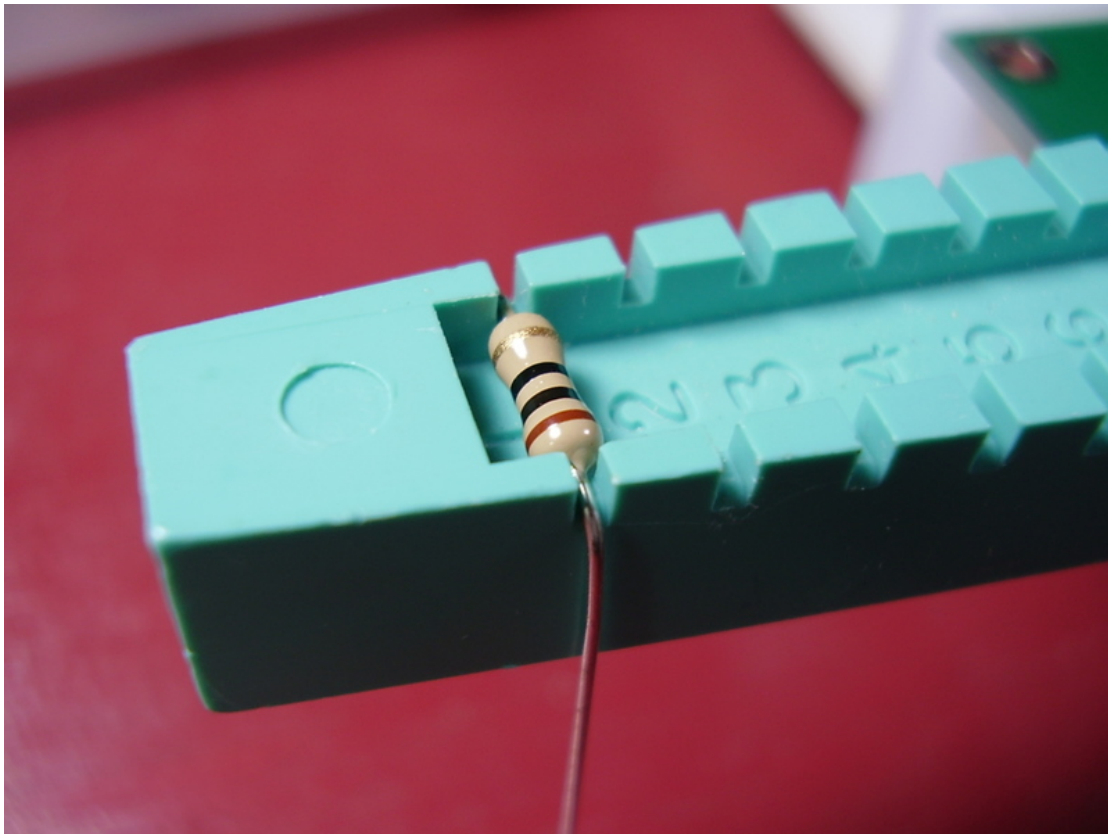

Figure 14: Lead Bender.

The lead bender may be a harder item to find. It allows you to bend the leads of resistors and axial leads of components to size. Especially helpfully for kits that use a standard hole placement for resistors. Makes for a neat assembly.

3.11 Super Glue



Figure 15: Super Glue Bottles.

This is not a tool, but while you are in Home Depot you will find the two bottles on the left in the paint department. I use these in the assembly of Manhattan style projects for glueing down circular pads for parts placement and assembly.

June 27, 2016: I found that the Loctite bottle has a longer shelf life than the other bottles. FYI.

3.12 Clamps

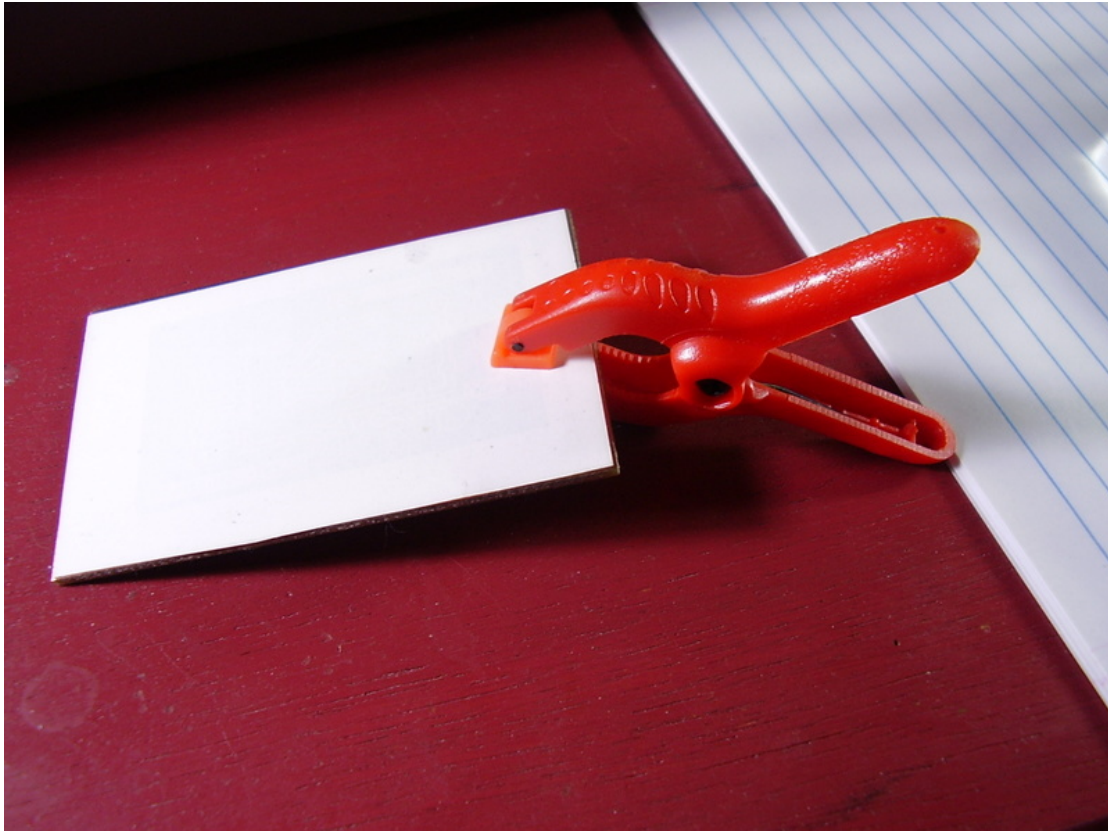

Figure 16: Plastic Clamp.

The small red plastic clamp above is from a set that I got at Harbor Freight one trip. They were on display at the checkout counter and you know why they put them there. I use them in PCB manufacturing during the hot laminator phase of the toner transfer process.

I also use clothes pins for holding stuff also when I need to use a soldering iron and would melt the plastic clamp.

3.13 Calipers



Figure 17: Mechanical Calipers.

The picture above is a closeup of a mechanical caliper dial face. I prefer the mechanical as they do not require frequent battery replacement as the digital calipers do.

I recommend you get both metric and english unit measuring calipers. Some calipers have a dual unit dial, but I have not tried them.

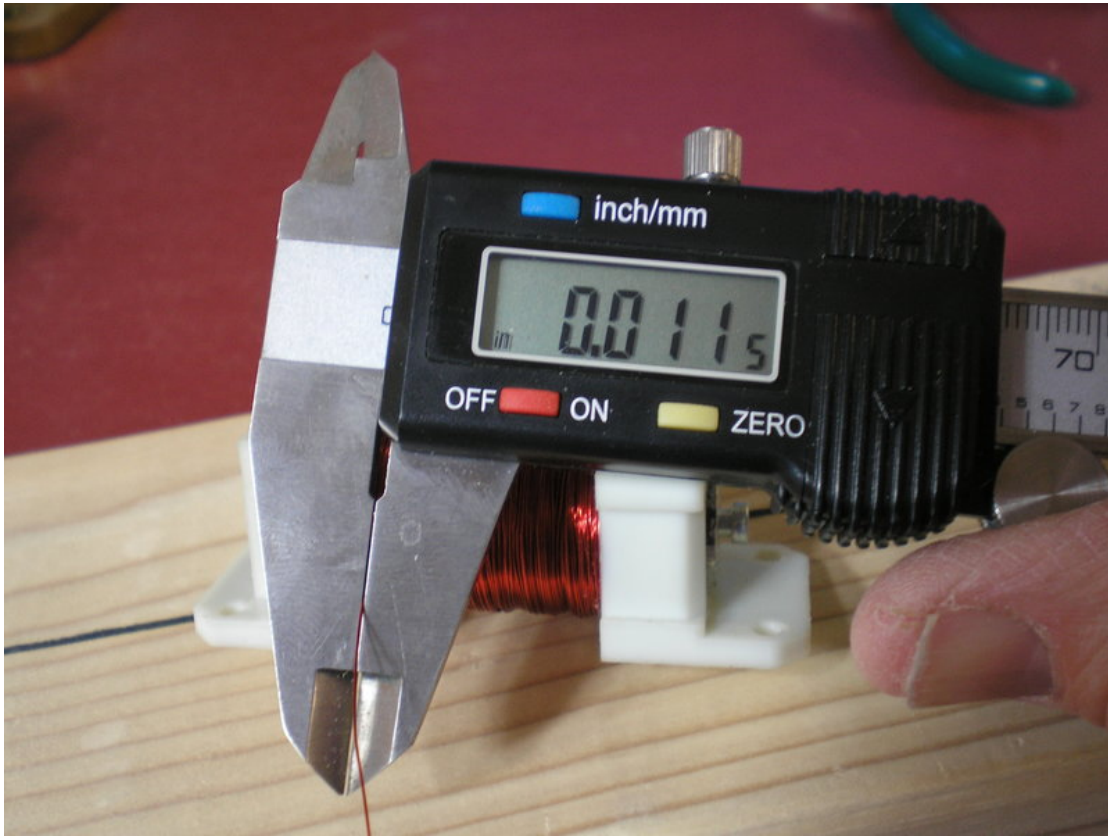

Figure 18: Digital Calipers.

Above is a digital caliper and its display.

3.14 PCB Holder

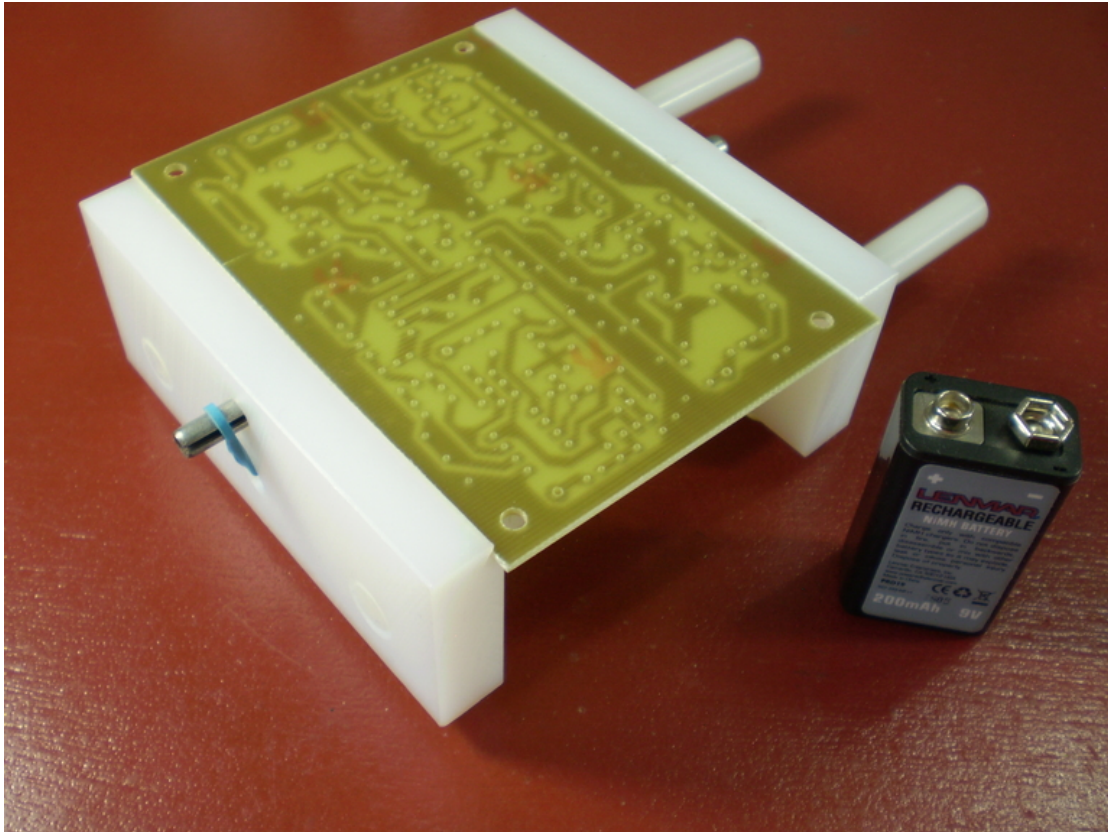

Figure 19: WA4MNT PCB Holder.

The PCB holder is available from Ken, WA4MNT, and his web site is <http://www.qrpbuilder.com/>. It costs \$23 US shipped. I love this thing as it serves to hold a board while doing assembly and it is very valuable for holding a board while powering up and testing. Keeps you from having it on top of some bare wire and shorting out and destroying parts of the PCB layer and components. Saved more than it costs. IMHO.

June 27, 2016: Ken has discontinued the manufacture of the tool. I found a replacement and will attempt to get a photo in this doc as soon as time allows.

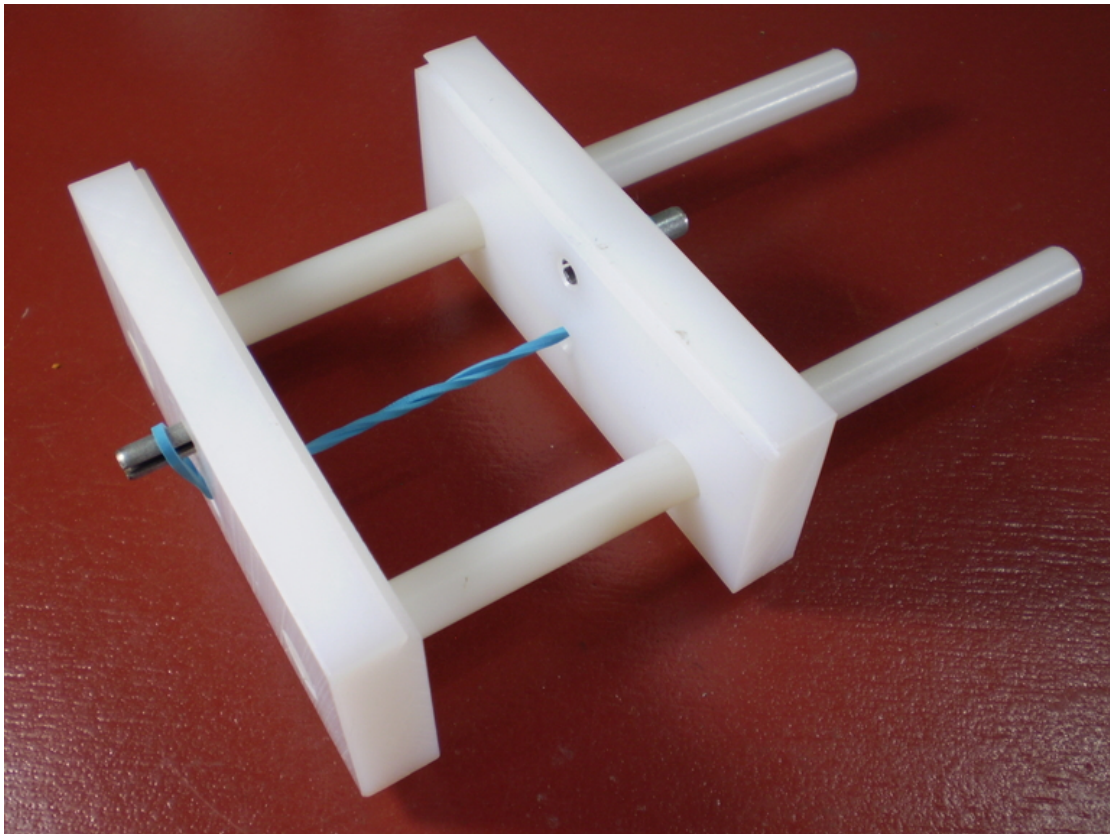

Figure 20: WA4MNT PCB Holder.

Chapter 4

The New and Improved Lab

Almost two years ago the wife and I decided to downsize. The house in Prescott AZ and the large property became too much for us. I hated giving up the 80m vee-beam and the large lab and a ham shack to die for, but the winters were getting to be too much for such a large hacienda. Also the requirements to maintain a large property were getting to be overwhelming and not worth the effort any more.

So here, is the new lab. We converted the Casita, a small guest cottage like building separate from the main QTH, to the K7QO Lab.

The view is of the solid core door painted up nicely and two computers. The one on the right is for creating PCB layouts with ExpressPCB and the one on the left is for listening to Internet radio with iTunes and the Sony audio system is on its edge behind the computer and monitor. The system also serves as my oscilloscope and spectrum analyzer with a DSO-2150 or DSO-2250 Hantek USB scope.

The critter in the middle is a new Wavetek Signal Generator from ebay bought in early 2012. We will be using it in the RF probe and voltmeter chapter as our main calibrated source of RF.



Figure 21: The New Lab Workbench.



Figure 22: Component Storage Shelves on back of the desk.

I am using 1 oz mini cups with lids for the storage media instead of the bulky pill bottles with the hard to open lids that are for the protection of the kids of the world. I made the house child proof, but the kids keep coming back.

The shelves you see are ones that I made using some 1/8" plywood and a hand router (not the plunge type) with a simple straight edge guide and spacer to make each shelf the exact same width. I did a groove in the back wooden sheet of plywood to keep the shelves straight for years of use. I am not a seasoned woodworker. I just dabble. I know how to measure twice and cut once. And, once in a while I will draw up a set of plans. ; -)



Figure 23: Closeup of the Storage Containers.

These plastic containers with lids are from Wal*Mart and found in the paper and plastic cups section in the market area. They are brand named Diamond and are called Mini Cups. They have replaced almost all the old pill bottles and they save space. I can get 3 to 4 of them between the shelves and can still easily see the labels. The cups cost less than \$0.06 each for 50 cups with lids. The labels on the cups are Avery stock number 5422 and I obtained them from Office Max in the labels section.

Here are two photos showing the use of Avery booklet seals. These are round and just the right size of the top of the containers. You can use these to mark additional information about the parts in the container. Here I have the forward voltage, V_f , of the LED at 5 milli-amperes of current. Nice to know for some projects.



Figure 24: Storage Container with Booklet Seal on Top.



Figure 25: Storage Container with Booklet Seal on Top.

I also still keep things like resistors, molded inductors and other components with longer leads in coin envelopes in a set of 25 drawers that I made up when I was in Prescott years ago. Here is the photo of the drawers and I will most likely never paint the thing. It is for utilitarian use only and not for show-and-tell.



Figure 26: Homemade Apothecary Drawers by K7QO.

I will add more details as time permits. I want to get the MUPPET show on the road first.

Chapter 5

The MUPPET Show

After years of building, experimenting and writing about Manhattan and PCB construction techniques, I have just come up with the term MUPPET board. MUPPET standing for the words Manhattan, Ugly and Precise Placement Experimental Technique. You can think of the following as allowing you to use all of the building techniques together as a hybrid and could even add SMT (surface mount technology) into the mix.

I use printed circuit board material as the basis for the building of a circuit. But unlike making a regular printed circuit board that has to be drilled with a large number of holes to place components, the MUPPET board allows you to place and solder components upon the top of the board without having to drill large numbers of holes. So in that respect it is like Manhattan construction, but without the tedious task of placing pads using super glue to hold them down. It is like ugly construction in that components are soldered to the copper layer, but if I think ahead enough I can save a lot of wires from one part of the board to another by doing traces, i.e. lines of copper material that form a flat wire from point A to point B.

But what is handy about the MUPPET board is that you form the pad area from the copper layer and create traces for signal and power paths to other parts of the circuit. You can leave a number of areas of the PCB plain (unetched) for room to construct modifications or additions at a later time. Think of this additional area as an area to 'tinker' in.

You can choose to be creative with either Manhattan or Ugly construction in these areas to improve or modify a project. Then you can do

a new board layout using all that you have learned for a final polished project, if you so desire. Or not, if you are the only person on the planet that will ever see the insides. And you don't even have to put a lot of projects in enclosures, especially for small test equipment or a build that tests a section of a larger circuit.

The way a MUPPET board works is that I can precisely place components and solder them to pads or areas using the leads of each component. I do not have to place Manhattan pads using super glue and wait for the glue to cure. If you work it out, a great deal of time is invested in doing pads for the Manhattan style of construction. And even for the drilling of a large number of holes for a regular PCB layout with the copper foil below the board and the components on the top side of the PCB.

You have to plan ahead on any layout, no matter what technique. You will paint yourself into a corner if you don't. I use ExpressPCB software to do the board layout. I do not do schematic capture, so this is just using experience to guide me in my layouts. Comes from doing so many Manhattan Projects over the years.

Let me demo the technique for you. The first muppet project^(tm) will be a simple board. This is a just a test board for you to do and check out the procedure. You have to walk before you can run.

Here is a list of the items that I use. You may substitute where you see fit. This is not a do it just my way technique. You may think of something that I have not. Let me list them and then give details where needed.

- PCB material
- Steel Wool #0000 or 3M Heavy Duty Stripping Pads
- Software for board layout and a computer to run it on
- A Laser Printer
- Hammermill Laser Gloss Paper
- Laminator or Common Clothes Iron
- Small plastic clamp for hot PCB material
- Hydrogen Peroxide (2%)

- Muriatic Acid (14.5% HCl)
- Pyrex dish
- Plastic 1/4 cup for measuring the etching fluids
- Clear enamel spray paint
- and all the components that make up the project.

5.1 Printed Circuit Board Material

I use printed circuit board material that I get on the Internet from Ebay. The vendors name is [abcfab](#). Here is a link to his online store on ebay.

[abcfab Store](#)

I like to go for the board by the pound sales, but if you are just starting out, then go for the FR-4 material, flame-retardant, and I like the 0.060" thickness and single sided, if you can find it in stock and like the pricing. Also, if you are going to do PCB enclosures for projects, at the same time get a supply of larger double sided (DS) PCB material. This makes great enclosures, as I will show you in another chapter devoted entirely to making enclosures.

If you don't like the above supplier (he does have a 100 per cent rating), then find a supplier for the PCB material and get what you think you can use. If you already have a supply, then all the more better.

5.2 Steel Wool or 3M Heavy Duty Stripping Pads

These two items I find in the Home Department of Wal*Mart. Both are about the same price. I think I am going to prefer the 3M stripping pads for a reason that I will demonstrate in a photo to follow in this section and a discussion in the enclosure chapter.

The steel wool also does a nice job.



Figure 27: 3M Heavy Duty Stripping Pads.



Figure 28: Fine Steel Wool.

What we need either or both of the items for is for cleaning the PCB before we do anything with it. The board material has oxidized as copper is a metal that easily tranishes and oxidizes. Also, some board material may have been handled with bare hands and finger prints and oils will tarnish the surface badly.

Just take the board you are going to work with and lightly rub it until you get a nice clean surface. I then wash with tap water and rapidly dry it before it reacts with the crud in the water. Water out of the warm tap will work better than the cold. Not because of temperature but because the warm tap water is purer than the cold water. Trust me on this.

Here are photos of three boards, the same size and from the same batch received from an order with [abcfab](#).



Figure 29: Unmodified Board.



Figure 30: Board Cleaned with 3M Pad.



Figure 31: Board Cleaned with Steel Wool.



Figure 32: Cleaned Boards Side by Side.

As you can see above, the 0000 steel wool does a smooth job. I am a fan of the 3M pads and I think that a famous online builder, AA7EE, used a course material for removing tarnish from his boards before coating with clear enamel spray paint.

AA7EE's Handiwork on PCB Material

Another thing about the rougher surface. In the toner transfer method we are going to melt the toner and 'fuse' it to the PCB surface to protect it against the etching fluid. Which surface do you think the toner will stick to more tightly than the other? My guess is the plowed corn field material. I will sacrifice both boards to scientifically determine which is better. Bill Nye is very jealous of this experiment. He did not do it first.

Two things about this cleaning procedure. The first being that you get a clean substrate that will be easier to etch and also easier to use the toner transfer technique, see the second section after this one, to mask off the areas we do not want to remove from the FR-4 material.

I do my cleaning in the garage on the old trusty and sometimes dusty workbench. I use a sheet of newspaper to do the cleaning on as it creates fine copper dust that I do not want in any electronic gear and if you use steel wool then it leaves steel fibers all over the place. You can fold up the newspaper afterwards and put it in the trash and you have a clean area. Neatness counts in this business or you are going to pay for not getting organized by destroying a project.

5.3 Copper Foil Layout

This first demo will show how we lay out a the foil pattern to be used in a construction project. Let's do a simple board. This board will have a number of straightline traces of varying width to show just how fine (narrow) traces can be made on a PCB.

Also a couple of pads to put a 1/4W resistor on and demonstrate how I make the leads match.

Use what ever program you want to layout a simple pattern shown in the next image. I use ExpressPCB as it had a simple learning curve and has no physical limits on the layout and it is free. Here is the URL to find the program.

ExpressPCB Download URL

I run the program under [wine](#) using debian linux 7.0, which was just released in early May 2013.

Make, using your program of choice, the following pattern. I did mine on the top layer of the board. I also made a ground plane filled area with 0.030" spacing between the plane and the traces and pads. Use 0.10" square pads at the end of the traces. I also have text showing the width of the line for the single trace between two pads. Make this to fit a board size you have. Mine is 4"x4" for this test.

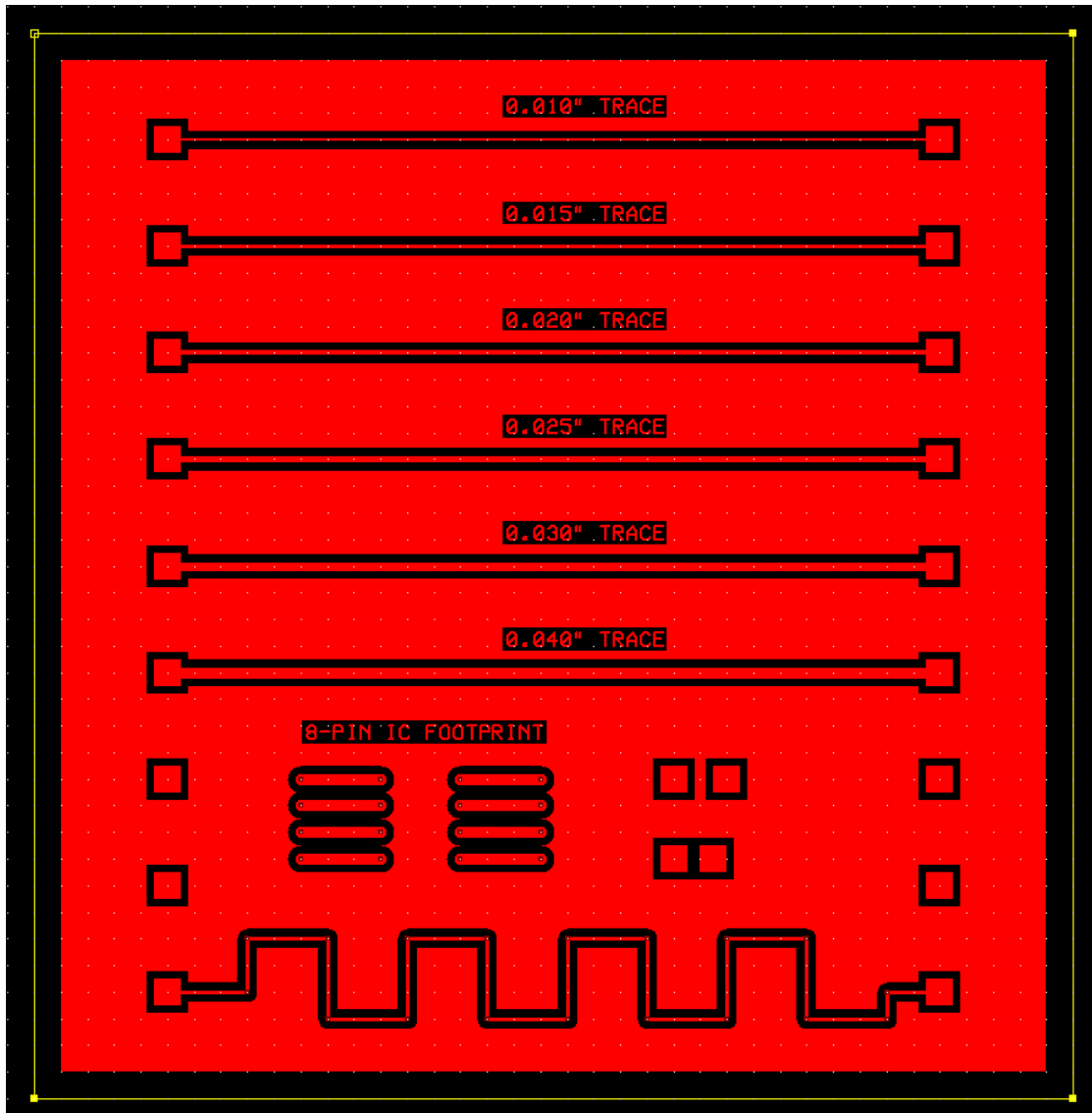

Figure 33: ExpressPCB Test Board Layout.

5.4 Printing PCB Layout

Now that you have a board laid out in software, it is time to convert it to a hardcopy. Now you have to put on your thinking cap. If you print out the top layer to a laser printer, you will look at it and you can read the text and 99.99 percent of todays printers will do a 1:1 ratio on the print and it will be the right size.

But you do not want to print the layout just now. You have to have one of two things. A printer with an option to mirror or reflect the image about the vertical, so that it is reversed.

Or, if you are running something like ExpressPCB using [wine](#) under Linux, then all you have to do is setup a PDF printer. Google on how to do that.

```
sudo apt-get install cups-pdf
```

for debian based linux systems.

Then when you do a print from the menu option in ExpressPCB, select to print the top layer only and send it to the PDF printer. It will generate a file named PDF.pdf or ExpressPCB.pdf. You have to have LaTeX installed under Linux with the latex-options package that contains a program called [pdfflip](#) that will reverse the image and create a file named PDF-flipped.pdf or ExpressPCB-flipped.pdf. Now send the flipped file to the real physical printer and you will get the image that you need to do the toner transfer.

I use Hammermill Color Laser Gloss paper with the printer. This paper is heavy weight and it is silky shiny smooth. The laser printer heats the toner and 'fuses' it to the paper surface. We will be reheating the toner, while it is contact with the copper layer of the PCB material to get a Oreo type sandwich made up of paper-toner-copper. A photo of the paper is shown a few pages further into this document.

Here is the PDF output from ExpressPCB flipped. This is what we will use to laminate to the PCB material. The file that I point to in the next section will print so that the board is four inches square.

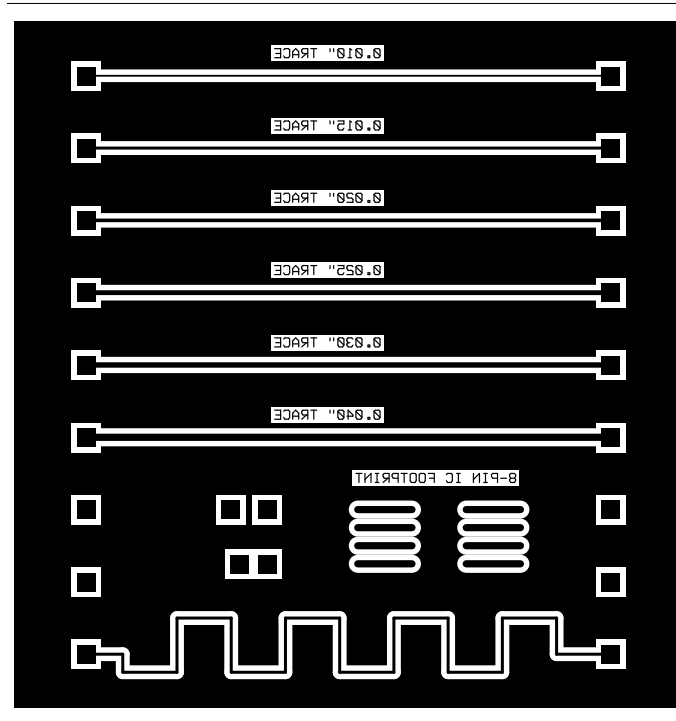

Figure 34: Test Board Layout for Printing. Not to scale.

5.5 Laminator to Transfer Toner to PCB

Now you have a piece of paper with the layout on it. You have two ways to transfer the toner to the PCB copper layer. Iron it on or use a laminator. If you are so strapped for cash that you can not or will not purchase a laminator to transfer the toner to the PCB then you are on your own. Google for iron on toner transfer and get the instructions. I've done it and I would not recommend it now. I get 100 per cent success with the laminator. Much cleaner and faster. IMHO.

I use a GBC BadgeMates laminator that I bought on sale at one of the big box office suppliers. It has been a while and I think it was Staples.

Here is a picture. If you have the capability, here is a video that I did to show it in use.

K7QO Use of Laminator Video Snippet

The laminator quit making the funny little noise after the video. I'm really not worried about it and I think it is going to outlast me. I will let you know when it fails, if ever.

Following the steps in the video, I have now transferred the test pattern to both the boards, soaked in water and removed the paper. You do not have to be retentive about the removal of the paper. Just make sure the bare areas of the board are clean. There is some chemical in the paper that dissolves in the water and I just like to make sure that it does not interfere with the areas to be etched.

5.6 Your First Board

I'd like for you to try the following board. It requires a 4"x4" piece of single sided material. It took me less than 10 minutes to etch it with a board that has 1 oz copper density on it. I'll put the PDF file at:

PDF of test board.

Download it and print it on Hammermill Color Laser Gloss paper and iron or laminate it to a clean board. Here is a photo of the paper that I use. People search far and wide and I have done the same and I think this is the best paper for the job at hand. It has a smooth surface and

it removes well with soaking in water for about 10–15 minutes.



Figure 35: Hammermill Color Laser Gloss Paper.

Then you CAREFULLY mix two parts hydrogen peroxide (I use two 1/4 cups into a pyrex 750ml rectangular dish from Wal*Mart) and THEN put in a single 1/4 cup of muriatic acid. Be very careful with this chemical. Remember your chemistry class where they taught you to put the other chemicals in first and the acid goes LAST every time. Here is a photo of the pyrex dish, measuring cup and spoon that I use.



Figure 36: Pyrex Dish, Measuring Cup and Spoon.

GENTLY stir with a plastic spoon for a few seconds to mix things up. Do this in the garage or outdoors or in a well ventilated place with the air moving away from you. Do not breath the fumes at all. Keep away from your body and your eyes, ears and mouth.

Then put the board into the mixture with the toner side up. You should see the copper turn dark almost immediately. That is the oxygen combining with the copper to oxidize it. Now just gently keep moving the liquid around with the plastic spoon. Do not try anything fancy and make a mess or cause serious injury. Just take your time. You may also note a bunch of bubble coming from the small amount of paper remaining attached to the toner.

It takes me about 6-10 minutes of gently stirring the liquid over the board without touching the toner at all. After the board has etched, then remove the board with rubber gloves on and clean with warm tap water.

Dry the board with a paper towel and set aside for a moment. Come back and put almost a 1/4 cup of baking soda into the mixture to neutralize it. Flush this. Flush twice to really dilute the stuff.

I take the board and then using the fine steel wool and a lot of elbow grease I remove the toner from the copper layer. Try not to damage the copper, but do get it clean

Then wash and dry and then I put a very very thin layer of clear enamel on the board and let it air dry for a few hours. This is the tough part. I know you want to get to melting solder almost immediately.

Here is what your finished board should look like. Take lots of pictures and send them to your relatives to show how smart you are to be able to make electronic boards.

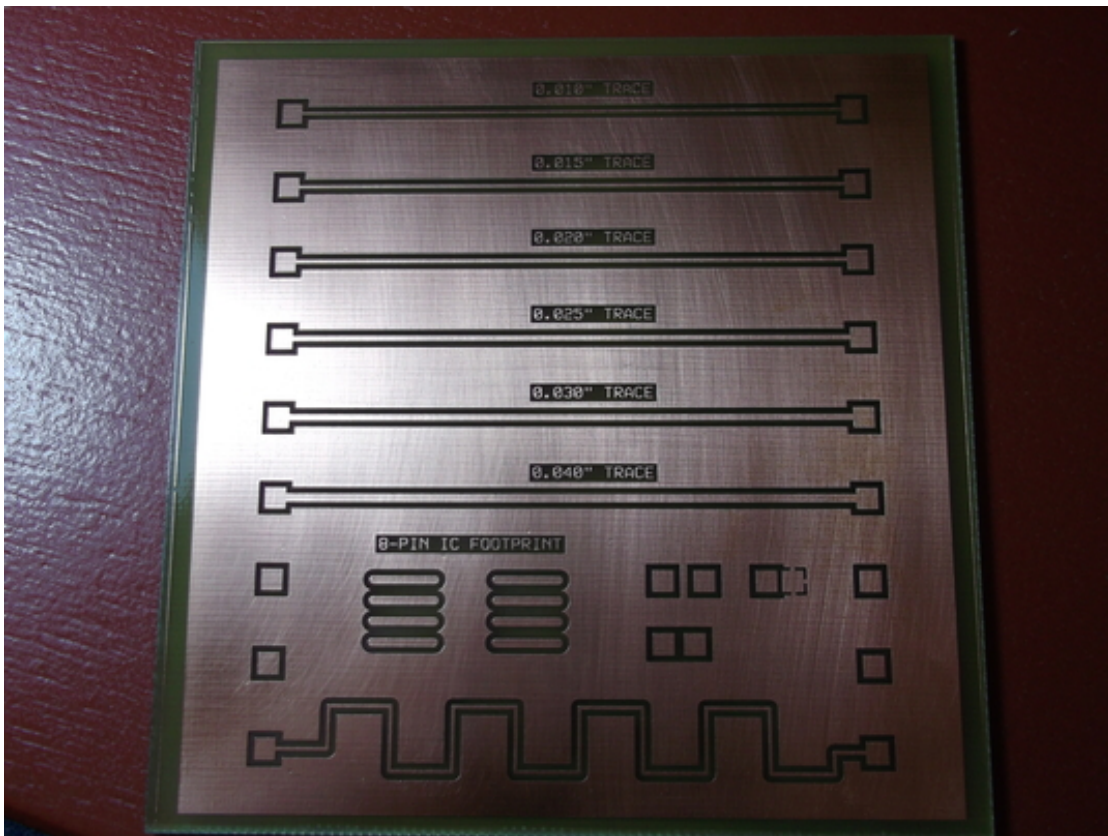

Figure 37: K7QO MUPPET 000 Board.

5.7 Test Soldering to PCB

I want you to see how soldering to a muppet board works.

I use a Weller 25W soldering iron, just like the ones you will find in the tools department of Home Depot. Costs about \$20. I have an old Ungar tip on mine, but the stock one will work just as well. I have built over 200 kits with this same iron and the tip. Too bad that Ungar does not make the tip any longer. I'd buy a dozen, not that I need a spare.

First. Using the iron and some solder, tin each of the square pads at the end of each of the straight traces. Don't use much. Just a thin layer will do. I use solder that has two per cent silver. It comes out the shiniest for me. I recommend a thin solder for better control.

Here is what I got for my board. Take a DMM and measure the resistance of each trace. Write this down in your lab notebook that you should be keeping. The resistance will depend upon the thickness of the copper layer and the width. You want the math? You should get a small value for each trace. If you get an infinite resistance, then the trace has a break in it. Use a large magnification spy glass to search for the defect if you encounter one. It's not critical here, but it will be the demise of a project if it occurs later. Analyze what went wrong to cause the break, if and when it occurs.

After EVERY board that I etch, and this is why I use single sided board, I put it up to the light and I carefully examine every square mm of the board for defects. It is much easier to find problems now than later. Been there. Done that. Just have fun doing this. It is not a race. You may wind up taking days to find a simple error when the projects get bigger.

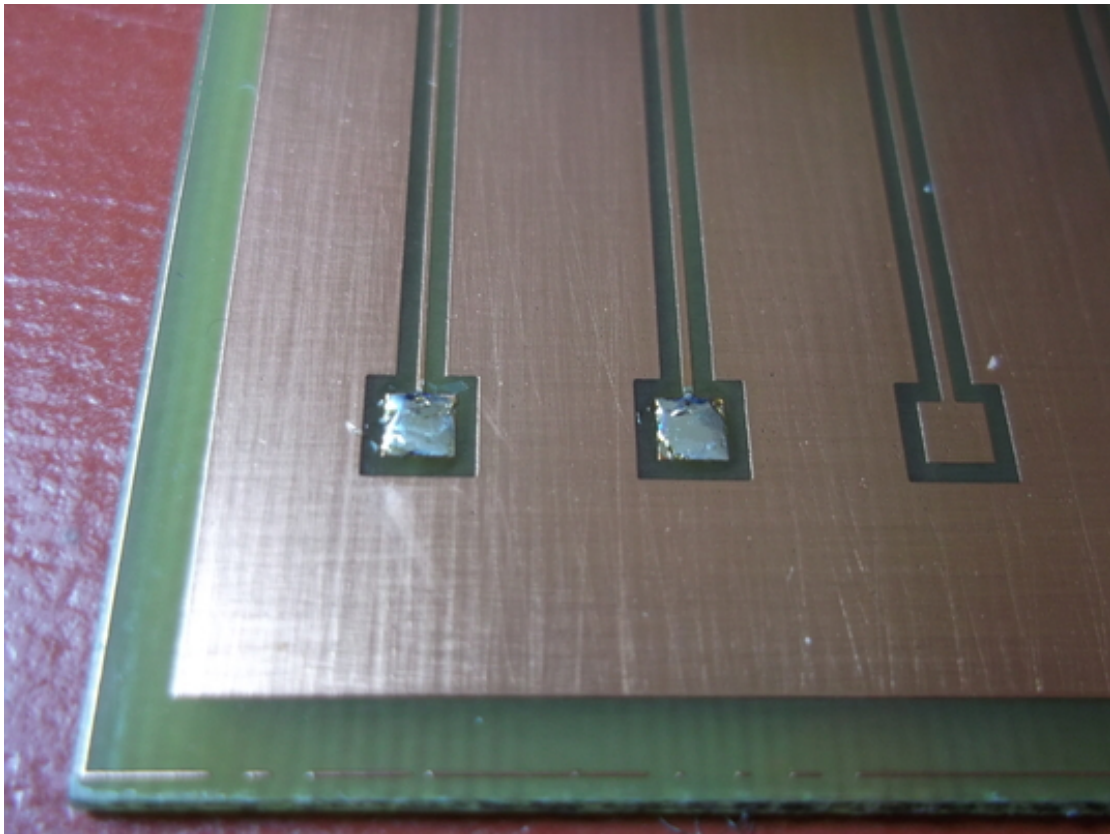

Figure 38: K7QO MUPPET 000 Board with soldered pads.

Here is board with just some of the pads at the end of the straight line traces soldered. You pre-tin the pads to solder components to or wires to during construction of a project. Just a itsy bitsy teeny weeny bit of solder is all it takes. Solder is so expensive now, that I know I don't have to convince you to use a little and not a lot. This is not an aircraft carrier we are building.

Now, with your DMM set in the lower range of resistance measurement, measure the resistance of each of the straight line traces at the end pads. If you get an infinite value on the 0.010" trace, then you have to find and correct some step in the process to eliminate the error(s). The resistance in my probe leads was greater than that of any of the traces and I estimate about 0.1 ohms for the traces.

5.8 Resistor Placement on Muppet Board

I'll show you how to mount a resistor and the steps that I use. You can easily determine how to do other parts. There are some parts, like the SBL-1 and relays, that are going to be a royal pain to figure out. It's not all easy, that's what makes it fun. If it was easy, everybody would be doing it.

Get a scrap piece of vector board or make a fixture out of a piece of scrap PCB material that is 0.060" thick. I use the board edge to bend the lead to form a hair pin like structure.

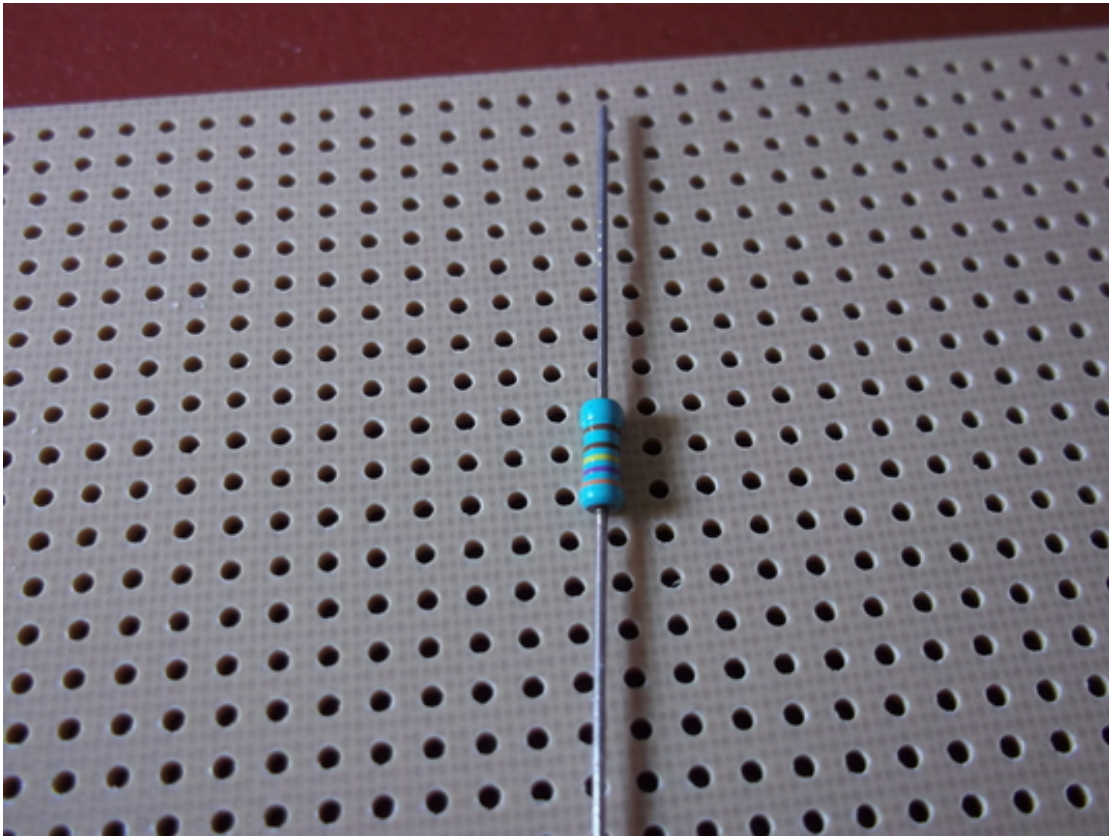

Figure 39: Vector Board and Resistor.

Above we see a section of what we call vector board. It has 0.10" spaced holes. And, since I laid out the practice boards with pads spaced at 0.20", we can preform component leads to fit.

I went to the parts draw and found an envelope with 100 4.73K ohm resistors that I got at some place in some galaxy some time ago. I know of no reason to have 4.73K as we usually use 4.7K in most circuits. So let's sacrifice this puppy for the good of mankind. And I'll show you that it's not really a sacrifice, as I have not lost the part and can reuse it if need be.

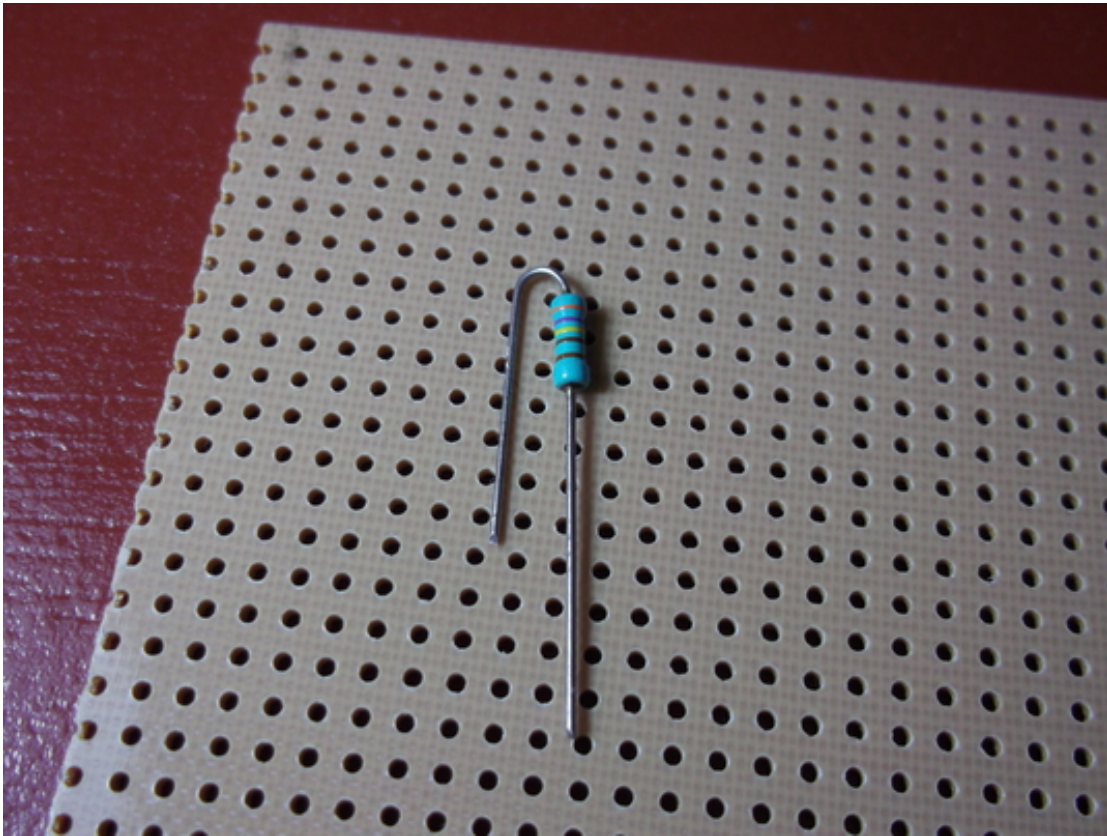

Figure 40: Bent Leads on a Resistor.

Here is what the part looks like after we bend its little legs. I just hold the part flat against the top of the board with the top of the resistor aligned the with the top row of holes adjacent to the edge (the top edge in this photo and not the raggedy edge on the left) and then bend over the top. You can get every resistor bent to the same dimensions every time. I'm OCD with ADD. I like perfect but not for very long. I just like the looks and it isn't that much trouble to bend them using the fixture.

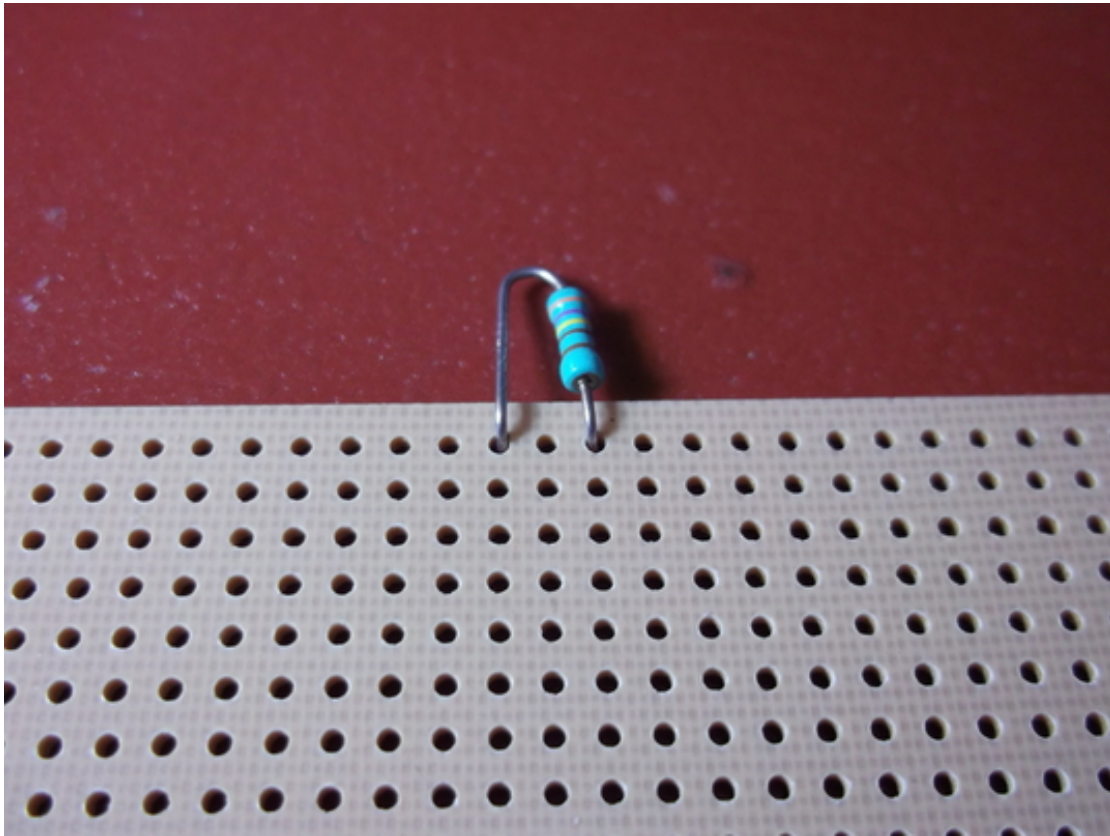

Figure 41: Preform resistor leads for PCB mounting.

Now, insert the resistor into the two holes that are the same distance apart as the pads where you want to place it. Here I am using the 0.20" spacing that is the same spacing I set the first two practice pads to the right of the IC pads. WHILE you have the resistor in the holes and bent, use your diagonal cutters to cut the two leads on the other side of the board flush with the board. This forms two 'feet' that will soldered to the pad. Gives you some length to form a good physical structure to hold the part in place and give a low resistance path for signals and currents to pass through.

This may take some practice to get a feel for just what pressures to use, etc.

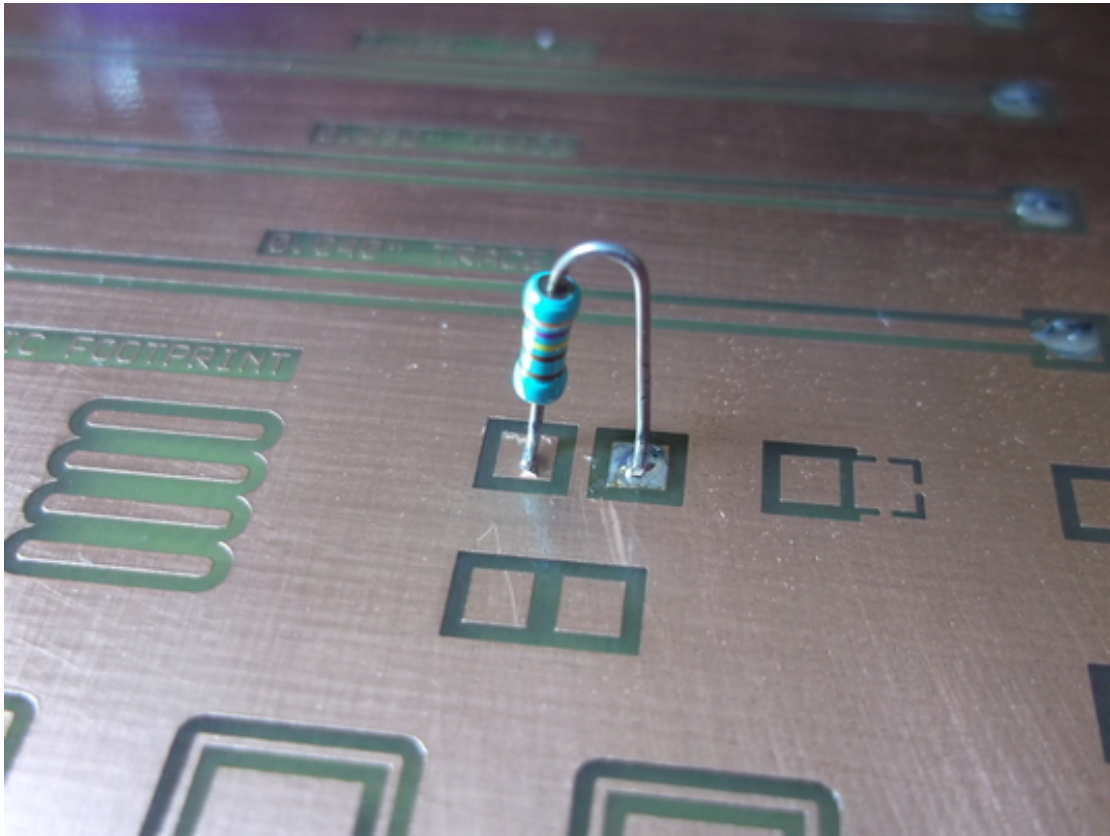

Figure 42: Resistor in place with one lead soldered.

Now, tin the two 'feet' of the resistor (lightly) and ONE and only one of the two pads. Just a smidge of solder will do. You should get something like you see above. I tin only one of the pads so that the second leg will be flush with the pad before I apply solder.

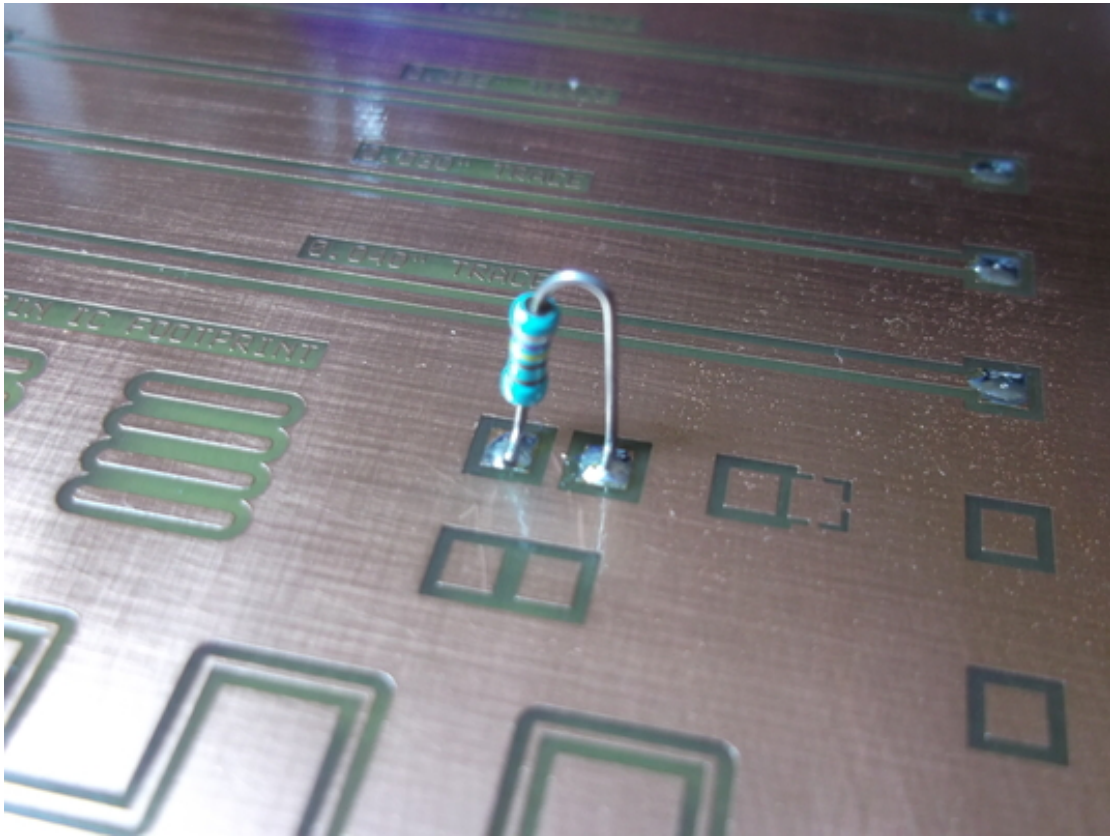

Figure 43: Resistor soldered in place.

Above is the final result. Let me also note. You can have the feet of the resistor closer to the inside edges to allow one or more other feet from other parts to also be soldered to the same pad. This you will need to do for more complex circuits. I'll show you two approaches to this in the next chapter on how to do a crystal oscillator.

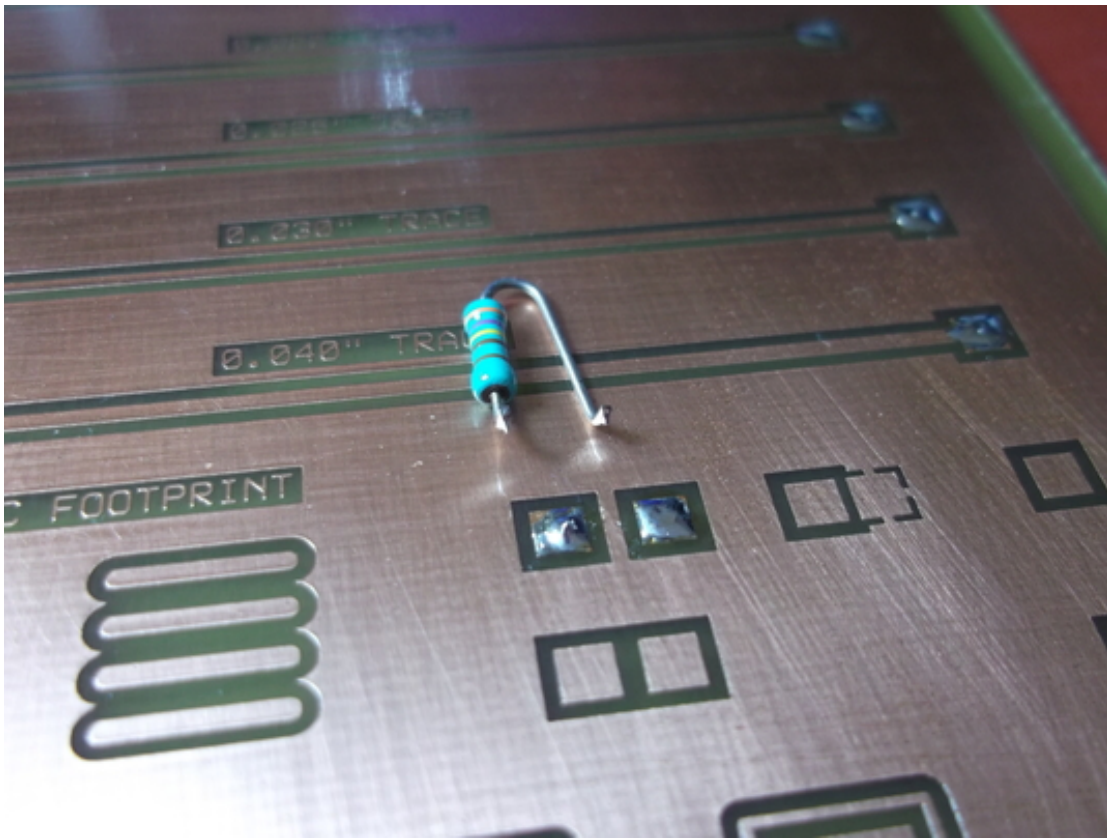

Figure 44: Resistor desoldered from its location.

Above you see that I have unsoldered the resistor from the two pads. I have not harmed the resistor nor have I ruined the PCB. You can easily replace a part with one of another value if you think the circuit, after testing, needs some other value. You can keep the old part for later use. just gotta figure out where and how to store them for later.

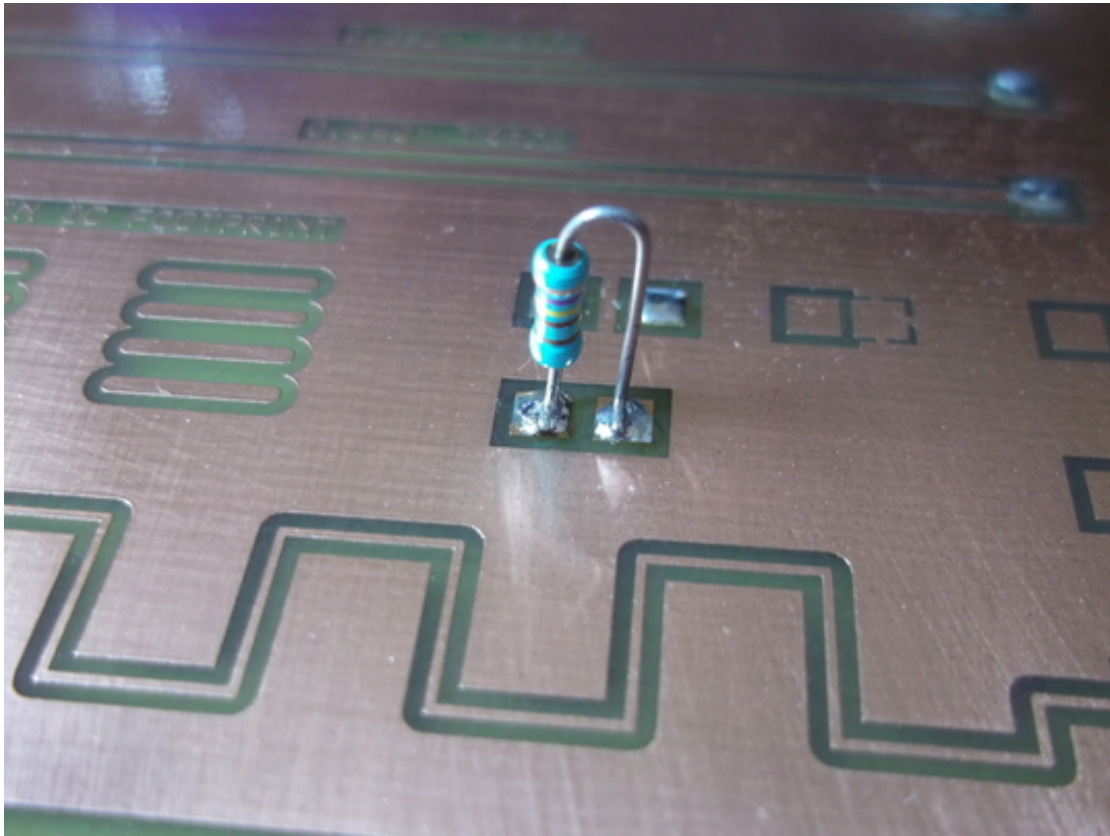

Figure 45: Resistor soldered into closer pads.

Using the same resistor. I go back and using the vector board I then form the leads closer together. This then allows me to solder the resistor to the two pads that are closer together. This is practice later when you want to make more densely populated boards for more complex circuits. You do not want the real estate to wind up the size of some Texas counties.

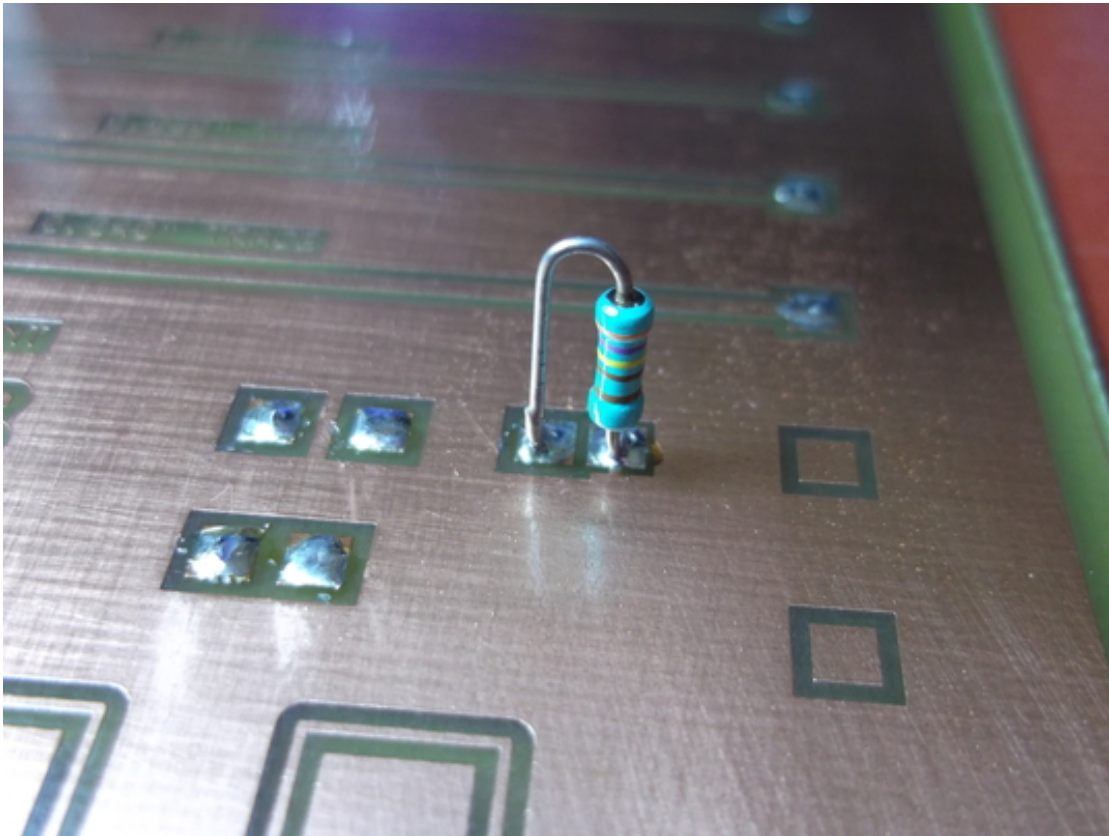

Figure 46: Resistor soldered to two pads. One at ground potential.

I tinned the ground pad first, which I do with ‘thermal relief pads’ in ExpressPCB. I do thermal relief pads for two reasons. One, to remind me that the pad is there and to double check for matched sets of pads before etching and during the board layout process. Second, to allow me to pre tin the pad and not have to heat up the entire board and take a lot of time in soldering. This, if you experiment with it, you will find to be a great help. IMHO.

And here is the MOST IMPORTANT thing that I can teach you here. Put the short lead of any component to the ground pad. That pad is at ground potential and you would have no reason to ever measure a voltage at that pad. By putting the lead that is not at ground potential on top, you can easily get a DMM or RF probe tip to it to measure a voltage or probe with a scope for a signal during a power on condition. Or to check for a short to ground WITH THE PROJECT POWERED OFF.

Also, plan ahead to do make things easier to measure in board layouts to make debugging and test measurements easier.

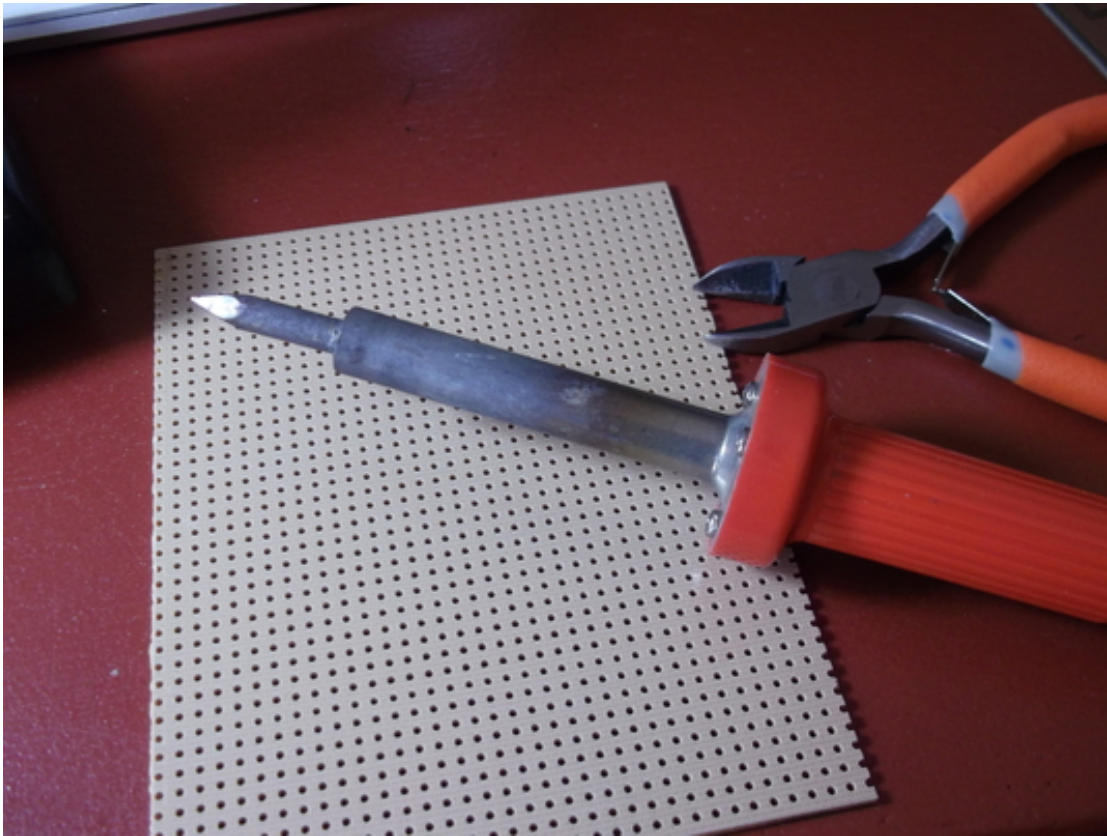

Figure 47: Weller iron with Ungar tip.

Here is an old old Weller SP-23 with the Ungar tip. Been using this thing forever. Money saved on a soldering station more than paid for one or more kits.



Figure 48: Solder iron stand.

I found this soldering iron stand (originally from Radio Shack) at a swap meet for the measly price of one buck. I like it as it doesn't cool down the iron and makes it handy to pick up.



Figure 49: Wash cloth.

And this will piss off a lot of guys as a bad idea. I keep my iron clean by just a swipe across this cloth rag. It does two things for me. It does NOT cool down the iron as with damp sponge critters and it does a good job of getting crud off the tip. Your mileage may vary. Cheap solution to an old problem.

Something I forgot to mention, but now is a good time. Did you wonder, when you saw my vector board fixture for bending leads, why did Chuck leave one side of the board cut at an angle and ragged? Here is why. Two pictures worth 2,000 words.

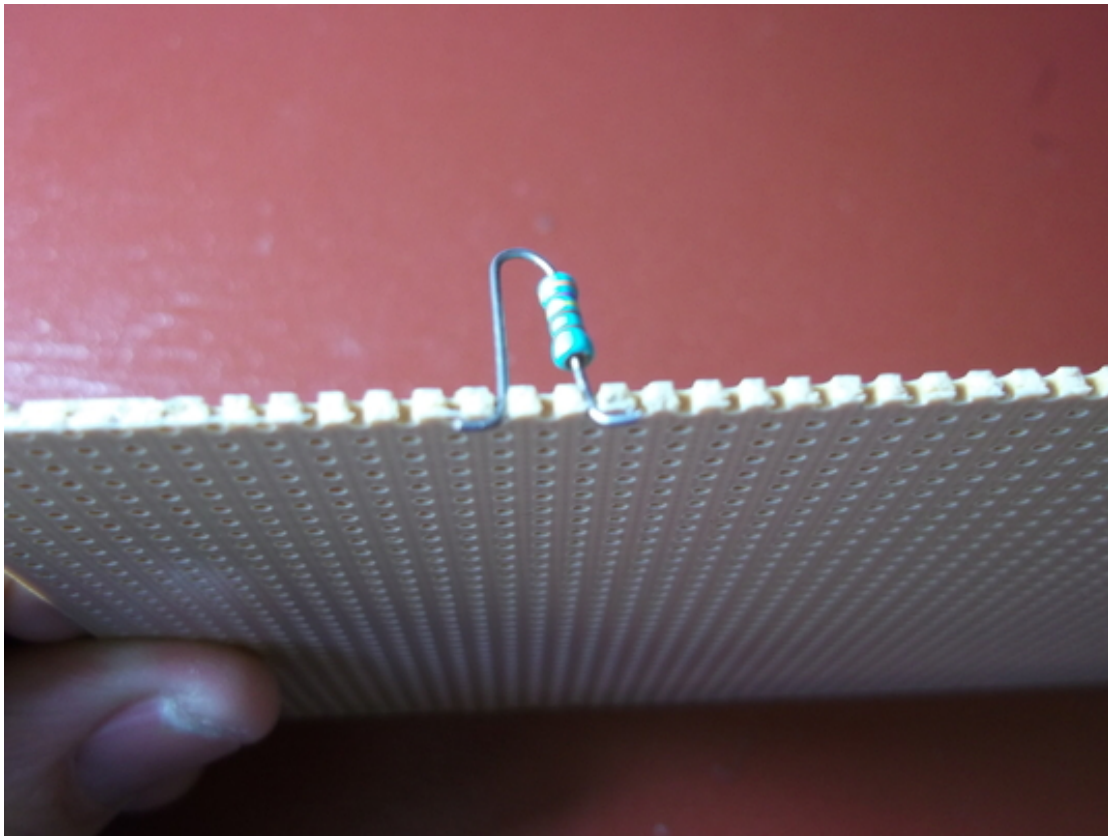

Figure 50: Edge bending of resistor leads.

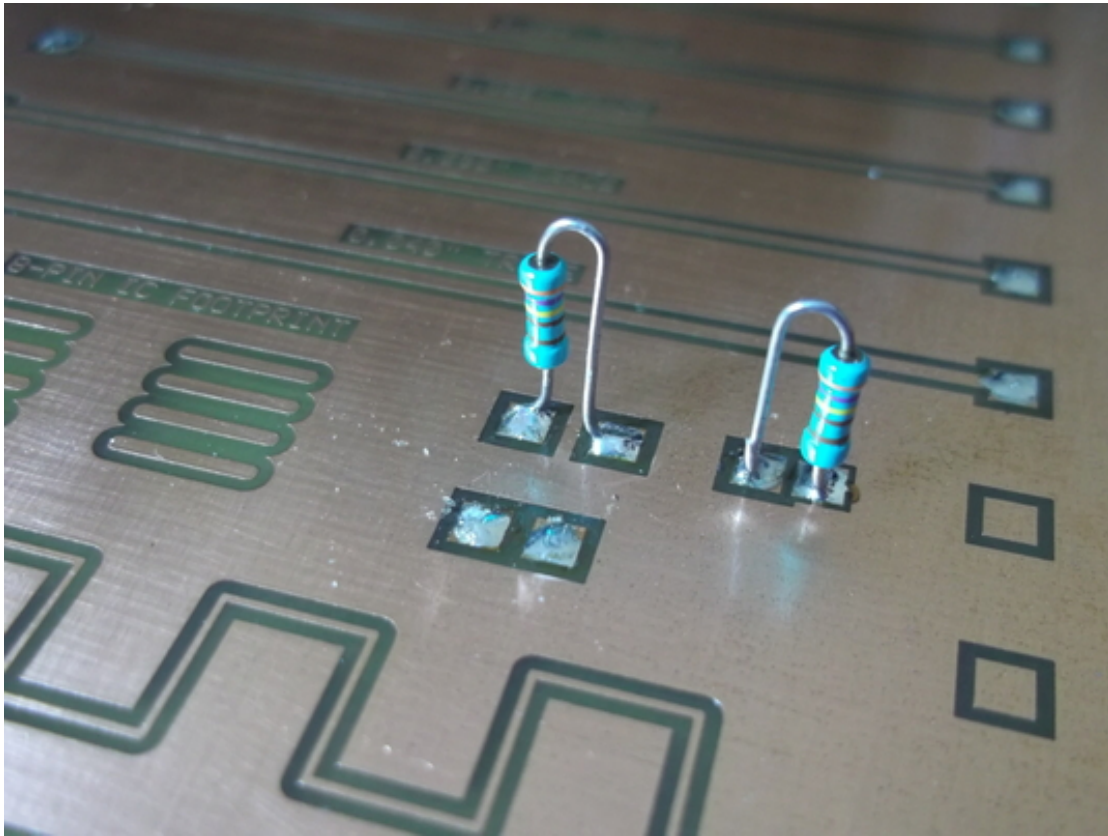

Figure 51: Resistor soldered into place with leads outwards.

OK. Enough of the newbie lessons for today. Let's now get on to some real building and experimenting that will result in some useful stuff for the workbench and shack (if separate).

5.9 Soldering IC Sockets and IC components

For IC components, like NE602A mixers and LM386 audio amplifiers, I like to use sockets. It is just my personal favorite just in case I want to abandon the project or need a part for some other device from time to time. I have not had one fail on me, even after years of use in a transceiver. And, I have not had troubles with connections between the socket and the IC. Some people complain from time to time on the Web and I wonder what they did to get the problems.

On the practice muppet board I purposely made an 8-pin set of traces to solder a socket to and demonstrate the technique that I use.

I first use solder and the soldering iron to pre-tin the socket pins that I have bent out from the bottom of the plastic that makes up the socket. Here is a photo of what it looks like. Note that I have pre-tinned pin number one on the board. I always do pin number one first to help remind me which way the socket is to be orientated when I go to start soldering it to the board. I have an OCD and an ADD problem. I like to be perfect, but not for long.

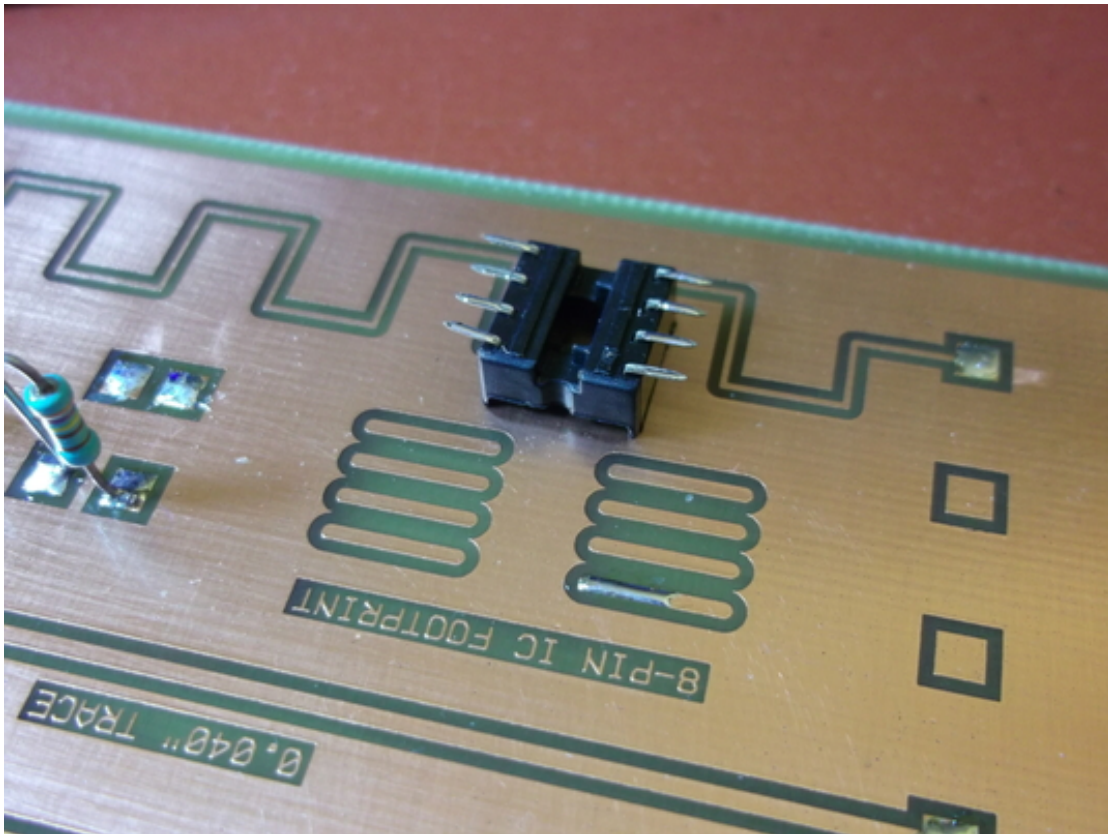

Figure 52: Pre-tinned leads outwards from the socket.

Then I carefully center the socket over the traces and heat the leg and the pad to place the socket. I double check to insure that all the leads are centered on all the traces.

I then solder the opposite leg to its corresponding trace and then double check that all the remaining legs of the socket are centered on their traces. Double check to make sure the socket is oriented with the half-moon adjacent to the number one pin on the PCB correctly to remind you the direction and orientation of the IC chip when you insert it into the socket during later assembly. They do not like to be powered up backwards. It could destroy a part in not time at all.

Here is photo of the two pins soldered and you'll note that in this example that the solder joint on pin number one isn't quite right, but it did hold the pin down. Which is all that is important at this stage of the game.

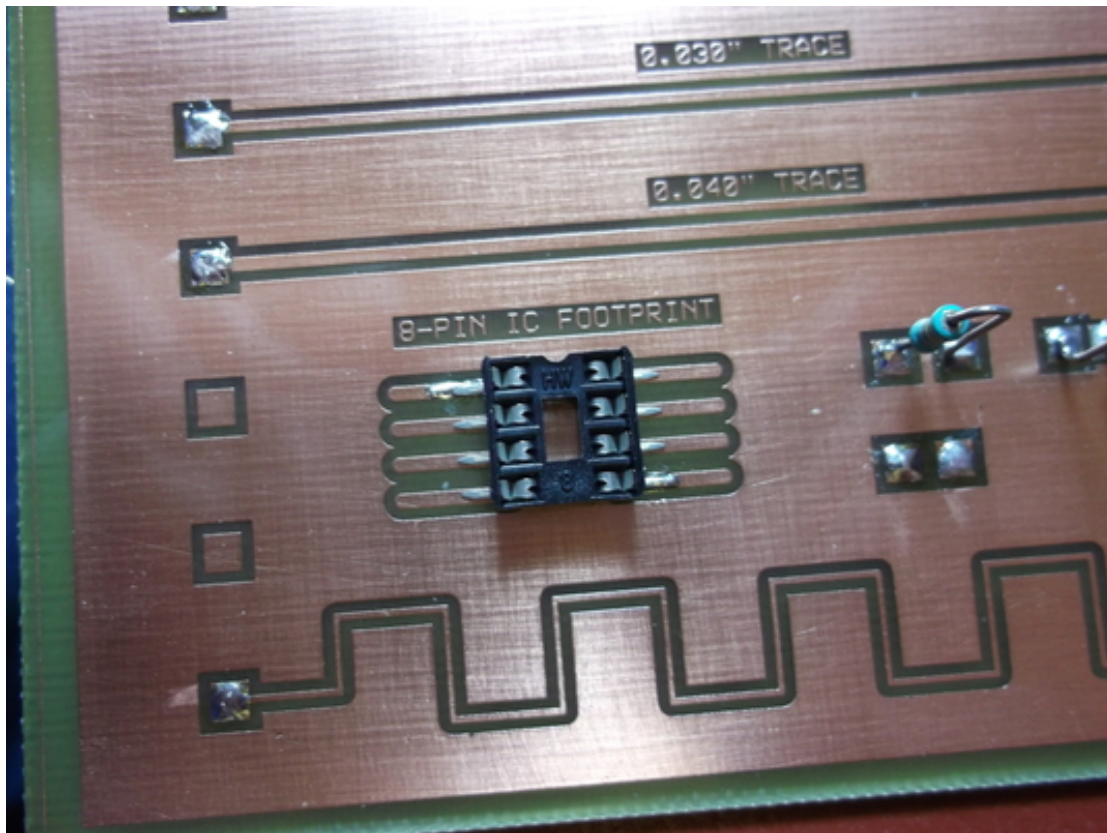

Figure 53: Socket with two pins soldered into place.

Now, go ahead and solder the remaining pins and double check and touch up any connections that don't look just right. Use the solder in small amounts here. After assembly there should never be any extreme forces ever applied after the IC is inserted. This device is not going to the Moon or to Mars. I don't think.

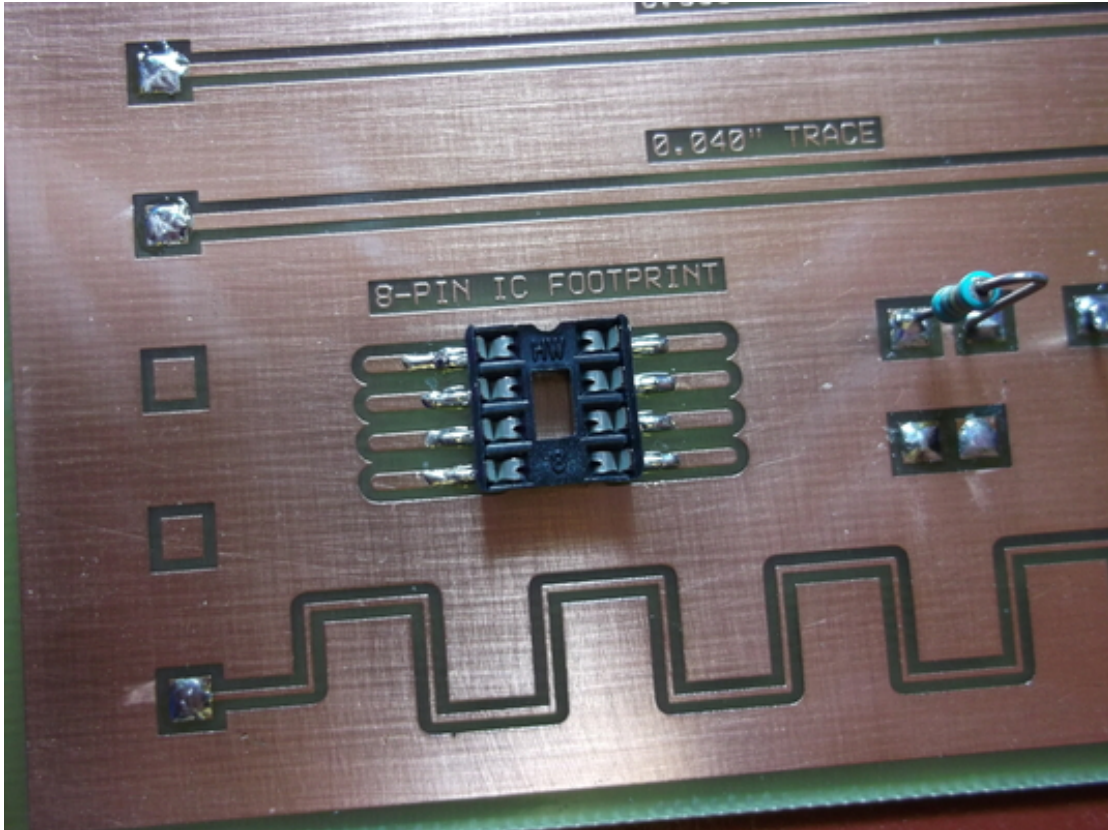

Figure 54: Socket with all pins soldered into place.

That's all there is to do to do a nice job. BTW, I bought 500 of the 8-pin sockets from a China source online for five American bucks, including free shipping, so there are very very cheap. Work well and will allow me to replace parts easily.

I'm thinking that later, I will build a test fixture for some ICs that use these sockets and allow me to exchange parts easily and quickly. Time will tell.

Chapter 6

The Quartz Crystal Unit

In the fall semester of college in 1963, I was a sophomore physics major at McMurry College in Abilene TX. Dr Virgil E. Bottom was the instructor of an electronics course in which I was one of 9 students. We had small classes then. We had no textbook for the course. We all wrote our own and I know that mine was over 600 handwritten pages. You have to remember this was before computers, operating systems and word processing. The PC wouldn't be around for another 20 years. The book we each wrote was the course assignment from Dr Bottom. At the end of the semester we all turned in a stack of notebooks that was more than a foot tall. I thought that there was no way he was going to be able to grade all that work. I was wrong.

I got back my notebooks. In them were some complete diagrams of lots of tube circuits including complete AM receivers and AM transmitters. Dr Bottom had found a couple of places in the schematics where I had forgotten some bypass capacitors! I was impressed.

The following material is what I remember from the class lectures on crystals. Dr Bottom was a world renowned expert in the field and wrote the classic text in 1982.

Today the world uses billions of quartz crystal units yearly. They are everywhere. In your wrist watch, cell phones and in every computer system on the planet. The quartz crystal provides a cheap and easy way to accurately keep track of time and frequency, since one is the inverse of the other.

The quartz crystal unit consists of a unit that has two leads or two connections in the case of modern day SMT devices. Internally the unit consists of a quartz element with plated contacts and acts like a series R-L-C circuit electronically. Here is the circuit diagram.

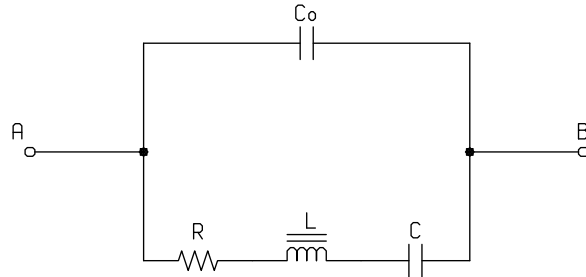

Figure 55: Equivalent circuit of the piezoelectric resonator.

The parameters R , L and C are technically referred to in professional literature as R_m , L_m and C_m to call attention to the fact that they are associated with the mechanical motion of the plate (the quartz crystal itself) during oscillations. The reference to the plate configuration has to do with the starting configuration in the FT-243 crystal unit during World II was a rectangular plate of the quartz crystal unit inside. Modern HC-49U units have a circular quartz plate that is plated with aluminum on two sides. The parallel capacitance C_0 is the representation of the capacitance across the plate due to the plating and the leads to the outside world. In the circuit in which the crystal unit operates there is some additional parallel capacitance that needs to be accounted for.

The admittance Y_{AB} between the terminals A and B is given by

$$Y_{AB} = 1/Z_{AB} = \frac{1}{Z_{AB}} = \frac{1}{R + j(\omega L - 1/\omega C)} + j\omega C_0 \quad (6.1)$$

and by combining the two terms we get

$$Y_{AB} = \frac{1 + j\omega RC_0 - \omega^2 LC_0 + C_0/C}{R + j(\omega L - 1/\omega C)} \quad (6.2)$$

and thus

$$Z_{AB} = \frac{R + j(\omega L - 1/\omega C)}{1 + j\omega RC_0 - \omega^2 LC_0 + C_0/C} \quad (6.3)$$

The reason for starting with the equation work for the admittance is to allow easy removal of the complex component from the denominator as shown in the next step. Multiplying both the numerator and the denominator by the complex conjugate of the denominator gives us

$$Z_{AB} = \frac{R + j(\omega L - 1/\omega C - \omega^3 L^2 C_0 + 2\omega L C_0/C - C_0/\omega C^2 - \omega R^2 C_0)}{C_0^2/C^2 + 1 - 2\omega^2 L C_0 + 2C_0/C + \omega^2 R^2 C_0^2 - 2\omega L C_0^2/C + \omega^4 L^2 C_0^2} \quad (6.4)$$

For resonance, the complex component of the above equation is zero. That is the term following the j , the engineers way of representing the complex number $\sqrt{-1}$. This is an attempt to prevent confusion with the current, i . Thus,

$$\omega L - 1/\omega C - \omega^3 L^2 C_0 + 2\omega L C_0/C - C_0/\omega C^2 - \omega R^2 C_0 = 0 \quad (6.5)$$

Now, multiply both sides by $\omega^2 C$ to get rid of the fractions:

$$\omega^2 L C - C - \omega^4 L^2 C^2 C_0 + 2\omega^2 L C C_0/C - C_0 - \omega^2 R^2 C^2 C_0 = 0 \quad (6.6)$$

It is not obvious, but the last term is much smaller than the other terms together, so we can eliminate the term with R in it and come up with:

$$\omega^2 L^2 C^2 C_0 + \omega^2 (L C^2 + 2L C C_0) + (C + C_0) = 0 \quad (6.7)$$

We can solve this equation by means of the quadratic formula. What is interesting to me is that for a couple of bucks US currency you can get Wolfram Alpha for your iPad and have the computer solve this in no time at all. And, after checking the formula you enter, you can be sure that the answers are good. If I did this by hand, I would perform the calculations several times to make sure that I had no error(s).

The two results are:

$$f_s = \frac{1}{2\pi} \sqrt{\frac{1}{LC}} \quad (6.8)$$

You will recognize the first formula as that for an resonant LC circuit and the frequency (f_S) is the series resonant frequency of the crystal. The second root of the equation gives us:

$$f_A = \frac{1}{2\pi} \sqrt{\frac{1}{LC} + \frac{1}{LC_0}} \quad (6.9)$$

and this is what is called the parallel or antiresonant frequency. You can see from the two formulii that f_A is always greater than f_S .

Since a crystal can not work without being connected to an external circuit, the C_0 has additional capacitance in parallel with it, say C_x , then the parallel resonant frequency becomes

$$f_A = \frac{1}{2\pi} \sqrt{\frac{1}{LC} + \frac{1}{LC_t}} \quad (6.10)$$

where $C_t = C_0 + C_x$.

6.0.1 Impedance at Resonant Frequencies

At series resonant frequency f_S , $\omega_S^2 = 1/LC$ and plugging into the formula for Z_{AB} will get us

$$Z_{AB} = Z_S = \frac{R}{1 - (\omega RC_0)^2} \approx R \quad (6.11)$$

We can get away with the approximation, since we experimentors are typically using HC-49U units which are AT crystal cut blanks. At 4MHz and higher, R is on the order of 10 ohms or higher and the ω term is on the order of 10^5 or 10^6 , but C_0 is on the order of 10^{-12} .. I will come back at some later time and do the calculation both ways with measurements made from a range of crystals at different frequencies. The approximations should be good for less than a one percent error.

For the impedance at the parallel or antiresonant frequency:

$$\omega_A^2 = 1/LC + 1/LC_t \quad (6.12)$$

and

$$Z_{AB} = \frac{1}{\omega^2 C_t^2 R} \quad (6.13)$$

with the last result obtained by substituting the ω^2 value into the impedance formula.

The impedance at the parallel or antiresonant frequency is also pure resistance and much higher than the series resonant frequency and is of the order 10^5 to $10^6 \Omega$.

In order to obtain C_m and L_m , all we need to do is measure the two frequencies for series and anti-parallel resonance and the capacitance C_0 and plug the numbers into the two equations and solve for $L - m$ and C_m . We need a stable and accurate signal generator, a frequency counter capable of measuring down to the frequencies generated in oscillators accurately and a RF voltmeter or RF probe.

6.0.2 Crystal Parameters by Measurement

If we take the two formulii for ω_S^2 and ω_A^2 and subtract, we get

$$\omega_A^2 - \omega_S^2 = (\omega_A - \omega_S)(\omega_A + \omega_S) = \frac{1}{LC_t} \quad (6.14)$$

Because ω_A and ω_S are close by less than 1%, the formula may be reduced to

$$2\omega\Delta\omega = \frac{1}{LC_t} \quad (6.15)$$

and

$$L_m = (8\pi^2 f C_t \Delta f)^{-1} \quad (6.16)$$

where $f = f_S$ and $\Delta f = f_A - f_S$.

We can get Q and C_m for $Q = \omega L/R$ and C_m from the resonant frequency formula using f and L_m .

C_0 is measured using a simple LC meter with the crystal alone. Measuring R_s , the effective series resistance requires a fixture and a signal source and RF meter.

Assuming that we have a 50 ohm impedance for our signal generator, the typical industry standard for commercial products, we can build a fixture like that in the following schematic.

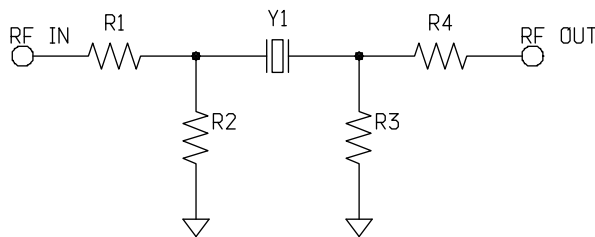

Figure 56: Simple Fixture for Crystal Parameter Measurements.

Now, please bear with me. This is an experiment to outline in detail why certain aspects of fixtures are important in the lab. You do not want to measure something that will wind up in error or just plain useless.

You will note in the crystal parameter fixture that the I have not placed values for the resistors. I want to show you how to home in on the values that will work. Of course, you can search the web and find values that others have used and then you will blindly follow where there is the possibility that you should not go.

The purpose of R_1 and R_2 is two fold. To create an input impedance that the RF source will like and to isolate the crystal and present it with a load. We want the load or impedance the crystal sees to be low. In

fact, as low as we can go without getting output RF that is too low for our detector and measuring system.

I have a Wavetek 3010 RF generator that has an output impedance of 50 ohms. So, for starters, let's use $R1=0.0$ ohms and $R2=50.0$ ohms. Closest we can get with standard resistor values is 51 ohms. I measure one from the parts bin at 50.8 ohms, so let's try it. I'll set $R1=R4=0$ ohms and $R2=R3=51$ ohms. Here is the plotted data for a 4.096MHz crystal.

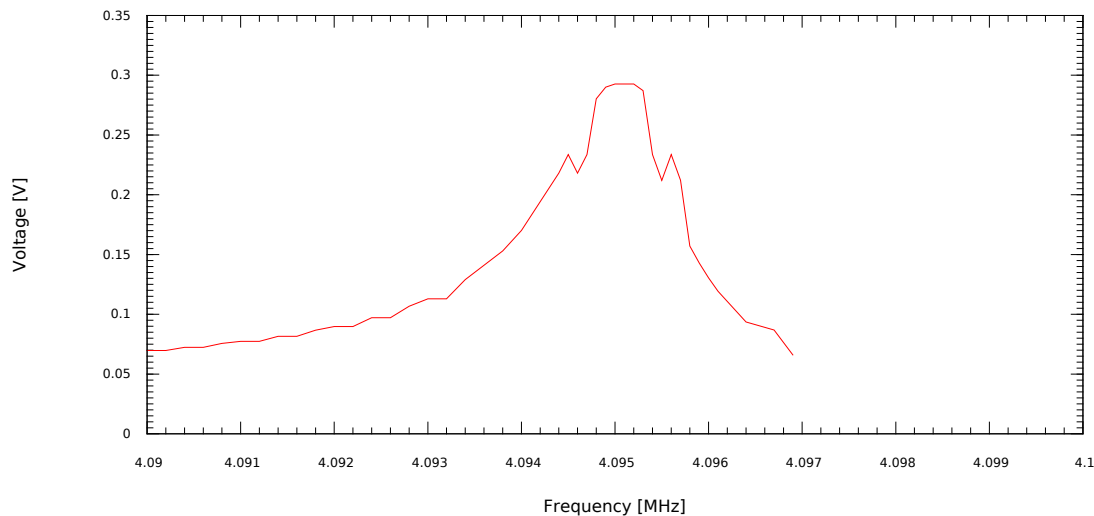

Figure 57: Frequency sweep of a 4.096MHz crystal.

You can see that the curve is not very pretty. You see the peak voltage around 4.095MHz, below the marked freq on the crystal of 4.096MHz. This is because we are measuring the series resonant frequency. Also note the broad peak. Well, this is caused by the two 51 ohm resistors presenting a fairly high load on the crystal, thus reducing the quality factor, Q-factor or just plain Q of the crystal.

So, let's now make $R1=R2=47$ ohms and $R3=R4=10$ ohms. The network, neglecting $R4$, makes the input port to ground approximate 50 ohms for a crystal series resistance in the neighborhood of 20 ohms or

so. This is a ball park estimate.

OK, I'm going to switch RF signal generators, because the Wavetek can only do 100 Hz steps. Let's use the FCC-2 signal generator that NorCal QRP club had many years ago. Now here is the plot and in some intervals the data is taken in steps of 20Hz. What this means, in order for you to do this, is that you have to either find an analog generator and use a digital frequency counter to take the data or use a digital signal generator capable of 10Hz or smaller steps in frequency.

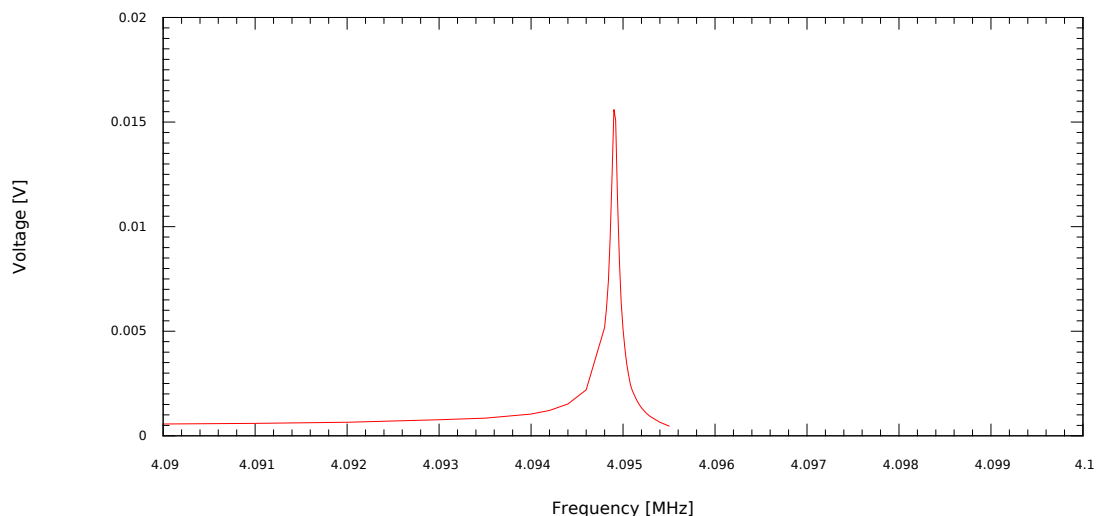

Figure 58: Frequency sweep of a 4.096MHz crystal.

Wow. Makes quite a big difference, doesn't it? OK. You ready for the bad news? Look at the voltage levels. The attenuation caused by stepping the input voltage down by a factor of 5 for more just before application to the crystal and then the attenuation added by the output side.

I could no longer take the data using the NorTex accuprobe. I had to resort to an HP3400A RF voltmeter. I will, later, come up with a fixture with added RF amplification at the output to allow the use of the accuprobe. A rabbit hole of this project, where a rabbit hole is used to refer to additional experimentation, work and building to get to the

final results desired.

Now I can find the series resonant frequency more precisely. How far you want to go with this is up to you. I can find the frequency within 1 Hz. That gives me 1:1,000,000 precision. BUT, we are going to be able to measure some capacitors needed in the second part by only 1:1,000, so you only need to get with a 10Hz or so to be good to go for calculating the motional inductance and motional capacitance of the crystal.

Another piece of bad news. I do want to measure the anti-resonant frequency, a.k.a. parallel resonant frequency. The impedance at that frequency will be so high, on the order of 10^5 or 10^6 ohms, we will have a signal at the output of our fixture that is 100 to 110 dB down from the peak. Very very difficult to measure without some expensive equipment. But never fear, Chuck is here to save the day. I will come up with an amplifier that will give us levels we can measure.

6.1 Crystal in Series with a Capacitor

Let's look at what happens when you put a cap in series with the crystal. The schematic for the circuit to be analyzed looks like the following.

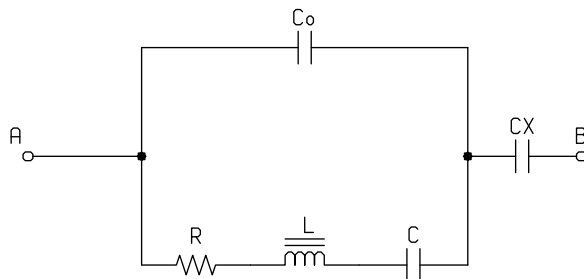

Figure 59: Circuit of with crystal in series with C_X .

Now the impedance between terminals A and B of the circuit becomes

$$Z_{AB} = \frac{R + j(\omega L - 1/\omega C)}{1 - \omega^2 LC_0 + C_0/C + j\omega RC_0} + \frac{1}{j\omega C_X} \quad (6.17)$$

OK, you are going to have to trust me on this. The breakdown of the above equation to find the two roots where the impedance has no complex component gets very nasty. If you want it, I can add it, but complex term has 14 components. So, let me just give you the major result. OK?

$$\omega_1 = \sqrt{(1/LC + 1/LC_t)} \quad (6.18)$$

$$\omega_1 = \sqrt{(1/LC + 1/LC_0)} \quad (6.19)$$

where $C_t = C_0 + C_X$.

We have shifted what was the series resonant point, now ω_1 , up in frequency, but the anti-resonant point remains the same. This is why Iacopo Giangrandi, HB9DUL, on his web page

<http://www.giangrandi.ch/electronics/crystalfilters/xtaltest.html>

has a fixture that measures the series resonant point (no cap in series) and then two other points with two different caps. Please, pretty please note that as I calculated above the anti-resonant point, which he calls f_p does not shift. Neato. Now you know how he came up with the fixture. Let me tell you a secret. In his L_m and C_m calculator we only need the three frequencies of resonance that we can easily measure. The parallel resonant point is only used to solve for C_0 !! We can use his calculator and enter the first three resonant frequencies and then make up the fourth. You can see that L_m and C_m are independent of the anti-resonant frequency. Try it. We are going to measure C_0 using a capacitance meter.

And we measure R_s in the following manner. Find the series resonant peak with the fixture. Note the voltage amplitude. Now, remove the crystal and put a variable resistor (potentiometer) in its place and adjust the resistor to get the exact same value. Remove the resistor and measure its value. That is the series resistance (R_s) of the crystal.

OK, here is a photo of my test fixture. I made a muppet board for it. I also did an extra trick. I do not want to, for measuring the series resistance, plug in and out a variable resistor. I built one into my own K7QO CTF, and using Berg connectors came up with a switching scheme not having to use expensive switches. Just use 0.10" headers and the Berg connector. Don't worry about the layout. If you feel that stray capacitance will effect your results, then by all means experiment with it. I found the exact same resonant frequency to the exact frequency down to 1Hz with different fixtures and related schemes.

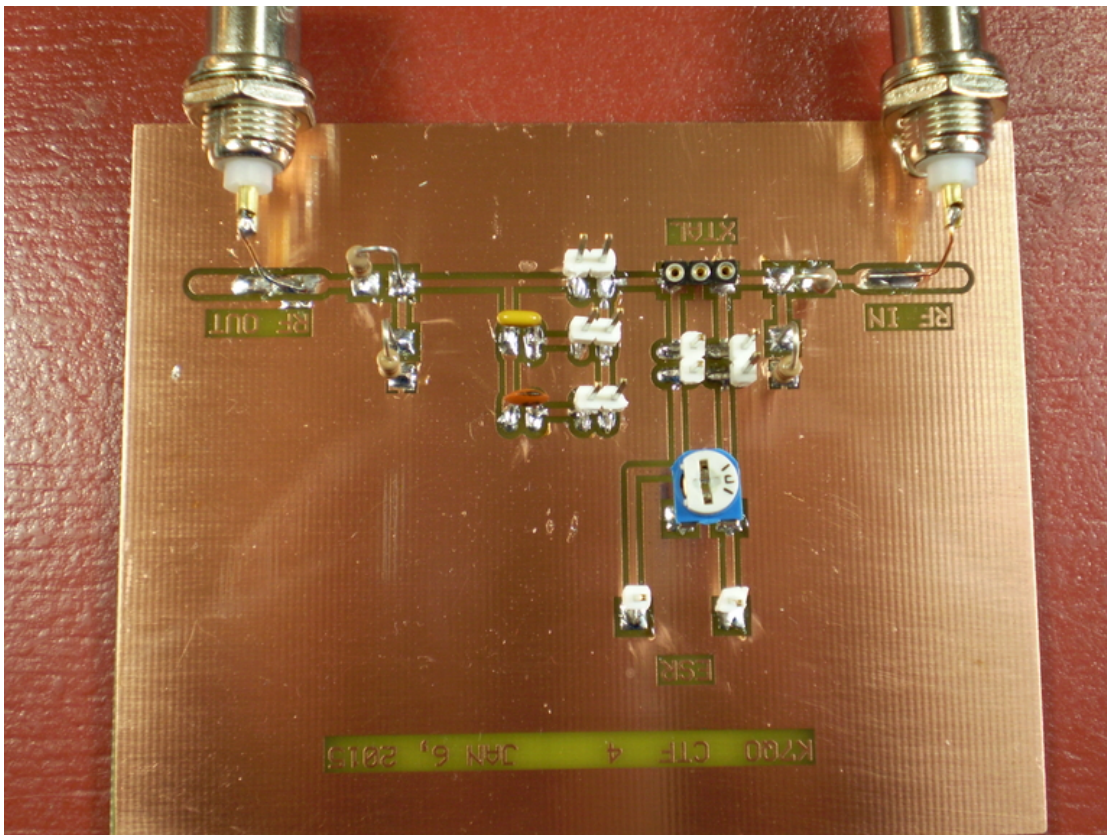

Figure 60: K7QO fixture for the HB9DUL scheme.

As it turns out, the stray capacitances outside the points A and B in the schematics do not effect the results! That is what is so slick about this scheme. AND, because we are not measuring Q direct we can get sloppy on the impedance matching and use larger resistances. Go the HB9DULs values. I did.

Let me now go and measure the crystal again, this time using the new fixture and using handy available caps with values of 34.14pF and 9.73pF. Here is what I get for the L_m , C_m , R_S and Q of the crystal. The Q value is calculated from $Q = \omega L_m / R_S$ at the resonant frequency. Also note, since I have the cap values to only 4 and 3 significant digits, the results are good only to 3 places!! All that work and we are limited by simple measurements for capacitance.

On the web page following the crystal calculator is a calculator to find the cap values to build an IF filter using the crystal parameters. That is why the work to measure these things.

The difficulty with this fixture and most others is in measuring the anti-resonant or parallel resonant frequency of the crystal with typical RF voltmeters. What I plan on doing is using a general coverage receiver. Get as close as you think you can to the parallel resonant frequency and connect a general coverage receiver with a good S-meter and tune for minimum signal level and that will be the parallel resonant frequency of the crystal unit.

6.2 Final Summary

We did this chapter on crystals to emphasise that they are neat components and we are going to use them in a number of places.

First. When we added capacitance to the crystal, either in series or parallel, we RAISED the frequency. This is important. Look at some of the transceiver designs that use a crystal as part of the mixer. Usually the crystal is used with a NE602 or NE612. If there is a cap in series with the crystal, it is there to raise the frequency. The amount that it is raised is inversely proportional to the value of the cap. The larger the cap value the smaller the frequency shift from the series resonant frequency. Now you know that if you want to shift the beat frequency up from where it is now, you reduce the series cap. If you want to lower the difference, then you increase the value.

I did the analysis in the chapter for the cap. An inductor does just the opposite. I leave to you, as the student, to go back and do the math for an inductor.

We will look at the G3UUR crystal fixture. Dave used the property of the frequency shift due to a series capacitor for his work. It is all connected.

The online calculator of HB9DUL solves the simultaneous equations obtained to find the variables. You could use something like Wolfram Alpha software to do the same thing. I have Wolfram Alpha on my iPad and for the two bucks, it has to be the best deal around. All your math textbooks are contained in the one program. Kids have it so easy today. :-)

Thanks.

Chapter 7

G3UUR Crystal Parameter Fixture

We will, in this chapter, look at the Dr Dave Gordon-Smith, G3UUR, circuit to obtain two of the parameters of the crystal unit. The circuit has been published in a number of places, including the Fall 2010 issue of the QRP ARCI Quarterly (QQ).

I am going to modify the circuit a bit to simplify it. His circuit included a variable resistor in series with the crystal and capacitor in a Colpitts crystal oscillator circuit. I want to remove the variable resistor so as to simplify how we get R_m .

Here is my modified circuit.

G3UUR CRYSTAL PARAMETER FIXTURE

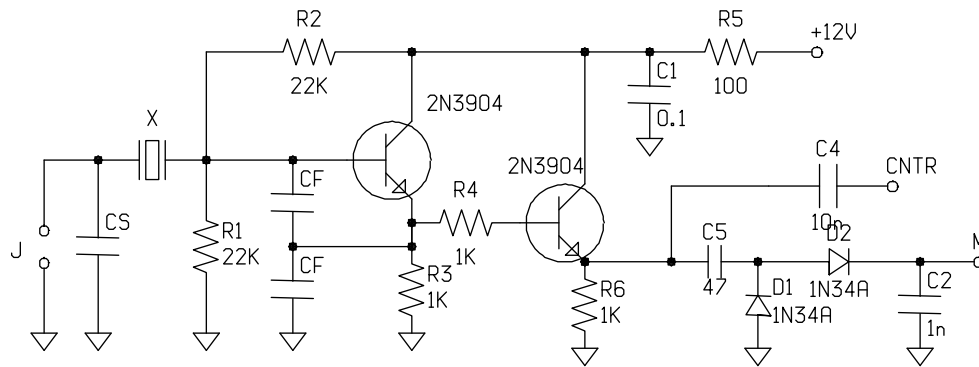

Figure 61: G3UUR Crystal Parameter Circuit. See text for values.

Several important things. When building the circuit. Before installing components on a PCB or other structure. Very very carefully measure the stray capacitance across the jumper terminals and across the crystal holder to the best accuracy and precision you can achieve. Measure several times before putting in C_S . Also measure C_S before installing. I used a value of 33pF for C_S . I used 470pF for C_F . I would measure all these capacitors as exact as possible for use in the calculations after the measurements on a crystal. Try to match both C_F caps as closely as possible. This will help in your measurement results.

Also, I found that the power supply voltage should be 12V (12V-13.8V) for good results. If you want to go with 9V supply, then remove the 100 ohm resistor and put in a 0 ohm resistor or just a plain wire.

Now you are ready to do some measurements. You are going to need a frequency counter with a resolution of 1Hz and have it calibrated with WWV on 10MHz. There are tons of ways to do this and you can search the Web to find out, if you don't know already.

For the meter output terminal, M, I use a Velleman DMM that has an input impedance of 10M, M for Megohms. Any DMM with an impedance of 1M or better will do nicely.

Hook up the meter to the M terminal and the frequency counter to the CNTR terminal.

Find a crystal that you want to measure. Using an L/C meter, measure the capacitance across the two leads of the crystal with it out of the circuit. This is C_0 . Mark this down as one of your measurements.

Put the crystal into the crystal holder of your G3UUR fixture close the jumper J. You can use a switch, but you have to be sure you measure it's capacitance in the circuit before building the rest of it. Power up the device and measure the frequency with the closed jumper/switch. This is f_S . Also measure the output voltage at M and write it down with the frequency. Open the jumper J and again measure both the frequency and the voltage. I'll explain the reason for measuring the output voltage later. It is used to give us a comparison of 'crystal activity' or another measure of how good the crystal will be for a filter.

7.1 ESR Measurement

Because the G3UUR circuit will not give you the R_m measurement as I have it set up, I have added to the PCB a section for measuring R_m or ESR.

You need a RF source and a sensitive RF voltmeter. I have a diode detector, but you need a sensitive analog voltmeter to effectively use it. Sensitivity down to 100mV or lower. You will have to experiment.

You put a crystal into the socket and feed RF into the input terminals. Adjust frequency until you get a peak in output at either the RF Voltmeter terminal or the M terminal for a DC voltmeter. Carefully read the output value and make a note of it.

Now, remove the crystal and close the two jumper terminals, J. Adjust VR until you get the exact same reading as with the crystal in the fixture. Now remove the RF source and the meter(s) and remove the two jumpers. At the two test points, TP, on the PCB measure the current value of the variable resistor. This is R_m or the ESR of the crystal.

G3UUR, in his original circuit required you to put two crystals in parallel and adjust the variable resistor in series with the crystal to get the same output value from the oscillator. This will only give you an average value between the two crystals. My technique shown here will get you the R_m for each individual crystal being measured.

So now you have a way to get all four of the motional parameters for an individual crystal.

I wrote a python program to do the calculations for me. Here it is for your amusement.

```

# crystal measurements
c_0 = 2.93e-12
# frequency with J open in Hz (don't do MHz or kHz)
f_o = 4095506.0
# frequency with J shorted in Hz (don't do MHz or kHz)
f_s = 4094946.0
# r_s from K7Q0 ESR fixture measurement
r_s = 24.6

# set the following values one time for your fixture
# measured values for the G3UUR fixture
# c_stray is the measured capacitance across C_s before installation
# x_stray is the measured capacitance across the crystal socket
c_stray = 1.70e-12
x_stray = 1.35e-12
c_s = 34.01e-12
c_f = 454.0e-12

# measured C_s plus the stray capacitance in parallel with it
c_s = c_s + c_stray
c_0 = c_0 + x_stray

# calculation of value from G3UUR calculation formula
c_r = 4.0*c_s*c_0/c_f

c_m = 2.0*(f_o-f_s)*(c_s+c_0+c_r)/f_s

print "C_m = ",c_m/1.0e-15," fF "

l_m = 1.0/(4*3.14159*3.14159*f_s*f_s*c_m)
l_m = l_m*1000.0

print "L_m = ",l_m," mH "
print "R_m = ",r_s
print "C_0 = ",(c_0 - c_stray)/1.0e-12," pF "

q = 2*3.141592*f_s*l_m/(1000.0*r_s)
print "Q = ",q

```

And to top of this chapter to aid you in seeing the board layout with parts on it, here is a photograph. This was the prototype and I made a couple of mods to the final layout, which I will include on the next page. The layout is not printed to size, so please do not use it for making a board. Use the PCB file at qrp-tech in the files section for making the board.

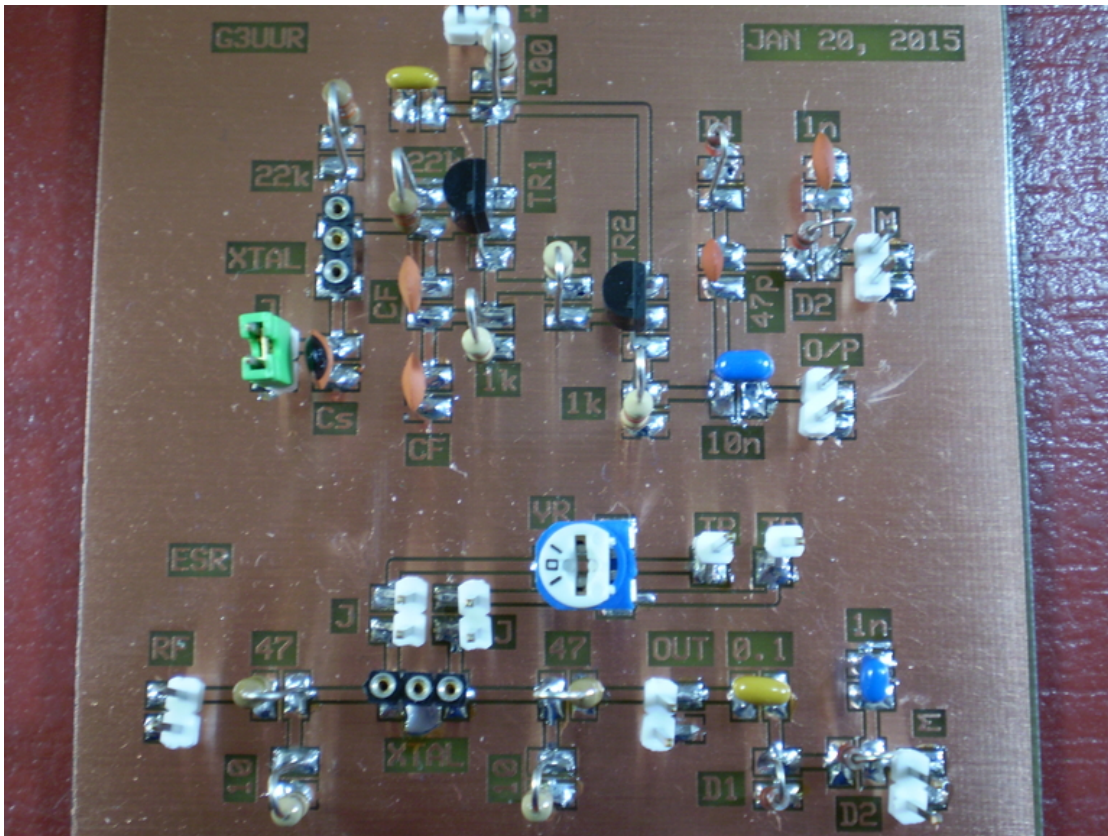

Figure 62: G3UUR PCB with K7QO ESR fixture.

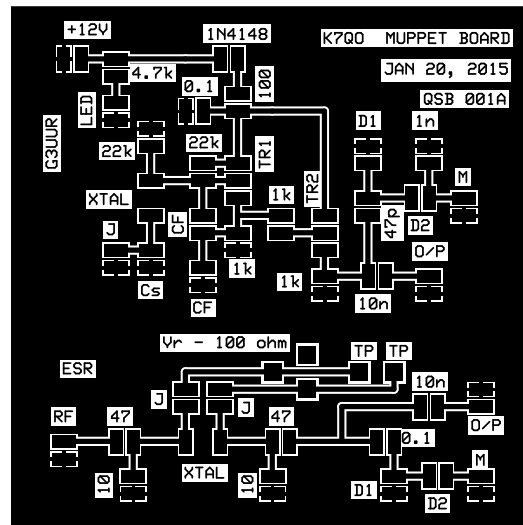

Figure 63: G3UUR Crystal Parameter PCB and K7QO ESR fixture.

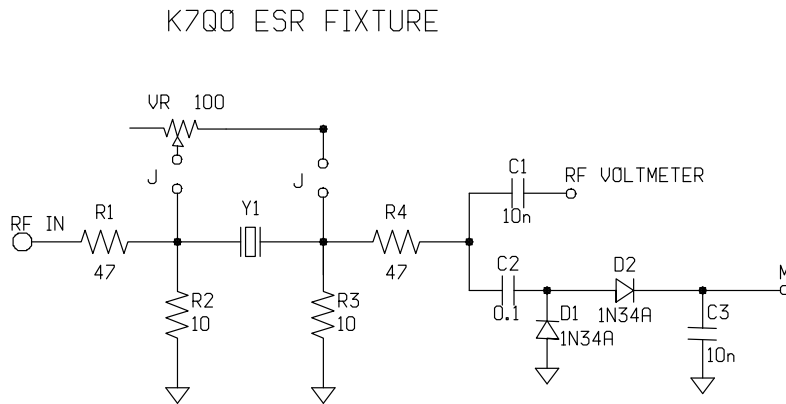

Figure 64: K7Q0 ESR schematic.

Above the the schematic for the ESR fixture. Very simple to build and simple to use.

You need a RF generator that is rock solid, preferably a DDS based system. Output level of between 0.5 to 1.0 volts. The output will be on the order of 20mV or so.

Place crystal in holder with jumpers open. Adjust frequency input to generate a maximum or peak output voltage and write down the voltage.

Now remove the crystal, put the two jumpers in place and now adjust the variable resistor to get the exact same voltage output.

Remove the two jumpers and now take an ohmmeter and measure the resistance across the two test pads (not shown on schematic yet). That will be the motional resistance of the crystal at resonance (R_m).

Simple to do, but valuable information.

7.2 SPICE Simulation

And, as a check of all my theoretical work and experimentation, after the fact, I sat down and did a small simulation using ngspice. I created a circuit that is exactly like my crystal test fixture.

I set up an input RF voltage of 1.00V and swept a crystal from 4.190MHz to 4.210MHz. Then plotted the voltage output in dB, because a linear plot of just the voltage out will just show a sharp peak at the resonant frequency.

Here are the results of three runs simulating the short, 34.14pF and 9.73pF in series with the crystal. The curves are, from left to right, the short, the 34.14pF cap and then the 9.73pF cap.

You see the series resonant frequency shift upwards and the value of the series cap decreases. This is what I showed in the derivation for the resonant frequency.

Another serious note. The amplitude of the output at the series point decreases. I did verify this in making my measurements. This means that in a real live circuit, such as in a mixer, when you put a series cap with the crystal, the output of the oscillator will drop. I can show this with a real circuit and I plan on running a series of tests on the VXO to illustrate just how serious this drop off can be.

And, the important thing to note is that the null, corresponding to the parallel resonant mode remains the same, but varies in magnitude.

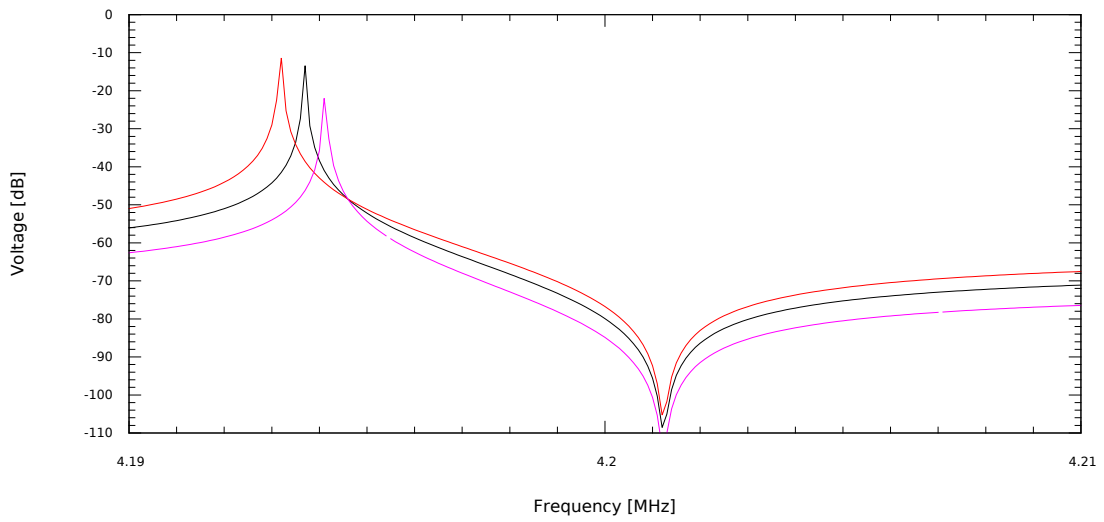

Figure 65: SPICE simulation of sweeping a crystal .

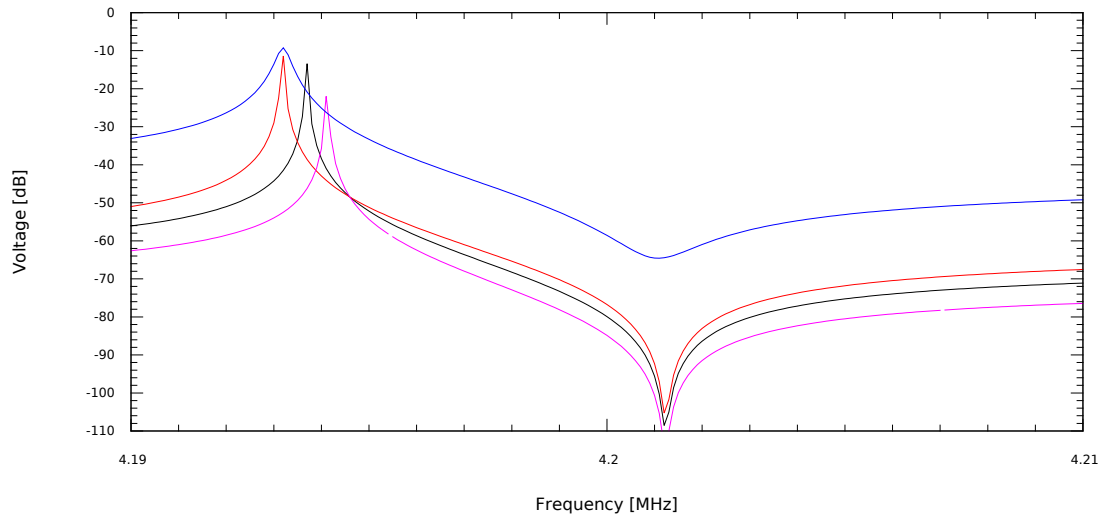

Figure 66: SPICE simulation.

In the above I added the high values for the padding resistors to show how that HB9DUL's values (in blue) are indeed too high and make the measurements more difficult to make. The peak is much harder to determine down to the 1Hz frequency resolution.

Chapter 8

Simple Crystal Oscillators.

In Jan 2015, I have added a second layout for the Colpitts Crystal Oscillator. It is slightly different from the first one in that I reduced the pad sizes for the components and added a dual diode voltage doubler on the output to allow output measurements with a simple DMM.

I also added a two transistor Pierce Crystal Oscillator to allow you to examine the geometry of another oscillator that operates the crystal nearer to its series resonant frequency. My intent is to test both oscillators with a series of crystals. By measuring the crystal characteristics using both, we want to examine how they may be used to select crystals for IF crystal filters later in the document.

8.1 A Simple Colpitts Crystal Oscillator

Here is a simple experiment to make a MUPPET board of some practical value. Let's make a crystal oscillator that can be used as a test fixture for checking crystals or even matching them. Because this document is for beginning experimenters, I will do this one project step by step. For those of you who know everything, feel free to skip this chapter. :-)

The parts needed:

D1	1N4148 Si diode
Q1	2N3904 NPN transistor
R1	33K 1/4W resistor
R2	33K 1/4W resistor
R3	5.1K 1/4W resistor
C1	150pF disc capacitor
C2	220pF disc capacitor
C3	0.01uF disc or mono capacitor
X1	crystal(s) to be tested
4.7K	resistor for power on indicator
LED	LED for power on indicator

This oscillator will work for crystals resonant between 3 to 20 MHz. To use lower frequencies requires a slight increase the values of C1, C2 and R3. You may have to experiment. I will let you know what I have to do to get to the lower range. And, if you want to use a crystal higher than 10MHz, then you lower the three component values. But this is mainly an exercise to get you started to become familiar with the technique.

The crystal oscillator in this section I did in 2013. Since then, I have made some changes in my style of layout, so include a second version in the next section. I think the second layout would be a better choice. It has a DC output for use with a simple DMM for those that do not have an experiment lab with a lot of equipment yet.

The second Colpitts layout is called k7qo-0001. This is for a new numbering scheme to simplify the large number of boards that I have done and am attempting to reorganize for distribution outside my lab.

This exercise has some value and you won't invest much time and money in doing this. In fact, as an incentive you do not have to do the board layout. I will give you the .pcb file so that if you want to load it and run through the printout steps on your system AND I will give you the PDF file with the image reversed (flipped). They are with this PDF document on my web site adjacent to the URL for this file and URLs to the PCB and PDF files and they are called [k7qo-muppet-001.pcb](#) and [k7qo-muppet-001-flipped.pdf](#). How is that for service?

Here is the schematic of the crystal oscillator. Sorry, but I added a 4.7K and LED at the input for power on indication, so it is missing from the schematic. Feel free to draw freehand and add for your own use one

time.

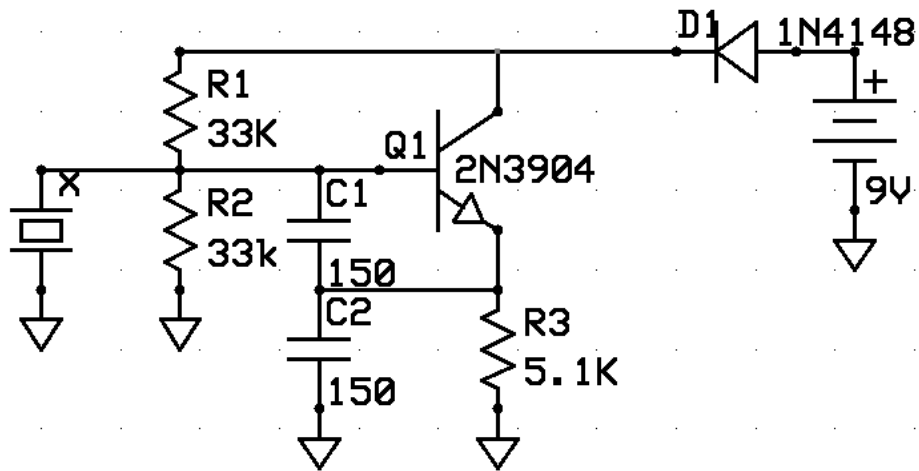

K7Q0 MUPPET 001 --- CRYSTAL OSCILLATOR

Figure 67: K7Q0 muppet 001 schematic.

Here is the ExpressPCB layout of the board showing the top layer of the PCB.

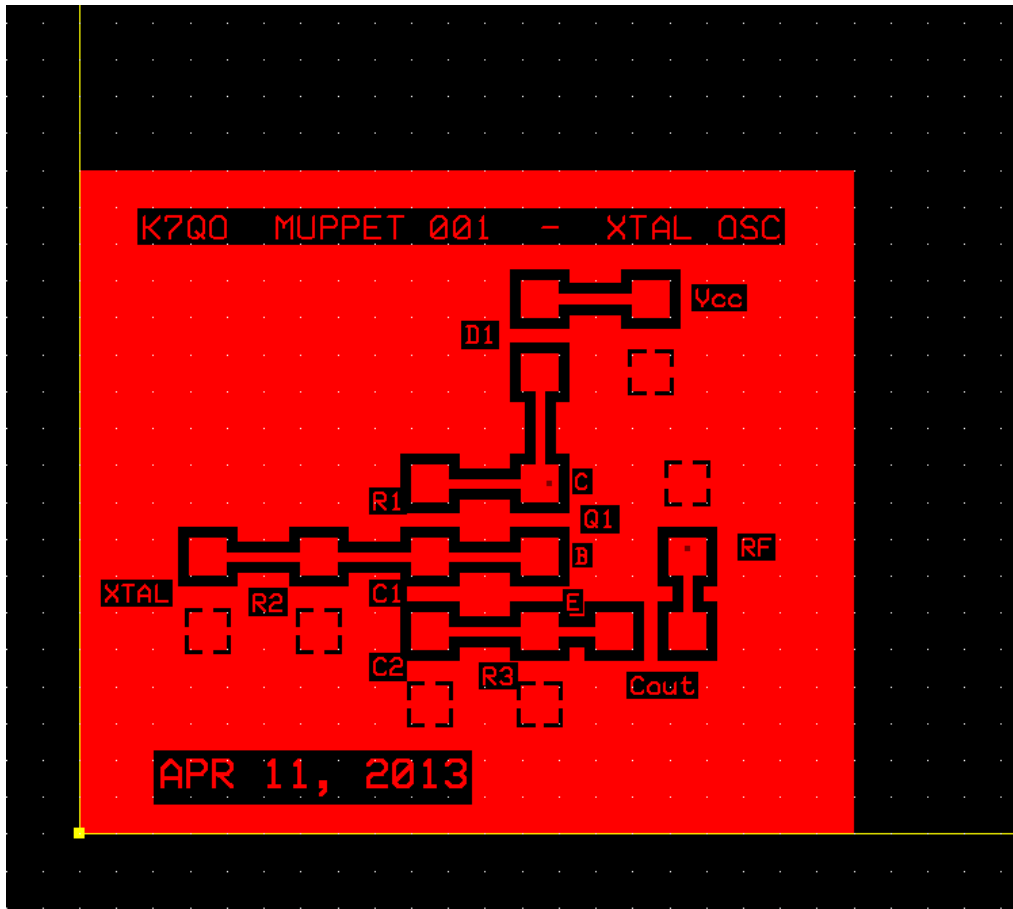

Figure 68: K7QO muppet 001 PCB layout.

You will note that I have placed text near the component pads. I find this helps me to reduce errors in parts installation and documents the layout for others like you. I sincerely hope that it helps. I will try LibreOffice Draw or Inkscape to do the layout like Paul Harden, NA5N, would do by his wonderful artwork.

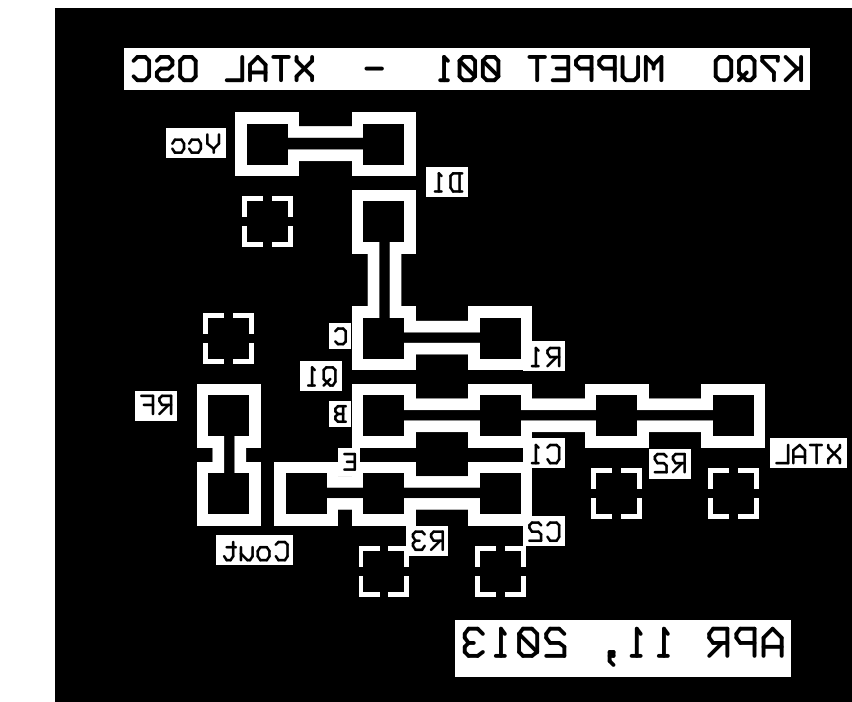

Figure 69: K7QO muppet 001 PCB layout flipped. Not to scale.

And here is the same image flipped to be printed out for the toner transfer technique.

Here is a photo of the printer output to be transferred to the PCB and the blank board before I run them through the laminator. The plastic clip is for handling the PCB material in and out of the laminator. The board will heat up to almost the boiling point of water, so be careful. A wooden clothes pin will work just as well.

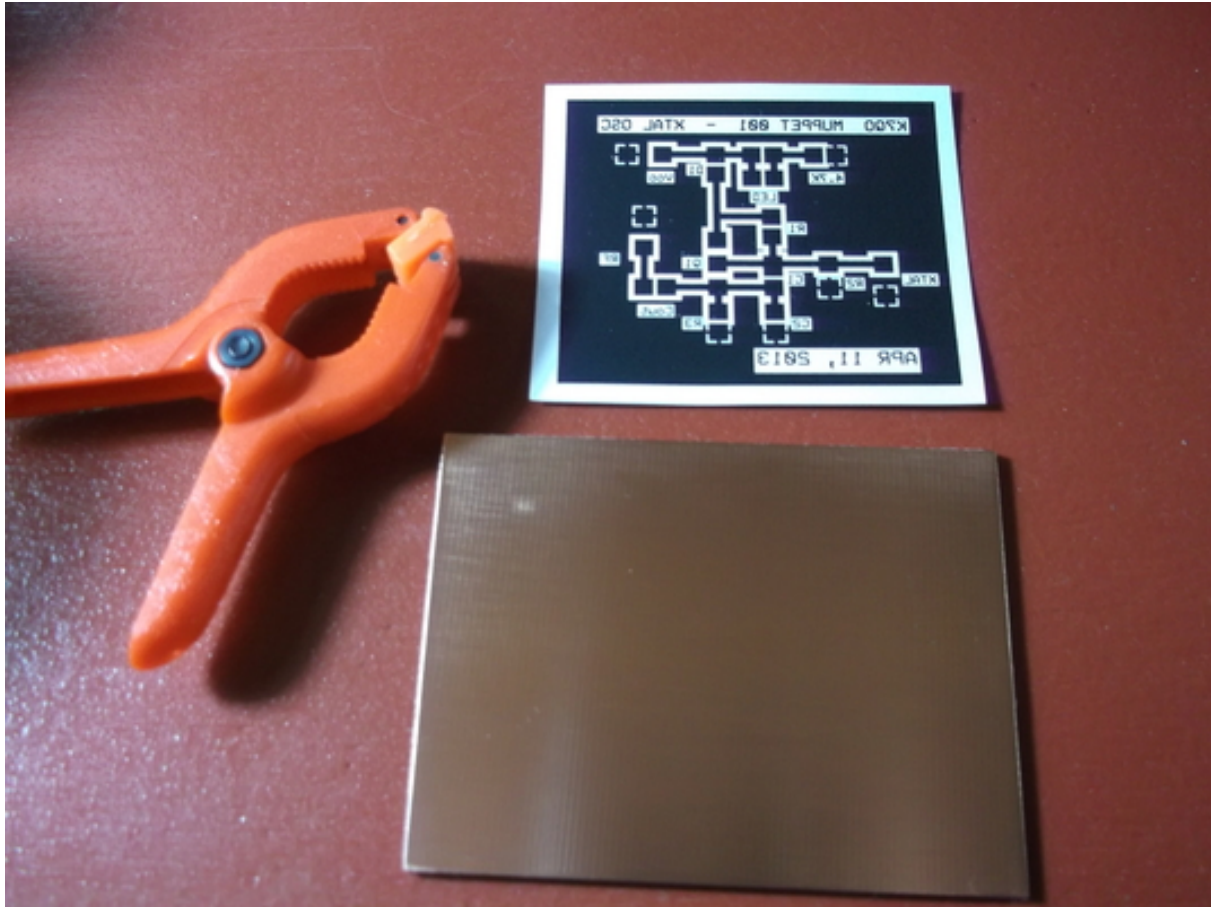

Figure 70: K7QO muppet board for crystal oscillator.

You will note that the printout is reversed. ExpressPCB will not allow you to print out the top layer of the board reversed. This is most likely due to their desire to not have so many hobbyists do double sided boards easily.

I use the linux operating system and run ExpressPCB under a Windows emulator, wine, and when I go to print I send the output to a PDF printer and the image is printed in PDF format into a file.

I then use a program [pdfflip](#) to reversed the image and then I print that to my Samsung laser printer.

Here is the board before etching. Note the toner still has some paper attached to it, but not to worry, it will not have a serious effect on the process.

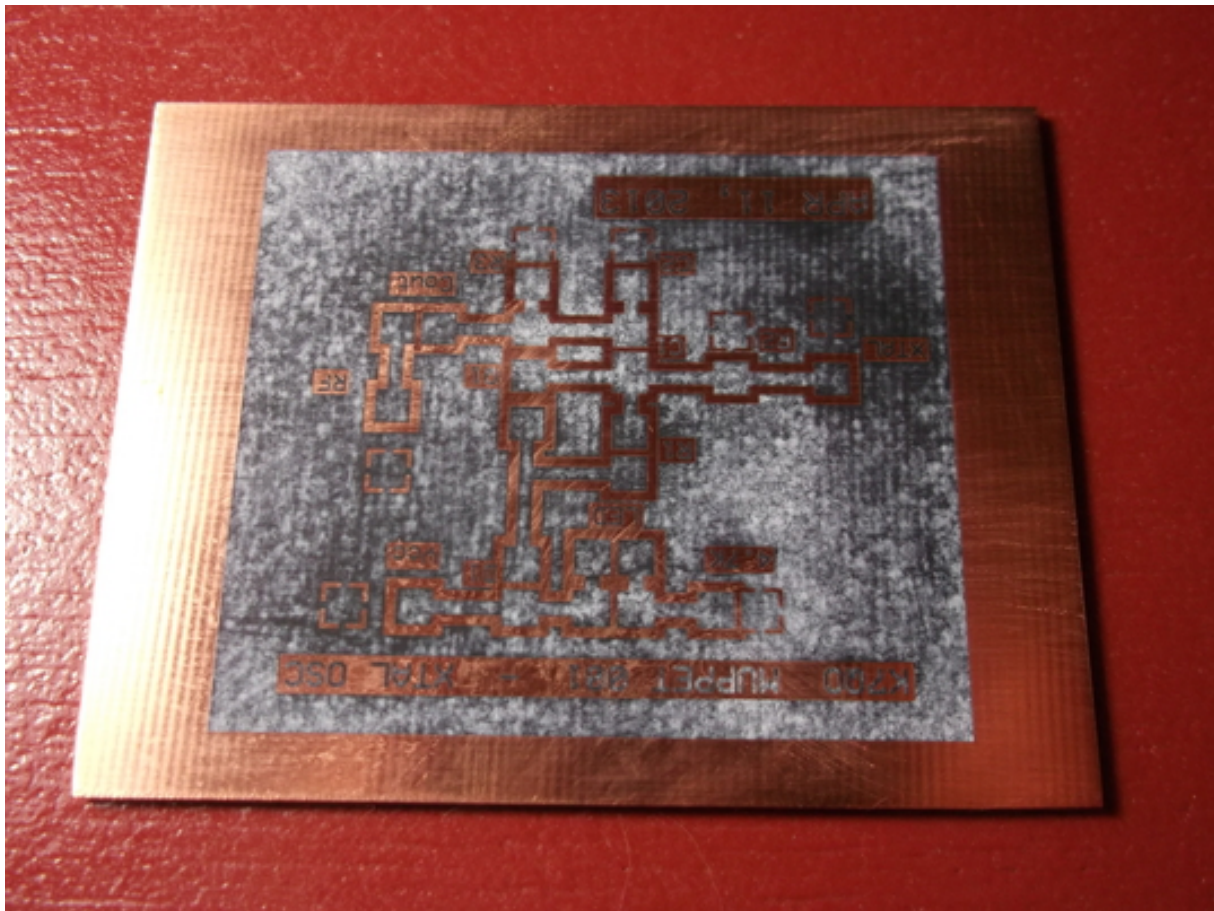

Figure 71: Toner transferred to board and paper removed.

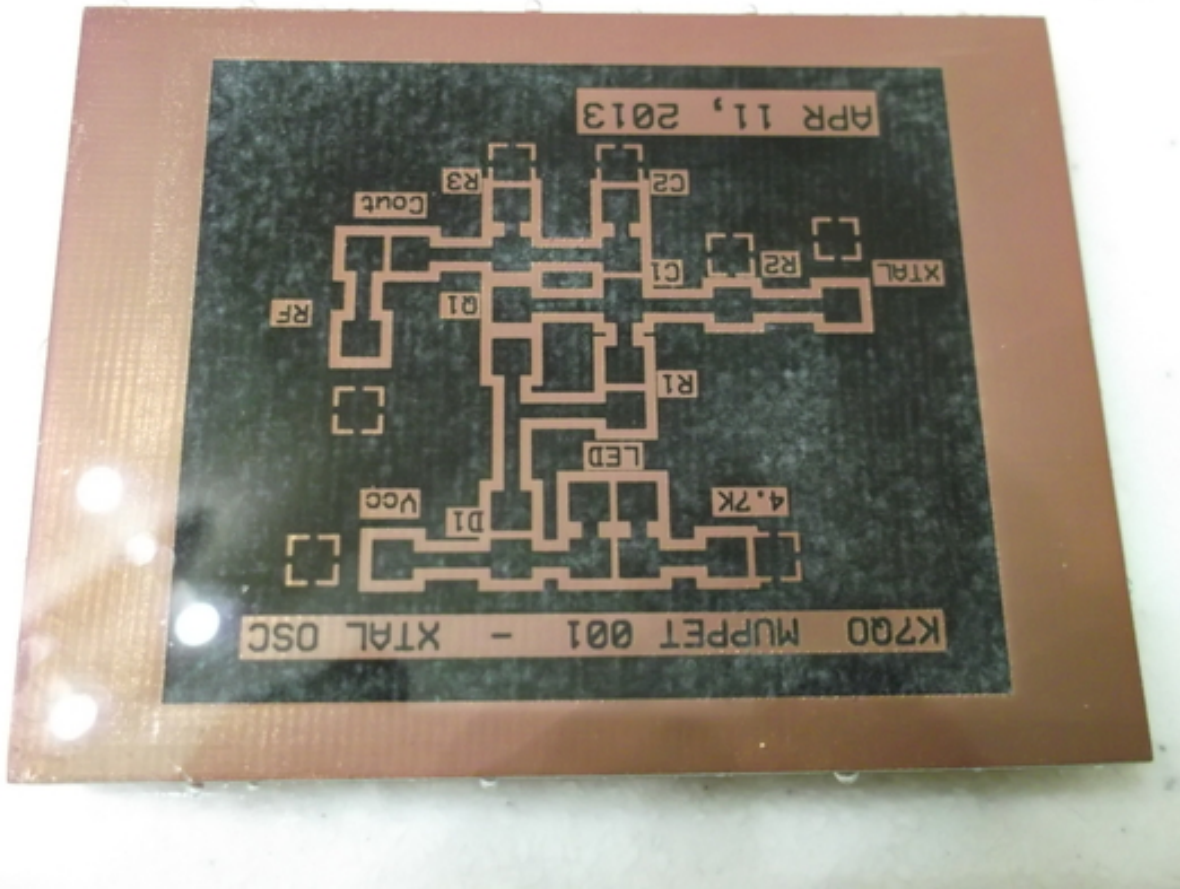

Figure 72: Muppet board in etchant.

Not how dark the copper turns almost immediately when placed into the two parts peroxide to one part muriatic acid solution for etching.

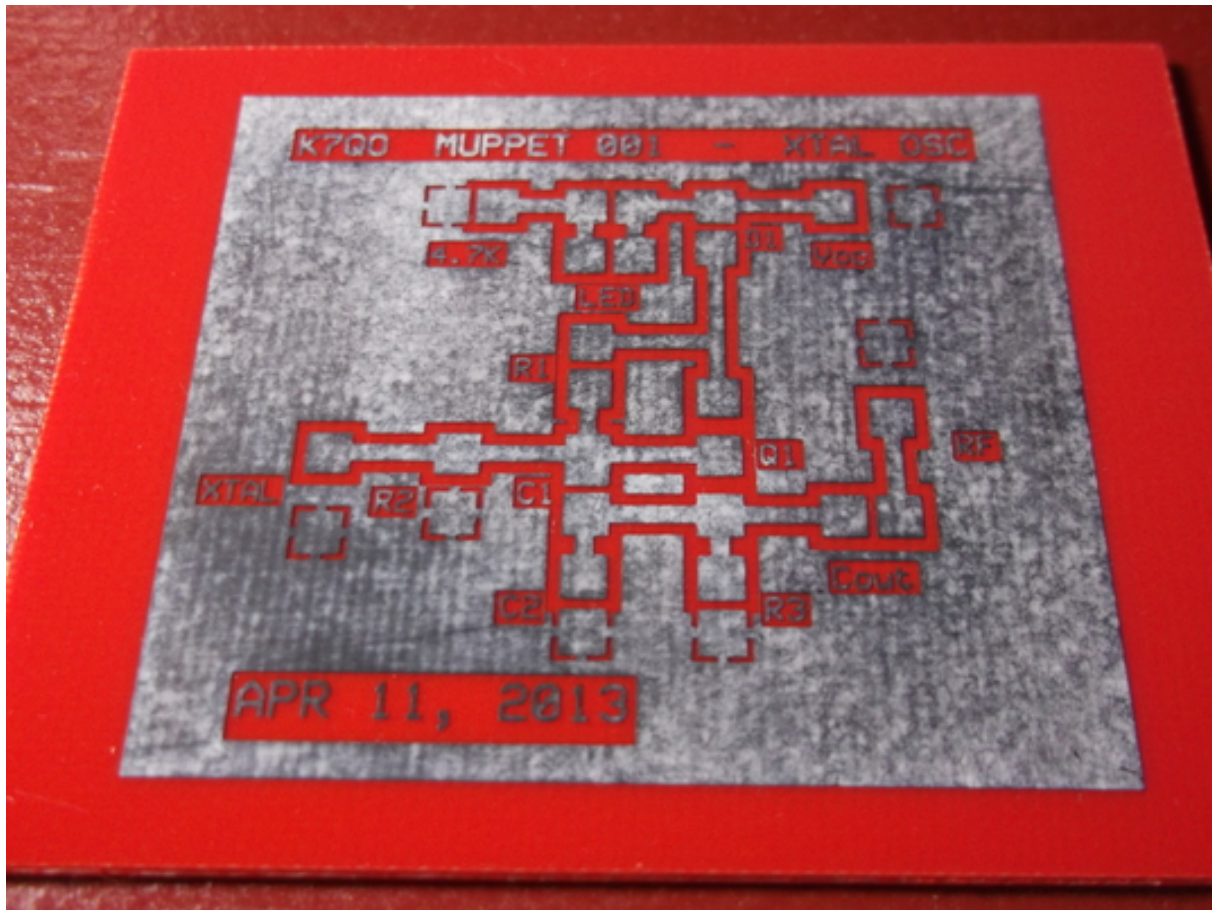

Figure 73: Muppet board etched with toner still in place.

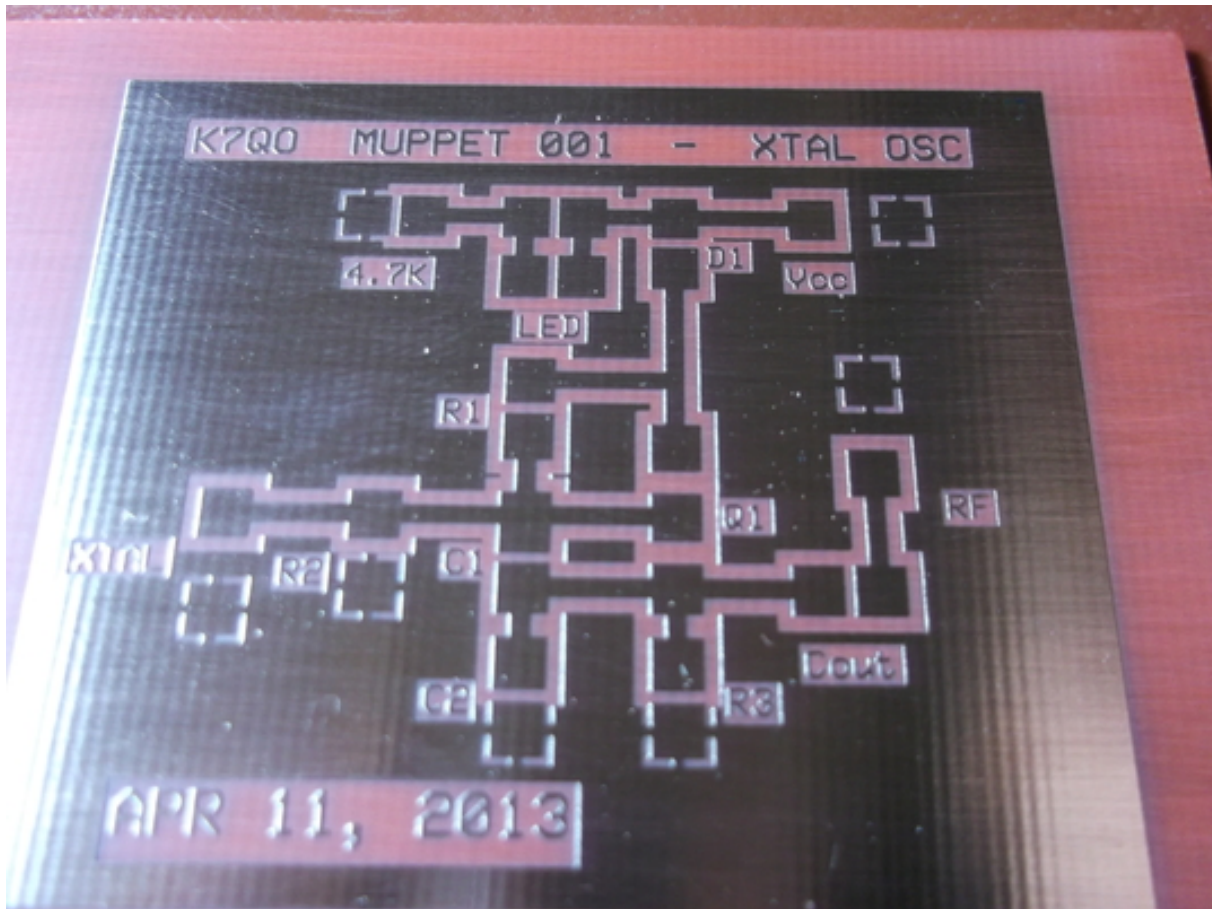

Figure 74: Toner removed with steel wool.



Figure 75: Board coated with light coat of clear Krylon.

Again, let me note that I usually spray a very light coat of clear enamel spray paint to protect the nice finish of the board. “Wait a second Chuck. Won’t that prevent me from soldering to the board?” And my reply would be no. It won’t if you do not cure the paint by heating in to 150° F for an hour, then your goose is cooked.

No, by air drying for a half-hour or so, the heat from the soldering iron and the solder will melt the enamel nicely and it acts as a solder mask to prevent the solder from spreading to the adjacent area. You just gotta love this stuff.

For a lot of small projects, we use a 9V battery for power. I have a number of 9V battery clips and connectors, but for these first projects I

am going to use one connector for all of them. I use 0.10" headers on the board to connect external power and as the output pins to connect scopes or meters to for measurements.



Figure 76: Some 0.10" male headers from China.

Cup of some of the 0.10" headers. These things are cheap. Real cheap. Check on ebay using Arduino male headers as the key phrase. You will see what I mean.

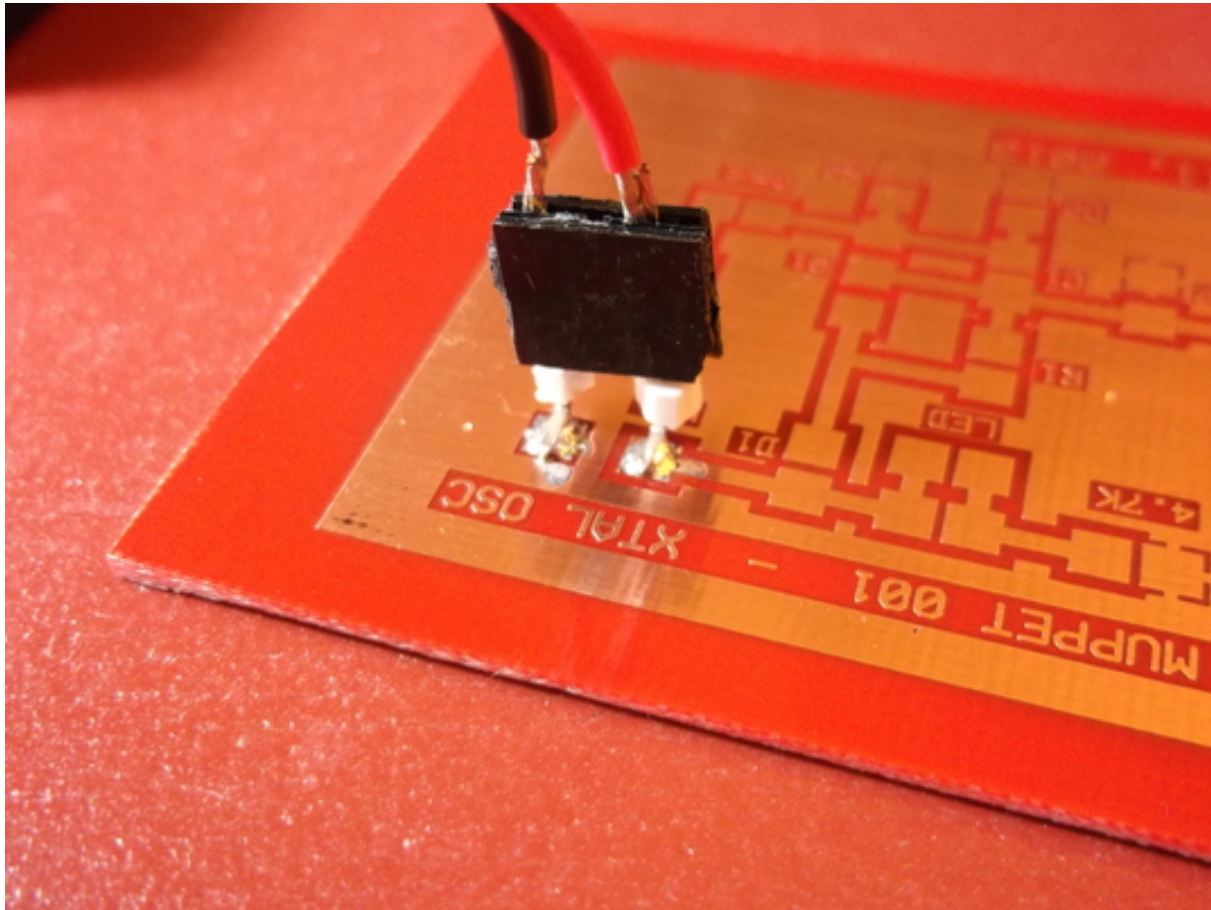

Figure 77: Male pins on PCB and the female header.

Above two of the male pins are soldered to the two power supply pads and the 9V battery clip is soldered to two pins of a female header with a center pin removed.

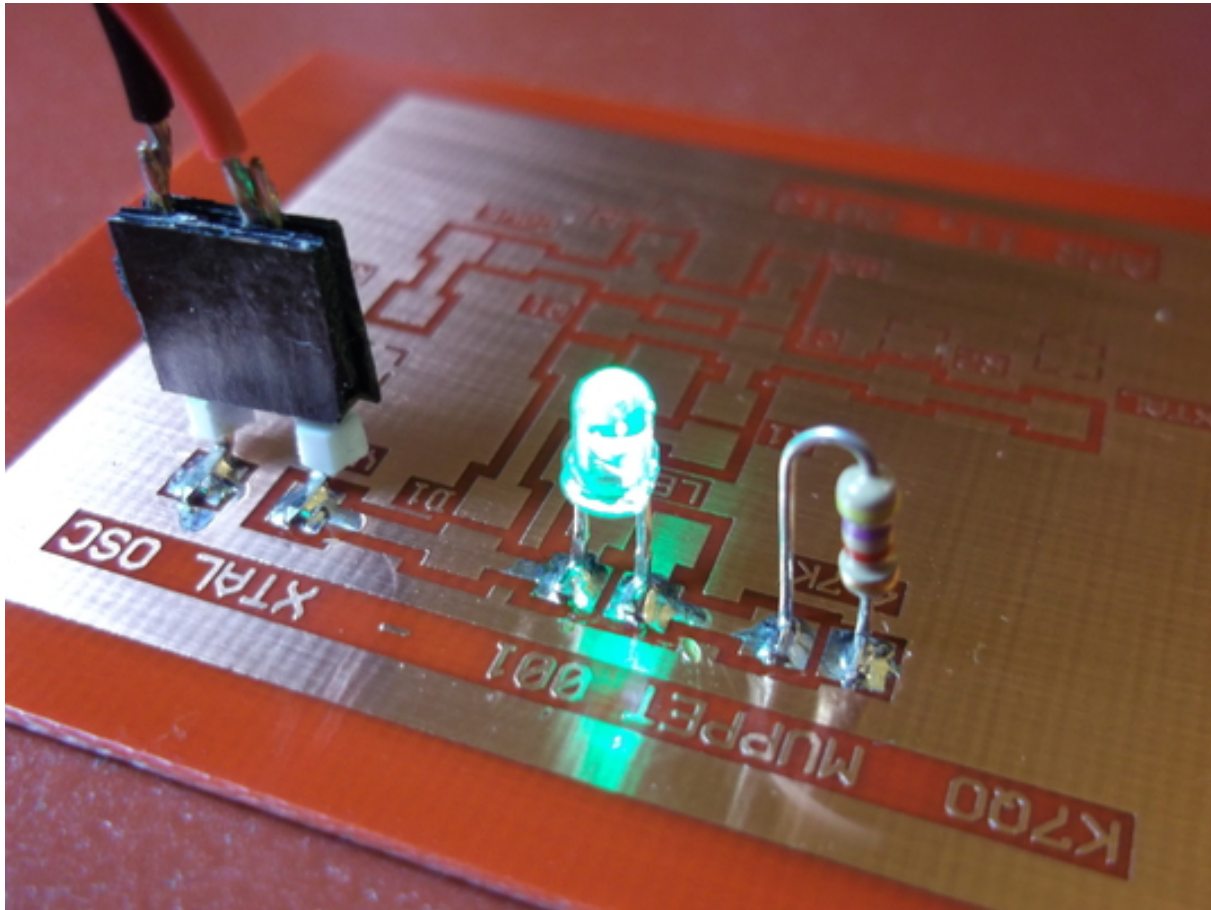

Figure 78: Green LED with current limiting resistor 4.7K.

In order not to leave anything on and run down the battery, I like to put an LED so that when it is powered up there is a visual indicator. With the 4.7K resistor the LED will only draw less than 2mA. Not a huge price to pay for peace of mind. I use a green LED, 15000MCD rating and it is bright even with the current limited to only 2mA.

For this project I put additional pads next to the LED for another LED, this one RED and in the opposite direction in polarity. If I happen to hook up the power supply backwards, the red LED will come on and show me that the circuit will not work.

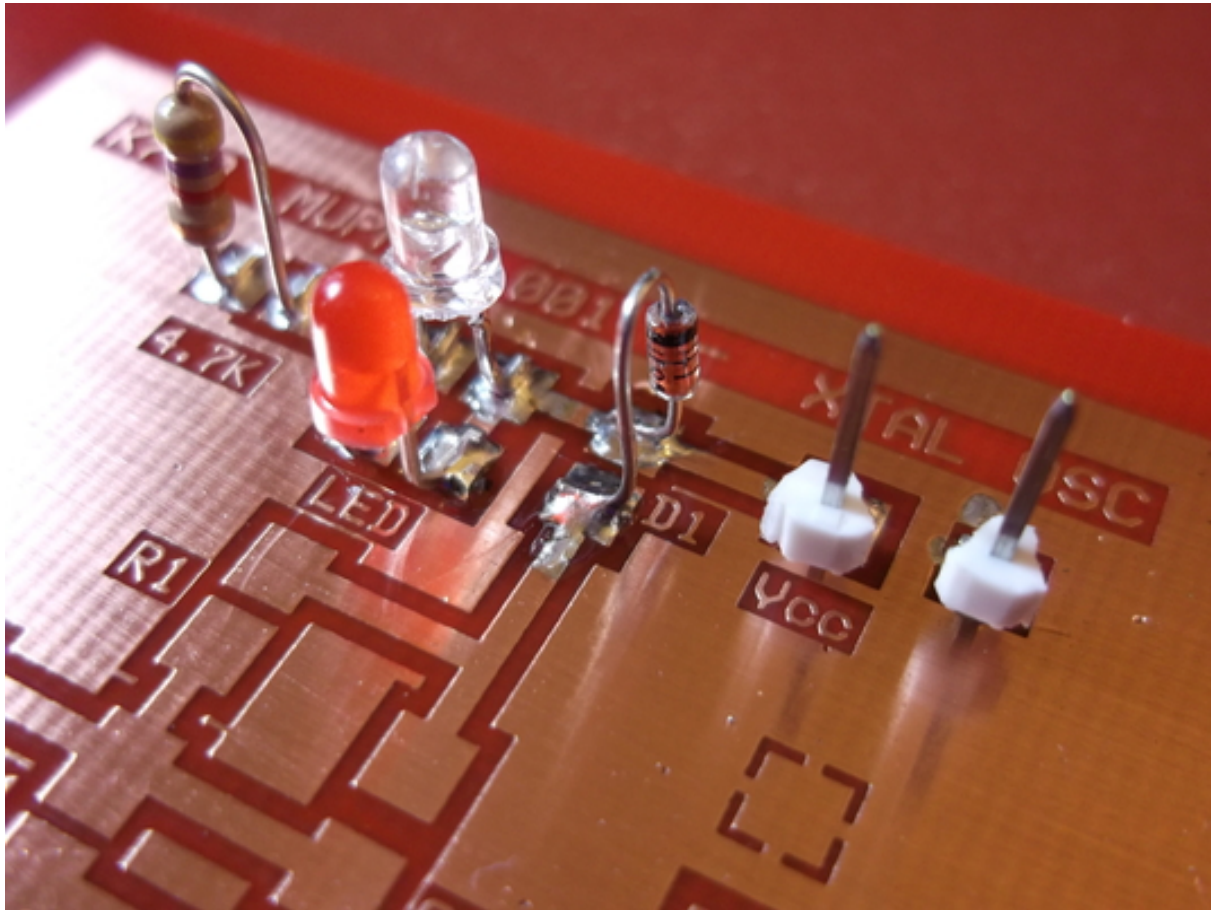

Figure 79: Reverse polarity protection diode, 1N4148.

Since this circuit and many others do not draw much current when in operation, I will use a cheap 1N4148 to protect the circuit. With the anode of the diode to the battery side of the circuit and the cathode (banded end) to the circuit, current will only flow if the battery is hooked up correctly. Impossible to destroy the circuit by hooking up the battery in reverse with this gimmick, otherwise you will destroy things by not using reverse polarity protection. Read the horror stories online.

Another benefit for using the 1N4148 for protection. If you happen to short out the power supply trace to ground during some experiment, the diode will burn out before serious damage can be done to your project. Not guaranteed, but a serious possibility.

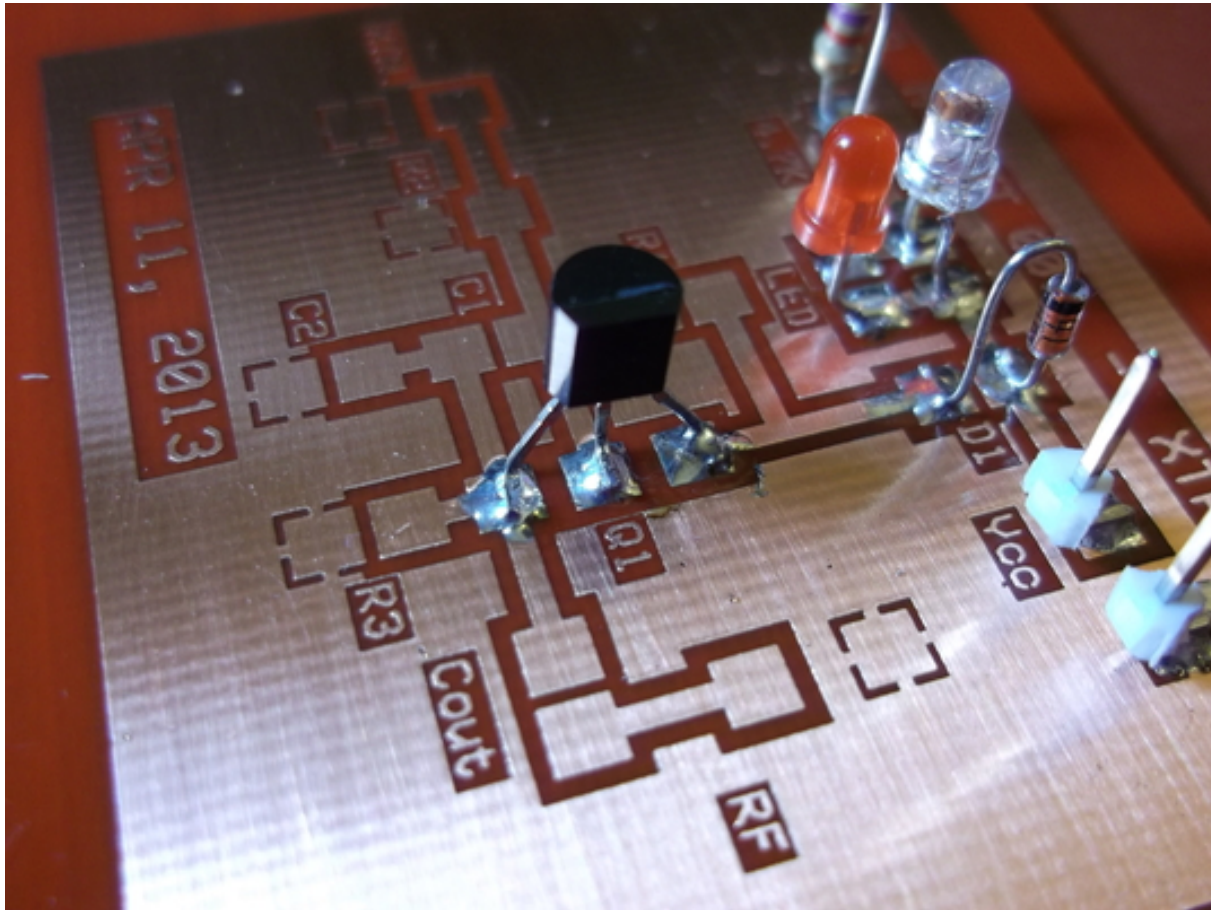

Figure 80: NPN transistor in position.

The circuit diagram calls for a 2N3904, but almost any NPN transistor will work, even the lowly 2N2222. This gives you a chance to experiment with other transistors. It must be an NPN though.

Note the orientation. If you use something other than a 2N3904, check the manufacturers spec sheet to make sure the pins are E B C reading from left to right in the photo. Make it a habit to check this. Not all manufacturers follow the same game plan from time to time.

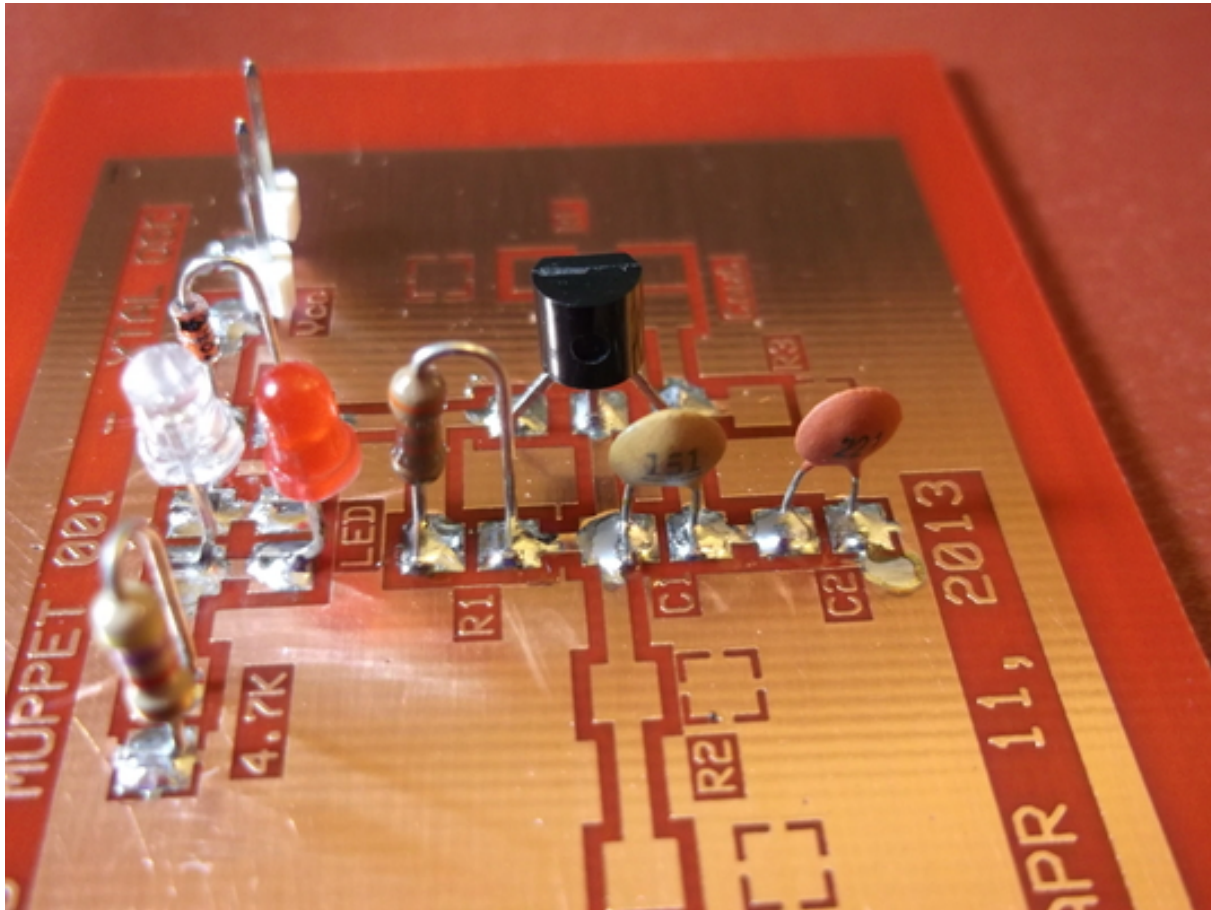

Figure 81: 33K, 150pF and 220pF components in position.

I do this so that I take care of components in a row before moving on to the next section.

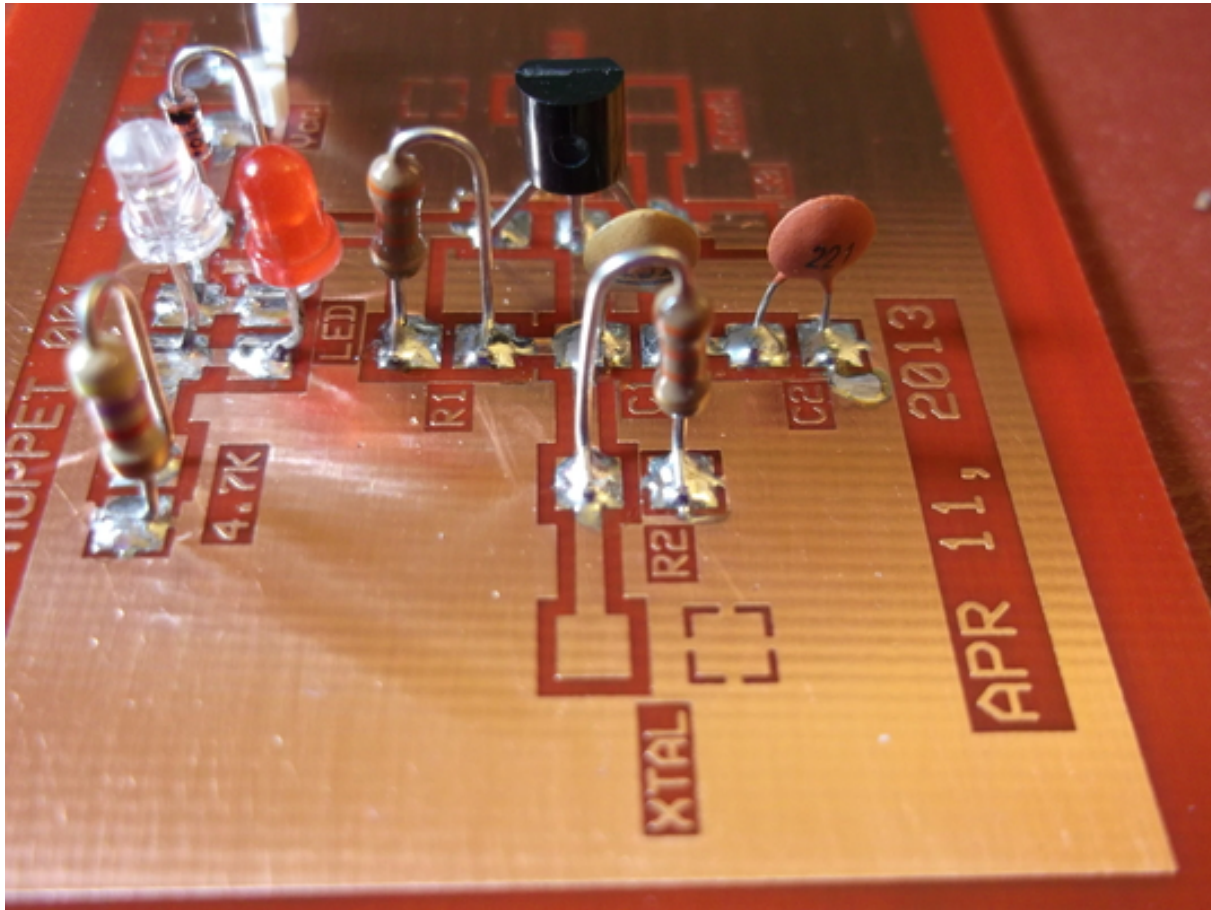

Figure 82: 33K component in position.



Figure 83: Crystal with socket.

I just picked a 8.000MHz crystal from the assortment that I have and I use a set of machined pins, come in a set of 4, and I cut one loose and cut the centered pin off as shown.

With the socket on the crystal leads, they are 0.20" apart, I can easily solder the pins to the PCB.

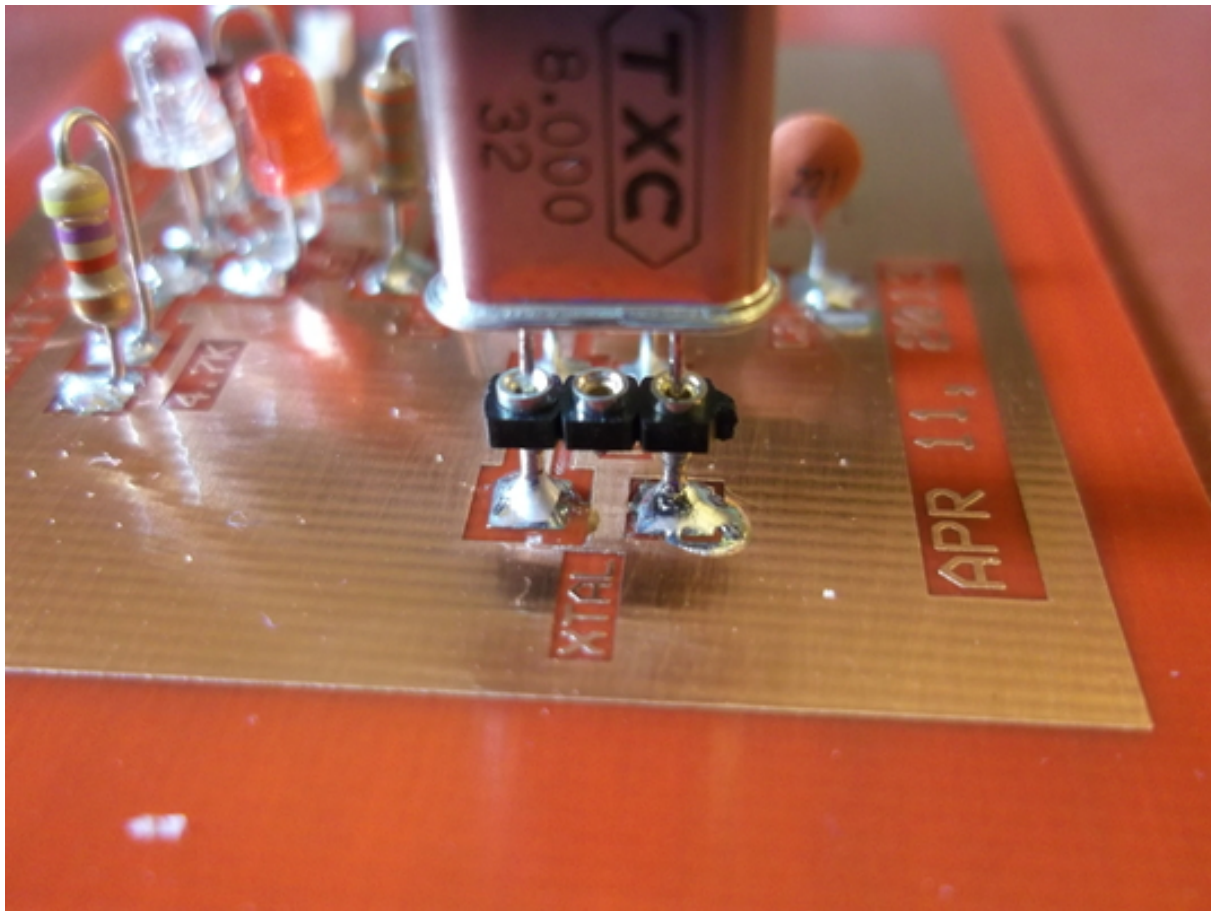

Figure 84: Crystal with socket soldered into place.

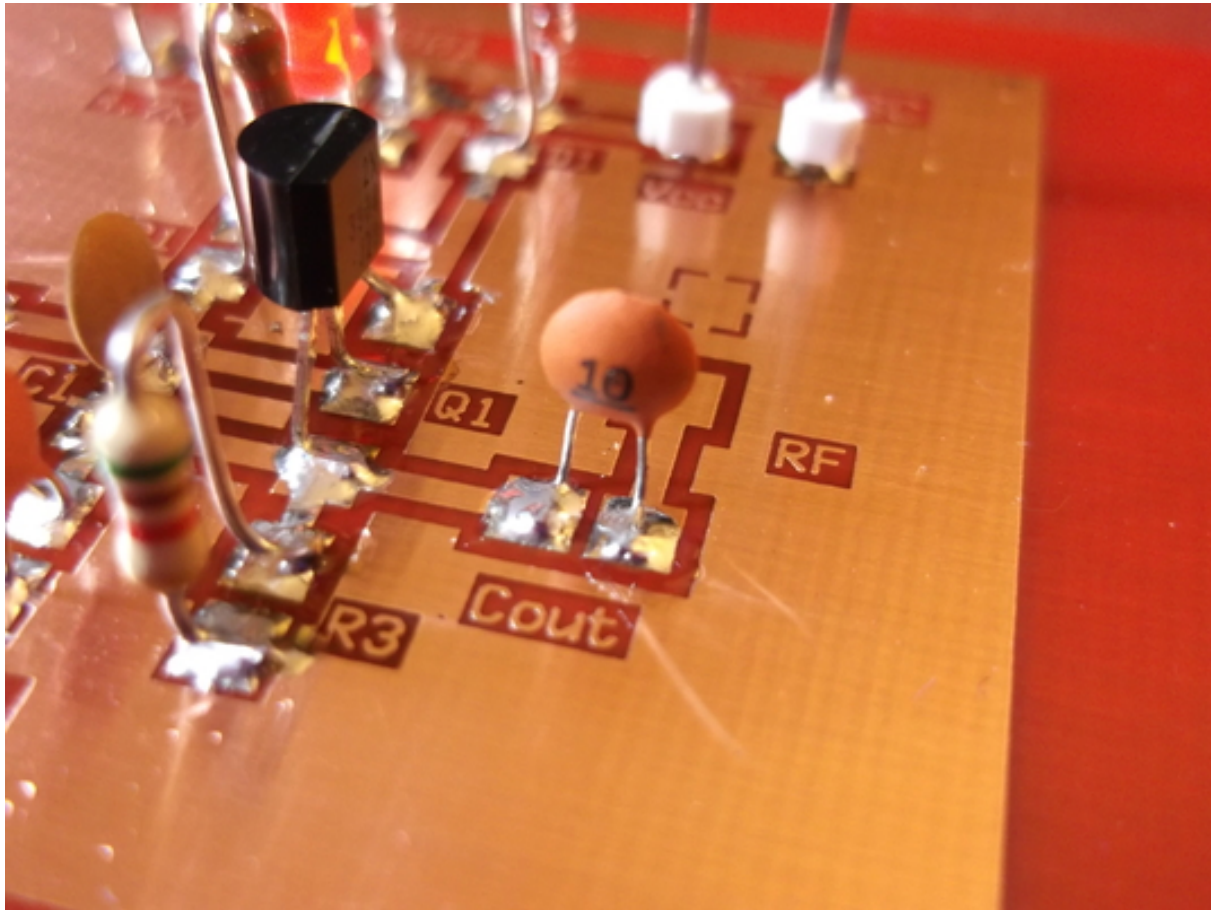

Figure 85: Here I picked a 10pF cap and it is way too small.

Here I made a mistake by not sticking to the schematic. I thought I would go with light coupling to the output of the circuit. But I will show you what will happen when you do this. For educational purposes for the masses.

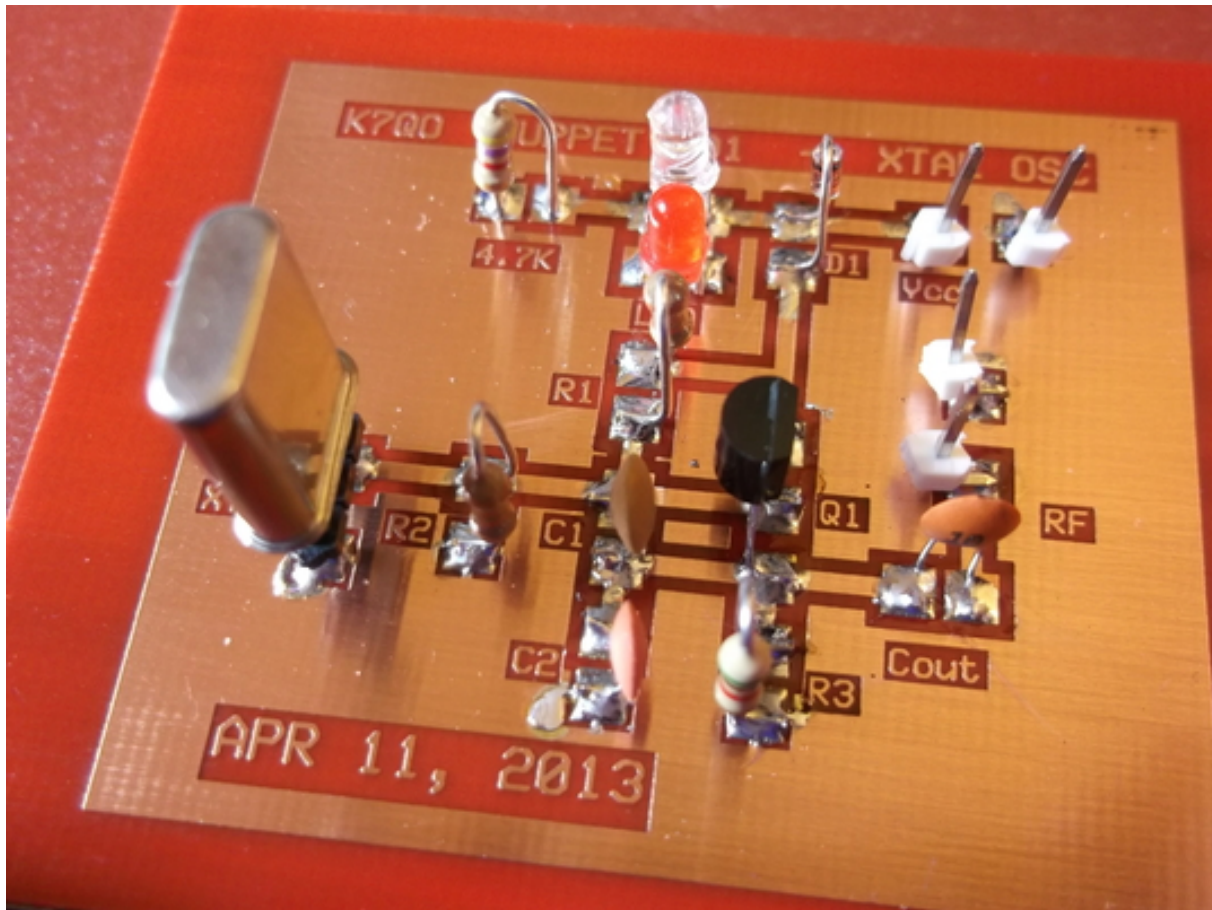

Figure 86: Here is the finished project.

As you can easily see. The project winds up looking fairly nice and orderly. Was not difficult to do, IMHO, and I think that even High School students in the sciences could benefit from this. But, there is the dangerous muriatic acid that might not be considered useful without close supervision in todays environment. I leave that to the professionals.



Figure 87: Oscillator up and running and connected to freq counter.

Here is where I learned that the coupling was too low. The NorCal FCC-1 frequency counter, that I consider to be the best there ever was, would not respond to the output from the 10pF cap, so connected it to the top lead of the 5.1K resistor (in the emitter to ground path). Remember I told you that I like to connect the bottom short lead of components to the ground pad so that I can hook up meters and scopes and counters to the 'hot' lead where the signal is.



Figure 88: HP3400A RF Voltmeter.

Here I have the probe connected to the output of the 10pF cap to the HP3400A RF voltmeter to see just how low the output is. With the meter in the 0.03V RMS position we can see that the output into a 600 ohm load is about 0.012V RMS.



Figure 89: HP3400A RF Voltmeter at 5.1K resistor.

Here, with the meter in the 0.10V RMS position and the probe at the 5.1K resistor connection to the emitter of the transistor we get a higher reading of 0.0525V RMS. A reading of over 4 times higher. When I get a chance, I will come back and replace the 10pF with a 0.01 μ F mono cap and see what the results will be. There is some other experiments we can do, but I will most likely add those as exercises for the student.

8.2 Second Colpitts Crystal Oscillator

Here is another Colpitts crystal oscillator laid out slightly different and with pads for components that are now 0.065" by 0.130" in size. Slightly smaller than the previous 0.100" by 0.100" square pads. With these smaller pads, it is easier to get pads that are spaced 0.10" apart from each other. A lot of capacitors have their leads spaced at 0.10", the standard grid points for printed circuit board layouts.

First, here is the new schematic showing an additional dual diode layout for measuring the voltage output of the oscillator. The circuit is a voltage doubler, so its output will be higher than the actual voltage, but I want higher output to be able to measure more easily. These values are for relative measurements for comparison for crystal activity or how easily the crystal oscillates.

Poor quality crystals will output a lower voltage, which you may discover in crystals from the same manufacturer in the same production run (called batch in every day terminology).

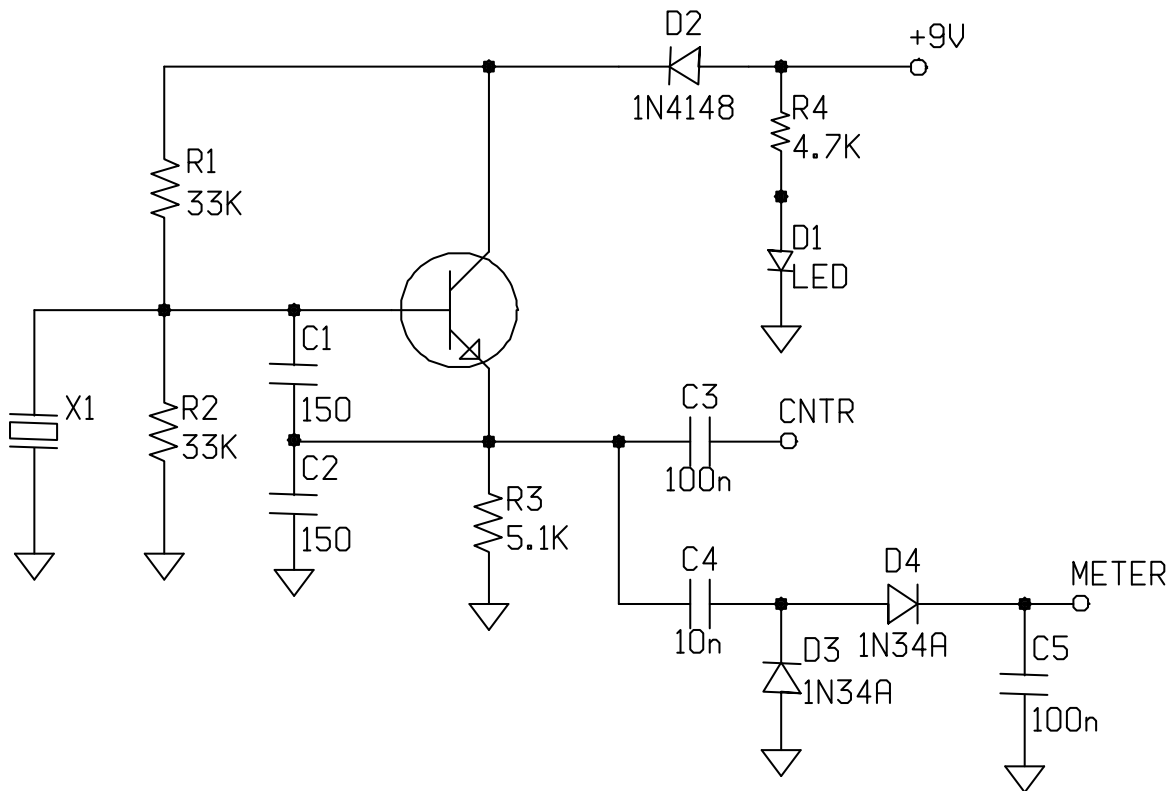

Figure 90: K7QO-0004 Revised Colpitts oscillator schematic.

OK. Now the new edition for the simple Colpitts crystal oscillator. Showing more detail about the LED addition.

R4, the 4.7K resistor, is for lowering the voltage drop across the LED. This value sets the current to a little less than 0.002A or 2mA of current.

Diode D2, a 1N4148, does two things. If I happen to hook up the power supply backwards, then there is no current allowed into the Colpitts oscillator and thus protecting the transistor from a reverse voltage that may damage it.

The second thing that D2 does is act like a small fuse. It will not handle more than a few hundred milliamperes of current before it self destructs. I bought a 1,000 of these diodes one time at a radio amateur swap

meet. One of the best deals I've gotten along with a lifetime supply of 4.7K resistors.

You may want to try the circuit with 12V of power. Now the LED gets around 3mA of current, which it can still easily handle. It is an interesting experiment to see what happens to the output level from the oscillator.

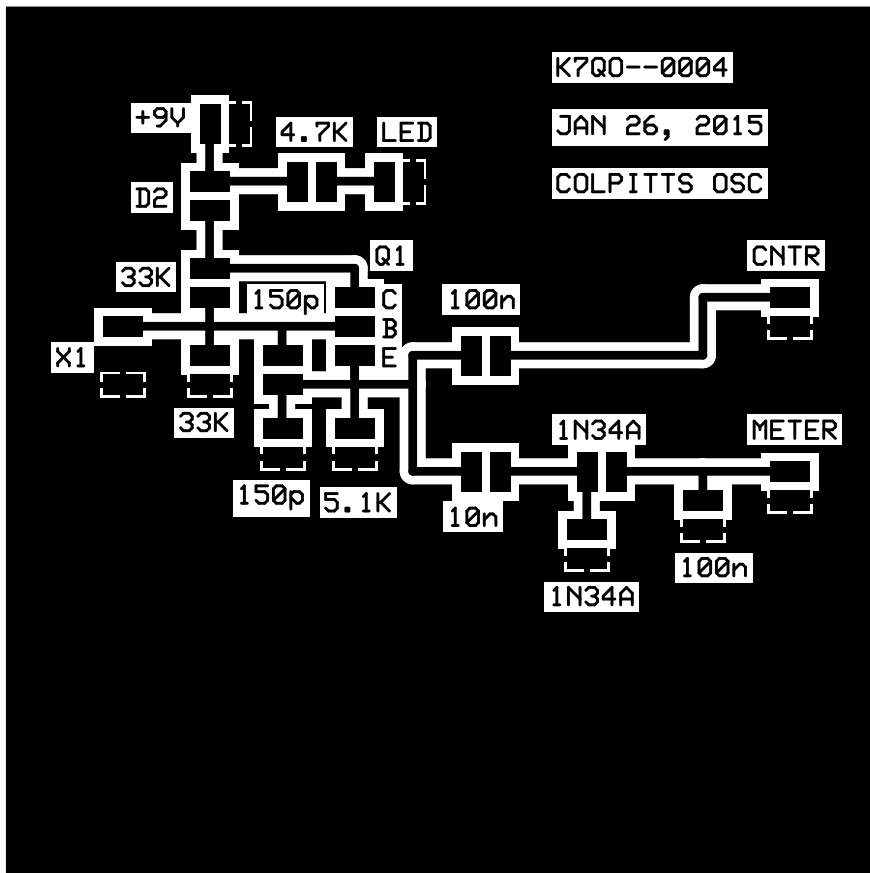

Figure 91: New Colpitts oscillator PCB layout.

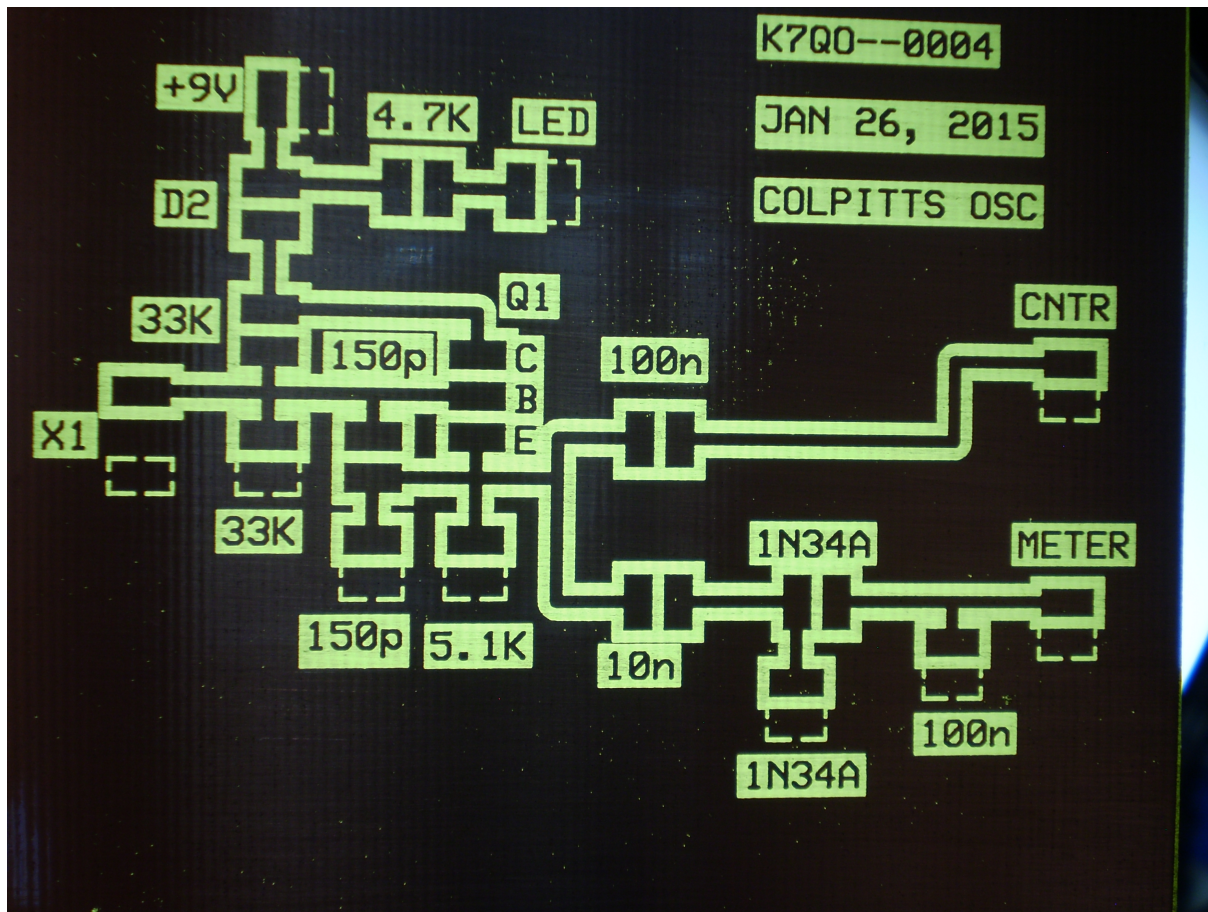

Figure 92: Etched board backlit to show detail .

Please note the following details.

Look at the label 150p that is to the left of the collector pad for Q1, the 2N3904. Look at the line above the text and just to the right of it. You will know you have perfected your transfer and etching techniques when you can consistently reproduce these fine lines. It does take time and practice to home in on what works for you.

Another thing. The lettering for this board is 0.060" high. When all the parts of the letters come out almost perfect, you will have another indicator of a high rate of success. Enjoy the journey. The most difficult letter is the Q.

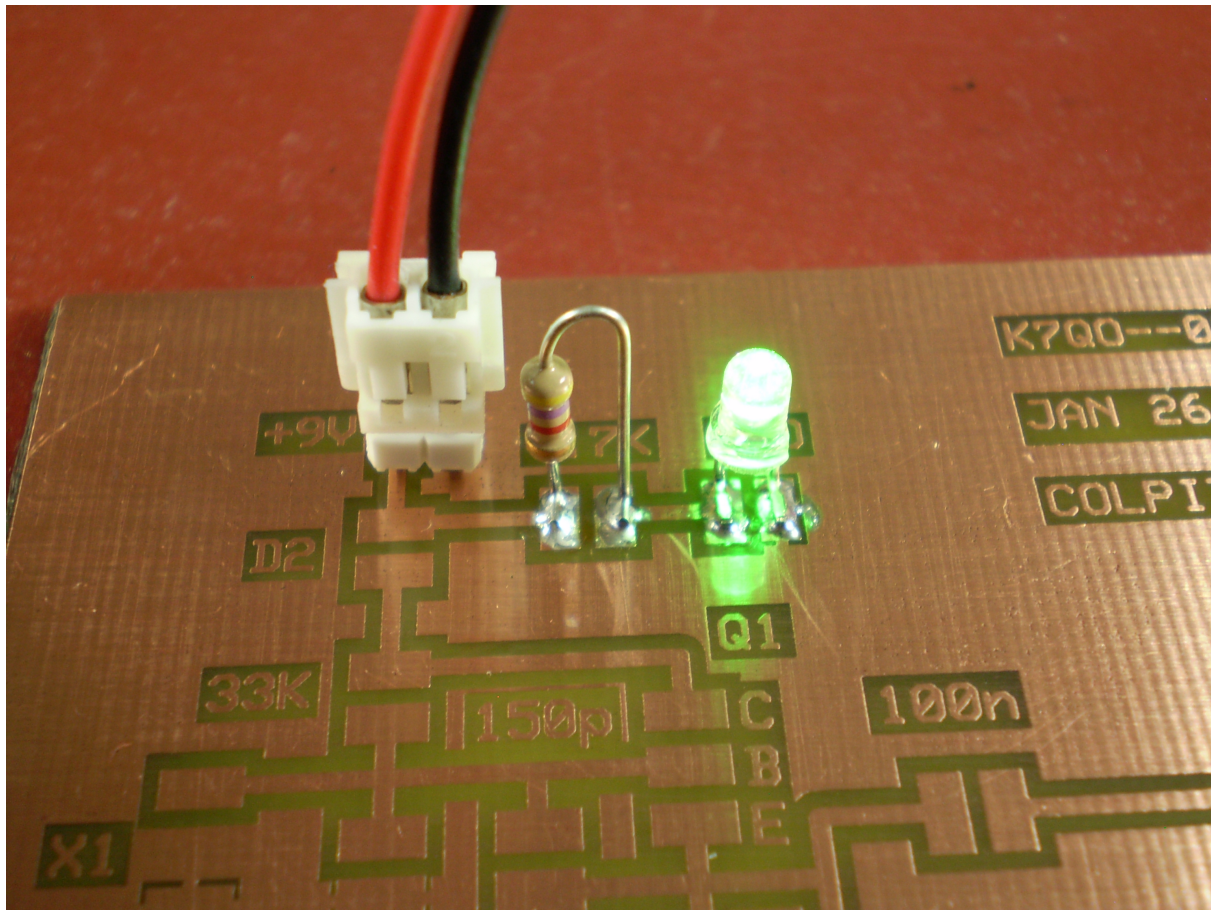

Figure 93: Power connector and LED powered up.

Now this may seem to be ridiculous to you, but I do it every time. I install the power connector, the 4.7K resistor and LED first. I then attach my power supply, in this case a simple 9V battery and make sure the LED comes on.

I, and you too, will feel foolish when we have completed a project and THINK we have power coming to the board and there is a problem with the power supply or connection.

Also will show if there is a short somewhere. I hope this never happens to you. The high current will cause some things to severely heat up.

I now use some scrap 0.030" PCB material to bend the leads on resistors. This gives me the 0.10" spacing on the leads at the bottom. I

made a mark on the PCB about 2mm from one edge to put the top of the resistor and have the bend the same size and height all the time. Just a artsy type thing. Looks nice.

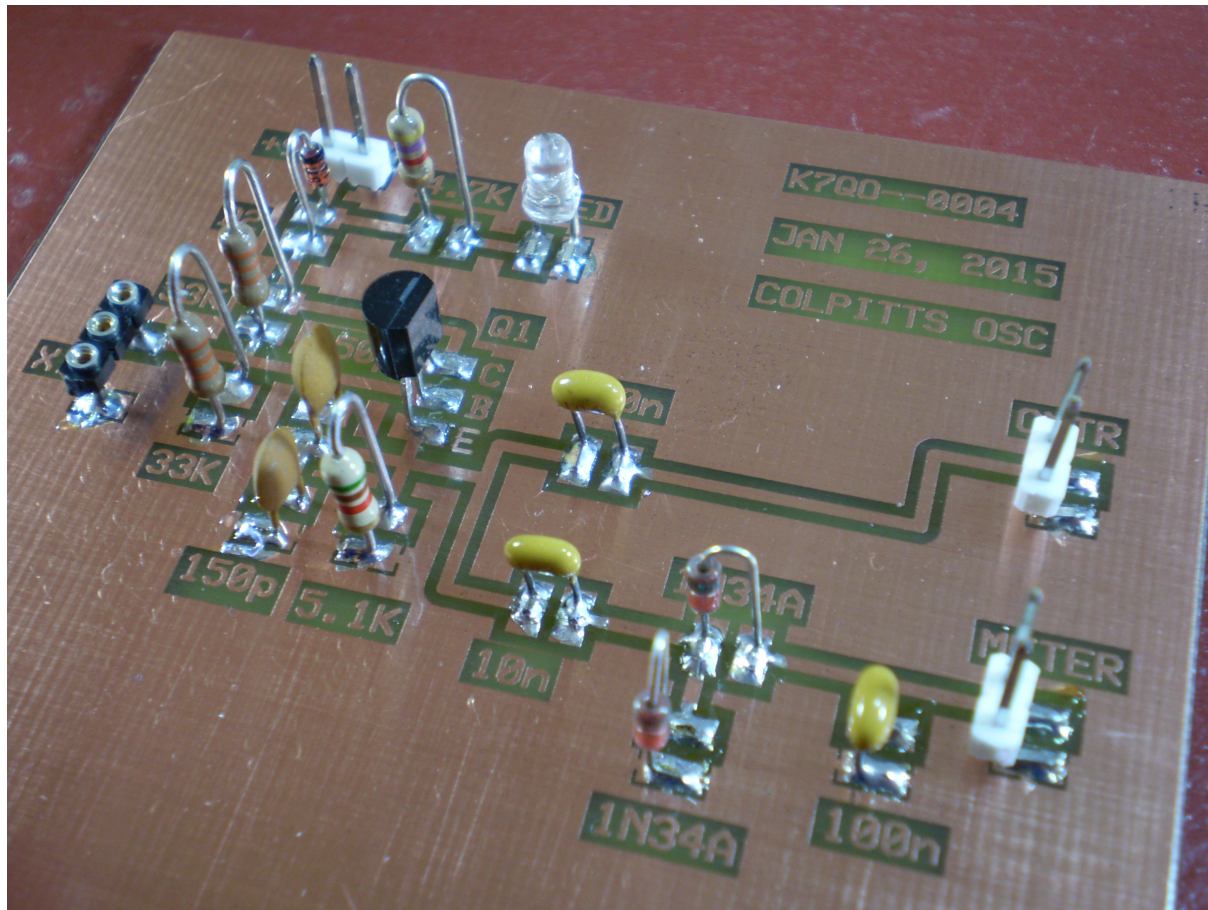

Figure 94: Assembled k7qo-0004 muppet board.

Now, come on. Even you have to admit that this layout technique has some beauty to it. But that is not the main reason why I love it.

One. It is not that difficult to do, once you get things in place to do it.

Two. Consistency. You can reproduce board after board with a high success rate of completion. The layout of the board forces me to think about each step. Carefully making sure all the parts are going on the board, in the right place and the connections are correct. It forces you to think and to concentrate. Don't be a robot and slap things together.

I don't need a shrink. This stuff keeps me sane, takes me away from all the bad news on TV and results in a lot of quite time. I don't have a receiver going in the background, no TV, no iPod and/or other distract-

tions.

Just my way of relaxing. Lowers the blood pressure significantly. IMHO. :-)

8.2.1 Building Order for k7qo-0004

For those that need Heathkit like assembly instructions. Here is the order in which I assembled the board. I like to build in sections and plan ahead to avoid having to place soldering iron in uncomfortable positions to solder.

- LED
- 4.7K resistor
- +9V connector
- Power up to see if LED lights up
- Debug to find out error(s) if no light
- Q1 2N3904 or similar NPN transistor
- 5.1K resistor
- 150pF capacitor
- 150pF capacitor
- 33K resistor
- 33K resistor
- XTAL socket
- 100nF capacitor
- 10nF or 100nF capacitor
- 1N34A diode or 1N4148 if no 34A available
- 1N34A diode or 1N4148 if no 34A available

- 100nF capacitor
- Counter connector at CNTR
- Meter connector at MTR pad

8.3 Pierce Crystal Oscillator

Here is another geometry for a crystal oscillator. The Pierce oscillator, because the crystal is in the feedback loop to the base of Q1, makes the crystal oscillate much closer to the natural series resonant frequency of the crystal.

The purpose here is to build it and check to see how much better it just might be for matching crystals faster and easier than the other techniques discussed in earlier chapters.

Here is the schematic for the Pierce oscillator. Always feel free to experiment with the values if you don't have the exact part(s) in your junk box or supply cabinet.

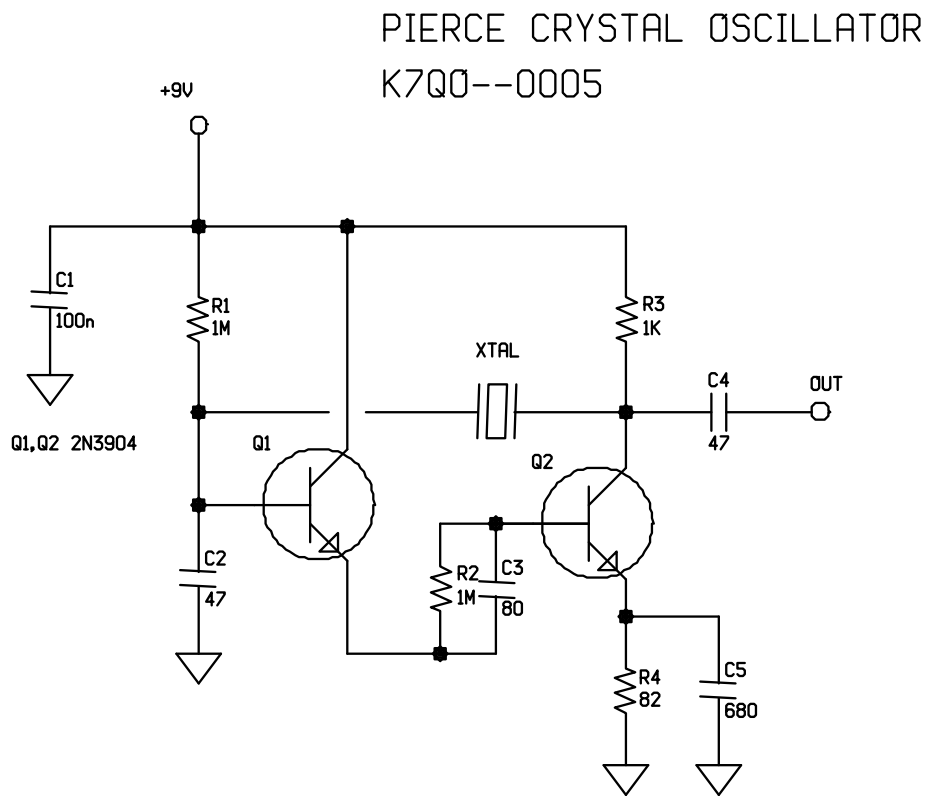

Figure 95: Pierce crystal oscillator schematic.

Chapter 9

Crystal Matching and Crystal Filters

This chapter we will look at the techniques for matching crystals and how it effects the performance of crystal filters typically used in IF filters for superhetrodyne receivers.

I have several thousand 4.096MHz crystals. Why? I came across an open bidding on ebay for these crystals. There were no bids and the bid was at \$10 with free shipping. OK, I put in the \$10 bid. My thought was that no one would let these crystals go at this price. A penny per crystal? Easy to bid on.

As it turns out, no one must have wanted them and I won the bid. Now I have a lot of 40m IF crystals. :-) So, let's use them as part of this analysis.

In the previous chapter on measuring crystal parameters you do not want to be using that for matching crystals. The process is just too tedious, even for the serious experimenter. History shows us that crystal matching is done with a crystal oscillator and a frequency counter that is precise to 1 Hz.

I am going to use a Peirce oscillator to start with and see how well the procedure works. To see if the technique has been used correctly for many decades by radio amateurs worldwide.

I took 100 crystals from stock. Setup the crystal oscillator on a muppet board and the NorCal FCC-1 frequency counter. I measured the 100+

crystals and here is the distribution plotted as a histogram. Each step is the number of crystals in a 10 Hz interval. This means that all the crystals within the interval are matched to 10Hz or less. There is also the possibility that a crystal in an adjacent interval may be within 10Hz of one or more crystals in the interval and on the adjacent edge of the frequency spectrum.

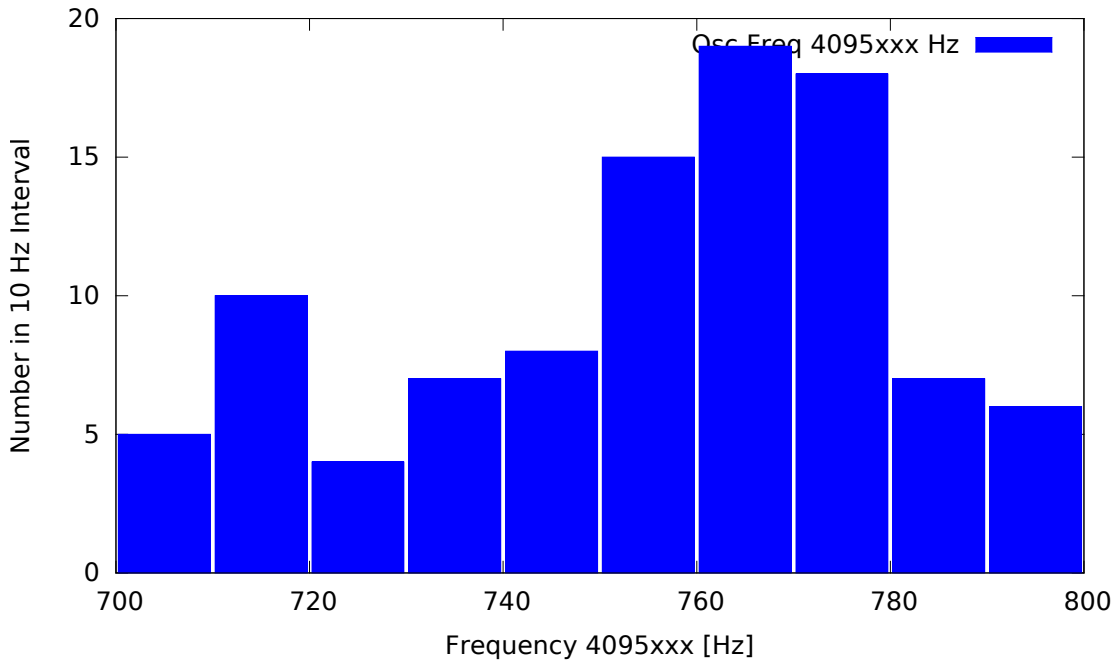

Figure 96: Distribution of 100 or so crystals marked 4.096MHz.

As you can see, of the 100 crystals almost half (50) are between the frequencies of 4095750 and 4095780 Hz. This amounts to a pretty good grouping. If you buy all your crystals for IF filters from the same source at the same time, then you have a very good chance of getting all the crystals manufactured on the same day. The date codes stamped on the side of the case should match. This makes for a very uniform batch of crystals.

OK, I'm going to find three crystals that have the exact same resonant frequency in the oscillator and measure their crystal parameters and see how they compare. This will indicate just how matching crystals with just an oscillator will work. This is how a lot of kit manufacturers and individuals selling matched sets do it.

Here is how I sort crystals without having to resort to paper cups or spreading them all over the desk. This is yet another use for vector board. I put a 20mm (2cm) standoff at each corner. This allows the crystal leads to extend through the bottom of the board and not touch the desk surface.

Here are two photos showing the process while doing the work. For me, it is simple and orderly and prevents mistakes.

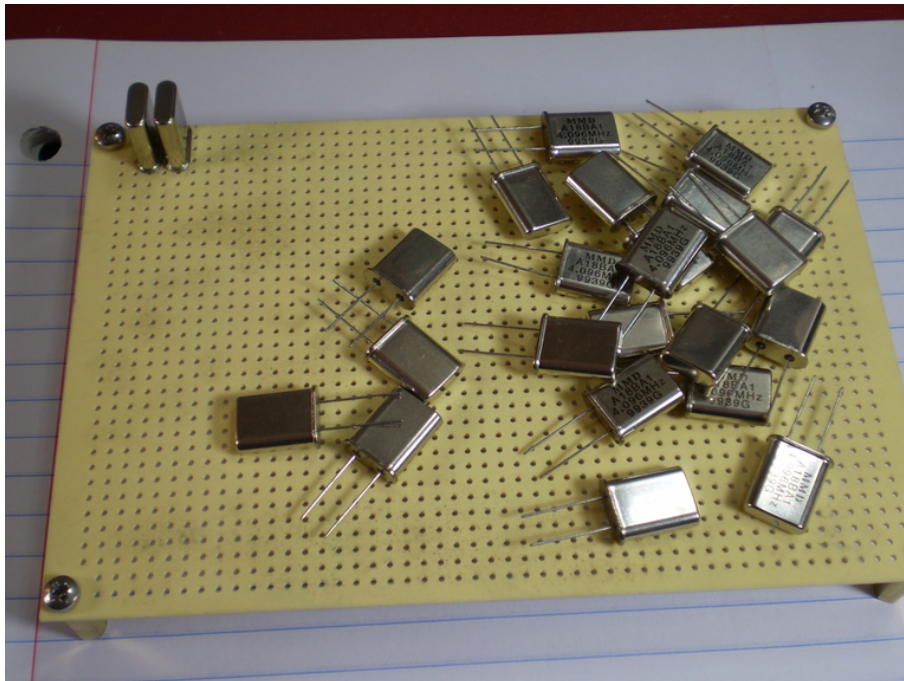

Figure 97: Vector Board and Crystals.

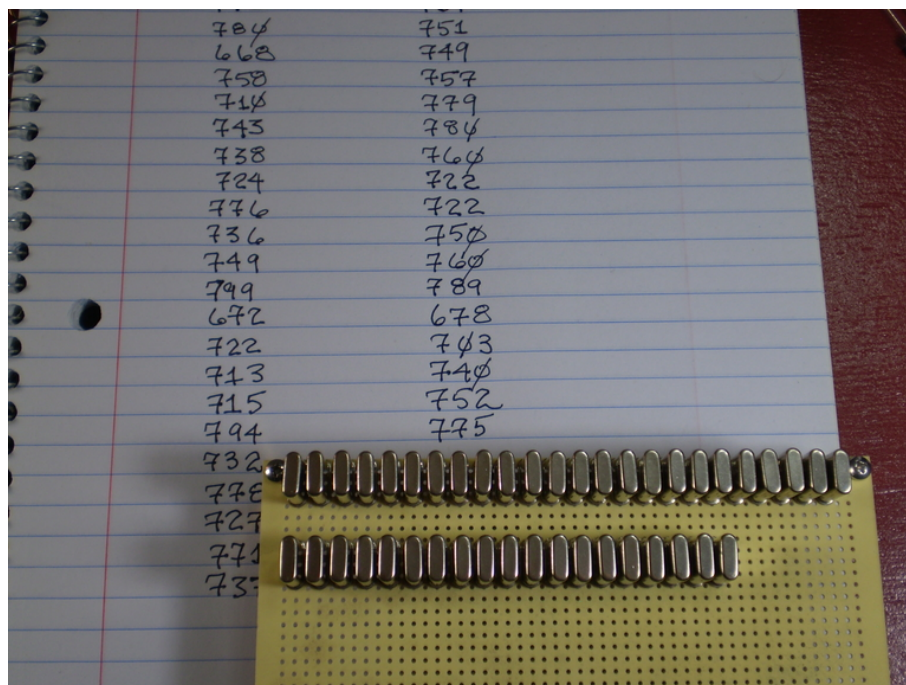

Figure 98: Vector Board, Notebook and Crystals.

As I measure the resonant frequency of each crystal in the Pierce crystal oscillator for this experiment, I write down the frequencies in order in a column and place the crystal next the previous one into the vector board. Easy to do since the lead spacings are 0.20" and the holes in the board are at 0.10".

Then, if I need a specific frequency or crystal I know where it is. I double check when I pull a crystal from the board by remeasuring it in the oscillator. This to prevent errors as much as possible.

I found three crystals that each output the exact same frequency of 4,095,722MHz. I take each crystal and use a fixture similar to that of HB9DUL on the web. I use a 9.73pF and a 34.14pF capacitor for the series capacitor for measurements.

Here is what I get.

Crystal 1:

f_s = 4094851 Hz 0.0205V (RF meter) R_s = 12.1 ohms C_0 = 2.91pF
 f_2 = 4095391 Hz 0.0180V
 f_3 = 4096129 Hz 0.0124V

Crystal 2:

f_s = 4094880 Hz 0.0222V (RF meter) R_s = 11.4 ohms C_0 = 2.86pF
 f_2 = 4095403 Hz 0.0194V
 f_3 = 4096118 Hz 0.0134V

Crystal 3:

f_s = 4094857 Hz 0.0202V (RF meter) R_s = 12.5 ohms C_0 = 2.91pF
 f_2 = 4095393 Hz 0.0175V
 f_3 = 4096129 Hz 0.0120V

By going to the web site for HB9DUL and plugging into his data entry boxes the above values for each crystal I get the following values:

Crystal 1: $L_m = 135.499\text{mH}$ $C_m = 11.149\text{fF}$
 $R_s = 12.1 \text{ ohms}$ $C_0 = 2.91\text{pF}$

Crystal 2: $L_m = 139.922\text{mH}$ $C_m = 10.796\text{fF}$
 $R_s = 11.4 \text{ ohms}$ $C_0 = 2.86\text{pF}$

Crystal 3: $L_m = 136.780\text{mH}$ $C_m = 11.044\text{fF}$
 $R_s = 12.5 \text{ ohms}$ $C_0 = 2.91\text{pF}$

As you can see there is excellent agreement on the motional parameters. I was surprised that a change of only a few Hz in the measurements between crystals changed the motional values by a few percent. Very sensitive parameters.

The C_0 values were measured using an L/C meter. R_s by removing the crystal and using a variable resistor to get the same voltage out at the series resonant frequency.

9.1 Conclusion So Far

I have shown in detail that the old technique of matching crystals for crystal filters can be done very well by just using a simple crystal oscillator and finding crystals that have the same frequency or close to each other. To get exact matches requires a significant inventory of crystals.

I happen to have several thousand of the 4.096MHz crystals. I won them in a bid on ebay when the vendor posted the items as a lot and started the bidding at ten dollars US. I made the ten dollar bid and no one else increased it. This included free shipping. So I have a lifetime supply of the critters.

I have to do some more measurements with a Colpitts crystal oscillator to verify that the oscillator geometry does not give erroneous results.

Also to build some IF filters and sweep them to determine how well they function when care is used in matching the crystal frequencies and the resulting impedances necessary to use them in a circuit.

Chapter 10

The Shear

Before I get too much further in this document let me show you the best purchase of the decade. This critter has saved me more time and money that I can ever list.

For years I have been using a Harbor Freight shear, SKU 90757, and retails for \$199.99 with \$7.00 (approximate) shipping cost. It is an 8" shear and does an excellent job on PCB material, but requires extra care to keep the edge straight along the cutting line of the material due to torque of the cutting edge against the material. I found a better solution.

10.0.1 Enco Shear

I bought a shear from use-enco.com that was on sale for \$89.00 US and with shipping the total price was \$117.00. The shipping was expensive due to the mass of the shear, about 30kg. This is a sturdy and heavy shear that should outlast us all. I bought it only for PCB work and it will not be used for cutting metal sheets. I plan on making a lot of PCB enclosures. The shear in May of 2013 was on sale for about \$120.00 and you still have about \$37.00 for shipping, but that is still a good deal considering the size of the shear and the amount of work you can get done with it over the smaller shear.

I first mounted the shear on 1" plywood so that I would not have to commit space on the workbench for it. Here is a photo of the shear on

its platform.

It has a spec of 12" for the cutting edge, but due to a portion of the blade that is already below the cutting edge of the bottom blade, the cutting length is more like 10" after all is said and done. Not an issue with me. It is what it is.

The circular disc and the rotatable shaft that you see horizontally positioned above the cutting edge is a hold down that keeps the material being cut from coming up at an angle during cutting. I took that off and I was never going to use it.



Figure 99: Harbor Freight 8" Shear.



Figure 100: Enco Shear SKU130-5700.

I made a platform/work table on the mounting piece and it looks like so.

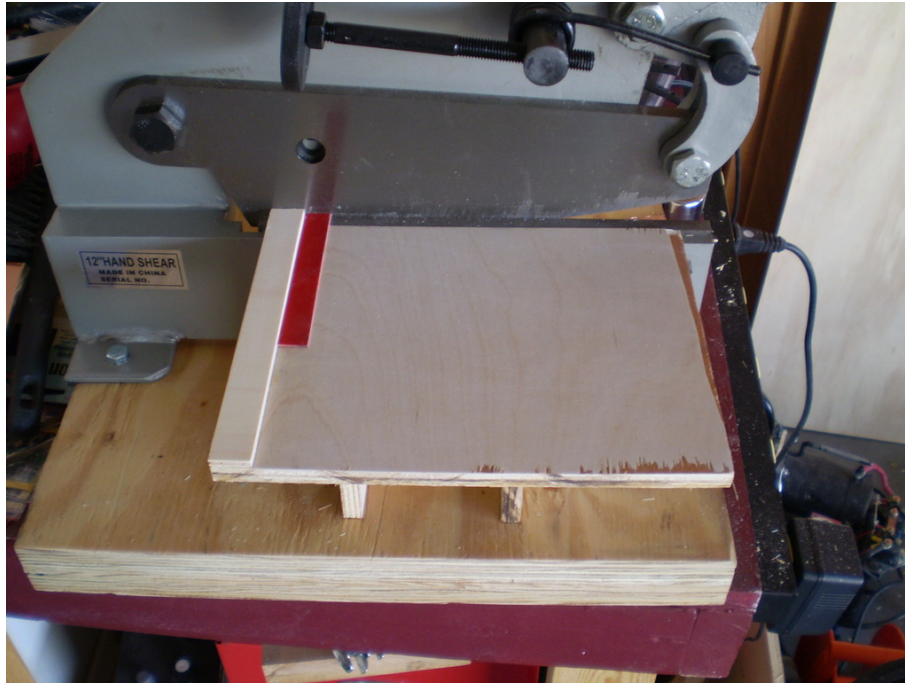

Figure 101: Enco Shear SKU 130-5700 at use-enco.com.



Figure 102: Enco Shear SKU 130-5700 at use-enco.com.

Make absolutely sure that the left stop is at 90.00 degrees to the cutting blade as I have done. Also, the red plastic piece is an add-on because I forgot to make sure that I was away from the part of the blade that was already down. Make sure, before you glue down the working surface that a board will go into the cutting opening.

Here is a set of photos with the shear on my workbench in the garage. I use a goose neck lamp with a CFL bulb to illuminate the work surface. It does make a difference. I also show you how I made sure the blade and the left stop are at 90.00 degrees. Use all the care you can muster to get it right the first time.



Figure 103: Enco Shear on Workbench.

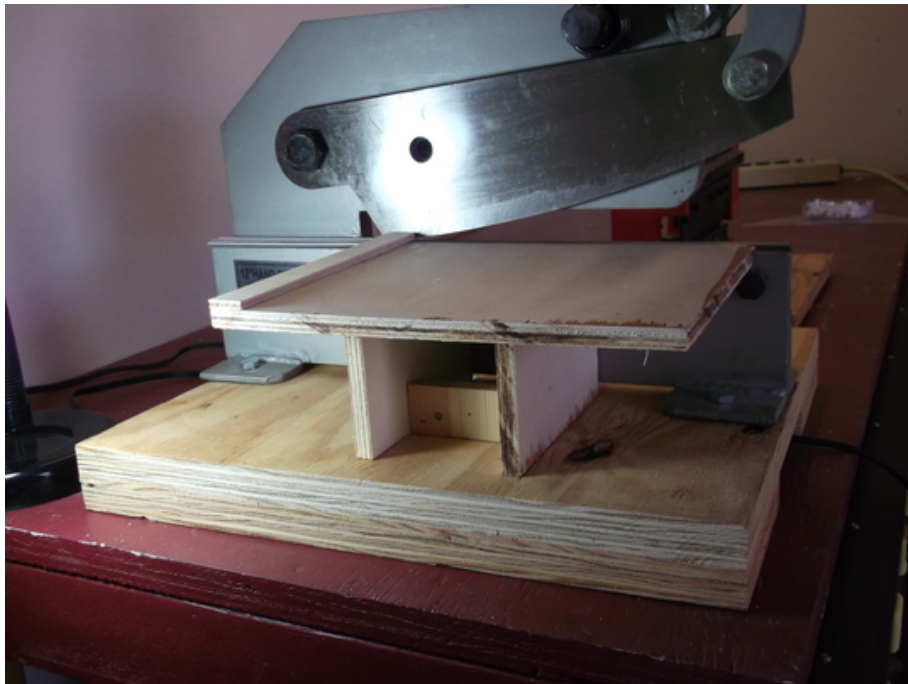

Figure 104: Enco Shear on Workbench.

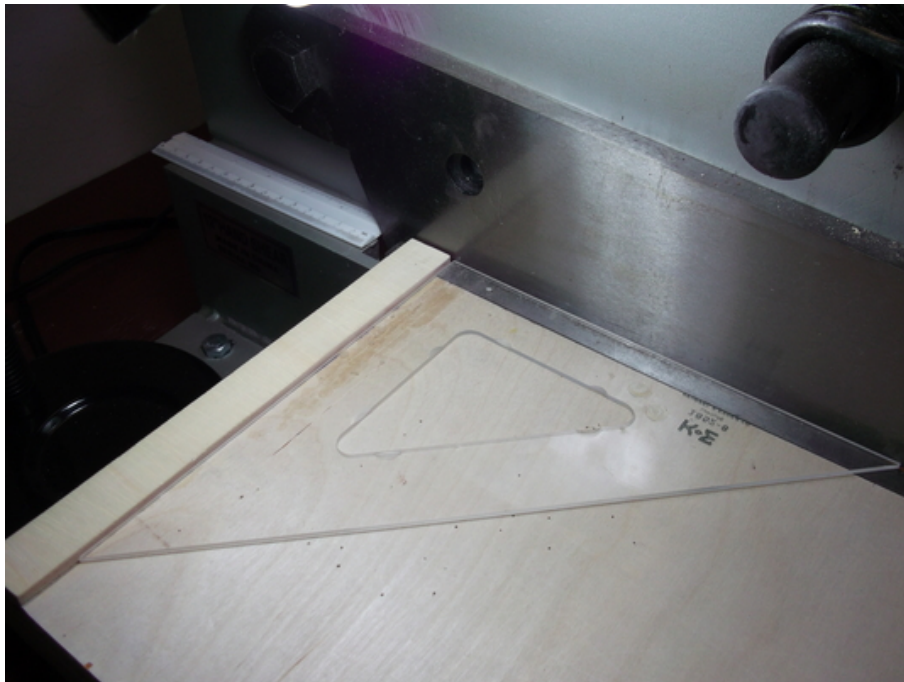

Figure 105: Enco Shear with Right Triangle.

One more thing to demo. When cutting board material, since I have a plywood platform to work on, I use large tacks to hold the bottom edge and right hand edge of the board steady against the torque forces generated by the blade. I can guarantee you that you will love this idea after trying to hold a board by hand and seeing just a smidge of a curve in the cuts that you get.

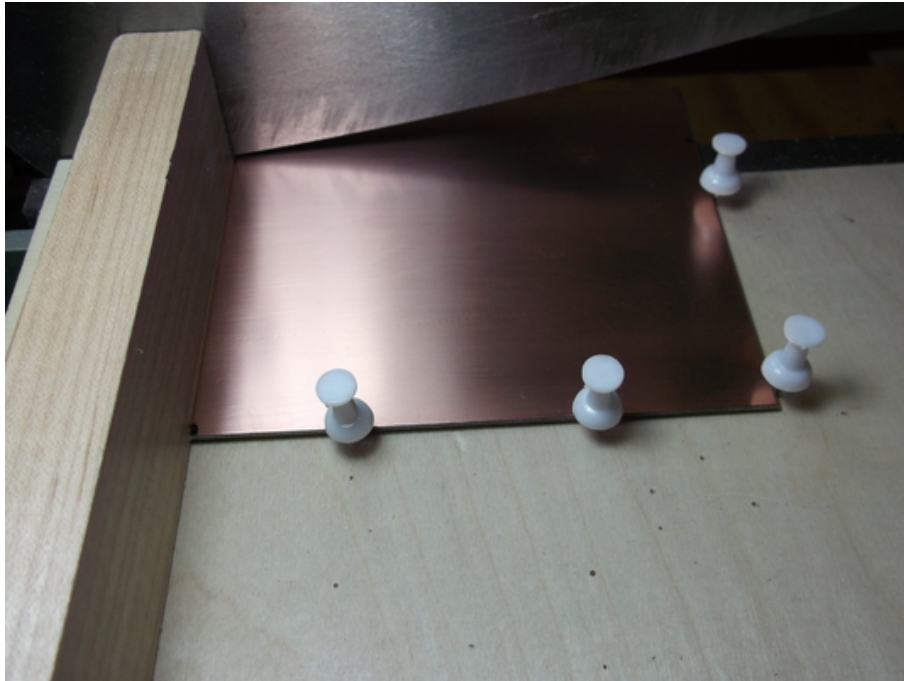

Figure 106: Tacks to Hold Material in Place.

I'll demo just how well this system works for me. It makes a nice clean cut of any PCB material and it cuts like a hot knife through butter, as the saying goes.

Here is a photo showing the end of the mounting board. I have added bottom pieces for clearance of the mounting bolts to keep the off the desk and marring the already scarred paint job. Also a shim, made of PCB material, is used to set the shear 90 degrees to the table surface for the addition of the support table for cutting PCB to size.



Figure 107: Enco Shear SKU 130-5700 at use-enco.com.

10.1 Same width cutting technique

Here is a quick and dirty way to cut PCB material to the same width. Using a right angle clamped down to the working platform that I built with the distance measured from the blade (when in the down position) to the face of the right triangle, I am pretty much guaranteed matching pieces. I measured and the deviation was less than 0.005" from end to end. A light touch up with sandpaper and sanding block will make the deviation even less if done carefully enough.



Figure 108: Right angle clamped down on working surface.

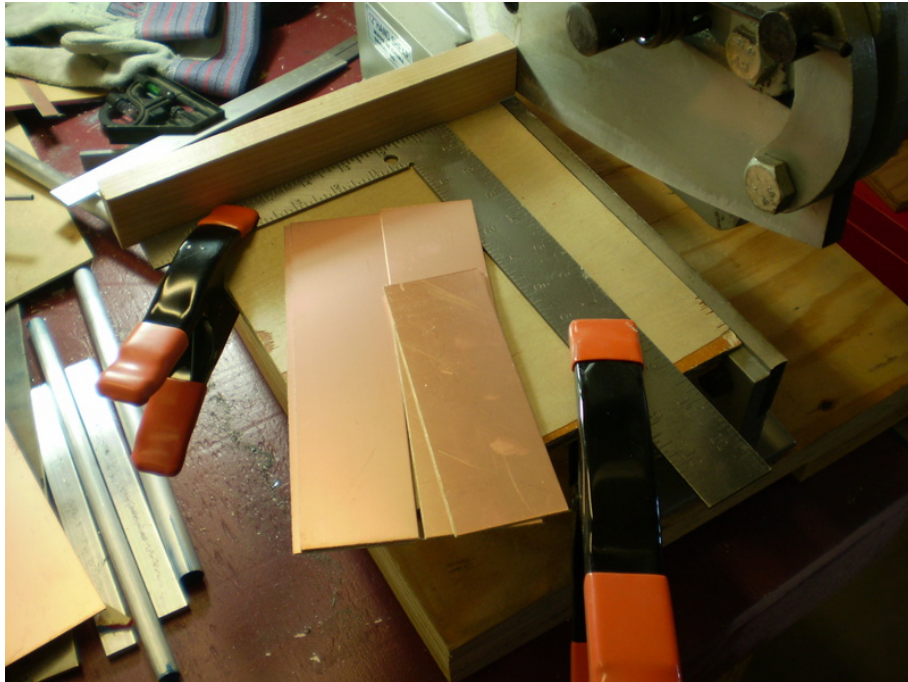

Figure 109: Number of pieces all cut to same width.

Chapter 11

Enclosures made from PCB material

This chapter will deal with the art and science of making enclosures cheaply and safely from PCB material. The money that we spent on the shear is more than made up for in the making of PCBs for circuits but also in the making of enclosures.

11.1 PCB Enclosure Fixture

The first thing you need to fabricate is a fixture for holding PCB material in place while soldering. For this I use half-inch plywood and I made the following fixture. I used no ruler in the fabrication of this device. It is not rocket science.

I did use a right triangle to make sure the angles at intersections are 90.00 degrees to each other. Scrap material will do nicely. You will note that the center piece is not at an end, but at an odd spacing between the other support edges. Two reasons for this.

One. To allow the use of clamps to hold boards in place. See the photo third in this sequence.

Two. The smaller corner space is used to make typical sized enclosures for QRP projects. The larger may be used in the future for larger enclosures for antenna couplers with large capacitors and a roller inductor.



Figure 110: Fixture for PCB Enclosure building.



Figure 111: Fixture for PCB Enclosure building.



Figure 112: Fixture with clamp from Home Depot tool department.

11.2 How To Solder PCB Material

In this section I will show you how I solder boards together and build a test setup or an enclosure. It is simple, fast, painless and very reproducible. You may think I am OCD, but that is not the case. I am just doing things that are repeatable, time after time and day after day. It looks neat and doesn't cost that much in time or materials.

I have taken a random piece of PCB material. Shown here in this photograph.

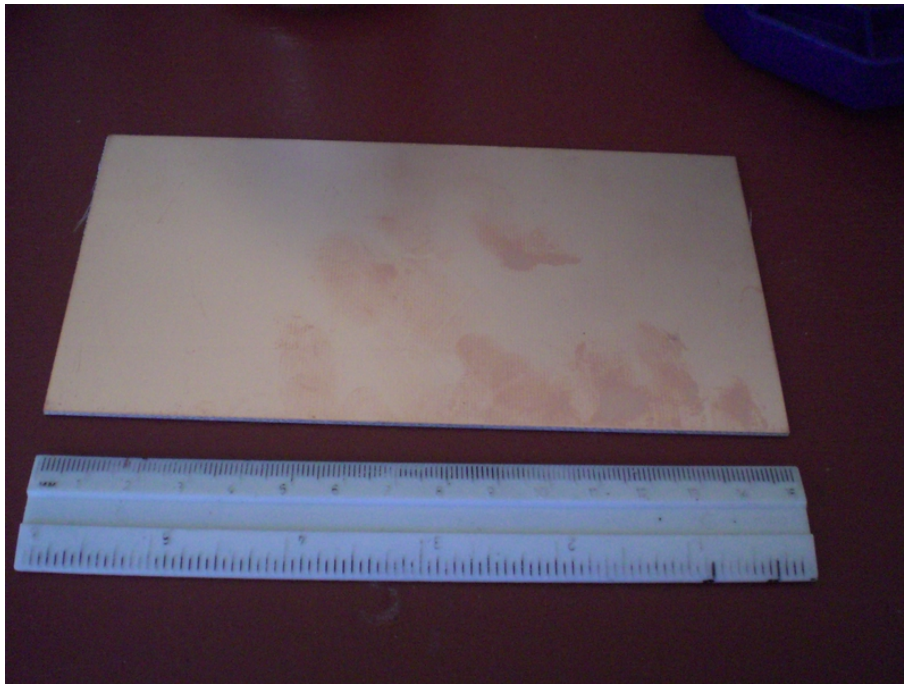

Figure 113: PCB material for test build.

I then use the 3M pad to remove the layer of oxidation and finger prints from the board surfaces. This board is double sided (DS) FR-4 material of thickness 0.040".

If I was really doing an enclosure, I would put a light layer of clear Krylon on both sides and bake in a toaster oven in the garage or outside for an hour. Remind me later to show you why you should save scrap PCB material. I use the PCB scrap material to make some standoffs to hold

wet boards up from the lower surface while baking in the oven. I do not recommend using the inside oven in the house for baking paint. It is dangerous and it is nasty and stinks up the rest of the house. Be kind to others that live around you.

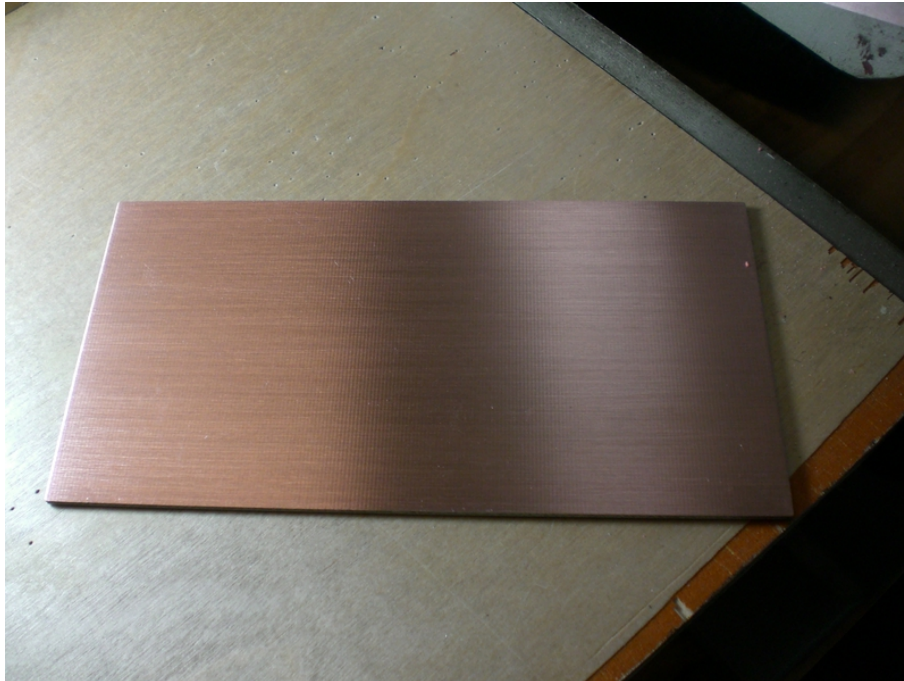

Figure 114: PCB material cleaned up nicely.

11.3 Matching Lengths

Here is a trick that will save you some time. I am going to cut the sample board at a random place, thus:

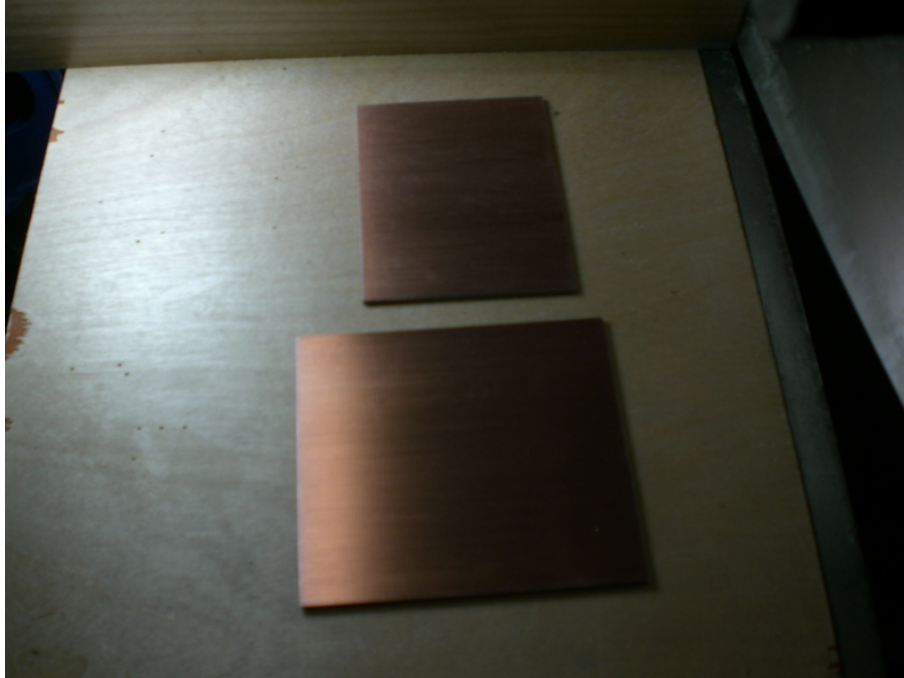

Figure 115: Two PCB pieces to be matched.

First, place the piece to be matched up against the lowered shear blade and against the right angle stop at the back. Use another PCB piece or board that is cut exactly at 90 degrees between the back and the right hand edge and put this against the piece and clamp it down as shown.

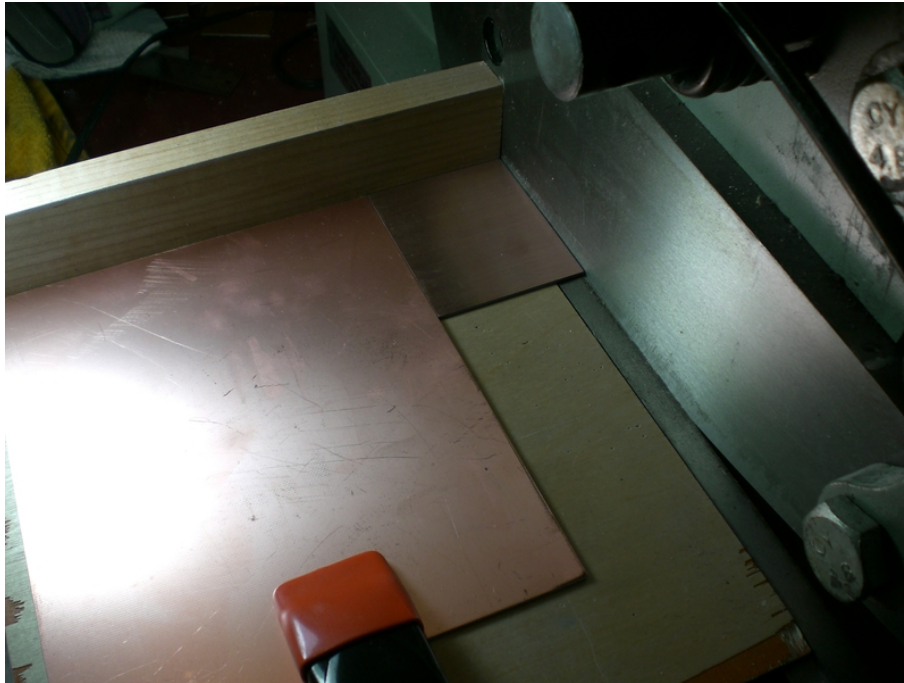

Figure 116: First piece in place.

Now put the piece to be matched flush up against the first piece and flush against the left side. Now you see that the blade is going to miss the first piece but cut the second piece exactly the same width. Important to hold all the pieces in place as firm as possible while doing this to prevent rotation when the shear cuts the edge.

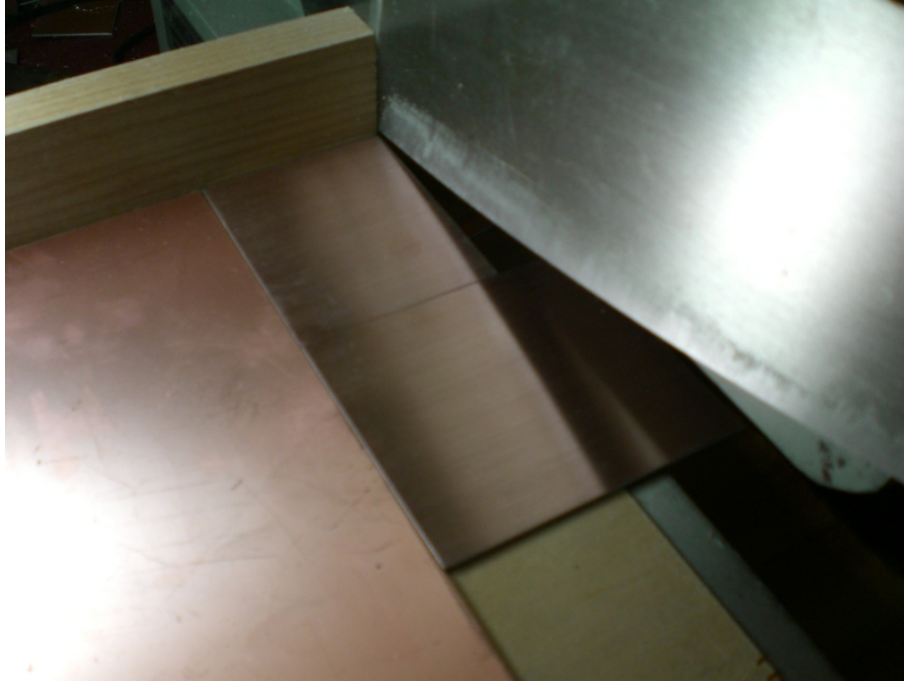

Figure 117: Second piece to be cut in place.

The nice thing about this technique is that you do not have to stop and measure, use a marker and ruler and right angle to mark where to cut. I am guaranteed to get an almost exact match. A light touch of sandpaper on the edges afterwards to remove rough edges. Be careful and not sand an uneven angle into the mix.

After cutting the second piece I now have two matched pieces. Picture does not do justice because of the shadowing.



Figure 118: Matched PCB material pieces.

Here is a piece of wire in place against the edge of the PCB fixture. What this will do is get a 90 degree angle on the two pieces soldered



Figure 119: Wire spacer in place.

together to allow for the shrinkage when the solder cools, otherwise the angle will be slightly less than 90 degrees. Try it out if you want to see what happens.

I now clamp the vertical piece in place against the wire on the bottom edge. Note that I have placed three marks on the board where I am going to solder it to the second board. You can do this with a ruler to get even spacing on the solder joints. OCD?

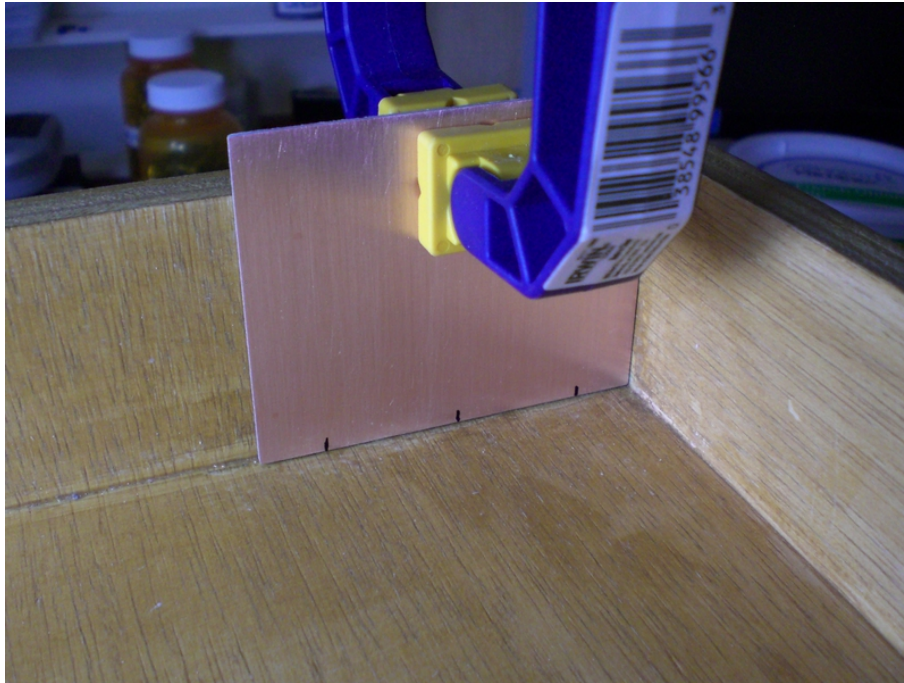

Figure 120: PCB material clamped in vertical position.

Now I clamp the bottom piece into place. I sometimes put a third clamp on the right hand side to prevent the bottom board from bowing upwards when the solder cools, as it will exert a high torque on the board and may get it to decrease the angle between the boards.

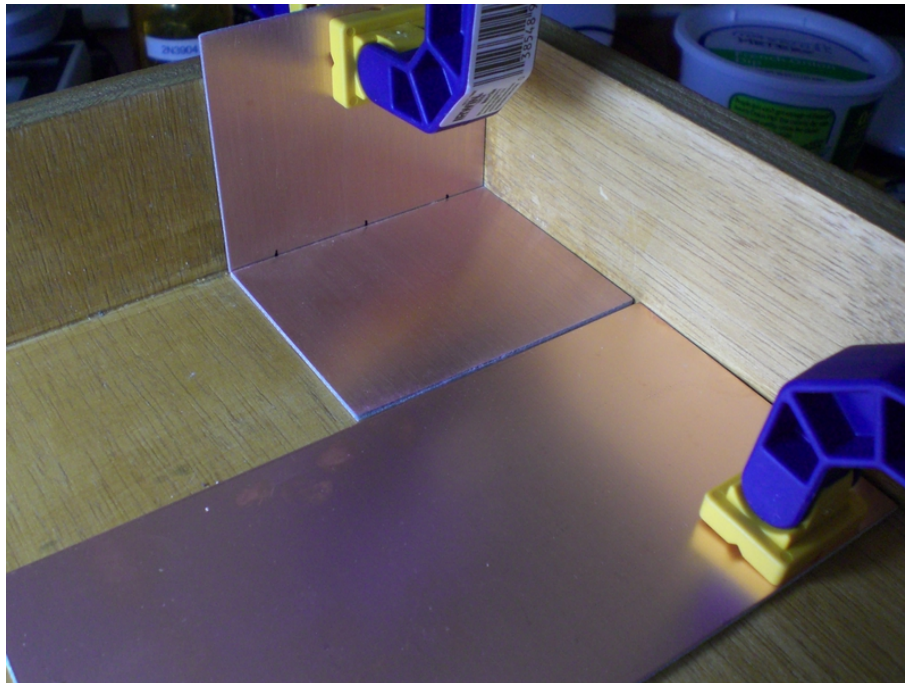

Figure 121: Bottom piece clamped into position.

I use a Weller soldering gun that is over 50 years old and still working to do the soldering. I put the tip at the marked points, heat it up and feed solder to the joint. I DO NOT move the tip back and forth to spread out the solder. I measure out the same amount of solder (or close to it) for each joint and pull the iron away from the joint at 45 degrees to the intersection. Trying to reproduce the same joint every time.

Here is what the finished soldering job looks like.

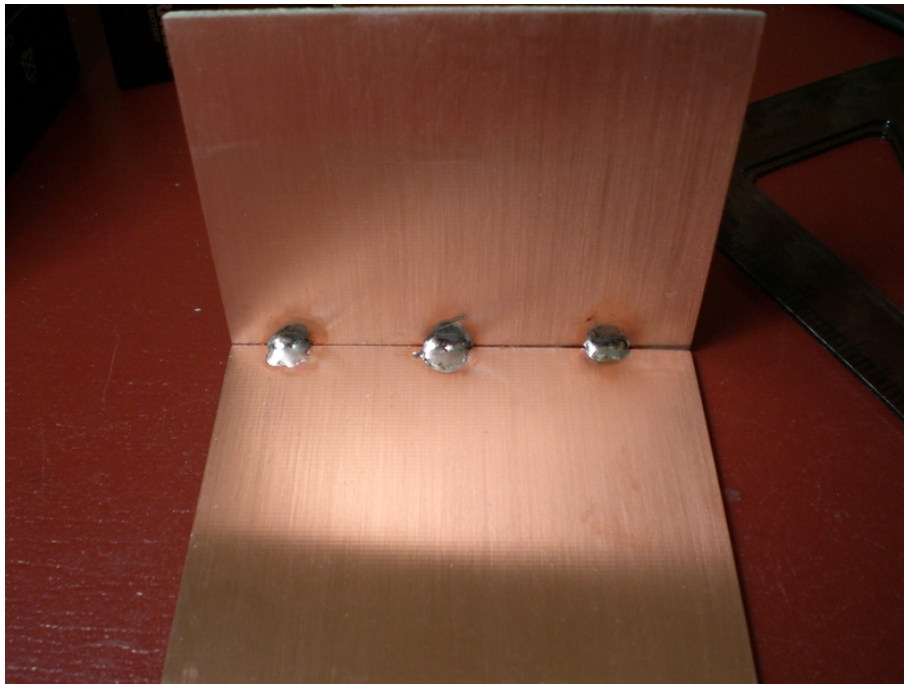

Figure 122: PCB material soldered together.

Here it is from the side showing the resulting 90 degree angle of intersection.

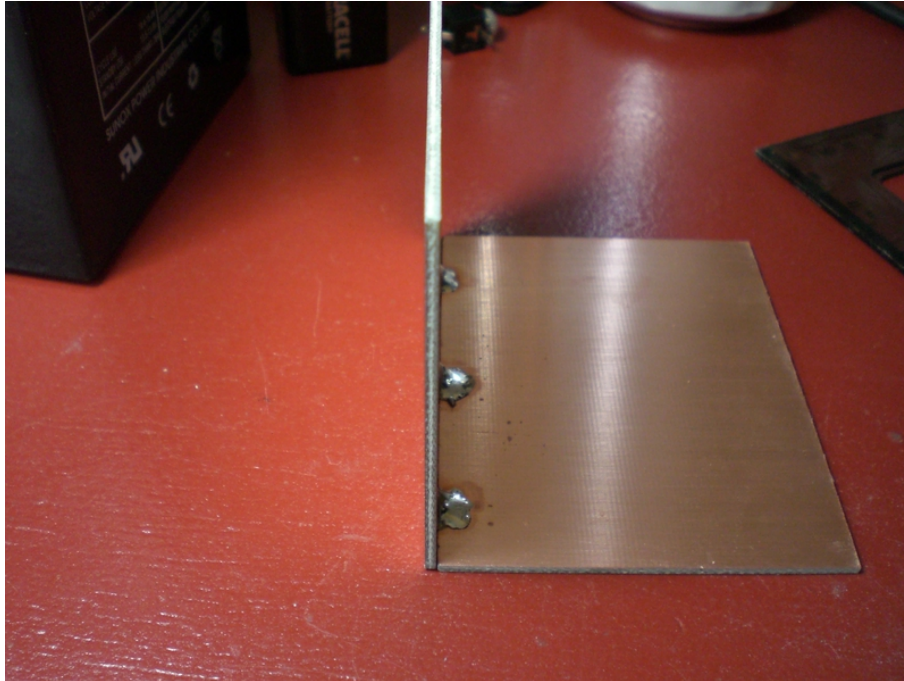

Figure 123: Right angle joining of the two boards.

Front view showing even matching at the bottom.



Figure 124: Front view of resulting structure.

Please note. I screwed this up. I did not put the two edges that I matched together, but did the side edges. One of the edges was an edge that I did not cut and as it turns out it was slightly off. Won't happen again. OK, maybe one more time.

But you get the technique and how it works. Try it. You will like it. Takes longer to describe it and write it up. And people wonder why I take so long to update the notebook. :-)

11.4 Simple PCB Fixture

The first thing that you might want to make is a simple two piece setup, let's call it a fixture, that we can build a Manhattan style project on. Here is one that I did for a VXO (variable crystal oscillator) experiment.

Let me show you, with two boards, how to place them to be soldered together. I put one piece in a vertical position against one side of the PCB fixture. Sometimes you have to use a shear to make sure that all sides are at ninety degrees.

The vertical piece in the next photograph is snug against the left hand side of the fixture and against the bottom edge of the PCB material. This makes the bottom PCB plate non-visible from the front face of the resulting structure.

Something that I got for Ken, WA4MNT. Use a piece of wire between the vertical PCB and the fixture to make an angle slight greater than 90 degrees between the bottom plate and the front panel. When soldered, the shrinkage of the solder will result in an angle of 88 to 89 degrees when you unclamp the two pieces from the fixture. I use a number 24 wire with teflon coating. The heat from soldering the two boards together may het normal wiring insulation and melt it to your PCB material.

Or piece of steel piano wire will do the job also.

I also finish the boards with the 3M pad and a coat of Krylon clear spray before I solder the structure together, whether it is a two piece fixture or an entire enclosure.

Here are some photos to show you what I mean.

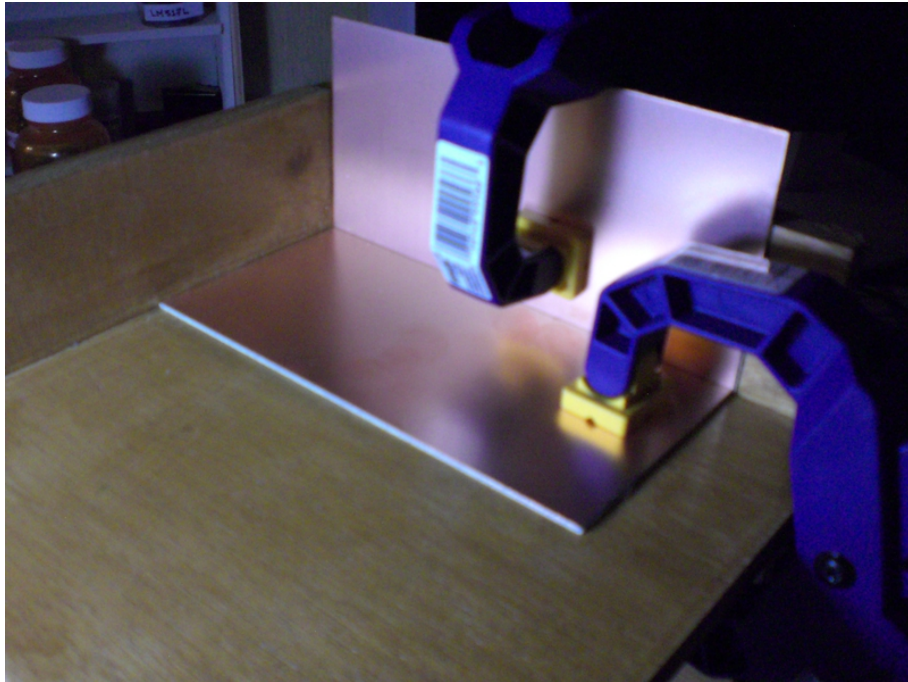

Figure 125: Fixture with clamped PCB pieces.



Figure 126: Two Piece fixture to build Manhattan project on.

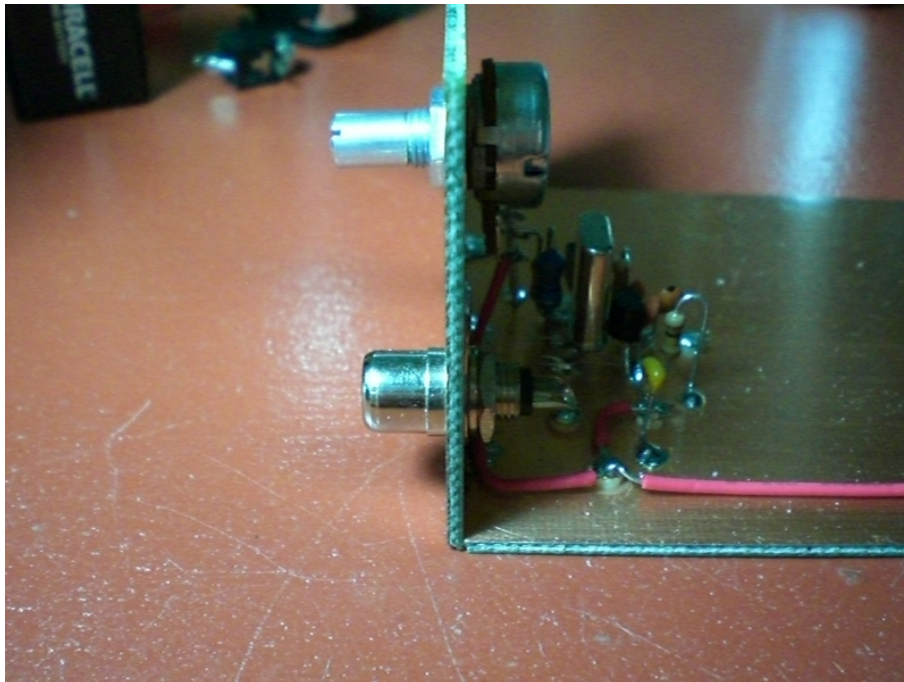

Figure 127: Here you can see the 90 degree angle.



Figure 128: Fixture front showing that lower plate is hidden from view.

Chapter 12

Digital Multimeter Impedance Measurements

I have shown this numerous times on the old grp-l list and the newer and improved grp-tech list on the Web.

I have four digital multimeters (DMMs) that I use from time to time on the workbench. Most likely you own one of them. It is the one that Harbor Freight gives away in a newspaper advertisement from time to time or a flyer you got in the mail.

This meter you immediately recognize as the one from Harbor Freight. Their item number #98025 and they use it as a loss leader to get you into the store by giving it away. Or they will put it on sale for three bucks or so.



Figure 129: CEN-TECH Digital Multimeter from Harbor Freight.



Figure 130: Velleman DVM850BL Multimeter.

This meter I got from Fry's Electronics here in Phoenix AZ. It was under \$30. Not sure about the price at the time I bought it on sale.



Figure 131: Protek D-930A Digital Multimeter.

This was a \$40 multimeter that I bought at Fry's Electronics many years ago on sale for \$10 and I bought 3 of them and it is the best meter I have. As you will see later in the measurements.

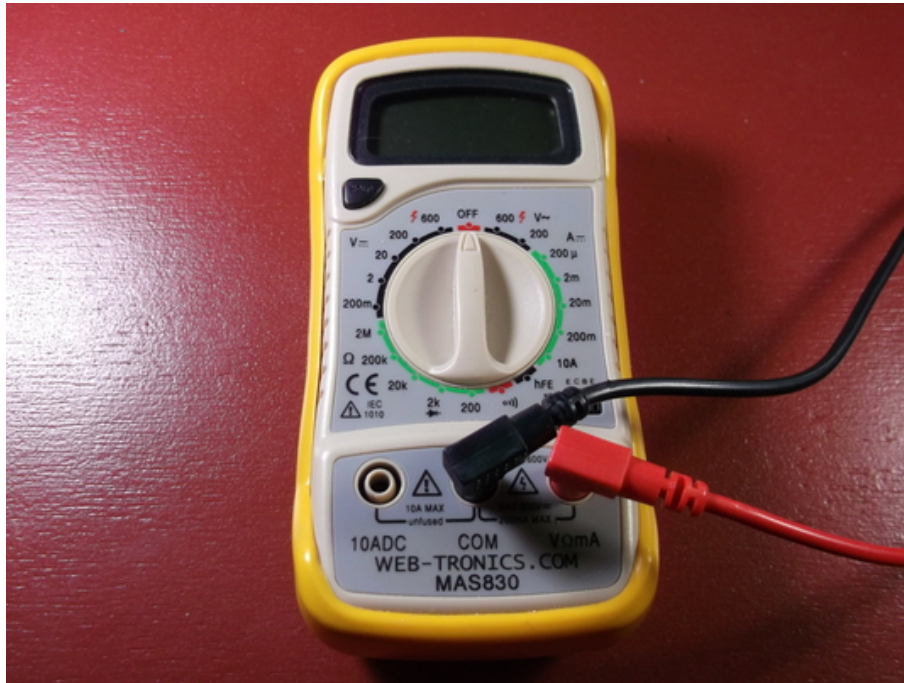

Figure 132: WEB-TRONICS.COM MAS830 Multimeter.

I got this meter at a place in Mesa AZ, a long distance from where I live now. Circuit Specialists and they have a presence online with their web site.

12.1 Voltage Measurement

Put your meters in the voltage mode for the following voltage measurement. I do not want you to blow an internal fuse doing this measurement. You know what I mean.

Get a good 9V or 12V battery for this experiment. Use each of the meters that you want to measure the impedance for and use each to measure the voltage of the battery. Record this number and label it as V_B for the voltage of the battery.

Here is what I get for each meter measurement.

Voltage	Meter
9.69V	Velleman DVM850BL
9.59V	CEN-TECH
9.67V	WEB-TRONICS.COM MAS830
9.70V	Protek D-930A

Note that three of the meters are extremely close to each other in the values and the cheap CEN-TECH meter isn't too far off in its measurement.

12.2 1M Resistor Measurement

Now put your meters in the resistance mode for the following.

Get a 1M (one megaohm) 1/4W resistor from your parts stock. If you don't have a 1M, then get the highest value you have close to one megohm.

Use each of the your meters to measure the resistance for the part. Note. Keep your cotton picking fingers off the leads of the meter and the resistor. You will become part of the measurement and mess up the results. Don't believe me? Measure the resistance with and without your fingers across the meter probes and the resistor. Your body resistance becomes a part of the measurement and you will read a lower resistance with you in parallel with the 1/4W resistor. Ohms law at work. It is the law, so please obey it at all times.

Here are my results. Call the quantity you measure R for the resistor value.

Resistance R	Meter
1.000M	Velleman DVM850BL
1004K	CEN-TECH
1.004M	WEB-TRONICS.COM MAS830
998K	Protek D-930A

12.3 Series Voltage Measurement

Before you go and do the following, put the meter back in the voltage mode.

Now, using the battery, the resistor and each meter in turn. Measure the voltage with the plus lead (red) of the voltmeter to the positive terminal of the battery, the negative lead (black) of the meter connected to one end of the 1M resistor and the other end of the resistor to the negative post of the battery.

Write down the voltage reading of the meter. Call this quantity V_m for the voltage across the meter.

What you are doing here is putting the resistance of the meter (the impedance, if you will) in series with the resistor and applying a voltage, V_B , the voltage of the battery across the two. The meter will measure the voltage drop across itself, the voltage across the two meter leads.

Here are my measurements for each of the meters.

Voltage	Meter
4.84V	Velleman DVM850BL
4.79V	CEN-TECH
4.83V	WEB-TRONICS.COM MAS830
8.75V	Protek D-930A

12.4 Impedance Calculation

Now, for every meter that you are testing. Do the following calculation using the following formula.

$$R_m = R \times \frac{V_m}{V_R} \quad (12.1)$$

You get this from Ohms law. The current through the series circuit is I . The voltage drop across the resistor and the meter is equal to the product of the current I and the resistance of the element. Since, I is

the same then:

$$I = \frac{V_R}{R} = \frac{V_m}{R_m} \quad (12.2)$$

Solving for R_m gives you the previous equation. Double check it and make sure you understand it. Draw a circuit diagram. I'll try to get back and do that. Takes time.

Here is what I get for each of the meters. Let me make a table showing each value so that you can concentrate here. Get out your calculator and double check my results. I have made mistakes before. Use the values measured by the meter for the calculation. Do not mix values measured by other meters or you will the results totally wrong. Trust me.

V_B	V_m	$V_R = V_B - V_m$	V_m/V_R	R	R_m	Meter
9.69V	4.84V	4.85V	0.998	1.000M	0.998M	Velleman
9.59V	4.79V	4.80V	0.998	1004K	1002K	CEN-TECH
9.67V	4.83V	4.84V	0.998	1.004M	1.002M	WEB-TRONICS
9.62V	8.75V	0.87V	10.057	998K	10037K	Protek

OK. Why is the Protek the best meter. It has the highest internal resistance, 10M, thus making it having a lower affect on measurements in operating circuits. We will investigate that in the next chapter. You need your meter values to do the next muppet experiment.

I will also show you why a lot of circuits in the literature in the 21st century is wrong and is a carry over from the days of old by not taking into account current impedances of meters. Should be fun. If you have an old Simpson meter, do the above. You should get a number on the order of 200K ohms, maybe even less. Those that swear by the Simpson are misguided souls and I hope you are not one of them. Especially in working with solid state devices and circuits.

12.5 Velleman DVM1100

After the writeup in this chapter, a very good friend of mine in East TX saw it and sent me a brand new Velleman DVM1100 meter. He uses one all the time and loves it.

So, in the spirit of fair play, I took it and made the same impedance measurement and calculations and find that the Velleman DVM1100 has an input impedance of 10.08 megohms.

Here is a picture of it and I too am getting to use this meter quite a bit. It is the first meter that I have gotten that came with a set of alligator clip leads at the end of the leads with the banana plugs for connection to the meter. Very handy indeed. I'd bet that Radio Shack probably sells a similar set in their connector bins.

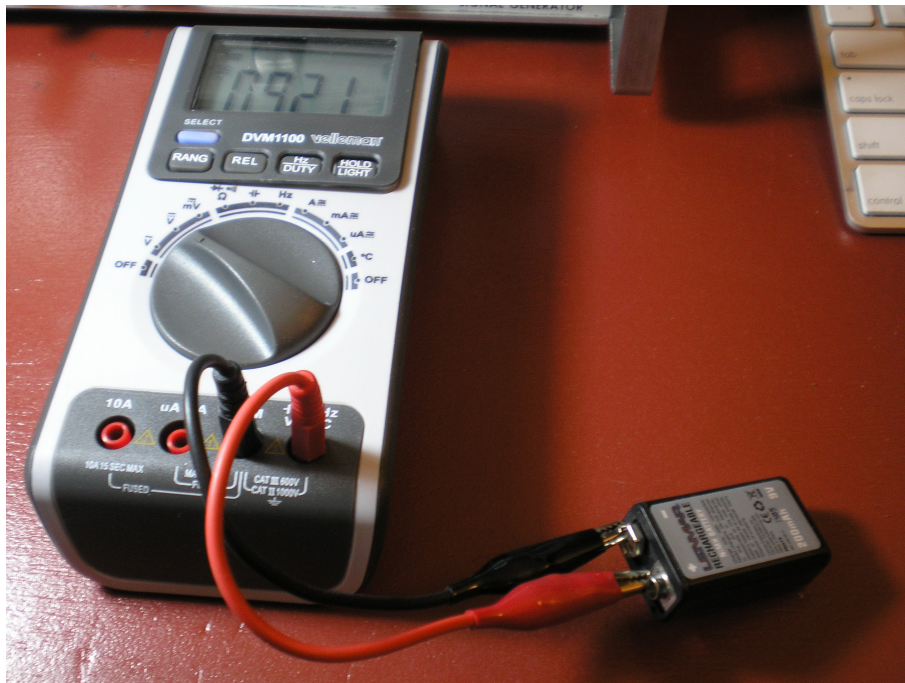

Figure 133: Velleman DVM1100 Digital Multimeter.

Chapter 13

DMM Calibration

One of the things that you want to be sure of in a experimental electronics lab is that when you measure something, the quantity that you measure is both precise and accurate.

For the purpose of accuracy you need a standard by which you can test your DMM. Such a device is available at a reasonable price from <http://www.voltagestandard.com/>. Here are two photos of the top of the device.

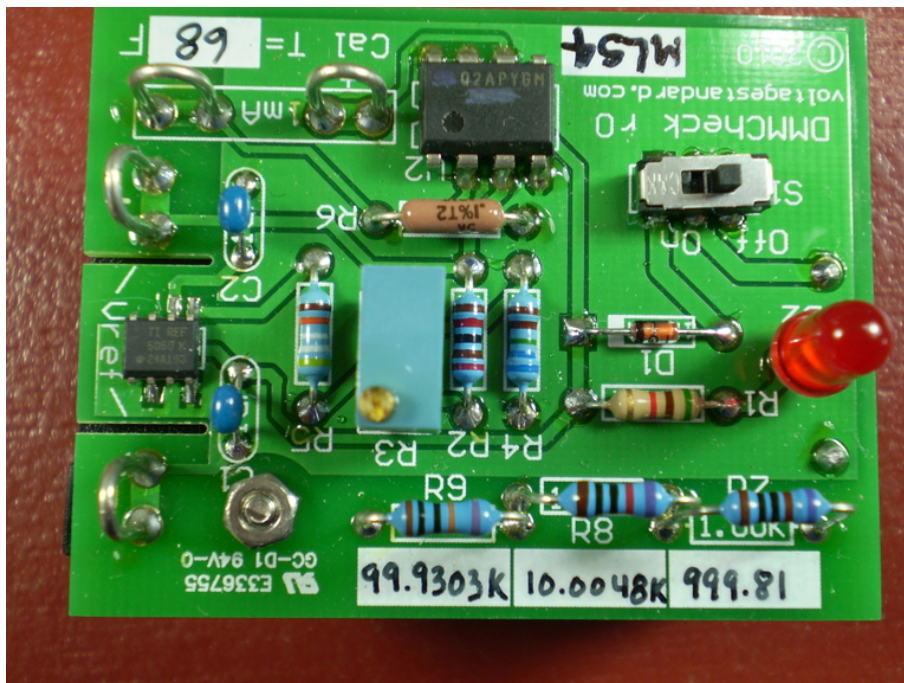

Figure 134: DMM Check System.

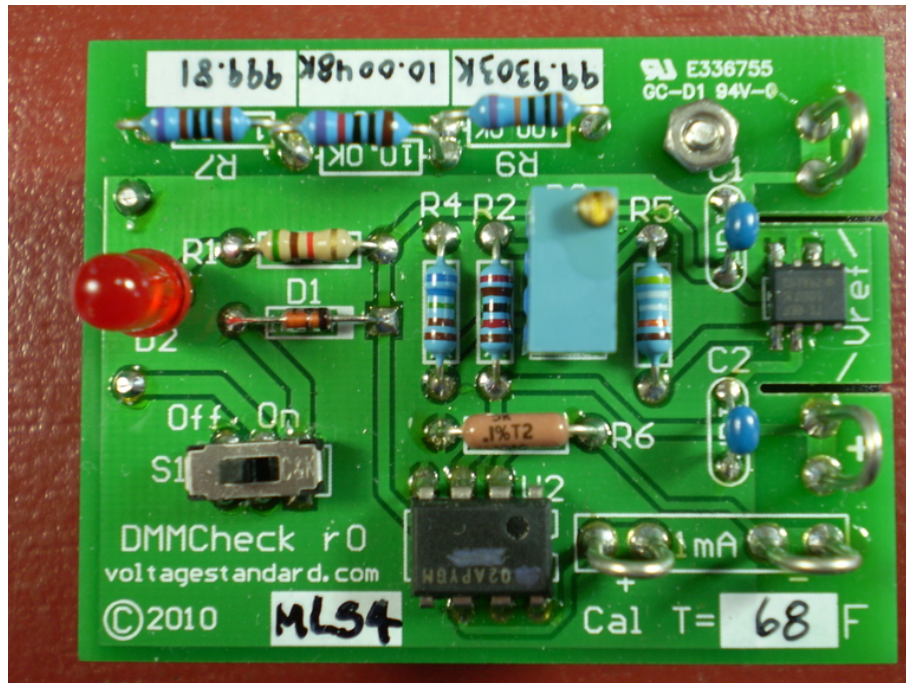

Figure 135: DMM Check System.

The device has terminals for different functions.

One is for the output of an accurate 1.0000mA current. The following three photos show the Velleman DVM1100 DMM connected and the result of measuring the 1.0000mA in the μA and mA scales.

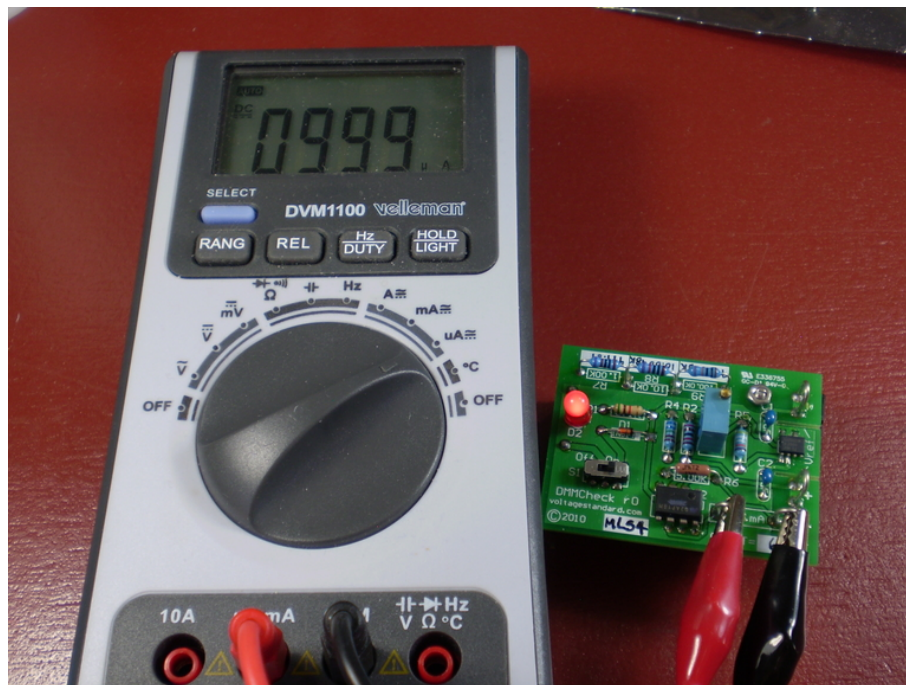

Figure 136: Velleman in μA scale.

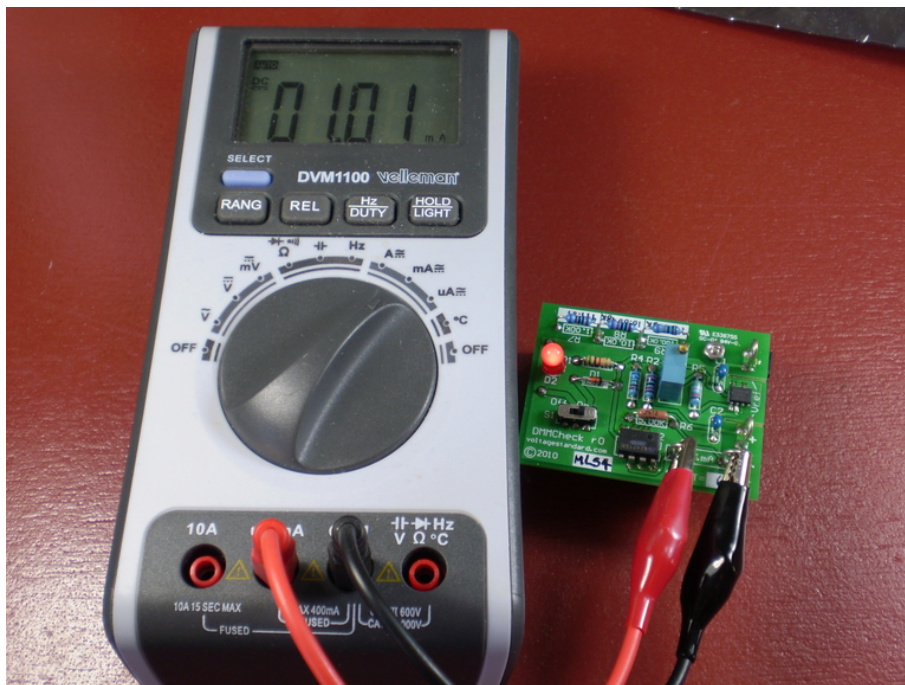

Figure 137: Velleman in mA scale.

There is a 5.000V voltage reference using a TI precision IC and calibrated by the vendor using HP high dollar test equipment. You can also get the instrument recalibrated every few years for making sure that you have a quality lab reference for serious work.

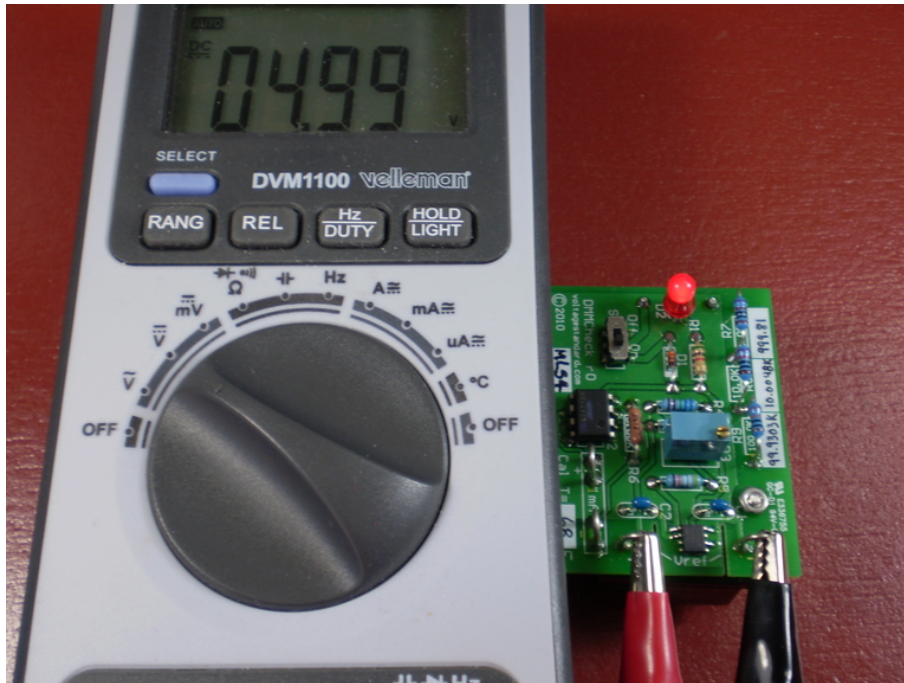

Figure 138: Velleman reading voltage for 5.000V in.

And last, but not least, are three resistors that have been read with an HP resistance meter to N places, where N is large and marked on the DMM Checker. The three on mine are measured at 999.81Ω , $10.0048\text{k}\Omega$ and $99.9303\text{k}\Omega$. As you can see the Velleman does a great job.

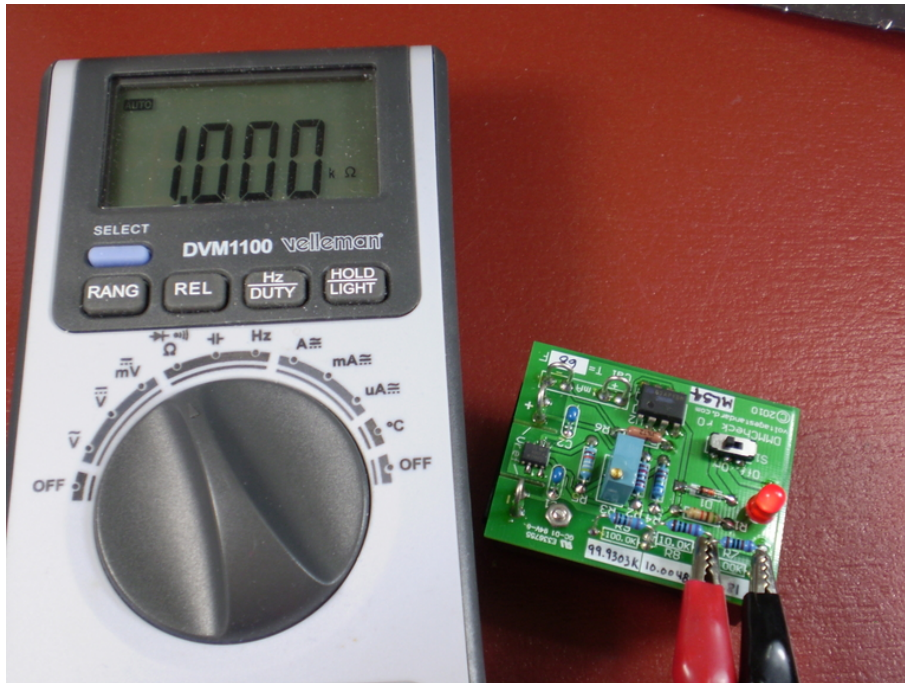

Figure 139: Velleman reading resistance for 999.81Ω .

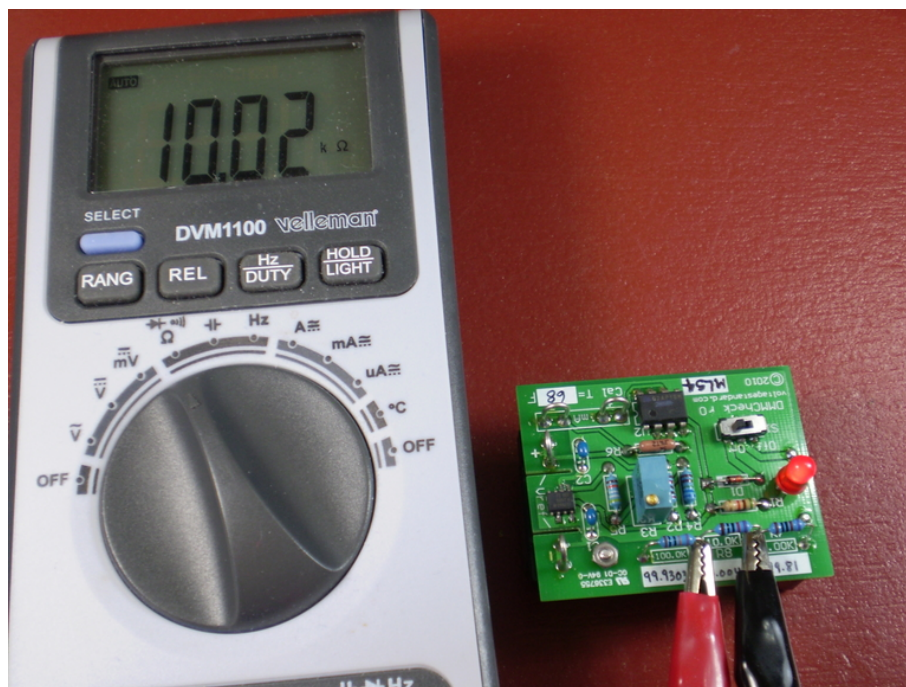

Figure 140: Velleman reading resistance for 10.0048kΩ.

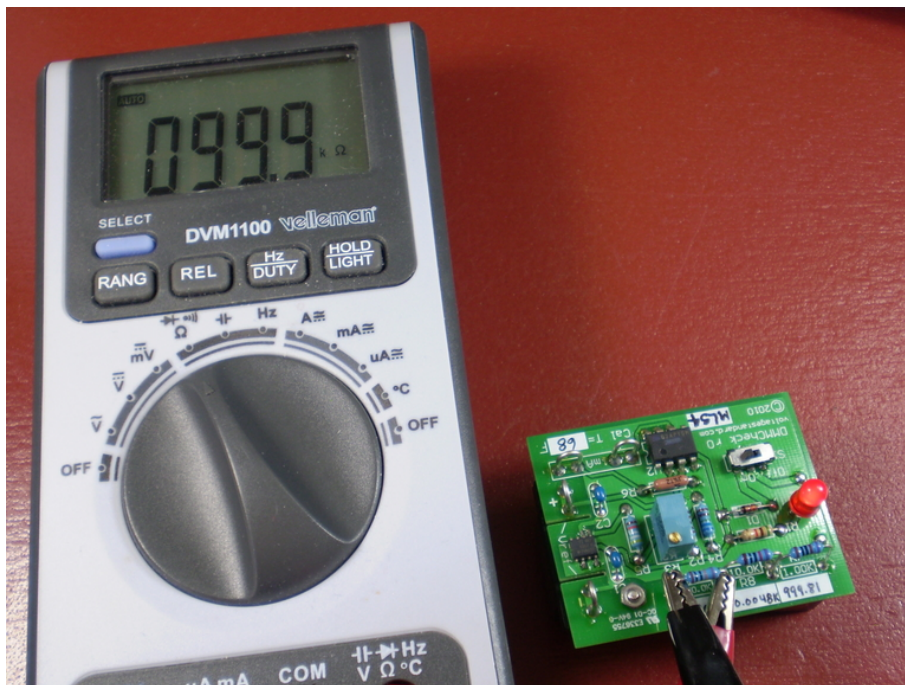

Figure 141: Velleman reading resistance for 99.9303k Ω .

Chapter 14

RF Measurement Techniques

In this chapter we will look at how to measure RF signals. We will make every attempt to make devices from scratch and show their limits and their strong suits.

14.1 Baseline Measurements

Let me first start with a set of baseline measurements that I do not expect you to make unless you have the lab equipment to do it. This requires some equipment that the majority of radio amateurs do not have. It is not expected, it is not needed and it may be expensive to have this equipment and some of the equipment is hard to come by, as you will see.

I will start out with two instruments that I am very fortunate to own. The first is a Wavetek Model 3010 signal generator. It is capable of generating signals in the KHz range up to 1.0GHz. I call that from DC to Daylight, in that it covers a large portion of the LF and HF frequencies that radio amateurs operate in and have equipment to do so.

The second instrument is a Hewlett Packard (HP) 3400A RF voltmeter, but it only covers up to 10MHz in its specs. Above that, there are no guarantees. Implied or otherwise. Here is a URL for the manual of the instrument online.

HP 3400A manual.

Here is a photograph of the HP voltmeter sitting on top of the Wavetek.



Figure 142: HP 3400A on top of the Wavetek 3010.

Also, for those of you in the audience that may be too young to know this. On the good analog meters, there is a mirror behind the needle. Here is a photo up close and personal.

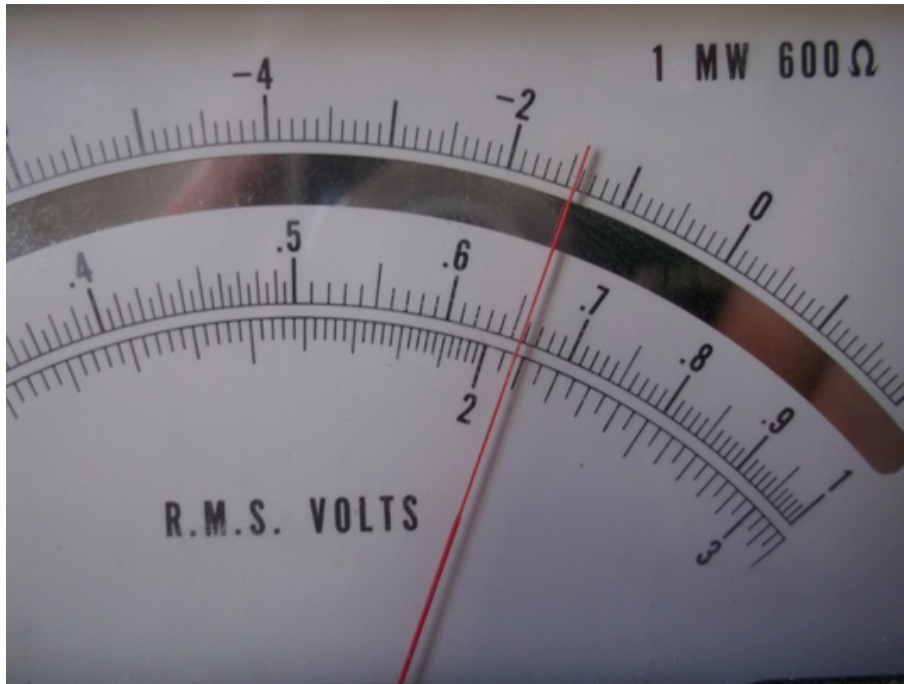

Figure 143: HP 3400A Meter Up Close.

Note, that the camera is pretty much aligned with the 6 on the scale. I can tell by the reflection in the mirror. Look at the red needle and its reflection in the mirror. You can see two images of the needle, the needle itself and its reflection. This means that if I try to take a 'reading' of the value, it will be absolutely wrong. You need to line up the needle and its reflection so that you can not see the reflection and while holding this position, then write down the value that the needle is sitting on for the scale. If the needle is between marks, then you estimate the fraction of the distance between the lower mark and the next mark positions on either side of the needle. It takes practice.

I got the Wavetek on ebay for \$317 including shipping and I lucky that I got a guy who refurbished it and loved doing it and did it with pride. It looks brand new and was well packed in shipping. I hear horror stories of hams that have bought equipment and the person shipping the equipment did not bother to shield the equipment from hard handling by the shipping company involved. Come on. Let's treat each other and our equipment with respect. This is the age when we are supposed to be educated and thoughtful.

14.2 Response Curves

Response curves, also known as bandwidth in some conditions, is the measured value of some electrical property over a range of frequencies. I am interested in the response of the HP voltmeter from 1MHz to 10MHz and above.

It is also somewhat dependent upon the output of the signal generator. The signal generator expects a load of 50 ohms. The HP voltmeter is calibrated for 600 ohms, so there is a mismatch.

I'm am just going to put a 50 ohm, non-reactive load which means 50 ohms resistance with no inductive or capacitive component, on the output BNC connector of the Wavetek and connect to the HP direct through a small length of 50 ohm coax.

I can not, and you should not expect, under these circumstances expect the HP to measure the correct output voltage of the Wavetek. But, since the Wavetek is looking at a load very close to 50 ohms, it should hold its output amplitude constant. This also assumes the Wavetek is in good

condition and is working properly, so we have two unknowns here, but we will know soon enough just how well things are working.

So, I got the following data. I am showing it here so you will see what I am doing and can repeat it in whatever you do.

Frequency	HP Voltage Readout
1.000 Mhz	0.205V
2.000 Mhz	0.205V
5.000 Mhz	0.207V
10.000 Mhz	0.206V
12.000 Mhz	0.202V
14.000 Mhz	0.196V
16.000 Mhz	0.188V
18.000 Mhz	0.178V
20.000 Mhz	0.165V
22.000 Mhz	0.151V
24.000 Mhz	0.135V

Here is the plot of the results to give us a visual feel for what is going on. Low and behold how flat the curve is from 1MHz to 10MHz and then the decline afterwards. We can see that the HP voltmeter still responds to an applied voltage above 10MHz, but its value is not to be trusted. We are going to assume here that the Wavetek is indeed outputting a constant voltage as the frequency increases. We will assume this until we determine otherwise.

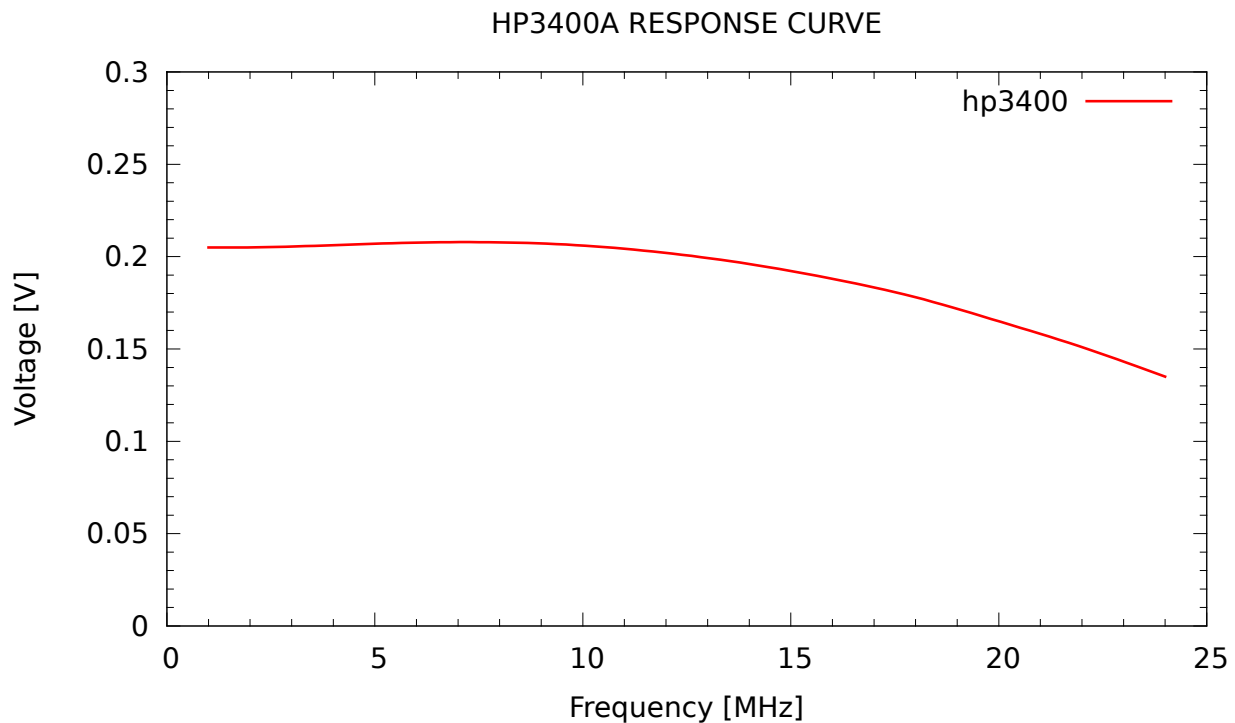

Figure 144: HP 3400A Meter Response Curve.

14.3 RF Generator Calibration Curves

Before getting into some RF probes, I needed to go back through the lab and check out some signal generators and their characteristics.

The first thing to check is the Wavetek 3010 again and also an S&S Engineering old DDS VFO RF generator. Here are the results.

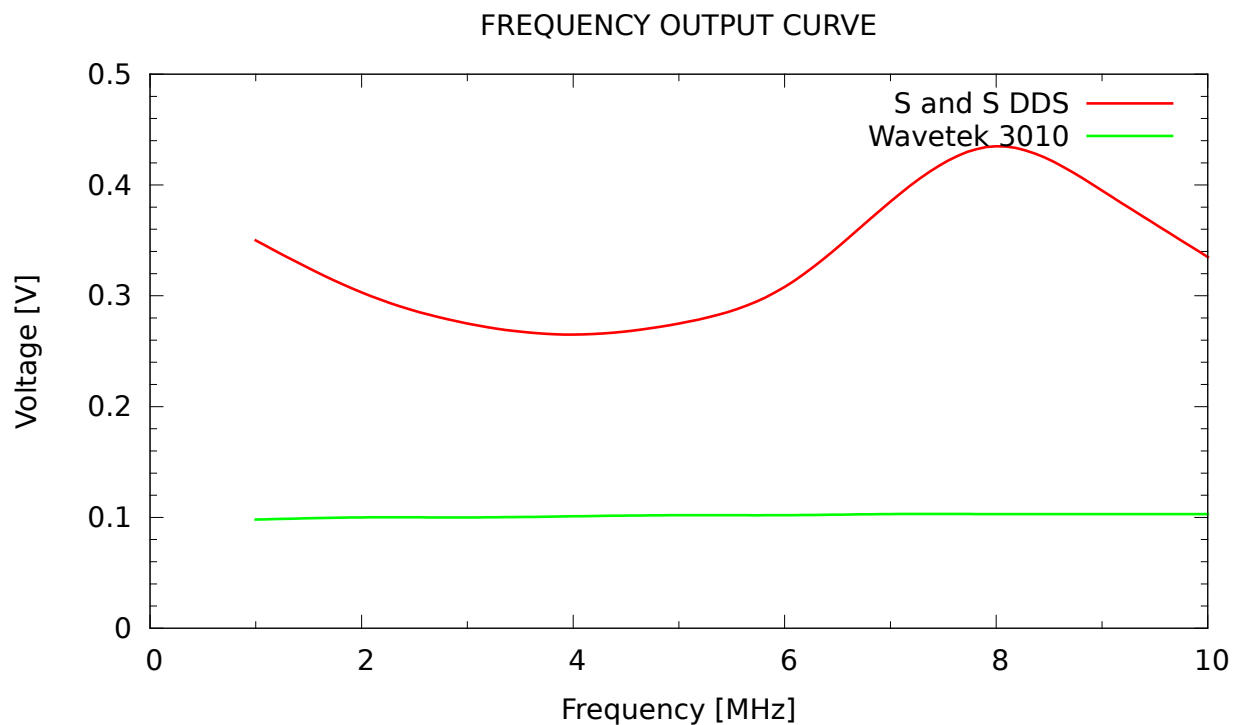

Figure 145: S&S Engineering DDS and Wavetek 3010 Output.

Then, digging into the storage drawer for small pop-corn kits, i.e. kits that are small and do not take up much space and typically are not in fancy enclosures. One of the items in the drawer was an old Nor-Cal FCC-1 and FCC-2 combination of frequency counter and DDS signal generator. I was pleasantly surprised to see just how flat it was from 1.000 to 10.000MHz.

The Boyd RSG-30 was a kit from Boyd Electronics and is no longer being offered. The qrp-tech group has it as a project in the sandbox series but I have yet to see any one attempt it.

The BK Precision 2005A is a signal generator that I got off of Ebay.COM for \$30 US and it needs some tweeking to get it back into specs as it is a very old piece of test equipment and had been dropped. I'll put a picture here later of all the stuff you may not be familiar with.

But, here is the response curves showing the output of each device into a 50 ohm load.

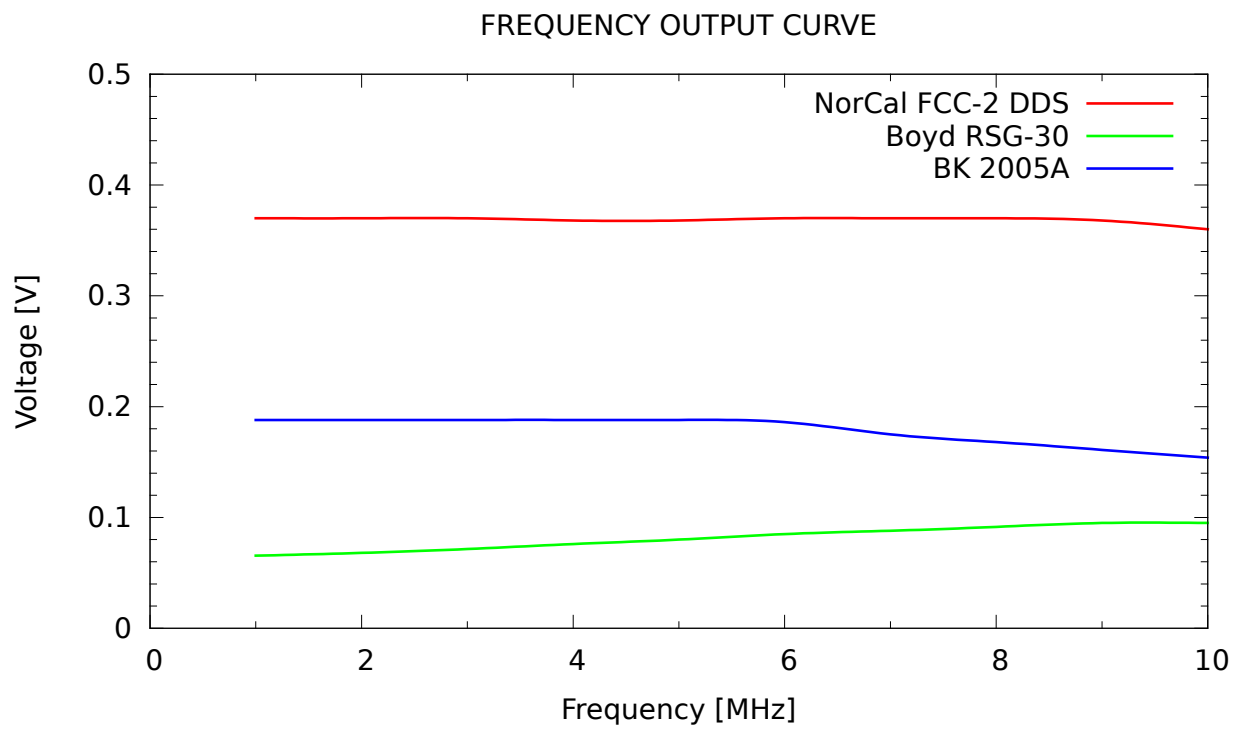

Figure 146: NorCal FCC-2, Boyd RSG-30 and BK 2005A Signal Generators

Chapter 15

Measurements

In electronics, when we measure things, we effect what it is we are measuring. We have to add something to the physical setup to detect some parameter we are measuring whether it be voltage, current or frequency.

15.1 Relative Error

Let the value of a quantity be x and the measured or inferred value x_0 . Then the **relative error** is defined by

$$\Delta x = \frac{\Delta x}{x} = \frac{x_0 - x}{x} = \frac{x_0}{x} - 1, \quad (15.1)$$

where Δx is the absolute error. The relative error of the quotient or product of a number of quantities is less than or equal to the sum of their relative errors. The percentage error is 100% times the relative error.

Dr. Walter Lewin, Professor Emeritus of MIT, in his first lecture on YouTube for a class in mechanics, says that a measurement without some indication of the error range or precision of measurement is useless. This means that when you make measurements or write up an experiment you need to show just how precise your measurements are. The accuracy of a measurement is also dependent upon the calibration

of the measuring instrument(s).

Although amateur radio is a hobby, there is the need to communicate experimental results in an organized fashion. I make every attempt in my writeups to show how I did things in as much detail as necessary for others to reproduce the project or experiment. The goal is not to make something that no one else on the planet can ever do. That is a waste of my time and yours.

Chapter 16

Varactor Diode Characteristics

In this chapter we will investigate the characteristics of variable solid state capacitors that go by several names: varacap, sudden abrupt diodes and other names. They have a common characteristic that their effective capacitance is determined by a control voltage that reverse biases the diode, thus it is non-conducting or has a negligible current flow.

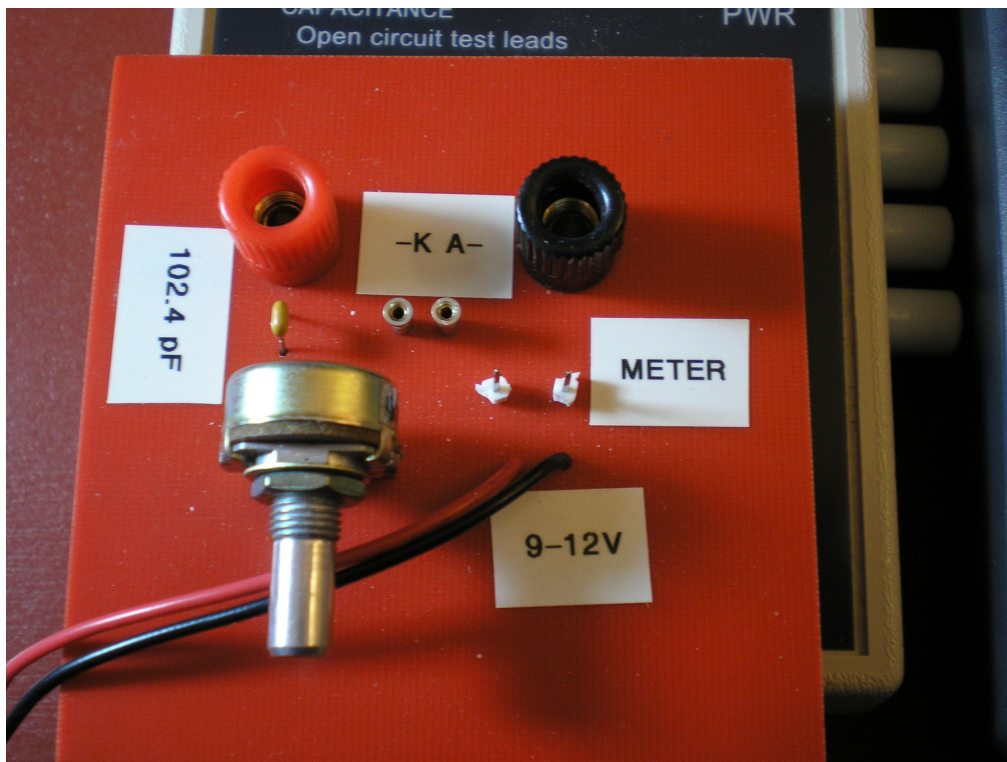

Figure 147: K7QO Varactor Diode Fixture for AADE Meter.

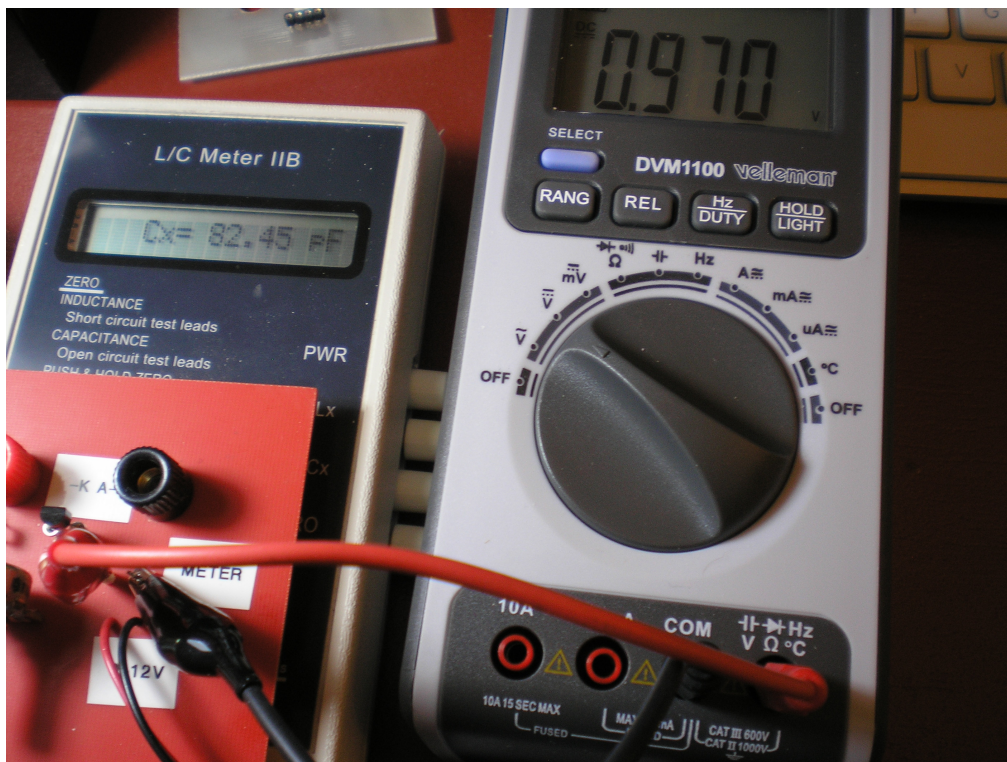

Figure 148: K7QO Varactor Diode Fixture in use.

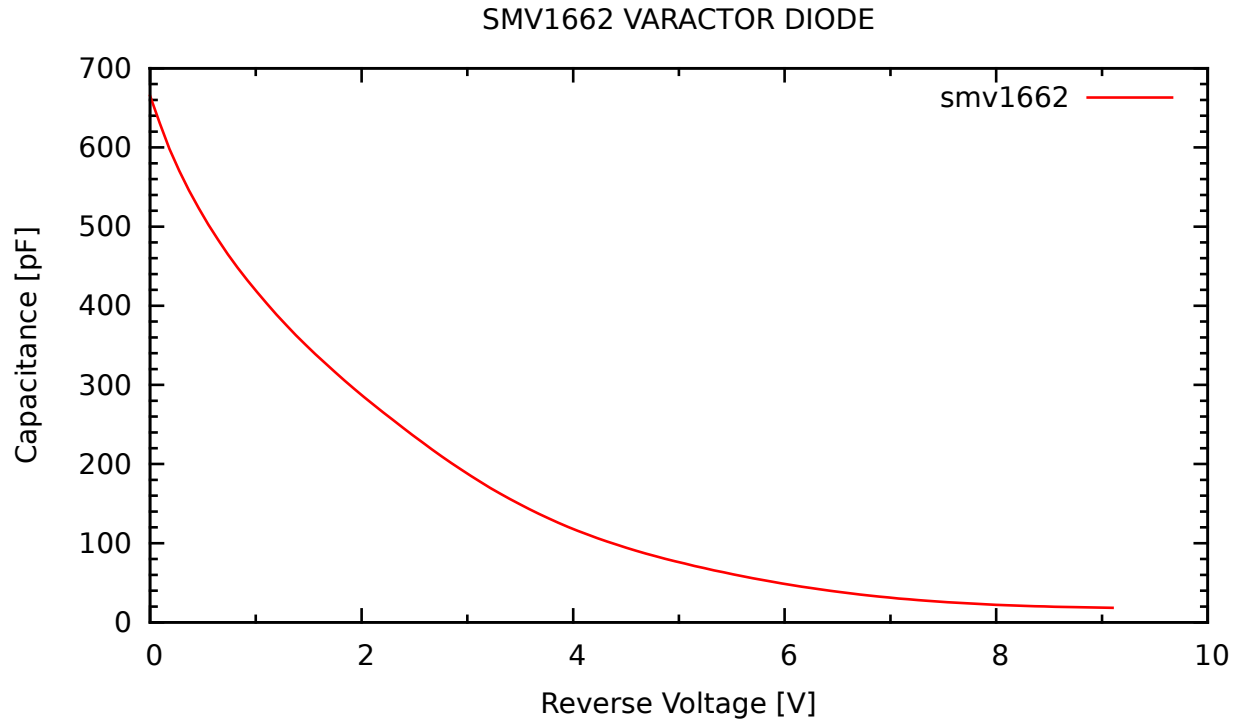

Figure 149: SMV1662 Varactor Diode Voltage Response Curve.

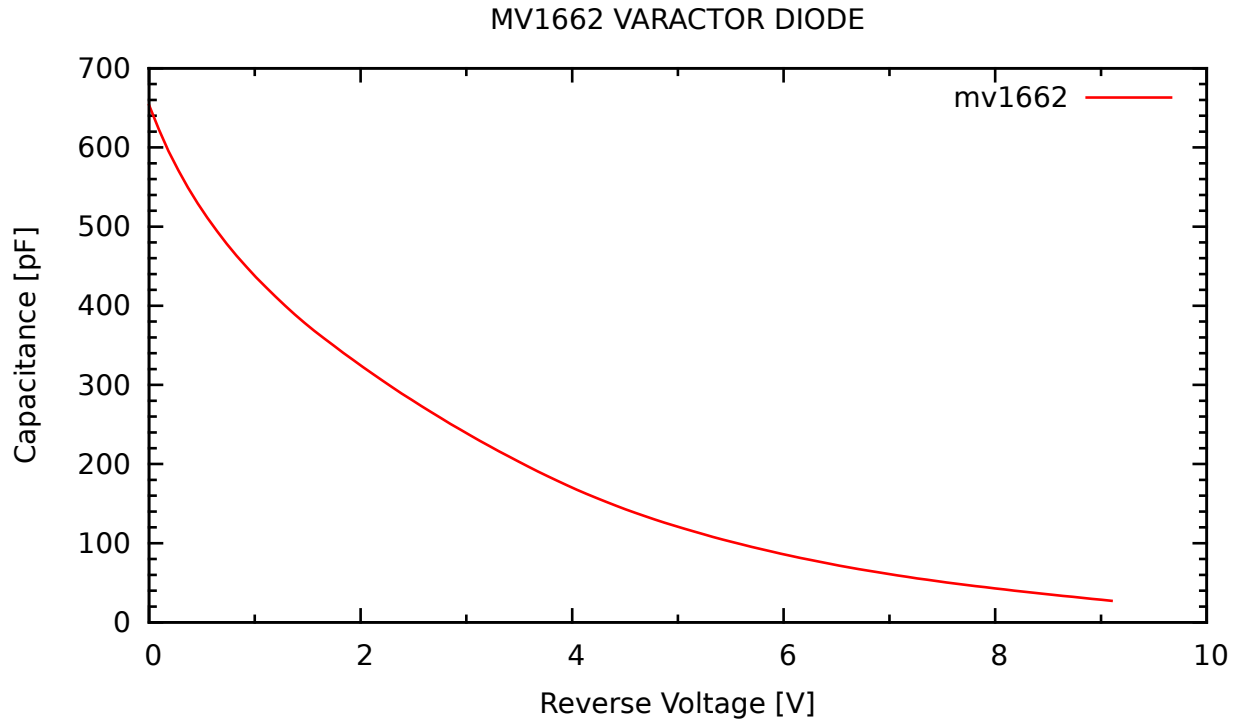

Figure 150: MV1662 Varactor Diode Voltage Response Curve.

Here I wanted to trace out the curve for a part labeled differently, MV1662 instead of SMV1662, than another container. Looks, to me, like they are the same part.

After looking at the two curves, I saw a slight variation in the slopes, so I took and plotted the two response curves into one graph, as seen below.

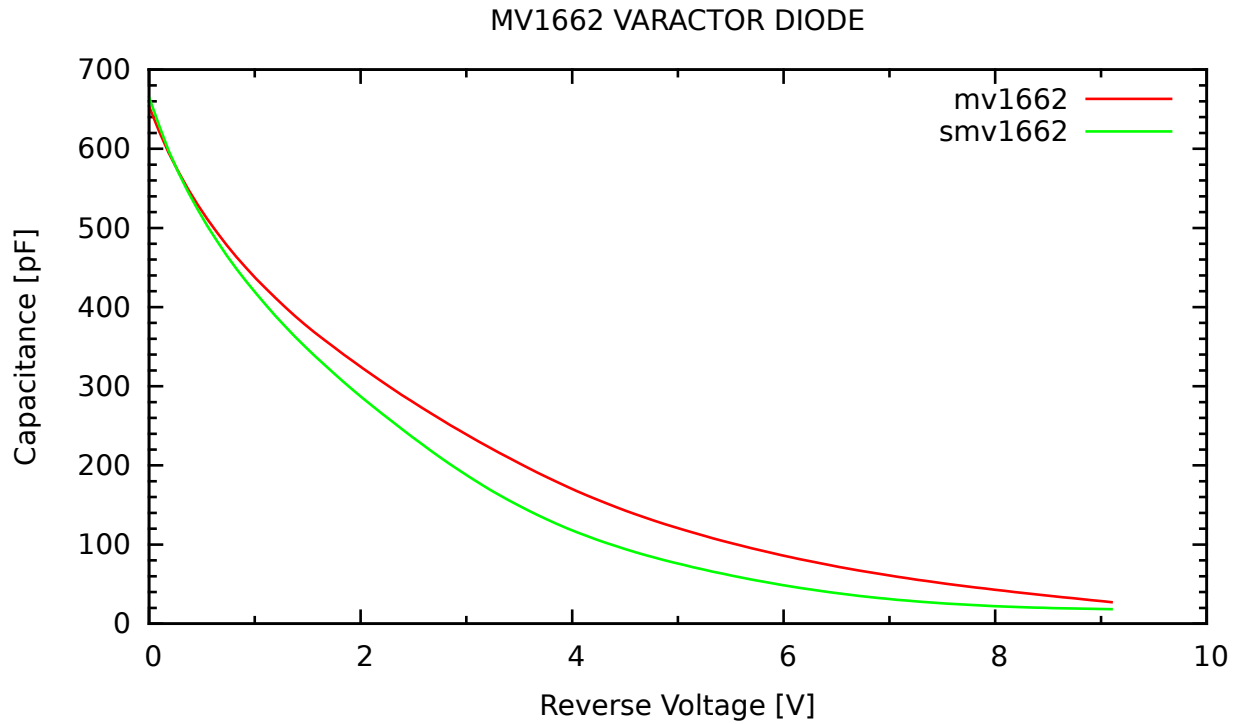

Figure 151: MV1662 and SMV1662 Varactor Diode Voltage Response Curves.

As you can clearly see, they are not the same part, but have slightly different characteristics.

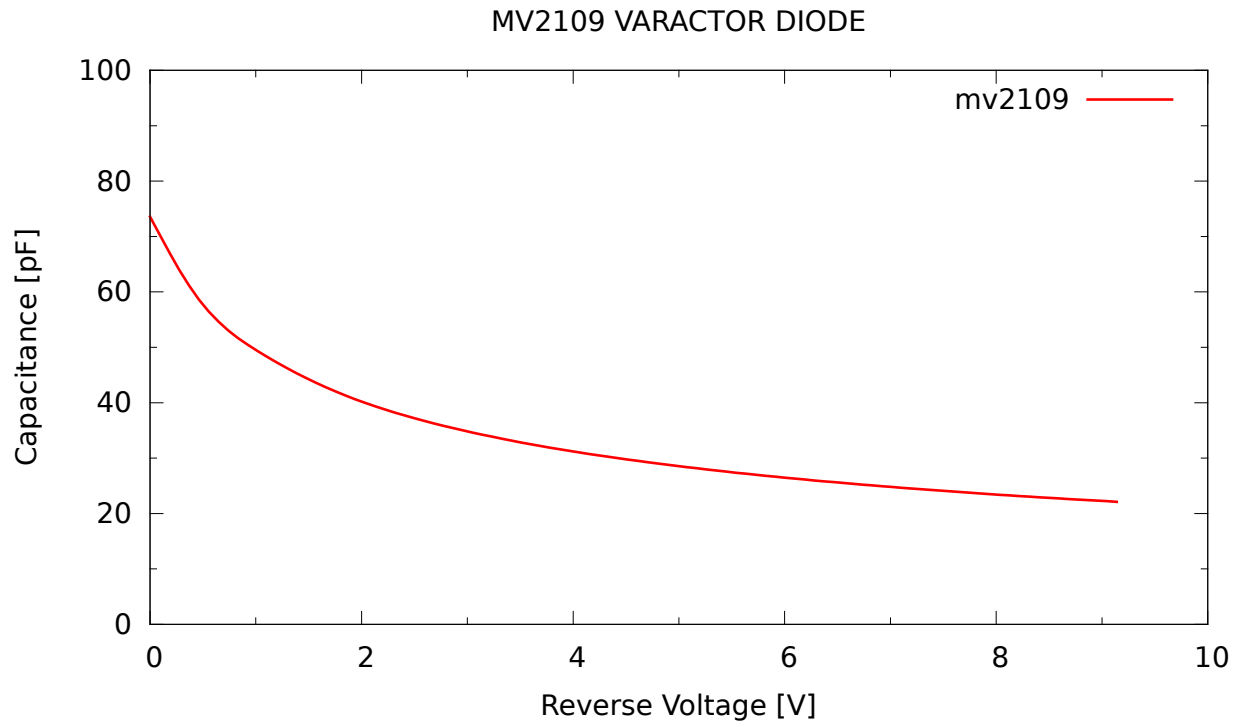

Figure 152: MV2109 Varactor Diode Voltage Response Curve.

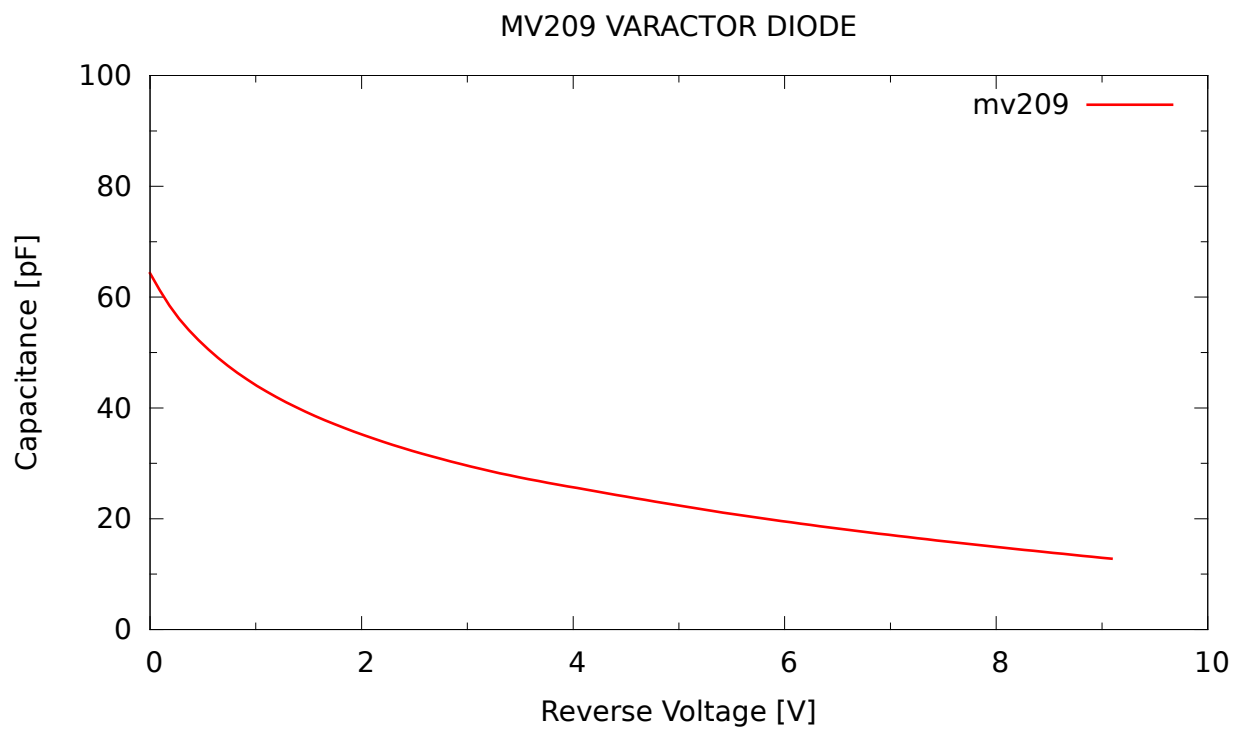

Figure 153: MV209 Varactor Diode Voltage Response Curve.

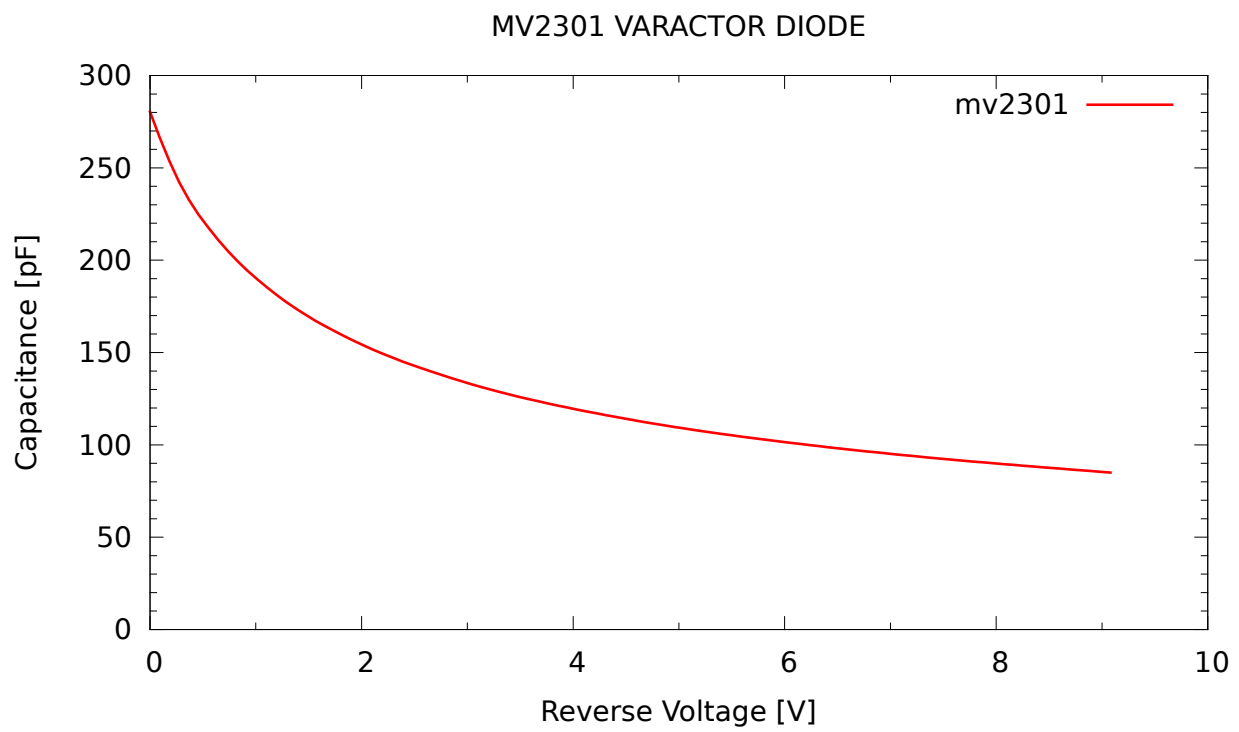

Figure 154: MV2301 Varactor Diode Voltage Response Curve.

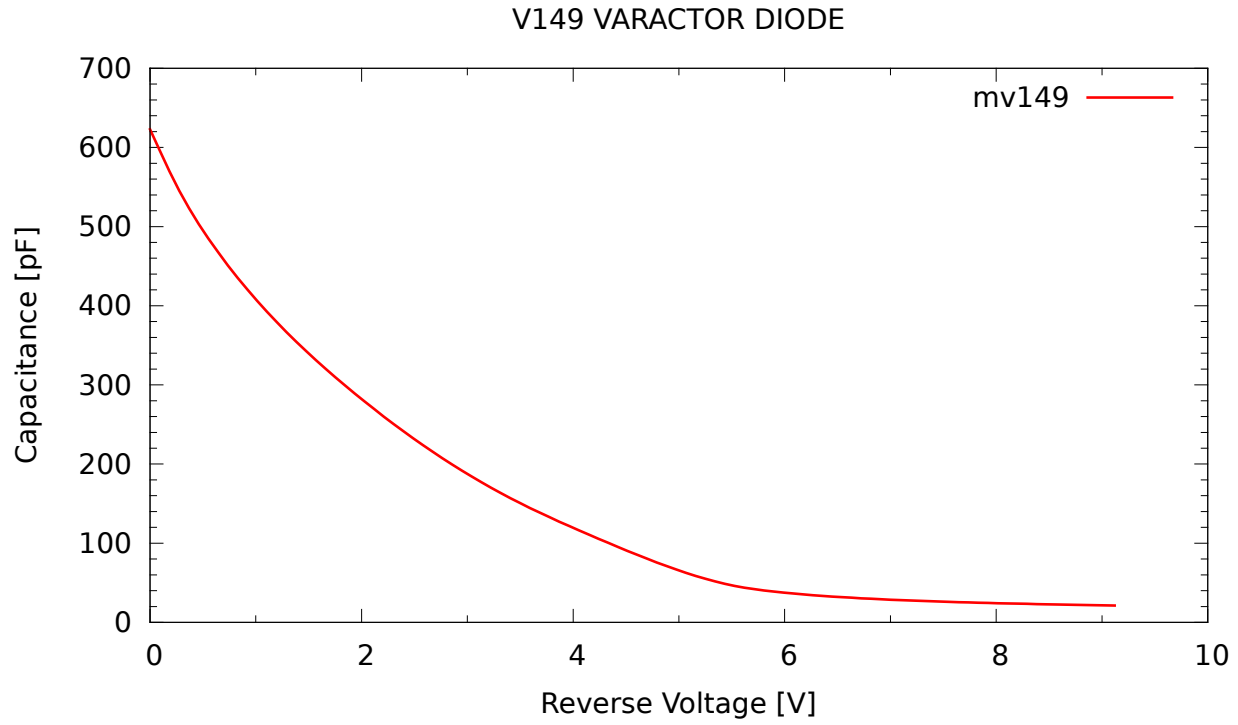

Figure 155: V149 Varactor Diode Voltage Response Curve.

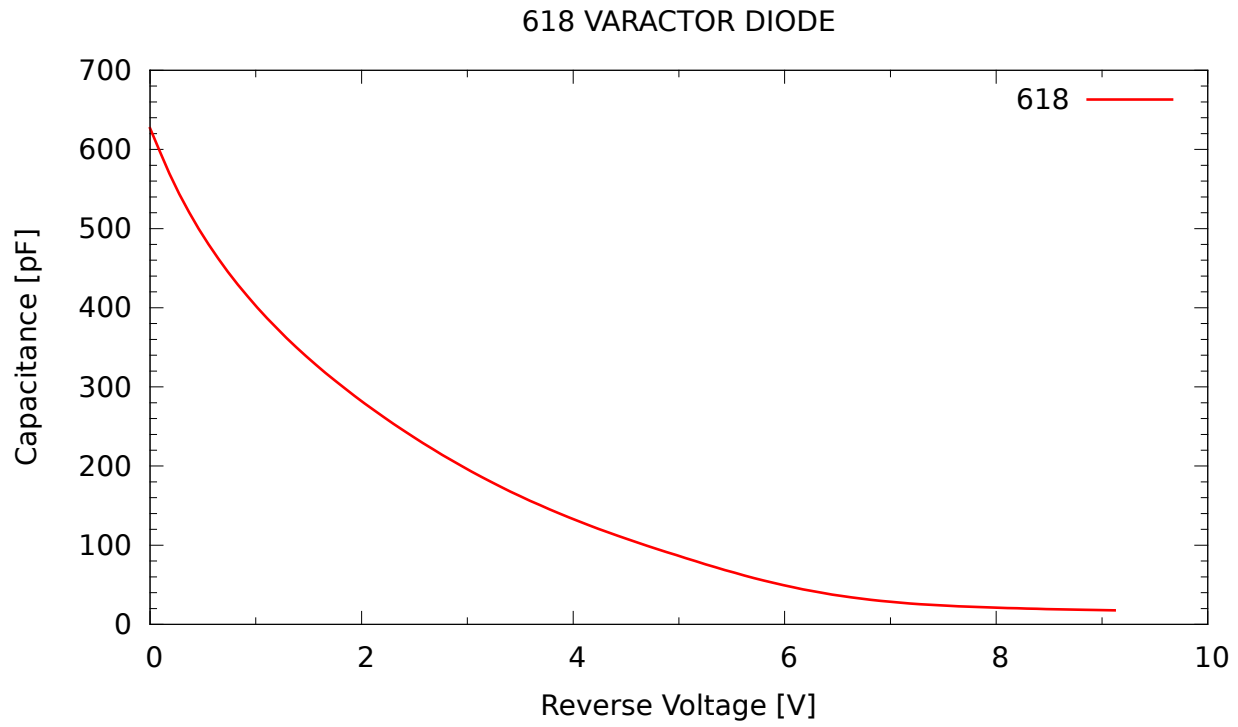

Figure 156: 618 Varactor Diode Voltage Response Curve.

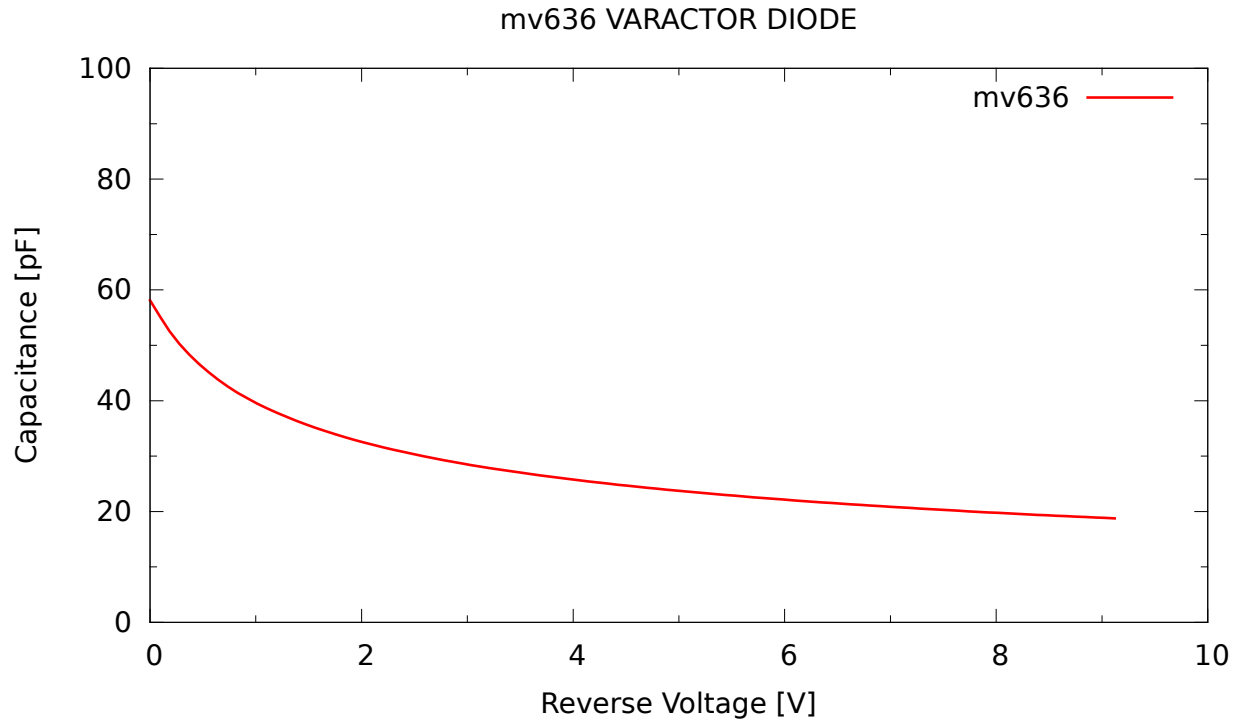

Figure 157: MV636 Varactor Diode Voltage Response Curve.

16.1 New Improved Varactor Fixture

After having a small difficulty with a single turn variable pot, I decided to go ahead and make another varactor fixture and use a ten-turn pot for the voltage adjustments. This gives me a greater resolution for the smaller range of voltages where most of the varactor diode changes are.

Here are the photos. Please note just how nice the boards turn out using the laminator to get a nice clean toner transfer.

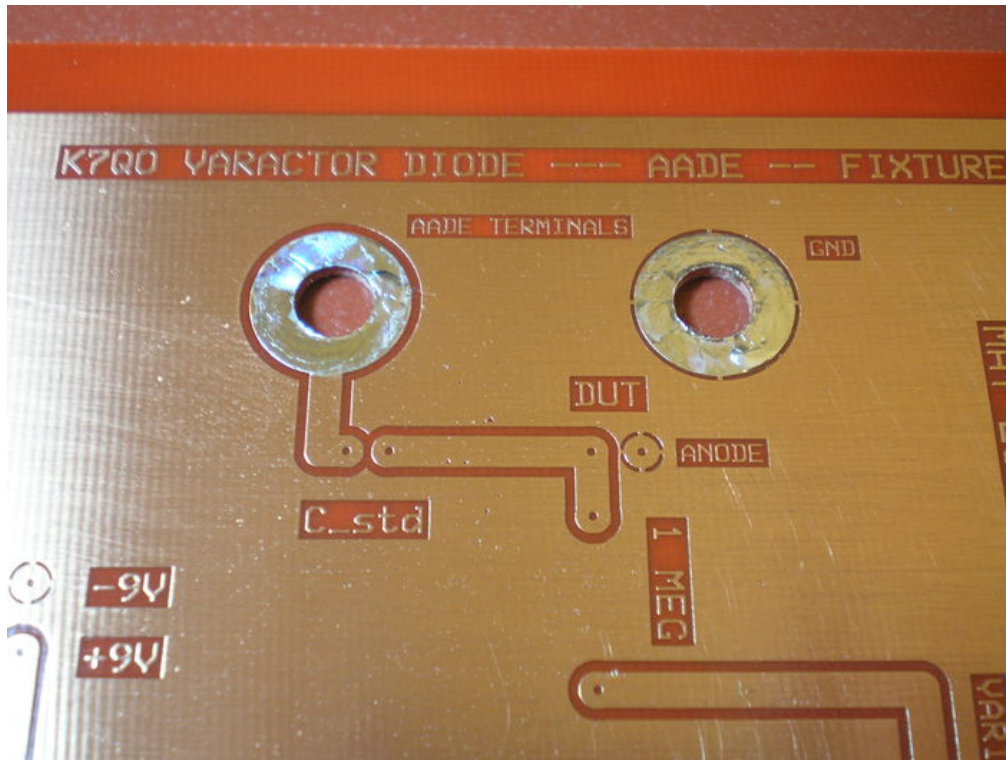

Figure 158: Tinned Binding Contacts

Note how nicely the board solders, even with a very thin coat of clear enamel. The secret. Get the enamel on very thinly and do not bake the paint to cure it. Let it air dry only. The enamel acts as a typical solder mask for commercial printed circuit boards.

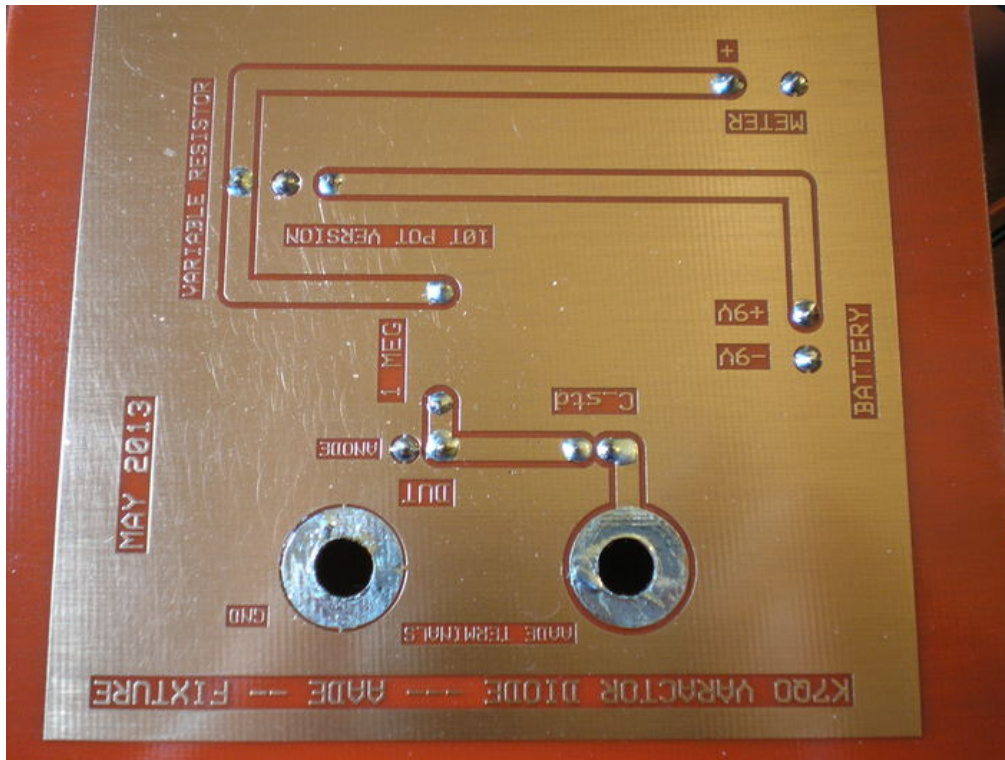

Figure 159: Completed Underside of Varactor Fixture



Figure 160: Varactor Fixture attached to AADE L/C Meter

Please note the ten-turn pot is set up with the shaft on the inside area of the PCB. I figured with a large ground plane above the AADE meter gives additional shielding and would allow adjustments without the meter reacting to hand capacitance. Seems to be working just fine. Now to make some more measurements.

Also, this 10T pot has the wiper contact on the left-most pin, of the three, as shown in this photograph. Make sure, if you use my layout, that your pot has the same pinout configuration.

Chapter 17

Regen Receivers

It is the purpose of this chapter to give a detailed account of how one can build a regen receiver. Every builder has their own biases and techniques. I am not claiming to be an expert. I am interested in experimentation. I build things and then do some modification(s) to see how things may be improved or learn some physics and circuit theory on just how critical components, layout and parts selection are to the operation of electronic equipment. Every day is a day to learn something new.

I wanted to build several regen receivers and compare their performance. This chapter is incomplete as this will take most of the winter of 2013 to complete. Be patient and build along if you have the inclination.

17.1 Scout Regen Receiver

When Doug Hendricks, KI6DS, announced the intro of the Scout Regen I was excited. Here was a regen that looked promising. I built one and found one problem with the external battery connector and that has now been fixed. The Scout that you see here has the reverse polarity problem, but if I can remember to do it correctly I can use an external battery with a modified connector to reverse the polarity.

Ooops. Gotta find the images. Film at 11.

17.2 The Desert Ratt Regen

The Desert Ratt regen is a creation of Paul Harden, NA5N, in New Mexico. I built one of the early versions using Manhattan construction techniques. Here are two photos of the critter. Worked well. The one that you see here has gone to that landfill in the sky. Have moved on to more refined versions of the receiver.

17.2.1 Some of the History of the Ratt

Here are some URLs of some of the history of the Desert Ratt by Paul Harden, NA5N. No need in me writing this again.

Paul Harden's schematic of the Desert Ratt 2.

You will need the schematic to follow along in this chapter as I describe the parts by their number according to the schematic numbering scheme.

Paul Harden's description for the Desert Ratt 2.

Desert Ratt history writeup online.

Here is the build that I did in 2000. My how time flies.

Recently Dave Richards, AA7EE, the poster boy for PCB enclosure building and his Manhattan building of receivers, did the Desert Ratt 2 build.

Dave Richards Desert Ratt build.

17.2.2 Desert Ratt Build 2013

As part of another project I side tracked to build the Desert Ratt again, but this time using the muppet board layout procedure. I wanted to build a platform to do some modifications and study the effects of different coil forms and coupling coefficients on coils on the receiver performance. The following is some of the details of that work. Documentation may be behind in some areas, but hopefully you get all you need to attempt this project.

First of all, the muppet board construction procedure came about by

the need to find a cheaper way for hams to build stuff. The Harbor Freight punch disappeared from their stores and their online web site. Other sources charge from \$30 US and up for the same punch. I have even seen them priced at over \$100. Geez guys. Give us a break. The muppet board is a Manhattan style procedure but without the hassle of punching pads and you even get interconnections without having to cut wires, strip the ends and then route and solder into place. You may have to use wire in some places where the board layout is impossible to do without some wires being needed to get from point A to point B without crossing paths on the circuit board.

Here is the board layout for the prototype. Do not use this. I had one small error in a missing pad for C2 that I will show you how I fixed in the build. I will layout a new board. The one you see here also uses an air variable and not everyone will have one handy and they are pricey in todays market place.

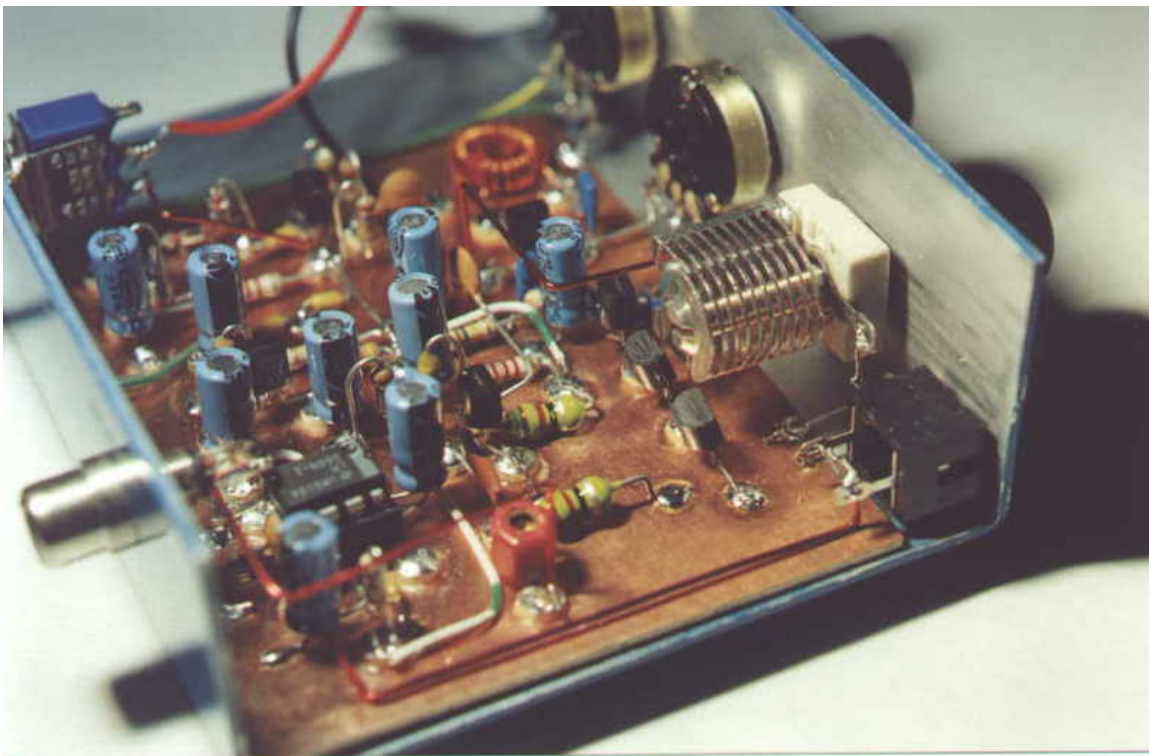

Figure 161: Desert Ratt build Manhattan style by K7QO.

I did a couple of mods. First was to use LM317L for a voltage regulator instead of the LED as shown by Paul Harden, NA5N, in his online schematic. There are so many LEDs in this day and age and they all have different voltage drops dependent upon the desired color output and brightness. So I spent the sixteen cents and went with a LM317L and two resistors (480 and 680 ohms) to get 3.06V out.

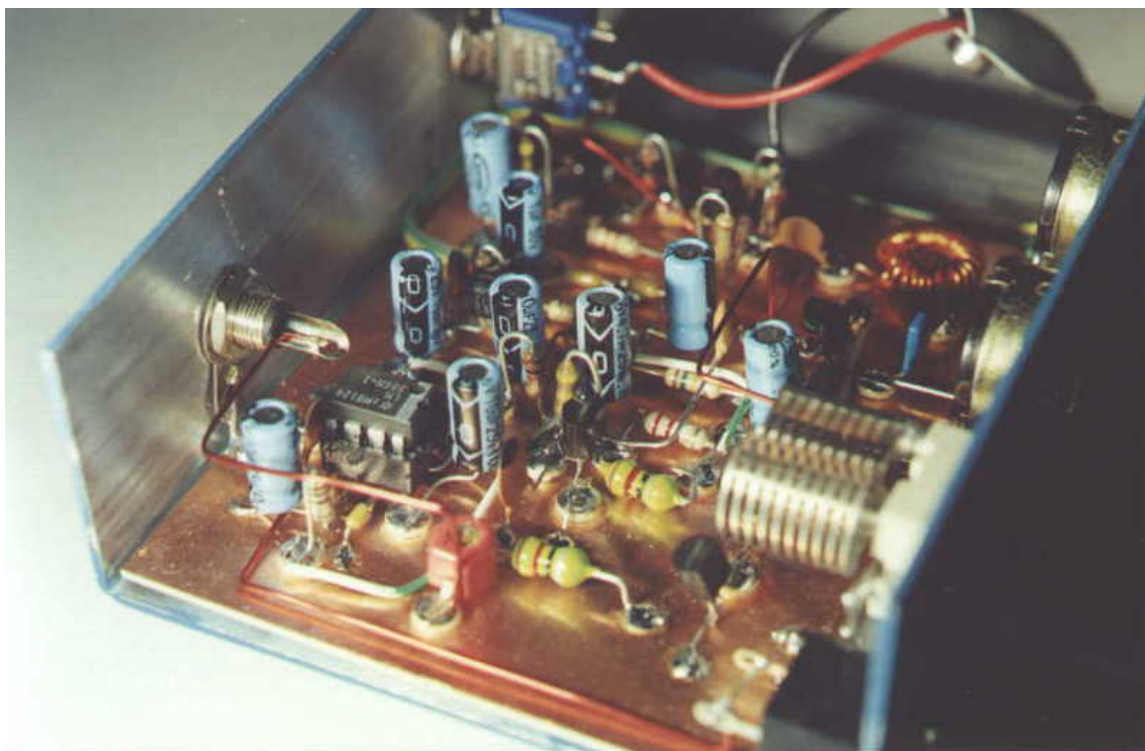

Figure 162: Desert Ratt build Manhattan style by K7QO.

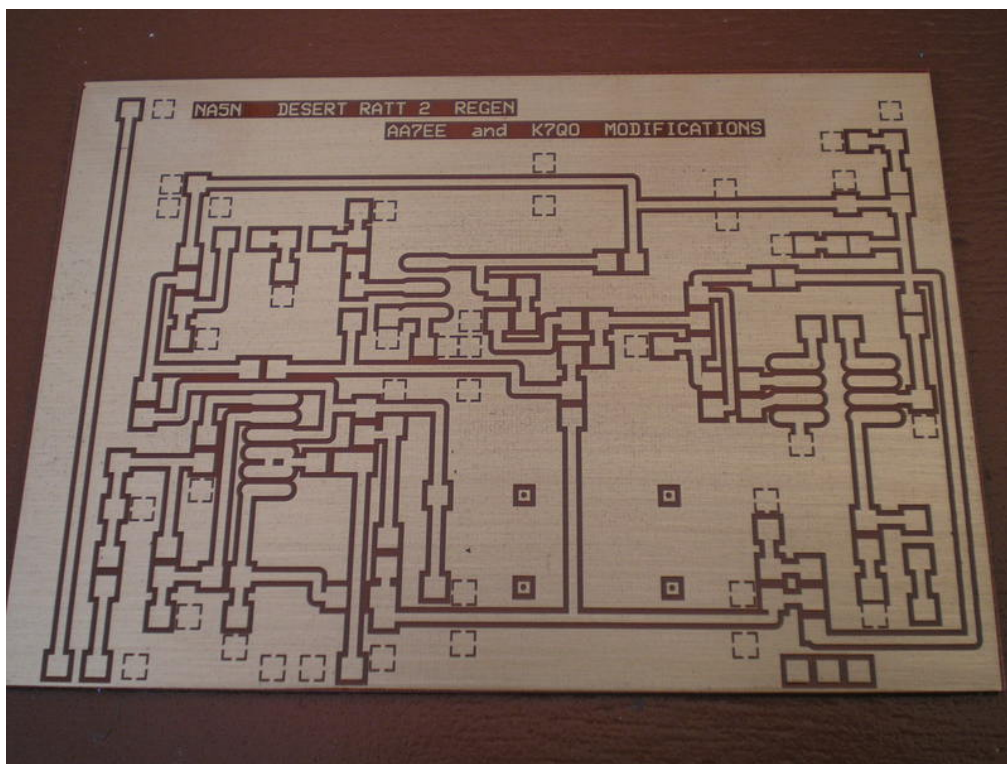

Figure 163: Desert Ratt Muppet board layout by K7QO.

OK. Time to start building. I build a section and then test the circuit. It is about the only way that I can get a project to be successful. I hate to build an entire circuit board and then fire it up and not have it work. I would have to spend more time looking for the problem. At least with the build and test procedure I will immediately know when a section does not work properly.

I use 0.10" headers for temporary connectors that allow me to rapidly connect and disconnect the power supply so that the wires do not get in the way during the construction process. In the photo you see a reverse polarity diode (1N4148 as the current is below 100mA) to keep me from destroying something if I hook up the P/S backwards. Also a 4.7K resistor in series with a green high intensity LED for power on indicator. The current draw is only about 1.5mA. The resistor to the left is a 1.0ohm. The ground plane in the center is isolated from the main ground plain due to routing issues, so we use 1.0 or 0.0 ohm resistors as the resistance is not critical vs the 4.7K in series with the LED.

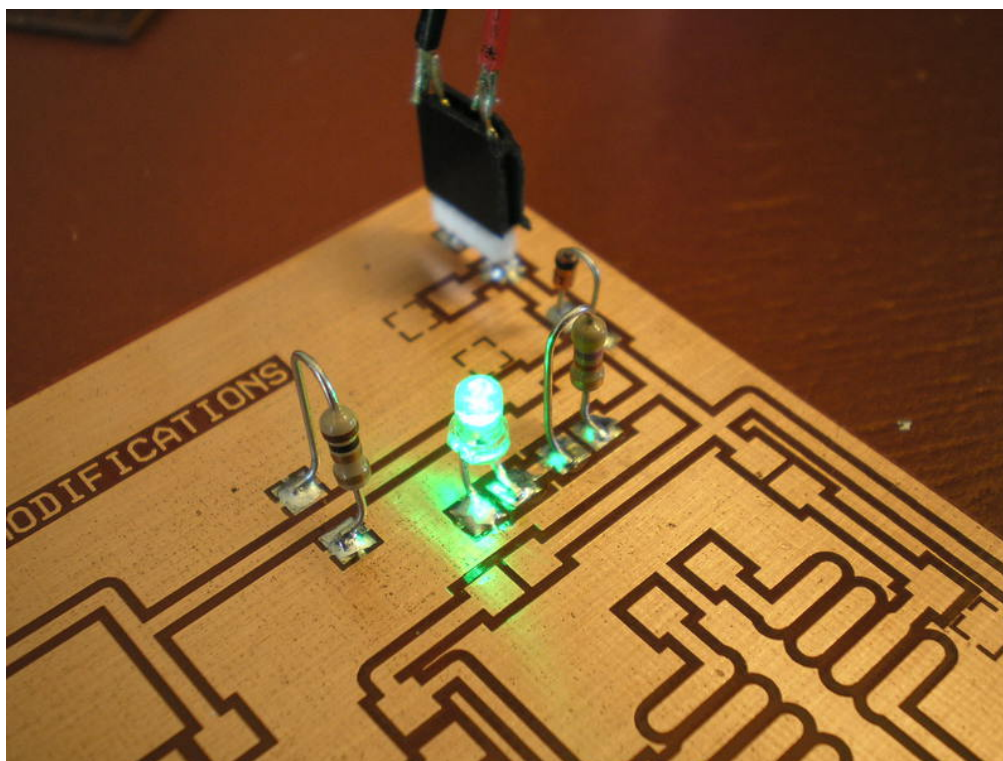

Figure 164: Power supply connection setup.

Since this is a receiver, I almost always start with the audio section. I can hook up headphones and determine if things are working. This procedure is easy and does not require fancy and expensive test equipment unless I run into problems.

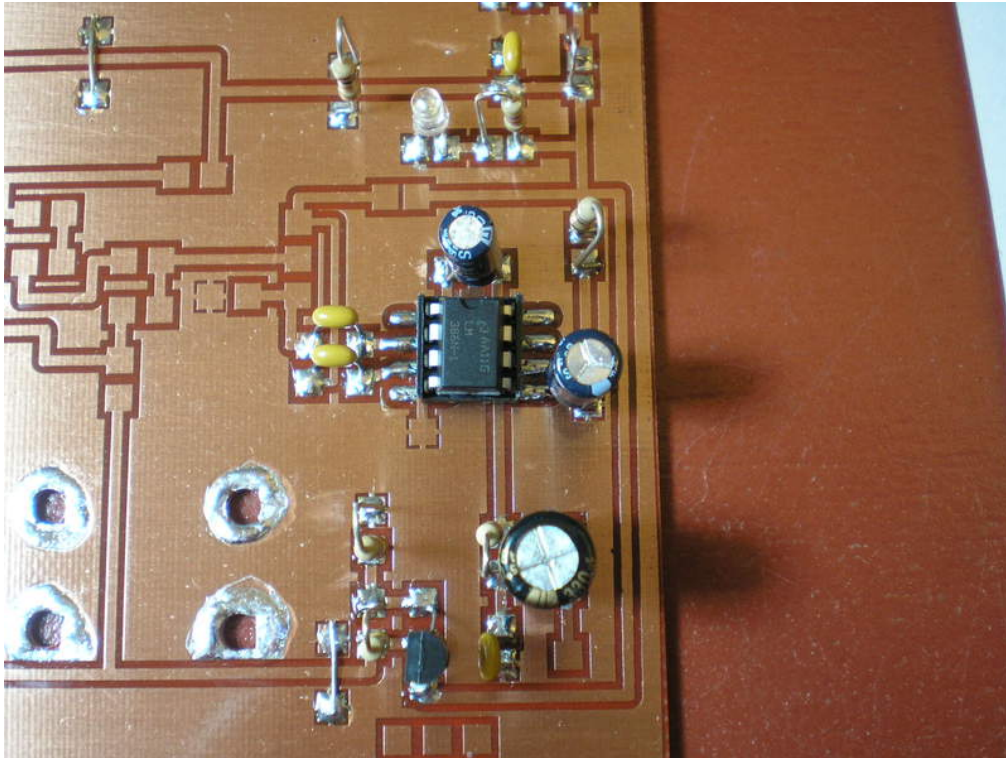

Figure 165: Audio section completed.

With the audio section wired, it is time to power it up. In the headphones I can hear the typical hiss from thermal noise from the LM386. Note. I use some breadboard test leads (search on ebay for 'dupont wire cables' or 'arduino breadboard cables') with alligator clips on one end to clamp onto the leads of the audio jack. With the board powered up, I then touch each of capacitors C16 and C17 one at a time with just a finger to see that AC hum appears to show that the audio amp is functioning properly.

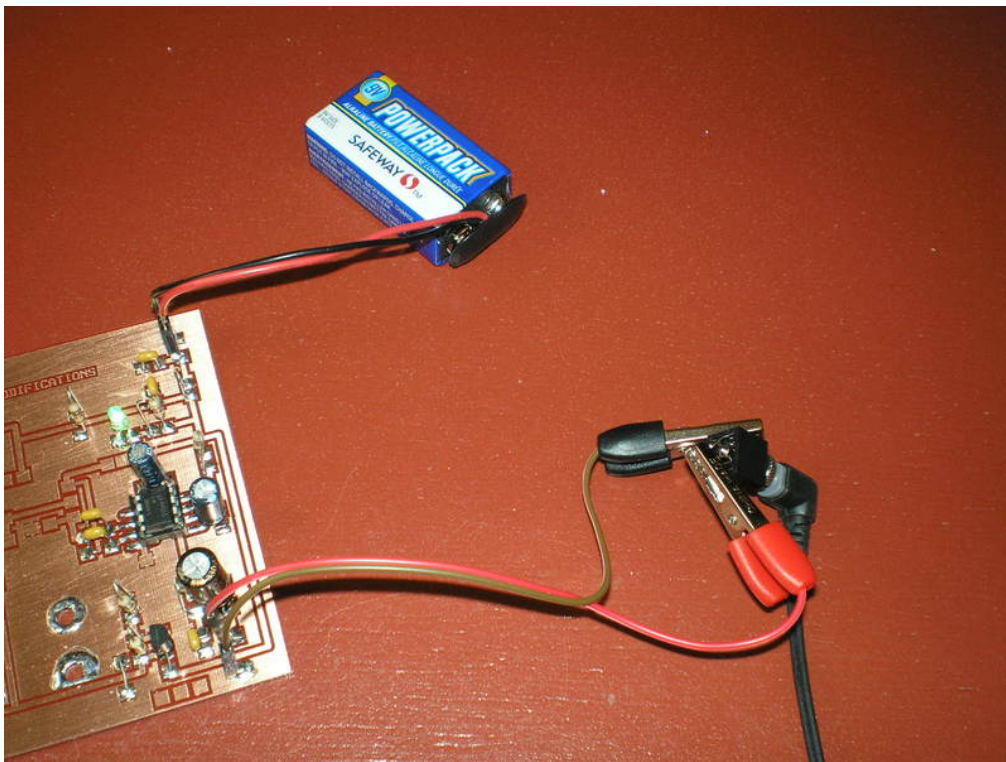

Figure 166: Audio section powered up for testing.

Here I have added the LM317L voltage regulator with 420 and 680 ohm resistors to get 3V out for the bias and operational voltages for the rest of the receiver. Note this in the NA5N schematic and document. I had highlighted in yellow during the board layout so that I would not forget connections for all the parts. Now, as I install parts, I use a green highlighter to show what has been installed and I can tell what it is I am testing in powering up. Works for me.

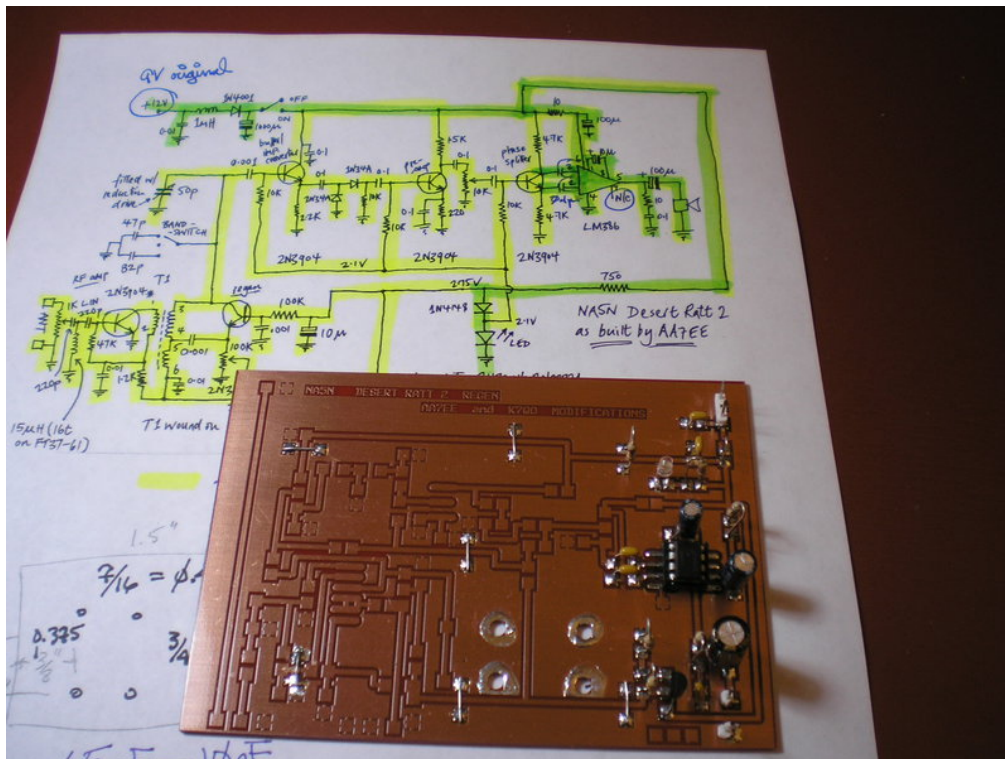

Figure 167: Schematic and board with LM317L installed.

Note that I have not modified the schematic to show the mod. Will do that later.

Next is the installation of the differential amp. Again power up and see if noise can be heard when the input side of C15 (connection to RV4 later) causes an increase in noise in the headphones.

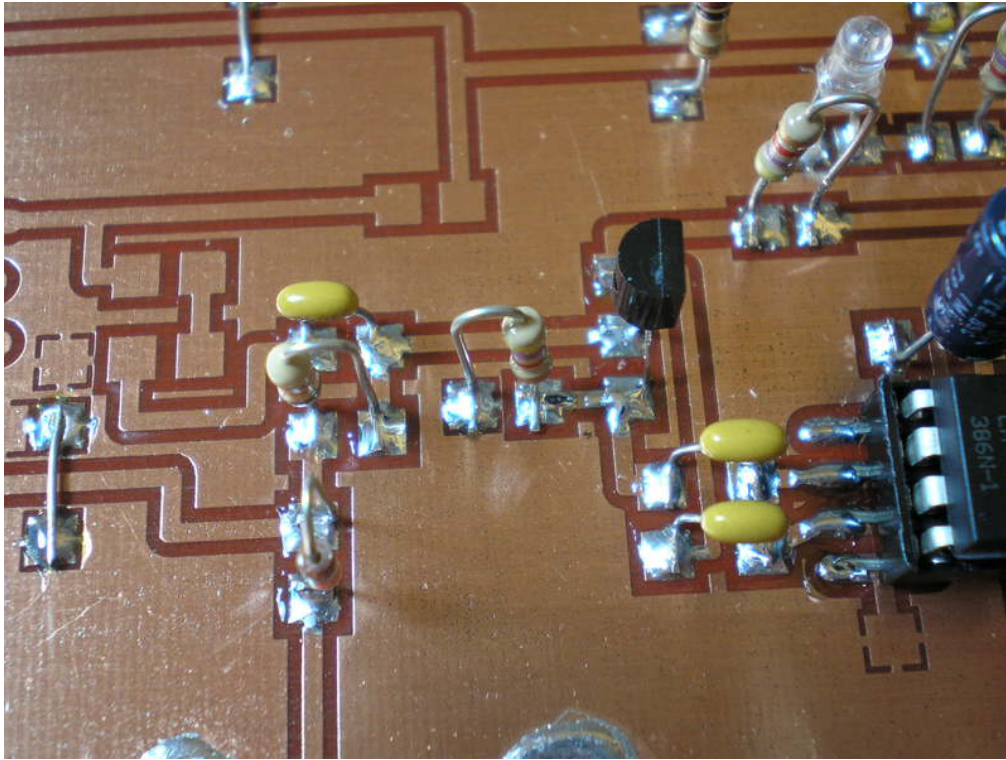

Figure 168: Differential amplifier section completed.

Installation of audio gain pot and AA7EE's pre-amp that was added to get some more gain in the receiver.

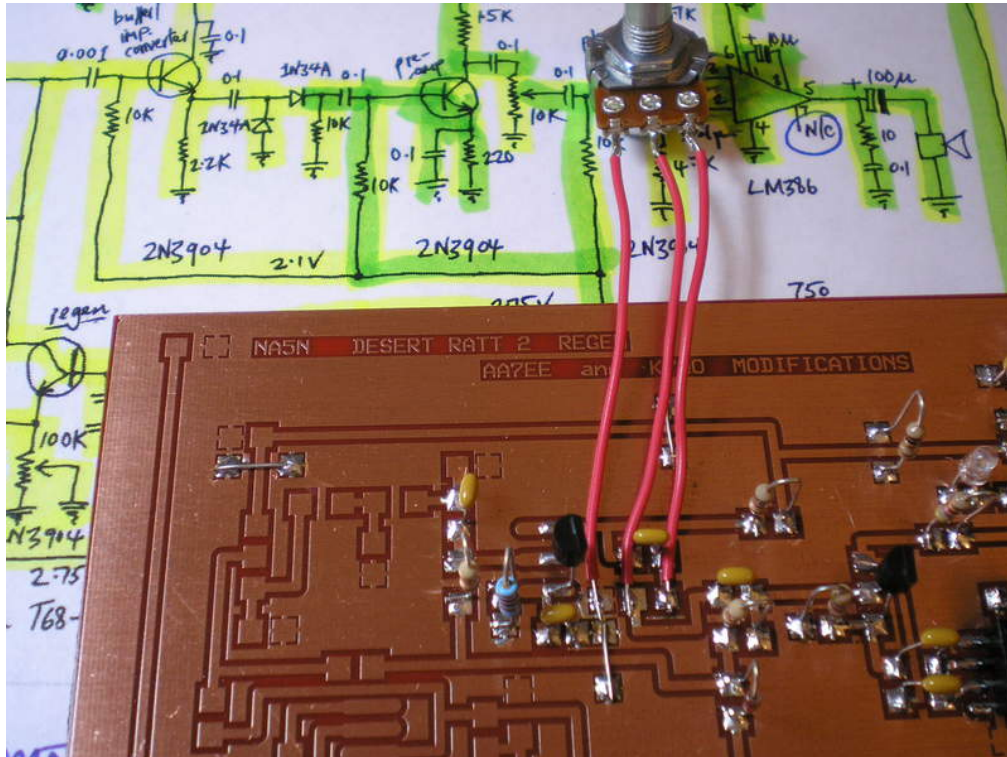

Figure 169: Audio volume control and pre-amp sections.

Diode detectors consisting of 1N34A diodes.

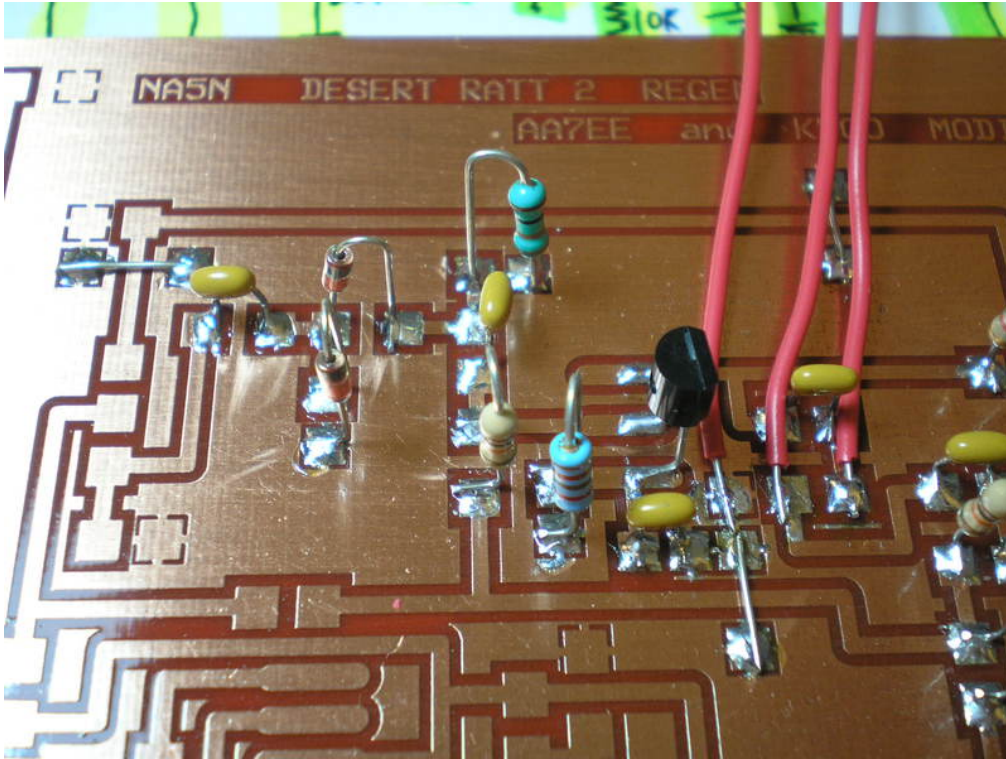

Figure 170: Diode detectors, 1N34A diodes.

Photo of section and schematic. At this point, when powered up, you should hear noise in the headphones if you touch the left hand side of the left most 0.1uF cap. Also, the change in position of the volume control will show an increase/decrease in the noise level, if everything is working properly.

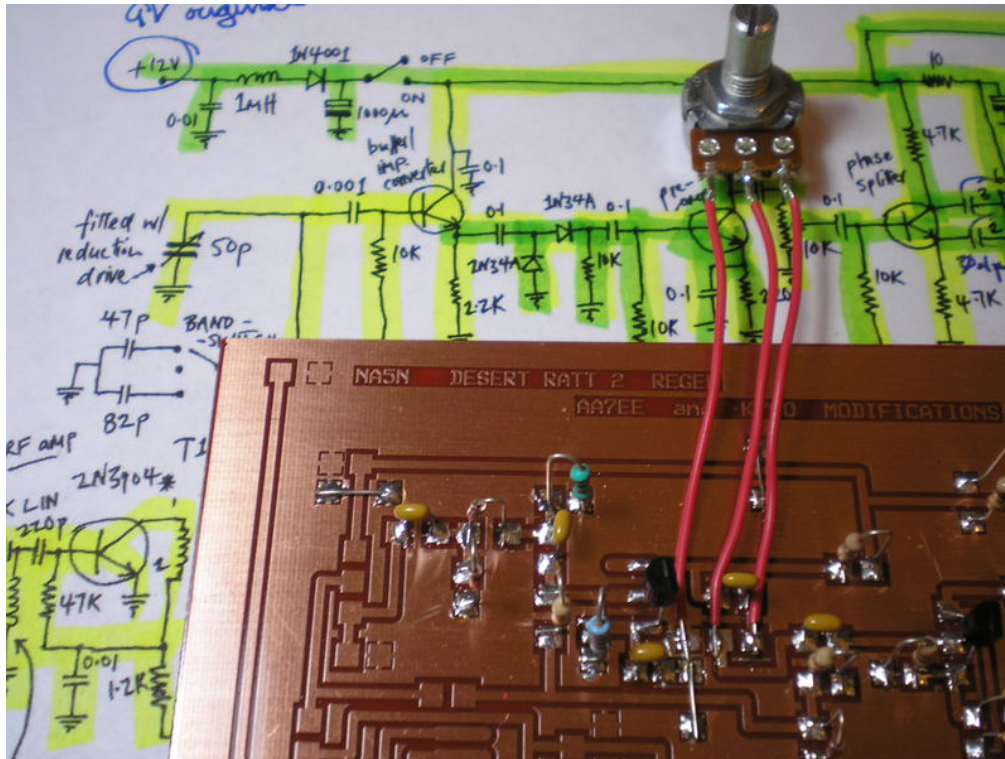

Figure 171: Board and schematic photograph.

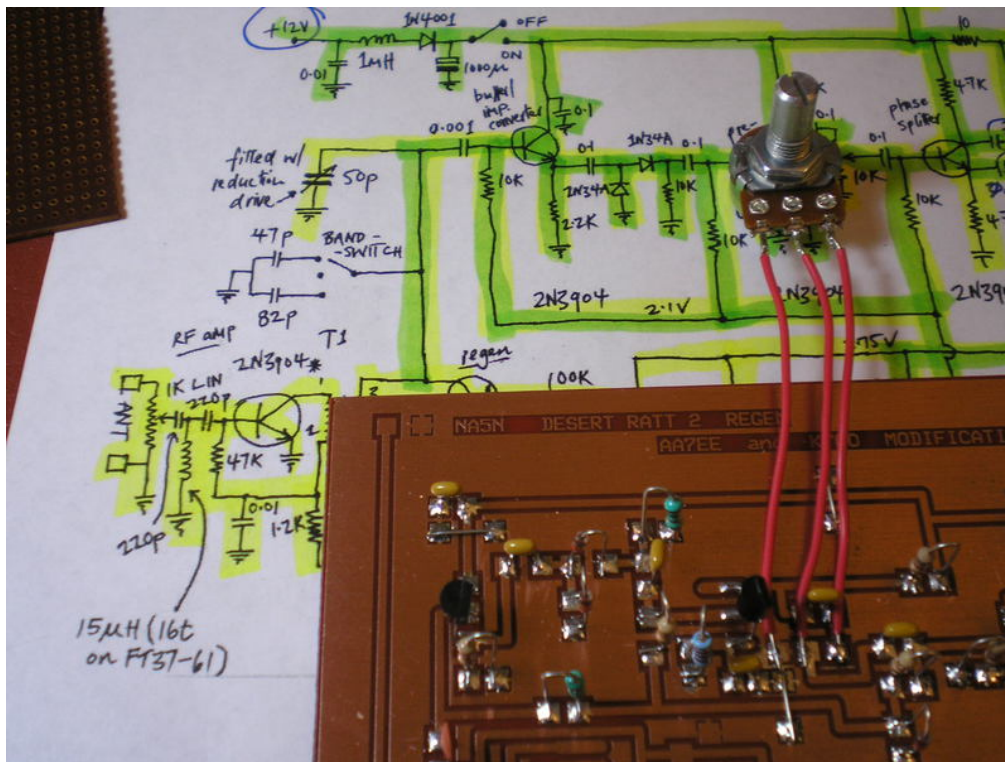

Figure 172: Impedance conversion section.

I was wiring up the regen and RF input amplifier section and I discovered I had made an error in the board layout. Had one pad for the cap C1, but must have gotten interrupted and forgot about the second pad and the gap. No problem. Exacto knife with #11 blade and a spot to put the cap opened up like magic.

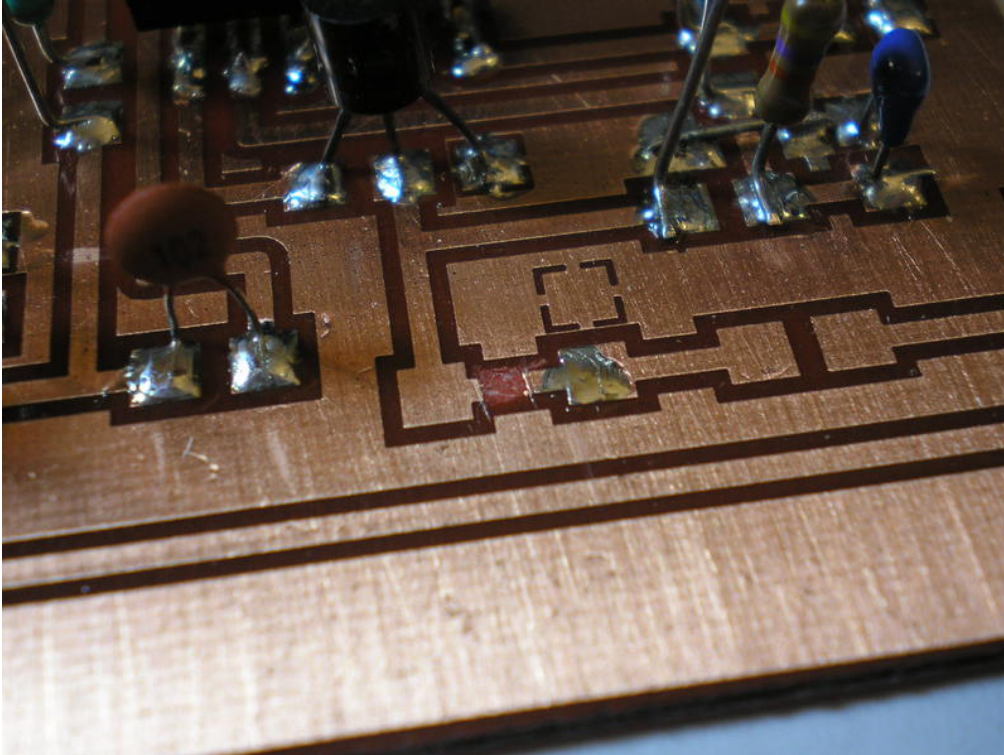

Figure 173: Board modification to correct error in layout.

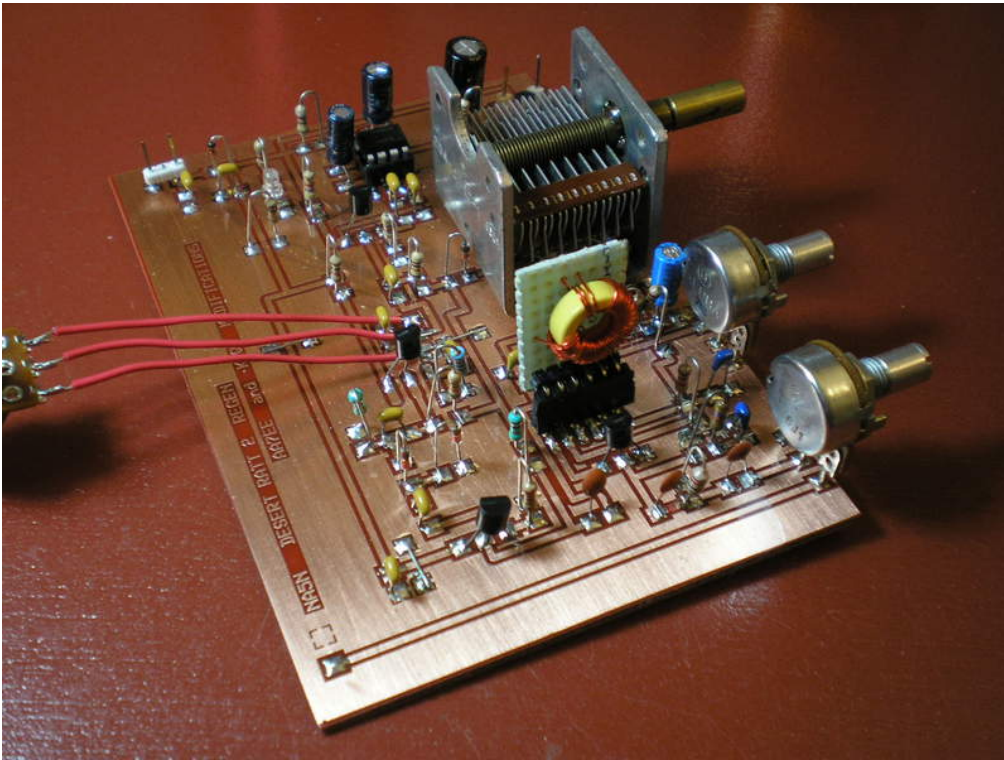

Figure 174: Completed board assembly by K7QO.

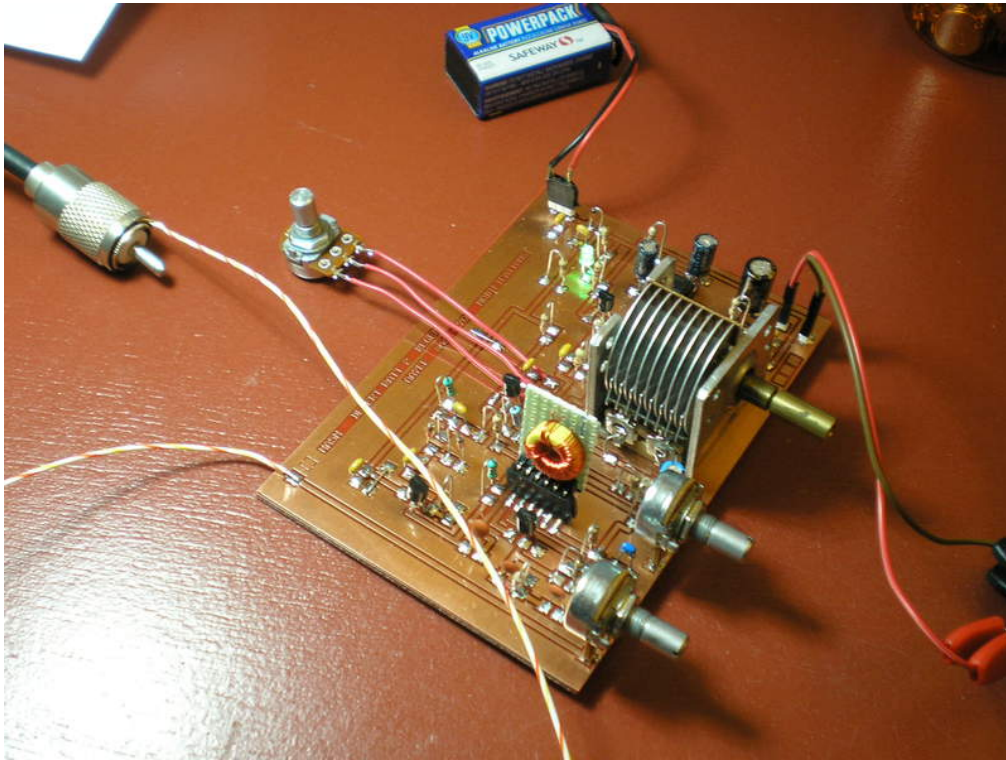

Figure 175: Desert Ratt powered up and listening to shortwave broadcast station.

See the vector board sticking up vertically with the yellow toroid on it? That is a band module, i.e. I can wire up a different combination of turns with a different toroid powder mix to study effects of coupling between turns. Also allows me to change frequency ranges or bands to listen to at different times of the day or night. Cool.

I am using the 0.10" headers but with a right angle male header for the vector board connection.

OK. Desert Ratt 2 is wired and working. I have a couple of mods to make to the circuit board. I am now going to go back and do a version using varactor diodes for tuning. Also going to make the board mountable in an enclosure instead of making the board the base of an enclosure. I want to route the volume control leads under the board and place the jumpers under the board also. But, have to make a new W7ZOI HP 8640jr signal generator again with the muppet board layout. To be used in this project for some measurements. Stay tuned.

This is current as of December 13, 2013. I need a few days to work on the signal generator and a sensitive RF meter.

Chapter 18

Crystal Frequencies

I am putting here a list of crystals I have on hand. This is for my reference only so that I have a quick place to look for what I have. I am trying to get organized. These will be used in a series of experiments on crystal oscillators and their properties.

3.575	3.579	3.582	3.686	3.930	
4.000	4.032	4.096	4.190	4.332	4.916
5.000	5.120				
6.000	6.400				
7.040	7.372	7.680			
8.000	8.192				
9.000	9.880				
10.000	10.116	10.483			
11.000	11.040	11.059	11.289		
12.000	12.084				
13.500					
14.318					
15.000					
16.000					
18.000	18.432				
22.118					
24.000					
50.000					

Chapter 19

AADE Toroid Measurements

The toroid is a valuable commodity in the parts collection of an electronic experimenter. This chapter will make an attempt to explain why this is so. At least for RF work in the HF and UHF regions of the electromagnetic spectrum.



Figure 176: Binding posts of AADE IIB meter.

Excuse the dust. I did not look before taking the photo and this is the area under the K7QO fixture. The fixture has two pads that make contact with the two posts.

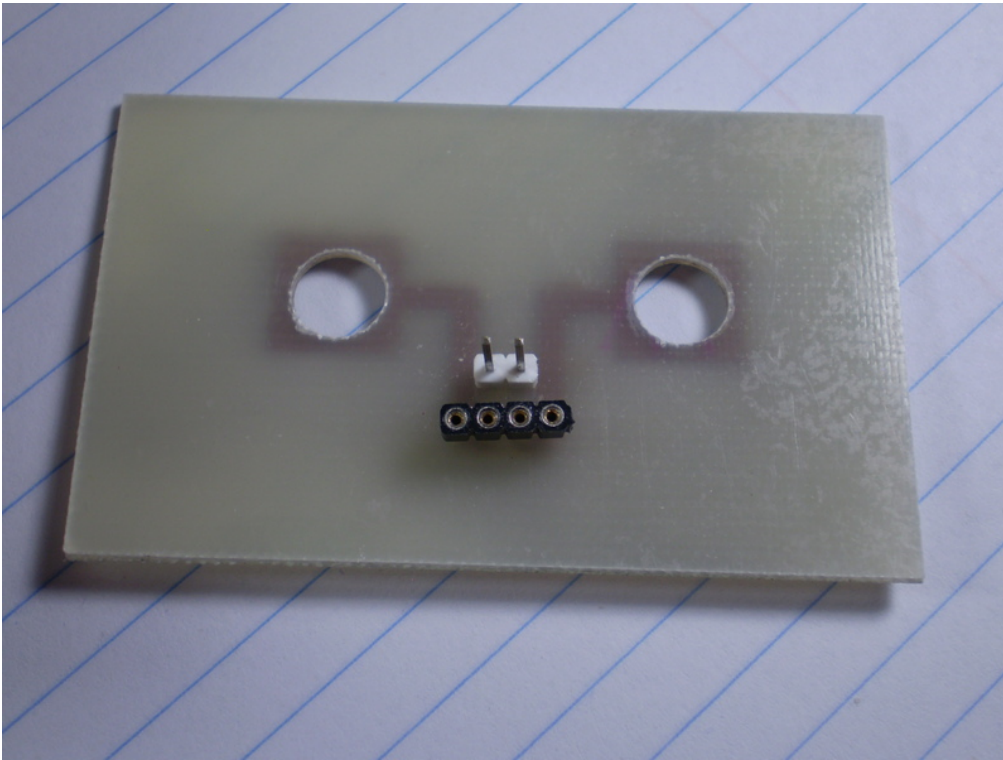

Figure 177: Top view of the K7QO fixture.

This is a PCB with traces under the board that connect both the 0.100 inch male header and the Augat machined socket pins to the traces.

The pins are used to insert parts to be measured into or I can use some connections to alligator clips to the 0.100 inch headers for larger parts or parts that I do not want to bend the pins on yet.

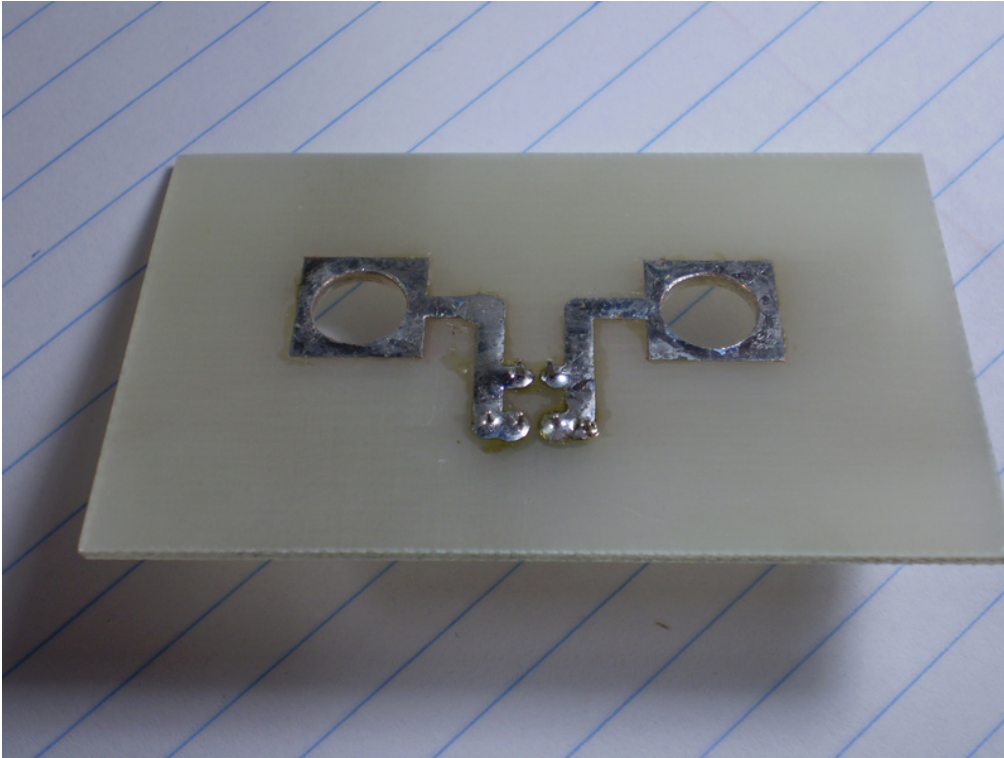

Figure 178: Cables with Radio Shack alligator clips.

Here is the underside of the fixture showing the traces. Don't worry about the additional capacitance across the meter posts as we zero out or calibrate the meter with the fixture in place.

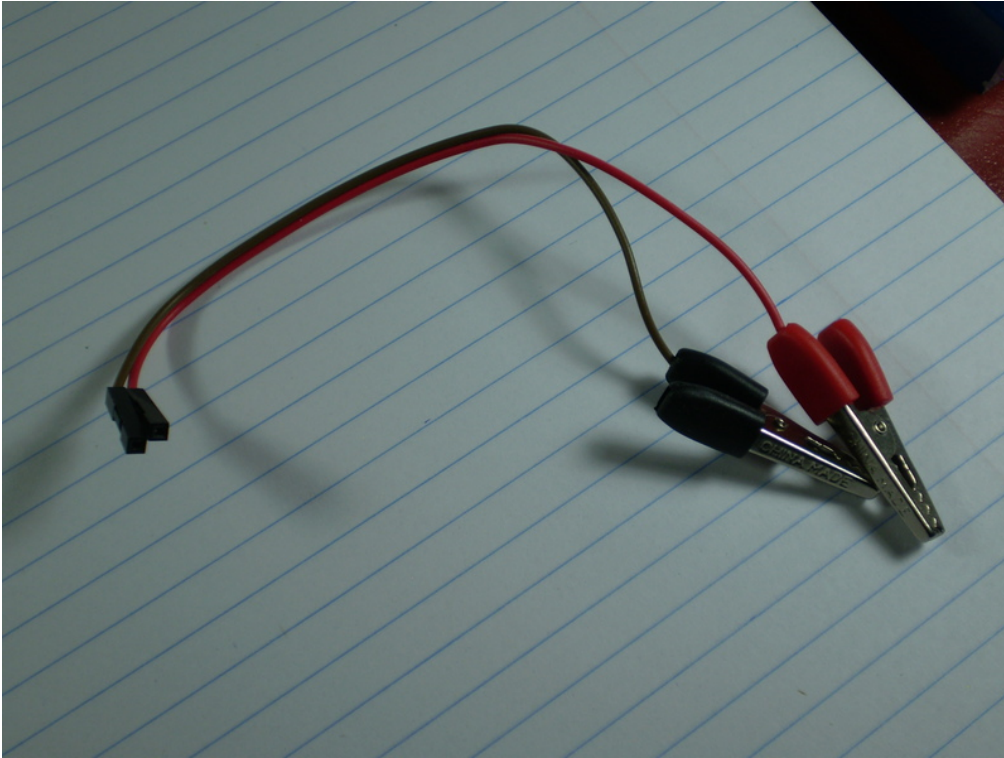

Figure 179: 0053.

In the above photo I have used two Arduino jumper cables that I have modified to put two Radio Shack alligator clips on one end. This allows me to plug the cables into the 0.100 inch header and then clamp to the leads of any part that I want to measure with the L/C meter.



Figure 180: Cables shorted out to calibrate for zero inductance.

The AADE meter allows you to short out any test leads and then zero out the added inductance before measuring the part that you want to find the value for.



Figure 181: Toroid to be measured in place.

By using the small alligator clips, I found that I could easily put a toroid on one jaw and connect the other clamp to the jaw containing the toroid to measure the inductance for a one turn coil on the toroid. Here a FT37-61 is in place to be measured.

How do I know that? Because the toroid is a dull grey without specular reflections (shiny areas). See next page.



Figure 182: FT37-43 in place.

Above is a FT37-43 to be measured. It has a much shinier surface as you can see by the reflections of light off the side.



Figure 183: Arduino female–female jumper cable.

Here is a photo of the ends of an Arduino jumper cable with female–female gender connectors. This allows me to connect from one 0.100 inch male connector on the fixture to the other connector. I do this first and calibrate for zero inductance.

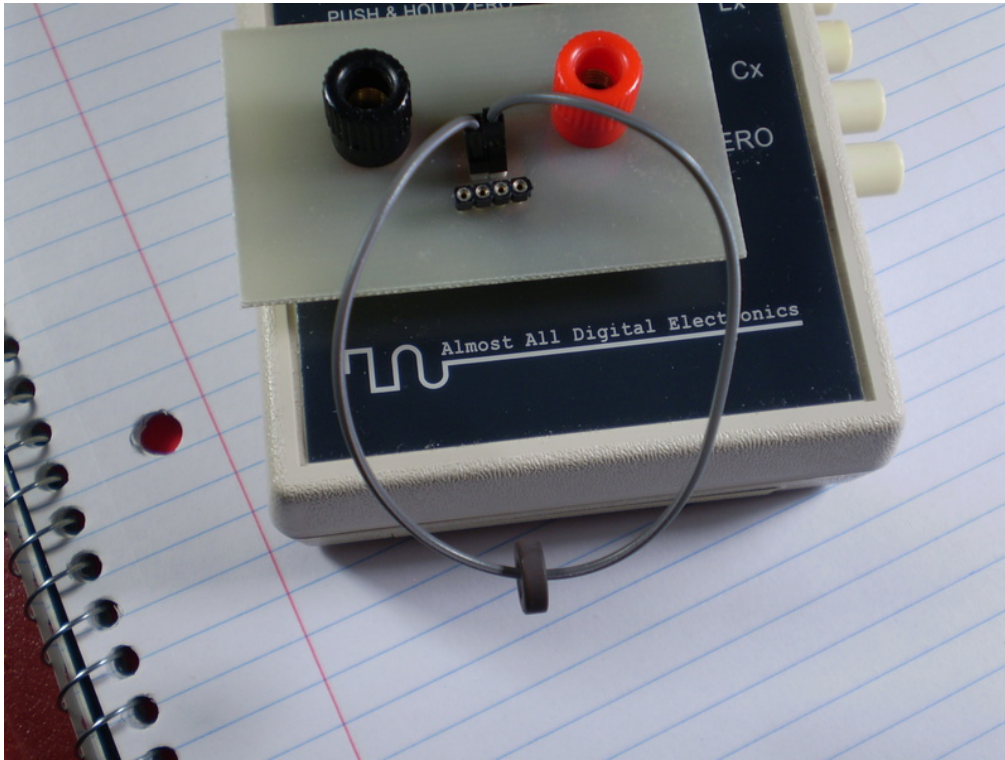

Figure 184: Cable in place with toroid on it.

With the cable connected to the fixture and a toroid in place, as shown, I can now measure the one turn inductance of the toroid. This is quick, painless and very effective in separating toroids on unknown type rapidly. Try it, you'll like it.

Chapter 20

VXO Experiment

A VXO is a variable crystal oscillator. Usually a crystal oscillator has no variation in its output frequency. You build one of the classic crystal oscillator circuits for the desired crystal frequency. Minor adjustments can be made in frequency adjustment by either adjusting component values in the oscillator circuit or by adding an inductor in series with the crystal to lower the frequency or place a capacitor in series to raise the frequency.

One of the things hidden in all this is a number of factors which can cause the circuit to cease functioning all together. But that is for another chapter at another time. I'll just let you search the Internet for discussions on the topic.

I wanted to measure the output of a VXO as a function of the frequency. To move a crystal from its resonant frequency, especially with the high Q typical in crystals, will decrease its activity and thus reduce the output of the oscillator. Not to even mention looking at increased phase noise and possible spur activity.

So, here is the circuit.

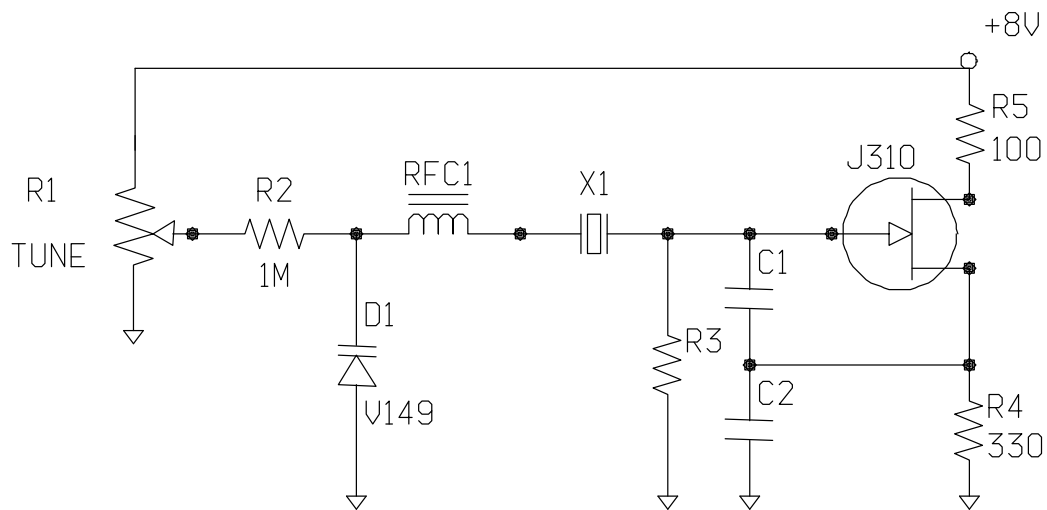

Figure 185: VXO Test Circuit.

Chapter 21

New England QRP Club NE4040

The New England QRP Club, NEQRP, in 1994 came out with a kit called the NE4040. This was a single board transceiver for the forty meter ham band and the cost of the kit was forty dollars, thus the derivation of the kit name, 4040.

The kit was designed by Dave Benson, K1SWL, although at the time his call was NN1G. Dave then formed his own company and came out with the Small Wonder Labs series of transceivers that were improvements on this design.

The board for the ARRL 1995 Handbook is available for Far Circuits, farcircuits.net, for under thirteen dollars US. I had one of the boards that I purchased some time ago, so it was about time to build it and the following photographs are shown as the building progressed. I will refrain from boring you to death with the nitty gritty. If you decide to build it and have questions, feel free to send me emails with your questions and I will respond to them. I do believe the board comes with a reproduction of the ARRL pages. Let me know.

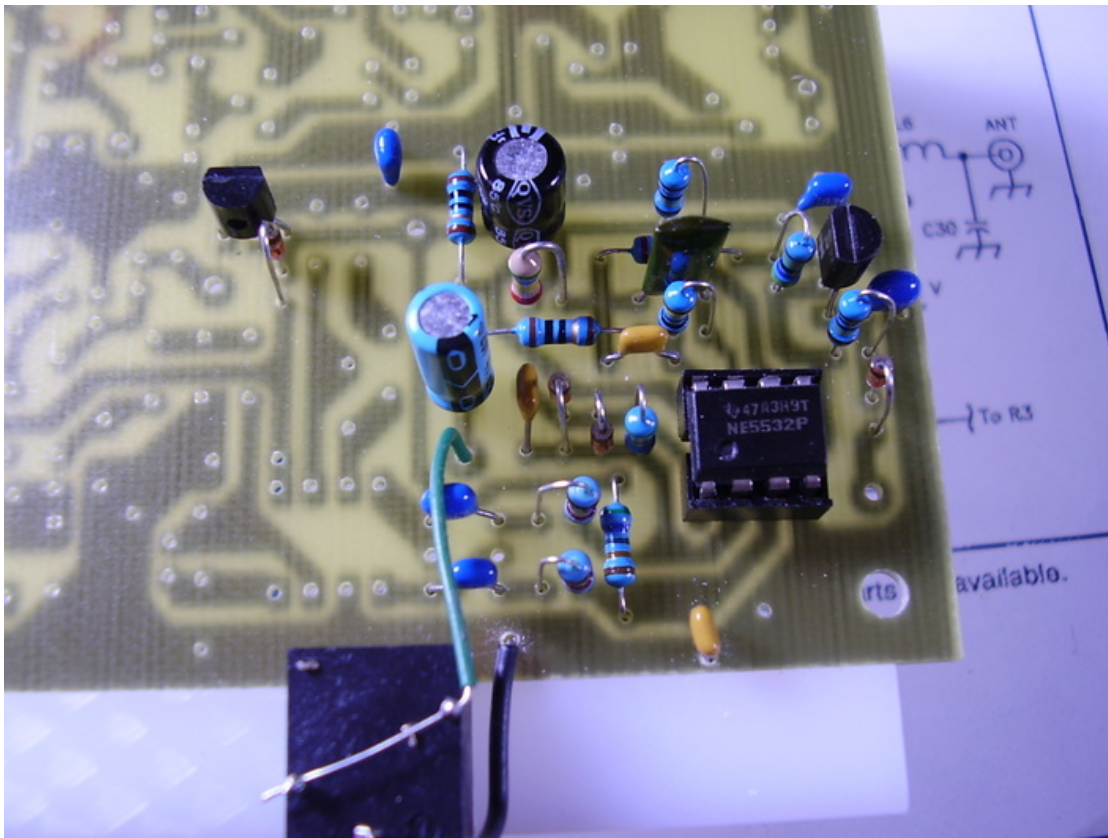

Figure 186: NE4040 audio section.

I choose to build a number of transceivers starting with the receiver. We can do this without a whole lot of test equipment to check things as we build.

Starting with the audio section as shown above. Temporary connect an audio jack so that you can connect headphones. I power up the board using a gel cell. Details a few photos later. Make sure you have the board off the workbench to avoid shorts. Make sure you have reverse polarity protection to avoid damages if battery is connected in reverse.

Use your fingers to poke at the audio section to see if you can induce a humm or noise in the headphones. Shows that circuit is working.

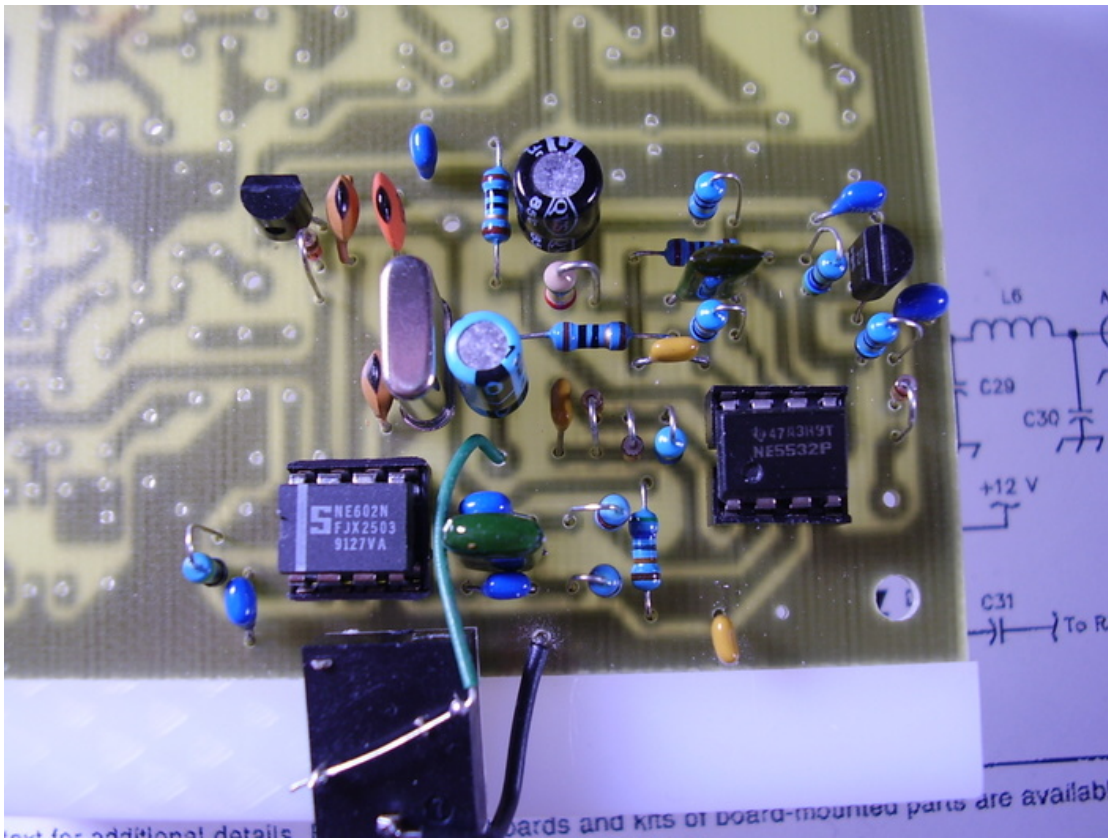

Figure 187: NE4040 second mixer section.

Now build the second mixer of the receiver. This generates the tone when a signal is present.

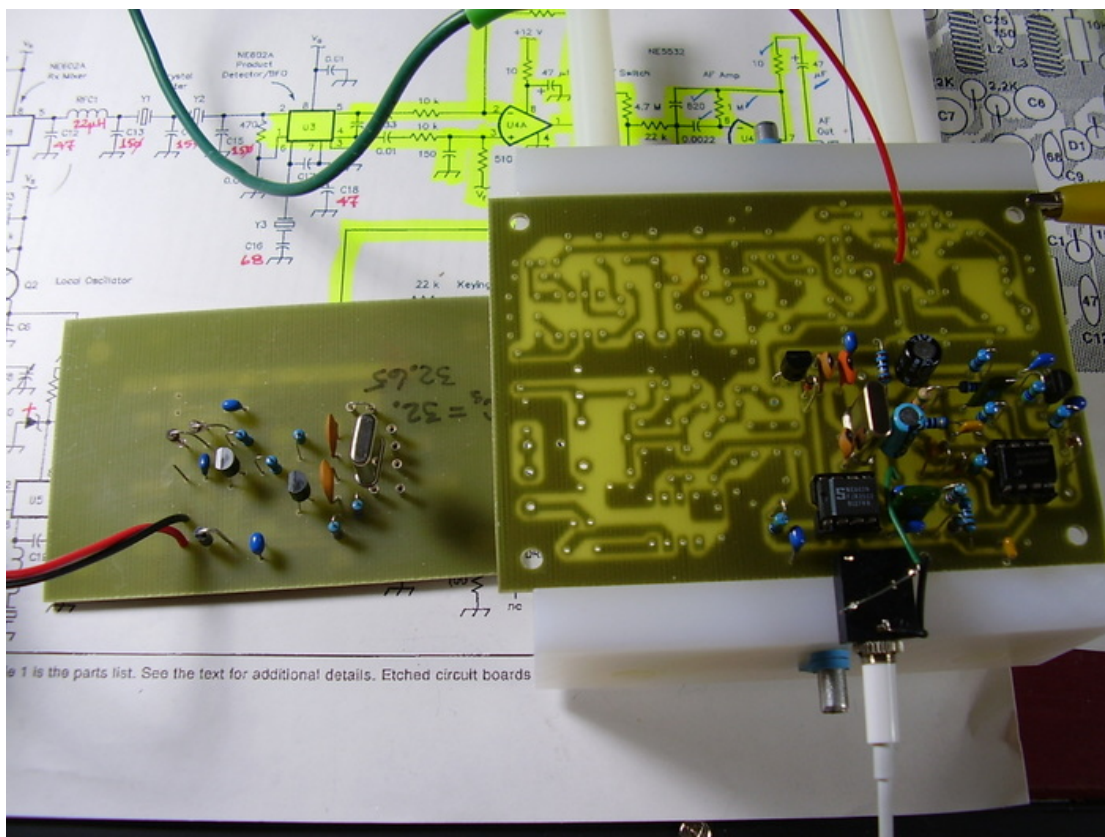

Figure 188: Testing with crystal generator.

You must have a crystal tester or here I am using a G3UUR crystal parameter oscillator. Take one of the remaining IF crystals and put it in the tester and power it up and power up the receiver. You should be able to hear a tone. You really don't have to get the oscillator very close to the receiver to hear it.

Note the red wire where +12V is connected. Yellow alligator clip in the upper right is to the negative terminal of the gel cell. I recommend you put a 1N4001 with banded end soldered where the red wire is to protect rig from reverse voltages. Will save you a hell of a lot of grief later in life. Been there. Done that.

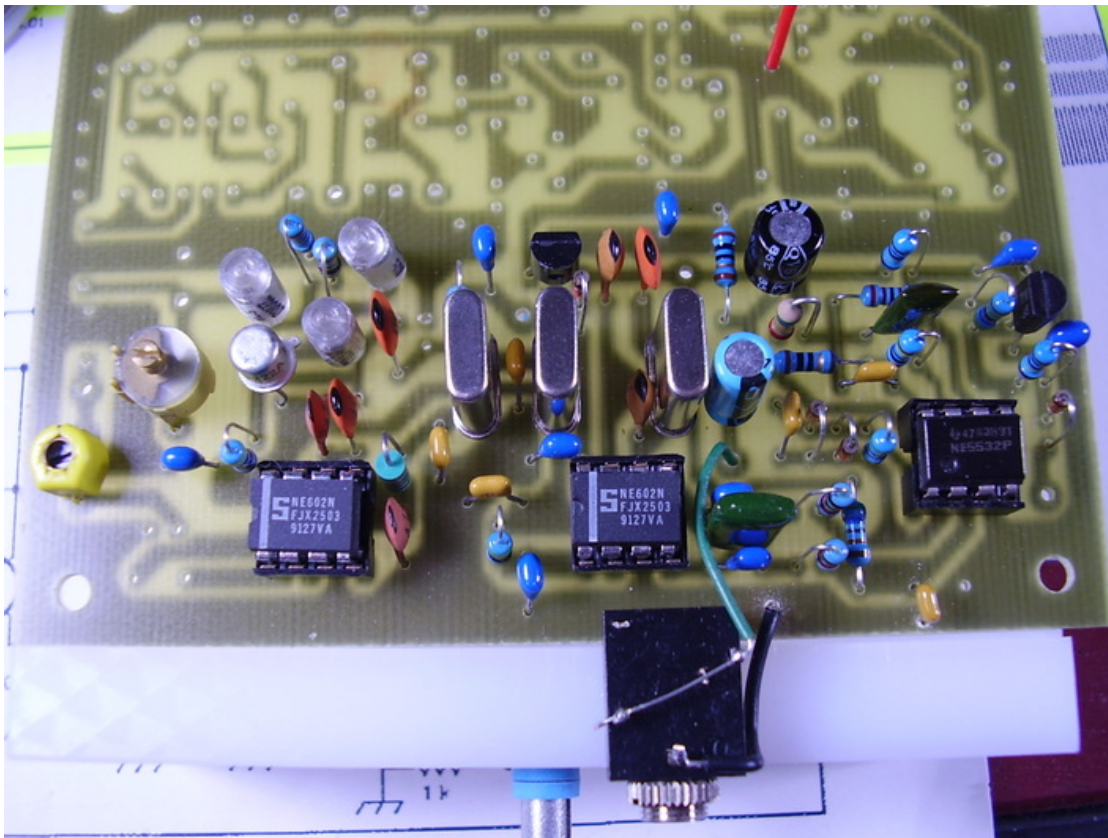

Figure 189: VFO, first mixer and IF filter.

Here is have the VFO and first mixer done along with the IF crystal filter consisting of two crystals.

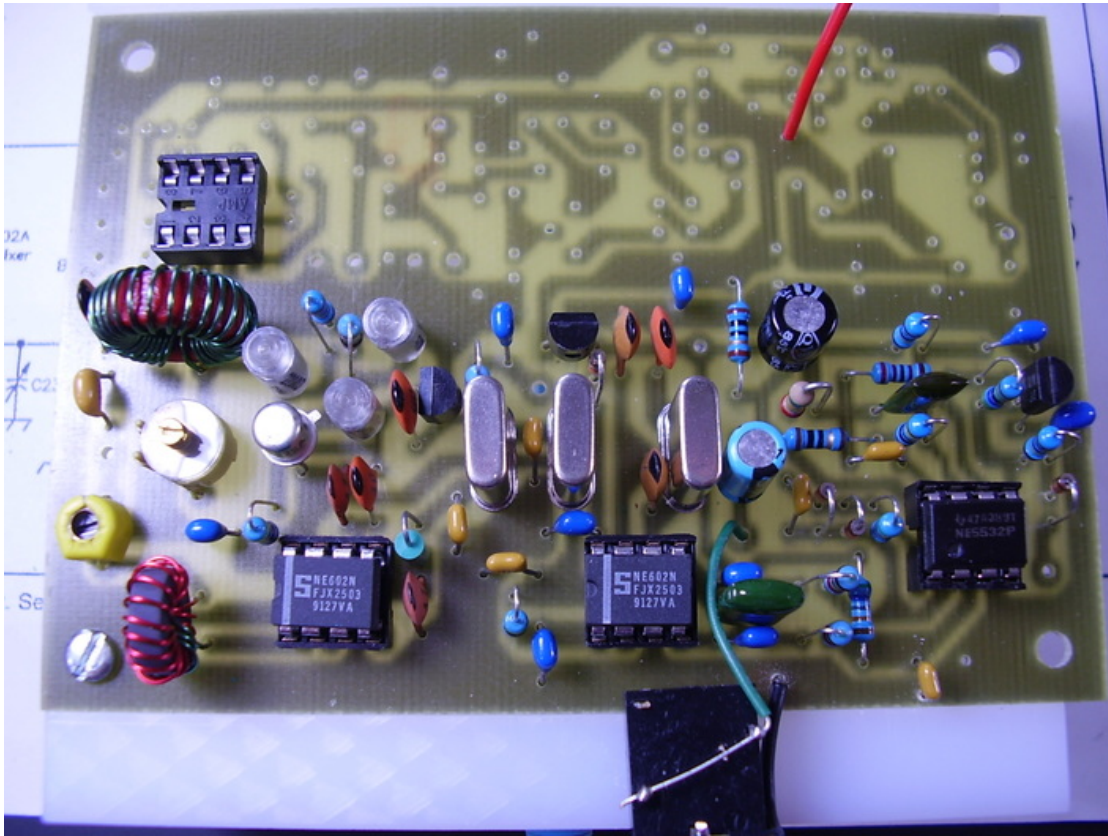

Figure 190: VFO completed.

Here you see that I have wound the toroid for the VFO along with the cap and toroid to the receiver input from the antenna.

Also using an IC socket for the first transmitter mixer. Need it to place frequency counter probe when checking the VFO frequency and operation.

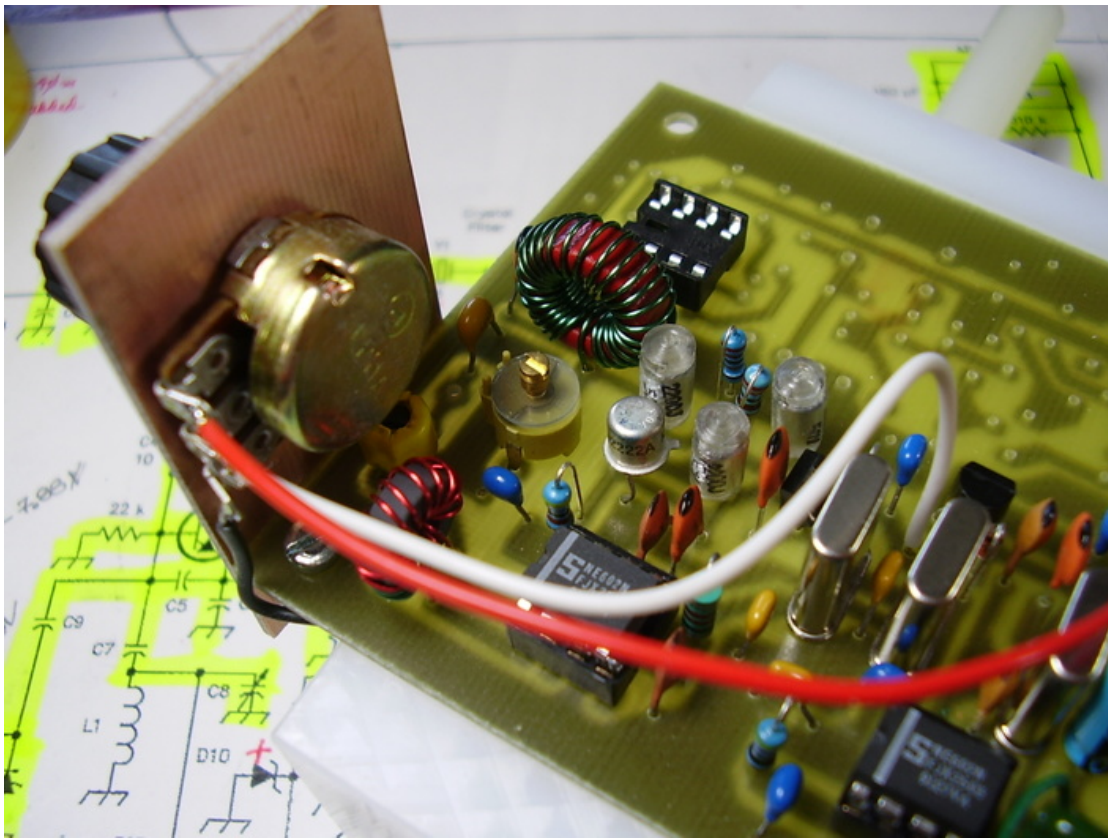

Figure 191: Variable resistor (pot) to tune added.

I have scrap pieces of PCB material in the garage that I use for tasks like this. Make a piece to mount the control pot to for the tuning of the VFO.

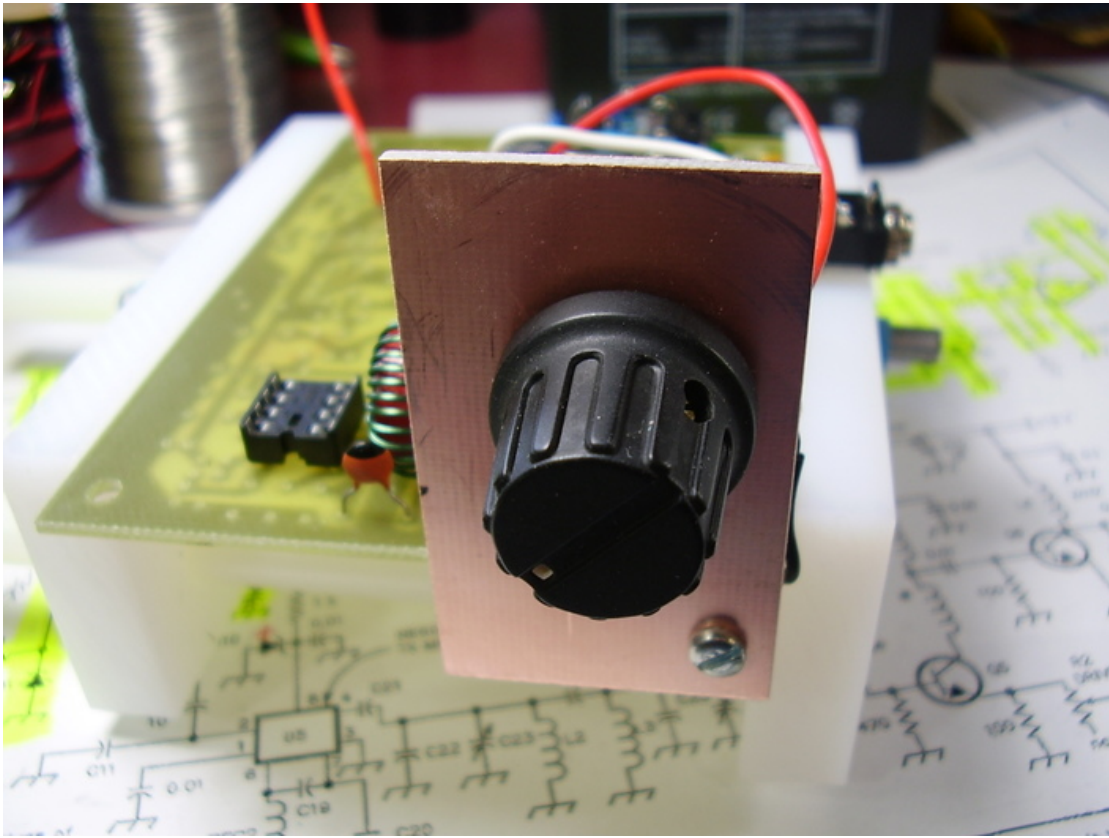

Figure 192: Tuning knob.

Now I can fire up the receiver and test the VFO and get it aligned to the desired frequency range.



Figure 193: Frequency readout.

Here is the frequency counter readout for the low end of the VFO range after some adjustment. I can also, if desired, look at the drift characteristics of the VFO with some timed measurements from cold start.



Figure 194: Frequency readout.

Above is the high end of the VFO range. By knowing the IF frequency I can figure the actual operating range of the transceiver when it is completed.

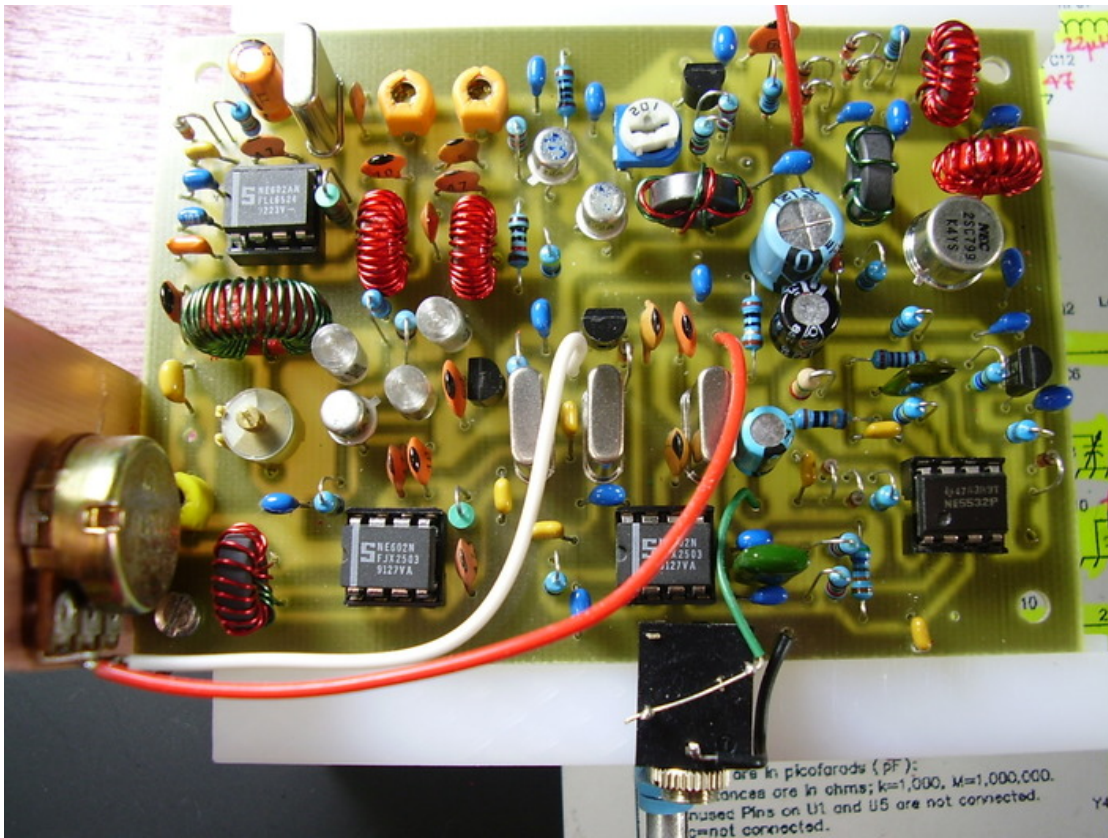

Figure 195: Assembled board.

Here the board is after the transmitter is finished. It was built from left to right in the upper sections of the board. Tested as I built using a scope to view signals.



Figure 196: NE4040.

The enclosure was home built from PCB material and painted with cheap Wal*Mart spray enamel. Color Place is the brand name. Slightly over a dollar a can. Works for me.

I am using a K1EL keyer in the back for keying. I love the little things and they are cheap.

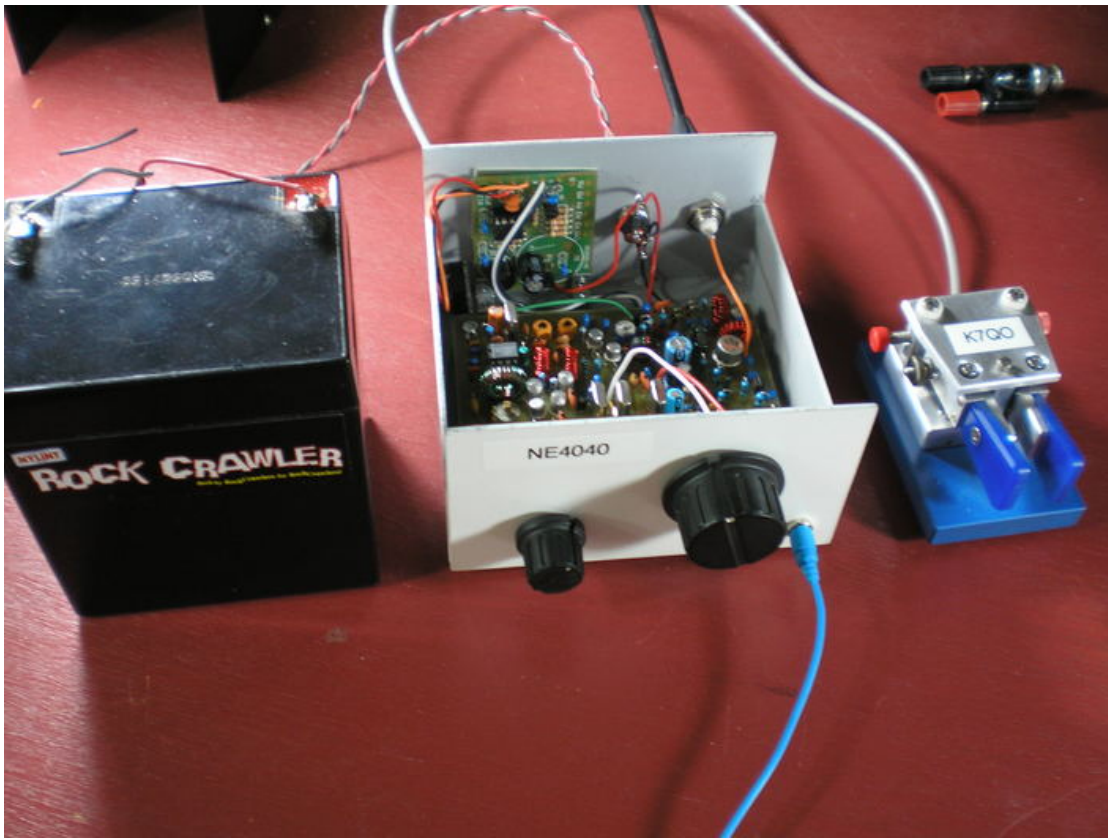

Figure 197: NE4040.



Figure 198: NE4040.



Figure 199: NE4040.

Chapter 22

The Inductor

In this chapter we will explore the inductor. The inductor is a passive component that typically consists of one or more loops of wire, either circular or square in shape, and may or may not have a ferromagnetic core within the wire structure.

The inductor, when current is flowing through it, has energy stored or contained in a surrounding magnetic field. This field tends to resist any change in the current flow. When the current changes in direction or magnitude an electromotive force or voltage is generated that tries to prevent the change. The electromotive force, the back EMF, can be exactly calculated using the formula

$$\mathcal{E} = -L \frac{dI}{dt} \quad (22.1)$$

where \mathcal{E} is the resulting back EMF for inductor L in Henries and the current I in amperes and time in seconds. The minus sign in the equation is a reflection of Lenz's law in physics; it says that the self-induced emf in a circuit opposes any change in the current in that circuit. We will also look into how to measure L using several techniques later in this chapter.

If the current is a sinusoidal waveform, then the voltage will be ninety degrees out of phase with the current. This is shown in the equation with the negative sign on the derivative. This is important. The ninety degrees is only when there is no resistance and the waveform is sinusoidal, either sine or cosine waveform function.

The voltage E in an inductor L leads the current I, thus the acronym ELI to aid in remembering the relationship.

The current I in a capacitor C leads the voltage E, thus the acronym ICE to remember the relationship for a capacitor until you get the hang of it.

22.1 Single Layer Air Core Inductors

For a single layer coil there is a formula for calculating the inductance of the coil. That formula is given by Wheeler's formula

$$L[uH] = \frac{r^2 * n^2}{(9 * r + 10 * l)}, \text{ or} \quad (22.2)$$

$$L[uH] = \frac{d^2 * n^2}{(18 * d + 40 * l)} \quad (22.3)$$

where

r = coil radius in inches

d = coil diameter in inches

l = coil length in inches

n = number of turns

Please note that the second equation is from chapter 2 in the ARRL Handbook, but no credit shown for Wheeler. The equation uses the diameter instead of the radius. What I do, for winding coils on 35mm film canisters, is to measure the diameter of the canister using a caliper and then measuring the outside of the wire diameter. Add the two measurements together and then divide by two. This will give you the diameter from center to center of the wire. Simple geometry problem.

The diameter or radius is measured from the wire center.

In the same light as above, double check every page that you visit on the Internet and the formula that is used for the online calculators. A number of them are in error and double check before entering the data

the unit of measurement. Some are metric as they should be. Here is the formula for metric measurements.

22.2 35mm film canister coil form

I have, over many years, saved a large number of 35mm film canisters from the landfills. I go to WalMart and Walgreens to their film processing centers and ask for 35mm film canisters they get in doing film processing for customers. The customer brings in their roll of film in the canister and center throws them away. I do not know how much longer they will be processing film due to the digital age overrunning the entire Universe as we know it.

I wound a 58 turn (58T) coil on the canister. Here are a couple of photos of the results. I did this coil using two horizontal placed holes about 2mm or so apart for the start of the coil. Please note, and this question comes up a lot. Does it matter which direction, clockwise or counter-clockwise, you wind the coil in? Not a damn bit. But, if you are winding a transformer, then it does make a difference, especially if the phase relationship between the input and the output matters. More on this in other sections.

Previously, I had placed the first two starting holes in a vertical direction. I think I now prefer the vertical placement as this will allow room below the coil and even with the bottom hole to place the output wire from the top of the coil at the same level as the other wire. I'll do another later on and show what I mean.

By the way. I tried at first to use a map tack to make the holes. These wound up being too small for the #26 AWG copper wire that I am using for the inductor. So, I wound up using a small drill bit and a battery powered hand drill to make the holes. Works for me.

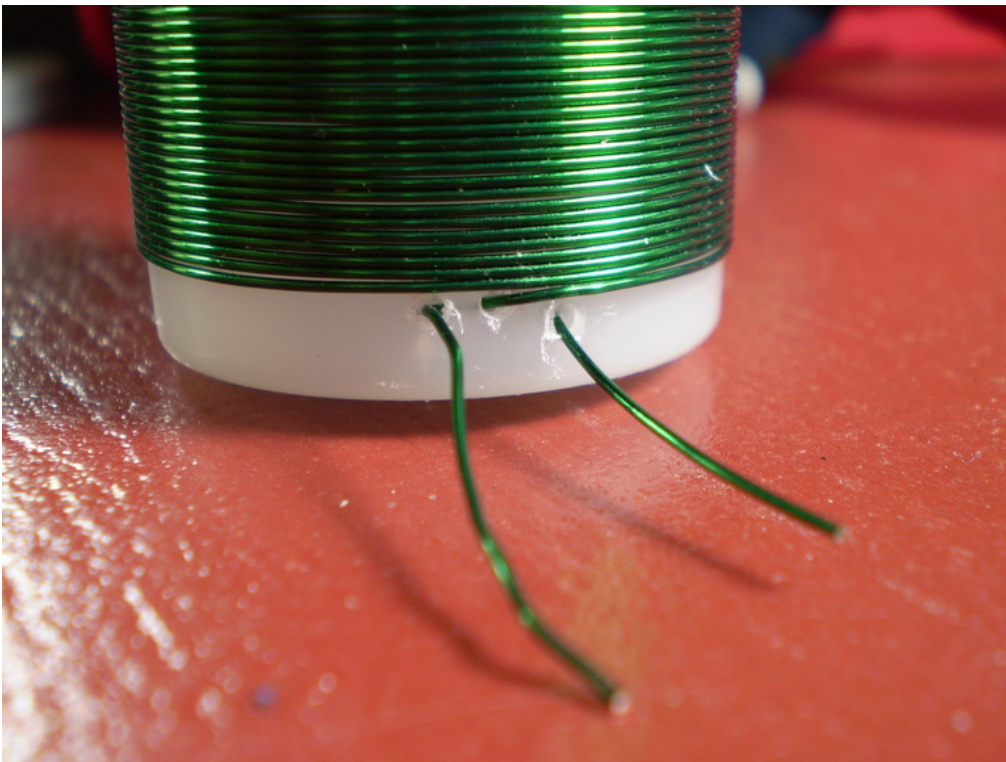

Figure 200: Coil form connection wire placement.

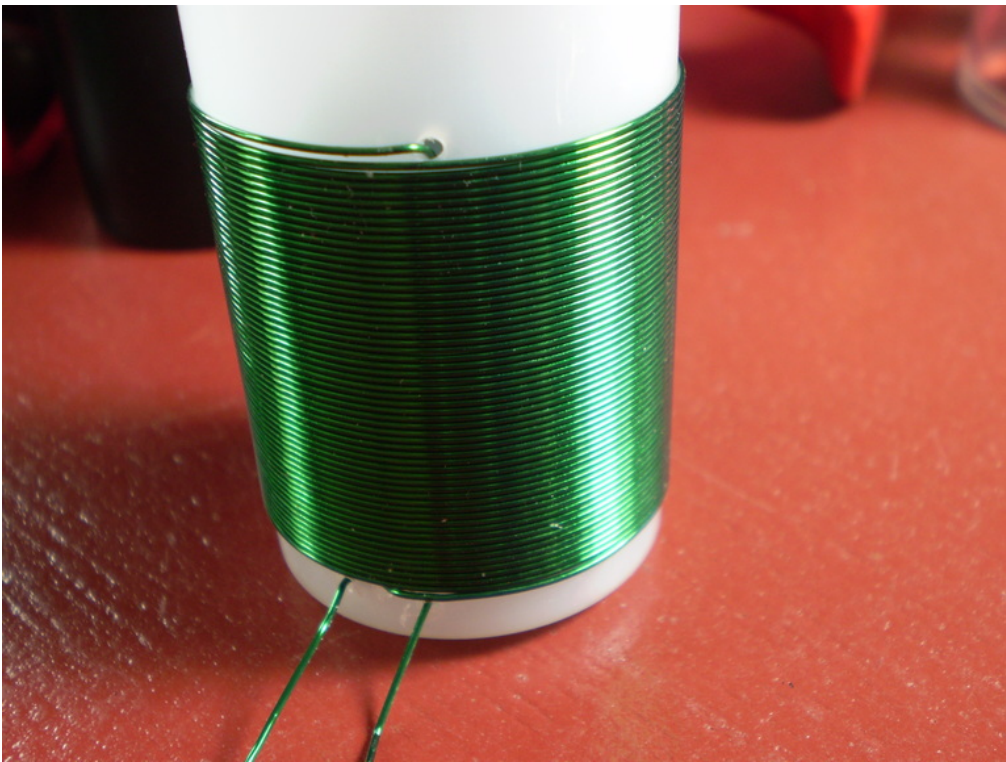

Figure 201: Complete inductor Coil.

22.3 Inductor Measurements with AADE L/C Meter

After assembling the coil, I used a computer program that I wrote using the [python](#) programming language. This while learning the language just for the heck of it.

I plugged in the measured distances for diameter and length and the number of turns that I wound. I got a value of $72.44\mu\text{H}$ for the calculation and using the AADE L/C meter I measured a value of $71.40\mu\text{H}$. This is less than a 1% error and well within the limits for what we typically do in ham radio experiments.

I then turned around and with another 35mm canister I made a coil using #28 AWG copper wire and wound 92 turns. The python program predicted a value of $172.47\mu\text{H}$ and the AADE meter measured $171.3\mu\text{H}$. So the Wheeler formula works very well for the geometry of a single layer solenoid type coil. May come back later and try some other geometries, but time is too valuable at the present to try everything possible. Let me know what you get in your experiments.

22.4 Q-Dope

OK. A much misunderstood topic on the Internet. Old literature and even some modern lit and web postings mention coating coils with Q-Dope. Q-Dope is a clear liquid in a glass bottle that is applied with a brush contained within bottle attached to the lid. The coating hardens upon curing at room temperature.

Q-Dope is difficult to find and is pricey. Just go to your local WalMart or Target and get a cheap bottle of clear fingernail polish. Works just as well and will save you a bundle of money.

The reasoning behind the coating is to lock the form into place to avoid generating microphonics when sudden movement or jarring occurs while in operation. Don't know why you expect sudden movement on a desk top, but I guess it does occur. For field operations then the coating is probably justified. I rarely coat coil forms. Some believe

that it will help thermal drift reduction, but I have to see some serious experimentation that is reproducible to believe it myself.

22.5 Distributed Capacitance of inductors.

Note that the formula for the inductance value is dependent upon the physical dimensions. For the close wound coil shown above, there is no room to squeeze turn together or expand to change some effects.

I get tired of people posting on the Internet that squeezing coil windings closer or expanding them changes the L value. BS. What is really happening is you are changing the distributed capacitance caused by non-conducting material(s) between the windings. Yes, due to the formula there may be a change in the values, but the main effect is going to be the capacitance between loops.

Here is how this works. The copper wire has resistance. I have a table in the first appendix of this document showing what the typical resistance is for copper wire for the AWG wire size. OK. Take two continuous loops of the coil. Each loop has both inductance and resistance associated with it. Because the loops are in series the inductance and resistance values add up. The total coil resistance and the total coil inductance is the sum of the resistances for each loop in the coil and the inductance of the loops added up.

Between corresponding adjacent points on each loop is a voltage difference. It is the same everywhere in the loop, neglecting edge effects, thus the need for the length of the coil to be more than forty percent of the coil diameter for the formula to be accurate. You can calculate this voltage difference by knowing the resistance for each loop (R_l), which is $R_l = l \times \rho$, where ρ is the resistance per unit length of the wire and l is the length of the loop of wire. The voltage difference or potential between the two loops is $V = I \times R_l$ where I is the current through the coil.

Now we have two conductors separated by some distance and with a voltage difference between them. This makes a capacitor. There are capacitors between every loop, but what saves us from disaster is that these capacitors are in series and thus the total capacitance generated from the geometry is less than the smallest capacitance in the series.

You need to know the formula for series capacitances in order to derive this result. Not really difficult.

So, for every inductor there is a resistance in series with the inductance and a capacitor in parallel. This is very similar to the model for a crystal unit. The reactance of the capacitance is hopefully small in comparison to the inductance at the operational frequency. If not, then you have to take it into account in building and using a circuit.

What happens, and we'll take a closer look at it later in this chapter, is that L/C meters use an oscillator that generates either square or sinusoidal waveforms to make a measurement of a component. This waveform causes some reactance value for the inductor, but at the same time there is a negative to this introduced by the capacitive reactance. Thus the measured value may be smaller than the calculated value as we saw in the coil that I constructed above.

Because an inductor has both inductance and capacitance in parallel, it is a resonant component and has some resonant frequency called 'self resonance' which we can measure and will later.

We could eliminate the distributed capacitance by making the resistance of the coil zero, but that would require super conductivity and beyond the normal expense we want to go to for our experiments and work.

Chapter 23

40/20 Meter Transceiver

This is an experiment in creating a transceiver that uses many of the same parts and can be built for either 40 or 20 meters. Now, like any experiment this can work or it can fail. We won't know until the final testing is done. But that is what experimentation is all about. You can't live if you are afraid of dying.

So, let us begin.

23.1 The VFO

The heart of a transceiver is typically a common frequency source. If the source is fixed, typical of a crystal controlled rig, then the transceiver works on one frequency only. This is the basis premise of the Small Wonder Labs Rock Mite and other similar transceivers.

If the common frequency source can be changed, then we have a variable frequency oscillator (VFO) or variable crystal oscillator (VXO) when the primary frequency control is a crystal, but circuitry has been added to vary the crystal frequency. For this transceiver I am going to use the Colpitts oscillator that Dave Benson, NN1G at the time, used in the NE4040 transceiver that was a kit put out by the New England QRP Club in 1994. Dave has given me permission to use the design as a teaching aid and for that I thank him.

Here is the schematic for the VFO. Please note. There is a missing con-

nection, noted by the dot and label 9 at the joining of the two wires of resistor R19 and collector common point for the NPN transistor, 2N3904 2N2222 2N4401 or others will work here.

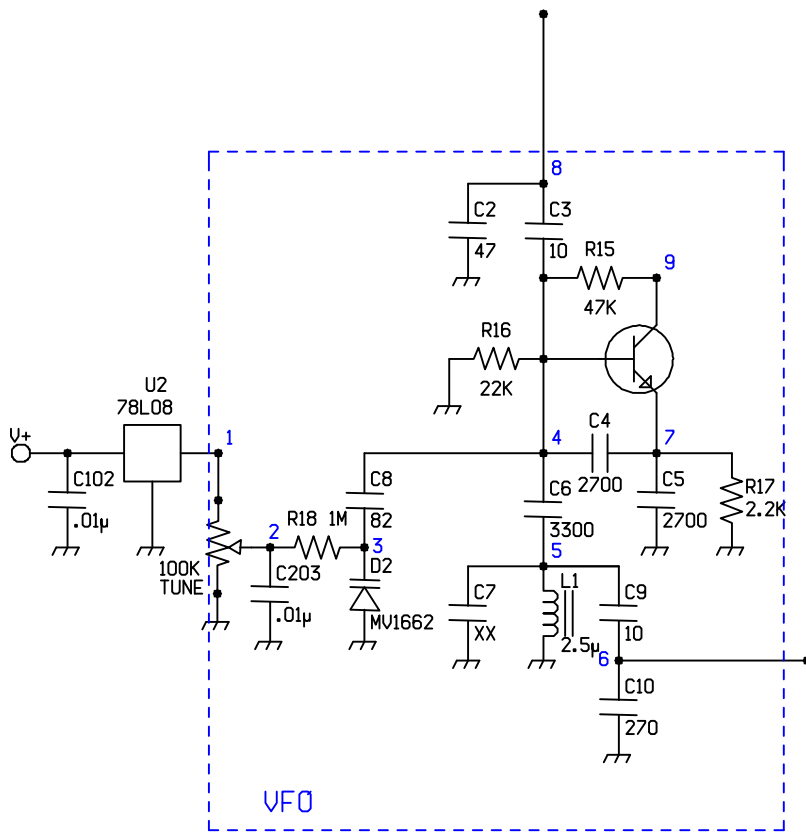

Figure 202: Colpitts VFO.

Note that I have labeled some of the nodes in the VFO with numbers in blue for ease of discussion.

The VFO is a Colpitts oscillator. I like the colpitts oscillator as it does not require a tapped inductor, which for many is a difficult configuration to wind on a toroid.

Any resonant frequency of an oscillator is determined by an inductor and capacitor combination that satisfies the formula

$$f = \frac{1}{2\pi\sqrt{LC}} \quad (23.1)$$

Let's start with L. The inductor L in the vfo circuit is a T50-6 toroid wound with 25 turns of #22 wire. If we go to <http://www.kitsandparts.com> and use a web calculator for toroids we find that the toroid has an inductance of 2.50μH.

In order to determine the desired VFO frequency, we first need to know a couple of things. The first is the IF frequency for the receiver and the second is HF frequency we want to operate at. Let's first start with the 40 meter band and use the QRP international calling frequency of 7.030MHz to start our analysis. Because I won a bid on ebay for 11.059MHz crystals, I plan on trying to use a lot of them in the future and that includes this project.

In order to get to 40 meters, I need a frequency that will subtract from 11.0592MHz to get to 7.030MHz. That means a frequency of 4.022MHz for the VFO at that operating point in the HF spectrum.

What capacitance must we see across the L of 2.50μH? Plugging into the frequency formula we get a capacitance value of 626pF.

Now I do not trust myself with a calculator. Too many ways to make a mistake and I have to do the calculations at least twice to double check my work. Now I just write a quick python program to do the calculation. Here is the code that I used for the above calculation.

```
l = 2.50e-6
f = 4.022e6

c=1.0/(2.0*2.0*3.14159*3.14159*l*f*f)
print c
```

The good thing about a piece of code like the above is that it is handy to come back and modify the values for another frequency. I also have a copy to double check against for programming error. Not likely with something this simple. I did take the scientific calculator and did the calculations and got the same result, so I'm not totally incompetent with a calculator. :-)

23.1.1 Capacitor calculations

We know L, let's see if we can determine C across L in the colpitts oscillator. I am going to neglect resistance in the coil and the wires for this calculation as we are not going to calculate the Q of the circuit.

Start at node 5 in the schematic. There is C7, L and then C9 and C10 (in series) all in parallel. Then from node 5 we pass through through C6 to three dual capacitor series combinations to ground. This sounds complicated but here is the schematic for the inductor and capacitor combination.

Looks complicated, but it really isn't. Just some simple mathematics and I'll show you the steps here. First. There are two unknowns in the schematic. The first is C7 marked with value XX. This is a cap that you do not put in until you first test the VFO powered up with all the rest of the caps in play. Then, if the frequency of the VFO is running too high, you add a cap to bring the frequency down. Remember the frequency is inversely proportional to the square root of C and increasing C brings down the resulting value.

The varactor diode is shown as D2. If you go to the following web site, you can purchase the cap for about \$2 for one including the postage. By buying more you can reduce the cost of a varactor diode down to close to 85 cents (US currency) per unit. I bought some of the MV1662s that I have in my parts collection from Earl and he is easy to do business with. This was some time ago and he still has a few of the diodes left as determined by his web page.

<http://www.earlandrews.com/MV1662.html>

Look at Figure 4.11 for a curve that shows the capacitance vs voltage curve for this part. Let's pick a value of 100pF for D2 to plug into the formula for the frequency in the LC combination for this VFO.

I am going to do the math from left to right in the figure.

C3 and C2	8.3 pF
C8 and D2	45.1 pF
C4 and C5	1350.0 pF

Total for the three combos in parallel is 1403 pF.

C6 and combo 984 pF

C9 and C10 9.6pF

Total capacitance is 994 pF.

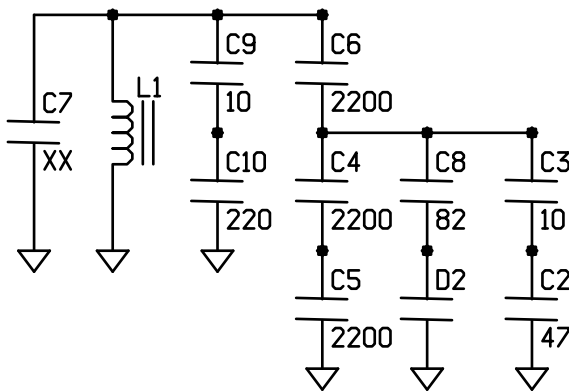

Figure 203: LC network for VFO frequency.

This in parallel with the $2.50\mu\text{H}$, results in a resonant frequency of 3.19MHz, which is higher than expected. For the NE4040 the IF frequency was 4.00MHz and thus for 40 meters we would like a value of 3.030 MHz to get to the QRP frequency of 7.030MHz. Double check my calculations above. I'll leave things as they are and we will build the circuit and see how the physical results compare with the theoretical calculations. With the C7 cap in parallel, by adding capacitance in parallel we will lower the operating frequency of the VFO and thus can bring it into alignment with the desired frequency range.

Since the VFO frequency with 100 pF for the varactor diode is too high at 3.19MHz, let's go and add one turn to the toroid and make it 26 turns or an inductance of $2.70\mu\text{H}$. This brings the resonant frequency down to 3.07MHz, which is closer to the desired value and we can tweak the circuit after that very easily.

23.1.2 SPICE Simulation of the VFO

Here is the output from a SPICE simulation of the Colpitts oscillator. I use [ngspice](#) with the linux operating system to do all my simulation work. I did the simulation as part of the Elmer 101 series that was done on QRP-L using the SWL-40+ transceiver for a series of tutorials on kit building and understanding of the different building blocks of a rig. What is interesting is that the series of tutorials is online. The analysis of the Colpitts oscillator has an error in determining the C value across L1. Hopefully I got it correct here. The graph shows that when the VFO is powered up there is a delay of almost 10 microseconds before the output reaches a near stable amplitude.

We do not have to worry about the start up time as the VFO runs continuously when the rig is powered up.

In the VFO section all the caps that we did the calculations with must be either COG or NPO so that the VFO does not drift significantly during the warmup period. When the transceiver is powered up there will be some heat generated do to power losses in resistors and other components and this heat will cause some drift and if care is not taken the drift will be significant and make it difficult to use in day to day operation. Building the VFO and testing it will insure that we do all that we can to make it stable.

23.1.3 Winding the toroid and measurement

To check the work so far, it is time to build the VFO. First, I'll wind the toroid and measure its inductance using the AADE L/C Meter II and my

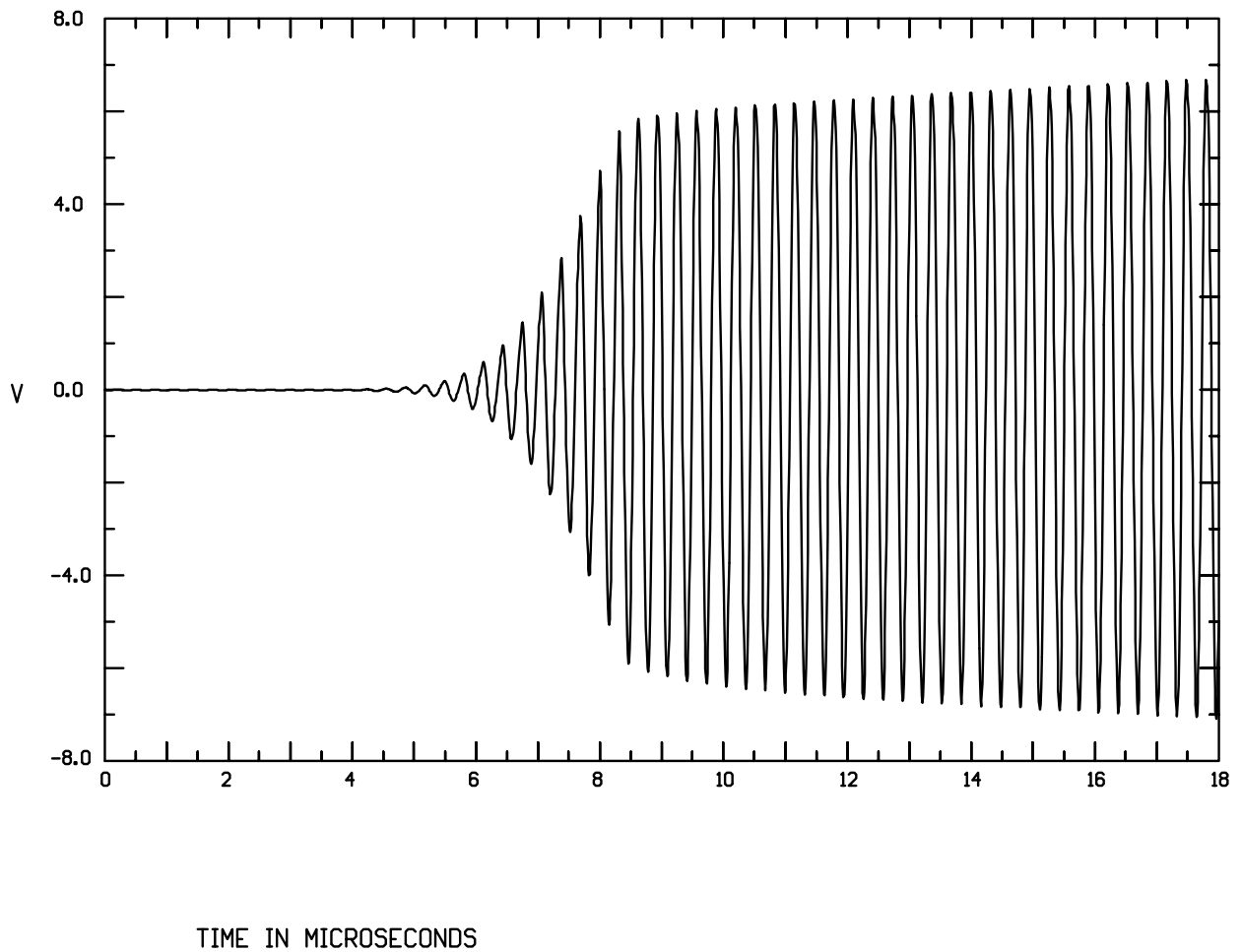

Figure 204: Colpitts VFO simulation.

own fixture.

Winding the toroid is fairly easy. Just don't rush the process. The first thing I see a lot on the Internet is the question about wire size for toroid coils. The inductance of a coil is determined by the number of turns. The larger the wire size the lower the internal resistance of the length of wire used to wind the coil and thus a resulting higher quality factor, Q, for the coil. But, if you do not have the wire size called for, a smaller diameter sized wire (higher wire size number) will work. A larger diameter wire size may not be possible depending upon the number of turns required and the diameter of the toroid.

Note also that the direction in which you wire the toroid, as long as the number of turns is the same, does not affect the resulting L value. The winding direction does effect the position of the two wires and their placement on a PCB. So, if you are building a kit, make sure you look at the wire placement on the PCB before you wind the toroid to make sure that the wires are aligned correctly when putting into place and soldering. It is not a happy day when you have to unwind a coil and redo it. There is no hard and fast rule as to which direction toroids should be wound. I prefer what corresponds to what Diz calls counterclockwise.

Here is a URL for a site with a set of nice photographs to illustrate the clockwise and counterclockwise directions done by Diz, W8DIZ, at kitsandparts.com.

<http://tinyurl.com/nf2jf2w>

23.1.4 Transmitter Mixer

The function of the transmitter mixer to to combine the VFO frequency and a frequency generated by a crystal oscillator to generate the RF frequency to be transmitted. This is the reverse of the process of taking a received signal and mixing with the VFO to get the IF frequency.

The process of mixing is going to generate a sum and a difference of the two frequencies fed into the mixer and some other nasty products. So, following the mixer we need a bandpass filter to seperate out the desired transmitter frequency. Here is the schematic of the additional mixer and bandpass filter.

In the toroid chapter in this document I showed a one wire fixture to sort toroids when -43 and -61 toroid types get mixed up. I am going to be OCD here and measure some T50-6 forms to match the A_l values for the two coils I am going to wind using the two directions. I am going to use #24 wire as I do not have a quantity of #22 wire on hand and I am going to do 25 turns (25T) for each coil.

OK. Made a decision here to change the VFO frequency and to go ahead and add the first transmitter mixer in order to kill several birds with one stone. If I am going to prototype the VFO using a muppet board, then I might as well go ahead and do a board that has another section or two of the transceiver and build and test in sections. If I use 11.059MHz for the IF frequency, then work on 20m, then to get to the QRP calling frequency of 14.060MHz we need a VFO frequency of 14.060MHz - 11.059MHz or 3.001MHz. Using the 994pF capacitance calculation the L1 inductance needs to be 2.83 μ H. Looking at the W8DIZ calculator, we will need 27 turns on the T50-6 toroid.

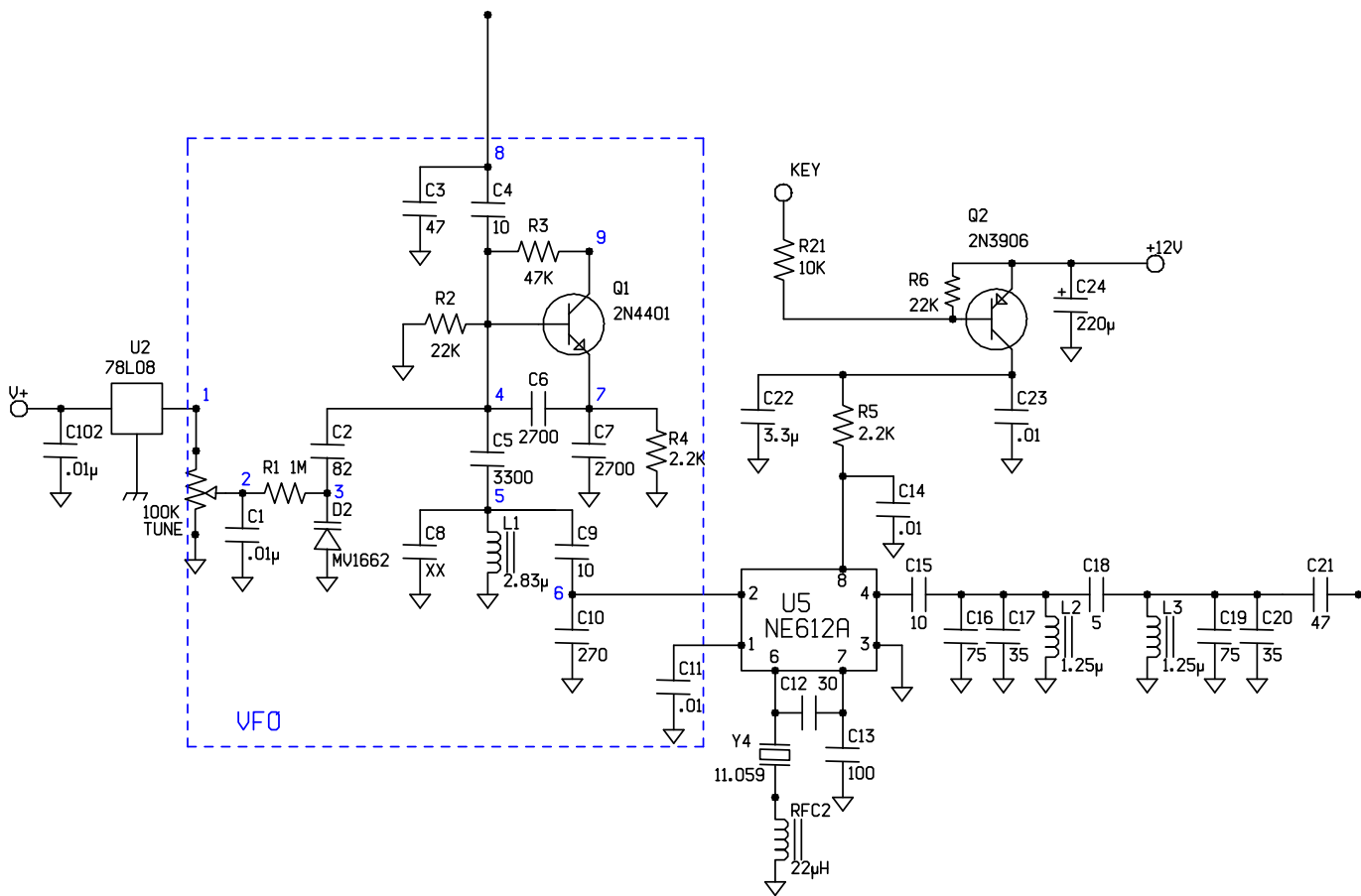

Figure 205: VFO and transmit mixer followed by bandpass filter.

23.2 First Section Build

OK, now is the moment of truth. I am going to build the transmitter section shown on the previous page. I have gone and added Q2, which is part of the keying circuit. I'll come back and add the labeling later. It is not important right now.

The purpose of having the keying circuit turn on and off the transmit mixer is to keep from hearing the local oscillator VFO converted to the frequency on which we are listening and transmitting on. You and I do not want to hear the signal interfering with any one we are working on the air.

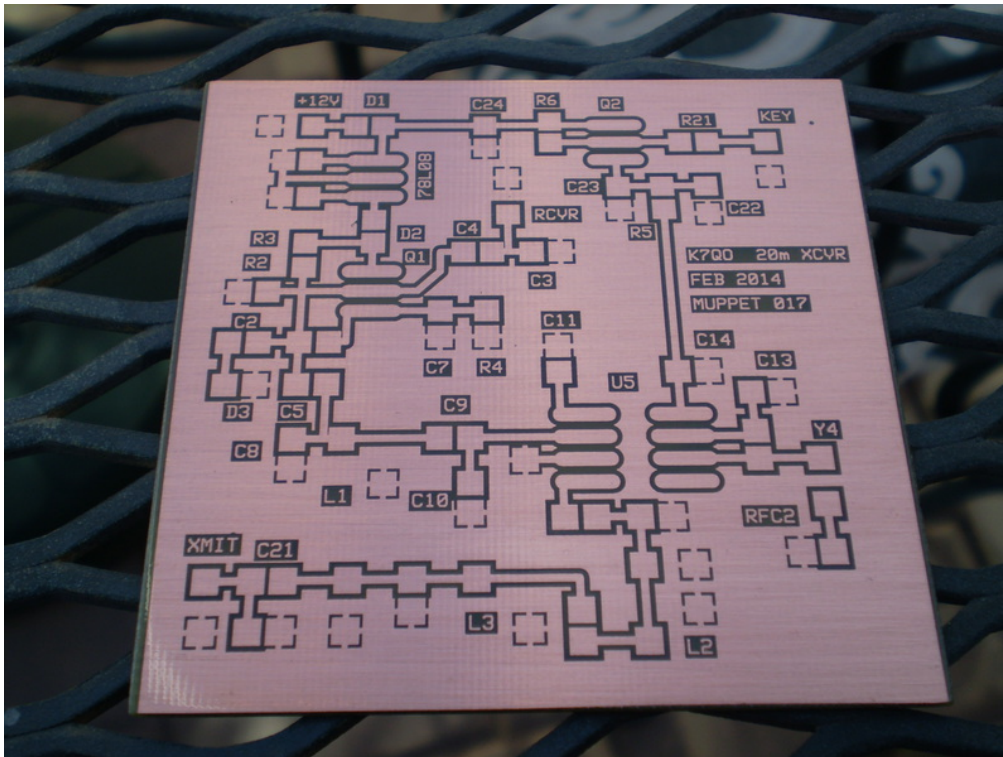

Figure 206: Muppet board for the VFO section.

Now this muppet board is just for the VFO, keying circuit and first transmitter mixer. I could have sat down and laid out the entire transceiver, but I have yet to design a driver and PA section for the transmitter. The original NE4040 and SWL-XX+ series from Dave only put out about 2W.

In most cases about 1.5W, which for a beginning QRPer is asking too much IMHO. You have to have a lot of patience and a good antenna to be successful. I have done WAS on 40, 30 and 20m with 0.95W and I can tell you it took a lot of time on the air to get it done. If it was easy, everybody would be doing it.

OK. Here is the photo of the build up to the VFO. I build the voltage regulator section and measured its output at 8.07V. This just to make sure I have everything right. It is of no use to build everything and then have to look for problems. I am a big fan of build things one section at a time in logical order and test each section.

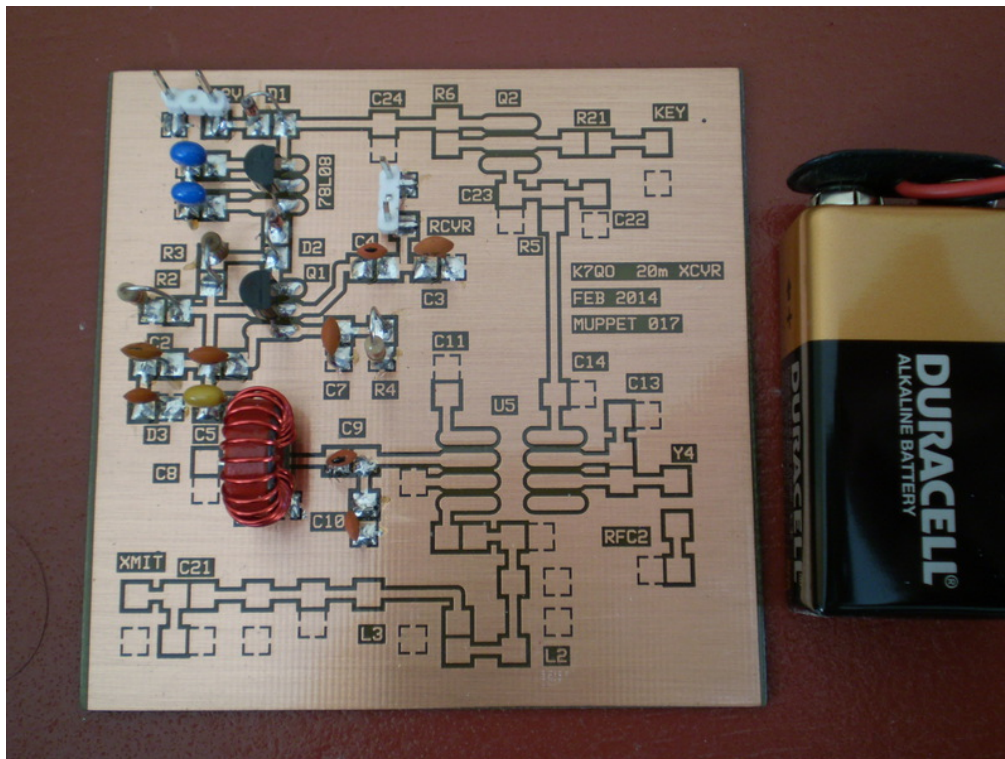

Figure 207: The VFO section up and running.

I built the VFO section. Powered it up and use a scope to measure the output at nodes 6 and 8 in the schematic to make sure the oscillator is working. I am getting about 25mV out at the input to the mixer of the transmitter, pin 2 of the NE602A. This is the same value that I get from measurements on a working NE4040 transceiver.

The RF voltage level is too low for any frequency counter that I have, so there is no need to adjust the operating frequency of the VFO at this time is ever for this first experiment. This board is not going to be used in a final build.

I laid out the board using ExpressPCB and without the use of the schematic capture routine of ExpressPCB design software. I just take the schematic and use the computer screen to lay down the pads and traces. So, the layout is not going to be the final version as I learn as I go on just where the optimal placement is going to be. And, I don't care if you or any one else can do better. This is not a competition. It is fun for me and my aim is to just get a good working rig up and running on the air.

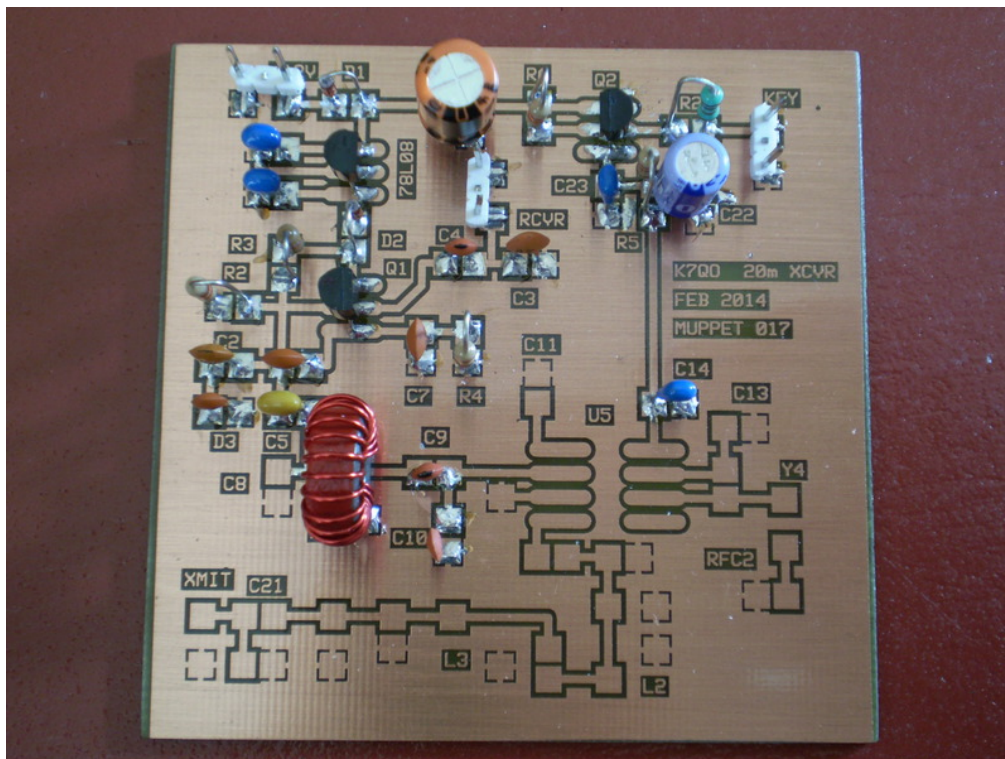

Figure 208: The keying section added.

The keying section is fairly straight forward. When the input to the base of the 2N3906 is pulled to ground (shorted or brought low by a key or keyer) the transistor begins conduction and thus a voltage is applied to the transmitter mixer. This turns on the NE602 and allows the output from the VFO being fed into pin 2 and at the same time

turns on the local oscillator with the 11.059MHz crystal and feeds the sum and difference of the two frequencies to the output.

The desired frequency is selected by the bandpass filter.

Here is the photo with the mixer installed and working.

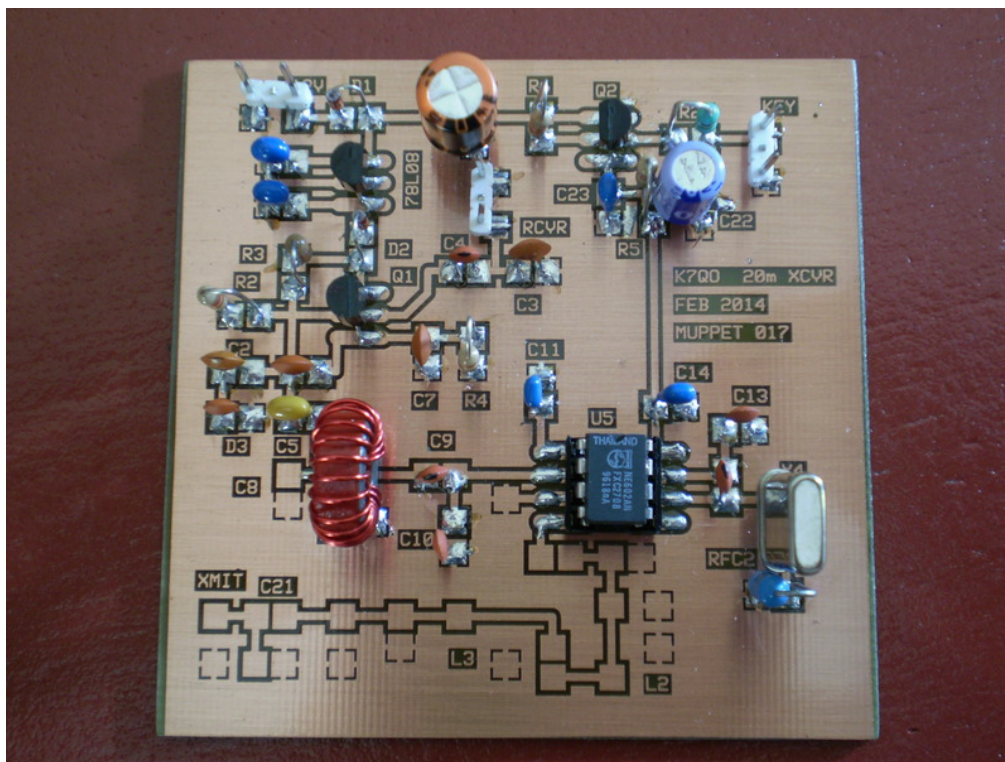

Figure 209: The transmit mixer section added.

At this point, after looking at the output from the mixer and seeing that all is working as expected, I have decided not to build the bandpass filter section. It is all passive components and easy to tune to the frequency range desired. And my supply of variable trimmer caps is limited and I want to not run out of them.

23.3 Drivers and Final Power Amplifier tests

In this section I want to look at a selection of power amplifier circuits and power transistors to determine what I want to use for both 20 and 40 meters.

This will involve some test fixtures and some self destruction tests to determine what will stand up to some abuse and still survive afterwards.

Chapter 24

Manhattan Style Construction

Some history as to how the term "Manhattan Style Construction" became known to the QRP radio amateur community and then the rest of the world at large.

At Dayton in May of 1998 there was a building contest sponsored by the NorCal QRP Club. The purpose of the building contest was to build a complete transceiver using only 2N2222 transistors. The idea came from Wayne Burdick, N6KR. I was one of the judges for that contest at Dayton that year. The first place winner was Jim Kortge, K8IQY, with his entry of a 40 meter transceiver made up of only 2N2222 transistors with no IC chips to be found anywhere in the design. He built the rig using the Manhattan Style technique and he used the phrase which his son used in college in an engineering program where they built this way. Since the contest at least 16 of the K8IQY rigs have been built using the same construction technique and used on the air to make contacts and the number is growing. You can see Jim's work at

<http://www.k8iqy.com>

if you have Internet capabilities. It is worth the time and effort to visit the site.

The Manhattan construction consists of using a printed circuit board as the ground plane to build the project on. Parts, such as resistors, capacitors, diodes, transistors and other electrical components are soldered to 'pads' made up of either rectangular or circular PCB material that is super glued to the base PCB material. These pads act as a physical

support and an electrical insulation between the circuit board and the node itself.

When a circuit is completed and laid out in an orderly fashion the resulting project reminds one of the regular pattern of buildings and streets in downtown Manhattan, thus the terminology.

This chapter will give you the information needed to begin construction using the technique and you too can build projects that look nice and work very well.

24.1 Printed Circuit Board material

The first thing you will need is a source of PCB material. I am a fan of a vendor on ebay known as [abcfab](#). You can find his store by searching for the phrase 'copper clad pcb' and then find one of the items that has a link to [abcfab](#). He has a one-hundred per cent rating.

There are mainly two types of pcb material you will find to chose from, CEM and FR-4. CEM stands for composite epoxy material, which is made up of the copper layer, a glass fabric surface and a cellulose paper based laminate interior. The FR (flame retardant) material has a fiber glass epoxy interior and is much harder and much more difficult to use as pad material. For Manhattan construction you want the CEM material and for etching printed circuit boards you want the FR-4 material.

For those not familiar with the terminology. DS and SS refers to double sided and single sided copper layers. Single sided board has the copper layer on only one side and the double layer has a layer of copper on both sided of a sheet of the material. For Manhattan construction it doesn't make much difference which one you use. If you are going to also be using the material for construction of an enclosure, then by all means get the double sided board.

You will also see a number of the thickness of the board. I typically use 0.040" through 0.060" for board material as I like the stiffness of the board, especially for enclosures. I will later show you some measurements on just how much capacitance a pad has dependent upon the board thickness and whether it is single sided or double sided material. For the retentive in the audience.

One more parameter is the copper plating thickness measured in ounces per square foot. Most of the board material is 1 oz or one ounce per square foot which amounts to a copper layer that is about 0.0013" in thickness. This is not critical for Manhattan construction, but is for etching as the thickness determines the time required to etch the material away in an etching bath and the amount of power you can carry in the traces laid out in the pcb pattern. Since we are not using the board as traces, we don't care. The board plane upon which we are going to lay out a project is continuous, it can handle some pretty healthy current flow, but we are supposed to be using this for QRP projects where power levels are relatively low.

The main advantage of the large copper plane is reduced inductance for RF circuit ground plane.

24.2 Cleaning Board Material

If you run across the Manhattan building article that I did over a decade ago, please ignore it. Have the person or persons that have it on the web remove it.

I used to use Tarn-X and other chemicals to clean finger prints and corrosion from the copper layer. Now I just use either steel wool or the 3M paint pad as shown in the Muppet Board chapter. The scrubbing thus does not use hazardous and expensive chemicals and is faster. Just wash and dry the board afterwards to remove metal filings that may come back and haunt you as a short in your project.

After you clean the board, keep your dirty hands off it. Use gloves as you will be handling the board by the edges to punch out pads. This prevents you from cutting yourself on sharp board edges. Make sure to run a sandpaper pad along the board edges to remove sharp metal fragments that can hurt you. Been there. Done that. Experience is a harsh teacher.

24.3 Making Pads

There are a number of ways of making the pads upon which we are going to build the interconnections of a circuit. Jim Kortge started out using an Adel nibbler to make rectangular pads. I did not have much luck with this procedure, so I adopted the procedure of using a metal punch. The first one that I got was from Harbor Freight, but unfortunately they have discontinued carrying the punch. So here is one source of a punch and you can do a Internet search to find the best deal. Look for sales, but don't wait too long. You want to get started on this building technique as soon as possible in order to not let too much time pass by. The clock is ticking.

<http://tinyurl.com/njxk7f8>

This URL may disappear, so I will try to come back and add another when I find a source that is stable. The problem with the Internet is things come and go rapidly.

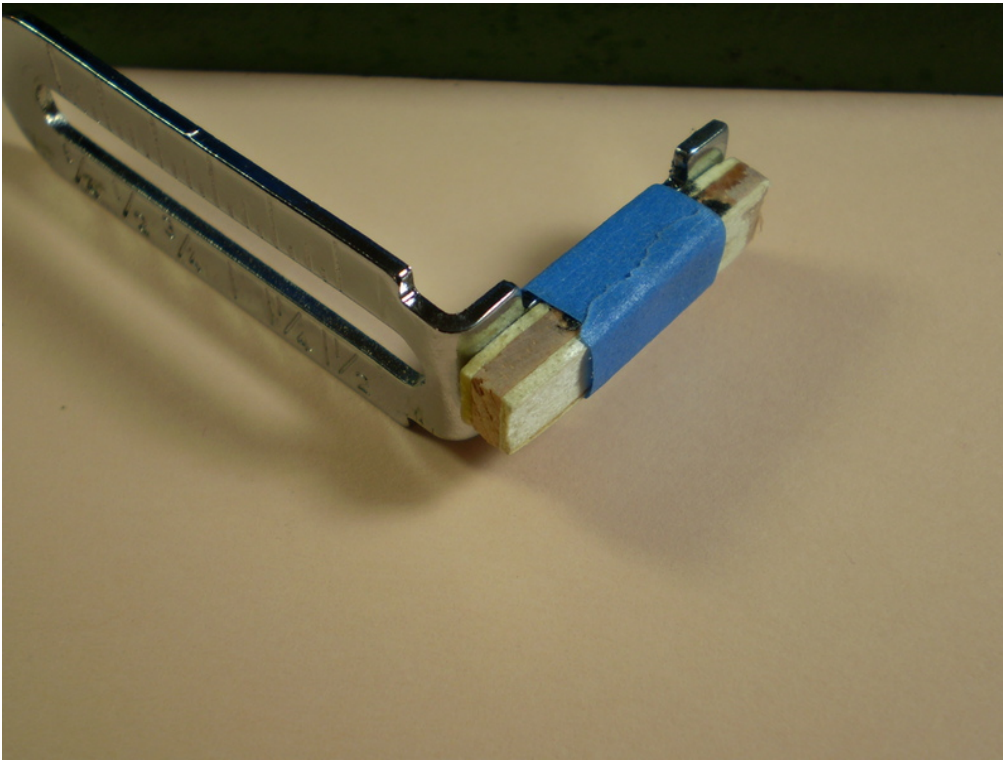

Figure 210: Stop modification on the punch.

The first thing that I did for the punch was add a small piece of scrap wood to the stop. With the stop as close to the punch die, the material being punched goes to far into the punch throat. With this board in place the holes will be close to the board edge and thus produce less scrap material.

Another mod that I made was the following. The male part of the die has a point centered on the face. This nipple is to punch into the metal and hold it in place to keep it from moving sideways as the punch is used on the material. This is bad for pads, so I used a file to remove the point. My punch is not ever going to be used for anything else. Make sure that when you file the point that you do not touch, if possible, the remainder of the face as any defects will show up on the pad, which is not really a problem. The point in the die fractures the copper clad on the board and that was something that I did not like.

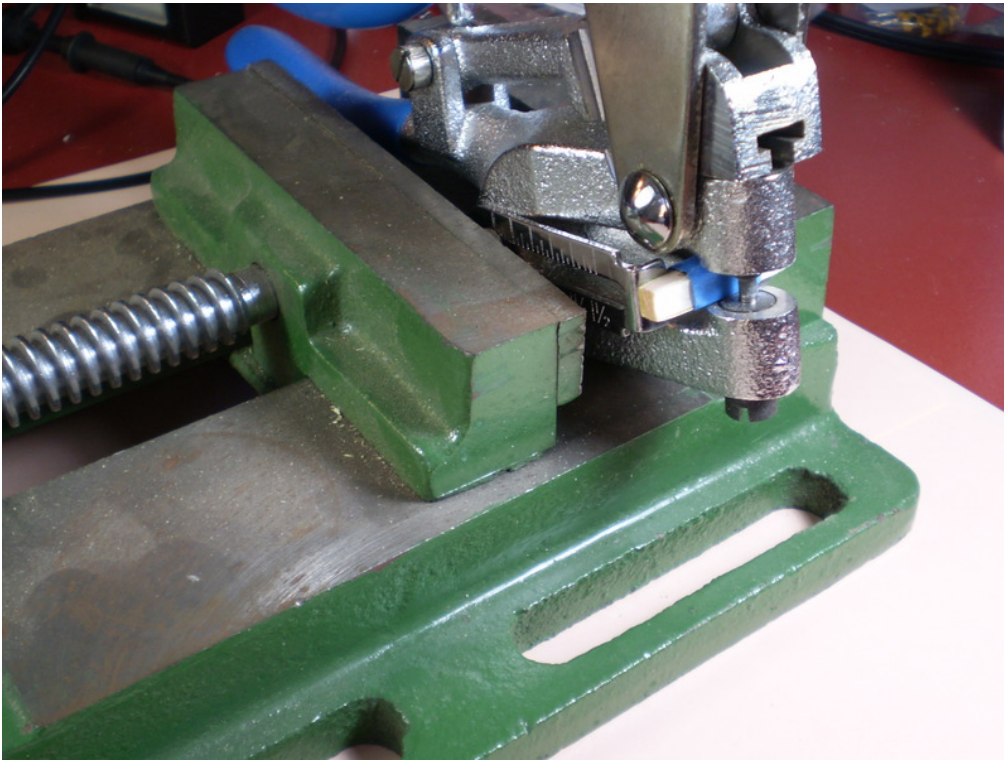

Figure 211: Stop in place and punch in vise.

The photo shows the punch tightly held in place in a Harbor Freight vise. This allows me to rapidly punch board material.

I like the 1/8" pad size. If this is your first time to do this, then you may want to start with a larger pad size until you get proficient at working in tight spaces. You can also make different sizes for different number and types of components to solder into your projects. Your option. Experiment and learn. Spread the word.

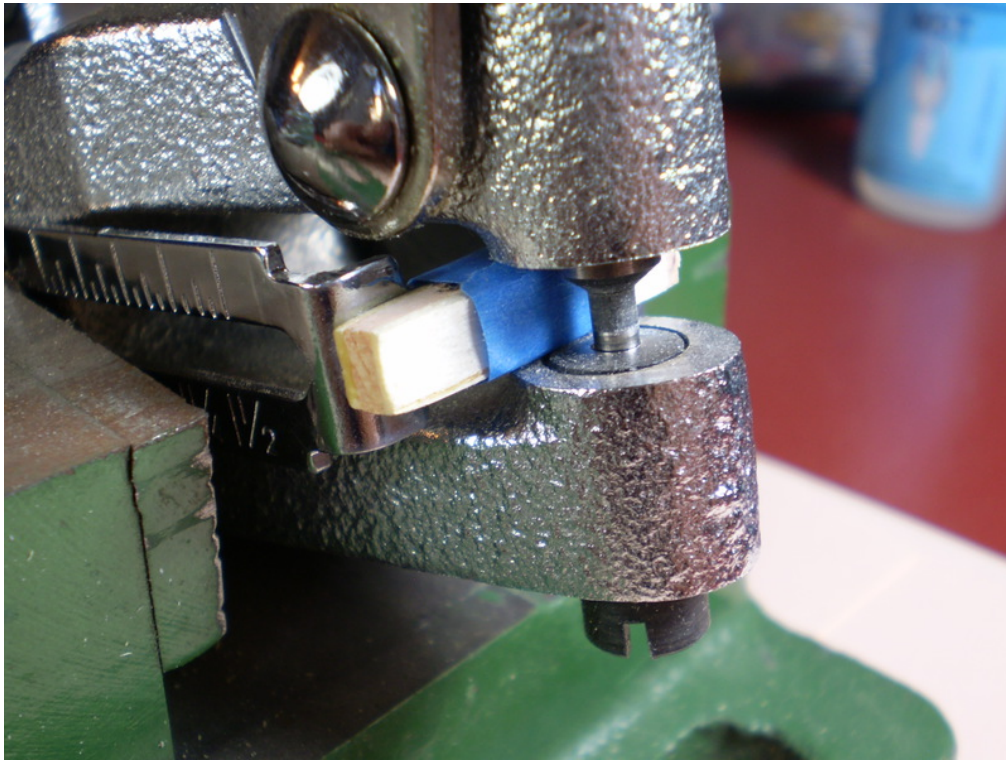

Figure 212: Stop in place and punch in vise.

Here is close up of the modified stop and how close it winds up to the punch die.

Note that the bottom part of the punch is level with the frame so that when a board is placed in to be punched it will be flush with the die and the frame to allow maximum force to be transferred to the die and material and shear the pad out of the board.

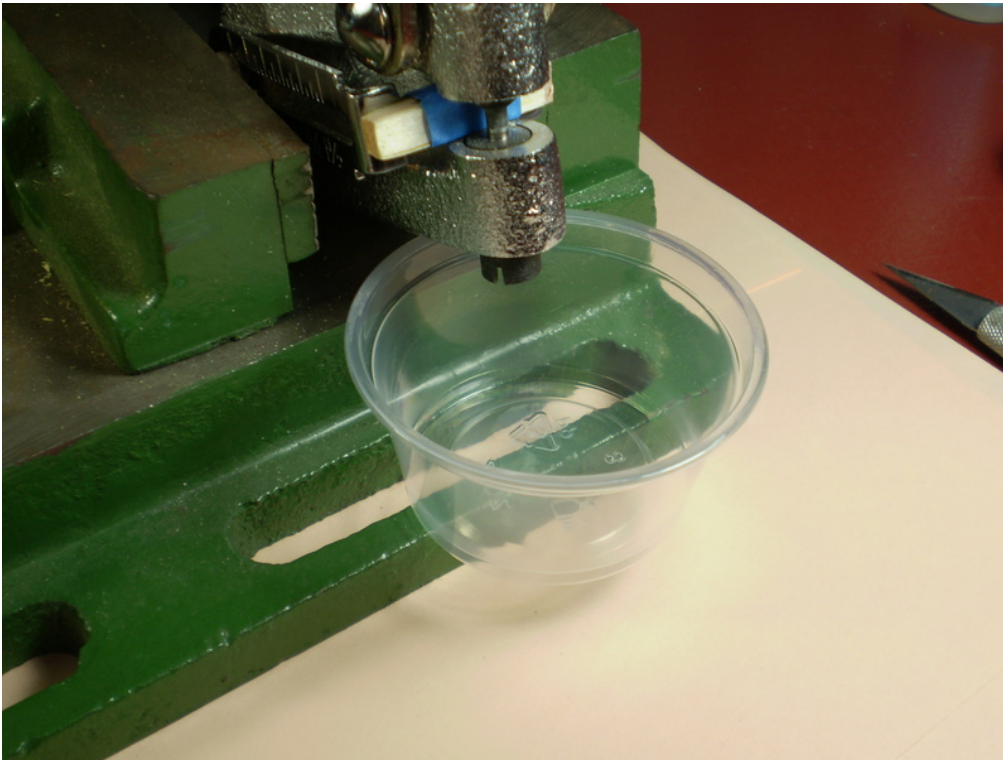

Figure 213: Small once ounce cup to catch punched pads.

You need to put something in place to catch the punched pad. I can guarantee that a punched pad will roll as far as possible on the desk or workbench to make your life miserable. Been there. Done that. :-)

With my arrangement above the cup will try to slide out, but the protruding part of the lower die keeps the cup from sliding away and causing a mess.

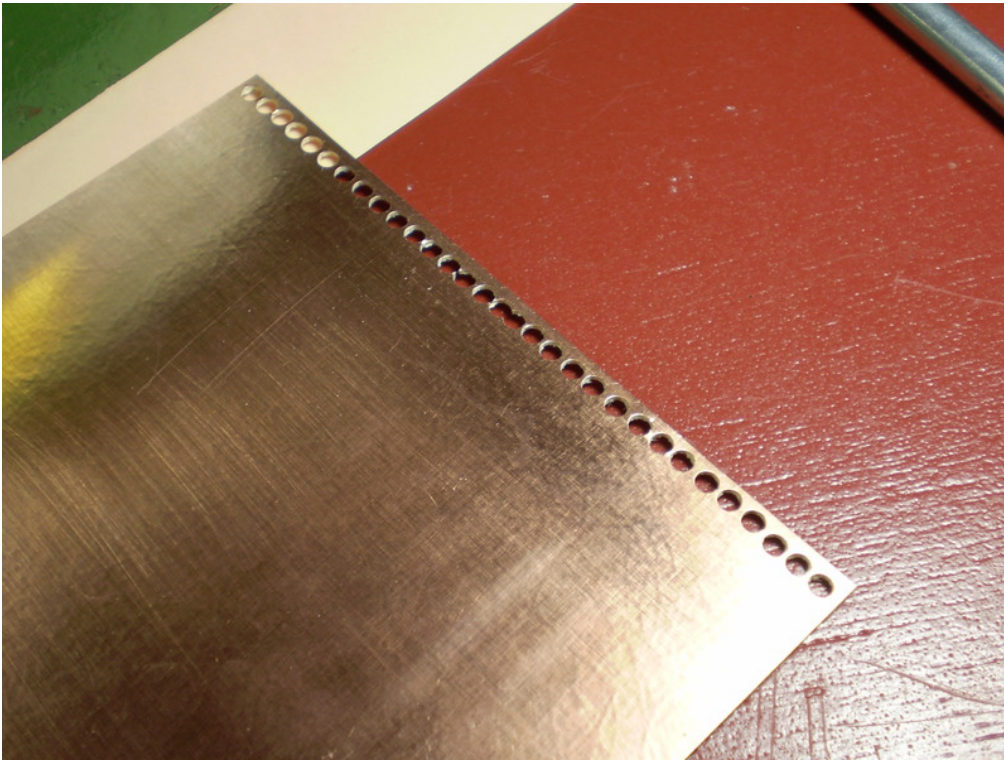

Figure 214: Board that has one row punched out.

As you can see, with the stop modification I am able to get holes punched out close to the board edge. This board is 4 inches by 6 inches. I am getting about 30 pads per row along the 4 inch side.

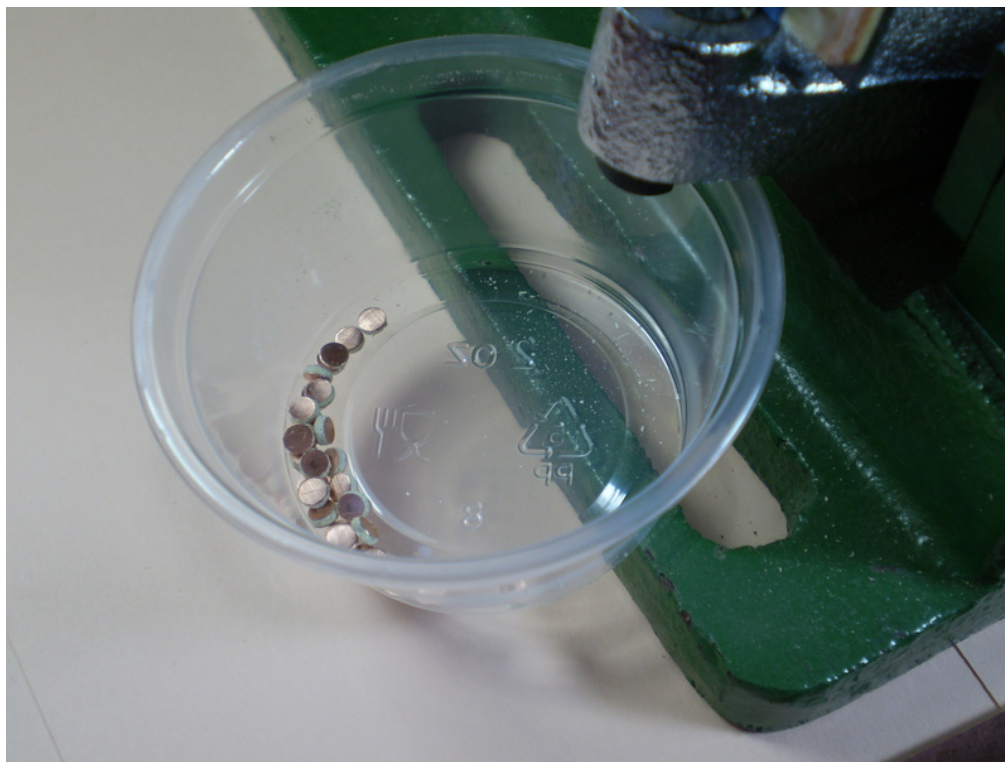

Figure 215: Pads from first row punched.

Here is the results of the first row.

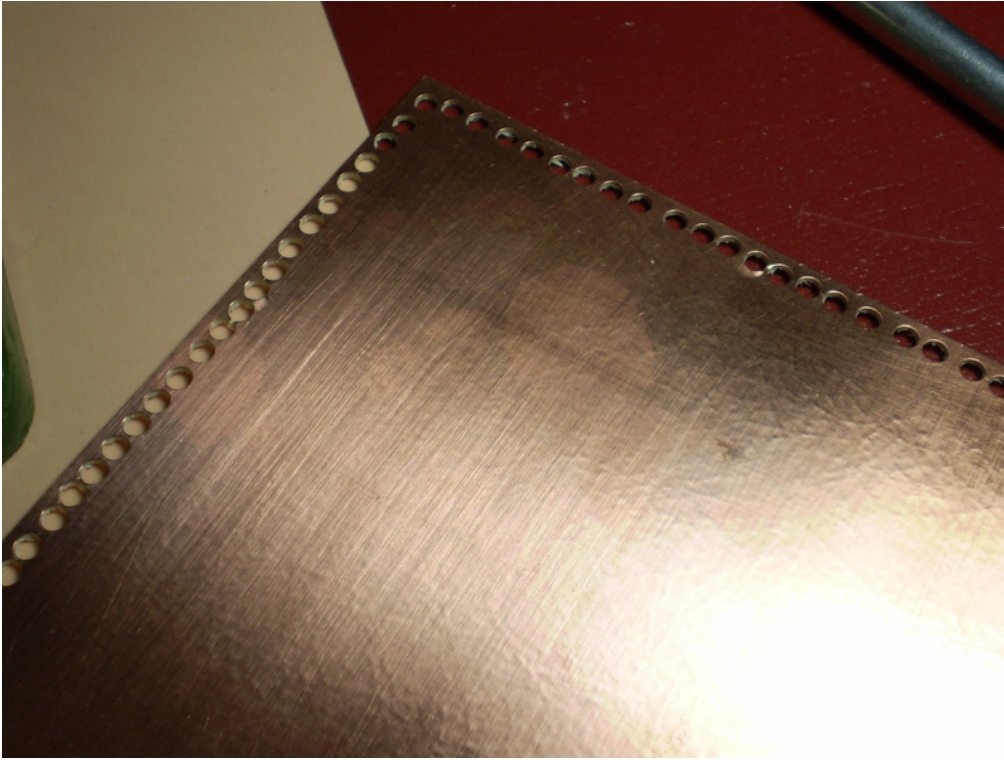

Figure 216: Punches along two edges of the board.

If you want to save time, you can punch all the way around the board edge before shearing away the punched sections. Then come back and repeat the procedure until all the board is punched.

Most of my time was going to the garage to the shear after doing four sides. In a little over 30 minutes I did the entire 4" by 6" PCB.



Figure 217: Results and a lot of pads.

OK. You can see the results of about 30 minutes of work. It is a lot cheaper to spend the thirty dollars to get the punch and do this myself instead of paying someone else to do it for me.

And I have a few large projects that I can now do with this number of pads.

You will also note, if you look closely, some of the pads are what I call 'moon pads' in that they are not complete. The punch overlapped a hole in the board material, thus the pad is incomplete. You can use these to glue up next to another pad to make a large pad, if you need to do so. The moon pads can be used as is and not hurt anything.

24.4 Mounting pads and components



Figure 218: Several super glue bottles.

For this write up I went to Home Depot and obtained the two bottles of super glue on the left and the bottle on the right I got from Hobby Bench where a lot of R/C modelers buy lots of expensive stuff.

I like the bottle on the left and all that you see here is done with it. Get what you can. I recommend you get a bottle that has a fine tip for dispensing the super glue. I do not have to warn you how dangerous this stuff is. Be careful. Don't inhale the fumes and use in a safe place. Keep away from kids and pets and keep the cap on at all times.

If you don't have kids, the bottle recommends that you keep it at 40 degrees F in the fridge for longer lasting storage.

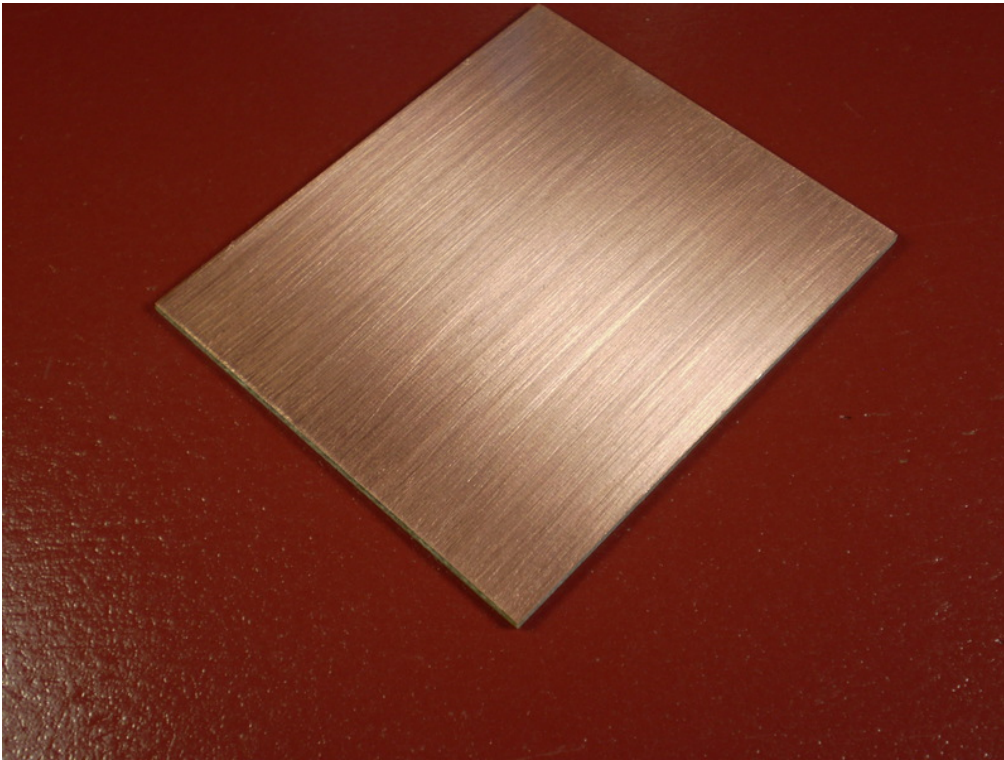

Figure 219: Ground plane PCB material.

Let's start with a small piece of PCB to experiment with, if you have never done Manhattan style. This board has been cleaned with 3M pad and then has a very very thin coat of Krylon clear spray on it. I then baked the PCB in a toaster oven at 140° F for 30 mins outside to keep from having noxious fumes in the house or lab. Don't piss off your family by using the kitchen oven. Spend the thirty bucks or so at Wal*Mart and get a large toaster oven. They will thank you for it and you will all live longer.



Figure 220: Radio Shack solder.

You can use what ever solder you have on hand. I show this stuff from Radio Shack for those that don't have solder. I love that it has two percent silver and makes a nice shiny solder joint.

Because of the metal industry and the EPA, this stuff is getting more expensive by the minute. This solder has lead in it and thus melts at a lower temp than the solder that does not have lead in it.

Also use the smallest diameter you can. Here the solder is 0.022" in diameter. You won't be using a lot of solder at each connection. We aren't building a battle ship. The project will be a lot lighter in the end.

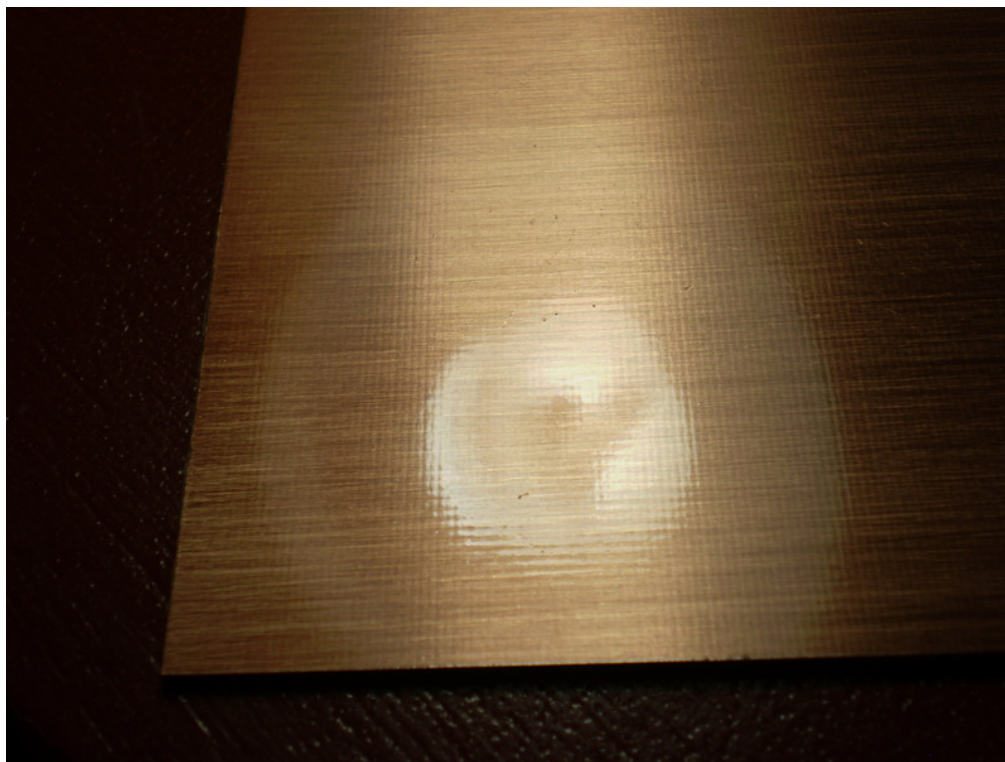

Figure 221: Krylon coating.

This photo to show reflection of light off the Krylon coating. This coating should be very thin.

The reason I do this? I want my projects to look good years from now. I learned this the hard way. Over a decade ago Jim Kortge and I built the QRP-10 transceiver using Manhattan construction. I did not coat the ground plane with Krylon clear. A few years later the board was getting ugly with finger prints and corrosion. I sent the rig to the landfill.

Some guys will show you they use blue painters tap on the board to protect it as they build and remove the tape from each area as they build. With the Krylon I have already protected the copper surface.



Figure 222: Ground points.

Your first solder homework is to take a spot on the board and put a SMALL amount of solder and get to the ground plane through the Krylon coating. I am using a 23 watt Weller soldering iron that I got from Home Depot for under twenty bucks. You will be doing a lot of ground plane points in a project.

This exercise will teach you patience. It takes longer to generate a ground point. You need to melt the Krylon and heat a relatively large surface to get the solder to connect. Other connections and soldering points will be almost instantaneous compared to this.

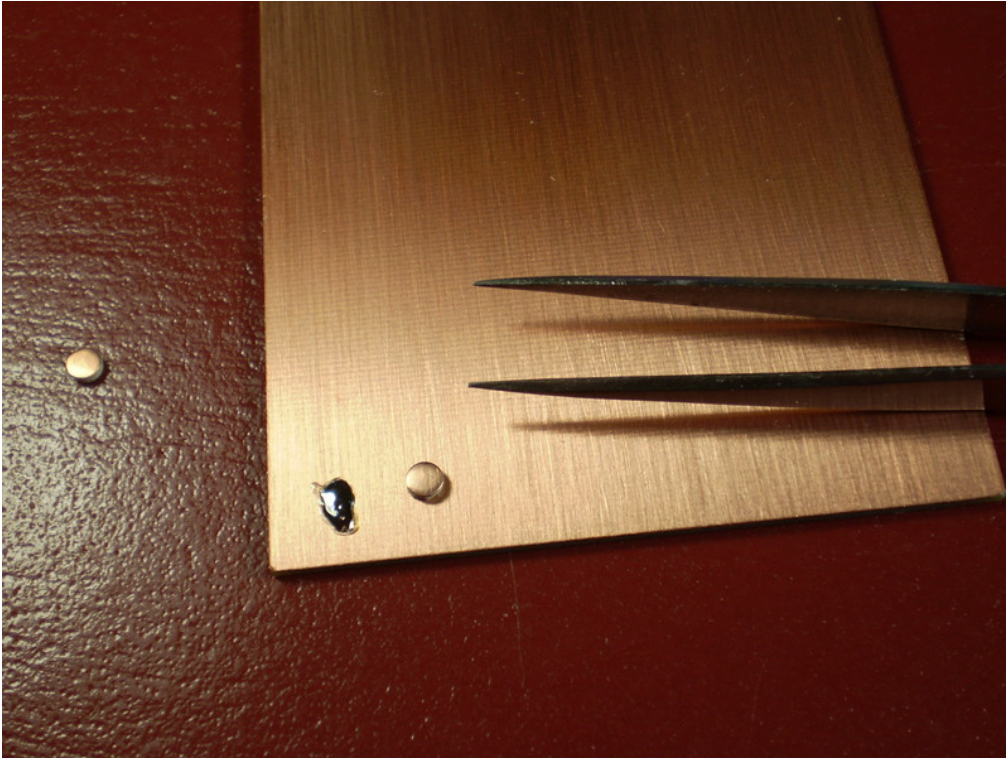

Figure 223: Manhattan pad and tweezers.

I use a extra pointy set of tweezers that came as part of a set that I got at Harbor Freight. You know the drill.

Make sure that you don't get the tweezers bogged down with super glue.

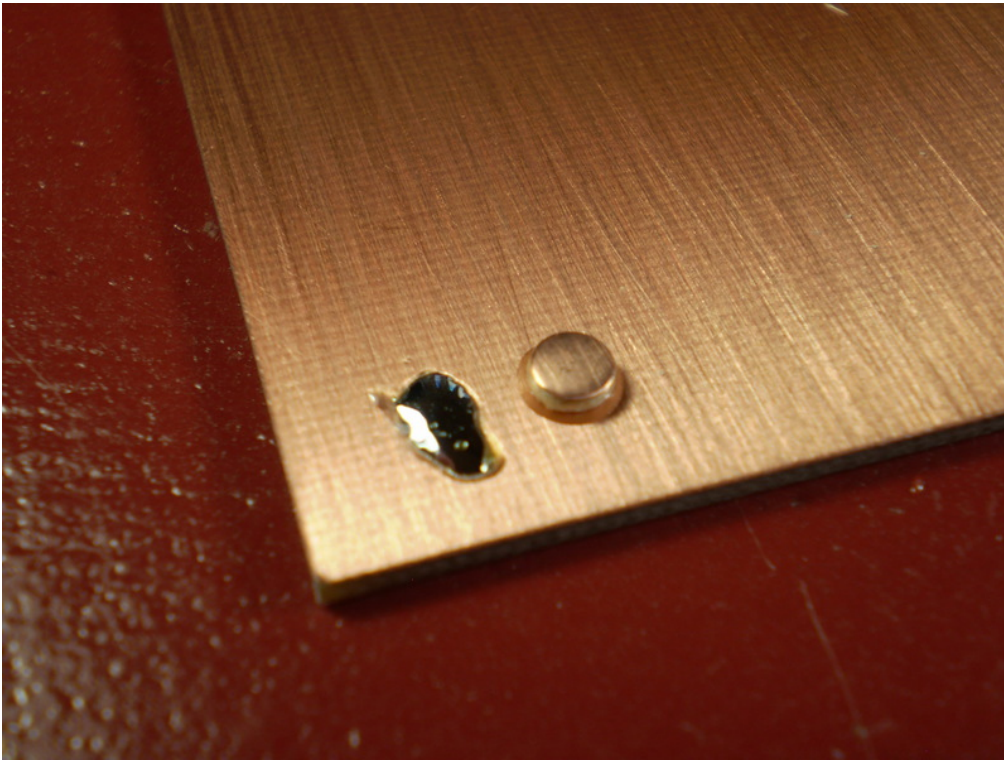

Figure 224: Pad glued down.

Just put a itsy bitsy teeny amount (a small drop) of glue at the point where you want the pad to go and then carefully place the pad on the drop. Then push down gently on the center of the pad to hold it in place a few seconds. Length of time depends upon the setting time of the glue. Get the fast stuff as you do not want to wait a long time for each pad. This will add a lot of building time to a project otherwise.

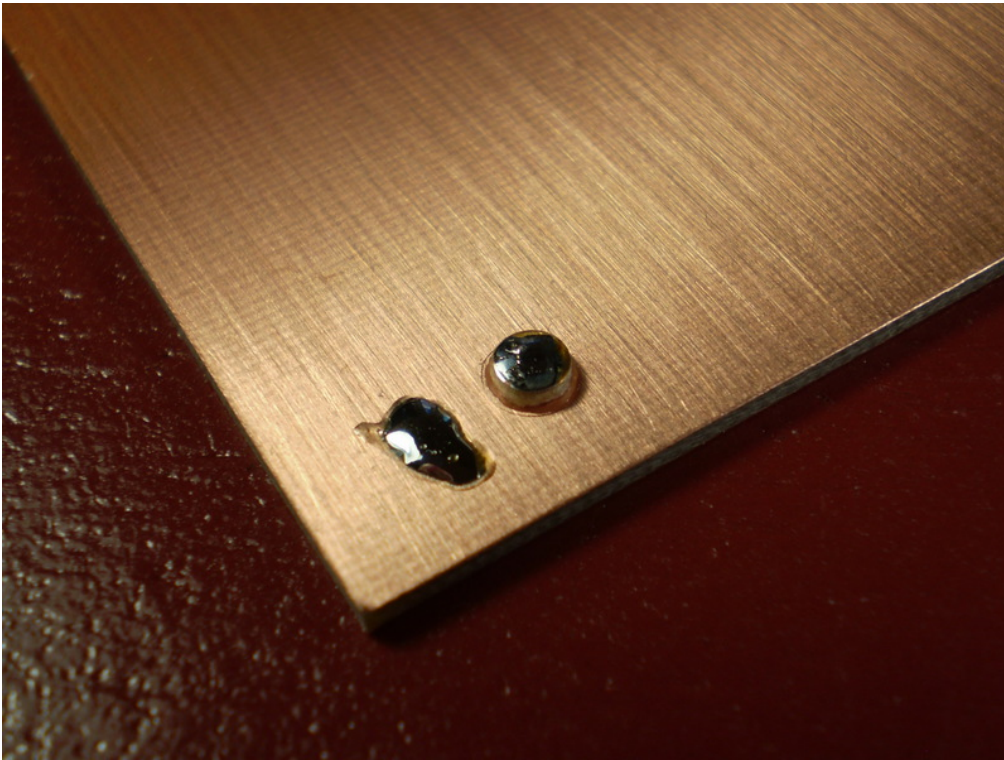

Figure 225: Tinned pad.

Then, using your iron and solder, tin the top of the pad. Don't load it down with a lot of solder. Just a little bit will do the job nicely.

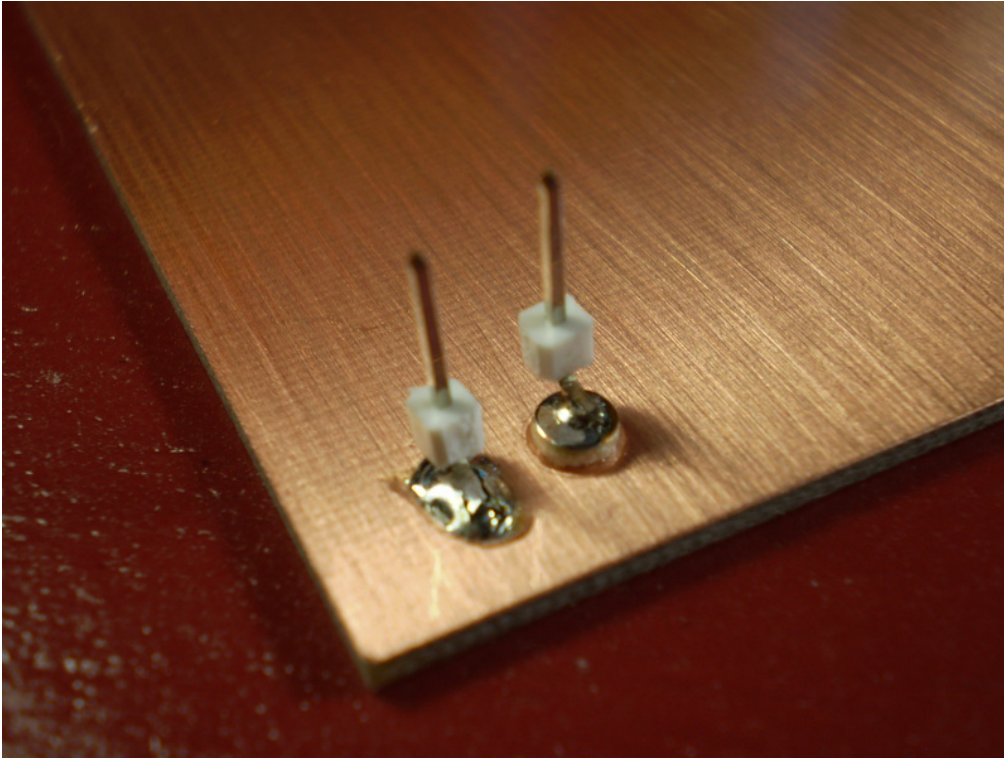

Figure 226: Header pins on ground plane and pad.

OK. Here I have soldered to the pad and the ground plane a pin for a row of 0.1" headers typically used for connectors.

I want to measure the capacitance of the pad. I will use an AADE L/C II meter using some Arduino connectors. I will zero out the meter with the leads connected to the meter and then connect to the pad via the headers.

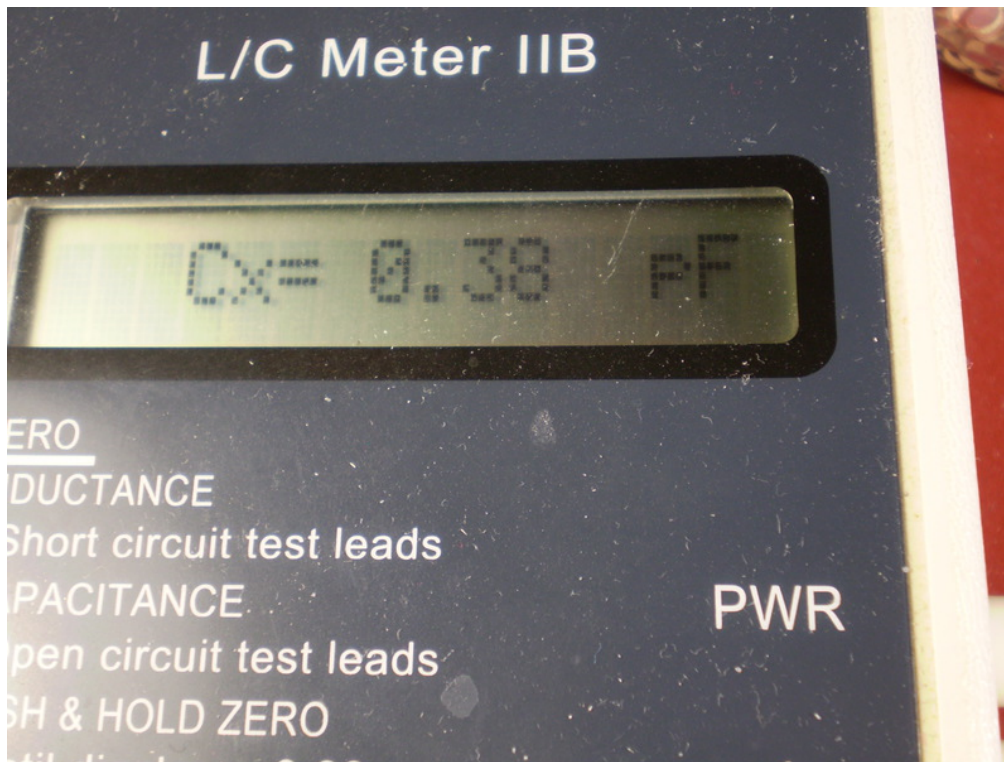

Figure 227: Capacitance of pad.

Here the meter reads 0.38pF for the capacitance of the pad.

Think about the following. We have the copper layer at the top, the paper insulation, a copper layer at the bottom of the pad, a layer of super glue, a layer of Krylon clear and then the copper of the ground plane of the PCB.

This physical configuration amounts to two series capacitors. Think about it. Draw a picture. This series arrangement reduces the total capacitance from the pad top to the ground plane. Less than 0.5pF for each pad. We have more serious things to worry about than getting retentive about the stray capacitance of each pad. Believe me.

I will come back with some single sided CEM board material that I have on order from abcfab and should get here in a couple of days. I will measure the capacitance with only one effective capacitor from the top of the pad to the ground plane. Any guess as to how much the increase will be? Double?

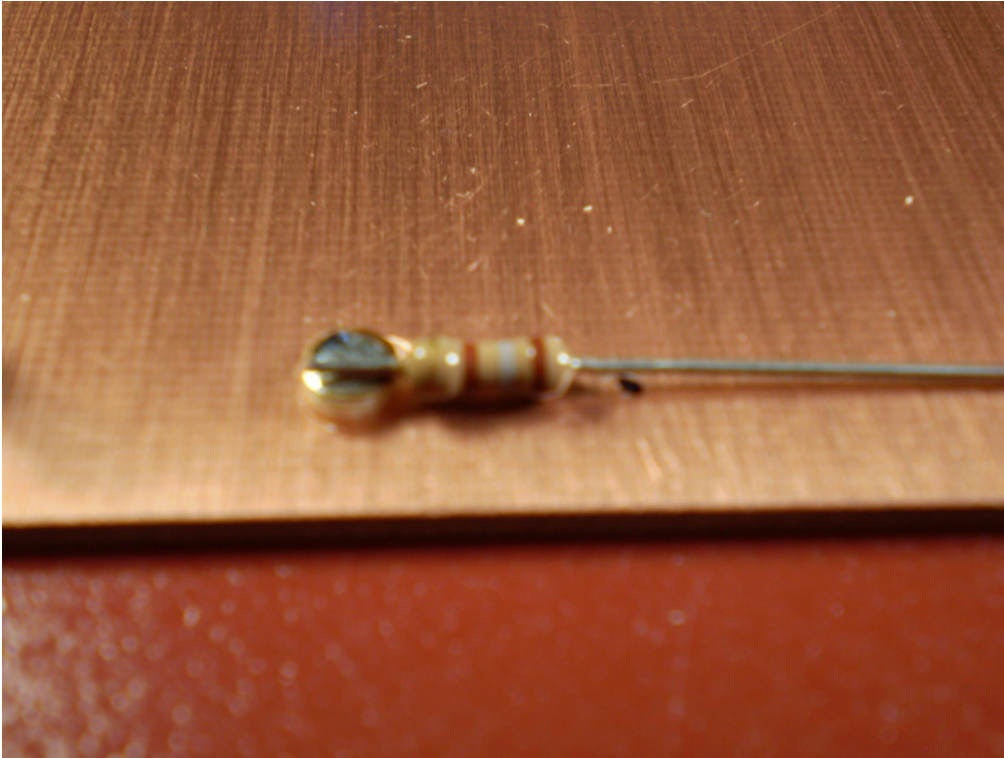

Figure 228: Resistor laying on board.

OK. Sorry about the focus. Difficult some times to get the camera to focus on the right spot. Here I have a resistor laying with one end on the pad (not soldered yet).

I use a Sharpie to make a dot on the board where the next pad is to go. See it under the right hand lead? I will put a drop of super glue and place another pad there. Then I can solder the resistor in place and clip the lead.



Figure 229: Resistor soldered into place.

OK. Nice looking job. Note. The solder joints do not have a lot of solder. No need for it. Just make sure you do not have a cold solder joint. There is room for a couple of more leads from parts, so the 1/8" diameter pads will allow you to get 4 or more parts to a node.



Figure 230: Three resistors.

Just to show you that you have options in parts placement. The center resistor is isolated from ground, but the two end resistors have one lead soldered to ground.

The purpose here is to show you that you have two choices on how to physically place parts. The left resistor is mounted vertically and will take up less area of the board and the right resistor lays horizontal and requires more board area.

Which you use is up to you and your layout. We'll get to that in a later section. This is not rocket science and you get a lot of freedom and creativity in laying out a project.

This concludes the beginning points. Let's go and build a real working circuit to demo some other things.

24.5 First Manhattan Project – Crystal Tester

Let's start with a real practical and useful project to demonstrate a Manhattan build. Here is Figure 5.1 showing a crystal oscillator. We can build this for use as a crystal tester.

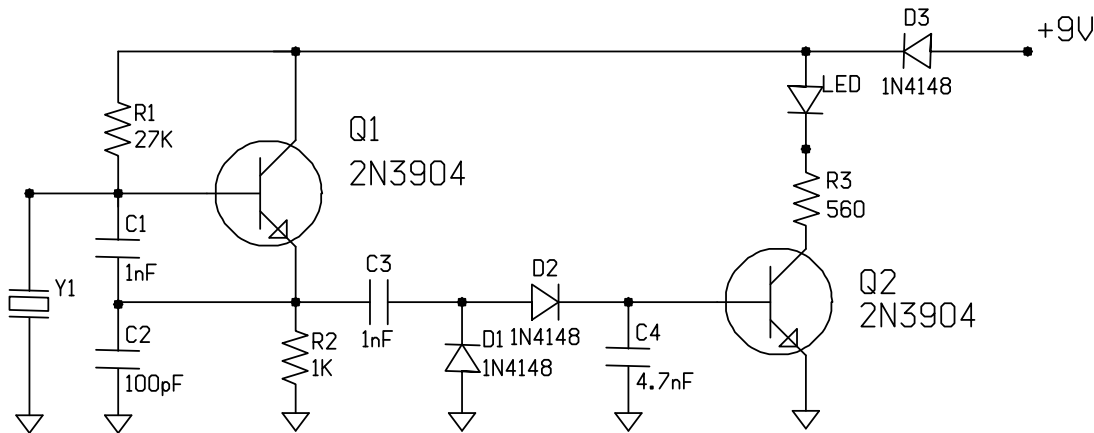

Figure 231: Crystal tester schematic.

The crystal tester consists of a Colpitts oscillator with output fed to D1 and D2 to generate a DC voltage to switch the Q2 transistor on to turn on the LED. If the LED lights, then there is RF and the crystal is oscillating. This is a simple circuit and may fail on some crystals that are good but will not oscillate because of the C1 and C2 values.

But it should be good for a majority of your crystals that you encounter. We can all run tests to check if there are better values. The circuit has no on/off switch. I just hook up the battery when testing and unplug it when not in use.

24.5.1 Assembly

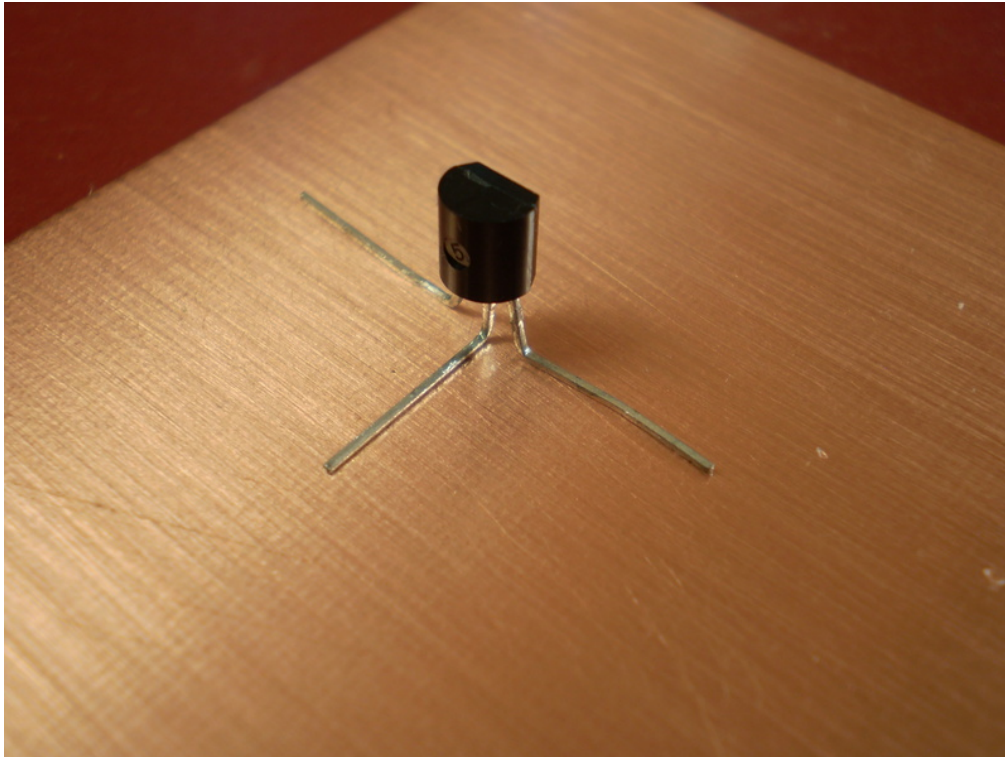

Figure 232: Q1 Transistor leads bending.

The first thing I do is take Q1, in this case a 2N3904, and bend the leads as shown in the photograph using chain nose pliers. I prefer chain nose over needle nose pliers for all my work.

For this circuit just about any good NPN transistor will work. The list may include 2N2222, 2N2222A, 2N4401 and many others.



Figure 233: Q1 mounted to pads.

Here we have Q1 mounted. I used the extra pad closest the edge of the board for a place to solder a machined socket pin to plug the crystal being tested into. You may want to leave more room than I did.



Figure 234: R1 and C1 added.

You can experiment with positioning of the components. Just because I do it one way does not mean you have to do the exact same thing. Creativity plays a part in just how the parts are laid out on the PCB for different circuits.

I also use the schematic and a highlighter to mark off parts as I solder them into place. For large circuits this is a must to minimize errors in wiring. Trust me. Start now with good habits.



Figure 235: C2 added.

Here I got a little too aggressive with the solder tip laying on a larger area of the board than I usually like for the ground connection, as you will see for some of the other ground points in the circuit.

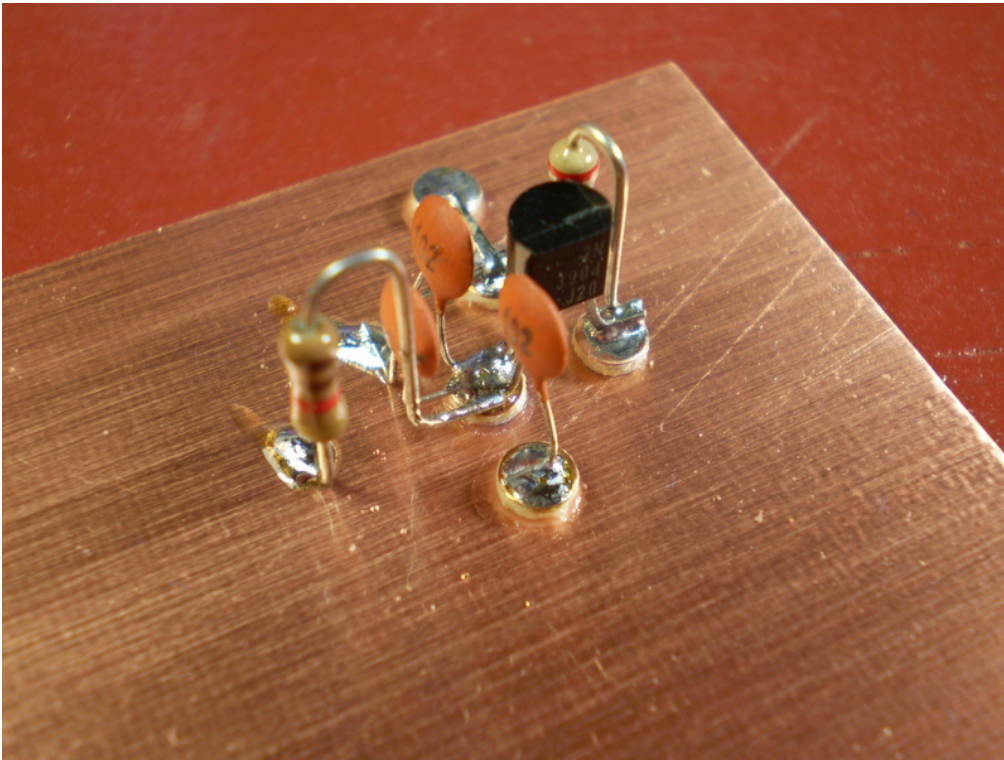

Figure 236: C3.

Here C3, the coupling capacitor to the voltage doubler is soldered to two pads.



Figure 237: D1.

D1, the first half of the voltage doubler. Note the neater ground connection. Make sure the banded end of the diode goes to the pad connection to C3.

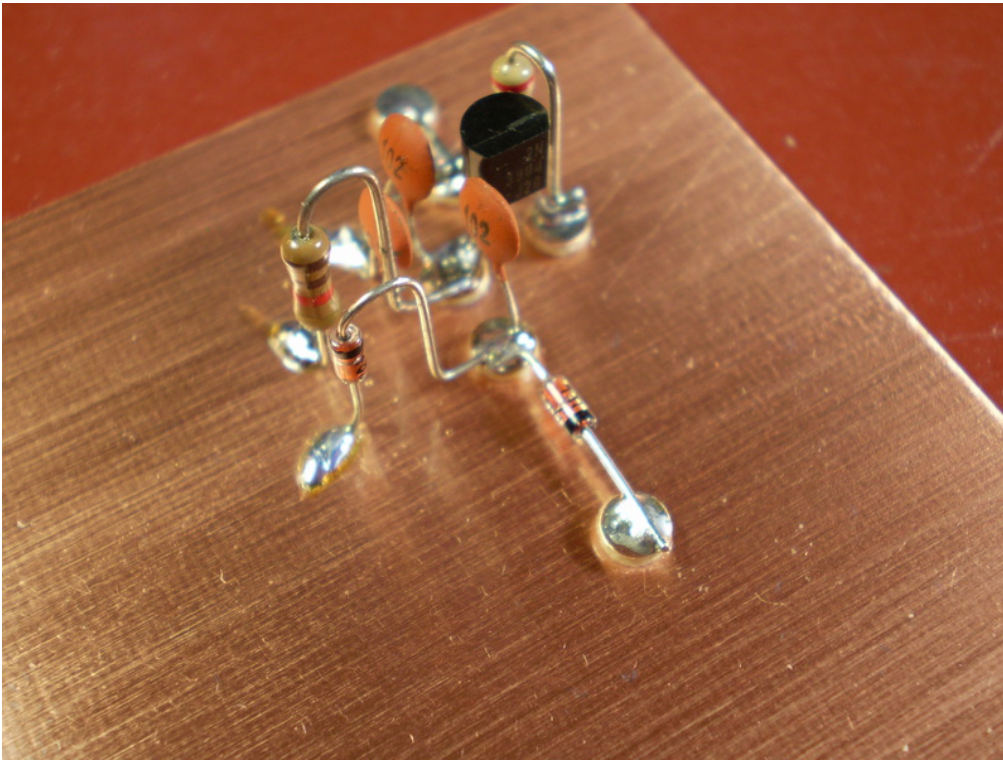

Figure 238: D2.

Here D2, for the second half of the voltage doubler is soldered into the circuit.



Figure 239: C4.

C4, which acts as a voltage smoothing capacitor on the full wave rectified waveform from the voltage doubler circuit using D1 and D2.

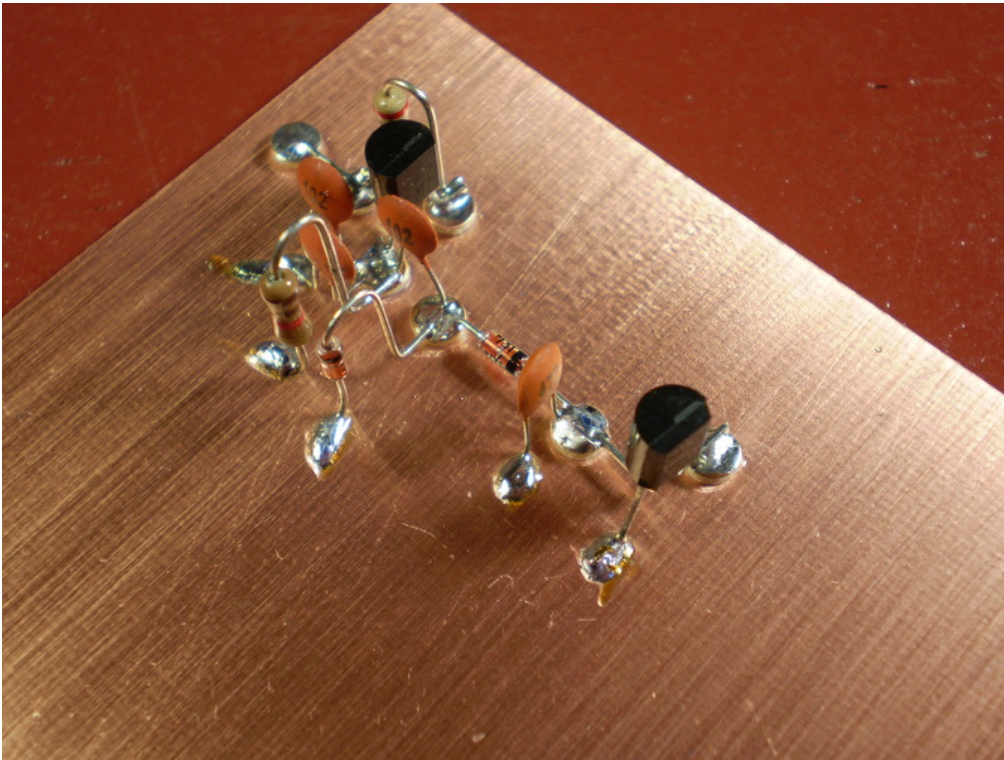

Figure 240: Q2.

Here Q2 is mounted and since the emitter lead goes direct to ground, a pad is not needed for the lead.



Figure 241: R3 and LED mounted.

Here is how I did the R3 and LED components.

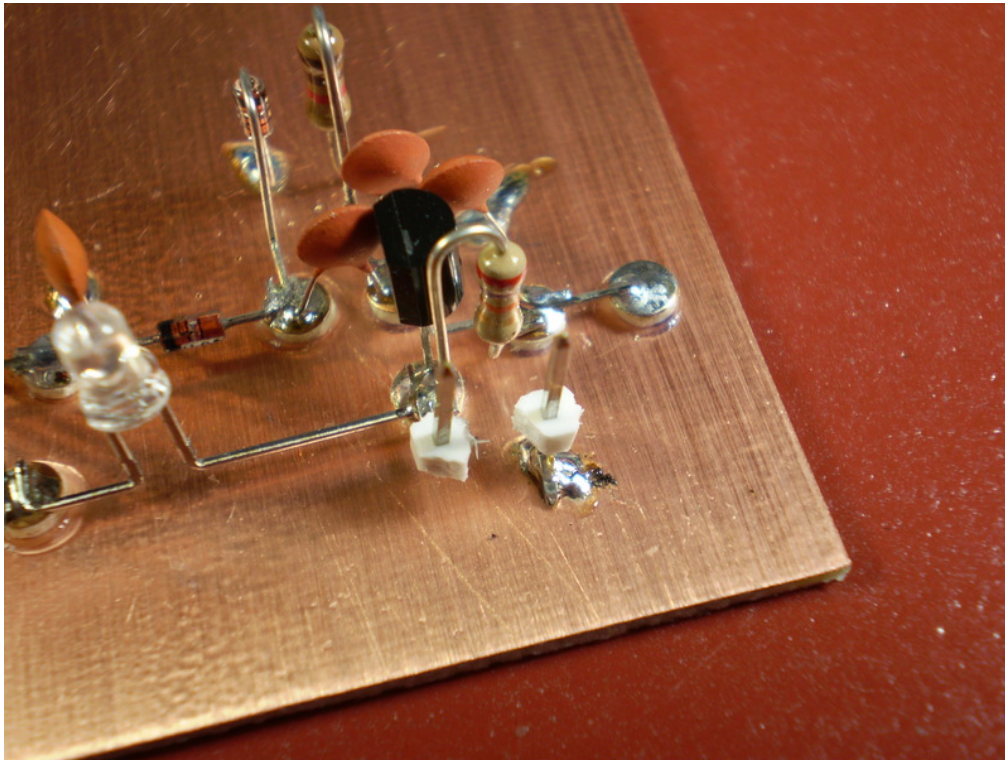

Figure 242: Power connector.

Because I like to use headers for power connections, since I have so many small projects that use 9V for the power, so that I can plug and unplug the same battery from project to project and not use up expensive 9V batter connectors.

Note, that I did not put in D3, the reverse polarity protection diode. I highly recommend that you not leave it out. I use reverse polarity protection on all my projects just in case I happen to hook up a power supply backwards. This prevents from having to debug and replace parts if I do it wrong.



Figure 243: Crystal connector.

Here are the two machine sockets soldered into place and holding a 11.0592MHz crystal in place to be tested.

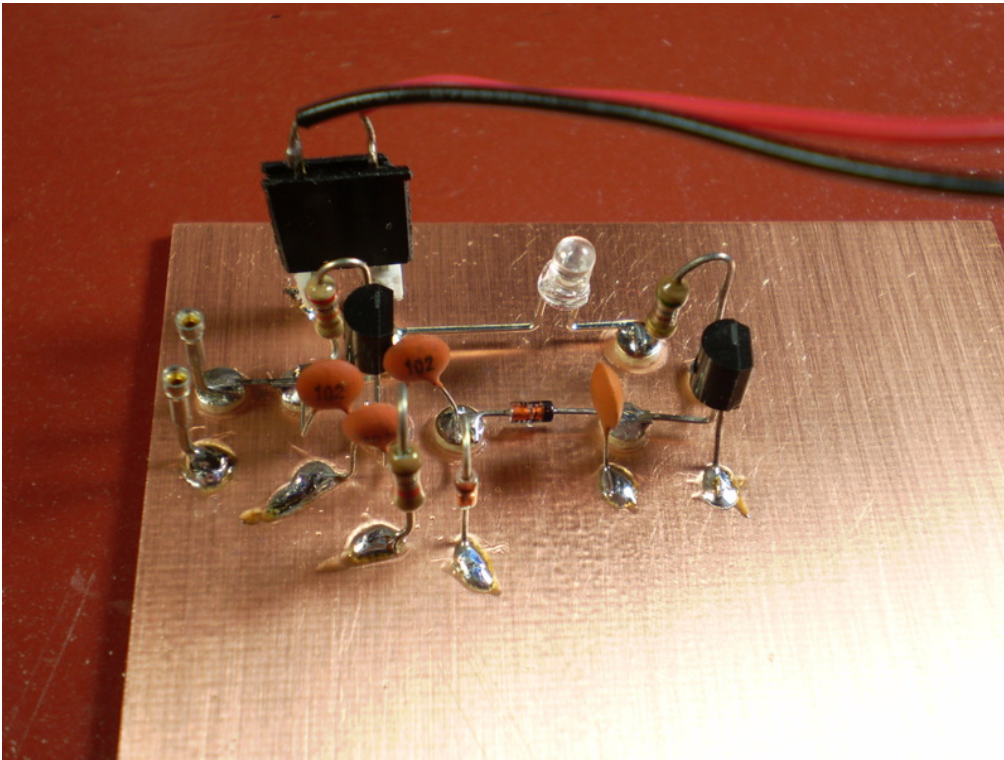

Figure 244: Final project powered up with no crystal.

With power applied and no crystal the LED does not light up.

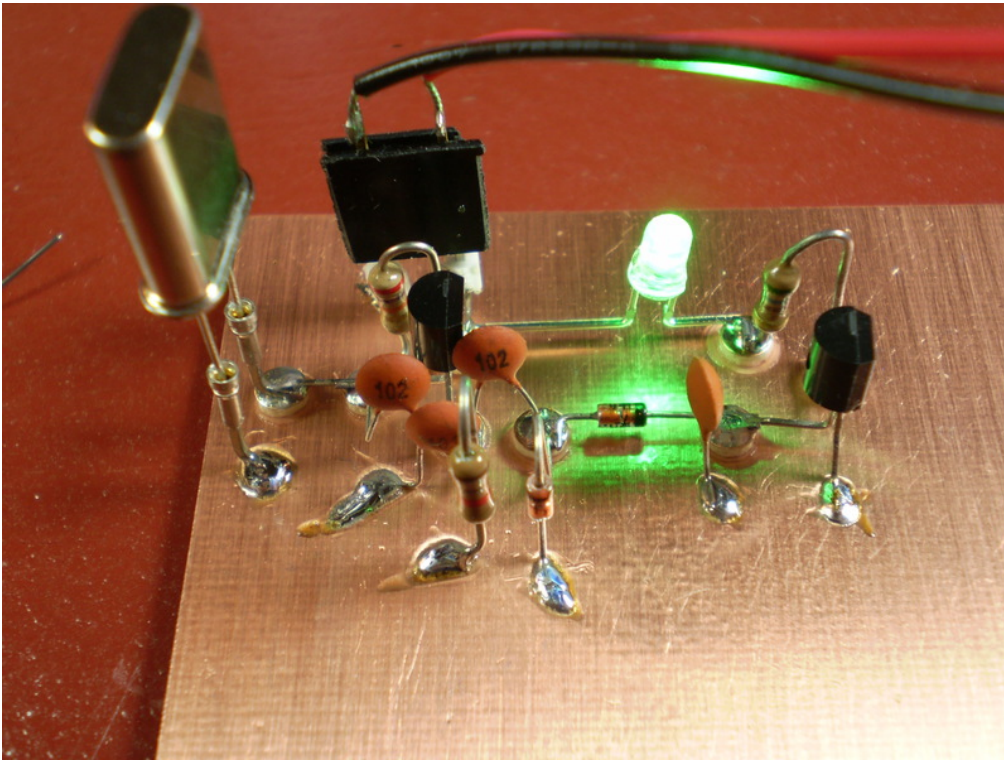

Figure 245: Powered up and crystal in socket.

With power applied with crystal in place and the LED does light up.

So, here I have shown you every step and how simple the process is to build up a circuit using Manhattan construction. Just start with several simple projects before attacking a more serious project.

One of the things that I recommend you not do is take some one else's layout and print it out and glue it down to the PCB and build on top of it. That is cheating. Use other layouts as guides, but please use your own skill set to do the work. You learn more that way. IMHO.

Chapter 25

The Ugly Weekender II

In August 1981 in QST the father and son team of Wes and Roger Hayward wrote an article The “Ugly Weekender”. It was on the building of a QRP transmitter that could easily be done over a weekend. The ugly term came about because of the building technique that used PCB material as a ground plane to solder components to as the circuit was built. High value resistors were used as stand offs for points where multiple components were connected and needed support and a cheap source of 1Meg or higher valued resistors were used for these points in the circuit.

Roger, KA7EXM, wrote another article in the June issue of QST for adding a receiver and thus making a transceiver possible. The article resulted in the Ugly Weekender II.

In March of 2014, as a project for [qrp-tech](http://qrp-tech.groups.yahoo.com) at groups.yahoo.com, Alan Jones, N8WQ, volunteered his services as project leader for an interested group to build the transceiver. The group has a choice of building the transceiver using the building technique of their choice.

A set of printed circuit boards (3 board set for \$12.50 plus shipping) is available from FARcircuits.com online and a number of us ordered the boards.

I am personally going to build the transceiver three times using the PCBs from FAR Circuits, Manhattan style building and the muppet board technique. Just for the heck of it and the fun of it to compare results.

So, here goes. All the gory details you would ever need.

25.1 VFO and Keying board

I am going to build in sections and test in sections. I am working with the two articles from QST. The boards from FAR Circuits do not come with documentation. I have no idea, at this time, where the parts labeling is coming from, so I have going to have to use the PCB traces and labeling to determine where everything goes and I have to hope the circuit from the original article was not modified.

I use headers with some Arduino leads with Radio Shack alligator clips to connect to a 12V gel cell to power up the project as I go. Here is the board with two pins from 0.10" headers for the connection to the board.

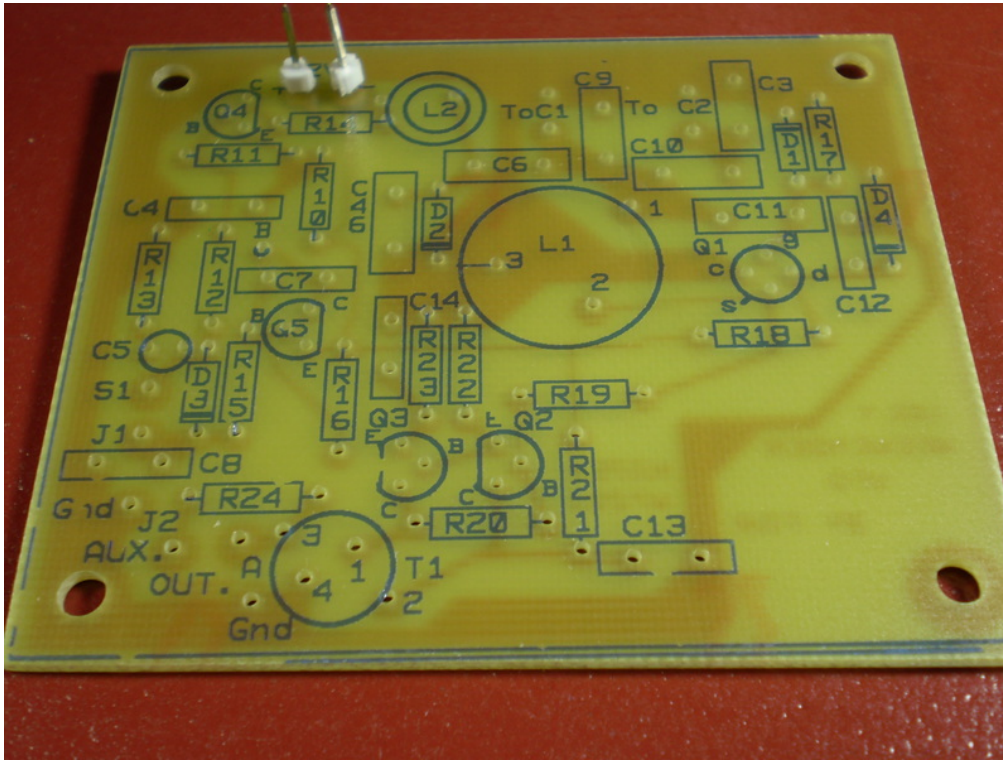

Figure 246: Power connector for the PCB.

I am going to first add the three parts D4, C12 and R18 to the board. These three parts make up the 9V regulator supply voltage to power the VFO circuit.

D4	1N4739A 9.1V zener diode
C12	0.1 μ F mono capacitor
R18	680 ohm 1/4W resistor

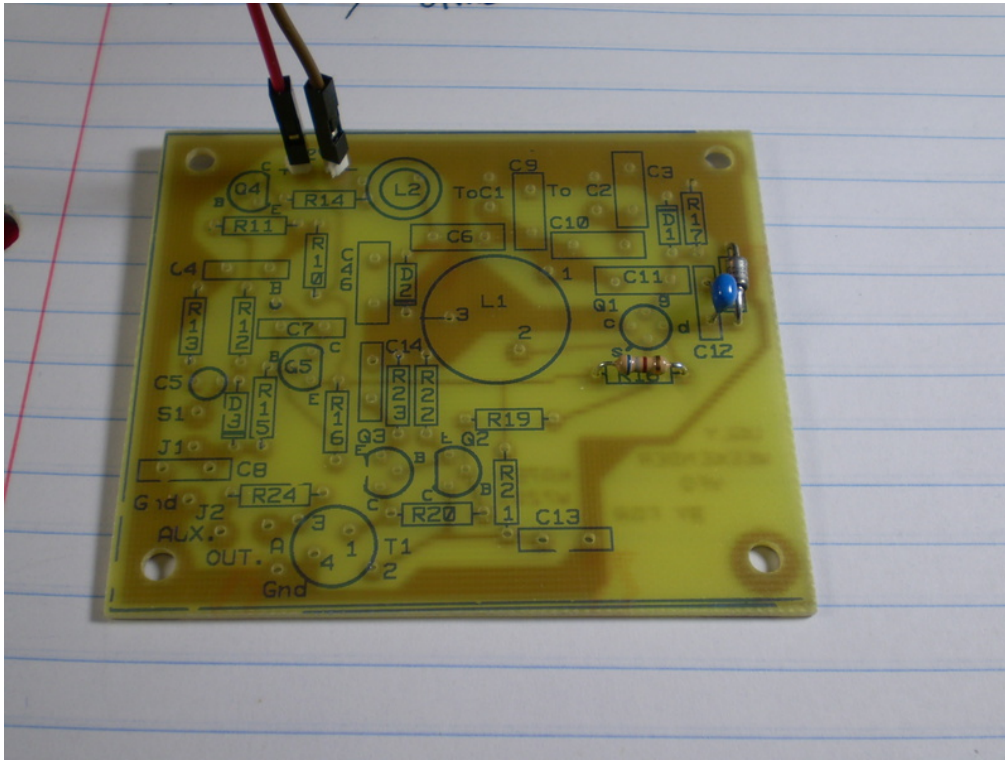

Figure 247: 9V zener regulator supply.

Above is the parts installed.

I powered up the circuit and measured the voltage from the right hand lead of R18 to ground and found a voltage level of 8.92V. This is without a load on the circuit and this is close enough to 9V to make the VFO work correctly.

Now on to the VFO itself.

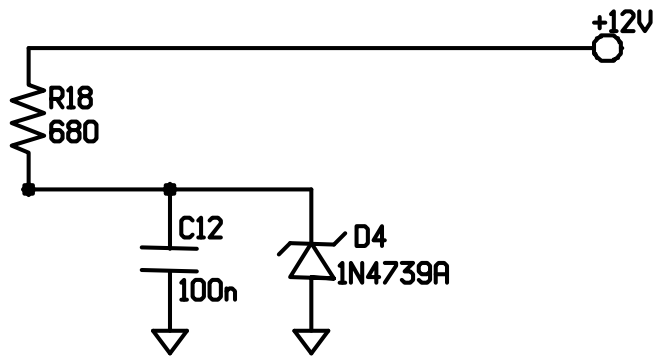

Figure 248: Ugly Weekender Schematic – 001.

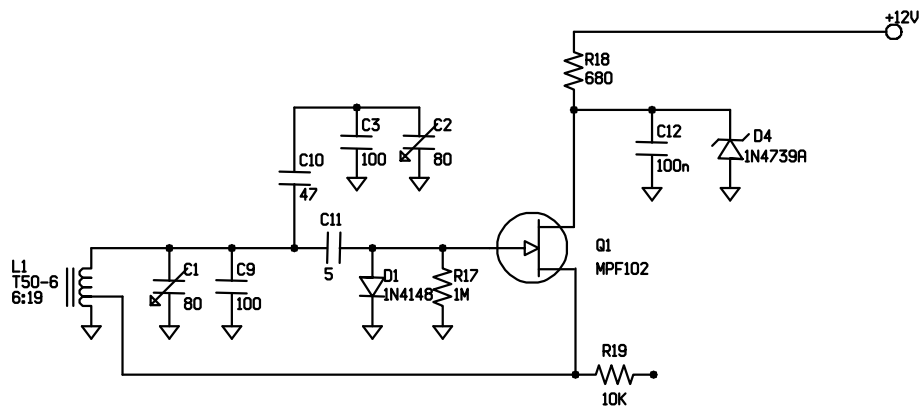

Figure 249: Ugly Weekender Schematic – 002.

In the above I have labeled the components using the parts labeling used on the FAR Circuits PCB. The original Hayward articles do not have labels for the transmitter section as shown in the first article.

On March 13, 2014 I have built this much of the transceiver, powered it up and checked for output and found that the VFO was oscillating

nicely. I used a MPF102 for the JFET. The use of a J310 did not get RF output, so went with the MPF102. This may be something that you have to experiment with if you decide to take on this project.

I will also come back and complete labeling when I get a chance. My program has a couple of labeling issues for components at other than zero degrees relative to the horizontal direction to the right.

Here is a photo of the assembly so far.

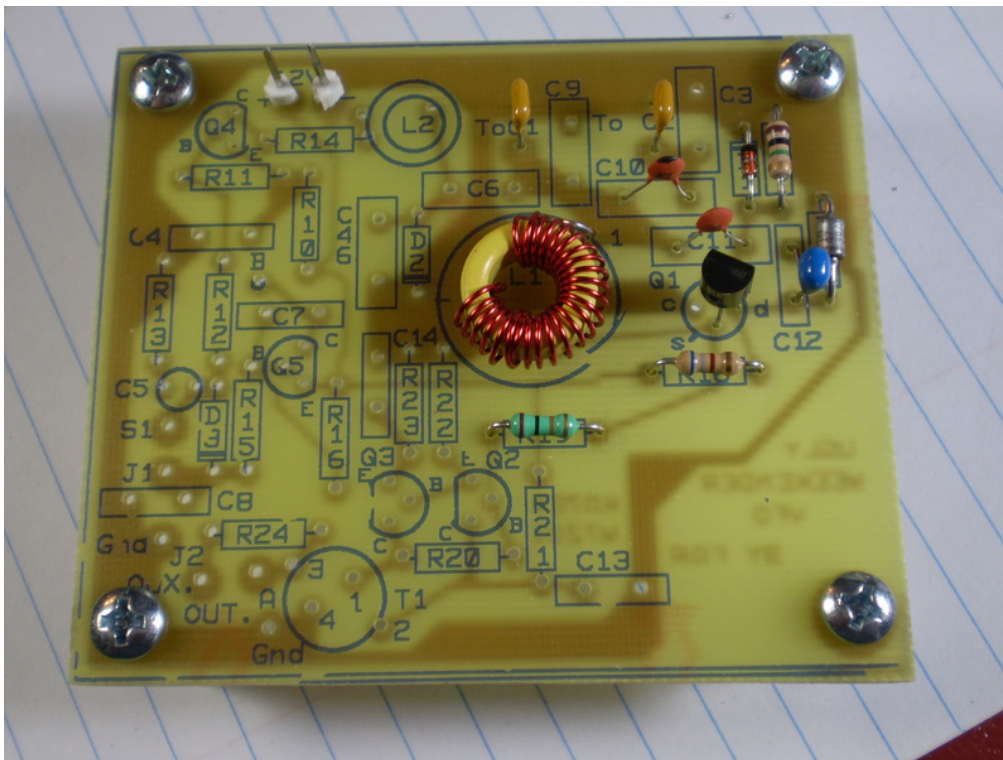

Figure 250: Partial VFO assembly.

Q1	MPF102 JFET
R17	1M
D1	1N4148
C11	5pF NPO
C10	47pF NPO
C3	100 NPO
C2	80pF air variable
C9	100pF NPO
C1	80pF air variable or trimmer
L1	T50-6 25T tap at 6T
R19	10K

25.1.1 VFO Buffer Amplifier

Because the output from the Harley oscillator is low there is the need for an amplifier following it. Since the output feeds the receiver and the transmitter, there is also the need for isolation or buffering. Q2 and Q3 provide the amplification and isolation with the transformer T1.

Here is the list of parts and a photo of the assembled section with labeling determined by the FAR circuit board.

R21	47
C13	10nF or 0.01 μ F
R20	27K
Q2	2N3904
Q3	2N3904
R22	1K
R23	180
C14	10nF or 0.01 μ F
T1	T50-6 25T with tap at 6T
R24	47

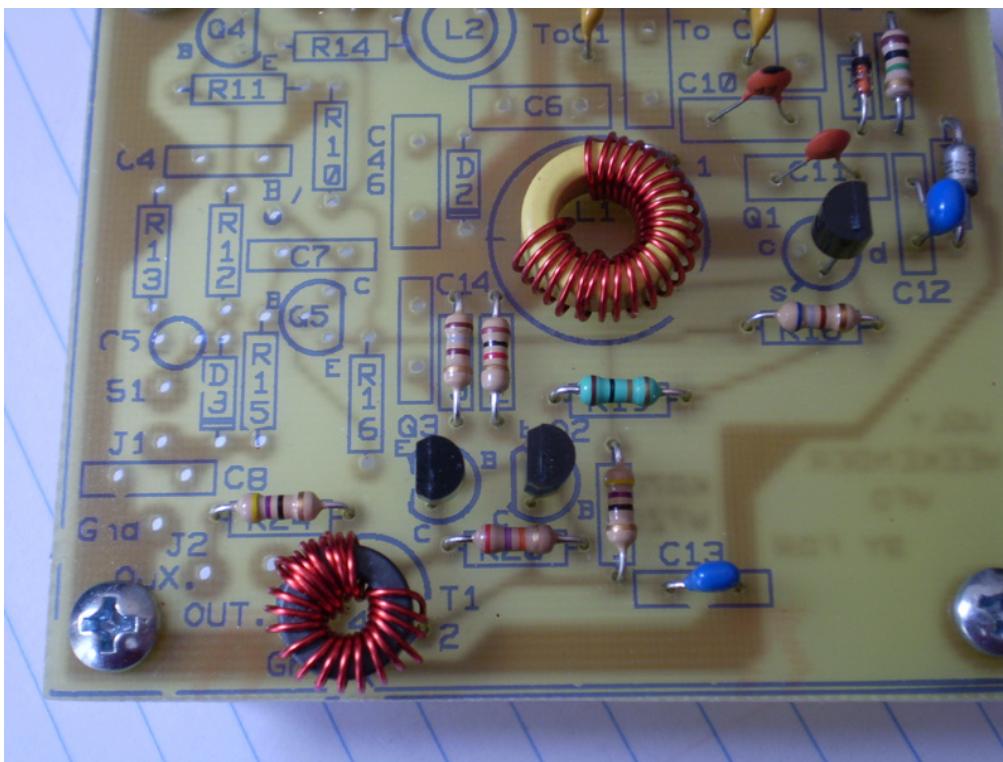

Figure 251: VFO Buffer Amplifier assembly.

Here is the schematic up to this point. Some cosmetic stuff to still be done, but I'm just moving along at my own pace and you have to follow along as best you can. See if you can guess where things are going...

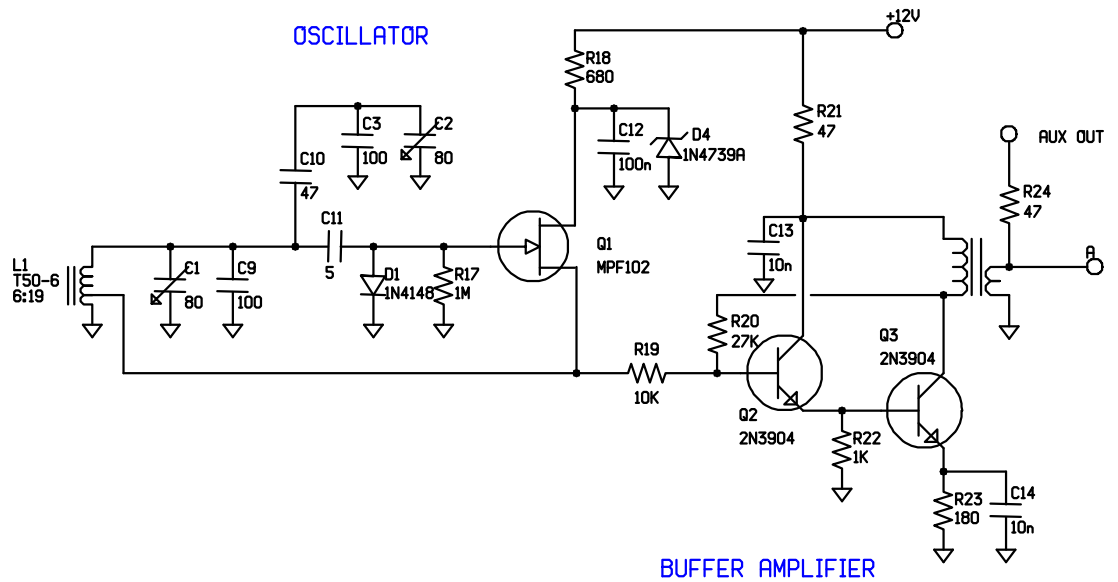

Figure 252: Ugly Weekender Schematic – 003.

Here is the completed VFO and keying circuit board for the Ugly Weekender II transceiver. I will come back and add all the parts to the schematic. This was completed on March 15, 2014.

Using a NorCal FCC-1, I find that the RF out at the AUX OUT point of R24 yields a frequency of 8.05MHz. This is OK as I have yet to put the two variables into the circuit and that will occur in the final assembly and tune up.

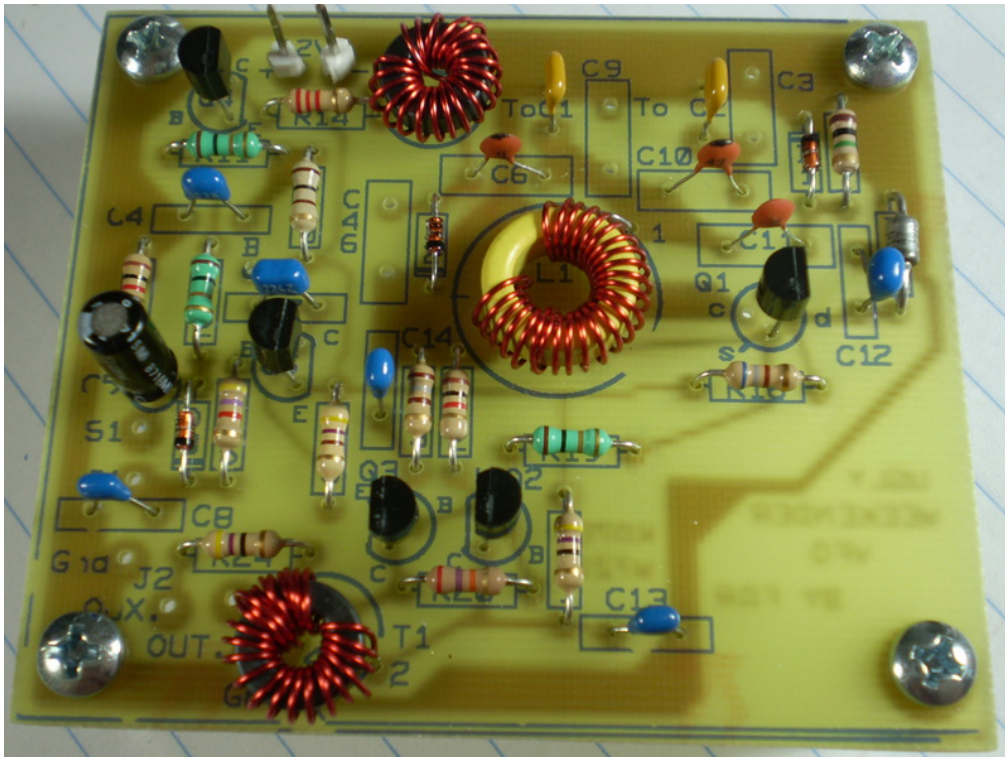

Figure 253: VFO and keying board assembly.

Here is the schematic of the ugly weekender ii up to this point in the assembly procedure for the FAR circuits circuit board.

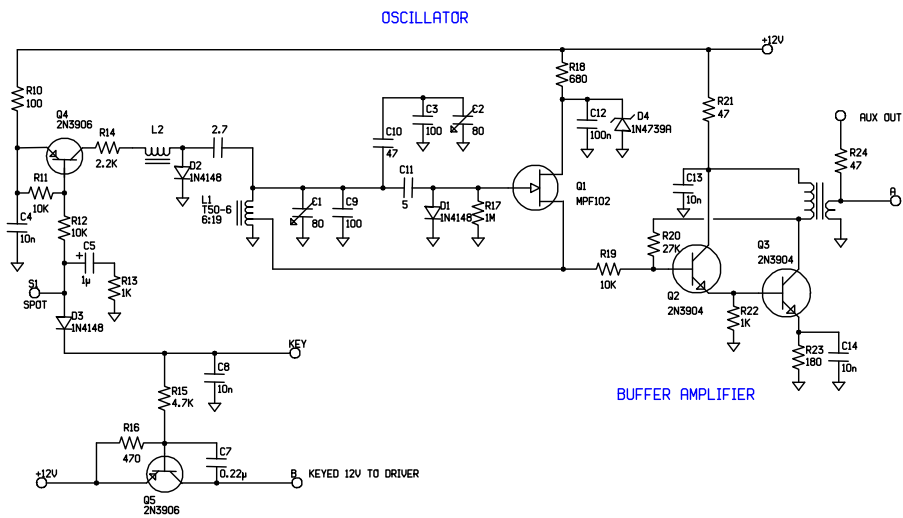

Figure 254: Ugly Weekender Schematic – 004.

25.2 Ugly Weekender II Receiver

Here is the LM386 audio amp section of the receiver. I have used headers for both power and the headphones until the receiver gets put into an enclosure.

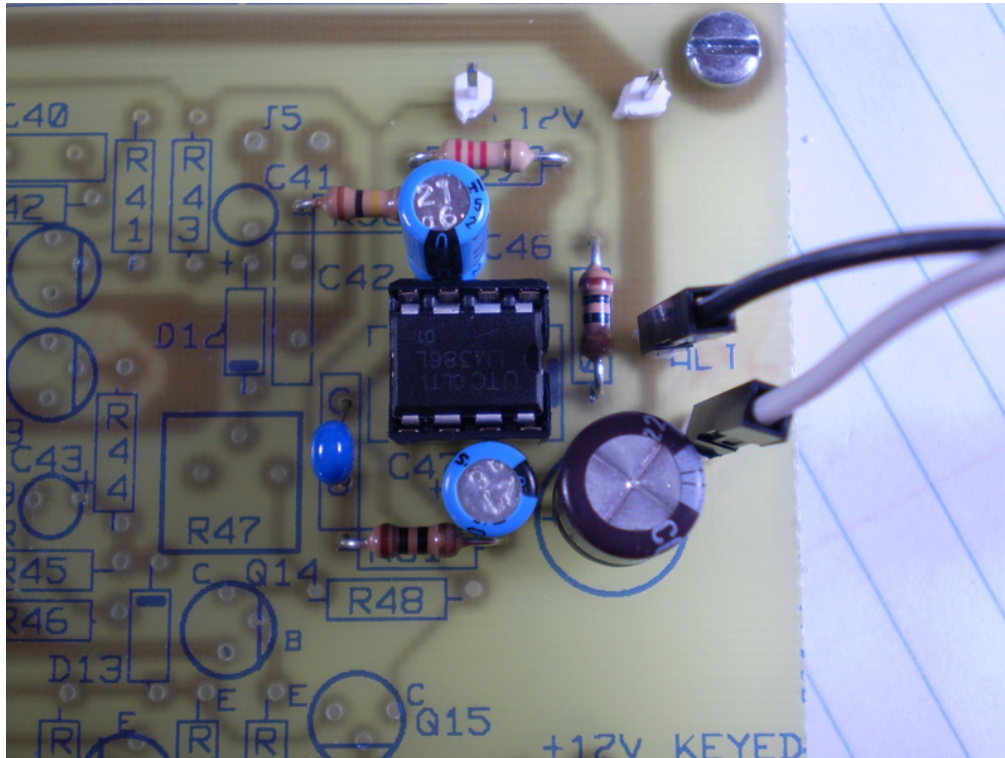

Figure 255: LM386 audio amp section.

I then proceeded to add the switching and mute circuitry along with the sidetone oscillator. I used a test lead with clips on each end to apply 12V to the Q15 switch and the sidetone works. In fact, it works too well. I replaced the R47 variable with a 1M Ω variable and it is still a bit too loud for me.

I recommend that you don't go with the 47K R47 value but go with 1M or larger. Our ears are too important to take chances with.

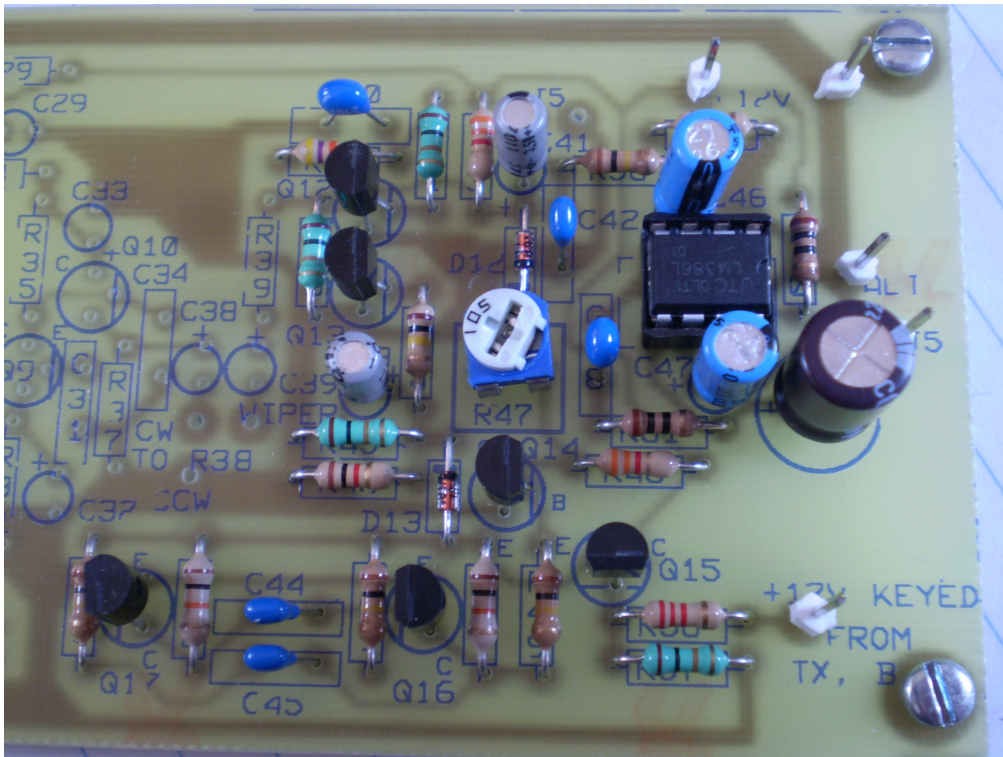

Figure 256: Audio amp and sidetone oscillator section.

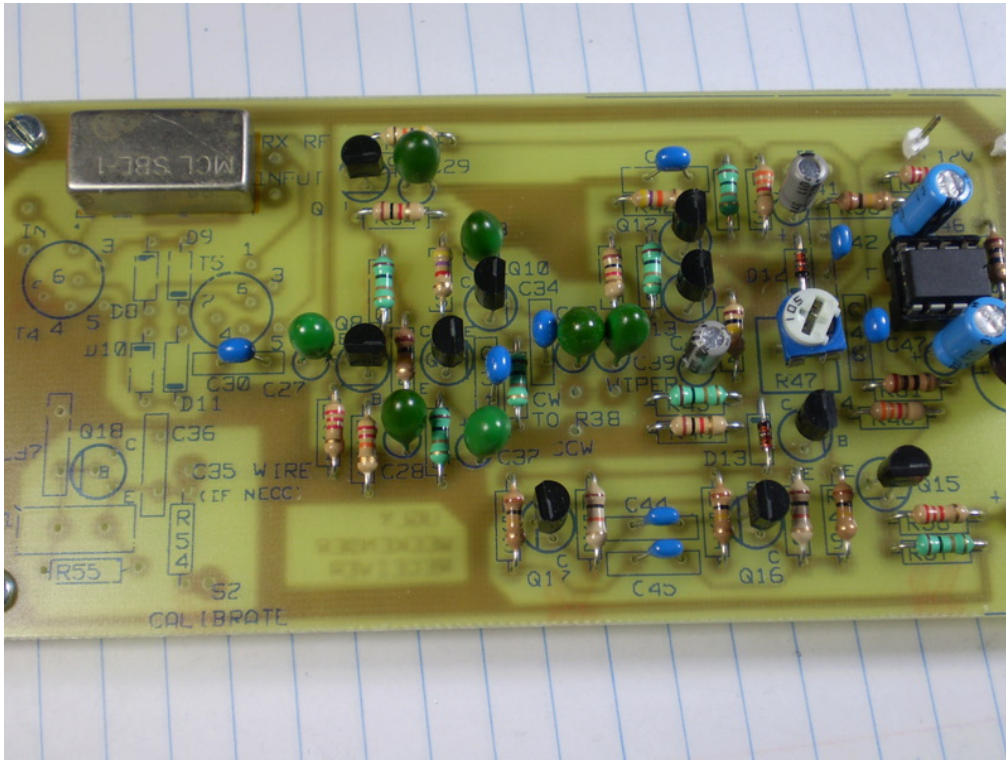

Figure 257: Completed Receiver.

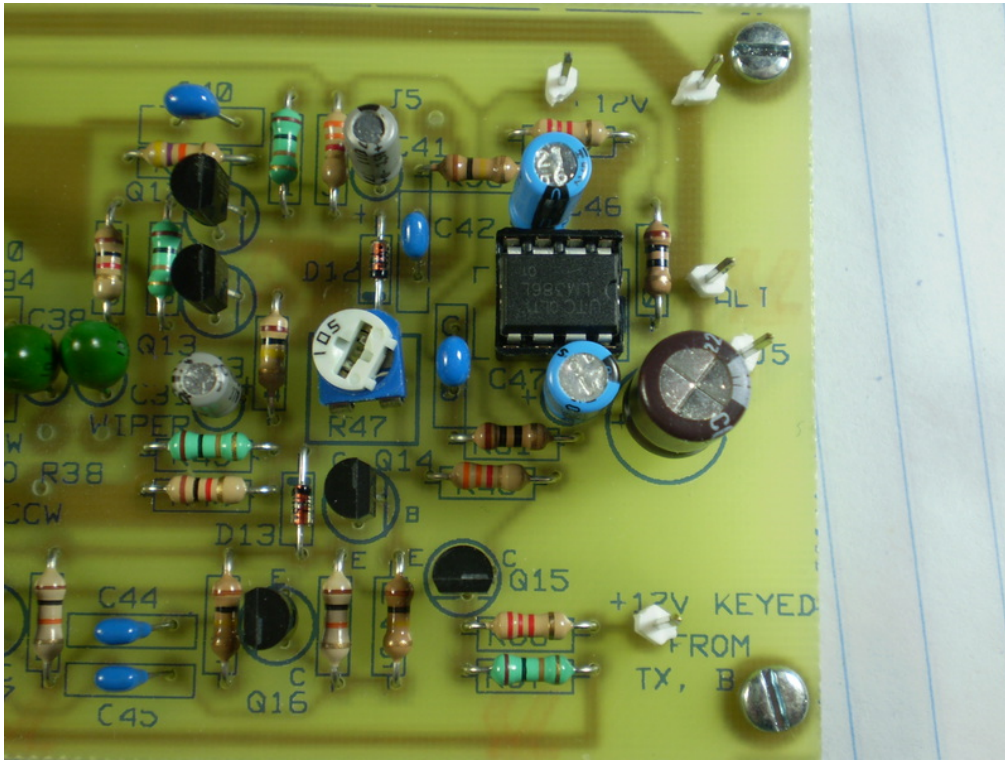

Figure 258: Completed Receiver.

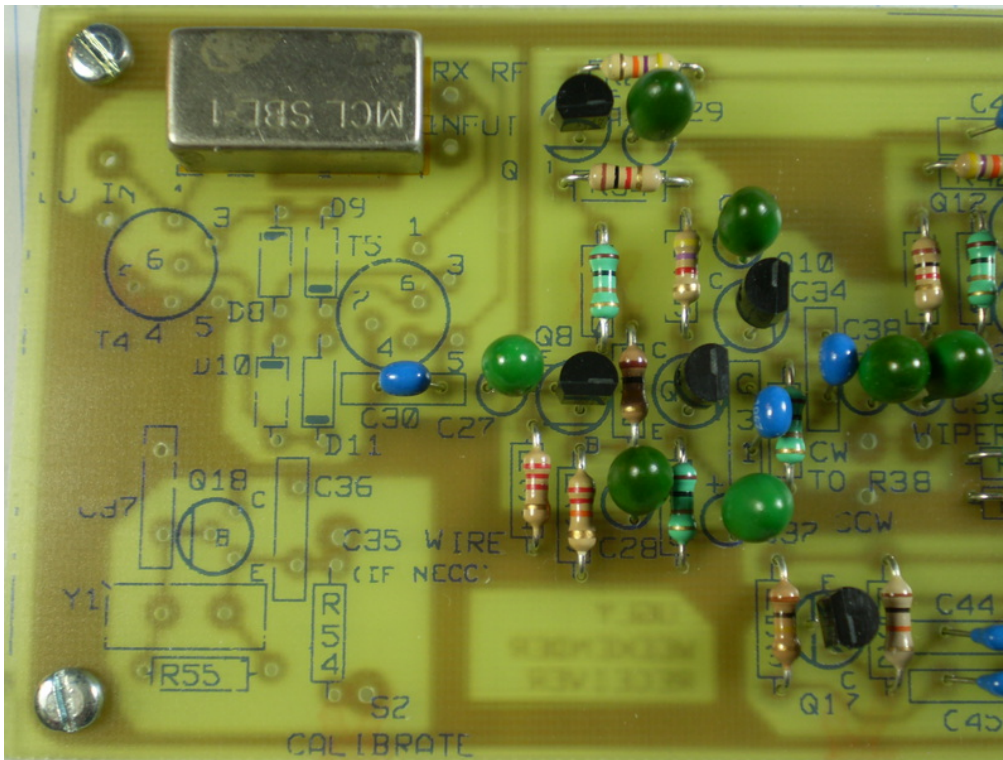

Figure 259: Completed Receiver.

The empty areas in the above photograph are for the discrete version of the mixer, instead of the SBL-1, and the crystal oscillator for the spotting frequency. That is the marker for the QRP frequencies if you use a 7.030MHz or 7.040MHz crystal and even a 7.122MHz crystal if you are a fan of the old Novice band range. I am not. The majority of the Flying Pig Rigs from Diz, W8DIZ, and other kit producers are at the lower QRP watering holes.

Chapter 26

Why Krylon on MUPPET Boards?

Today is January 5, 2015, a Monday. I had just finished the prototype of the QT20, the qrp-tech 20m transceiver. This is the project that takes the Dave Benson NE4040 (40m) and NE3040 (30m) QRP transceiver and converts it to 20m. Instead of calling it the NE2040 (20m), I changed the name to QT20 for 20m and a qrp-tech project.

OK, in cleaning around the lab I found the following board from January 2009. At that time I was creating boards using the toner transfer but using a common household iron for clothes to melt the toner and transfer to the PCB. I was winding up with a sore shoulder joint a lot, so went after the laminator to do all the work.

Here is one of the first boards I did to verify that I could do small traces without fail.



Figure 260: Jan 2009 Test Board after 6 years.

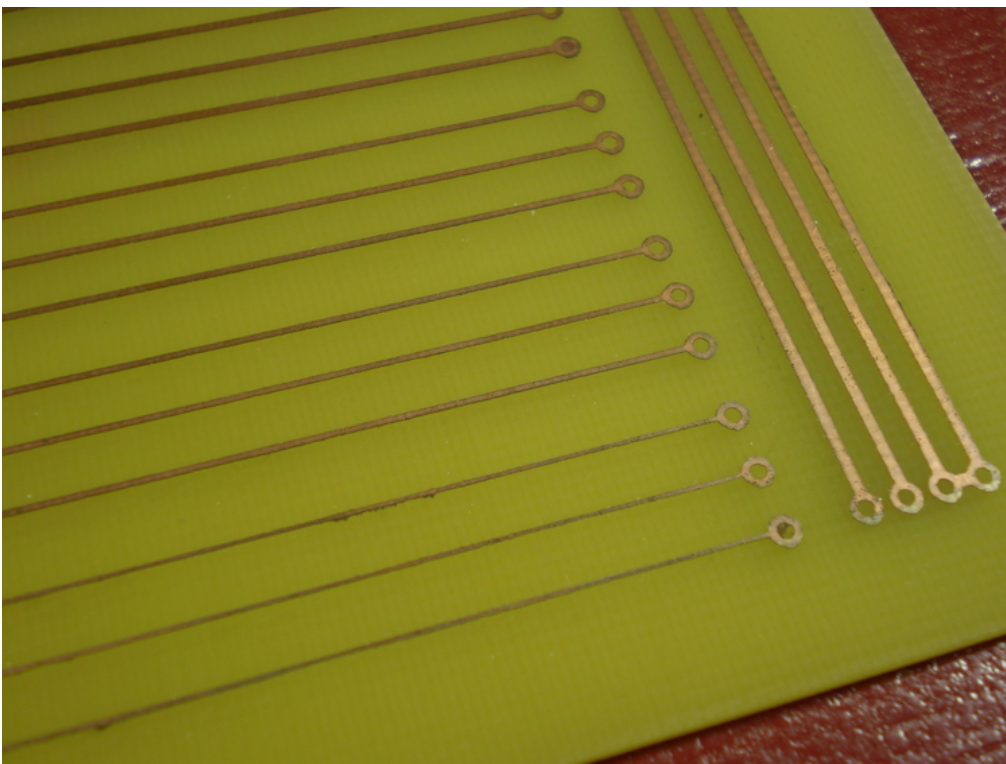

Figure 261: Jan 2009 Test Board after 6 years.

As you can see, the board has oxidized and become somewhat ugly. I knew at the time this was going to happen and after that I started putting a thin coat of Krylon clear spray on boards to protect the surface from dust, fingerprints and general crud in the environment.

To the garage and applied some steel wool and pressure to remove the layer of oxidation. Here is the result:



Figure 262: Steel Wool removal of layer of oxide.

And then a thin coat of Krylon clear spray and heated in toaster oven at 120° F for 45 minutes.

Now you see why I spray my boards after etching and cleaning with the Krylon. Not an OCD thing, but just an extra step to insure longevity of the board. No way I can clean it after it has been soldered to for a project. FYI.

This board should now be protected for the life of the Krylon layer of enamel.

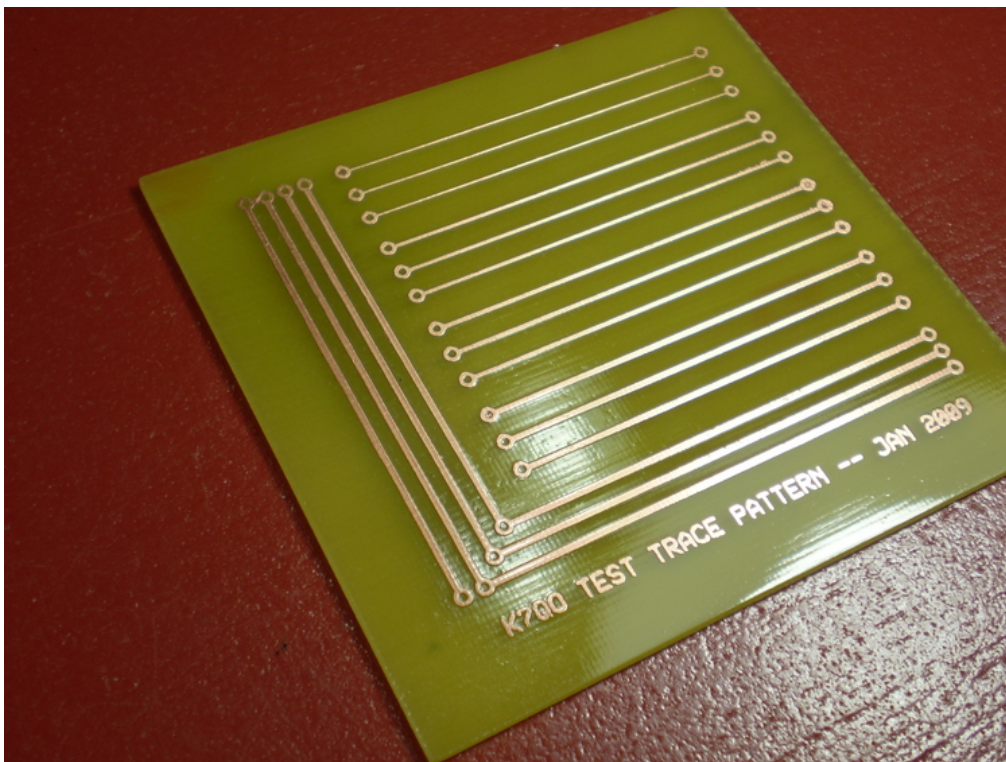

Figure 263: Board after application of thin layer of Krylon Clear.

Chapter 27

The K7QO MUPPET Show-and-Tell

For the past two years I have been building projects using the muppet board technique. As a result, my production level has gone up from what I was doing using Manhattan construction. Also I have been way behind on putting material into the lab notebook.

So, for 2015, I will now try to continue production and at the same time devote more time to writing material for this document. It just takes some time and energy on my part to get it done. Let's see how I do....

Each pair of photographs are given one figure number and the caption, for now, is the JPG number of the image. This is so that I can come back and add names and comments as soon as I can get to it. Thanks for your patience.

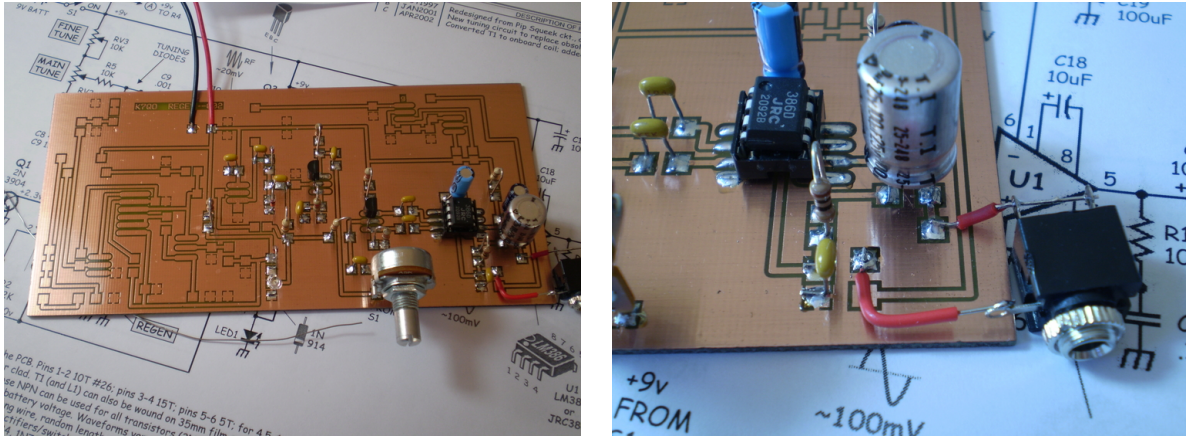

Figure 264: 2549 and 2550

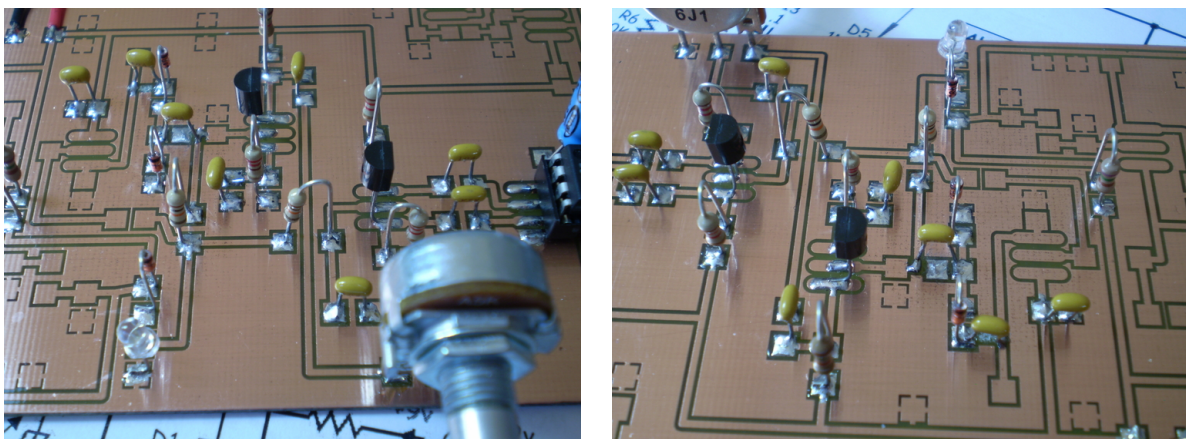

Figure 265: 2551 and 2552

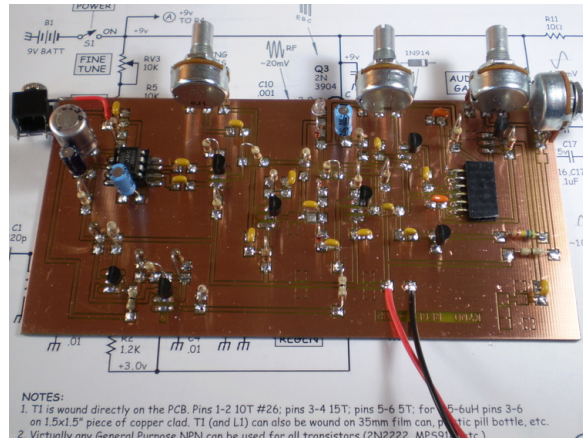
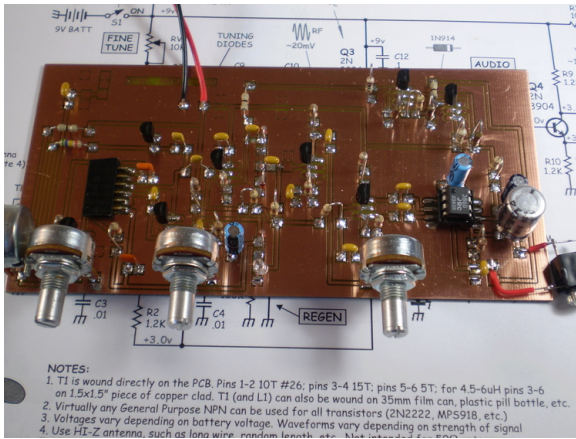

Figure 266: 2553 and 2555

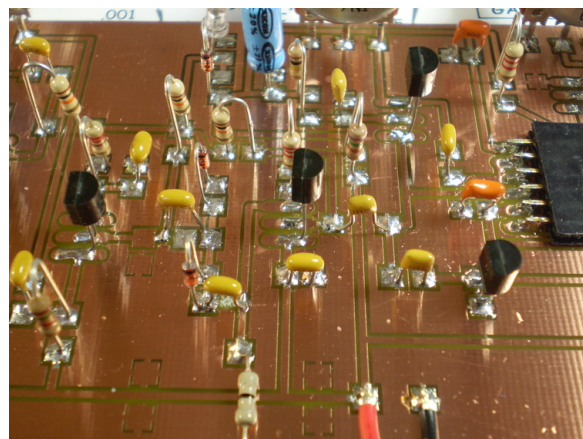
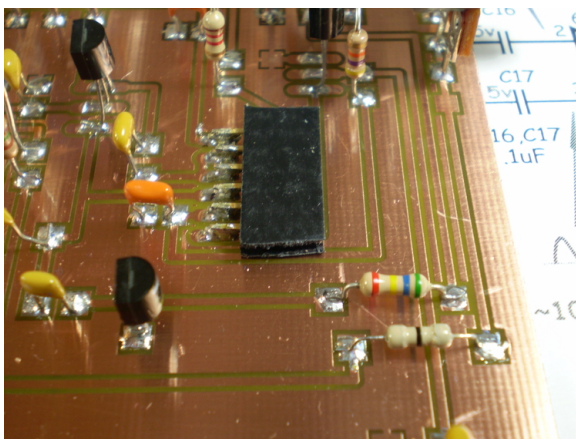

Figure 267: 2556 and 2557

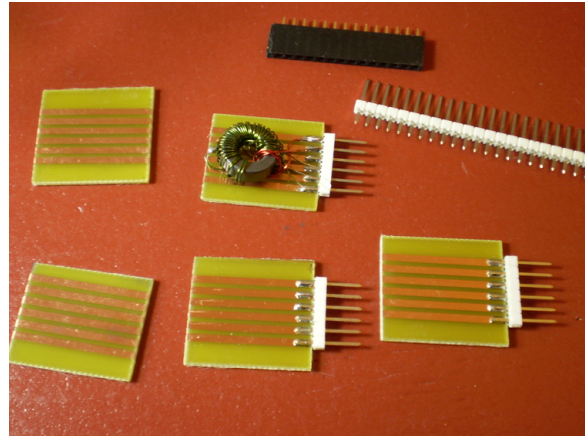
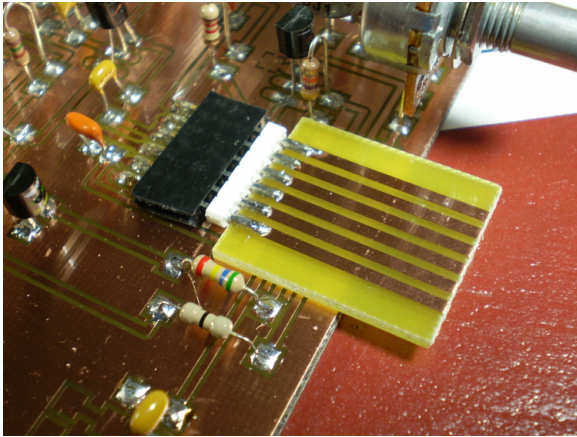

Figure 268: 2558 and 2559

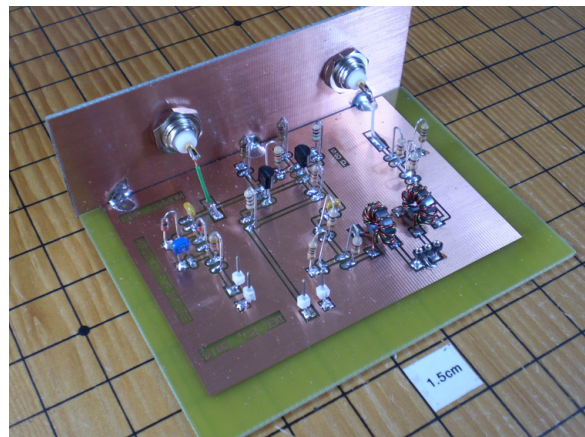
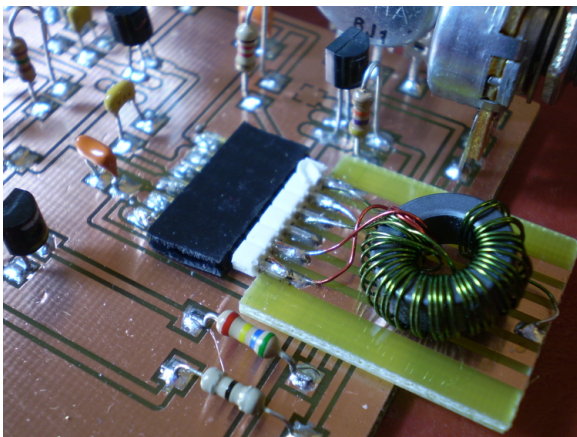

Figure 269: 2560 and 2566

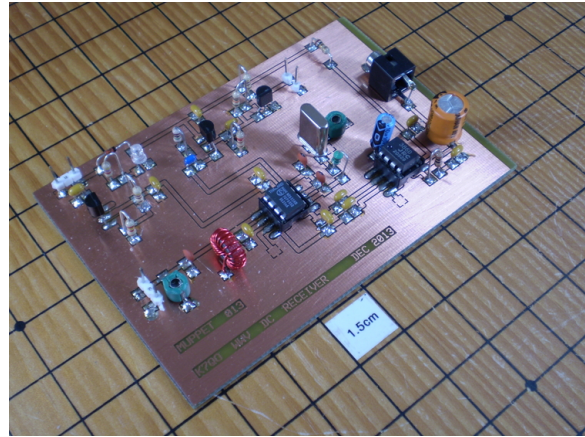
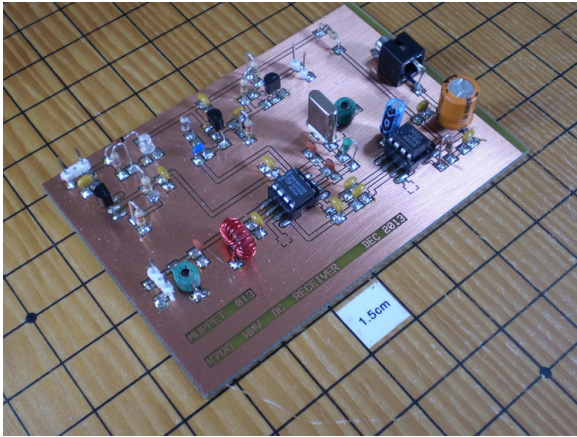

Figure 270: 2567 and 2568

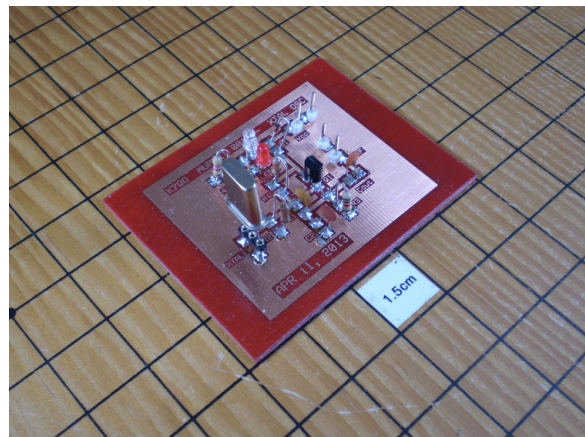
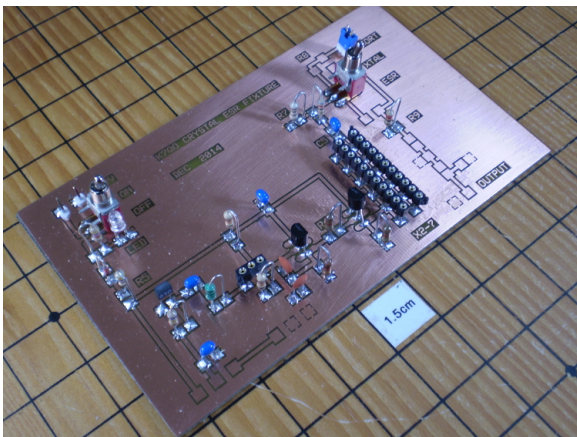

Figure 271: 2569 and 2570

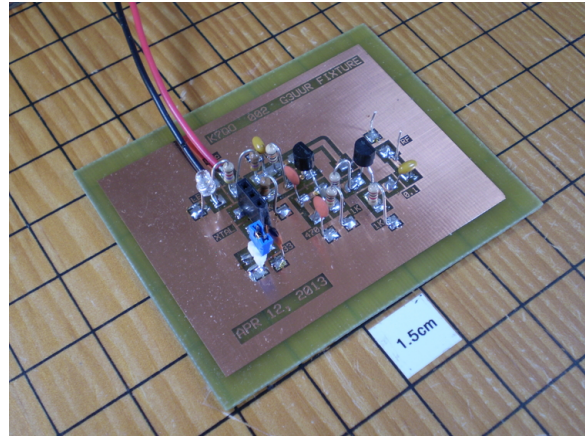
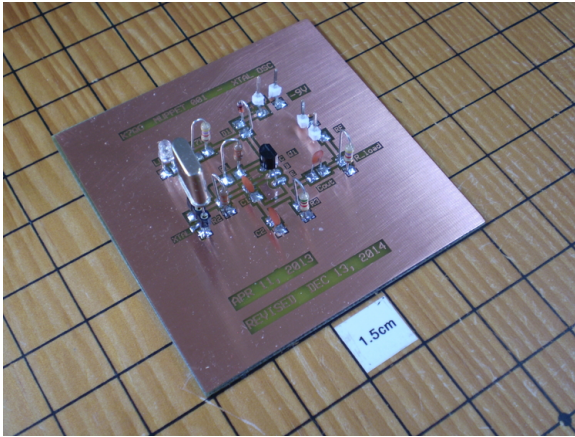

Figure 272: 2572 and 2573

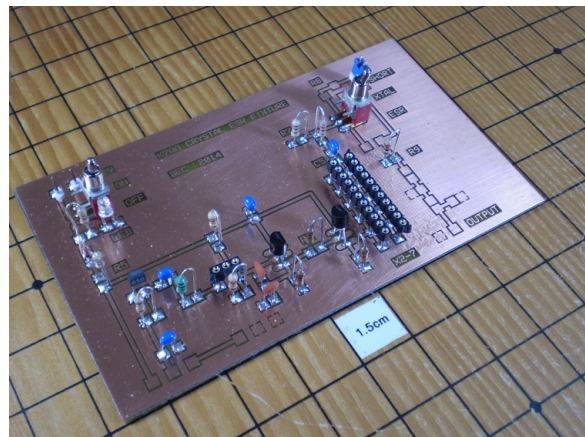
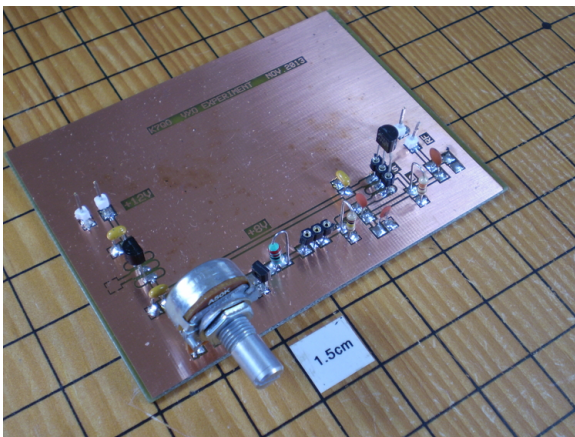

Figure 273: 2574 and 2575

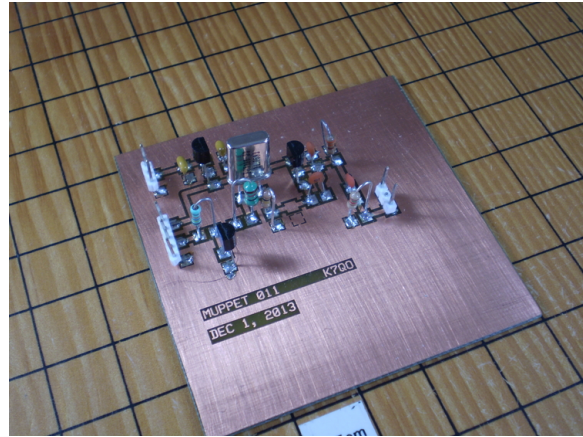
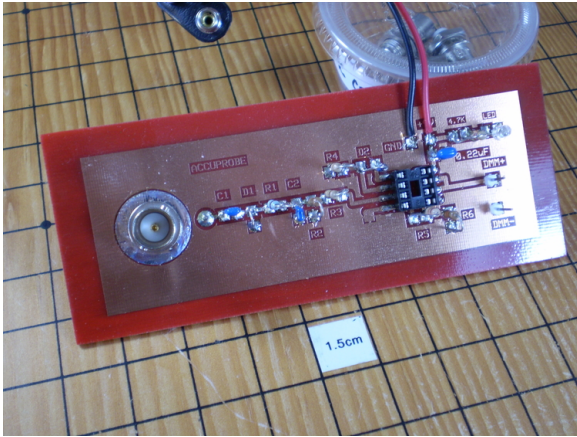

Figure 274: 2576 and 2577

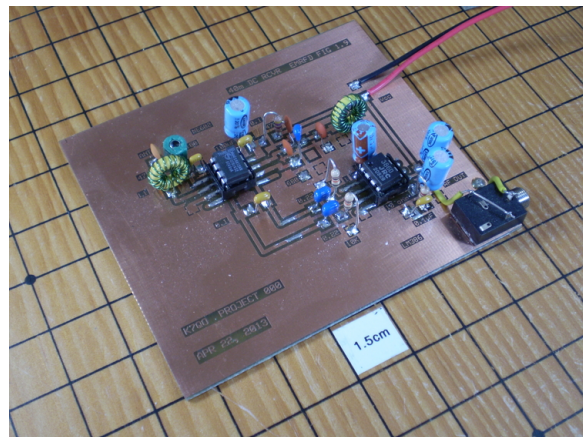
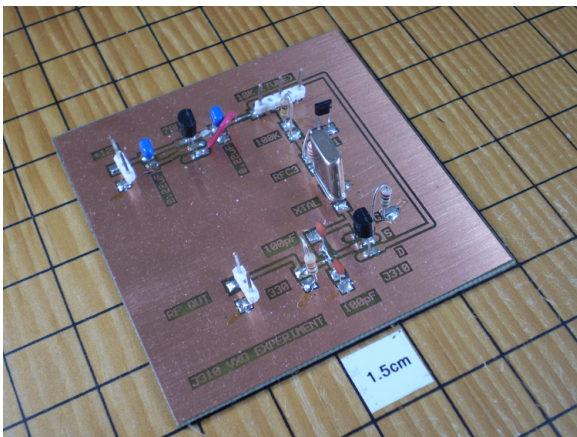

Figure 275: 2578 and 2579

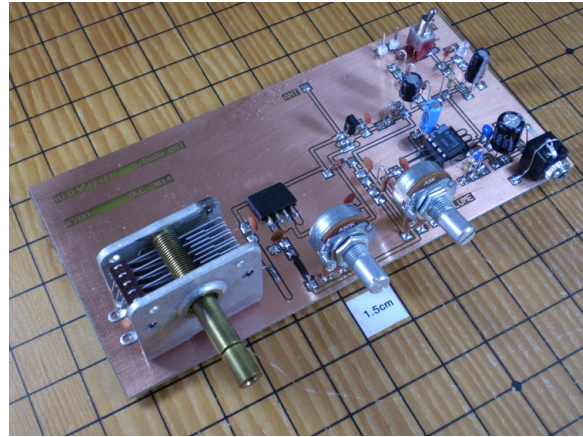
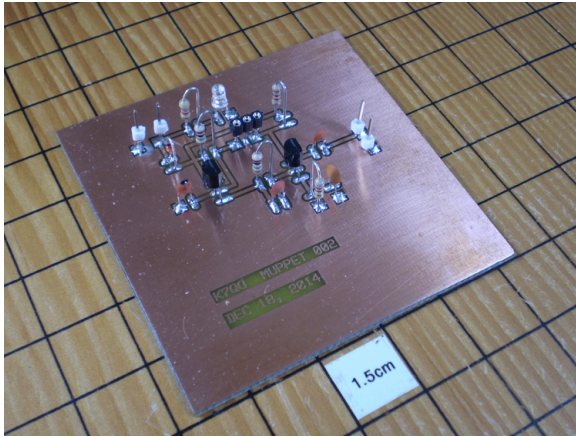

Figure 276: 2571 and 2589

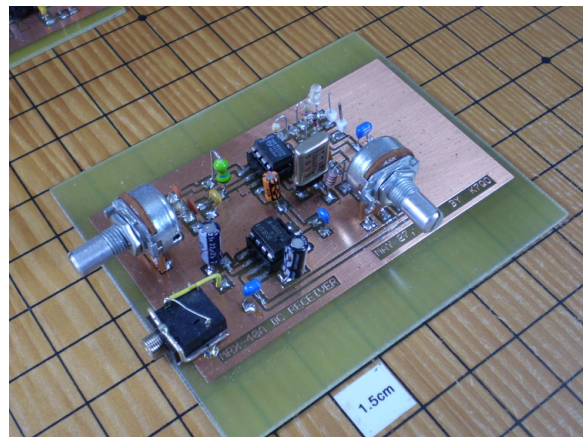
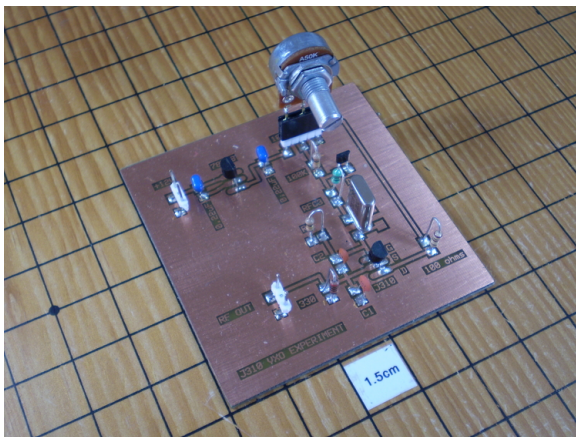

Figure 277: 2580 and 2585

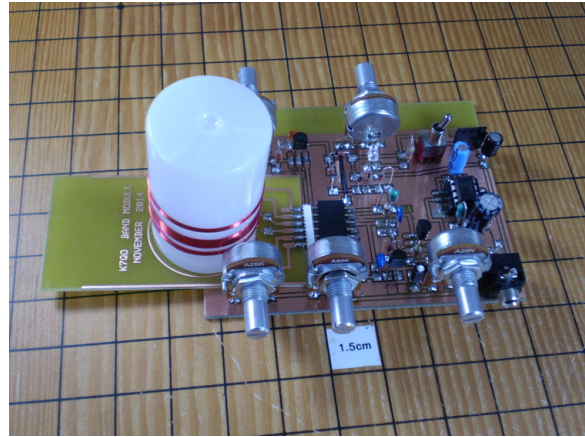
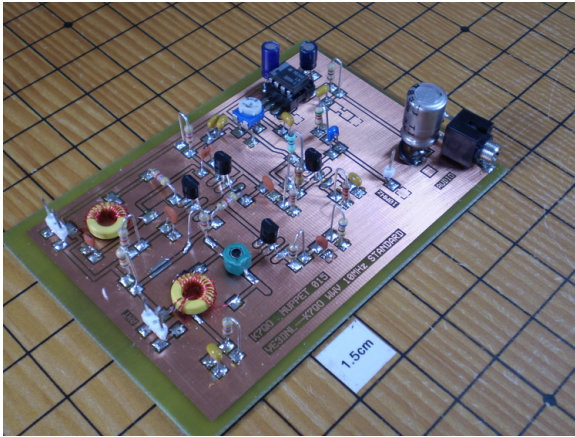

Figure 278: 2583 and 2587

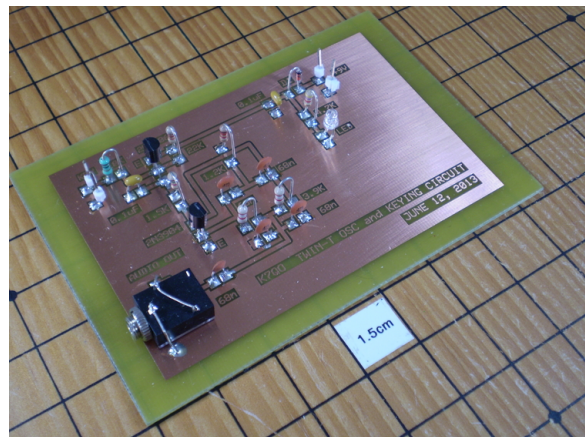
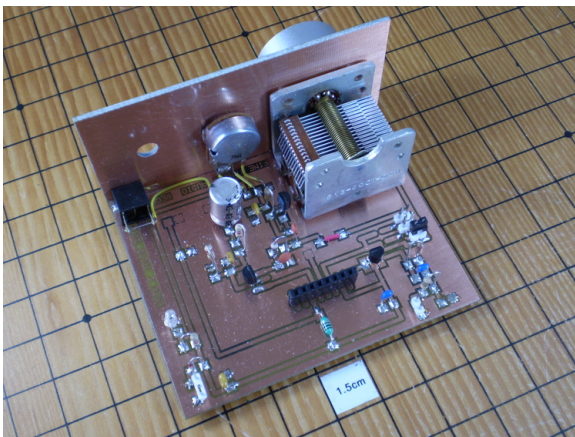

Figure 279: 2591 and 2582

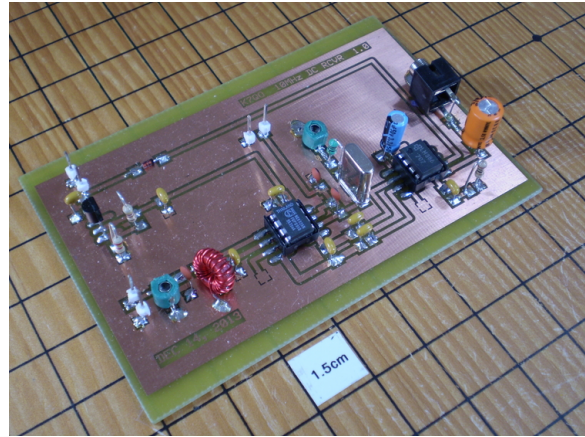
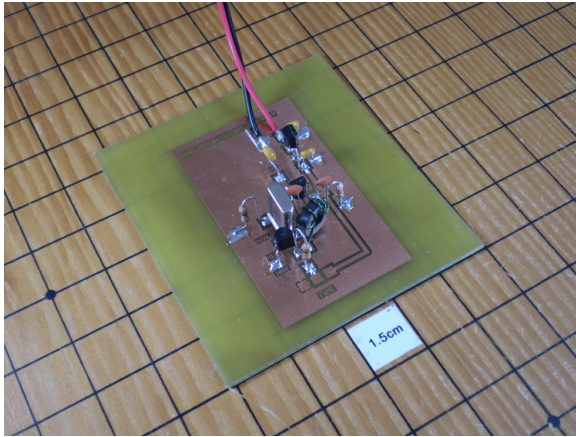

Figure 280: 2581 and 2584

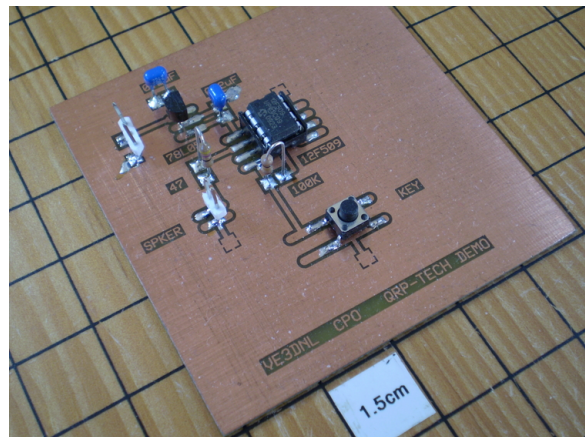
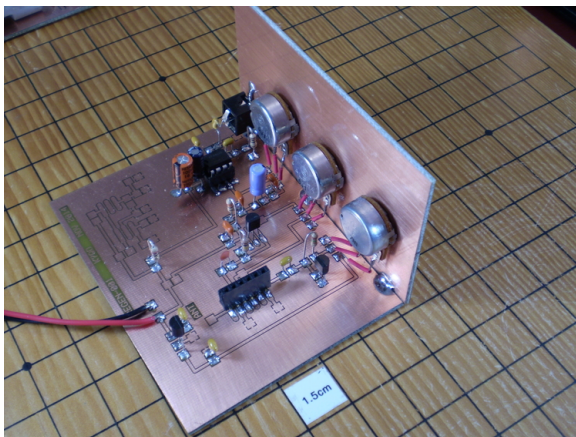

Figure 281: 2590 and 2595

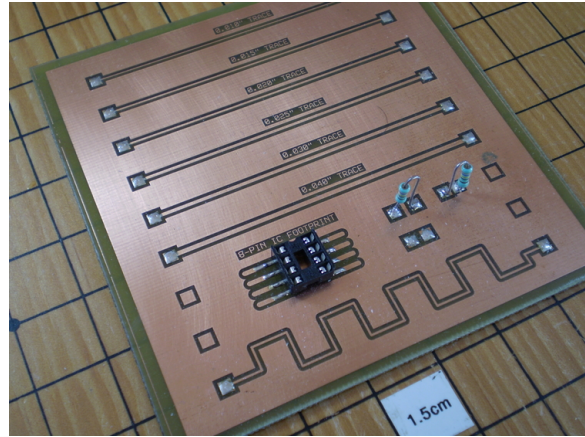
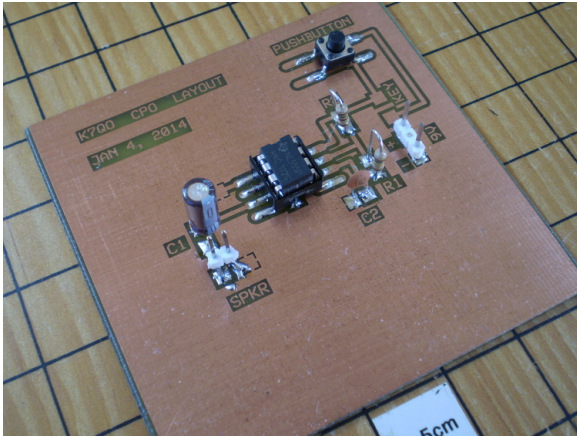

Figure 282: 2596 and 2597

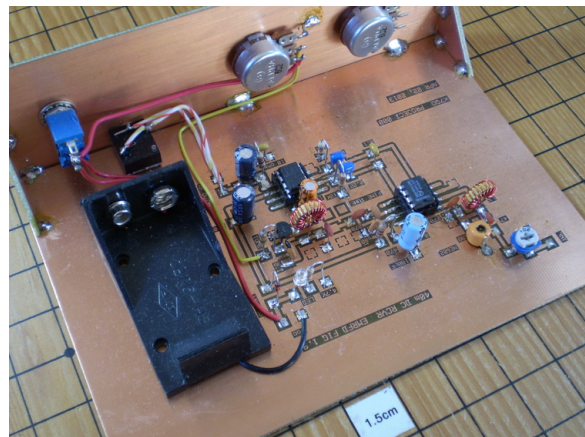
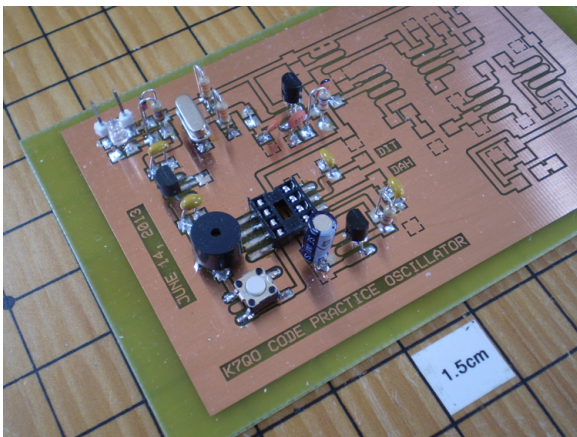

Figure 283: 2598 and 2599

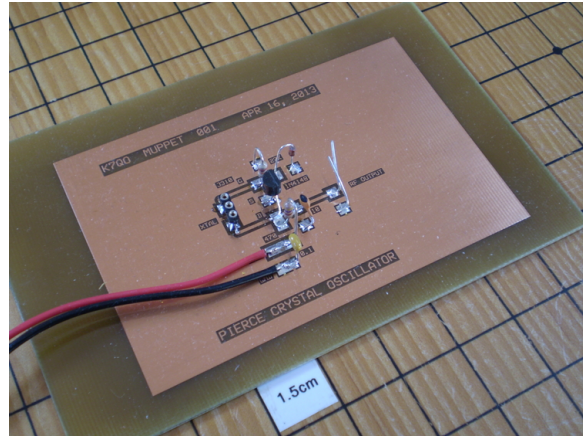
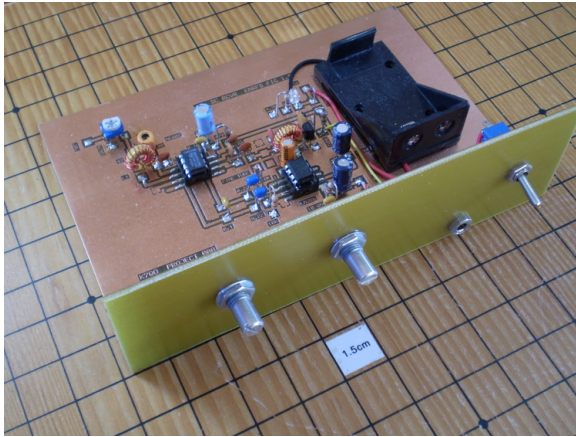

Figure 284: 2600 and 2601

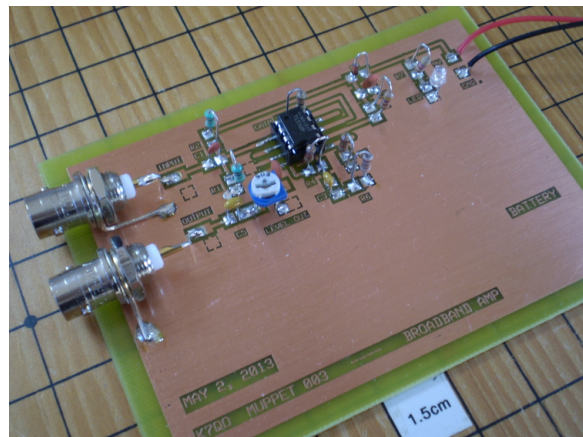
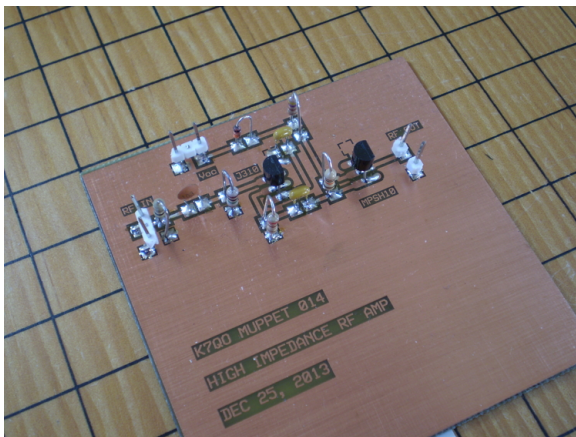

Figure 285: 2602 and 2603

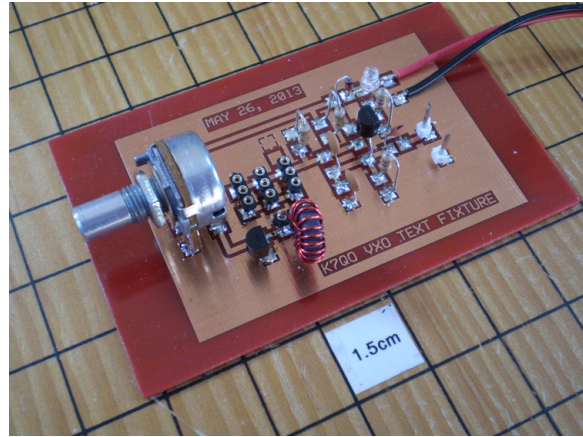
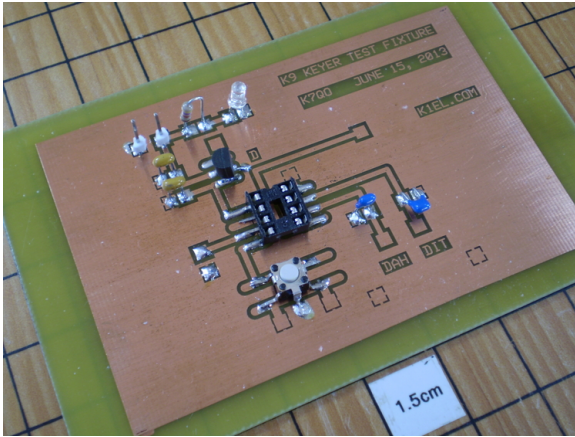

Figure 286: 2604 and 2605

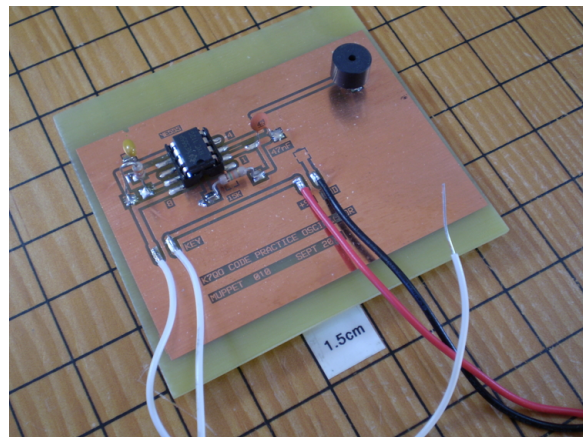
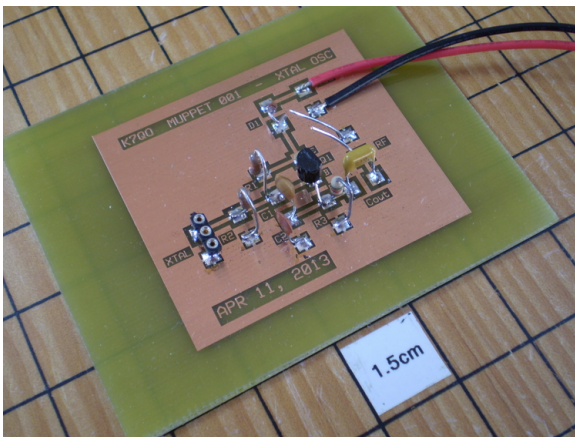

Figure 287: 2606 and 2607

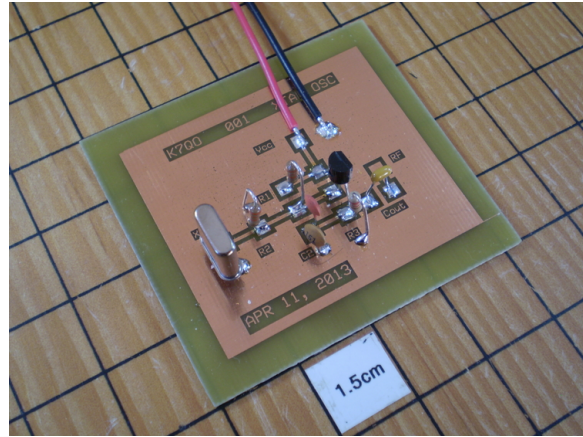
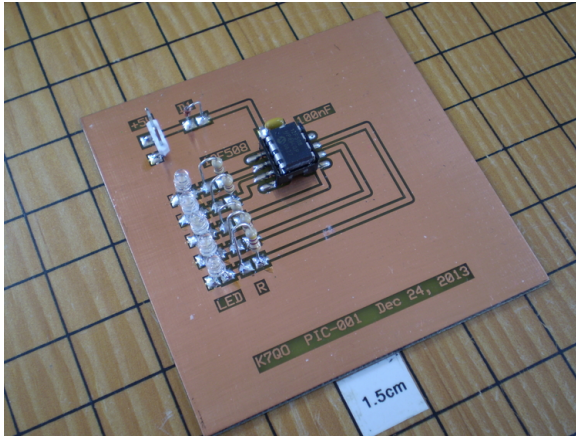

Figure 288: 2608 and 2609

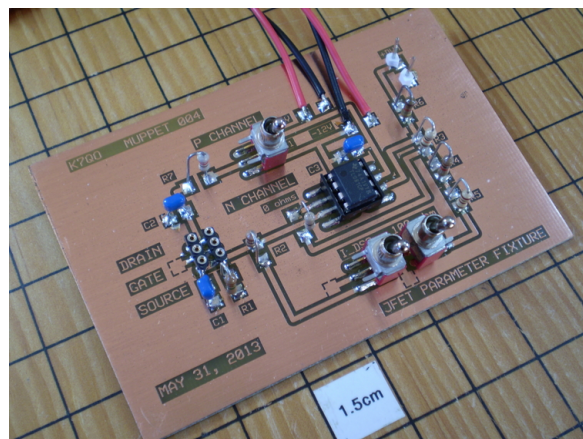
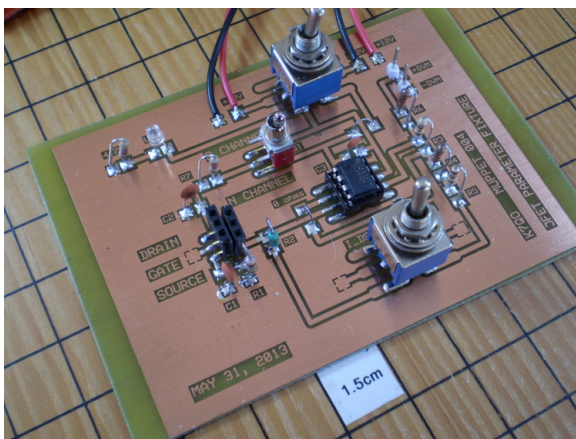

Figure 289: 2610 and 2611

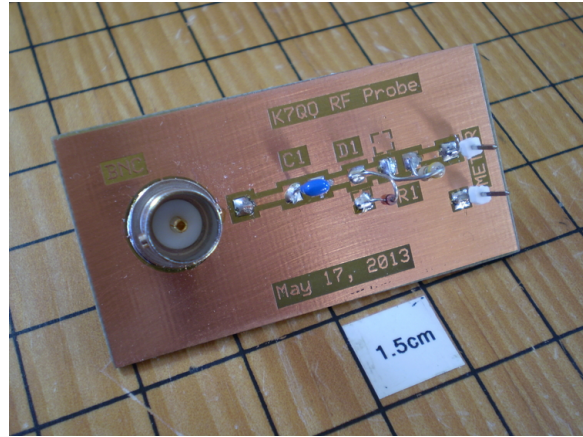
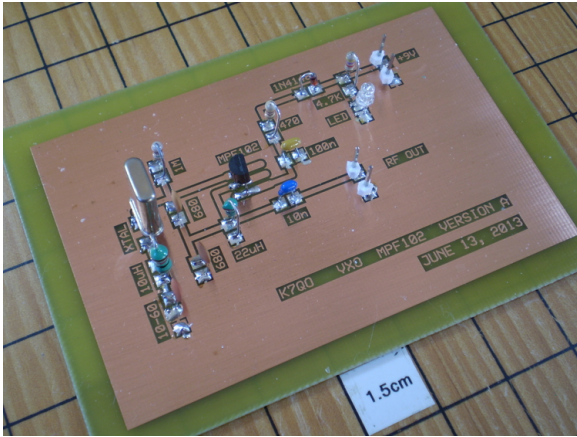

Figure 290: 2612 and 2613

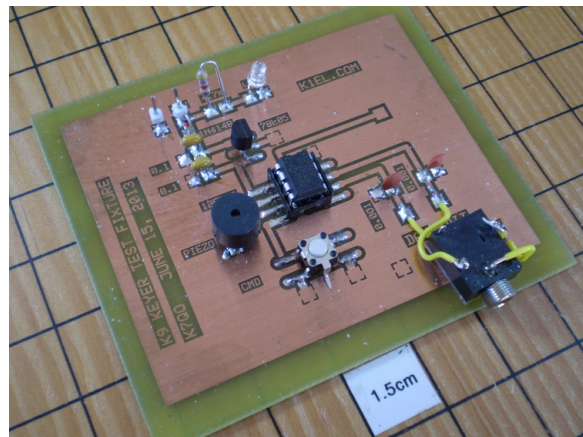
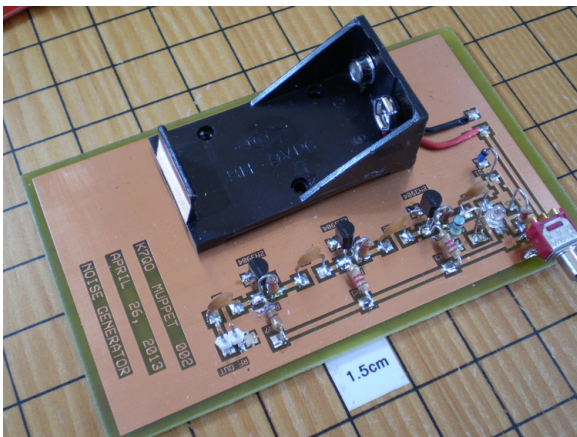

Figure 291: 2614 and 2615

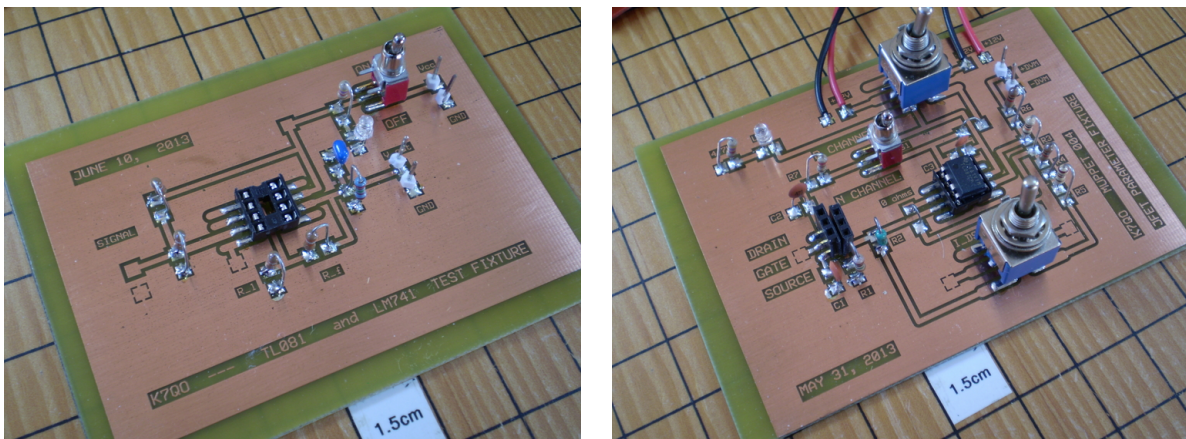

Figure 292: 2616 and 2610

Appendix A

AWG Wire Table

AWG	d [in]	d [mm]	Ω [/1000']	Ω [/km]	I_{max} [amps]
10	0.1019	2.58826	0.9989	3.2763	55
11	0.0907	2.30378	1.26	4.1328	47
12	0.0808	2.05232	1.588	5.2086	41
13	0.0720	1.8288	2.003	6.5698	35
14	0.0641	1.62814	2.525	8.282	32
15	0.0571	1.45034	3.184	10.44352	28
16	0.0508	1.29032	4.016	13.17248	22
17	0.0453	1.15062	5.064	16.60992	19
18	0.0403	1.02362	6.385	20.9428	16
19	0.0359	0.91186	8.051	26.40728	14
20	0.0320	0.81280	10.15	33.292	11
21	0.0285	0.72390	12.8	41.984	9
22	0.0254	0.64516	16.14	52.9392	7
23	0.0226	0.57404	20.36	66.7808	4.7
24	0.0201	0.51054	25.67	84.1976	3.5
25	0.0179	0.45466	32.37	106.173	2.7
26	0.0159	0.40386	40.81	133.857	2.2
27	0.0142	0.36068	51.47	168.822	1.7
28	0.0126	0.32004	64.9	212.872	1.4
29	0.0113	0.28702	81.83	268.402	1.2
30	0.0100	0.25400	103.2	338.496	0.86
31	0.0089	0.22606	130.1	426.728	0.7
32	0.0080	0.20320	164.1	538.248	0.53
33	0.0071	0.18034	206.9	678.632	0.43
34	0.0063	0.16002	260.9	855.752	0.33

Bibliography

- [1] Ashcroft , Neil W, and N. David Mermin. *Solid State Physics*. Newnes, Oxford, 1959. ([physics](#)) **Note: the blue items are the subdirectories in which I have the PDF images of the books listed here.**
- [2] Amos , Stan, and Mike James. *Principles of Transistor Circuits*. Newnes, Oxford, 1959. ([electronics](#))
- [3] Bogart Jr., Theodore F. *BASIC Programs for Electrical Circuit Analysis*. Reston Publishing Company, Inc., Reston, 1985. ([circuits](#))
- [4] Boylestad, Robert and Louis Nashelsky. *Electronic Devices and Circuit Theory. Seventh Edition*. Prentice-Hall, Upper Saddle River, 2006. ([electronics](#))
- [5] Carr, Joseph J. *Mastering Radio Frequency Circuits*. TAB Books, New York, 1994. ([circuits](#))
- [6] Dungan, Frank B. *Op Amps and Linear Integrated Circuits for Technicians. Second Edition*. Delmar Publishers Inc., Albany, 1992. ([circuits](#))
- [7] Gonzalez, Guillermo. *Foundations of Oscillator Circuit Design*. Artech House, Boston, 2007. ([circuits](#))
- [8] Josefsson, Lars and Patrik Persson. *Conformal Array Antenna Theory and Design*. Wiley-Interscience, Hoboken, 2006. ([antennas](#))
- [9] Karris, Steven T. *Circuit Analysis I with MATLAB Applications*. Orchard Publications, Fremont, 2004. ([circuits](#))

- [10] Karris, Steven T. *Circuit Analysis II with MATLAB Applications*. Orchard Publications, Fremont, 2003. ([circuits](#))
- [11] Laport, Edmund A. *Radio Antenna Engineering*. McGraw-Hill Book Company, Inc., New York, 1952. ([antennas](#))
- [12] Li, Richard Chi-Hsi. *RF Circuit Design*. Wiley, New York, 2009. ([circuits](#))
- [13] McMahon, David. *Circuit Analysis Demystified*. McGraw-Hill Publications, New York, 2008. ([circuits](#))
- [14] O'Malley, John. *Theory and Problems of Basic Circuit Analysis. Second Edition*. McGraw-Hill Publishing Company, Inc., New York, 1982. ([circuits](#))
- [15] Pierce, John Franklin. *Transistor Circuit Theory and Design*. Charles E. Merrill Books, Inc., Columbus, 1963. ([electronics](#))
- [16] Ritchie, G.J. *Transistor Circuit Techniques: Discrete and Integrated*. Chapman and Hall/CRC, New York, 1983. ([electronics](#))
- [17] Schilling, Donald L., Charles Belove, Tuvia Apelwicz and Raymond J. Saccardi. *Electronic Circuits : Discrete and Integrated: Third Edition*. McGraw-Hill Publications, New York, 1968. ([circuits](#))
- [18] Silver, Samuel. *Microwave Antenna Theory and Design*. McGraw-Hill Book Company, Inc., New York, 1949. ([antennas](#))
- [19] Spence, Robert. *Introductory Circuits*. Wiley, London, 2008. ([circuits](#))
- [20] Stutzman, Warren L. and Gary A. Thiele. *Antenna Theory and Design*. John Wiley & Sons, Inc., New York, 1981. ([antennas](#))