

J 20 419 F



*A Publication  
for the Radio-Amateur  
Especially Covering VHF,  
UHF and Microwaves*

**VHF**

# **communications**

Volume No. 18 · Autumn · 3/1986 · DM 7.00



*ATV in FM*



# VHF communications

A Publication for the Radio Amateur  
Especially Covering VHF, UHF, and Microwaves

Volume No. 18 · Autumn · Edition 3/1986

## Published by:

Verlag UKW-BERICHTE, Terry Bittan  
P. O. Box 80, Jahnstraße 14  
D-8523 BAIERSDORF  
Fed. Rep. of Germany  
Telephone (9133) 47-0 Telex 629 887  
Postgiro Nbg. 30455-858

## Publisher:

Verlag UKW-BERICHTE, Terry Bittan

## Editors:

Corrie Bittan  
Colin J. Brock (Assistant)

## Translator:

Colin J. Brock, G 3 ISB / DJ Ø OK

## Advertising manager:

Corrie Bittan

## VHF COMMUNICATIONS

The international edition of the German publication UKW-BERICHTE, is a quarterly amateur radio magazine especially catering for the VHF / UHF / SHF technology. It is published in Spring, Summer, Autumn and Winter. The 1986 subscription price is DM 24.00 or national equivalent per year. Individual copies are available at DM 7.00 or equivalent each. Subscriptions, orders of individual copies, purchase of PC-boards and advertised special components, advertisements and contributions to the magazine should be addressed to the national representative, or – if not possible – directly to the publishers.

©Verlag  
UKW-BERICHTE

All rights reserved. Reprints, translations, or extracts only with the written approval of the publisher.

Printed in the Fed. Rep. of Germany by R. Reichenbach KG Krelingstr. 39 · 8500 Nuernberg.

We would be grateful if you would address your orders and queries to your representative.

## Representatives

### Austria

Verlag UKW-BERICHTE, Terry D. Bittan  
PCB 80, D-8523 Baiersdorf/W. Germany  
Credittanstalt Bankvereins, WIEN Kto. 17 90.599,  
Pöschke WIEN 1, 189.146

### Australia

W. I. A. P.O. Box 300, South Caulfield, 3162 VIC, Phone 5285862

### Belgium

HAM INTERNATIONAL, Brusselssesteenweg 428, B-9218 GENT,  
PCR 000-1014267 CCP, Tel. 00-32-91-312111

### Denmark

Halskov Electronic, ØZTLX, Sigersted gamle Skole,  
DK-4100 RINGSTED, Tel. 03-616182, Giro 7 29 68 00

### France

Christiane Miché, F 5 SM, SM Electronic,  
20 bis, Avenue des Clairiers, F-89000 AUXERRE  
Tel. (86) 46 99 59

### Finland

Erdi Hohenthal, SF-31400 SOMERO  
Joensuu tie 6, Tel. 924-46311

### Holland

MECOM, PA 0 AER, Postbus 40, Noordwoldenweg 12,  
NL-9780 AA BEDUM, Tel. 05900-14390,  
Postgiro 3696153

### Israel

Z. Pomer, 4X4KT, PO Box 222, K. MOZKIN 26114  
Tel. 00972-4714078

### Italy

Franco Armenghi, I 4 LCK, Via Sigonio 2,  
I-40137 BOLOGNA, Tel. (051) 34 56 97

### Luxembourg

TELECO, Jos. Faber, LX 1 DE, 5-9, Rue de la fontaine,  
ESCH-SUR-ALZETTE, Tel. 53752

### New Zealand

E. M. Zimmermann, ZL 1 AGO, PO Box 31-261  
Milford, AUCKLAND 6, Phone 492-744

### Norway

Hennig Theg, LA 4 YG, Postboks 70,  
N-1324 LYSAKER, Postgirokonta 3 16 00 09

### South Africa

SA Radio Publications, PO Box 84454  
GREENSIDE 2034, Telephone 011-3378472

### Spain + Portugal

Julio A. Prieto Alonso, EA 4 CJ, MADRID-15,  
Donoso Cortés 88 5<sup>a</sup> B, Tel. 243 83 84

### Sweden

Carl-Oscar Biese, SMeHVL, Gjöterbacken 12 B  
S-17239 SUNDBYBERG, Tel. 08-29 63 22

### Switzerland

Terry Bittan, Schweiz, Kreditanstalt ZÜRICH,  
Kto. 469-253-41 · Pöschke ZÜRICH 60-54-849

### USA

UV COMMS, K3BR5  
PO Box 432, LANHAM, MD 20706  
Tel. 301-459-4924

ISSN 0177-7505



## Contents

Roman Polz, DC 2 CS	<b>IF Amplifier and Demodulator for Wideband FM</b>	130 - 134
Carsten Vieland, DJ 4 GC	<b>Modifying the FT 225 RD</b>	135 - 138
J. Jirmann, F. Krug, DB 1 NV, DJ 3 RV	<b>Microcomputer System Part 2: The CPU and Floppy Disc Controller</b>	139 - 142
Matjaž Vidmar, YU 3 UMV	<b>Microstrip Transverters for 23 and 13 cm Part 2</b>	143 - 164
Josef Grimm, DJ 6 PI	<b>Frequency Modulated Amateur Television (ATV)</b>	165 - 176
Carsten Vieland, DJ 4 GC	<b>Tunable VHF to SHF Bandpass Filter</b>	177 - 185
Erich Stadler, DG 7 GK	<b>Reflection Coefficient</b>	186 - 188
Editors	<b>Briefly speaking</b>	189





Roman Polz, DC 2 CS

## IF Amplifier and Demodulator for Wideband FM

This article describes an IF module for satellite T.V. The amplifier and demodulator components chosen are suitable for any frequency between 300 MHz and 1 GHz, but 480 MHz has been chosen for this design due to the availability of a standard surface-wave filter which provides all necessary selectivity and removes the need for any alignment. A prototype of the completed amplifier is shown in fig. 1.

---

### 1. CONCEPT

---

The module is designed around an FM demodulator circuit, the SL 1452, which requires a minimum input level of 10 mV. The typical 17 dB loss in the chosen SAW filter must be considered when designing the IF module – too much gain

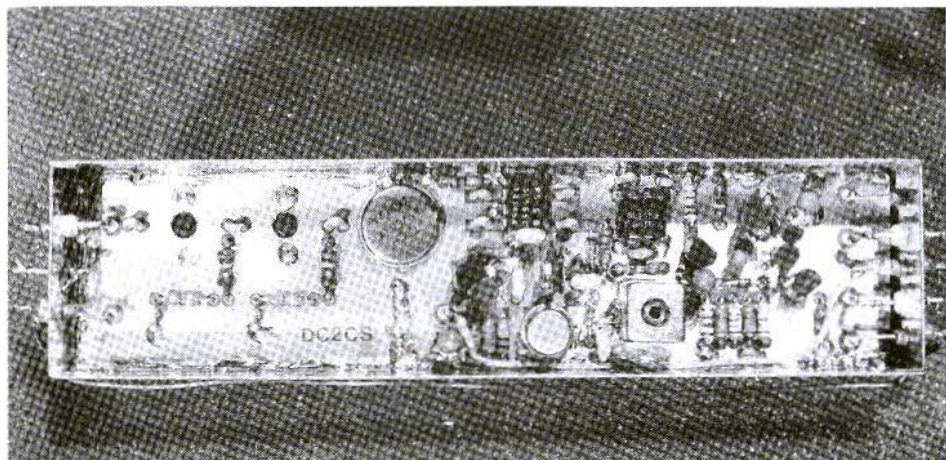

Fig. 1: The module DC 2 CS 001 is about 150 mm long, 37 mm wide and 30 mm high



after the filter will result in poor noise performance — whereas high gain before bandwidth limitation could cause overload problems. A reasonable compromise was effected by arranging two stages of amplification before the filter and a single stage following it.

Although PLL demodulators for this frequency range are available from the same manufacturer, the simple quadrature demodulator was chosen for its ease of use and alignment. Despite its simplicity, the SL 1452 gives a very linear video output signal with low intermodulation. The video output from the SL 1452 is split to provide a video output and an AFC signal. The AFC output being buffered by an emitter follower whereas the video output amplifier is a damped inverter stage with sufficient gain to drive a monitor.

An active rectifier gives an output voltage proportional to the applied IF level for field strength indicator or gain control of earlier stages. A de-emphasis network is not fitted to the board as component values may vary for different transmission standards.

## 2. CIRCUIT DESCRIPTION

Fig. 2 shows the complete circuit diagram.

### 2.1. IF Amplifier

The two-stage amplifier (I 1, I 2) in front of the filter uses wideband amplifiers type MSA-0104 which are AC coupled by C 1, C 2, C 3. The value of these capacitors is not critical. Bias conditions for the amplifiers are set by the load resistors (R 1, R 2) which provide an operating voltage of 5 V with 18 mA supply current from the 12 V supply. Supply decoupling is provided by RF chokes and capacitors (ch 1, ch 2; C 4, C 5). Each stage has a gain of 17 dB or in other terms, the applied power is amplified by the factor of 50.

The SW 504 SAW filter has a typical insertion loss of 17 dB, a bandwidth of 27 MHz, which is suitable for satellite television broadcasts, and worst case

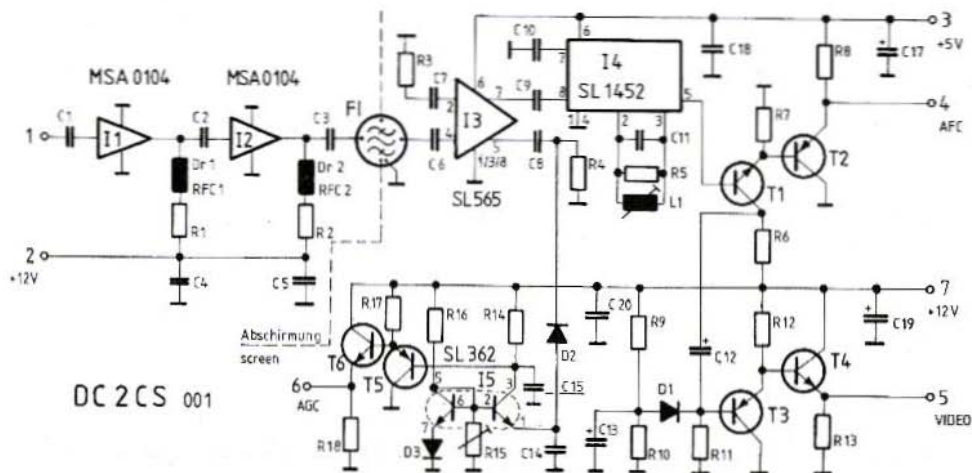

Fig. 2: The demodulator coil L 1 is the only unit to be aligned in this IF amplifier and demodulator for wideband FM



sidelobes of -30 dB, but careful layout is required if this specification is not to be degraded. Direct breakthrough between the filter input and output must be reduced to less than 60 dB (20 dB loss + 40 dB selectivity) by ensuring the metal case is soldered to the PCB ground plane and the ground must be throughplated between the filter inputs and outputs to provide a screen. To avoid coupling via the supply rails, the 12 V line is brought out separately from each side of the filter.

An SL 565 amplifier (I 3), immediately following the filter, provides 14 dB of gain, the differential outputs being used separately to drive the AGC rectifier and the demodulator IC (I 4). The unused differential input is decoupled by C 7 and R 3.

## 2.2 Demodulator

The SL 1452 will function with input levels between 10 mV and 300 mV, corresponding to -27 dBm and +3 dBm. Operating frequency may be in the range 300 MHz to 1 GHz, but due to the internal divide by four, the quadrature demodulator operates from 75 MHz to 250 MHz, easing the design and assembly of the quadrature circuit. In most cases, a standard coil assembly can be used and for the 480 MHz design being considered here, tuned circuit values of 40 nH and 47 pF are suitable for L 1 and C 11. Other combinations of capacitance and inductance giving a similar resonant frequency can be used, the provided C 11 value is sufficient to dominate stray capacitance effects.

Demodulation gain, measured in mV / MHz, and therefore the maximum deviation demodulated without excessive distortion is determined by the Q of the quadrature circuit. Values for Q between 4 and 6 have proved suitable for use in this application. The desired Q is obtained by connecting a shunt resistor (R 5) in parallel with the tuned circuit and calculating the required value from

$$R = Q \cdot 2 \cdot \pi \cdot f \cdot L$$

R is the total damping resistor in Ohms, Q is the required quality factor,  $\pi$  is the constant 3.1415, f is the resonant frequency in Hz and L is the inductance value in Henrys. An internal resistance value of 800 Ohms exists between pins 2

and 3 which should be taken into account when calculating damping resistor value.

For example:

$$L = 40 \text{ nH}, C = 43.9 \text{ pF (norm. value 47 pF)}, Q = 5$$

Therefore

$$R = 5 \cdot 2 \cdot 3.14 \cdot 120 \cdot 10^6 \cdot 40 \cdot 10^{-9} = 150 \text{ Ohms}$$

correcting the internal 800 Ohm resistor gives  $R_5 = 184.6 \text{ Ohms}$  and therefore the nearest standard value 180 Ohms is used. When determining the value of R 5, it should be remembered that the obtainable video bandwidth is also affected by the Q factor. Experimentally determined values are  $Q = 10$  at 7.5 MHz,  $Q = 6$  at 14 MHz and  $Q = 4$  at 23 MHz.

## 2.3 Video Amplifier

The video output available from the SL 1452 is not suitable for direct connection to a monitor screen, being of relatively high output impedance with a DC offset voltage dependent on input frequency, which may be used for AFC purposes. In addition, the polarity of the output video, having positive syncs when a high side second local oscillator is used, is the inverse of that required for most monitors.

Maximum flexibility is obtained by using two separate video amplifiers, T 1 and T 2 give an output voltage on pin 4 similar to that on the output of the demodulator suitable for AFC. An additional inverted output amplified by the factor R 6 / R 7 is available from T 1 collector. This output is AC coupled and clamped by C 12 and D 1 to the level determined by R 9 and R 10 and buffered by emitter followers T 3, T 4 to give a video signal with fairly constant DC level.

## 2.4. Level Detector

A balanced arrangement of dual transistor (I 5) and Schottky diodes (D 2, D 3) is used to provide a fairly stable AGC point. In addition the detector diode D 2 is forward biased by a current via R 14 and R 4, overcoming the bias voltage of the diode and allowing detection of low signals. As the output level from I 3 increases, the negative



voltage on C 14 increases and the voltage on R 14 drops, producing an equal shift in the voltage at the AGC output. The AGC time constant is determined by R 14, C 15.

Adjustment of the AGC threshold can be made by varying R 15 and the available output swing from 11 V to 0.1 V is roughly equivalent to a 10 dB increase in the IF level on input (1).

The high sensitivity and large adjustable operating window allow the AGC output to be used for converter alignment or antenna adjustment, whilst the operating mode – where a higher IF level input gives a lower DC output level – was chosen to allow AGC control using gate 2 of a dual-gate MOSFET.

### 3. CONSTRUCTION

The circuit is built on a throughplated PCB, 35 × 145 mm, as shown in **fig. 3**. A suitable metal case is available as a standard part. During construction, it is advised that the 7 solder pins are inserted firstly, followed by the passive components and finally the transistors and integrated circuits.

Both amplifiers I 1 and I 2 are attached from beneath the board into the 4.5 mm holes, allowing the leads to be trimmed to about 3 mm, the dot on the package indicating the output pin. A short connection to the ground plane from both earth pins via contact holes is essential for good performance.

When all components have been assembled, the board may be soldered into the prepared case, using feed-through capacitors for the power supplies and low capacitance feed-through for the IF input and video output. A feed-through capacitor or low-capacitance feed-through is suitable for the AGC output.

#### 3.1. Parts List

I 1, I 2:	MSA 0104 wideband amplifier (Avantek)
I 3:	SL 565 CDP wideband differential amplifier (Plessey)
I 4:	SL 1452 wideband FM demodulator (Plessey)
I 5:	SL 362 NPN dual transistor (Plessey)
F I:	SW 504, 480 MHz SAW filter (Signal Technology)
T 1, T 4, T 6:	BC 550 NPN transistor
T 2, T 3, T 5:	BC 560 PNP transistor
D 1:	1 N 4148 Si diode
D 2, D 3:	5082-2800 Schottky diode (HP)
L 1:	E 526 HNA 100071 40 nH tunable (Tokio)
RFC 1, RFC 2:	6.8 $\mu$ H choke
C 1 ... C 10, C 18:	680 pF ceramic capacitor RM = 2.5 mm
C 11:	47 pF ceramic capacitor RM = 2.5 mm
C 12:	4.7 $\mu$ F / 16 V electrolytic, standing
C 14, C 15, C 16:	0.1 $\mu$ F ceramic capacitor RM = 5 mm

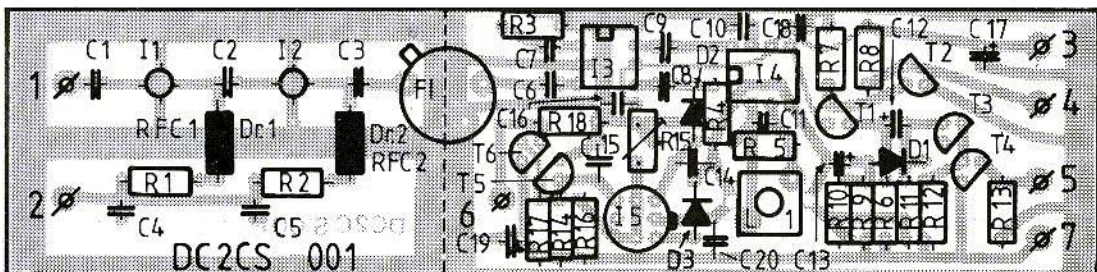

Fig. 3: Components layout of the plated-through PCB DC 2 CS 001



C 13, C 19:	10 $\mu$ F / 6 V electrolytic, standing
C 17:	10 $\mu$ F / 16 V electrolytic, standing
R 1, R 2, R 8, R 13:	390 $\Omega$
R 3:	10 $\Omega$
R 4:	120 $\Omega$
R 5:	180 $\Omega$
R 6, R 12:	1.8 k $\Omega$
R 7, R 10:	1.2 k $\Omega$
R 9, R 11, R 18:	18 k $\Omega$
R 14:	4.7 M $\Omega$
R 16:	100 k $\Omega$
R 15:	10 k $\Omega$ trimmpotentiometer RM = 5 / 2.5 mm
R 17:	180 k $\Omega$
Note:	RM = lead spacing grid

#### 4. ALIGNMENT

As there are hardly any components to be adjusted, the alignment is a simple task. First connect 12 V to pin 2 and check the current which should be about 36 mA. If this is correct the 5 V supply on pin 3 can be connected and the current checked at approximately 90 mA. Finally, if the current drawn from the 12 V supply on pin 7 is about 11 mA there is no major fault on the board and alignment can proceed. Vary R 15 until the voltage on pin 6 starts to drop indicating the most sensitive range of the AGC detector.

For the following adjustments and checks either a signal generator with 480 MHz output or a signal from a converter is required. Tune L 1 to give 2.5 V at pin 4 with an unmodulated signal at 480 MHz or, if using a modulated signal, a symmetrical output of sync tips to white level around 2.5 V. When tuning the quadrature circuit, the input level should be greater than - 50 dBm or 0.7 mV.

The calculated sensitivity level of this board is - 58 dBm (- 27 dBm for the SL 1452, + 14 dB from SL 565, - 17 dB for the filter loss and + 34 dB from the two stage amplifiers I 1, I 2). The

samples built by the author had a measured sensitivity of close to - 70 dBm, this discrepancy being due to the SL 1452 devices used which had actual sensitivity levels of 3 mV instead of the specified worst-case level of 10 mV.

#### 5. TESTRESULTS

IF:	480 MHz
Bandwidth:	27 MHz
Noise bandwidth:	30 MHz
Selectivity:	> 35 dB
Input level:	
maximum	0 dBm (I 2 overloads)
minimum	- 60 dBm (I 4 input too low)
Rectifier range:	approx. 10 dB, adjustable between - 50 and - 20 dBm
AFC output - amplitude non inverted:	50 mV / MHz dependent on Q
Video output - amplitude inverted:	approx. 1 V <sub>pp</sub> for 13.5 MHz deviation dependent on Q
Power consumption:	
+ 12 V:	50 mA
+ 5 V:	90 mA

#### 6. LITERATURE

Avantek:  
INFORMATION MSA 0104 Jan. 1985  
Signal Technology:  
PRELIMINARY INFORMATION SW 504  
Plessey:  
LINEAR INTEGRATED CIRCUIT  
HANDBOOK 1983 (SL 565)  
Plessey:  
SATELLITE CABLE AND TV IC  
HANDBOOK 1985 (SL 1452)





*Carsten Vieland, DJ 4 GC*

## Modifying the FT 225 RD

Although the FT 225 RD has not been produced now for a few years, it was sold in large quantities and represents one of the most frequently used UHF equipments. On account of its modular construction it is very easily serviced and whole modules may be replaced easily.

---

### 1. THE RECEIVER INPUT STAGE (RX RF Unit PB 1748)

---

Some manufacturers of pre-amplifiers maintain that with the help of their particular technology, the grass may be heard to grow. The FT 225 RD, in its original state, would be suitable even for the detection of earthquakes! The receiver noise figure lies uncomfortably close to a two-digit number and at the same time the overload point, blocking and intermodulation characteristics are only in the lower category of the technically feasible. The employment of a MOS-FET as a first mixer, even in those days, did not represent an acceptable solution for equipment design.

This particular module is actually the only technical blackspot in an otherwise carefully and extensively conceived transceiver. In order to round off its whole technical specification, it should be given a new front-end, either proprietary (for example Mutek) or home construc-

ted. Suggestions for high-performance receiver front-ends are frequently published. It must be stressed, however, that the 40 dB gain of the existing module must be preserved in the new version. An overall gain of more than 50 dB, however, would improve the AGC performance of the receiver. In the original condition, the AGC is taken solely to the input pre-amplifier (3 SK 51). The employment of a PIN-diode attenuator before the mixer, together with an additional controlled MOS-FET amplifying stage following the crystal filter, would improve the dynamic range as well as the threshold of the AGC.

For the author's equipment a circuit was developed, with the aid of a computer, which has an intercept point (IP) of + 7 dBm at a noise figure of 1.8 dB (Burdewick MMV 2 HB-PIN with BFQ 29, BFR 34a, and PIN-diode attenuator; BFR 91a with negativ feedback; high-level mixer TAK-1H, matching amplifier using P 8000 FET, 15 kHz crystal filter, 3 N 200 providing a termination for the crystal filter as well as to a further 3 N 200).

The overall gain amounted to 50 dB. Installed into the receiver, however, only an IP of + 4 dBm could be obtained. The noise figure deteriorated to 2.5 dB. This somewhat disappointing result was caused by the oracle-like formulation, and thereby wrongly accepted noise figure, of the purchased pre-amplifier as well as a lossy antenna change-over circuit. There is an existing special coaxial cable taken from the antenna relay to a terminating pin on the circuit board. This cable connection on the board should be disconnected from the circuit.



The original printed circuit board (PB 1746) can also be improved in order to increase the sensitivity. The FT 225 RD is actually able to be used from 144 MHz through 146 MHz to 148 MHz. In order to achieve such a bandwidth the first and middle tuned circuits are tuned with varicaps. The sensitivity can be improved somewhat by replacing the varicaps by capacitors or trimmers (about 10 pF). Within the confines of the amateur band no re-tuning is necessary. The input transistor should be replaced by the markedly higher performance BF 981. A ferrite bead may have to be slipped over the drain lead of the transistor to dampen any oscillation tendencies.

## 2. OSCILLATOR NOISE (Module PLL Unit PB 1748)

The FT 225 RD PLL oscillator is highly linear, stable and has low-noise sidebands. In order to fully utilise a high dynamic range front end,

however, the phase noise must be reduced even further. With reference to some very informative instructions from Leif Aesbrink, SM 5 BSZ (2) two measures were carried out (see fig. 1).

(1) L 02: The core must be screwed-in until the tuning voltage for diode D 01 and D 02 at 146 MHz lies between 0.5 and 1 volt from its maximum value of 6 V. The PLL will then lock more positively over the range 144 MHz to 146 MHz.

(2) The PLL tuning voltage must be filtered to a higher degree with  $C = 47$  nF on Q09 pin 8,  $\mu$ PC 1008 C (MC 4044).

Explanation:

The first modification is carried out in order that a higher Q may be obtained from the tuned circuits by sacrificing two MHz of unwanted tuning range, i. e. from 146 to 148 MHz. The varicaps operate, following the modification, at a higher tuning voltage thereby imparting a higher Q to the tuned circuits and together with the reduced tuning range, further reducing the oscillator phase noise. The improved filtering of the second modification reduces directly the high-frequency noise component on the tuning voltage line.

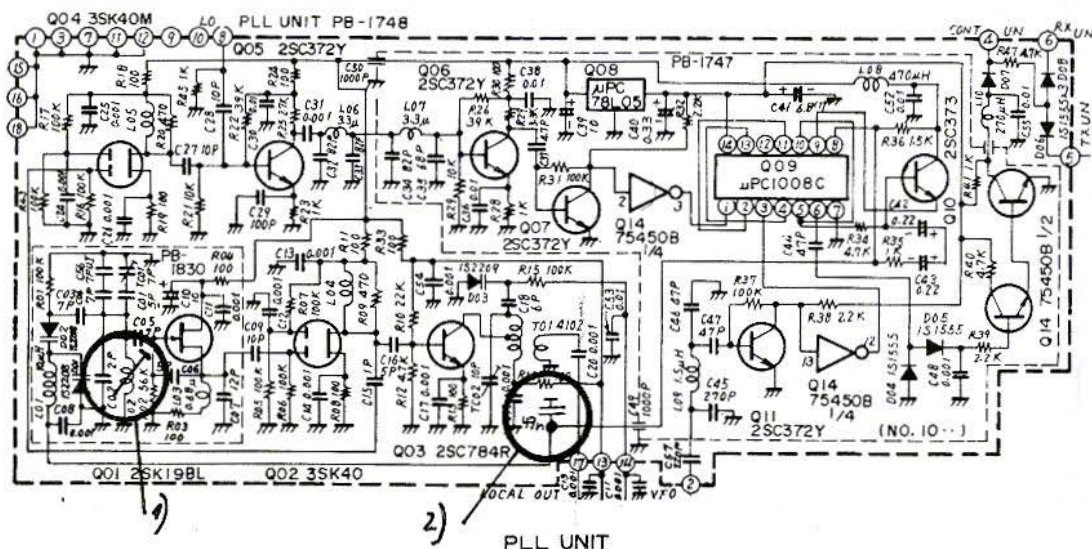

Fig. 1: Two measures for the reduction of oscillator phase noise

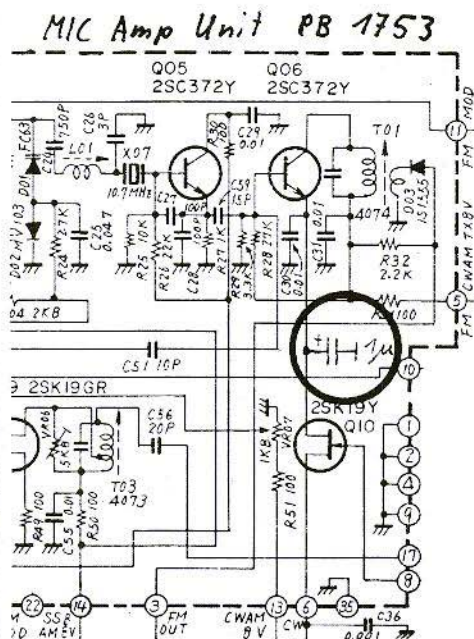
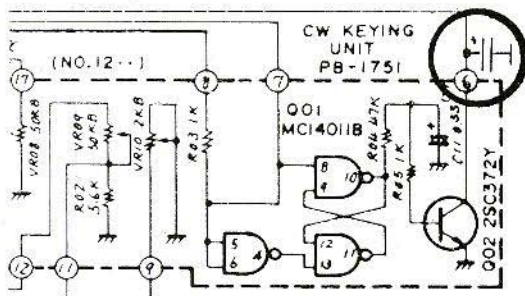

Fig. 2: Rounding off the leading edge of CW impulses

In order to test the efficacy of these modifications the following test may be undertaken.

Switch the FT 225 RD to SSB with MIC-gain control at minimum and the microphone removed.

The antenna output is terminated with a 50  $\Omega$  attenuator (only residual carrier present). The sender is tuned to within 100 kHz of a receiver which possesses good phase noise characteristics (e. g. IC 202). The attenuator must be so dimensioned (about 80 dB) that the transceiver phase noise gives a good indication on the receiver's 'S' meter. By taking before and after modification attenuation values for the same 'S' reading an improvement factor may be determined. Both measures taken together should improve both the transmit and receive phase noise, at 100 kHz removed from the carrier,



by at least 10 dB. This rises as the frequency separation increases between the transmit carrier and the receiver test frequency.

### 3. KEY CLICKS

The telegraphy signal of the FT 225 RD is accompanied by relatively large key clicks. These may be seen by using a high-frequency demodulator probe into a DC oscilloscope. The signal waveform decays with a clean exponential function but the rise is accompanied by a large overshwing which must be corrected in order to reduce the key clicks.

In the author's equipment an additional capacitor of 1  $\mu$ F from the emitter of Q 06 (Module MIC. AMP. UNIT PB 1753) to earth was sufficient to remove the transient. The capacitor delays slightly, but sufficiently, the switch-on of amplifying stage Q 06 by the switch transistor Q 10. See fig. 2.

As the timing of the switching sequence is subject to small manufacturing variations, an alternative modification would be to alter the emitter or collector of Q 02 (CW-KEYING UNIT PB 1751). By adding capacitors or increasing their value, the shape of the keying pulse may be suitably rounded. In order to avoid a deformation of the

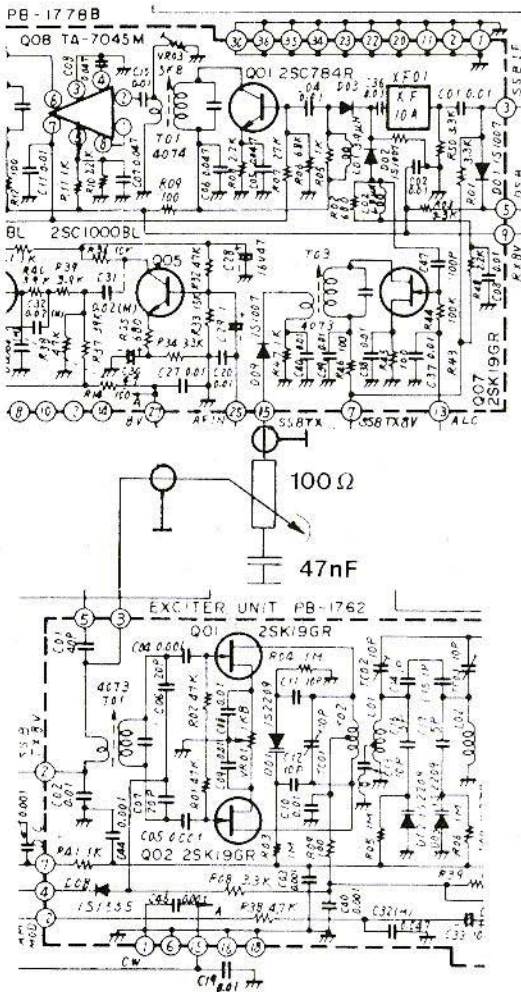

Fig. 3:  
Continuously variable power adjustment on SSB

pulse shape at high keying speeds the additional capacity should only be as large as necessary (e. g.  $10 \mu\text{F}$  at Q02 collector). The signal should be monitored on an oscilloscope in order to check the keying waveform after circuit change.

#### 4. POWER CONTROL ON SSB

The coaxial connection from SSB IF UNIT PB 1778 B to the exciter PB 1762 is broken and taken to a  $100 \Omega$  potentiometer. The cable carries a DC voltage to a switch and this should remain. The object is to control the transmit intermediate frequency level at 10.7 MHz by the potentiometer which must be mounted on the transceiver's front panel. The SSB output may be thereby continuously varied from 0 to 25 W. By means of this interesting modification (fig. 3) the detrimental effect of the ALC on the dynamic range is reduced. The reference for the characteristics and the operation of this adjustment to linear amplifiers was obtained from (4).

#### 5. REFERENCES

- (1) DUBUS:  
VHF UHF SHF-Technik Sammelband 2  
Vier Beiträge zur Modification des FT 221
- (2) Asbrink L., SM 5 BSZ:  
Dynamic Range of 2 m Receivers  
Part 1 and 2  
VHF COMMUNICATIONS, Vol. 14,  
Ed. 1 / 1982, Pages 49 - 58  
Part 3, Ed. 2 / 1982, Pages 106 - 109  
Part 4, Ed. 3 / 1982, Pages 158 - 162
- (3) Martin, M., DJ 7 VY  
A Modern Receive Converter for 2 m  
Receivers Having a Large Dynamic Range  
and Low Intermodulation Distortions  
VHF COMMUNICATIONS, Vol. 10,  
Ed. 4 / 1978, Pages 218 - 229
- (4) Vieland, C., DJ 4 GC:  
Power Amplifiers - How they are operated  
VHF COMMUNICATIONS, Vol. 17,  
Ed. 4 / 1985, Pages 208 - 212



*Jochen Jirmann, DB 1 NV and Friedrich Krug, DJ 3 RV*

# Microcomputer System

## Part 2: The CPU and Floppy Disc Controller

**With the following introduction of two cards, a computer with a 64 kByte RAM memory and two serial interfaces, a parallel interface and a floppy disc interface for four drive mechanisms will have been realized which operates using the CP/M 2.2 system. Together with the power supply from the last article (3) and the forthcoming graphic terminal card, a versatile computer in its basic form will have been produced which possesses an almost limitless capacity for expansion.**

---

### 1. CONCEPT

---

If one, as do the authors, has a lot to do with sensitive, analogue, high-frequency circuits, there is a temptation to regard digital circuits mostly as broad spectrum noise sources. Despite increasingly sharper anti-interference regulations, the situation has steadily deteriorated owing to the increasing use of digital circuits in the household

and hobby areas which are often included by the manufacturer in the apparatus, not to improve its function, but rather to improve its sales appeal.

This was the main consideration behind the development of this computer project. The wish to learn and understand the workings of relatively complex microprocessors was also a considerable motivation. At the same time, knowledge about the functional process the computer uses could be gained, which, through choice of circuitry and constructional technique, would help to avoid the many disadvantages of some commercial computers.

The following points were therefore always kept in mind during the design of this project:

- clearly arranged with readily obtainable components and a surefire reproducibility.
- a modular construction based upon the ECB bus with clearly defined access planes and standard interfaces which allow expansion and additions to the system.
- a design which incorporates anti-interference measures and the modules housed in a metal box.

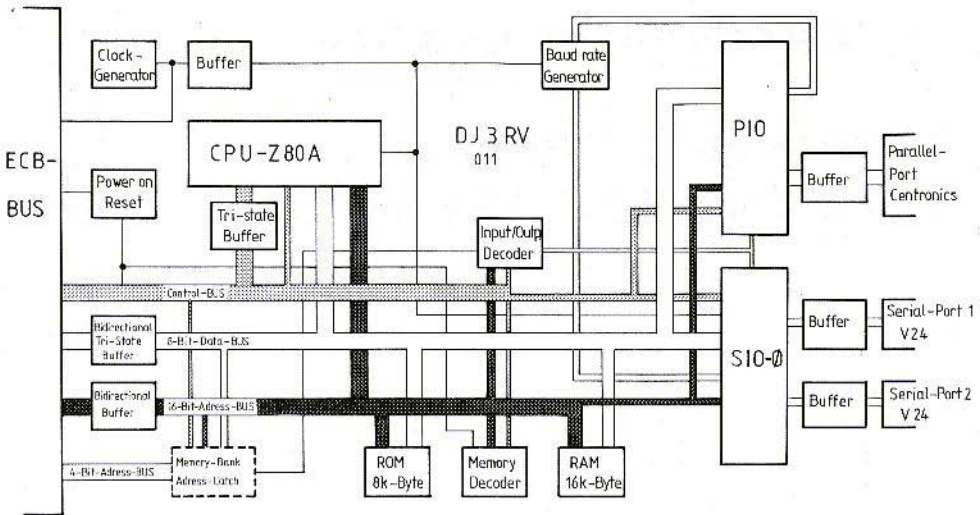

Fig. 1: Block diagram of the CPU card DJ 3 RV 011

These points would appeal to anyone with an interest in microprocessor techniques and their applications and who would like to be acquainted with them through practical experience. They would then be in possession of a versatile CP / M computer, the function and circuitry of which they are well familiar.

By means of the supplementary units, already mentioned in (1), the system may be expanded at will.

## 2. THE CPU CARD

From the block diagram of the CPU card DJ 3 RV 011 in fig. 1, it will be seen that the circuit already possesses the important functional attributes of a computer.

The Z 80 A microprocessor forms the main component (the CPU) on the card and is driven with a sync. pulse train of 4 MHz. The synchronization may be effected, as desired, either by the internal

clock generator or externally, for example, by the sync. generator described in (2).

A fixed value read-only memory (ROM) of 8 kByte capacity is provided on the card for the monitor programme and a 16 kByte read / write random access memory (RAM) which is accessed from the CPU via the memory decoder. The RAM is NiCd battery buffered providing security against a loss of store content should the computer lose its main supply for any reason. The battery capacity is sufficient to retain the store memory for more than a year without a re-charge.

Upon switching the power on, the "power on reset" facility sets the circuit to a definite start position with the ROM being put on the start address of the CPU by means of the monitor programme. In this manner the CPU receives the functional sequence as far as the software is concerned.

This monitor programme consists of several independent parts which will be described in detail in the special booklet on the project. The most important is the initialization routine which sets the function of the individual modules and their attendant input / output programmes in order that the interface modules may be addressed.

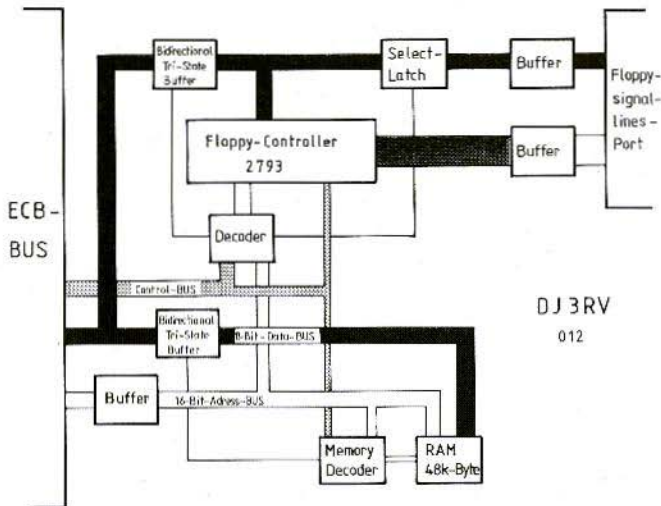

Fig. 2:  
Block diagram of the  
floppy disc controller card  
DJ 3 RV 012

The PIO module (parallel input output) feeds, via a driver, the 8 bit parallel interface (Centronics) for a printer or plotter and also adjusts the division factor in the baud rate generator for the baud rate of the serial ports.

The serial input output (SIO) module serves two serial V 24 interfaces. The first interface is for the terminal or keyboard and monitor and the other is provided with a programmable baud rate for optional use. It could, for example, be used to connect an RTTY modem or for computer to computer coupling.

The wires to the ECB bus are isolated by bidirectional buffers which make possible direct memory access (DMA) working. The circuit is so designed that only the CPU is switched off and the various functions of the card may be addressed by another CPU via the ECB bus.

As the CPU can directly address only one memory of 64 kByte, provision has been made for the addition of 4 lines to the existing 16 in order to extend the memory. This enables a maximum of 1 MByte, in blocks of 64 kByte, to be addressed. This renders the card suitable for the CP / M Plus system.

### 3. FLOPPY DISC CONTROLLER CARD

The block diagram of the floppy disc controller card DJ 3 RV 012 in fig. 2 shows that on this card the other read / write memory of 48 kByte is available. This may be addressed directly from the CPU and is also battery buffered. With these two cards, a working system memory is available which can be addressed directly by the CPU.

The floppy disc controller operates the disc drive mechanisms as its name suggests. The interface is pin-compatible with most mechanisms and up to four floppy disc drives may be connected simultaneously. The CPU addresses the floppy disc controller as an IO port and the necessary software is present in the monitor programme. We have adopted here the read / write routine and addressing system of the firm Feltron in order that CP / M systems from them may be read immediately.

The data and address wires to the ECB bus are taken via buffers in order that the bus is sufficiently lightly loaded.



#### 4. REFERENCES

- 1) Jirmann, J.; Krug, F.:  
A Microcomputer System for Radio Amateurs  
VHF COMMUNICATIONS Vol. 17,  
Ed. 4 / 1985, Pages 252 – 254
- 2) Krug, F.:  
Microcomputer Clock-Pulse Generator  
linked to DCF 77  
Off-Air Time-Standard  
VHF COMMUNICATIONS Vol. 18,  
Ed. 2 / 1986, Pages 121 – 125
- 3) Jirmann, J.; Krug, F.:  
Microcomputer System  
Part 1: Switched-Mode Power Supply  
(S.M.P.S.)  
VHF COMMUNICATIONS Vol. 18,  
Ed. 2 / 1986, Pages 108 – 120

### Which Volumes of VHF COMMUNICATIONS are missing from your library?

As you know, the publishers continue to reprint back copies of VHF COMMUNICATIONS. Since they are full technical articles and little news or advertising, they contain a great deal of non-renewable information that is just as valid today. Many of our readers will also have lent out copies of VHF COMMUNICATIONS and never received them back. All editions available can be obtained from your representative or from the publishers.

<b>Subscription to VHF COMMUNICATIONS 1985/1986</b> .....	<b>each DM 24.00</b>
VHF COMMUNICATIONS – Volume 1983/1984 .....	each DM 22.00
VHF COMMUNICATIONS – Volume 1981/1982 .....	each DM 20.00
VHF COMMUNICATIONS – Volume 1979/1980 .....	each DM 18.00
VHF COMMUNICATIONS – Volume 1976, 1977, and 1978 .....	each DM 16.00
VHF COMMUNICATIONS – Volume 1975 .....	DM 14.00
VHF COMMUNICATIONS - Individual copies 1985/1986 .....	each DM 7.00
VHF COMMUNICATIONS - Individual copies 1983/1984 .....	each DM 6.50
VHF COMMUNICATIONS - Individual copies 1981/1982 .....	each DM 5.50
VHF COMMUNICATIONS – Individual copies 1979/1980 .....	each DM 4.50
VHF COMMUNICATIONS – Individual copies 1975, 1976, 1977, 1978 .....	DM 4.00
Individual copies out of order, incomplete volumes, as long as stock lasts:	
1/1970, 2/1970, 2/1971, 1/1972, 2/1972, 4/1972 .....	each DM 3.00
2/1973, 4/1973, 1/1974, 2/1974, 3/1974 .....	each DM 3.00
<b>VHF COMMUNICATIONS – Discount price for any 3 volumes including 1 binder:</b>	
VHF COMMUNICATIONS – Volumes 1975 – 1977 .....	DM 47.00
VHF COMMUNICATIONS – Volumes 1976 – 1978 .....	DM 48.00
VHF COMMUNICATIONS – Volumes 1977 – 1979 .....	DM 50.00
VHF COMMUNICATIONS – Volumes 1978 – 1980 .....	DM 52.00
VHF COMMUNICATIONS – Volumes 1979 – 1981 .....	DM 56.00
VHF COMMUNICATIONS – Volumes 1980 – 1982 .....	DM 59.00
VHF COMMUNICATIONS – Volumes 1981 – 1983 .....	DM 62.00
VHF COMMUNICATIONS – Volumes 1982 – 1984 .....	DM 68.00
VHF COMMUNICATIONS – Volumes 1983 – 1985 .....	DM 72.00
Plastic binder for 3 volumes .....	DM 9.00

**All prices including surface mail.**



**UKWberichte** Terry D. Bittan · Jahnstr. 14 · Postfach 80 · D-8523 Baiersdorf

Tel. West Germany 9133 47-0. For Representatives see cover page 2





Matjaž Vidmar, YU 3 UMV

## Microstrip Transverters for 23 and 13 cm Part 2

### 7. OSCILLATOR MODULES

Two different oscillator modules were developed, primarily in order to utilize various types of crystals. One of them (fig. 13) works with third overtone crystals in the range 32 to 45 MHz and the other unit was designed for fifth overtone crystals working at 90 or 96 MHz (fig. 14). Both types of modules supply a power output of 10 mW at 576 MHz, 540 MHz or 544 MHz.

The oscillator injection frequency should, in any case, always be chosen somewhat lower. If the start of the narrow-band operating range of the microwave band when translated, overlaps the start of the 144 MHz amateur band, then interference from high-power, two-meter stations is the likely outcome since most of the two-meter TRs available nowadays, and used as a base equipment, are not sufficiently screened. On top of this, most modern PLL synthesizer transceivers do not allow themselves to be tuned below 144.0. If the transverter crystal should drift in the correct direction, a portion of the microwave band would be

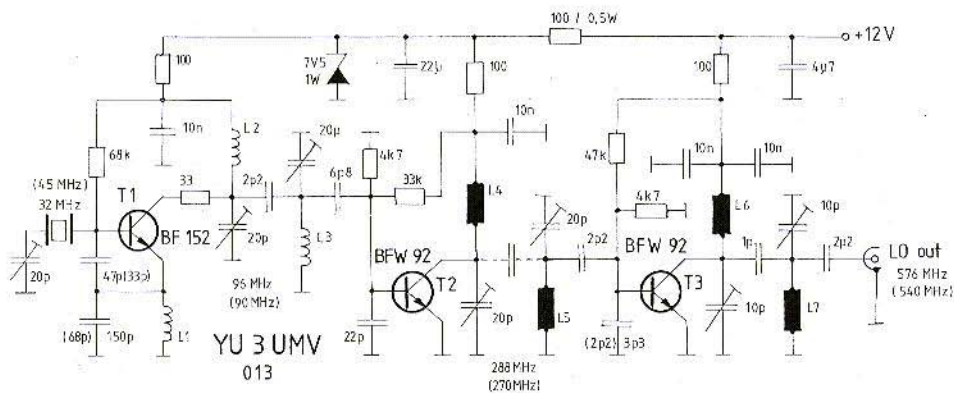

Fig. 13: Local oscillator module for 32 MHz crystals (45 MHz values in brackets)

- L 1 to L 3: self supporting 0.7 mm CuL wire, 5 mm int. dia.
- L 1: 10 (11) turns, L 2: 6 (7) turns, L 3: 6 turns
- The inductors L 4 to L 7 etched.

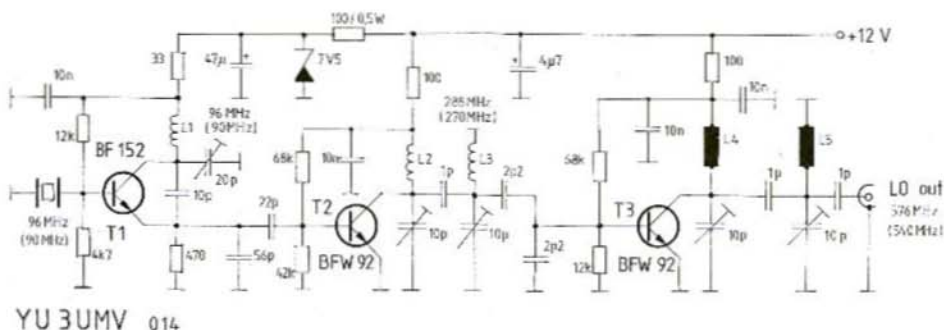

Fig. 14: Local oscillator module for 96 MHz crystals (90 MHz values in brackets).

L 1 to L 3: self supporting 0.7 mm CuL wire, 5 mm int. dia.

L 1: 6 turns, L 2, L 3: 2 turns

The inductors L 4 and L 5 are etched.

unattainable. Therefore, the first 400 kHz of the microwave band, the part normally used for narrow-band activity, should be translated to the 144.600 to 145.000 MHz range which is mainly free from hectic contest traffic.

Using third overtone crystals, a reliable oscillator can be fairly designed. The one shown in fig. 13 should oscillate without any need for special adjustment. The inductance L 1 in the oscillator T 1 emitter prevents the crystal from oscillating at its natural frequency. The oscillator has been designed for parallel-resonance specified crystals in order that in both versions a higher value for the crystal trimmer capacitor will be required.

The collector of the crystal oscillator transistor should be at ground potential as far as the crystal frequency is concerned. That is conveniently arranged by including an harmonically tuned LC circuit in the collector which results in a fourth harmonic selection and thereby saving a multiplier stage.

Both the following stages are conventional frequency multipliers. The inductors L 4, L 5, L 6 and L 7 are all printed on the circuit board. The inductive coupling between L 4 and L 5 is sufficiently close so as to obviate the need for a cou-

pling capacitor. The supply voltage, both for the oscillator and for the following stage is, of course, highly stabilized. Crystals in the range about 90 MHz oscillate normally at the fifth overtone. Suitable oscillators are more critical especially when the crystal must be pulled in order to provide a specific fine-tuning range. The oscillator circuit shown in fig. 14 was designed for series-resonance crystals. In any case, it is necessary that the trimmer for L 1 be very carefully tuned in order that a stable working condition for the oscillator at the desired frequency is achieved.

Also this oscillator is followed by two frequency multiplier stages but the difference to the formerly described unit is that the both inductors for 288 MHz, L 2 and L 3, are air-wound self-supporting coils instead of being etched from the PCB. Also, in this unit, the oscillator supply voltage is extra stabilized with a 7.5 V zener diode.

As already mentioned when the block diagrams were described, a diode switch (fig. 15) is employed to effect the switching of the two oscillator units to the transmit and receive converters.

It should be mentioned that no DC blocking capacitors have been provided in the signal lead as

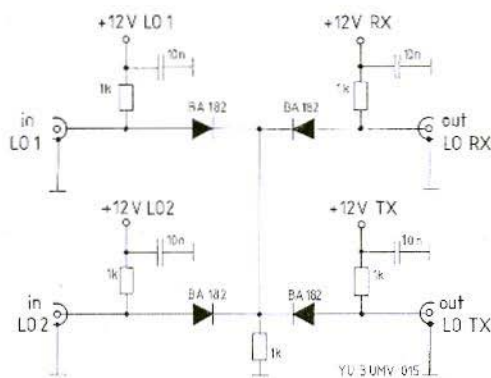

**Fig. 15:**  
Oscillator module  
electronic switch



**Fig. 16:**  
A simple method of splitting the  
oscillator signal to feed both transmit  
and receive mixers.

they already exist in the outputs of the oscillator modules and in the inputs of the transmit and receive converters.

If only one oscillator module is to be employed, the simpler circuit of **fig. 16** should be used. In order to achieve a usable power division, a certain experimentation with the value of capacitors and cable lengths may be necessary.

## 8. VOX MODULE

The circuit diagram for the voice operated switching (VOX) is shown in **fig. 17**. The largest proportion of the base station's output power is dissipated in an attenuator consisting of several resistors. The voltage across the attenuator is rectified by an OA 95, or similar germanium diode,

for control purposes. The rectified voltage switches on T 2 which discharges the  $4.7 \mu\text{F}$  capacitor through a  $1 \text{ k}\Omega$  resistor in a relatively short period of time. The charging of this capacitor is much slower owing to the presence of the  $150 \text{ k}\Omega$  resistor. These two resistors determine the time constants of the VOX circuitry: a quick switch-on time for the transmitter and a delayed return to the receive condition in order to bridge natural pauses in SSB speech.

The voltage on the aforementioned  $4.7 \mu\text{F}$  capacitor controls a 4049 UB (1 1) CMOS inverter DC amplifier. This amplifier has a built-in hysteresis and controls both PNP supply switches, T 3 and T 4. The PNP switches were chosen because of the low voltage drop across them as opposed to that of the normal employed switching transistors. Of course, the working  $+12 \text{ VRX}$  and  $+12 \text{ VTX}$  supply lines must not be grounded inadvertently, otherwise the switching transistors will be destroyed.

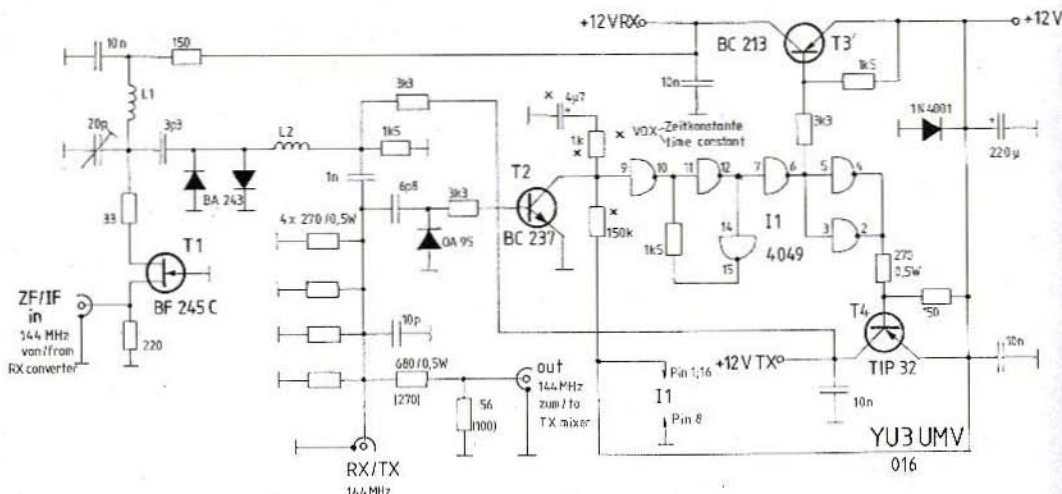

Fig. 17: The VOX module (values in brackets for the 2304 / 2320 MHz transverter)

- L 1, L 2: self supporting 0.7 mm CuL wire, 5 mm int. dia.  
L 1: 4 turns, L 2: 6 turns.

The VOX module also contains an attenuator which reduces the base station's power in order that it may be applied to the send converter mixer. It should be observed that the 13 cm transmit mixer requires a higher 2 m driving signal power than the 23 cm mixer necessitating the alteration of a few resistances. The values for 13 cm working are given in brackets (fig. 17). The attenuator is so dimensioned, that 1 W of transmit power at 144 MHz drives the transverter to full power output and up to 3 W is dissipated in the 4 x 270  $\Omega$ /0.5 W attenuator.

As the VOX switching circuitry is not able to forecast when the 2 m transceiver will be switched to transmit, a protection circuit, in the form of a power limiter, is necessary in order to protect the receive mixer from burn-out during the initial switch from receive to transmit. The function of this limiter is made more efficacious by the subsequent provision of a DC bias to the two BA 243 diodes.

The IF amplifier using T 1 has the task of compensating for the loss of power, consequent on con-

version and the protection measures to the final output power.

For an operational control, two LEDs with suitable dropping resistors can be wired between the + 12 VTX and + 12 VRX supply lines and earth.

## 9. CONSTRUCTION

As mentioned in the introduction, all microwave circuits of both transverters using microstrip techniques are realized using 1.6 mm thick epoxy-glass PCB material designated FR 4. Various circuit board patterns and their related component placing diagrams are shown in figures 19 through 27 in actual size. The top side only is shown, of course, as the underside consists of a film of unetched copper. It should be observed that there are two different printed circuit boards for the PIN diode antenna change-over switches,

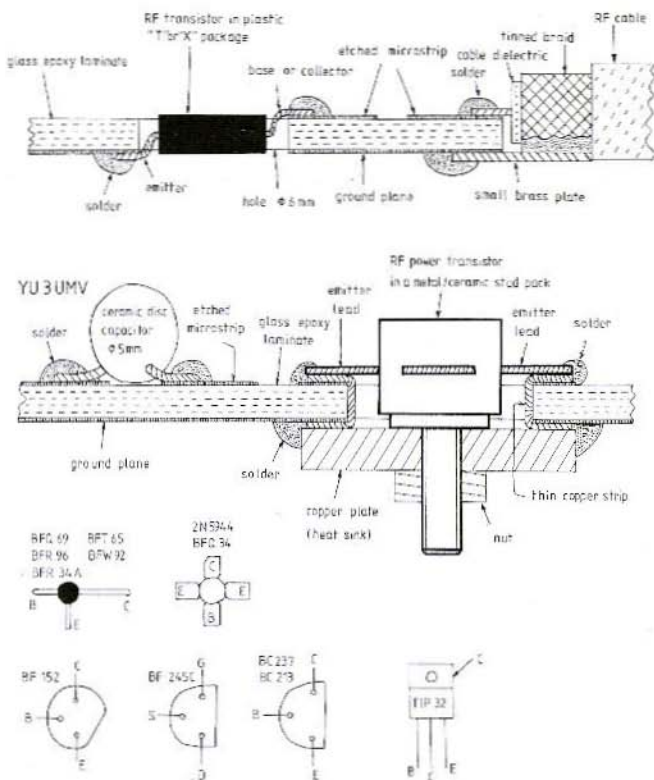

**Fig. 18:**  
Mounting instructions for  
various components

one for 23 cm and the other for the 13 cm band, but the circuit diagrams are identical.

The component layout plans plus diagrams do not, of course, give sufficient information in order that a working replica may be produced and this is normally the case when working at microwave frequencies. Therefore the diagrams of **fig. 18** are given to indicate how various components are physically located upon the board. The plastic packaged transistors are sunk into 6 mm dia holes in the PCB which have been bored at the marked spots. It should be noted that all transistor connections should be as short as possible — especially the emitter. The emitter lead inductance is responsible for most of the transistor's power loss at microwaves.

The power transistors in the metal / ceramic packaging are let into 10 mm diameter holes drilled in the board together with the mounting studs. Prior to this, a strip of sheet copper having the same width as the emitter strip, is soldered around the hole which acts as a very low inductance contact between the two PCB faces. Also a 1 mm copper piece, at least 15 mm  $\times$  25 mm, is soldered over the PCB hole with a concentric boring of a suitable diameter to just accept the transistor stud. (**fig. 18**). This serves as the transistor heat-sink. The collector is then identified with a spot of paint put on the ceramic hub and the connection strips cut back to a suitable length. The transistor is then bolted on to its heat-sink complete with a spring washer. The other transistor strip connections can then be soldered onto the PCB.

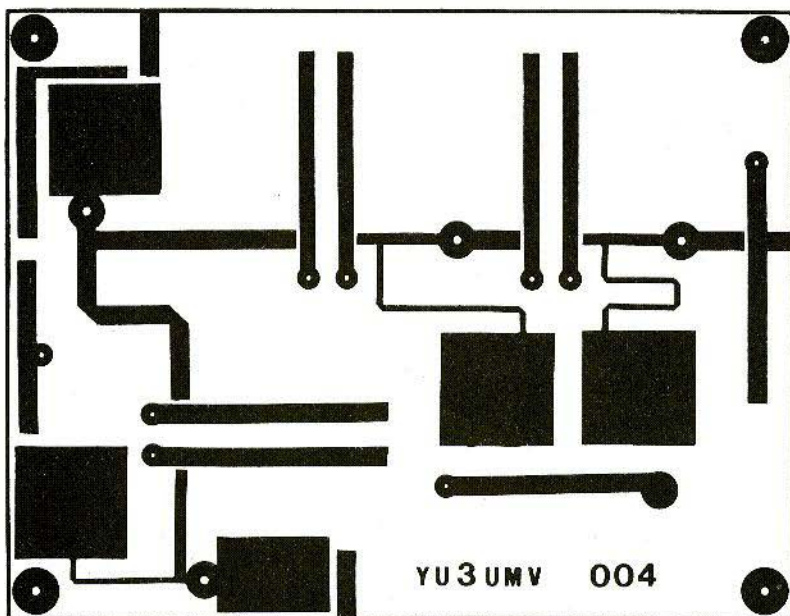
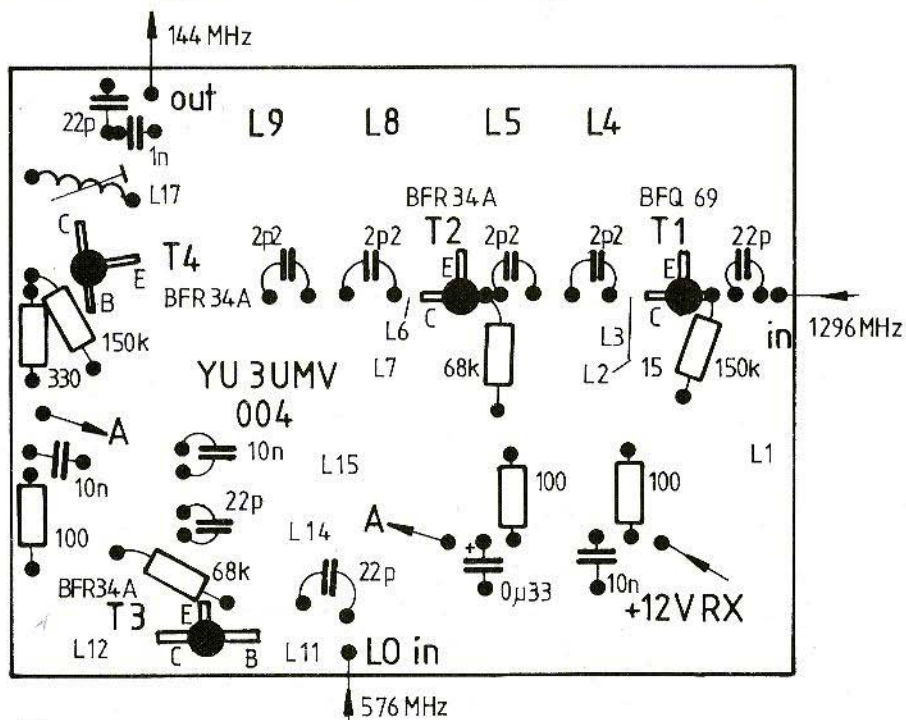

Fig. 19:  
PCB YU 3 UMV  
004 for 1296 MHz  
receive converter



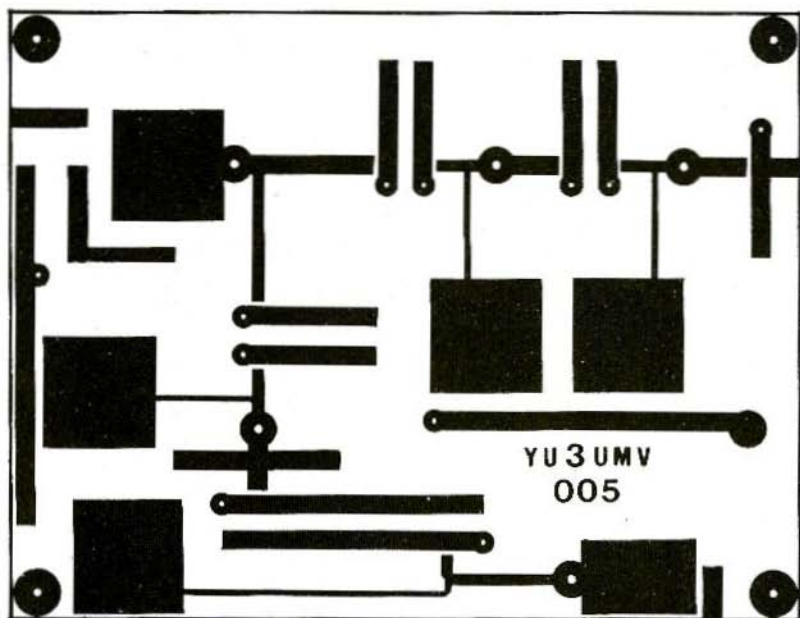
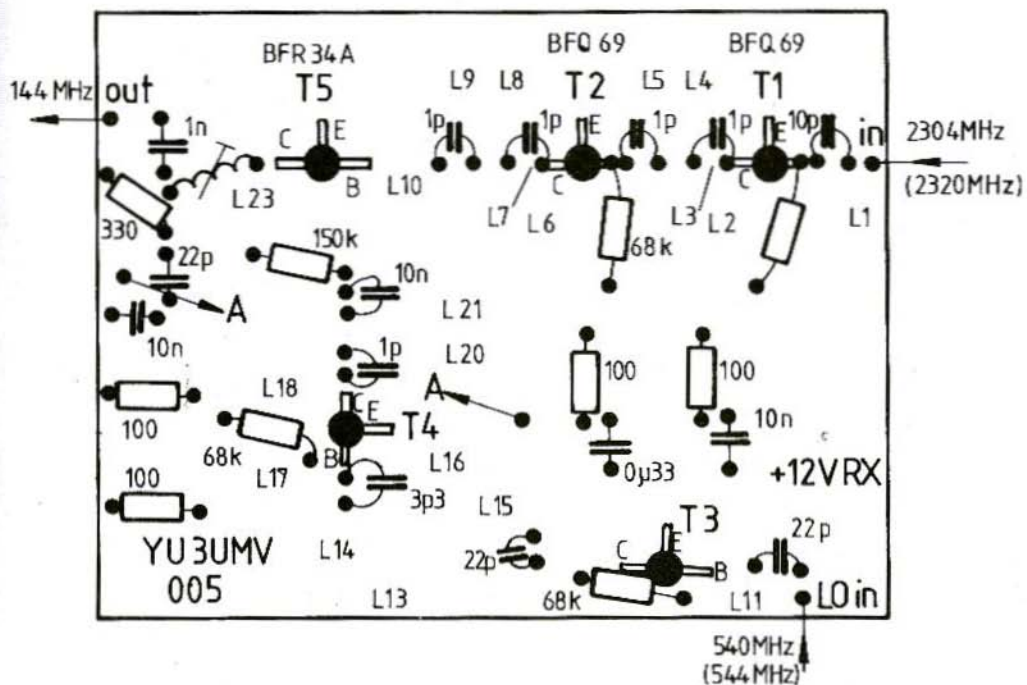

Fig. 20:  
PCB YU 3 UMV  
005 for 2304 / 2320  
MHz receive  
converter



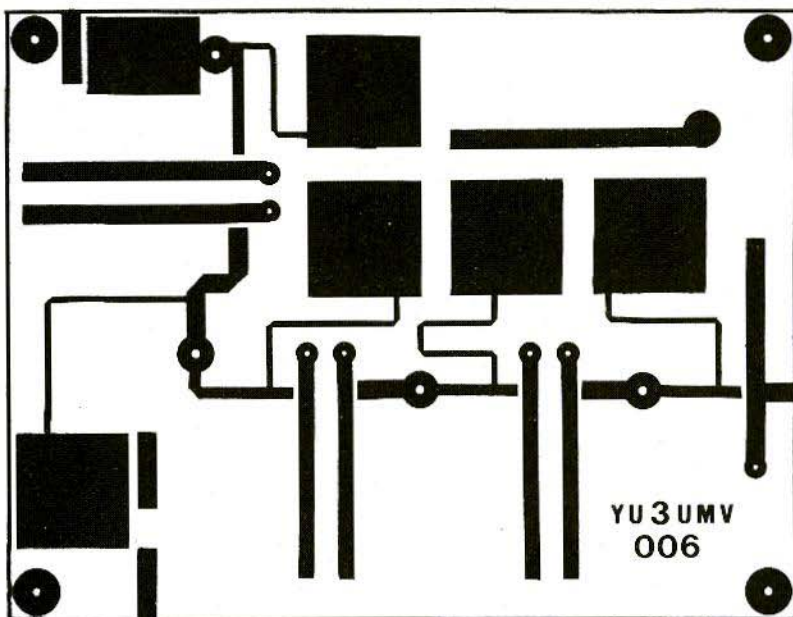
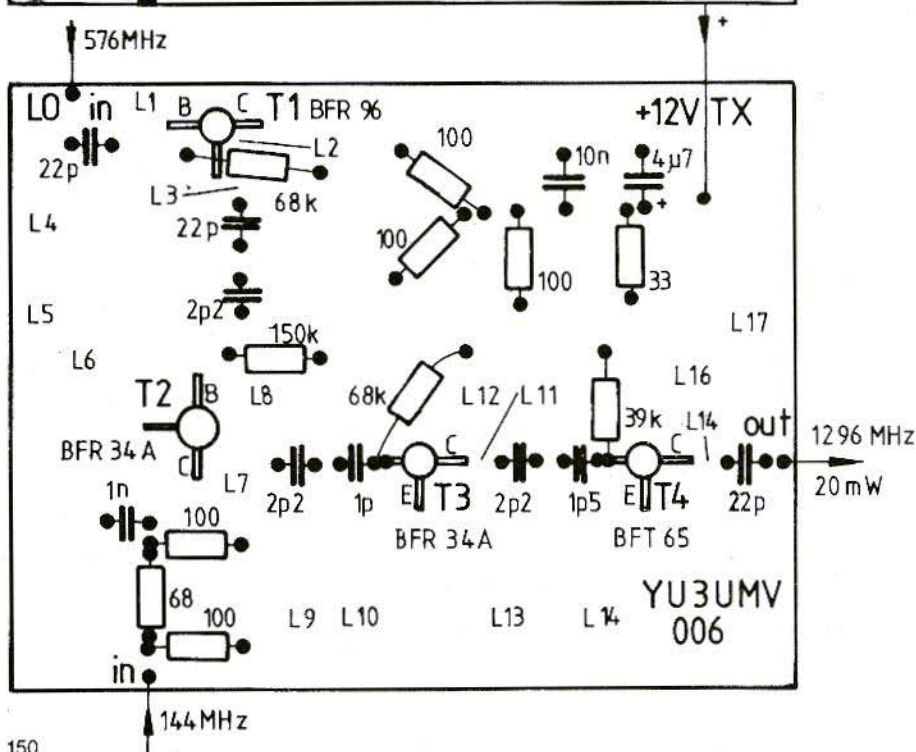

Fig. 21:  
PCB YU 3 UMV  
006 for 1296 / 1270  
MHz transmit  
converter





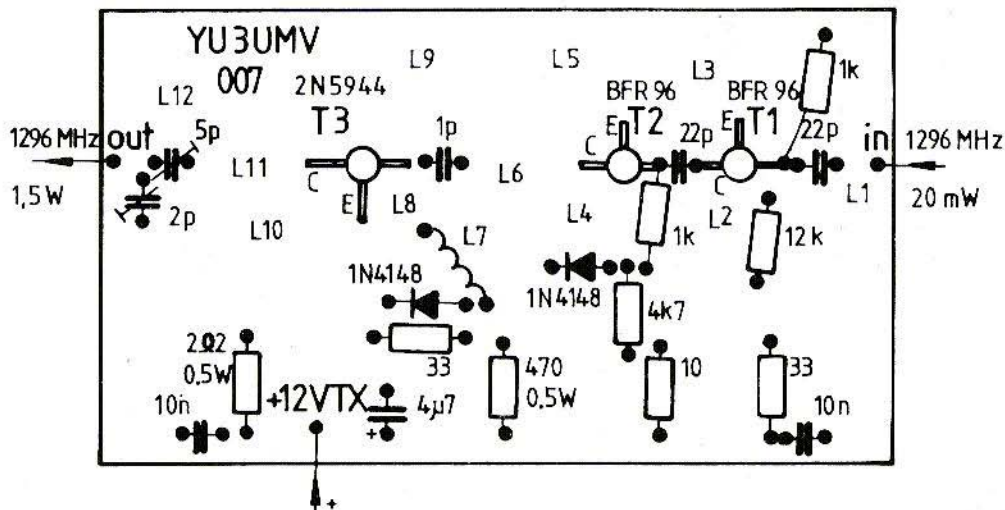
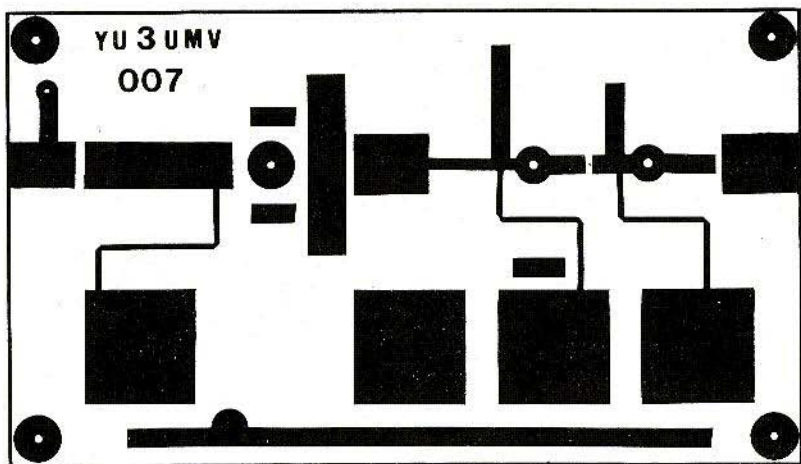

Fig. 22: PCB YU 3 UMV 007 for 1296 / 1270 MHz transmit amplifier

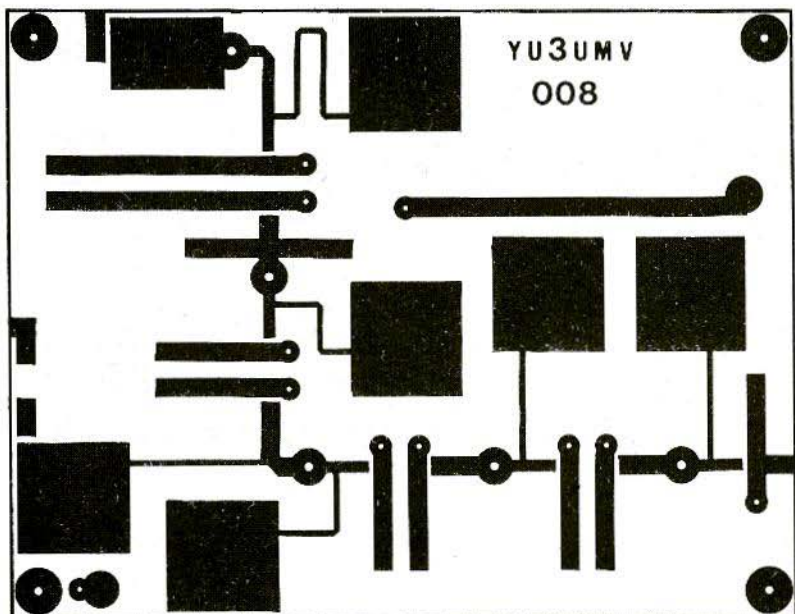
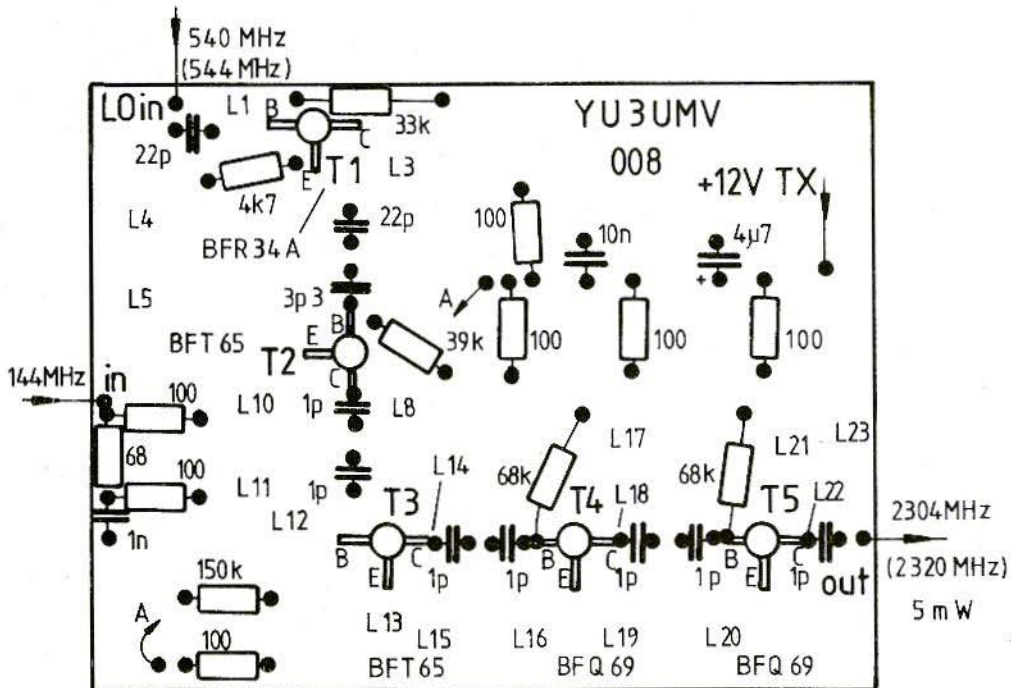

Fig. 23:  
PCB YU 3 UMV  
008 for 2304 / 2320  
MHz transmit  
converter



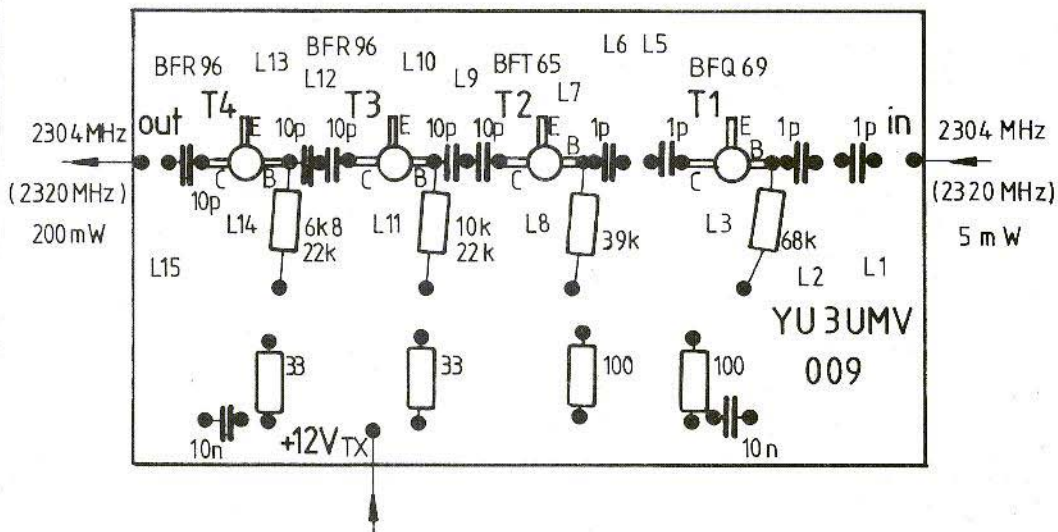
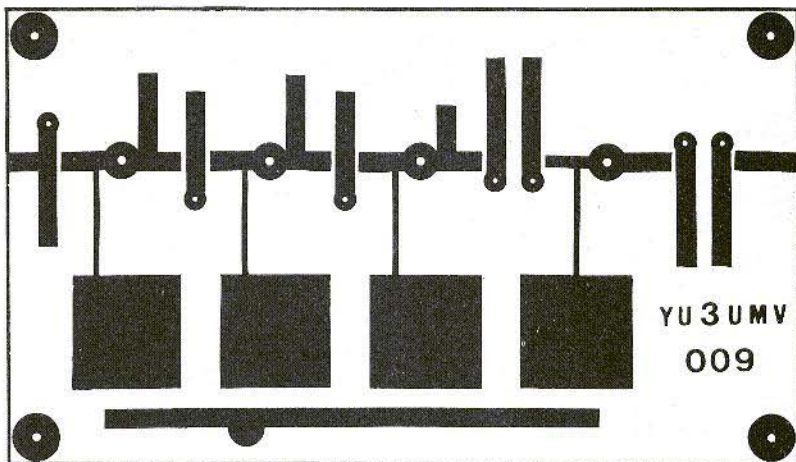

Fig. 24: PCB YU 3 UMV 009 for selective 2304 / 2320 MHz transmit amplifier

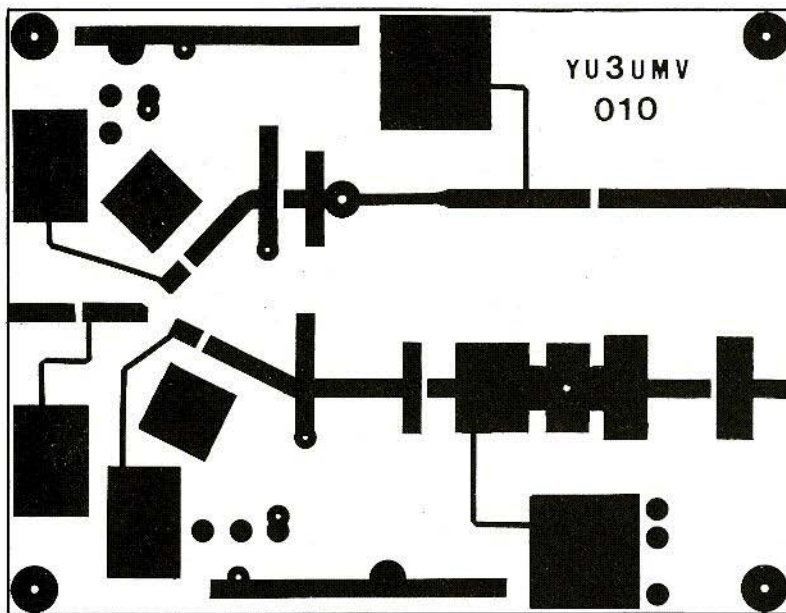
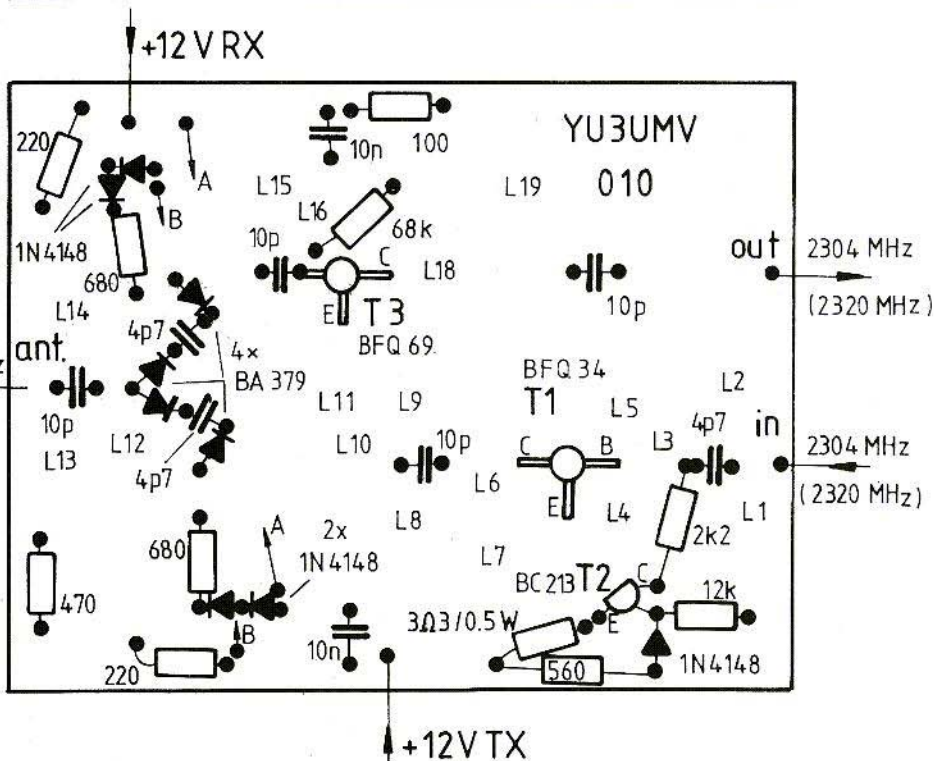

Fig. 25:  
PCB YU 3 U MV  
010 for transmit  
amplifier, antenna  
switch and  
receive pream-  
plifier for  
2304 / 2320 MHz



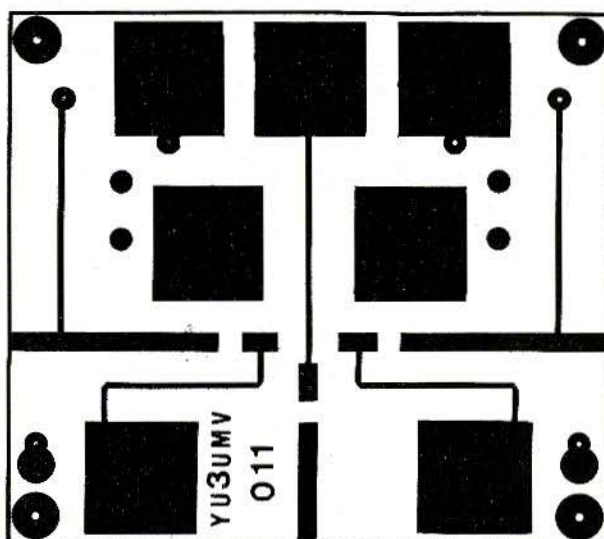
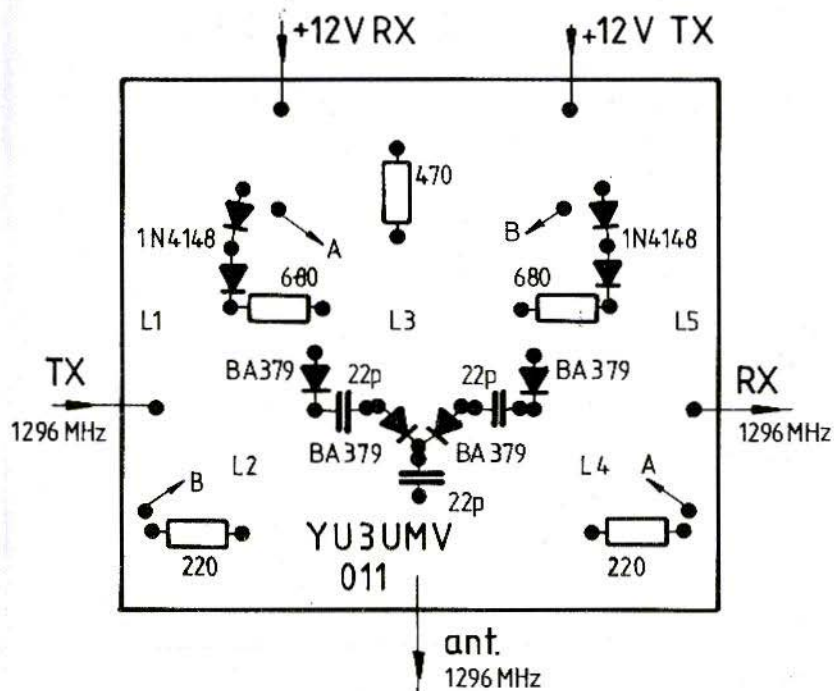

Fig. 26:  
PCB YU 3 UMV 011 for 1296 MHz  
antenna switch



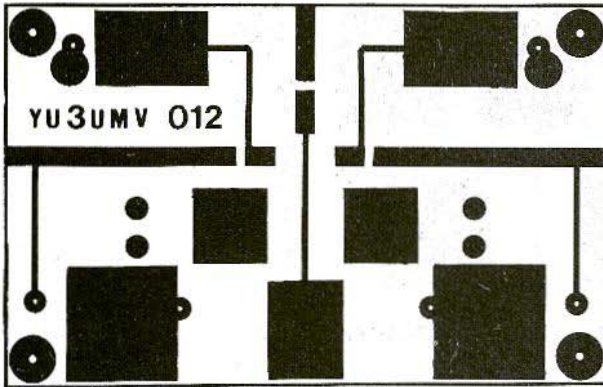
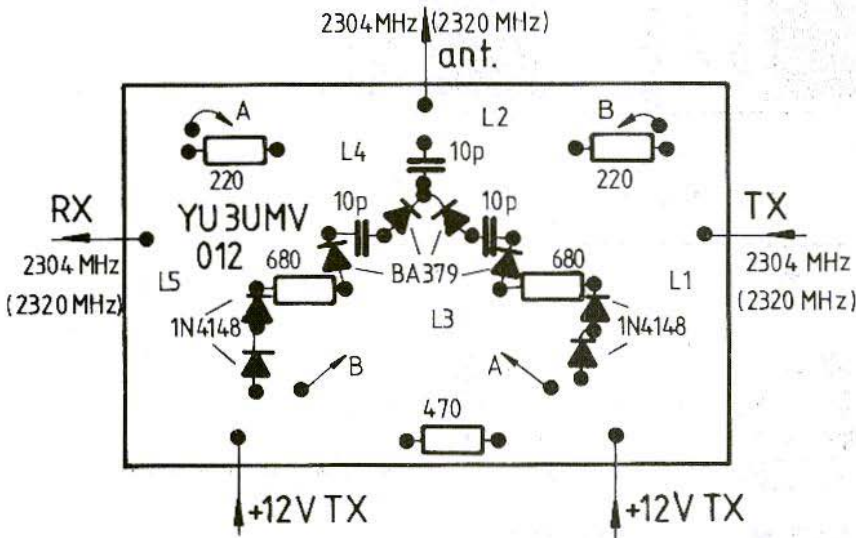

Fig. 27:  
PCB YU 3 UMV 012 for  
2304 / 2320 MHz antenna  
switch



The ceramic capacitors must be soldered in with the very shortest connections possible as indicated in **fig. 18**. The leads are, in fact, snipped off so that they protrude only 1 mm from the body of the capacitor and they are then completely covered in solder to effect the connection. A perfectly built transverter should show no trace of SHF capacitor leads.

All low value disc ceramic capacitors are of 3 mm to 5 mm diameter with the exception of the 1 pF capacitors which are pearl types. The higher

value ceramics are multilayer types but are also of small format.

The decoupling for the supply voltage is accomplished by ceramic and tantalum pearl capacitors, one leg of which is passed through a 1 mm drilling in the PCB and soldered to the earth plane. Their position is not so critical and their drillings in the layout plan have not been indicated.

Resistors play no part in the microwave portion of the circuit, and where they exist their installation is

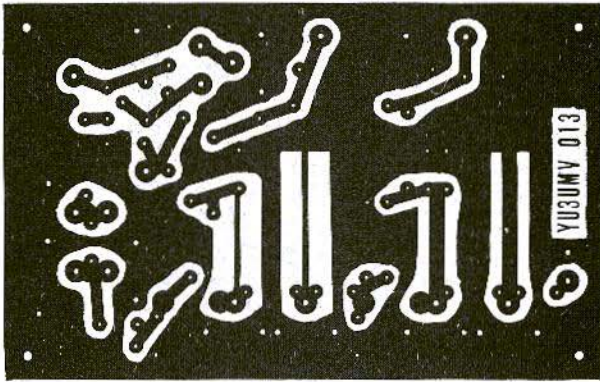
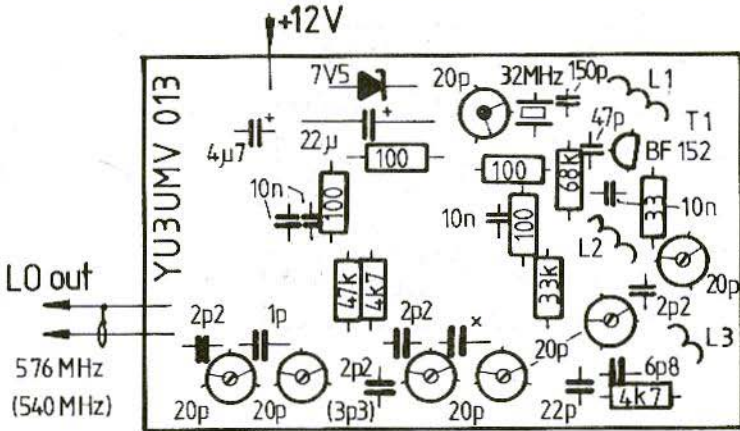

Fig. 28:  
PCB YU 3 UMV 013 for  
oscillator module using  
32 (45) MHz crystals



T2 und T3 auf Leiterbahnseite

uncritical. The capacitance to earth of connecting leads has, however, to be considered and their length must be minimized to reduce self inductance.

Now comes a most important consideration, the  $\lambda / 4$  microstrip resonator ground connections. These must be carried out exactly as shown in the prototypes, otherwise not only the resonant frequencies will be off but also the couplings to other active circuit elements will be too.

Always at the indicated spot, a 1.5 mm hole should be drilled. A short piece of 1 mm silvered copper wire is inserted and soldered to both planes. It should be borne in mind that this wire is

located exactly in a current anti-node and its parasitic inductance has a marked effect upon the characteristics of the resonator.

The various modules are interconnected by means of short lengths of thin PTFE (teflon) coaxial cable (RG-188). Normal polyethylene coaxial cable (RG-174 / U) can be employed but it is more difficult to work with as the thin dielectric melts very easily with the application of heat. In any case, it is of the utmost importance that the cable ends are terminated at the microstrip circuit exactly as shown in **fig. 18**. Most problems of parasitic resonant effects are caused by inductances formed by the indirect nature of the cable ground

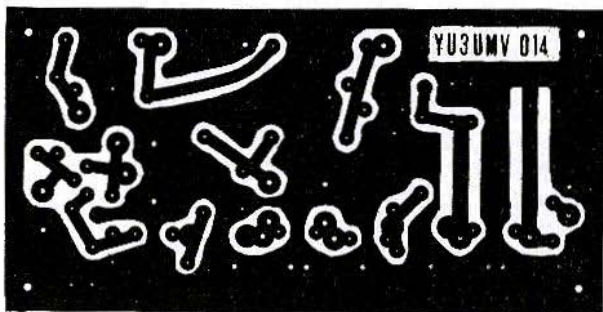
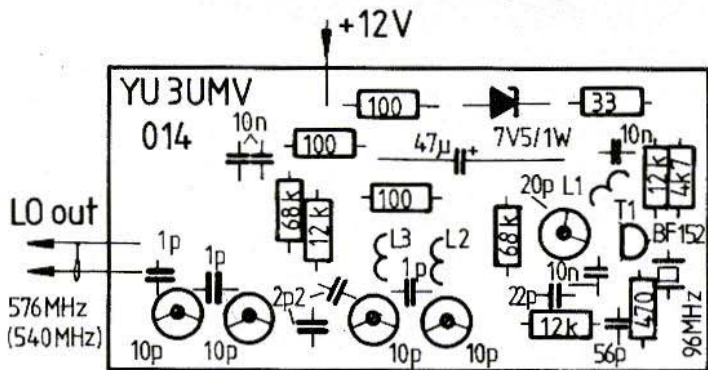

Fig. 29:  
PCB YU 3UMV 014 for  
oscillator module using  
96 (90) MHz crystals



T2 und T3 auf Leiterbahnseite

connections. First of all, a suitable length of cable is cut and both ends are prepared as shown, the inner and outer conductors being tinned. A 8 mm × 8 mm piece of tinned thin copper plate (brass will do also) is then soldered to the ground plane of the PCB – a slightly larger size will be required for RG-142 or RG-58 cable – and this is soldered to the coaxial screening mantle of the cable – the inner to the microstrip.

The oscillator modules and also the VOX circuitry can be constructed using ordinary single-sided PCBs. Their etching patterns and component layout diagrams are shown in figs. 28 to 31 in actual size drawings. All components can be mounted in the usual fashion with the exception of the transistors BFW 92. These are mounted under the PCB in order that the deleterious effects of the lead

inductance can be held to a minimum. All trimmers must be of high-quality plastic types – the ceramic trimmers are both mechanically and electrically inferior. The 2 pF to 10 pF trimmers in the 540 / 576 MHz resonator circuits can, in most cases, be replaced with 2 pF to 6 pF types, thereby obtaining a less critical tuning point.

The order of building the modules should follow the order in which the complete assembly would have to be aligned from scratch. First of all the modules which can be independently checked, are completed – the oscillators for example, can be built, checked and aligned first of all. Of course, any order of building is acceptable if the necessary test equipment is readily available but these instructions are intended for the average radio amateur constructor.



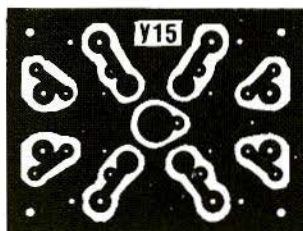
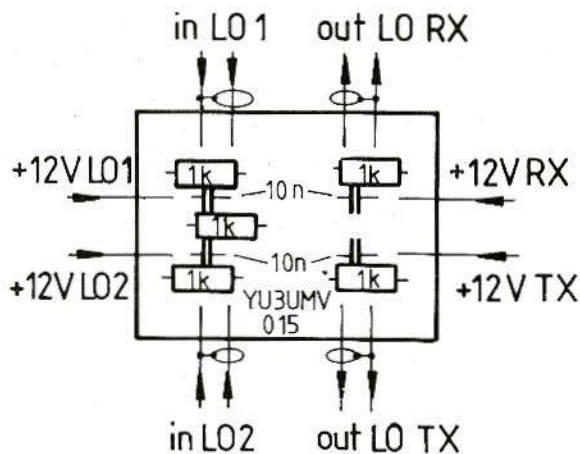

Fig. 30:  
PCB YU 3 UMV 015: Change-over switch for oscillator modules



4 x BA 182 auf Leiterbahnseite

After all the modules have been successfully built, tested and aligned, they can be installed into a suitable metal housing. Internal screening is, in practice, superfluous – quite the contrary in fact, the walls and floors of the cabinet must be kept at least 3 cm away from microstrip circuits in order to inhibit detuning and unwanted coupling effects.

## 10. ALIGNMENT

The alignment was, in principle, described in the introduction. All the microstrip resonators should lie very close to the specified frequency after an accurate etching process on the board material has been carried out. Only a fine tuning is necessary. Should it be necessary to shorten a resonator because its resonant frequency is too low, then it should only be done by cutting off 0.5 mm at a time, and then testing.

Before testing the resonant frequency of a microstrip circuit, it is as well to bear in mind that the permittivity of glass-epoxy PCB material has a positive temperature coefficient, which means, that as the board is heated, its natural frequency

tends to decrease. Therefore, always allow the board to cool to normal ambient temperature before testing (or tuning) following operations with the soldering iron.

The multiplier chain of the heterodyne oscillator is aligned first. All trimmers and / or resonators are tuned to obtain maximum output at the specified frequency. The frequency should be checked by a counter or by a Lecher-line resonant wave meter to ensure that maximum power is being delivered at the correct frequency.

Bipolar transistors, working as mixers and multipliers in a non-linear condition, should be checked following any alteration to the working DC conditions – particularly the base-emitter voltage. Owing to the rectifying action of the base-emitter junction, the applied RF signal develops an additional bias voltage which can be negative (peak to peak) by a few volts. The BE diode of the following transistor behaves then as an RF probe exactly where it is most desired – at the output of the stage which is to be aligned.

The small signal stages of the receive converter should be aligned with the aid of a suitable signal source and a two-meter receiver fitted with a sensitive S-meter. Since the microstrip resonators have already been aligned for the specified frequency a white noise source can be employed as

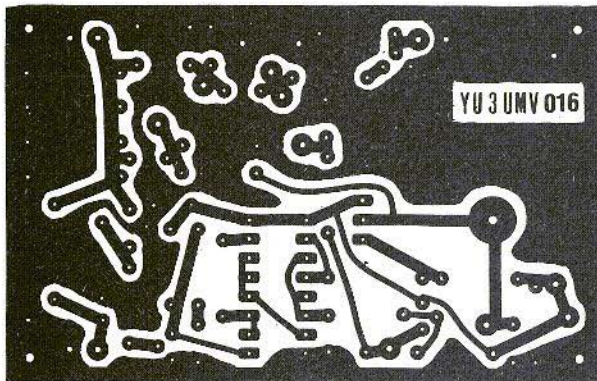
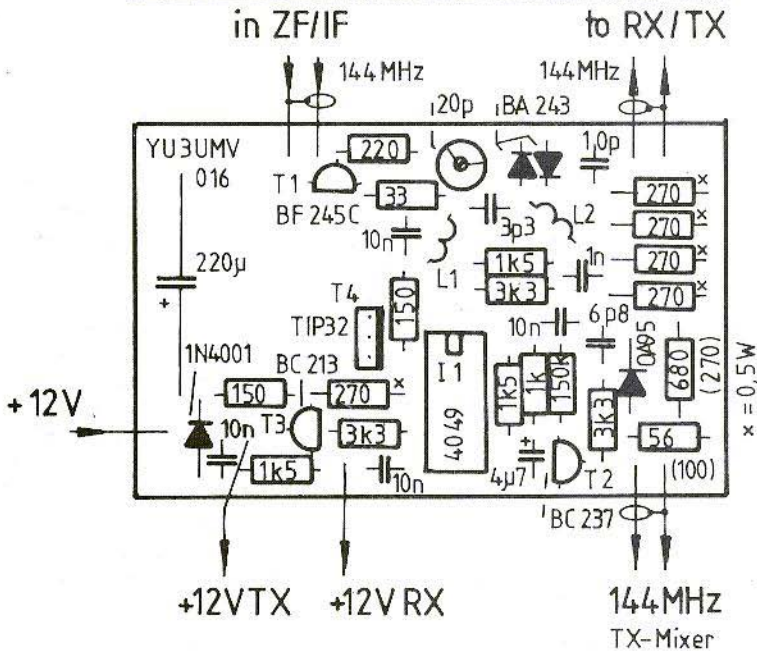

Fig. 31:  
PCB YU 3 UMV 016: VOX  
module



a signal generator. All resonators can simply be tuned for maximum possible output as in this transverter the bipolar silicon transistors used at frequencies above 1 GHz show no discernible differences between noise and signal matching.

To align the transmit converter, an SHF milliwattmeter should be connected to the output. This

could take the form of a 50 Ω termination, across which is a Schottky diode detector and suitable indicating meter. As the local-oscillator injection frequency lies very close to the desired mixer output signal — especially in the 13 cm band — and the single ended mixer in no way suppresses it, some care must be taken to ensure that the correct frequency is selected from the mixer out-



put. After the microstrip has been accurately etched to the specified dimensions it means, quite simply, that the resonator must be resonate at the correct frequency with a minimal of fine tuning. The output signal must, of course, immediately disappear when the 144 MHz input signal is removed from the mixer input. The famous Lecher wires are simple to construct and are sufficiently accurate as a frequency measurer (within 1 %).

When the transmit converter has been aligned and tested the output amplifier can be connected. Again, all stages are tuned to achieve a maximum output power.

During the tuning of the 23 cm power amplifier (fig.8) the  $10 \Omega$  resistance in the collector of T 2 should be increased to  $47 \Omega$  in order to avoid burning out the BFR 96 under off-tune conditions.

The selective 13 cm output amplifier (fig. 10) should be experimentally adjusted by altering the bias resistors of the last two stages (T 3 and T 4) and penultimate transistors in order to achieve a maximum output power but without exceeding the dissipation limits of these devices.

As already mentioned in the introduction, microstrip circuits, according to theory, require no screening measures. Problems can occur in practice when individual circuits are located in a metal housing and connected by coaxial cable. Every metal enclosure has an unending number of self resonances, some with a high Q, and the situation is made much more complicated by the presence of PCBs wire and coaxial cable of various lengths. Looking at the practical side concerning dimensions, the lowest resonant frequency must fall in low GHz range. For this reason those who work with frequencies below 500 MHz are hardly aware of this problem — quite the contrary to the experience of people working above 1 GHz!

Resonance problems are very difficult to cure by using screening measures as they only serve to create more resonances. Such problems are best tackled by reducing the Q of the unwanted resonance by the use of damping materials and circuits, the introduction of absorber pieces and soldering-in of low inductive resistors between the resonator hot points.

Absorber material is the best method of damping resonances caused by metal enclosures and

large surface area microstrips. Of course, care must be taken that the wanted resonance is not damped as well as the unwanted when using this material. If professional damping materials are difficult and / or expensive to obtain, a cheaper alternative solution is recommended: the conductive plastic foam which is used to store MOS semiconductor devices.

Individual resistors instead of absorbing material can also be used. They are used mainly to solve problems arising from the use of physically small components. This applies also to the coaxial cable which connect the various microstrip circuits together. The resonances do not occur on the inner conductor, or between the inner and screening mantle because both ends are terminated in the characteristic impedance of the cable. The screen of the coaxial cable forms, together with metal surfaces, another transmission line. As both ends of the coaxial screen are connected to ground,  $n \lambda / 2$  resonances are formed which possess quite a good Q. Owing to the continuous parasitic inductance of the screen-ground connection at both ends, these resonances are radiated out of the cable as radio waves. This is made worse, of course, if the ground connections have not been carried out correctly. These resonances can be damped effectively by soldering one or more  $100 \Omega$  resistors between screen and ground but the voltage nodal points of the spurious must be avoided.

Finally, there are coaxial cable lengths to consider, the critical ones which carry the signal from the oscillator modules to the multiplier stages are very sensitive to output termination impedances and can be rendered inoperative by an »unfortunate« choice of cable length. The 13 cm power amplifier chain too, perhaps could do with a trimming of cable lengths in order that the output power may be optimized.

---

## 11. CONCLUSION

---

The transverters described in this article have been in operation now for over two years and

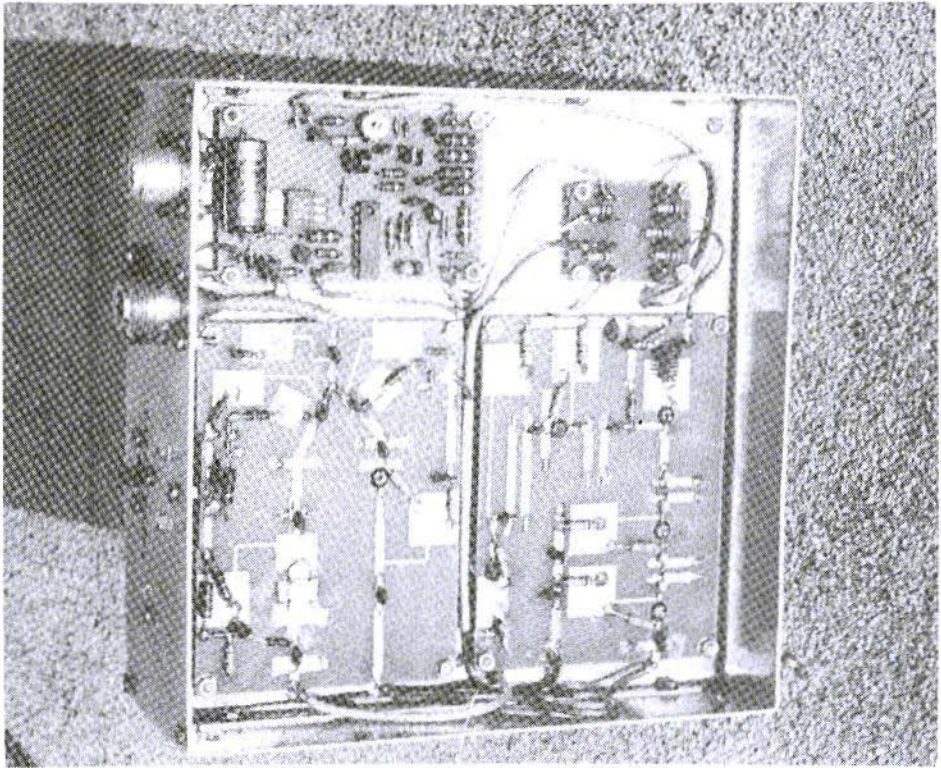

Fig. 32: Top view of 13 cm transverter prototype

several examples have been constructed. Many experiments were carried out in order to weed out potential problem areas in the circuit. The one main problem was caused by the frequency multiplier stages i. e. the transistors which were employed there. Besides the normal causes of transistor failure, over-current, over-voltage etc. another failure mechanism was observed. If relatively large RF signals are applied to the base of a transistor, as normally required for the efficient operation of a frequency multiplier, a parasitic Schottky barrier is gradually formed

which lies in parallel to the normal BE barrier. As the breakdown of this pseudo Schottky barrier is only 0.3 V, it is much lower than the 0.7 Volt of the normal barrier. This leads to a progressive deterioration of the transistor current amplification factor until it is zero. This process is gradual and sometimes can last for weeks or months of continuous operation before any deterioration is noticed.

It was discovered that differences in the susceptibility of a transistor to this mechanism was exhibi-

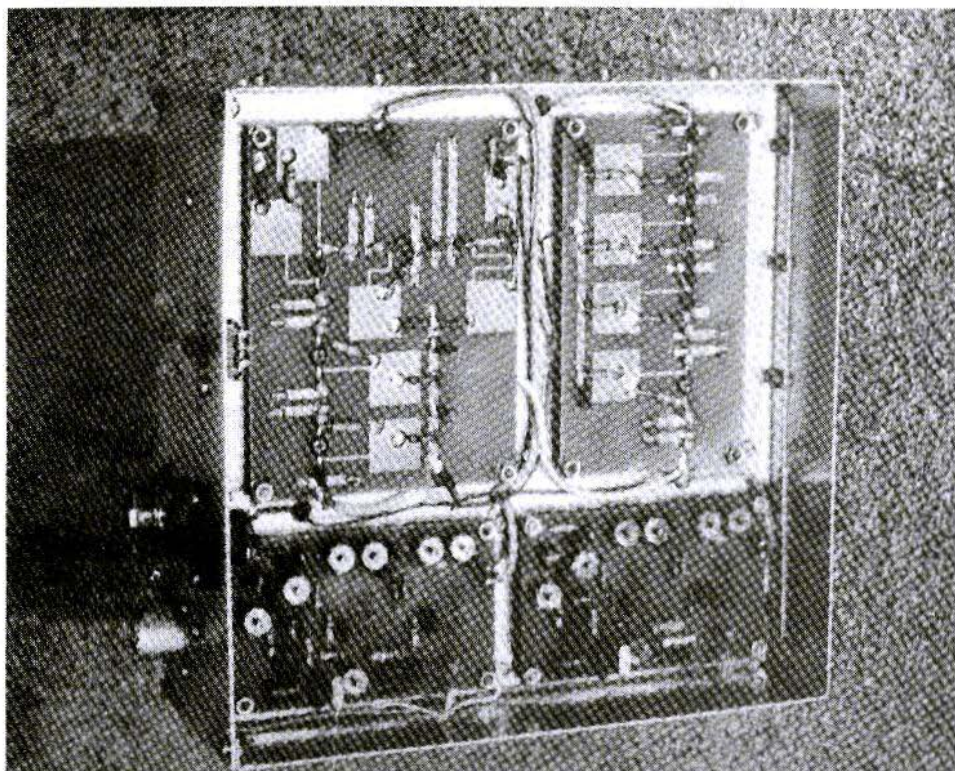

Fig. 33: Bottom view of 13 cm transverter prototype

ted within the same type manufactured by diverse firms. An important factor appears to be, that first grade transistors from reputable firms, such as Valvo or Siemens, seldom exhibit this failing when other specified operating conditions have not been exceeded.

On the other hand, the microwave stages with lower levels can employ a wide variety of transistors as the microstrip band filters allow a very wide tuning range. Microwave transistors in ceramic packaging ("micro-X" or "Cerec") always result

in higher gain and noise figure but they are almost an order dearer to buy.

Fortunately, a short time ago, two plastic packaged types with emitter fins have appeared on the market which are both reasonable priced and have data approaching that of the ceramic types.

Both transverters were designed in order that the adjustment procedure was as simple as possible, such items as wave trap resonators, balanced mixers and other complex circuit devices which



require expensive test equipment to set up, were deliberately avoided. Of course, these circuits can be used in microstrip technology. Besides the transverters, many other circuits were designed using the same technique: 13 cm and 23 cm transponders, receive down-converters for various satellite bands such as the meteorological satellite at 1.7 GHz, the MARECS downlink band at 1540 MHz and the NAVSTAR frequency 1575.42 MHz. In fact, the first converters built,

using the technology described, were tested on METEOSAT signals at 1694.5 MHz.

It was found in practice, that circuits built, using this technology, will work in extreme ambient conditions determined both by temperature and by humidity, they can be hauled up mountains, accepting rough usage such as inadvertent "drop tests" without being detuned.

## New High-Gain Yagi Antennas

The **SHF 6964** is a special antenna for the **space communication allocation** of the 24 cm band. The maximum gain of this long Yagi is 19.9 dB<sub>d</sub> at 1269 MHz and falls off quite quickly, as with all high-gain Yagis, with increasing frequency. We do not, therefore, recommend this type of antenna for operation at 1296 MHz but for **ATV applications** at 1152 MHz it is eminently suitable. There is no 24 cm ATV antenna on the world market which possesses more gain.

The mechanics are precise, the gain frequency-swept and optimised. Measurements carried out during heavy rain show that the antenna is not detuned by moisture.

Length:	5 m
Gain: 22 dB <sub>i</sub> , i. e.	19.9 dB <sub>d</sub>
Beam-width:	13.6°
Front / Back ratio:	26 dB
Side-lobes:	- 17 dB
VSWR ref. 50 Ω:	1.2 : 1
Mast mounting: clip (max).	52 mm
<b>Stock-No. 0103</b>	<b>Price: DM 298.—</b>

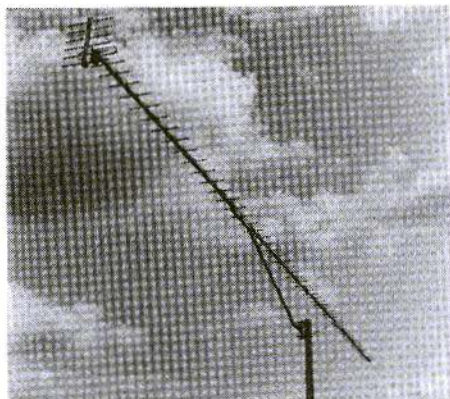

The **SHF 1693** is a special version for the **reception of METEOSAT 2**. This unobtrusive alternative to a 90 cm diameter parabolic antenna enables, with the aid of a modern pre-amplifier or down-converter, noise-free weather picture reception.

Length:	3 m
Gain: 20.1 dB <sub>i</sub> , i. e.	18 dB <sub>d</sub>
Beam-width:	16.8°
Front / Back ratio:	25 dB
Side-lobes:	- 17 dB
<b>Stock-No 0102</b>	<b>Price: DM 398.—</b>



**UKWberichte** Terry D. Bittan · Jahnstr. 14 · Postfach 80 · D-8523 Baiersdorf

Tel. West Germany 9133 47-0. For Representatives see cover page 2



Josef Grimm, DJ 6 PI

## Frequency Modulated Amateur Television (ATV)

Amateur television (ATV) was, until a few years ago, almost exclusively carried out in the 70 cm band. There was then sufficient room for an amplitude modulated colour television signal using commercial transmission standards.

As the 70 cm band grew increasingly busy with FM transponders, direct FM, satellite communication and commercial space safety installations, ATV signals were interfered with more often. Since this inconvenient eventuality cannot now be changed, many ATV amateurs are leaving the 70 cm band and are using frequency modulated signals in the SHF bands.

**The advantages of FM will be compared with the previously universally employed amplitude modulation. This report is a compendium of articles published in radio amateur literature and of the author's experience with FM ATV. The latest components from satellite technology, which are employed in ATV, will also be mentioned. In forthcoming issues of VHF Communications there will be articles from various authors which describe send and receive equipments for FM ATV in the GHz range. Some of this equipment will be suitable for the reception of commercial satellite television.**

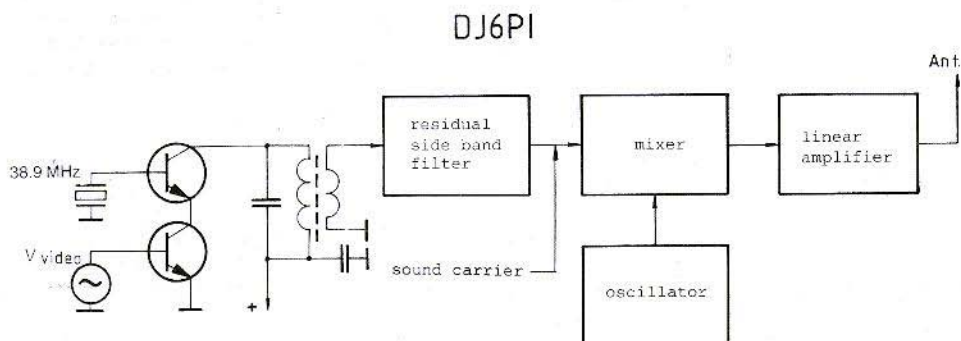

Fig. 1: Principle of an AM TV Transmitter

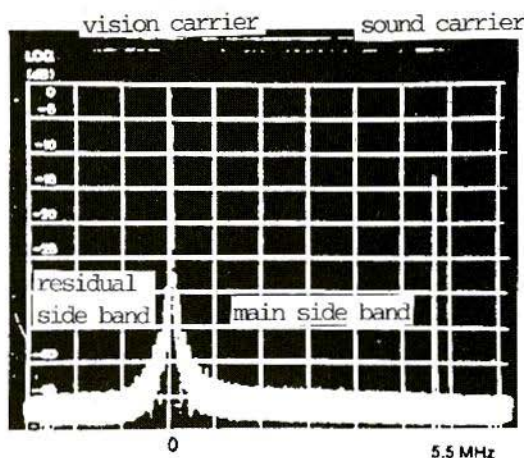

Fig. 2  
Bandwidth requirements of an AM TV transmission

## 1. AMPLITUDE MODULATED ATV

The AM mode was used by amateurs initially merely because this was the norm employed by commercial TV stations at both VHF and UHF.

### 1.1. AM ATV Transmitters and Receivers

ATV transmitters are described in references (1) and (2). The simplest type amplitude modulates a crystal oscillator at IF (38.9 MHz) with a video signal (fig. 1).

After passing through a residual side band filter and the addition of a sound carrier, the bandwidth is 6.75 MHz (fig. 2).

For the reception of amplitude modulated ATV signals, television receivers can be fitted with a frequency converter. The ATV signal is then translated into a suitable channel at VHF or UHF. As the picture information is contained in an AM signal, all stages in the transmitter must work in a highly linear mode. All departures from amplitude linearity have the effect of displacing the horizontal picture lines thus distorting the picture as well as falsifying the contrast and colour content. The signal also suffers from reduced synchronization leading to constantly rolling pictures. Amplitude

modulated transmitters must, on account of linearity, be driven at powers not more than 20 % of their peak power output capability. In the receiver, the linearity problem is countered by the use of automatic gain control (AGC) in both tuner and IF amplifier.

### 1.2. Signal to Noise Ratio

The noise spectrum located about a demodulated AM carrier, in the absence of distortion, is of constant amplitude (fig. 3) with frequency.

The video frequency signal to noise (S/N) ratio is equal to the high frequency carrier to noise (C/N) ratio. An improvement in picture quality can only be brought about by an improvement in the C/N ratio entailing an increase in sender power, higher gain antennas, improved receiver noise figures and lower attenuation coaxial feed cables etc.

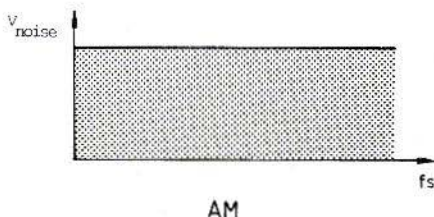
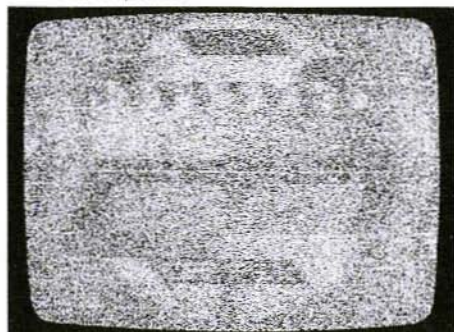

Fig. 3: AM noise spectrum following demodulation

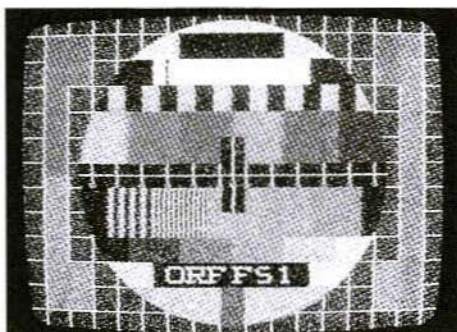



**Fig. 4: Effect of various signal / noise ratios on an AM TV picture**



**C / N ≈ 3 dB: Picture barely discernible**



**C / N = 20 dB: Details recognizable; Presence of colour**

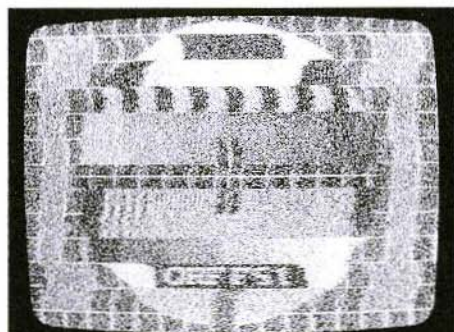

**C / N = 10 dB: Picture contaminated by noise**



**C / N = 30 dB: Noise just discernible**



**C / N = 40 dB: Picture noise-free (in commercial practice a picture is considered noise-free at 60 dB)**

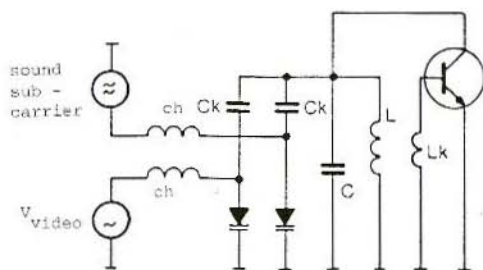

**Fig. 5: Circuit diagram of oscillator FM modulated by both sound and vision**



The visual impact of this improvement upon the picture quality is depicted in **fig. 4**.

A received picture which is plagued with noise from a contact station using 10 W of power would have to request an increase in power of up to 10 kW before the picture could be considered as noise free.

### 1.3. High Frequency ATV Interference at 70 cm and how to find a Solution

When the 70 cm band is overcrowded an ATV contact can suffer picture degradations ranging from light patterning to drop-outs of both sound and vision. The only answer really is to move to the GHz bands. Even here, there are some obstacles in the way of improved reception.

— The path loss

$$A_o = 32.5 + 20 \log. d. f \text{ (dB)}$$

Where  $A_o$  is the free space attenuation,  $d$  is the distance in km and  $f$  is the frequency in MHz.  $A_o$  at 23 cm is some 9 dB more than at 70 cm and further 5 dB is added at 13 cm. The additional loss due to earth-obstacle interference is also considerable.

— Cable loss

The cable loss also climbs greatly as the frequency increases. Taking the well known RG-213 as an example, the cable losses at 23 cm increase by 14 dB compared with the loss at 70 cm and a further 23 dB at 13 cm, all for a 100 m length of cable. These losses cannot be compensated by an increase in the transmitted power as this is not normally an option for radio amateurs working at SHF.

The only answer is to use a suitable transmission form which can compensate for all losses, and that is frequency modulation.

## 2. FREQUENCY MODULATED ATV

The modulation mode FM has been successfully employed in TV communication, broadcast TV and by direct broadcast television (DBS) satellite systems. The technology is simple enough for its adoption by radio amateurs.

### 2.1. FM ATV Transmitters and Receivers

The picture modulation can, in the simplest manner, be produced by impressing the video signal on to a varicap diode controlling the oscillator frequency. The audio signal is FM modulated on a subcarrier (5.5 MHz for example) and then fed to another varicap also controlling the oscillator frequency as indicated in **fig. 5**. On account of large deviation of the video signal, crystal oscillators are not suitable. Stable, free running oscillators are used at low frequency (e. g. 123 MHz) and multiplied or translated up to the final frequency.

A suitable transmitter driver is described in ref. (3).

At the present time FM ATV are using a preferred frequency of 123 MHz in order that available SHF mixers and amplifiers can be used. Such transmitters are designed for the conversion of CW / SSB / FM signals from two metres up to SHF. They are inherently capable of handling

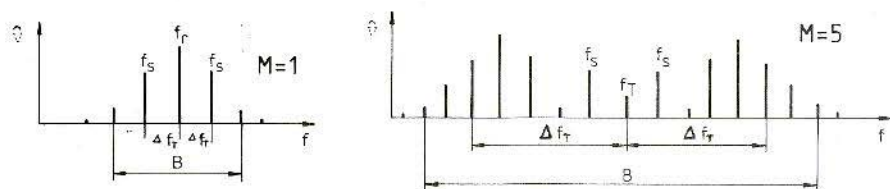
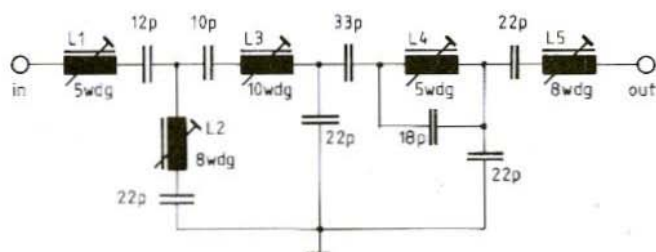

Fig. 6: Spectrum of FM carrier modulated by sinusoidal tone for modulation indices of 1 and 5



**Fig. 7 :**  
70 MHz LC bandpass filter:  
Coil dia. 5 mm, core: white

wide band FM ATV signals. The FM ATV signals are generated at somewhat below 144 MHz in order not to interfere with local receivers working on two metres. Transmitter circuits using PLL ICs working directly at SHF without the need for up-conversion, are in the course of preparation (ref. 8).

Angle modulation, i. e. frequency or phase modulation, produces a theoretically infinite number of side band frequencies which are symmetrically disposed about the radio frequency carrier. They occur at frequency intervals, about the carrier, equal to the instantaneous frequency  $f_s$  of the modulating frequency (picture and sound). The peak deviation  $\Delta f$  about the carrier is determined by the amplitude of the modulating signal.

The total bandwidth  $B$  of an FM transmission is given by:

$$B \approx 2(\Delta f_T + f_s) \text{ Hz}$$

In practice the bandwidth is not infinite, as the outer signal frequencies about the carrier do not contain much power. In this application, the outer side frequencies whose amplitudes are less than 10 % of the unmodulated carrier are of no importance but, naturally, the fidelity requirements set the limit to the bandwidth.

The signal to noise ratio depends upon the modulation index  $M$

$$M = \frac{\Delta f_T}{f_s}$$

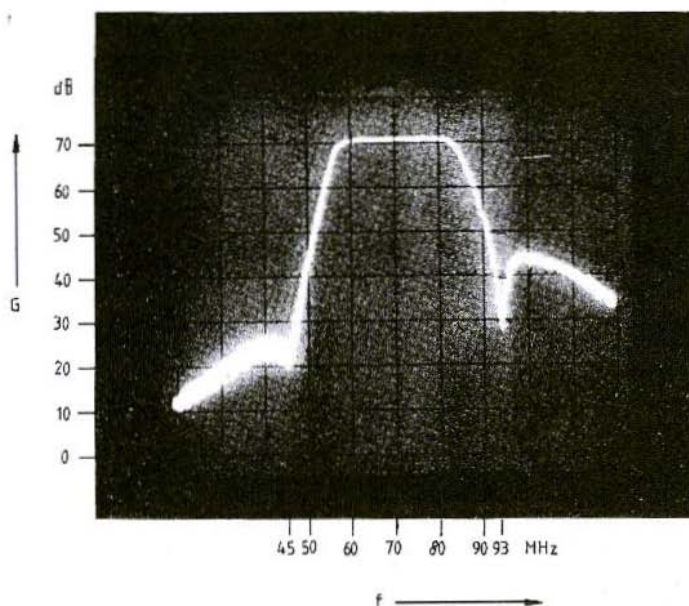

**Fig. 8:**  
Response curve of  
70 MHz amplifier with  
LC bandpass filter

The effect of this important FM parameter upon the bandwidth, as well as the amplitude of the carrier and side frequencies, is shown in **fig. 6**.

The highest signal frequency  $f_s$  used in ATV is 5.5 MHz which is that of the sound subcarrier. The modulation index  $M$  normally used lies between 0.5 and 1. Thus the bandwidth is approx. 16 to 22 MHz and it can be appreciated that it would be very uneconomic in terms of channel bandwidth to use this mode below the SHF bands.

The FM receiver part of the system is more complicated than the transmitter and something more than just a frequency translator is required. The HF and IF sections of the receiver must be designed to pass sufficient of the FM TV bandwidth (and no more) to allow an acceptable picture quality. The FM demodulator must also be able to function at large bandwidths.

At first, the IF amplifiers and FM demodulators worked at 70 MHz which is an international IF used in satellite communications. The signal frequency at SHF (e. g. 1.3, 2.3, 10 GHz) is translated down to the IF by means of a down-converter. In references (4) and (5), suitable IF amplifiers are described. A modified version of that described in (5) is featured in a serial article in the magazine "TV - Amateur". The 70 MHz IF has the disadvantage that the image channel lies very

close to that of the input signal. In order to avoid the extra noise content resulting from this, a complicated bandpass filter, which has a stop band able to reject the image frequency, must be used at the received frequency. Until now, a self-constructed LC acceptor filter was used to select the IF signal (**fig. 7**).

The pass band flanks (**fig. 8**) are fairly steep in order that adjacent channel narrow band signals (CW, SSB, FM speech) do not interfere with the reception of FM ATV signals. A sweep generator is required for alignment. A pre-aligned, 70 MHz mid-frequency LC bandpass filter is now available from Texscan with bandwidths of 16 to 30 MHz (designated e. g. XBM 70 / 25-1). Its use obviates the requirement for a sweep generator.

In the meantime, surface wave resonators have become available for the 70 MHz band. They are distinguished by their steep flanks and the stop-band rejection (i. e. outside the bandpass range) is better than 40 dB.

The outstanding pass band characteristics (**fig. 9**) must, however, be obtained at the expense of a very high insertion loss, about 27 dB, but the IF amplifier in (5) possesses enough gain reserve (and a good noise figure) in order to compensate for this undesirable characteristic.

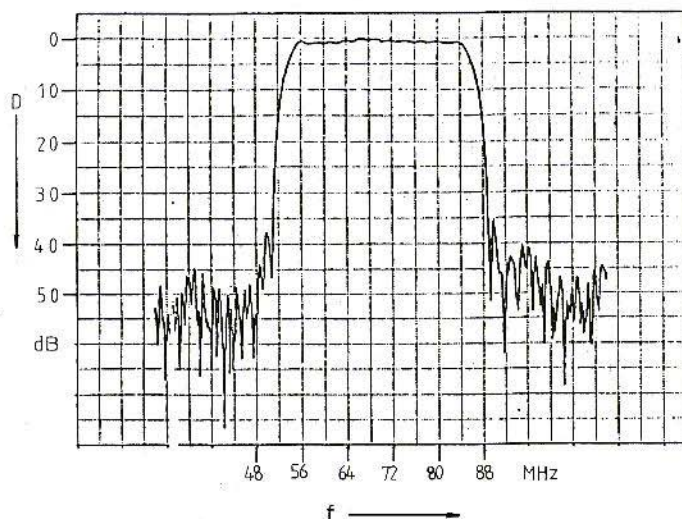

**Fig. 9:**  
Response curve of  
Signal Technology  
SW 503 70 MHz  
surface wave filter

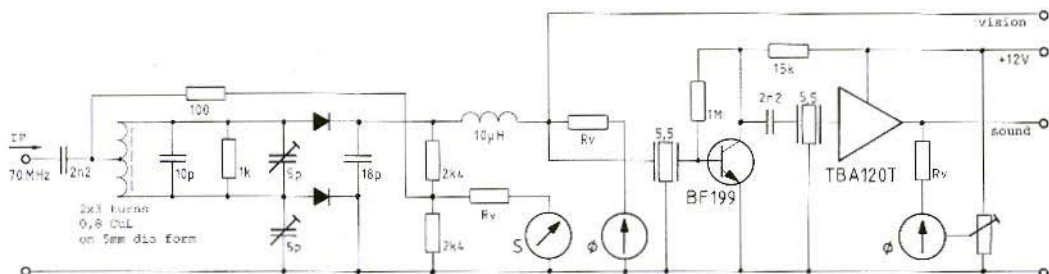

Fig. 10: FM TV diode discriminator showing vision and sound demodulators

Industry has now moved away from the 70 MHz IF band, on account of the image frequency problem, to a new frequency of 479.5 MHz. Surface wave filters possessing the same specifications of those at 70 MHz are available, for example the Y 6950 (Siemens) and the SW 504 (Signal Technology). Also FM ATV equipment should be using these new IF components and complete integrated IF amplifiers incorporating them should be available soon.

On account of the high price and the difficulty in obtaining these new 479.5 MHz components, the use of the 70 MHz IF technology is still justified.

Particular attention must be devoted to the FM demodulator which is largely responsible for a distortion free FM TV communication link.

At the start, experiments were made using a diode discriminator and in (6) one of these is described. The diode discriminator shown in fig. 10

requires a very high IF input level. It is also very difficult to effect the required bandwidth using a simple tuned circuit in the discriminator.

Better results can be obtained with the PLL demodulator using the IC NE 564 (fig. 11). It has a 5 dB (approx.) better signal / noise ratio with only a very weak input signal.

In spite of the outstanding characteristics of the NE 564, there are a few disadvantages which must also be taken into account. The maximum specified working frequency is only 50 MHz and therefore some examples working at 70 MHz are unstable. The bandwidth, also, is only 22 MHz causing broadband TV signals to display pictures having ragged edges. The internal signal / noise (vision) amounts to only 40 dB and the received picture is slightly noisy even under the best reception conditions. Commercial TV reproduction demands a signal / noise ratio of about 60 dB.

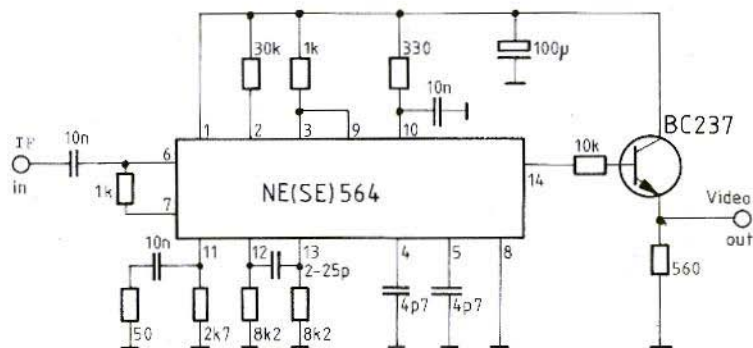

Fig. 11: Integrated circuit PLL demodulator using NE 564

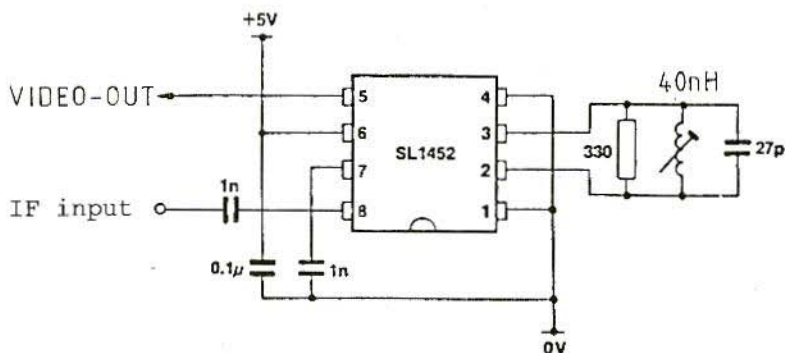

Fig. 12: Simplified circuit diagram of demodulator using the SL 1452

Finally, the NE 564, in spite of its internal limiter, can be easily overloaded. An external limiter such as the MC 10116 is able to help in this respect.

For the new IF band at 479.5 MHz a better integrated circuit demodulator is already available. It is the Plessey quadrature demodulator SL 1452 (fig. 12).

The bandwidth can be altered according to requirements by changing the value of the external damping resistor across the tuned circuit. The vision frequency signal / noise ratio is 70 dB thereby exceeding even commercial requirements.

The author has had no experience of the NEC  $\mu$ PC 1477 C 479.5 MHz PLL demodulator.

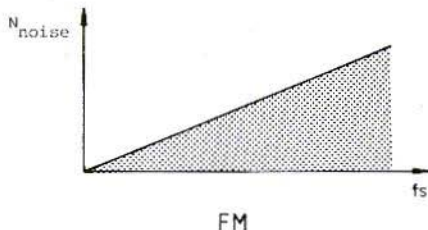

Fig. 13: Triangular noise spectrum of demodulated FM wave

At the FM receiver output the vision and the speech signals are available. The TV receiver must have a monitor input. Older TV sets can normally be easily provided with a direct input. As an alternative, both vision and speech may be caused to modulate a UHF oscillator and the

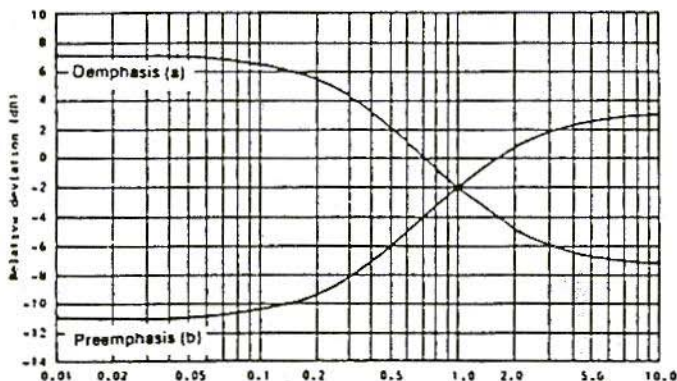

Fig. 14: Pre- and deemphasis characteristics

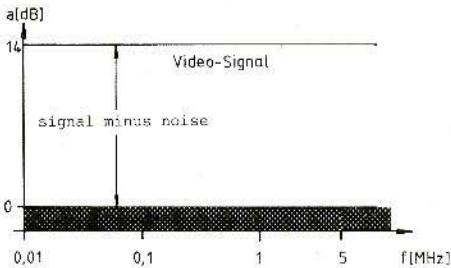

Fig. 15: Result of Emphasis on received video frequency output

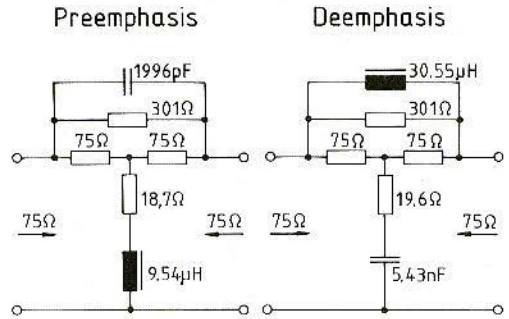

Fig. 16: Pre- and de-emphasis networks

modulator fed to the antenna input of the set. A suitable modulator is e. g. the Siemens IC TDA 5660 P (9).

**2.2. Improvement of FM TV Video Signal / Noise ratio**

The demodulation of an FM signal reveals an inherent undesirable effect, the linear increase in the noise signal as the modulation frequency increases (see fig. 13). This is known as the "FM triangular noise", the AM noise spectrum, on the other hand, is flat (fig. 3).

As the amplitudes of the higher frequency video signals from a video camera tend to be lower, the result of this FM triangular noise is a noisy picture. The universal answer to this phenomena is to

emphasize the higher modulation frequencies linearly with frequency thus compensating for the noise and tending to equalize the signal to noise ratio across the band. This process is known as pre-emphasis (PE) and must be matched at the receiver by a network which effectively attenuates the high modulating frequencies thus restoring the relative amplitudes to those of the original from the camera. This network at the receiver is known as the de-emphasis (DE) network and is shown together with the pre-emphases network in fig. 16.

The form of the characteristics are complementary and are subject of a CCIR standard NORM-405-1. They are shown in fig. 14. The networks are of a simple nature and are installed



Fig. 17: Picture without emphasis



Fig. 18: Picture under same conditions but with emphasis



in the video frequency circuits of both transmitter and receiver.

**Figures 17 and 18** show the effects of including these networks on a marginal link resulting in a noisy picture. Following inclusion of the PE and DE networks the picture quality is noticeably improved. It is quite a simple means of improving the signal to noise by some 14 dB and thereby picture quality.

### 3. AM AND FM TV COMPARED

Both modes of transmission require signals at the receiver which exceed the respective threshold levels. FM cannot work wonders and make good pictures from noisy links when the signal lies under the FM threshold ( $T_{FM}$ ).

With FM, an increasing system gain relative to AM is obtained as the modulation index  $M$  is increased above 0.5. The improvement is brought about because the frequency deviation of the transmitted FM signal is increasing larger than the thermal (phase) noise of the link as  $M$  is increased. This applies to all components of the modulating signal  $f_c$  comprising both vision and sound.

According to ref. (7) the system gain of FM over AM is: —

$$S = 10 \log 3(M/m)^2 \quad (\text{dB})$$

Where  $m$  is the modulation factor of the AM TV signal.  $S$  = System gain. The AM transmission must limit the picture modulation to a maximum of 80 % in order that the speed and colour are not submerged due to subcarrier compression. The modulation factor  $m$  is thus 0.8. **Fig. 19** shows the curve of system gain  $S$  versus modulation index  $M$ .

**At a modulation index of  $M = 1$ , the bandwidth is about 22 MHz and the FM gain (over AM) is 6.7 dB.** This should be a satisfactory working condition for the SHF bands. The satellite TV bands, however, use a somewhat larger bandwidth of 27 MHz. At a modulation index of  $M = 5$  the bandwidth would be an enormous 66 MHz at an FM gain of 20.6 dB. It is clear that gain is purchased

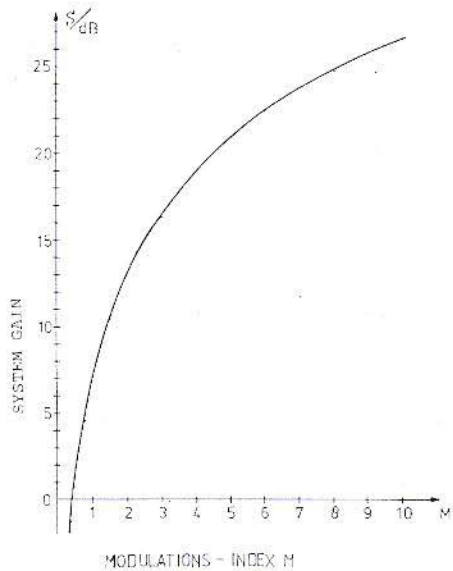

**Fig. 19: FM system gain over AM versus increasing values of  $M$**

at the expense of bandwidth in an FM system. This bandwidth is not, however, economical in terms of frequency, and in any case, the video signal could not be demodulated using means available to the radio amateur.

The use of an emphasized signal increases the gain by 14 dB but by the use of a suitable demodulator a further 5 dB may be obtained.

**The overall gain of FM over AM systems in terms of vision signal to noise ratio is 20 to 25 dB.**

The change from the 70 cm band to the 1.3 or 2.3 GHz SHF bands, with their higher path loss, has been more than justified. This is conditioned, however, by the fact that a clear path between the link partners is even more necessary at SHF and no obstacles such as houses, hills, woods, etc. can be tolerated.

The theory was borne out by the experience of a group using the ATV transponder DB Ø DN situated on the top of Tegelberg.

The FM threshold in the 2.3 GHz band receiver lies about 10 dB above the system noise. Under





Fig. 20: FM ATV 2.3 GHz transmission at 150 mW. Received under the receiver FM threshold ( $T_{FM}$ ). Noisy but colour present

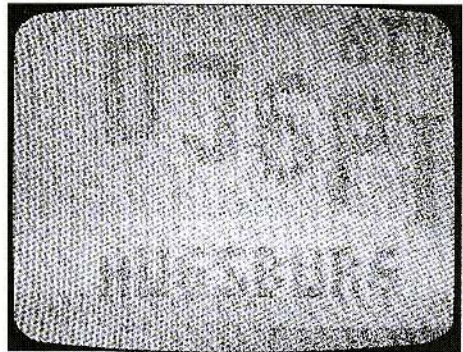

Fig. 23: AM ATV 70 MHz transmission,  $P_o = 1$  W, received  $C/N \approx 10$  dB, contaminated with noise, no colour

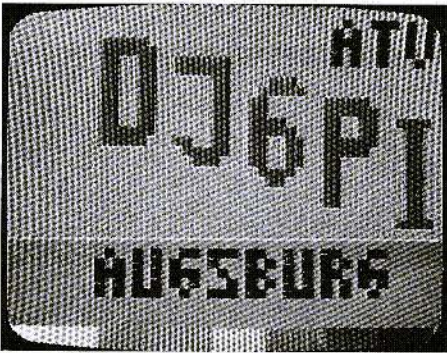

Fig. 21: As fig. 20 but  $P_s = 800$  mW. Reception at  $T_{FM}$ , slight noise but colour present

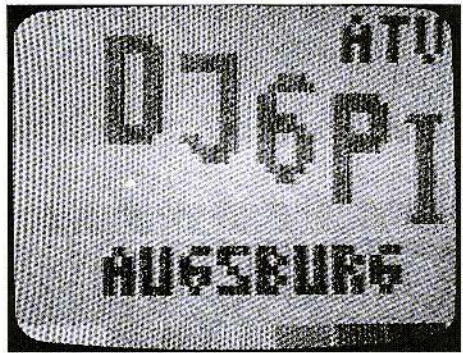

Fig. 24: As fig. 23, but  $P_o = 10$  W,  $C/N \approx 20$  dB, noisy but colour present



Fig. 22: As fig. 20, but  $P_o = 1.5$  W: Noise-free with colour



Fig. 25: As fig. 23, but  $P_o = 70$  W,  $C/N \approx 30$  dB, slight noise, colour present



this threshold, the received pictures are contaminated with noise but colour is available as soon as the picture becomes visible, see **fig. 20**. In the region of the FM threshold the picture improves dramatically from noisy to noise-free (**fig. 21**). From 3 to 6 dB above the FM threshold, the picture cannot be improved by system change, such as increase in Tx power, better Rx noise figures etc., as the picture is already noise-free (**fig. 22**).

Finally to summarize:

FM ATV has the following advantages over AM TV.

- 20 to 25 dB better signal / noise ratio by transmitters of equal strengths. This means, conversely, that the TV sender power using FM can be 20 to 25 dB lower for the same received picture quality.
- Simpler transmitter construction

- All stages in the transmitter may be driven at their full permissible power ratings.

The following disadvantages must be recorded:

- A special receiver must be built for FM TV
- Higher bandwidth is required.

The advantages are overwhelming for the use of an FM system and those who are tired of receiving QRM plagued pictures on the 70 MHz band should switch to FM ATV in the SHF bands.

The pictures shown in **figs. 20 - 25** were transmitted over the 2.3 GHz band using FM ATV and over the 70 cm band using AM ATV. For a better comparison, antenna gains and feeder losses were compensated for in the final analysis in order that the transmission quality could be judged for transmitters using the given powers.

#### 4. REFERENCES

- (1) G. Sattler, DJ 4 LB:  
Baugruppen für einen ATV-Sender nach dem ZF-Verfahren  
UKW-Berichte 12 (1972) Hefte 3 und 4.  
Not available in English
- (2) H. Venhaus, DC 6 MR:  
Ein ATV-Sender für das 70-cm-Band auf einer Platine  
TV-Amateur 3 / 1974, Pages 9 - 29
- (3) W. Rätz, DL 6 KA:  
Ein FM-ATV-Steuersender  
TV-Amateur 50 / 1983, Pages 18 - 23
- (4) K. Hirschelmann, DJ 7 OO:  
Eine Amateurfunkfernsehstation im 10-GHz-Band  
TV-Amateur 45 / 1982, Pages 20 - 29
- (5) E. Zimmermann, DD 9 QP:  
Universeller ZF-Verstärker für FM-ATV-Anwendungen.  
TV-Amateur 54 / 1984, Pages 18 - 23
- (6) H. Venhaus, DC 6 MR:  
FM-ATV.  
TV-Amateur 43 / 1981, Pages 14 - 21
- (7) R. Mäusi, DL 9 YZ:  
Modulationsverfahren in der Nachrichtentechnik  
Hüthig-Verlag 1981
- (8) G. Sattler, DJ 4 LB:  
SDA 3202 - A new PLL IC for up to 1.5 GHz  
VHF COMMUNICATIONS Vol. 18,  
Ed. 1 / 1986, Pages 18 - 22
- (9) Siemens:  
TDA 5660 p - A Versatile Modulator Circuit for TV, Video and Sound Signals in the Range of 48 to 860 MHz  
VHF COMMUNICATIONS Vol. 17,  
Ed. 2 / 1985, Pages 125 - 127
- (10) R. Polz, DC 2 CS:  
IF Amplifier and Demodulator for Wideband FM.  
VHF COMMUNICATIONS Vol. 18,  
Ed. 3 / 1986, Pages 130 - 134



Carsten Vieland, DJ 4 GC

## Tunable VHF to SHF Bandpass Filter

The successful amateur construction of equipment requires a certain amount of test gear. A recurring problem is that of the definite identification of high-frequency signals. The driving of mixers and the operation of amplifiers and multipliers in class C all require the positive selection of the wanted signal from the spectrum of frequencies incidently generated by this mode of operation. A tunable bandpass filter is described here which possesses a good Q and can be employed over a wide range of frequencies. The filter is designed around  $50 \Omega$  enabling it to be used with standard  $50 \Omega$  coaxial interfaces.

---

### 1. PRINCIPLE

---

Fixed tuned filters above one gigahertz are based upon the idea of stub filters comprising a number of intercoupled quarter – or half – wave elements. These filters, according to the number of elements, have either a low insertion loss or excellent selection characteristics. The filter possesses resonant responses at an indefinite number of frequencies above the design frequency. The tuning range is very limited and a continu-

ous tuning with the aid of a calibrated scale is difficult owing to mechanical ganging problems.

In this article a UHF transmitter, using a well known cavity resonator (e. g. that used for the 2 C 39), will be fitted with a tuning drive having a calibrated frequency scale as well as input and output couplings. The tuning range, interestingly, is considerably larger than that using LC or power resonators and is only equalled by magnetically tuned YIG filters. In an actual case there was one filter with a highest tuning limit of 2.9 GHz (plunger fully out) and a lower limit of 280 MHz (plunger fully in). This well nigh fabulous frequency range is, however, also free of overtone and spurious resonances. In addition, the frequency selection was better than 25 dB and the Q was high over the entire tuning range.

On the debit side, an insertion loss of, in general, more than 1 dB has to be taken into consideration. The main strength of this filter lies in measurement analysis possibilities and the cleanliness of the output signal. In conjunction with a suitable wide band detector (thermal or diode) the combination represents a very effective spectrum analyzer.

The resonant circuit consists of a cavity resonator which is excited in the  $E_{010}$  mode. By adjustment of the input coupling, it was determined that spurious modes and resonances could not be



provoked. The "hot" point of the resonator was located at the end of the tuning plunger. The deeper the plunger is screwed into the cavity the greater its capacity to the cavity wall as well as an increasing self-inductance along its length. It is because of the combined effects of the LC tuning that enables such an extreme tuning range of over 10 : 1 to be possible.

In the vicinity of the lower frequency limit, the alternating field is concentrated at the end of the plunger. The input coupling probes at the periphery interact with this field causing a certain amount of mismatch. This causes a deterioration in the return loss together with an increase in the insertion loss of the device. The latter is normally under 1 dB at midrange with resonators that have been silver-plated but at the extreme lower limit the loss could climb to 10 dB. For this reason, the tuning range should be restricted to a limit ratio of between 2 and 3 in order to preserve the insertion loss specifications.

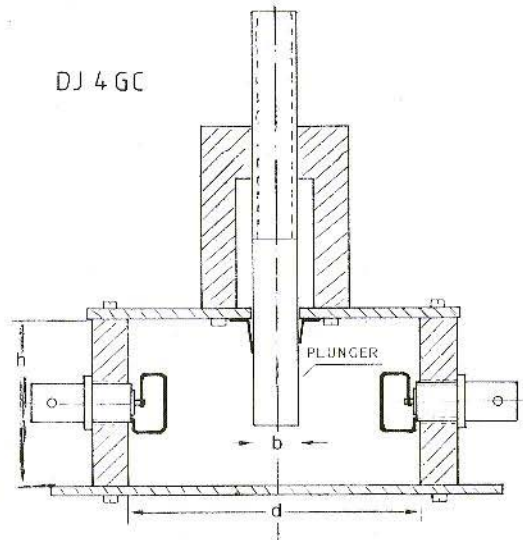

Fig. 1: Construction of a tunable cavity resonator

## 2. CONSTRUCTION

The mechanical construction in the simplest case can take the form of a length of cylinder complete with top and bottom. Coaxial couplings are let into the sides and the cavity is excited by coupling loops. The depth by which the tuning plunger penetrates the interior of the cavity from one of the lids

determines the cavity resonance frequency. The fitting of a mechanical drive and an engraved frequency scale is left to the ingenuity and skill of the constructor. The tuning range, when the tuning plunger is near the cavity floor, becomes very cramped as may be seen in **fig. 3**. The filters discussed in this article have several tuning mechanisms whose merits will be compared. The con-

No	Frequency range (GHz)	Internal height (mm)	Internal diameter (mm)	Plunger dia (mm)	Coupling loop (mm)	Coaxial connectors
1	0.10 – 1.0	85	192	see text	30 x 20	BNC
2	0.28 – 2.9	25	70	19	11 x 6	BNC
3	0.75 – 5.7	15	40	7	7 x 3.5	BNC
4	2.60 – 10.5	9.5	20	4	3 Ø	SMA
5	8.00 – 26.0	4	8	3	1.5 wire	SMA

Table 1



structural representation in **fig. 1** shows the main constructional points of an inductively coupled resonant filter. The figures in **table 1** give dimensions together with the frequency range which may be expected.

Using a diameter to height ratio of 2 : 1, the upper tunable frequency limit may be given by the following approximation: –

$$f_0 \approx 1 \text{ GHz} \frac{208 \text{ mm}}{d}$$

where  $d$  is given also in millimeters.

The unloaded  $Q_0$  of a cavity with the tuning plunger fully withdrawn is approximated by: –

$$Q_0 \approx \frac{V}{A}$$

where  $V \triangleq$  Internal volume of cavity (without tuning plunger)

$A \triangleq$  Internal surface area

Using silvered cavities which have been polished, unloaded  $Q_0$ s of more than 50,000 can be achieved.

The working  $Q$ , and thereby the bandwidth  $B$ , is overwhelmingly determined by the degree of coupling. If the input coupling is weak, however, the loaded  $Q_0$  is quite high despite the poor value of the unloaded  $Q_0$  in this region.

The walls of the cavity are made preferably from brass tubing of 5 mm thickness. As this material cannot be readily obtained, and in any case a lathe and BNC / SMA thread cutters would be required, a low cost thin-walled version with cleanly soldered lid joints and flange sockets was constructed. Also, cavities of rectangular cross section display similar characteristics and are very frequently employed as cavity filters.

The first filter detailed in table 1 is only an experimental effort which was constructed from a biscuit tin (**fig. 2**). The tuning plunger (6 mm  $\phi$ ) is fitted with a 50 mm  $\phi$  plate in order to increase the capacity. Using tin, however, results in a drastic increase in the insertion loss of the device.

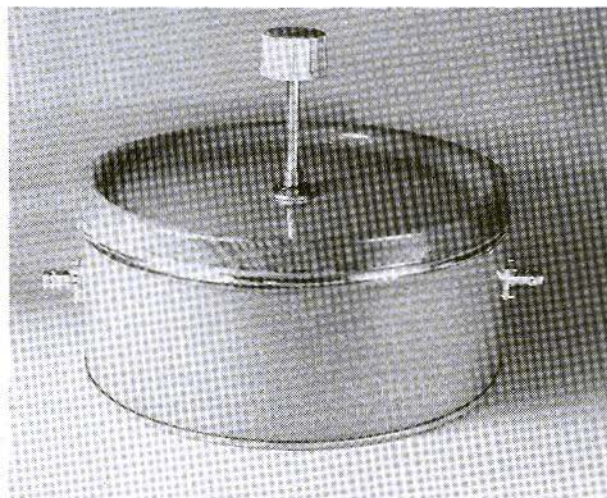

**Fig. 2:**  
VHF cavity (filter No. 1)  
made from a biscuit tin

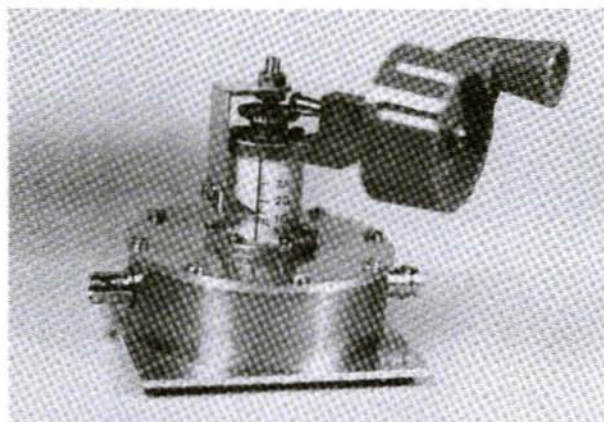

Fig. 3:  
UHF cavity resonator  
(filter No. 2)



Fig. 4:  
Internal construction of the  
UHF cavity resonator

A tunable UHF resonator is shown in **figs. 3 and 4** and two SHF filters are displayed in **figs. 5 and 6**.

The contacting of the plunger with the lid wall is a key factor in the quality of the cavity's construction. This should preferably be carried out using contact (finger) strip. This may be purchased in metre long strips but material taken from UHF / SHF radio junk can be pressed into service. In particular, cathode and grid holders for coaxial tubes such as the 2 C 39 or RH 7 C are of high quality and are very suitable for this purpose.

Cavity diode holders must be worked on a little (6.3 mm) but can be used. Push-pull mixers using diodes in a reversible housing (e. g. 1 N 23 WE): the diode plug-in caps represent a high quality 2.3 mm plunger bush. For the plunger a 2.5 mm diameter length of copper wire can be stretched to obtain a diameter of 2.3 mm. Owing to its small relative diameter, such a tuning spindle should only be used in high frequency cavities. For use at UHF the plunger could be fitted with a capacitive plate of 5 to 10 mm diameter.

Should only a preset or fixed tuning range be de-

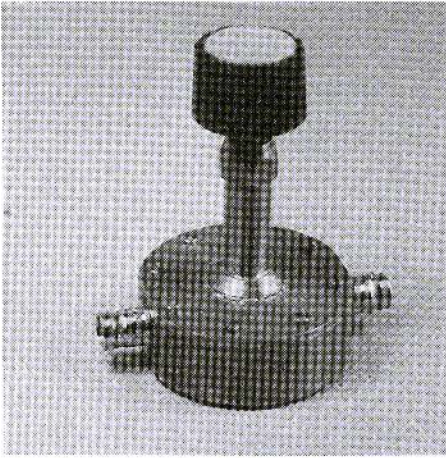

**Fig. 5: Filter No. 3, a 750 MHz to 5.8 GHz cavity resonator built by DJ Ø PQ**

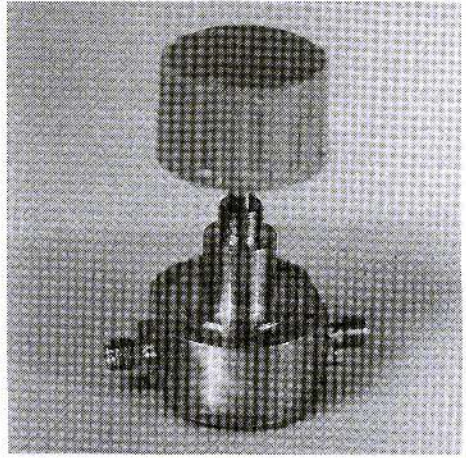

**Fig. 6: X-band filter with SMA connections (No. 4)**

sired, the tuning plunger can take the form of a silvered (preferably) brass M 3 to M 8 screw (fig. 7) with a suitable locking nut.

In the higher SHF regions a contact-free tuning mechanism is chiefly employed such as that described by DL 3 ER in (1) and (2). This is to be preferred rather than the sliding contacts of the plunger guide. The low pass structure of the plunger guide must, however, be effective at the lowest tunable frequency (figs. 8, 9 and 10).

Because of its precision guide system, a plunger fitted with a micrometer is particularly suitable. Such tuning micrometers can often be rescued from S-band or X-band junk.

Instead of the more usual magnetic loop coupling, a capacitive excitation from a short rod or from the inner of a coaxial socket could be used. These coupling elements must, however, be shorter than  $\lambda / 4$  at the highest tunable frequency as otherwise, a free-space transmission would

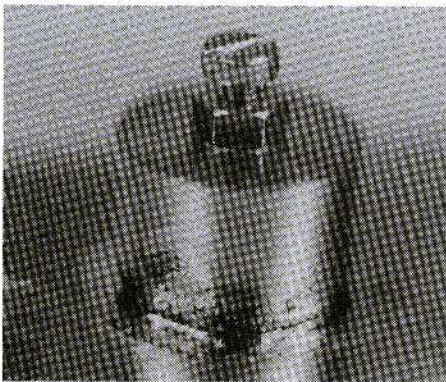

**Fig. 7: Printed circuit board X-band resonator with M3 screw tuning plunger**

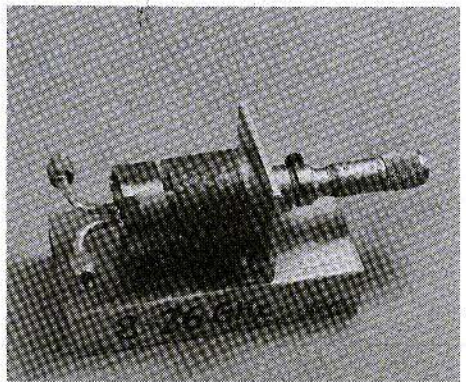

**Fig. 8: 8 to 26 GHz through filter (No. 5)**



occur. If the coupling is too tight into the resonator, the  $Q$  deteriorates and with it the selectivity of the device. A coupling element which is on the short side increases the insertion loss.

In practice, a favourable value is obtained with a radiation length of no more than  $\lambda / 8$  (free-space wave length) at the highest tunable frequency. For fixed frequency applications the optimum probe length lies around  $\lambda / 10$  which means a length of some 3 mm for X - band work. The distance to the cavity walls would, in this example, be from 1 to 2 mm.

The through filter, shown in **figures 8 to 11**, covers the frequency range from 8 to 26 GHz, i. e. the three millimetric bands X, KU and K. The SMA sockets are not specified for the highest of these frequencies and still higher frequencies require the use of waveguide components.

The cavity resonator has a height of 4 mm and a diameter of only 8 mm. The couplings are formed from the 1.5 mm ends of the coaxial inner conductors (UT 141) shown in **fig. 11**. The free-space distance to the wall is 1 mm. The 3 mm thick tuning plunger is effected by a contact-less low-pass joint in a 3.1 mm drilling. The wall separation is stabilized by a teflon sleeve which has been split along its length. On account of the high resonant frequency the capacitance between plunger and resonator is sufficiently high.

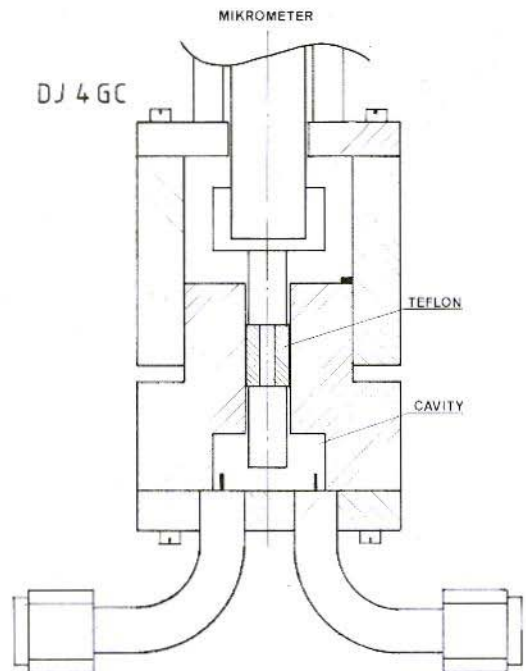

Fig. 9: Constructional details of filter No. 5

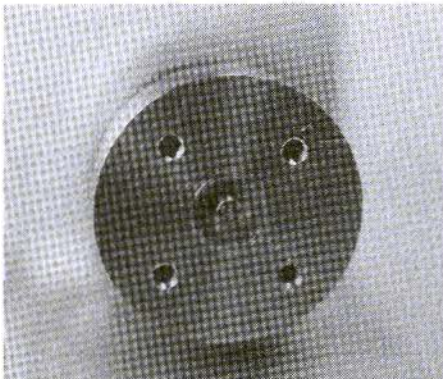

Fig. 10: Resonator cavity with tuning plunger

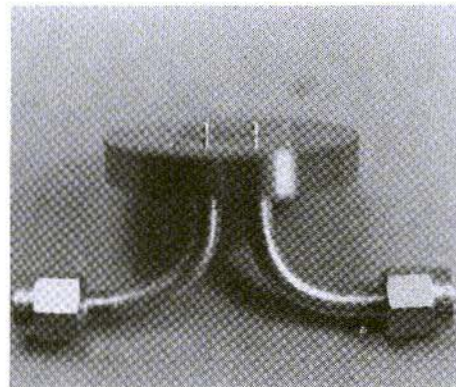
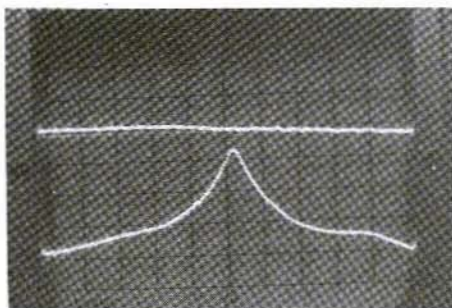
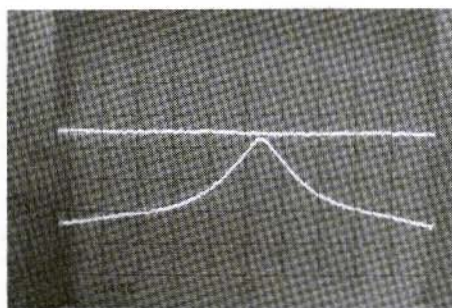

Fig. 11: 1.5 mm ends of the inner conductor of hard coax (UT 141) used as coupling probes

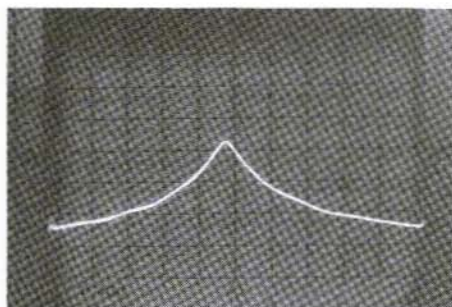



**Fig. 12:**  
**Filter No. 2, Centre frequency:**  
 432 MHz, h: 10 MHz / cm, V: 10 dB / cm  
 3 dB bandwidth: 3.9 MHz, Q = 110,  
 $I_L = 6.5$  dB



**Fig. 13:**  
**Filter No. 2, Centre frequency:**  
 1296 MHz, h: 10 MHz / cm, V: 10 dB / cm  
 3 dB bandwidth: 5.7 MHz, Q = 227,  
 $I_L = 1.6$  dB



**Fig. 14:**  
**Filter No. 2, Centre frequency:**  
 2320 MHz, h: 30 MHz / cm, V: 10 dB / cm  
 3 dB bandwidth: 15 MHz, Q = 155,  
 $I_L = 1.0$  dB

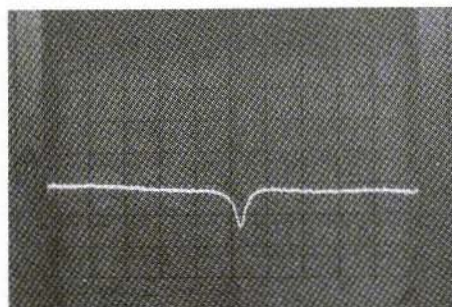

**Fig. 15:**  
**Return loss of filter No. 2 in 23 cm**  
**band, Centre frequency: 1296 MHz,**  
 h: 10 MHz / cm, V: 10 dB / cm



Using a micrometer plunger drive a backlash free tuning system is assured. The distance of the tuning plunger from the resonator end cap is indicated in one hundredths of a millimeter and may be related to frequency by means of a graph. The selectivity and tuning characteristics in the X - band are quite outstanding but at 24 GHz the stop band attenuation has deteriorated. The display of characteristics in these bands could not be carried out because no sweeper was available.

### 3. TEST RESULTS

The photographs of **figs. 12, 13 and 14** show the resonance characteristics of filter No. 2 (280 MHz - 2.9 GHz) which covers three amateur bands: 70 cm, 23 cm and 13 cm. On a few measurements, the zero dB reference line can also be seen. The selectivity is always better than 25 dB for all three amateur bands. It is sufficient, for example, to identify a 23 cm band local oscillator frequency at 1152 MHz at a level of 30 dB below the input signal.

The return loss for a high quality termination at 23 cm was measured at 12 dB (**fig. 15**). For specific applications, within an amateur band, the couplings can be optimized to improve the return loss at an acceptable insertion loss ( $I_L$ ).

The 50  $\Omega$  measurement bridge, described by DJ 7 VY, is simple to construct and can be used for measurements of return loss up to 2 GHz with a directivity of about 30 dB. Care must be taken, when using a wide band detector for this purpose, that a signal generator of high spectral purity is used. If necessary, use a filter on the generator output to ensure an accurate measurement which has not been falsified by generator spurious.

The responses of **fig. 16** are from the filter No. 3 (table 1) taken at 5.76 GHz.

The X - band filter No. 4 (**fig. 17**) 2.5 - 10.5 GHz has an insertion loss ( $I_L$ ) of 1.2 dB at 10.36 GHz. The bandwidth (3 dB) measured by a point-for-point process, was about 40 MHz. The oscillator signal separated by 144 MHz from 10.36 GHz receive frequency, was some 16 dB down on the mid-band attenuation.

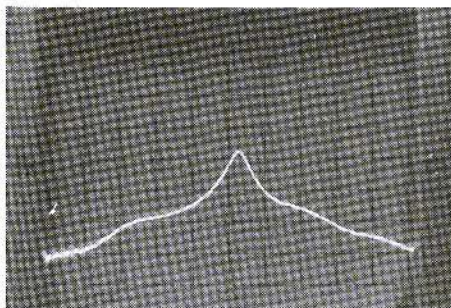

**Fig. 16: Filter No. 3, Centre frequency:**  
5.76 GHz, h: 100 MHz / cm, V: 10 dB / cm  
3 dB bandwidth: 35 MHz,  $I_L = 0.6$  dB

Two filters may be cascaded in order to improve the selectivity (**fig. 18**). If the familiar double-hump is apparent, caused by over-critical coupling, an attenuator, of say 6 dB, can be inserted between the two filters. In a specific case, this measure proved unnecessary as filter No. 3 in the 23 cm band already had quite a high insertion loss. The high adjacent selectivity was matched by an adequate stop-band rejection of more than 60 dB.

A suitable indicator on the filter output can be chosen from a spectrum analyser, a logarithmic detector or a thermic power meter. Extremes of

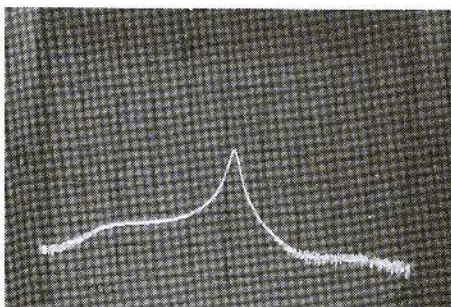

**Fig. 17: Filter No. 4, Centre frequency:**  
5.76 GHz, h: 100 MHz / cm, V: 10 dB / cm  
3 dB bandwidth: 22 MHz,  $I_L = 2.1$  dB

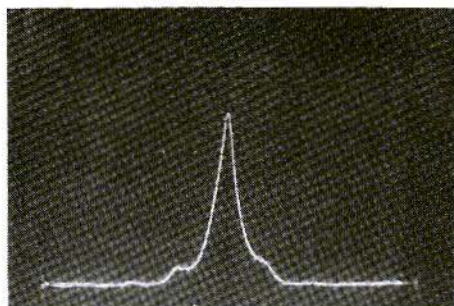

**Fig. 18: Filter 2 and Filter 3 in cascade,**  
Centre frequency: 1296 MHz,  
h: 30 MHz / cm, V: 10 dB / cm  
 $I_L$  (total) = 9.6 dB

power measurements can be aided by the use of a known-gain amplifier to boost weak signals in order that they fall within the dynamic range of the indicator. (Suitable diode detectors will be the subject of a later article).

This measurement system cannot compare with the ease and convenience of a spectrum analyser but it does exhibit similar results at a fraction of the analyser's cost.

#### 4. REFERENCES

- (1) Erwin Schäfer, DL 3 ER:  
A Wavemeter for the Frequency Range  
23.5 to 24.5 GHz  
VHF COMMUNICATIONS, Vol. 13,  
Ed. 4 / 1981, Pages 235 - 238
- (2) Erwin Schäfer, DL 3 ER:  
Chokes for Contactless Tuning of  
Waveguide Modules  
VHF COMMUNICATIONS, Vol. 13,  
Ed. 2 / 1981, Pages 105 - 107
- (3) Jürgen Dahms, DC Ø DA und  
Hans-J. Meise, DK 2 AB:  
10 GHz-SSB-Transverter  
Sonderdruck des DARC-Verlags
- (4) H.J. Woelky, DK 2 UO:  
Mikrowellenkomponenten aus rundem  
Standard-Cu-Rohr  
VHF-UHF Meeting booklet, München 1986
- (5) Hans-J. Meise, DK 2 AB:  
Resonatorfilter für die Bänder 9, 6 und 3 cm  
DUBUS-Informationen, Heft 1 / 1986



You can now order magazines, kits etc. using  
your **Eurocard** or **VISA Credit Card** !  
We only require the order against your  
signature, the card number and its expiry date.

VHF COMMUNICATIONS / UKW-BERICHTE



**UKW**berichte

Terry D. Bittan · Jahnstr. 14 · Postfach 80 · D-8523 Baiersdorf  
Tel. West Germany 9133 47-0. For Representatives see cover page 2



Erich Stadler, DG 7 GK

## Reflection Coefficient

The reflection coefficient expresses the relationship between the reflected voltage  $V_{\text{back}}$  to the incident voltage  $V_{\text{inc}}$ .

$$r = V_{\text{back}} / V_{\text{inc}}$$

If the end of the cable is terminated with an ohmic load resistor  $R_L$  the reflection coefficient may be given as: —

$$r = (R_L - Z_0) / (R_L + Z_0)$$

where  $Z_0$  is the characteristic impedance of the cable. At high radio frequencies, this may be taken as being a purely resistive quantity. This formula will be explained by the following numerical example.

The diagram shows a generator of open circuit voltage 20 V and an internal resistance of 50  $\Omega$ .

For the time being, it is not important how the other end of the cable is terminated. Only when the output is short-circuited or open-circuited, and connected to the generator, does the generator voltage drop to 10 V i. e. half the unloaded voltage. This comes about because the generator cannot know, at the instant of connection, how the end of the cable has been terminated. The open-circuit output voltage is halved between the generator internal resistance of 50  $\Omega$  and the characteristic impedance of the line 50  $\Omega$ . The 10 V applied to the line is the incident or forward voltage which is transmitted to the far end of the line. This forward voltage surge takes a finite time, in nanoseconds, depending upon the length of the line.

Together with the forward voltage wave of 10 V there is an associated forward current wave whose amplitude is given quite simply by Ohm's

law i. e. the  $V_{\text{inc}}$  across the  $Z_0$  causes a current  $10 \text{ V} / 50 \Omega = 0.2 \text{ A}$ . Taking a homogeneous, lossless line, the current and voltage amplitudes remain constant at all points along the line's length, and their relationship is at all points equal to the characteristic impedance  $Z_0$ . The phase of the wave, however, does change with respect to that at the line input but that will be considered later.

The voltage and current waves at the end of the cable have quite different relationships from these along the length of the line. The value of the termination resistance  $R_L$  alters the relationship between voltage and current to that which exists along the cable length because the termination  $R_L$  is 200  $\Omega$  and does not match the  $Z_0 = 50 \Omega$  of the cable. How can the incident wave be extracted from this predicament?

Does another current now exist at the termination

$$I_L = 10 \text{ V} / 200 \Omega = 0.05 \text{ A}$$

or another voltage

$$V_L = 0.2 \text{ A} \times 200 \Omega = 40 \text{ V?}$$

In fact, neither one is true.

The incident wave causes a reflected wave to be formed at the cable end which returns back along the line and is known as the return wave consisting of both voltage and current components. The special thing about the return wave is, however, that its voltage amplitude  $V_{\text{back}}$  and current amplitude  $I_{\text{back}}$  are formed in such a manner that **two** physical conditions are maintained:

a) The superimposed voltage amplitudes of incident and return waves form a relationship with the superimposed current amplitudes

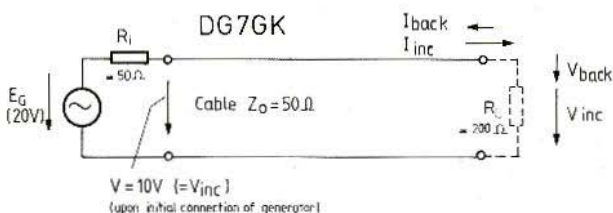

des of incident and return waves which must satisfy Ohm's law at the termination  $R_L$ .

- b) The ratio of voltage amplitude to current amplitude of the return wave must equal the characteristic impedance  $Z_0$  at all points along the line.

Considering the condition made in a):

As the value of the termination  $R_L$  is, in this numerical example, larger than the characteristic impedance  $Z_0$  of the line, the **superimposed voltage amplitude** resulting from incident and return components must be **greater** than the incident voltage alone, thus signifying that they are **in phase** with each other. At the same time, the **superimposed total current** must be smaller than that of the incident current at the termination end and the two current components, incident and return, must be in **antiphase** to each other.

In the calculation, Ohm's law is preserved by considering that at the  $200\ \Omega$  termination the following relationship must exist: -

$$(10\text{ V} + V_{\text{back}}) / (0.2\text{ A} - I_{\text{back}}) = 200\ \Omega$$

Considering the condition made in b):

It can be imagined that the reflected wave behaves exactly as if it had been injected at the point of reflection i. e. at the termination. The following is true for the return wave: -

$$V_{\text{back}} / I_{\text{back}} = 50\ \Omega$$

and therefore

$$I_{\text{back}} = V_{\text{back}} / 50\ \Omega$$

Inserting into the penultimate equation and transforming:

$$V_{\text{back}} = 10\text{ V} \cdot \frac{200\ \Omega - 50\ \Omega}{200\ \Omega + 50\ \Omega}$$

The 10 V is the amplitude of the incident wave  $V_{\text{inc}}$ , therefore

$$\frac{V_{\text{back}}}{V_{\text{inc}}} = \frac{200\ \Omega - 50\ \Omega}{200\ \Omega + 50\ \Omega}$$

but

$$V_{\text{back}} / V_{\text{inc}} = r \text{ the reflection coefficient}$$

If the characteristic impedance  $Z_0$  is larger than the load resistance  $R_L$ , then  $r$  is negative. It is now possible to define the reflection coefficient in terms of the characteristic impedance of the line and the load resistance.

$$r = \frac{R_L - Z_0}{R_L + Z_0}$$

#### Example:

The amplitude of the return wave

$$V_{\text{back}} = 10\text{ V} \cdot \frac{(200\ \Omega - 50\ \Omega)}{(200\ \Omega + 50\ \Omega)} = 6\text{ V},$$

and the return current  $I_{\text{back}} = 6\text{ V} / 50\ \Omega = 0.12\text{ A}$ .  $I_{\text{back}}$  is antiphase to  $I_{\text{inc}}$  as shown by the arrows in the diagram. Across the load resistance the two voltage components  $V_{\text{inc}}$  and  $V_{\text{back}}$  are additive  $V_L = 10\text{ V} + 6\text{ V} = 16\text{ V}$ . The resultant load current  $I_L = 0.2\text{ A} - 0.12\text{ A} = 0.08\text{ A}$ . Thus Ohm's law is satisfied:  $16\text{ V} / 0.08\text{ A} = 200\ \Omega$ ! The reflection coefficient is 0.6 i. e. 60%.

#### Special Case

The special case occurs when the resistance of the termination equals that of the characteristic impedance of the line. There is then no return



wave as all the forward wave is absorbed by the load termination and the reflection coefficient is zero. The relationship  $V_{inc} / I_{inc}$  equals the load resistance.

At the beginning it was mentioned that initially it was of no importance what sort of load was terminating the cable end. This must be more fully explained. A few nanoseconds after the reflected wave has been applied to the line, it arrives back at the generator. The incident and return waves superimpose and form voltage and current waves which, according to the type of termination and line length, can have any phase relation between + and - 180° with respect to the phase of the open-circuit voltage of the generator. The input voltage amplitude can vary between zero and that of the open generator voltage and the current amplitude can vary between zero and the generator short-circuited current. If then, for the purposes of explanation the initial values of current and voltage were not actually measured, it is because normal means of measuring these quantities is not possible within the first few nanoseconds after

connecting the line to the generator. If this information should be required then it is carried out by impulse reflectometry techniques. Another possibility would be to use directional couplers to measure both incident and return wave amplitudes.

### Reflection Coefficient Modulus and the Reflected Power

If the cable resistance is equal to the generator internal resistance, the generator attempts to deliver its maximum available power to the line. The reflected wave, however, carries a fraction (at full reflection, all) of the power back to the generator. The reflection coefficient is proportional to the return voltage. As the power is proportional to the square of the real part of the reflection coefficient,  $P_{back} = P_{max} \cdot r^2$ .

The power delivered to the termination load is therefore:  $P = P_{max} (1 - r^2)$ .

The reflection factor therefore provides a simple method of estimating the power delivered by the generator.

## Colour ATV-Transmissions are no problem for our new ATV-7011

The **ATV-7011** is a professional quality ATV transmitter for the 70 cm band. It is only necessary to connect a camera (monochrome or colour), antenna and microphone. Can be operated from 220 V AC or 12 V DC. The standard unit operates according to CCIR, but other standards are available on request.

The **ATV-7011** is a further development of our reliable ATV-7010 with better specifications, newer design, and smaller dimensions. It uses a new system of video-sound combination and modulation. It is also suitable for mobile operation from 12 V DC or for fixed operation on 220 V AC.

**Price** ..... **DM 2995.—**

The **ATV-7011** is also available for broadcasting use between 470 MHz and 500 MHz, and a number of such units are in continuous operation in Africa.



### Specifications:

Frequencies, crystal-controlled:  
 Video 434.25 MHz, Sound 439.75 MHz  
 IM-products (3rd order): better than - 30 dB  
 Suppression of osc.freq. and image:  
 better than - 55 dB  
 Power-output, unmodulated: typ. 10 W  
 Delivery: ex. stock to 8 weeks (standard model)



**UKWberichte** Terry D. Bittan · Jahnstr. 14 · Postfach 80 · D-8523 Baidersdorf

Tel. West Germany 9133 47-0. For Representatives see cover page 2



## BRIEFLY SPEAKING...

### To all users of TEC 200 foil

Improved proposals for the transfer of the PCB artwork to the laminated boards copper surface.

- Heat the board to a temperature of approximately 140° C by laying it upon a hotplate or an upturned smoothing iron.
- Upon the surface of the heated board now lay the TEC 200 foil which carries a facsimile of the diagram to be transferred.
- Roll the foil with a photographic roller and the printed circuit artwork will be transferred directly onto the PCB copper face, even when using light pressure. The results are considerably better than those achieved by pressing the foil onto the board by means of a smoothing iron.

Even the finest detailed lines will be cleanly and reliably transferred if the above procedure is adopted.

**Dr. Roland Milker,  
DL 2 OM**

### CFY 18: GaAs-FET to 15 GHz

With the CFY 18, Siemens have introduced a microwave transistor in a low-cost Cerec

housing for low-noise amplification of signals up to 15 GHz. Then GaAs-FETs (0.5  $\mu\text{m}$ ) are implanted on a two-inch disc and possess a typical noise figure of 2.1 dB at 12 GHz at a gain of 9.5 dB. The preferred application is for low-noise pre-amplifiers between 4 and 15 GHz for the impending direct broadcasting satellite service for "everyone".

Siemens Press Info.

### GaAs-FET S 3030

Much has been reported in these pages about the Schottky Double-Gate Gallium-Arsenide FET S 3030 and constructional articles for low-noise amplifiers for 144 MHz (VHF Comm. 2 / 82) and 432 MHz (VHF Comm. 3 / 82) have appeared. Now here is further information on this transistor:

The S 3030, in its improved version, went into largescale manufacture and is now offered at prices below DM 10.—. Especially interesting are the — so far unpublished— data about its upper frequency limit:

At 2.3 GHz and  $V_B = 10\text{ V}$ :  
 $P_{\text{out}} = +15\text{ dBm}$  (33 mW)  
 $G_p = 10 - 12\text{ dB}$

The semi-conductor structure is now twice as large, and thereby robuster than with comparable types from other manufacturers. The marking changed in early 1985 from S 3000 to S 3030.

In 1984 a T. I. book "Applications Book No. 4", again by J. Schuermann, DJ 1 SK, was published. It is devoted to

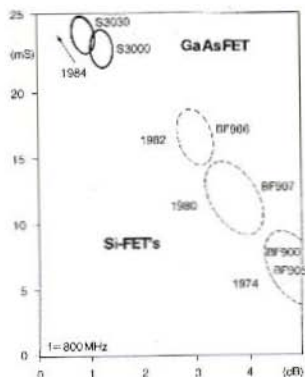

VHF / UHF gallium-arsenide technology which had recently commenced with the S 3000 / 3030. The following themes are discussed in 80 pages:

- Technology, structure and behaviour, bias and amplification rules, noise, amplification and intermodulation in applications at 900 - 1000 MHz, RF amplifiers for UHF, low-noise pre-amplifiers for 144 MHz and 432 MHz (VHF Communications re-print), test circuit, reliability test results, data sheets.

The book is written in English and costs DM 15.80, obtainable from VHF COMMUNICATIONS.

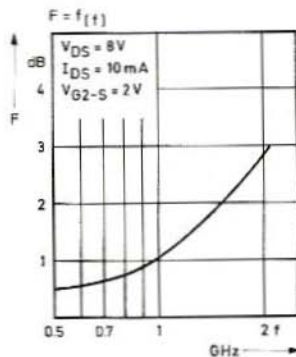

# MATERIAL PRICE LIST OF EQUIPMENT

described in edition 3 / 1986 of VHF COMMUNICATIONS

DC 2 CS	IF Amplifier and Demodulator for Wideband FM	Art. No.	Ed. 3/1986
PC-board	DC2CS 001 double-sided, through-plated	6953	DM 38.—
Components	DC2CS 001 2 Avantek amps., 3 Plessey ICs, 6 transistors, 3 diodes, 1 coil, 2 chokes, 15 ceramic and 4 electrol. caps, 17 resistors, 1 preset, 7 solder pins, 4 DF caps, 3 PTFE feed- throughs, 1 tin-plated case	6955	DM 212.—
SAW filter	SW 504	6954	DM 118.—
Kit	<b>DC2CS 001 complete with all above parts</b>	<b>6856</b>	<b>DM 350.—</b>
<b>YU 3 UMV</b>	<b>Microstrip Transverter for 23 and 13 cm</b>		<b>Ed. 2-3/86</b>
PC-board	YU3UMV 004 Receive converter 1296 / 144 MHz double-sided, undrilled, silvered	6960	DM 25.—
PC-board	YU3UMV 005 Receive converter 2320 (2304) / 144 MHz double-sided, undrilled, silvered	6961	DM 25.—
PC-board	YU3UMV 006 Transmit converter 144 / 1296 (1270) MHz double-sided, undrilled, silvered	6962	DM 25.—
PC-board	YU3UMV 007 Transmit amplifier for 1296 (1270) MHz double-sided, undrilled, silvered	6963	DM 19.50
PC-board	YU3UMV 008 Transmit converter 144 / 2320 (2304) MHz double-sided, undrilled, silvered	6964	DM 25.—
PC-board	YU3UMV 009 Selective transmit amplifier for 2320 (2304) MHz double-sided, undrilled, silvered	6965	DM 19.50
PC-board	YU3UMV 010 Transmit amplifier, antenna switch and receive pre-amplifier for 2320 (2304) MHz double-sided, undrilled, silvered	6966	DM 25.—
PC-board	YU3UMV 011 Antenna switch for 1296 MHz double-sided, undrilled, silvered	6967	DM 19.—
PC-board	YU3UMV 012 Antenna switch for 2320 (2304) MHz double-sided, undrilled, silvered	6968	DM 16.50
PC-board	YU3UMV 013 Oscillator module 32 (45) MHz crystals single-sided, undrilled with component plan	6969	DM 20.—
PC-board	YU3UMV 014 Oscillator module 96 (90) MHz crystals single-sided, undrilled with component plan	6970	DM 19.—





PC-board	YU3UMV 015 Change-over switch for oscillator modules single-sided, undrilled with component plan	6971	DM 17.—
PC-board	YU3UMV 016 VOX module, single-sided, undrilled with component plan	6972	DM 20.—

### Components for the PC-boards YU 3 UMV 004 to 016

Type / equivalent	Art. No.	1 piece DM	10 pieces DM	
BA 182, BA 243	switching diode	9005	1.00	8.00
BA 379, BA 479	PIN diode	9581	4.00	32.00
1 N 4001, 1 N 4007	rectifier	9100	1.00	8.00
1 N 4148, 1 N 4151	switching diode	9101	0.50	4.00
OA 95, AA 118	Ge-diode	10012	1.00	8.00
7 V 5	Z-diode	9040	1.50	10.00
BC 213, BC 415	PNP-NF-trans.	9010	1.00	8.00
BC 237, BC 413	NPN-NF-trans.	9527	1.00	8.00
BF 152, BF 199	HF transistor	9016	1.00	8.00
BF 245 C	FET	9019	2.00	15.00
BFQ 34	UHF power-transistor	9699	40.00	360.00
BFQ 69	low-noise UHF trans.	9577	8.50	76.50
BFR 34 A	UHF transistor	9023	10.00	75.00
BFR 96	UHF low-power trans.	9025	11.00	80.00
BFT 65	low-noise wide-band trans.	10009	5.75	51.75
BFW 92	UHF low-power trans.	9533	5.00	45.00
TIP 32, BD 436	PNP power-transistor	9528	3.25	29.00
2 N 5944	UHF power-transistor	9573	70.00	650.00
CD 4049	C-MOS inverter	9697	2.50	20.00
Foil trimmer 10 p (yellow)		9214	1.00	8.00
Foil trimmer 20 p (green)		9215	1.00	8.00
Crystal 32.000 MHz for 144 / 1296 MHz		6235	26.00	230.00
Crystal 45.333 MHz for 144 / 2320 MHz		6236	26.00	230.00
Crystal 90.000 MHz for 144 / 2304 MHz		6237	26.00	230.00
Crystal 90.666 MHz for 144 / 2320 MHz		6234	26.00	230.00
Crystal 96.000 MHz for 144 / 1296 MHz		6224	26.00	230.00

**Further components upon request**



# Weather Satellite Receive Systems

for private or professional use

NEW 10 image memories display NEW  
NEW - in colour, if desired - NEW  
NEW (storage capacity 4 MBit) NEW



This new Compact System offers...

- modular design, allowing extension
- movie display with the aid of 10 (!) image memories
- programmable automatic reception
- brilliant colour images
- zooming
- digital data output (optional)

More information available at:



Weather Satellite Systems

## UKWtechnik

Terry Bittan Vertriebs-GmbH

Tel. (09133) 47-0

P.O. Box 80 - Jahnstraße 14

D - 8523 Baiersdorf (W. Germany) Telex 629887

**UKW alpha**  
**UKW beta**  
**UKW gamma**  
**UKW delta**

Complete System

UKW alpha

from DM 4,950.-

including: antenna, converter  
receiver, 1 image memory,  
monitor, interconn. cable



METEOSAT-Image C 02

New · New · New · Now available ex stock

## Interface „slave 10“

for the satellite rotator systems  
KR 5400 and KR 5600

**Stock-Nr. 1001 DM 590.—**  
(incl. connection cable)

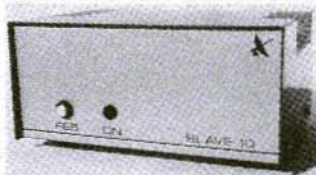

- fully-automatic antenna tracking system for satellite communications
- connection to any computer possible via RS 232
- resolution of the dual-channel A / D converter amounts to 10 bits
- OSCAR 10 software for the C 64 available
- connection to existing rotator systems possible

### Table of commands:

command		response		function
R	CR	R	CR	rotation clockwise
L	CR	L	CR	rotation counter clockwise
U	CR	U	CR	rotation up
D	CR	D	CR	rotation down
S	CR	S	CR	all rotators stop
V	CR	V	CR	rotator stop vert.
H	CR	H	CR	rotator stop horiz.
G xxxxyyy	CR	G	CR	preset position
F	CR	F xxxxyyy	CR	interrogation position

xxxx: Vertical position (4 digits)  
yyyy: Horizontal position (4 digits)  
CR: CARRIAGE RETURN

### Technical data:

Data exchange: 3-wire asynchron. full duplex  
input and output negative or positive

Data format: 1 start bit  
8 data bits  
2 stop bits

Baud rate: 1200 B / s

Power supply: 14 V unstab. via control box  
KR 5400 or KR 5600

Dimensions: w x h x d = 160 x 80 x 130 mm

### Special accessories:

Software on diskette for C 64

Art. nr. 1100

DM 48.—

### Satellite rotator systems:

KR 5400  
KR 5600

Art. nr. 1013  
Art. nr. 1014

DM 809.—  
DM 1070.—

### System's block diagram

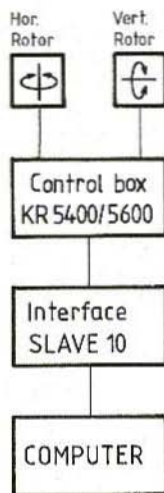

# You should know what's behind our sign

We are the only European manufacturers of these **Miniature TCXO's**

**CCO 102, CCO 103,  
CCO 104, CCO 152**  
**modulable table**

higher stability than a quartz crystal:  
less than  $\pm 3$  ppm over the temperature range  $-30$  to  $+60^\circ\text{C}$ . (types B)

low ageing rate:  
less than 1 ppm per year.

wide frequency range:  
10 MHz to 80 MHz

low supply voltage:  
 $+5$  V

low current consumption:  
3 mA max. (series CCO 102)

small outlines: CCO 104 =  $2,6 \text{ cm}^3$ , CCO 102/152 =  $3,3 \text{ cm}^3$ ,  
CCO 103 =  $4,0 \text{ cm}^3$

widespread applications e.g. as channel elements or reference oscillators in UHF radios (450 and 900 MHz range)

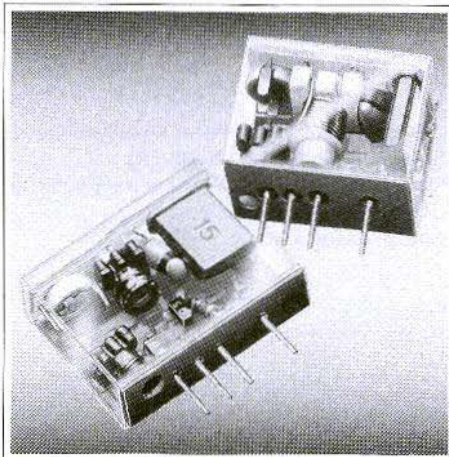

Our R + D engineers are constantly working with new technology to develop new products. We can offer technical advice for your new projects or manufacture against your specification.

**Quartz crystal units in the frequency range from 800 kHz to 360 MHz Microprocessor oscillators (TCXO's, VCXO's, OCXO's) crystal components according to customer's specifications**

Types	CCO 102			CCO 103			CCO 104		
	A	B	F	A	B	$\Gamma$	A	B	F
Freq. range	10-80 MHz			6.4-25 MHz			10-80 MHz		
stability vs temp. range	$-30$ to $+60^\circ\text{C}$			$-30$ to $-60^\circ\text{C}$			$-30$ to $+60^\circ\text{C}$		
Current consumption	max. 3 mA at UB = $+5$ V			max. 10 mA at UB = $+5$ V			max. 10 mA at UB = $+5$ V		
input signal	-10 dB/50 Ohm			TTL-compatible (Fan-out 2)			0 dB/50 Ohm		

**CCO 152 A + B**  
same size as CCO 102 A + B  
modulation input: typ. 1 kHz/V  
deviation: DC to 10 kHz  
mod. frequency: 20 k Ohm  
impedance:

**TELE QUARZ**

... Your precise and reliable source

TELE-QUARZ GMBH · D-6924 Neckarbischofsheim 2  
Telefon 07268/801-0 · Telex 782359 tq d · Telefax 07268/1435