



*A Publication for the
Radio Amateur Worldwide*

*Especially Covering VHF,
UHF and Microwaves*

VHF COMMUNICATIONS

Volume No.25 . Spring . 1/1993 . £3.75

**DOPPLER DF
ARRAY
Burchard**

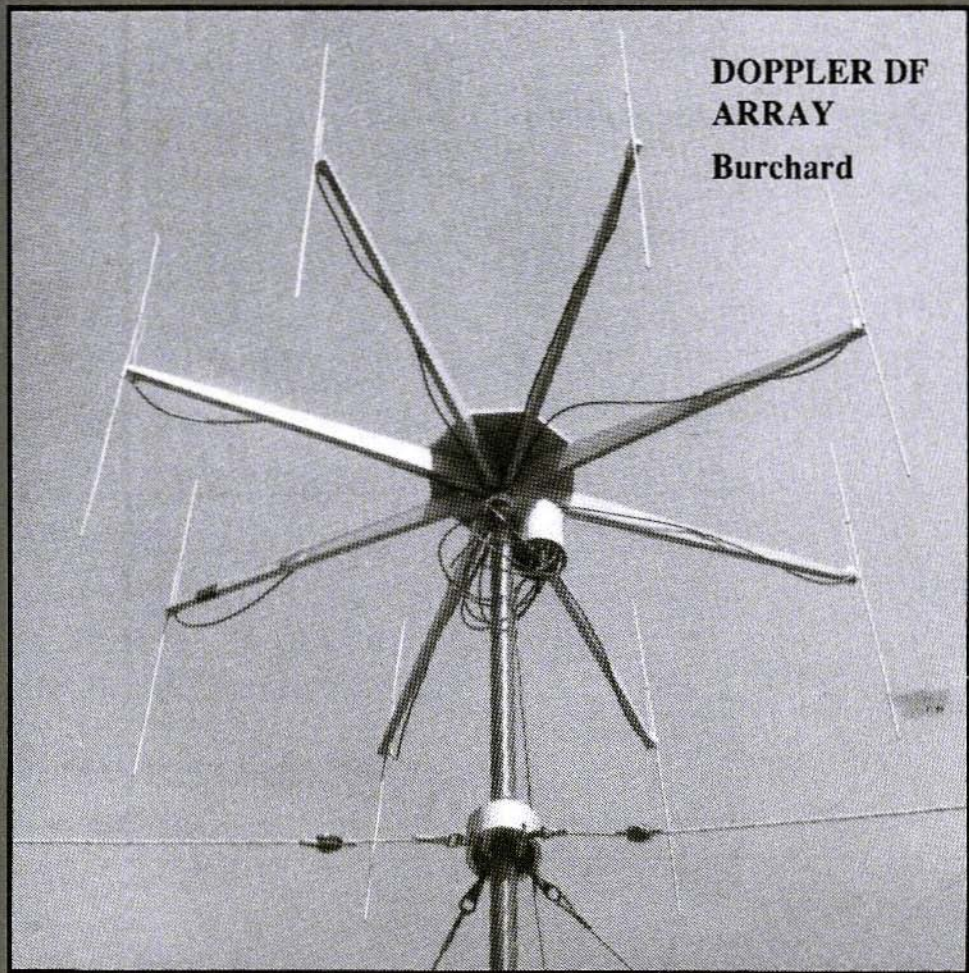



VHF COMMUNICATIONS

A Publication for the Radio Amateur Worldwide

Especially Covering VHF, UHF and Microwaves

Volume No. 25 Spring Edition 1/1993

Published by: KM PUBLICATIONS,
5 Ware Orchard, Barby, Nr.Rugby,
CV23 8UF, United Kingdom.

Publishers: KM PUBLICATIONS

Editors: Mike Wooding G6IQM
Krystyna Wooding

Advertising Manager: Mike Wooding G6IQM

VHF
COMMUNICATIONS

The international edition of the German publication UKW-Berichte is a quarterly amateur radio magazine especially catering for the VHF/UHF/SHF technology. It is owned and published in the United Kingdom in Spring, Summer, Autumn and Winter by KM PUBLICATIONS.

The 1993 subscription price is £13.00, or national equivalent. Individual copies are available at £3.75, or national equivalent each. Subscriptions and orders of individual copies of the magazine should be addressed to the national representative, or - if not possible - directly to the publishers. All other enquiries should be addressed directly to the publishers.

Back issues, kits, as well as the blue plastic binders are obtainable from your national representative or direct from KM Publications.

© KM
PUBLICATIONS

All rights reserved, reprints, translations, or extracts only with the written approval of the publishers.

Translated by: Mr. A. Emmerson
G8PTH, 71 Falcott Way,
Northampton, NN2 8PH, U.K.

Printed in the United Kingdom by
Apex Print, P.O. Box 111, 19
Church Street, Rugby, CV21 3PG.

Please address your orders or
enquiries to your representative.

REPRESENTATIVES:

AUSTRIA - Verlag UKW-BERICHTE, Terry D. Bittan, POB 80,
D-8523 BAERSDORF, Germany. Telephone: (9133) 47-0.
Telex: 629 887. Postgiro Nbg: 30455-858. Fax: 09733 4747.

AUSTRALIA - W.J.A., P.O. Box 300, SOUTH CAULFIELD, 3162
VIC, Australia. Telephone: 528 5962.

BELGIUM - UKW-BERICHTE, P.O. Box 80, D-8523,
BAIERSDORF, Germany. Tel: 09133 47 0.
Postgiro Nbg: 30455-858. Fax: 09133-4747

DENMARK - KM PUBLICATIONS, 5 Ware Orchard, Barby,
Nr.RUGBY, CV23 8UF, U.K. Tel: +44 788 890365.
Fax: +44 788 891883

FRANCE - Christianne Michel F5SM, SM ELECTRONIC,
20 bis Avenue des Clarions, F-8900 AUXERRE, France.
Telephone: (86) 46 96 59

FINLAND - PETER LYTZ, OH2AVP, Yläkauttanonkuja 5 A 9,
SF-02360 ESPOO, Finland

- SRAT, pl 44, SF-00441 HELSINKI, Finland.
Telephone: 358/0/5625973.

GERMANY - UKW-BERICHTE, P.O. Box 80, D-8523
BAIERSDORF, Germany. Tel: 09133-47-0. Postgiro: 30455-858

GREECE - C+A ELECTRONIC, P.O. Box 25070, ATHENS 100 26,
Greece. Telephone: 01 52 42 867. Fax: 01 52 42 537.

HOLLAND - KM PUBLICATIONS, 5 Ware Orchard, Barby,
Nr.RUGBY, CV23 8UF, U.K. Telephone: +44 788 890365.
Fax: +44 788 891883

ITALY - ADB ELETTRONICA di Luchesi Fabrizio IW5ADB,
Via del Cantone 714, 55100 ANTRACCOLI (LU), Italy.
Telephone: 0583 952612.

NEW ZEALAND - Peter Mott, AUCLANDVHF GROUP Inc.,
P.O. Box 10 138, AUCLAND 1030, New Zealand.
Telephone: 0 9-480-1536

NORWAY - HENNING THEG RADIO COMMUNICATION
LA4YG, Kjøjeveien 30, 1370 ASKER, Norway.
Postgirokonto: 3 16 00 09

SOUTH AFRICA - HI-TECH BOOKS, P.O. Box 1142, RAND-
BURG, Transvaal 2125, South Africa. Telephone: (011) 886-2020.

SPAIN & PORTUGAL - JULIO A. PRIETO ALONSO EA4CJ,
Donoso Cortés 58 55-B, MADRID-15, Spain. Telephone: 543.83.84

SWEDEN - LARS PETTERSON SM4IVE, Pl. 1254, Smögården,
Täby, S-17500 ODENSBACKEN, Sweden. Telephone: 19-50223

SWITZERLAND - TERRY BITTAN, Pöschl, ZÜRICH,
Switzerland.

UNITED KINGDOM - KM PUBLICATIONS, 5 Ware Orchard,
Barby, Nr.RUGBY, CV23 8UF, U.K. Telephone: 0788 890365.
Fax: 0788 891883.

U.S.A. - WYMAN RESEARCH Inc., RR#1 Box 95, WALDRON,
Indiana 46182, U.S.A. Telephone: (317) 525-6452.

- Henry Ruh, ATVQ MAGAZINE, 1545 Lee Street, Suite 73,
Des Plaines, IL 60018, U.S.A. Tel: (708) 298 2269.
Fax: (708) 291 1644

ELSEWHERE - KM PUBLICATIONS, address as for the U.K.

ISSN 0177-7505



Contents

Detlef Burchard	Doppler Direction Finder with	2 - 18
Volker Espel DF9PL	High-Stability, Low-Noise Power Supply	19 - 37
Dr-Ing. Jochen Jirrmann DB1NV Wilfried Hercher DL8MX	Improvement of the Intermodulation Performance of modern Amateur HF Receivers	38 - 43
Dr-Ing. Jochen Jirrmann DB1NV	A Digital Framestore for the Spectrum Analyser: alterations and additions	44 - 47
Wolfgang Schneider DJ8ES	SSB Transceiver for 50 MHz 50Ω Modules Part-2	48 - 57
The Editors	Poor man's CAE 1 & 2 Public Domain Software Development Programs for the IBM PC	58 - 60



KM Publications, 5 Ware Orchard, Barby, Rugby, CV23 8UF, U.K.

Telephone: U.K: 0788 890365; INT: +44 788 890365. FAX: 0788 891883



Detlef Burchard, Box 14426, Nairobi, Kenya

Doppler Direction Finder with Improved Characteristics

Starting in the late 1970s in the USA and the early 1980s in Germany, ideas were published for a simple direction finding system using the Doppler principle, which looked affordable by amateurs. As examples we can take the work of Rogers (3) and Zopp (4). In the USA indeed corresponding firms were established - for example Doppler Systems (6) - which produced direction finding systems of this kind for their special circle of customers. Somewhat previously manufacturers of RF apparatus had already started to use the Doppler system commercially for direction finding, for example the Bendix Corporation in the USA and Rohde & Schwarz in Germany.

I first became interested in these system in 1986 because they could be employed successfully in wildlife research. Price in this connection is extremely important, because research into biology or ethology doesn't attract defence sector-type budgets!

So we were looking for a low cost solution, closer to the amateur kind than a high-end product. Familiarity with amateur hardware revealed so many inadequacies in this apparatus that it seemed worthwhile studying the basic principles and developing a new concept. Meanwhile a new system of wild animal study was ready to put into service; details can be read in reference (1). The system is not immediately suitable for use in the amateur field. All the same, the principles used are identical so the following are some suggestions which could lead to an amateur Doppler direction finder which works well with high accuracy.

The details following assume that the reader has a basic understanding of how Doppler direction finding works and has perhaps read the publications of Rogers (3) and Zopp (4) or has even built a Doppler of this kind. Here I will restrict myself to questions handled too briefly in the named publications and that are critical to good operation. So we'll be dismissing the

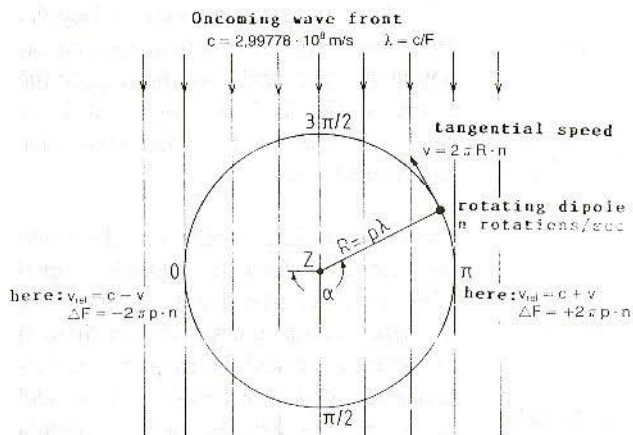

Fig.1:
The conventional but technically incorrect deviation of the Doppler effect from the rotation of a dipole in a homogenous electromagnetic field

frequently cited theory of the rotating dipole and presenting what really goes on; we'll report on the nasty habits of commutators and indicate a better method; finally mentioning the requirements placed on the IF amplifier and oscillator of the receiver as well as the filtering of the Doppler signal following demodulation. Physics and mathematics cannot be kept out of this entirely; some figures will give a clue to the orders of magnitude to be expected.

1. THE ROTATING DIPOLE

In figure 1 a dipole is sketched, whose long axis is in line with the E-plane of an oncoming wave (vertical to the page in this illustration). In the H-plane it rotates around a central point Z. The radius of the circle of rotation is given as a multiple p of the wavelength. Equivalent or similar drawings are also found in Rogers (3) and Zopp (4) to illustrate that the speed relationship between dipole and wave on the left-hand side ($\alpha = 0$) is smaller and on

the right-hand side ($\alpha = \pi$) than with a dipole at rest or in the upper or lower position ($\alpha = \pi/2; 3\pi/2$). Simple consideration brings us to the resulting Doppler frequency deviation

$$\Delta F = \pm \frac{2\pi \cdot R \cdot n \cdot F}{c} = \pm 2 \cdot \pi \cdot p \cdot n \quad (1)$$

The form of this deviation is a sine wave, requiring no further explanation. Had we been concerned with waves that propagate themselves relatively slowly, e.g. sound waves - with which Christian Doppler (1803-1853) made the discover that is named after him - then there would be nothing more to say. But we are working with electromagnetic waves which propagate at the speed of light. And for this the "principle of the constancy of the speed of light" is valid, as discovered by Albert Einstein (1879-1955). Even if you don't remember much of the theory of relativity from your schooldays, the rule that you cannot exceed the speed of light may stand out still. Yet that's what we have assumed in Fig.1 by taking $\alpha = 3\pi/2$.

The correct evaluation can be sought following the rules of relativity set out by

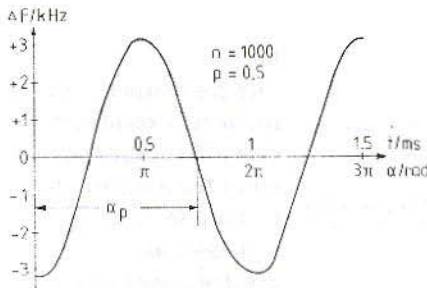

Fig.2: The Doppler frequency of a rotating dipole

Henrik Antoon Lorentz (1853-1928) in his transformation, which demands a lengthy demonstration which I'll do without here. In any case, it comes to the same solution as in equation (1) apart from a correction factor $\sqrt{(1-v^2/c^2)}$. The correction factor is in the realms of parts per million if one assumes v in technical reality around 10^3 m/s, whilst thanks to nature being in a good mood, c amounts almost exactly to $3 \cdot 10^8$ m/s. Anyone possessing a pocket calculator with sufficient decimal places can reach back to the measurements of Albert Abraham Michelson (1853-1931) and his students, who got $2.99778 \cdot 10^8$

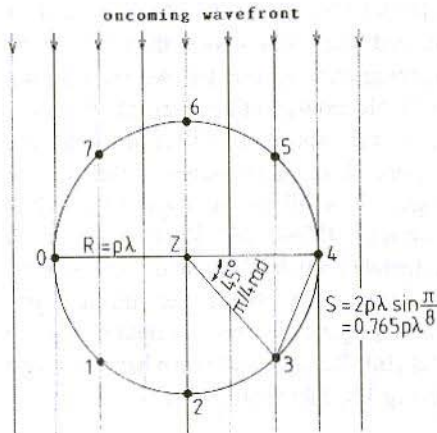

Fig.3: Arrangement of eight antennas in a circular group

m/s. There is also a transversal Doppler effect, which produces a frequency deviation in the upper and lower position of the dipole of fig. 1. This component is so small, however, that it can remain outside our calculations.

This excursion into physics should serve to find out what form the Doppler signal takes. We know now that it is a sine-wave frequency modulation with the modulation frequency $f = n$ and the frequency deviation according to equation (1) if the model of fig. 1 is usable. An example should make the matter clearer. With $n = 100\text{Hz}$ and $p = 0.5$ $\Delta F = 3142\text{Hz}$. This function is drawn in fig. 2.

Direction finding of the azimuth α_p of the angle between the null direction ($\alpha = 0$) and the direction of the oncoming wave is found by measuring the time or the angle of the null respectively reference point until the Doppler signal passes through zero and becomes negative in value. Developed systems of a simple kind according to references (3), (4) and (6) are certainly far removed from this model; more complex systems such as Rohde & Schwarz (5) differ significantly too. This is because the rotating dipole is replaced by a circular group of antennas which are scanned in rotation.

2. THE SCANNED CIRCULAR GROUP

Receiving dipoles set up at random in a field where waves are passing will deliver sine-wave voltages of a frequency $F = c/\lambda$.

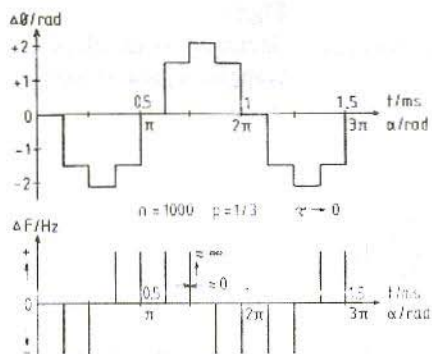

Fig.4: Phase deviation (a) and frequency deviation (b) of a circular group being scanned by rapid switching

If we scan a number of them sequentially no kind of change in frequency can be detected. All the same, there is a change of phase generally occurs in the switch-over interval. If we take two dipoles erected in the direction of radiation a multiple of the wavelength apart, their output signal will exhibit not only the same frequency but also the same phase. If we want to detect phase relationships in an unambiguous fashion, we must restrain the separation range of our antenna layout to less than a wavelength, which means $p < 0.5$. After this, the behaviour of the scanned antenna group changes fundamentally from that of a single antenna moved around. It is questionable whether the phenomena that occur then can even be called the Doppler effect.

Fig.3 shows a circular group of eight antennas. This figure was optimal for my application and would also be no bad choice for the radio amateur. It is better than a primitive system of four antennas and far less trouble than a large-scale

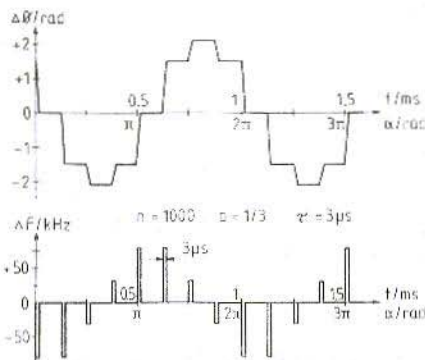

Fig.5: Phase deviation (a) and frequency deviation (b) of a circular group being scanned by unabrupt switching.

set-up as described in (5). If we select $p = 1/3$, the phase deviation curve becomes a staircase as in fig. 4a. This presupposes that switching between the antennas is as fast as we want, which can be achieved closely by using switching diodes such as BA244 for approx. 10ns switching times. The advantage of these diodes is their extraordinarily low insertion loss at 50 ohms - one achieves values below 0.05dB. The frequency deviation is the differential quotient of the phase deviation

$$\Delta F = \frac{1}{2\pi} \cdot \frac{d\Phi}{dt} \quad (2)$$

and is illustrated in fig. 4b. Entirely expectedly, it takes the form of needle pulses of the greatest size and disappearing widths (Dirac pulses). A discriminator for evaluating frequency modulation of this kind must be extremely broadband, even in the situation where an integrator is connected afterwards to maintain the staircase-form $\Delta\Phi$ curve. Comparing Fig.2 with fig. 4a, an approximate phase shift of $\pi/2$

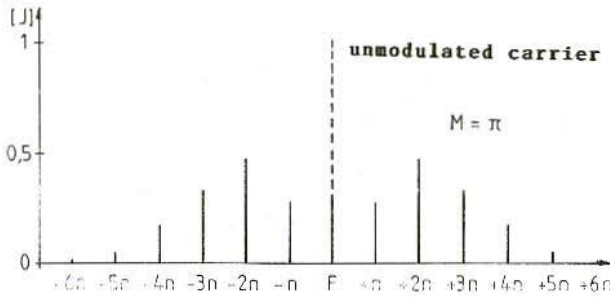

Fig.6:
Spectrum of an ideal
Doppler signal according
to Fig.2

appears between the ΔF curve of the rotating dipole and the $\Delta\phi$ curve of the scanned circular group. If the same phenomenon is affecting both signals, that is exactly what we would expect from equation (2). To begin with, we cannot get anything from the ΔF curve of the scanned circular group. The assumption is that the sum of all the levels encompassed by the Dirac pulses coincide with the levels below the curve of Fig.2. But $\infty \cdot 0$ can eventually produce every value! If we demodulate with an extremely broad FM demodulator (using a deviation meter with a linear region of plus or minus 500 kHz for example) and afterwards connect a bandpass filter for the frequency of rotation, then in fact we can measure a deviation of plus or minus 2000 Hz or so, which agrees with equation (1) and $p = 1/3$. Is this a Doppler effect then?

The ΔF curve from fig. 4b cannot be handled with narrowband receivers, also it is totally impossible to determine the point of passing through zero into the negative direction. The reason is the narrowness and height of the pulses, which must have something to do with the switching time of the switching diodes.

There is some benefit in slower switching

times. Suppose we take PIN diodes, as used in all the instruments of (3), (4), (5) and (6). The resulting curves for ΔF and $\Delta\phi$ are seen in Fig.5. The resulting signal can be processed in an broadband FM receiver - no solution for the radio amateur. A narrowband receiver would suppress significant components of the resulting spectrum, bringing in a reduction of and distortion to the deviation. The direction finding result would be unsatisfactory and dependent on the fortuitous position of individual spectral lines in the throughpass region and on the edges of the selectivity curve because, and this holds for all FM channels, linear distortion at IF level brings about non-linear distortion at audio frequencies. Despite this, a kind of Doppler effect is produced, otherwise instruments like (3), (4) and (6) would be totally unable to work.

3. THE DOPPLER SPECTRUM

It is easy to indicate the spectrum of an ideal signal as in Fig.2. If the measurements can be maintained in the same relationship to the wavelength, then the deviation of the Doppler frequency is

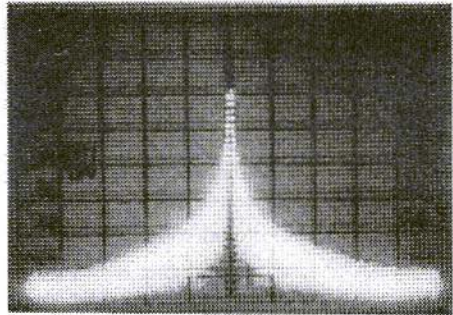
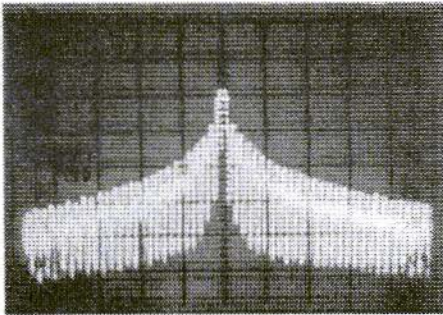

Fig.7: Spectrum of the 'Doppler signal' of the circular group scanned with a PIN diode
a. X: 20kHz per division. Derivation time = 5 seconds. Bandwidth analysed = 1 kHz. Video filter 1 kHz
b. X: 200 kHz per division. Derivation time = 5 seconds. Bandwidth analysed = 10 kHz. Video filter 1 kHz
Y is 10dB per division in both pictures

dependent only on the rotational frequency n . The modulation index resulting is thus

$$M = 2 \cdot \pi \cdot p \quad (3)$$

for the value of p shown in fig. 2 equal to π . We are dealing with broadband FM ($M > 1$) then for as long as $p > 1/2 \pi = 0.159$. Calculation of the lines of the spectrum is carried out in the customary way with the help of Bessel functions and is demonstrated for $M = \pi$ in Fig.6.

Commonplace IF filters in amateur telephony receivers have a bandwidth of plus/minus 6 kHz. The spectrum of Fig.6 is valid as long as n does not exceed 1000 Hz, leaving even 1 kHz in reserve for mistuning. This is only one criterion for the selection of n ; we will meet others later.

For the best results the IF filter should be optimised for flat transit time, for transit time distortion can also lead to non-linear distortion in the demodulated Doppler

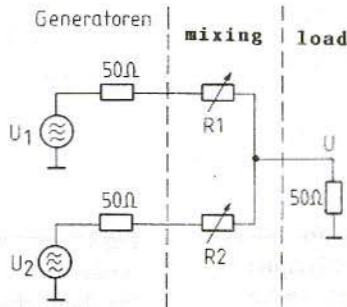
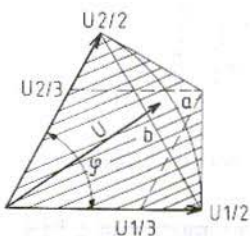

Fig.8: Mixing two generators with the same frequency but different phase

signal. They cause tuning-related variations in the bearing value, increasing with n^2 . If variations of the bearing indication are established with only slight mistuning, then a lower value of n must be chosen or else a more suitable filter should be used. It often helps to improve the input and output termination of the filter already installed.

Instead of calculating the signal spectrum from scanning a circular group, which is not possible with precision on account of the unknown actual switching performance of the PIN diodes used, we show in Fig.7 properly measured spectra. The frequency scale in both illustrations is not suited for resolving a Doppler signal. On the other hand, they show that a very broad spectrum is produced which is fully demonstrable at an interval of plus/minus 1 MHz. That would not be bad if at the receiver input there was really only one frequency on hand whose source we wanted to home in on. Fig. 7a shows that 90 per cent of the energy of the spectrum lies within plus/minus 7 kHz and 99% of this energy is

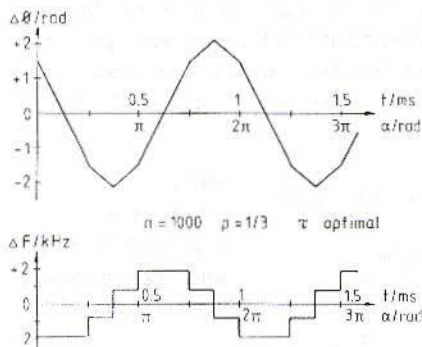

Fig.9: Best curve forms for phase deviation (a) and frequency deviation (b) that can be achieved by optimised mixing

within plus/minus 25 kHz. Both values are sufficient for establishing a close approximation of the Doppler frequency deviation, naturally better in the second case than in the first. This explains the method of operation of the instruments of (3), (4) and (6).

In practice, the antenna group picks up a quantity of other transmitters whose frequencies can differ either a little (e.g. 20 kHz) or a lot (several MHz) from the frequency in question. All are provided with a spectrum as in Fig.7 by the PIN diode commutator. Resulting sidelines will fall within the channel under investigation and will produce interference. The receiver, which previously exhibited 80dB selectivity against neighbouring channels, now shows only 18dB (Fig7a). Strong

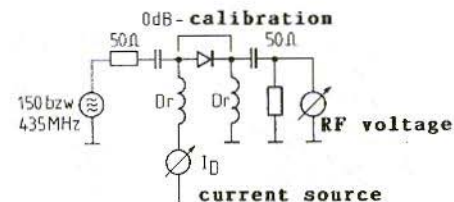
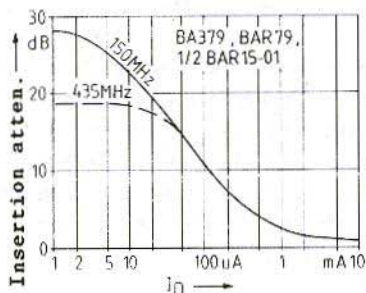

Fig.10: Insertion attenuation of a PIN diode switch showing dependency to the diode direct current: measurement circuit



out-of-band transmitters (aeronautical, PMR, etc.) will overpower weak desired signals. In short, the receiver has to a large extent lost its characteristic of suppressing unwanted signals. This is the actual reason why instruments working in this fashion cannot give satisfactory results.

In fact it is superfluous to say that apparatus of type (5) are free of the effects described. For most radio amateurs, however, it is only affordable when it turns up surplus or at a flea market. People who are not prepared to wait, or want to build their own or else would like to "supercharge" their existing inadequate Doppler equipment should read on.

Anyone who can afford high-end equipment will find plenty to read in Grabau and Pfaff (2), covering among other things bearing errors in multiple reception, determining the elevation of the incoming wave and complex evaluation techniques. This book appears to me to be the most recent pronouncement on the state of this technology. Here I just want to go as far as achieving the best Doppler signal with the least effort.

4. THE RIGHT COMMUTATOR

That actual switching between antennas should not be allowed should now have become clear. The problem of achieving a signal transition between antennas such that the ΔF curve comes out as in Fig.2 can be reduced by mixing a generator with another of the same frequency but different phase. We can examine this in fig. 8.

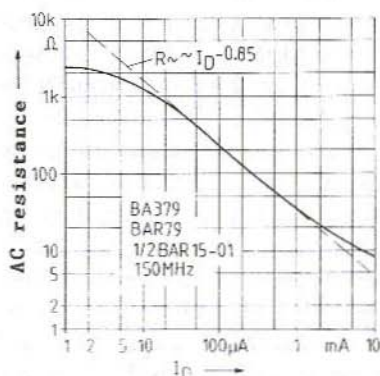

Fig.11: AC resistance of a PIN diode switch showing dependency to the diode direct current

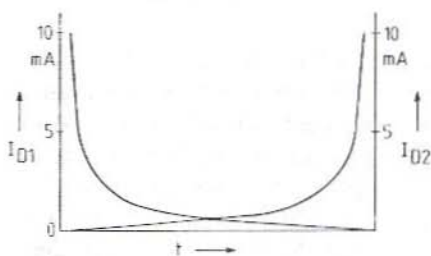

Fig.12: Control currents of two PIN diodes during mixing (idealised form)

The two generators have a phase difference of φ . After adjusting each of the mixing controls R_1 and R_2 , all values of the resulting output voltage u can be confined within the shaded zone in the diagram. That gives us the opportunity of leading the end of vector u (arrowhead) along any desired path from $u_1/2$ to $u_2/2$. The end of the mixing process is reached each time that $R_1 = 0$ and $R_2 = \text{infinity}$ (and vice versa). Two clearly special paths of the arrowhead are useful: with one, the

value of the vector remains constant and the route is an arc of a circle. In the other, the source resistance, which the load sees, remains constant; this path is a straight line between the end points. Whilst the arc, using this dissipative (lossy) mixing arrangement, can no longer be achieved above a certain value of angle ϕ the second way is always feasible. It does of course produce an amplitude modulation component, to be eliminated in the receiver, but has the advantage of a match that remains constant, which a high performance input amplifier in a receiver likes to see. The following relationship is maintained then:

$$R1 \cdot R2 = (50\Omega)^2 \quad (4)$$

In themselves, R1 and R2 could be replaced by active elements whose amplification could be altered in similar fashion. Passive modulators might be suitable too. However, in the PIN diode we have already a building block whose RF resistance over the DC flowing through is variable over a wide range. It introduces no additional distortion above a certain fre-

quency (about 40 MHz here) and is available with sufficiently small tolerances. If we give the control currents of the PIN diodes suitable time functions, we can then by means of these phase manipulations imitate the rotating dipole of Fig.1 so far as to make it appear to be moved through an octagon. The best achievable curve forms for $\Delta\phi$ and ΔF in this way that can be expected are illustrated in fig. 9.

So that the amplitude modulation does not become too great, the phase differences between the RF voltages of neighbouring dipoles should not get too large. The greatest variation occurs when the wavefront comes in rotated by 22.5 degrees as against to Fig.3; it is then

$$s = 2 \cdot p \cdot \lambda \sin \pi/8 = 0.765 p\lambda$$

Should ϕ remain below 120 degrees (100 degrees; 90 degrees), to which 33% (22%; 17%) AM belongs, then p must remain below 0.436 (0.3653; 0.327).

5. THE DERIVATION OF THE CONTROL CURRENT-TIME FUNCTION

The PIN diode offering of German manufacturers is not large. Types which used to be offered for use in TV receivers have disappeared again from the market, now that other concepts are used in tuners. The types that are still easy to find - BA379, BAR79 and BAR15-01 (two diodes in one SMD package) - are suited for use on two metres without reservations. In the 70cm band I would recommend compensating

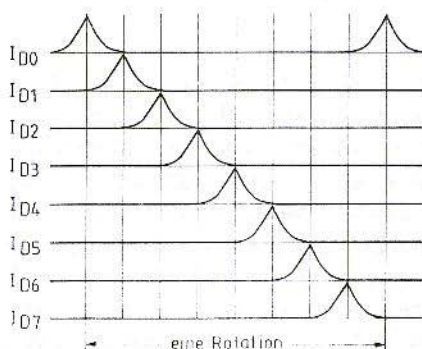

Fig.13: Control currents for all PIN diodes during a rotation in the mathematically positive sense

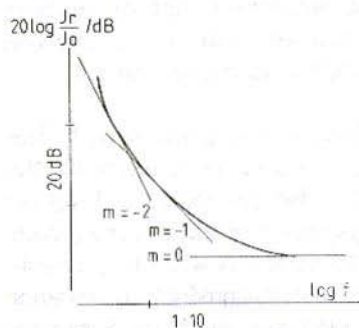

Fig.14: Typical course of an oscillator's sideband noise

for the diode's capacity, so as to get an isolation of around 25dB at zero current. Measurement of insertion loss in a 50Ω ohm system produces almost exactly the same curve (like Fig.10), from which the AC resistance (fig. 11) can be calculated. The lowest AC resistance barely exceed 10Ω the insertion loss drops barely below 1dB. In this respect, then, PIN diodes are inferior to the switching diodes mentioned earlier. For this reason you should avoid complicated arrangements of several PIN diodes if high sensitivity is a requirement. The insertion loss (and increasing AM) degrade the noise figure of the receive system in well known ways. To try to cure this, you could use impedance transformations with pi and T arrangements of several diodes. These would require a complicated control generator with separate time functions for the transverse and longitudinal ("vertical" and "horizontal") diodes.

I don't want to make it that complex here. Each individual antenna should have just one PIN diode in circuit, similar to Fig.10, to produce the same star arrangement as found in Rogers (3) and Zopp (4).

In Fig.11 an auxiliary straight line has been drawn in to illustrate the relationship <you type it!>. The curve of the diode coincides with this over a broad range of currents. So that equation (4) can now be valid, mixing must result between two diodes, so that

$$I_{D1}^{-0.85} \cdot I_{D2}^{-0.85} \sim (50\Omega)^2$$

The value of the proportionality constant still missing can be found if equal quantities are delivered by both sources, bearing in mind that by definition, AC resistance must equal 50Ω .

To this belongs a control current of around 0.65mA. Equation (5) then becomes

$$I_{D1} \cdot I_{D2} = (0.65\text{mA})^2 \quad (6)$$

This control current function is illustrated in figure 12. In reality one would not take the control current to really large values but would let it end up between 5 and 10mA. We are still left with a variance between equation (5) and the actual diode curve. The control current function of Fig. 12 is thus a first approximation, albeit a good one. WE produce it in practice as a triangular form with an analogue function generator and optimise it in the final version by equalising the bends for best FM staircase form and smallest AM.

For all the diodes of a commutator we have the resulting control current functions seen in Fig.13. We must therefore either construct an eight-phase generator or divide the currents from a bi-phase generator with suitable switches of diodes of an even or odd number. If the control currents are correct, we will now find that the receiver has regained its selectivity.



6. THE CHOICE OF ROTATION FREQUENCY

The spectrum of Fig.6 does not hold for real Doppler signals, which look at best like Fig.9. It will contain further lines of higher frequency, produced by inequalities (*k*-rating) in the Doppler signal. If they go into the neighbouring channel, then the selectivity is corrupted. If you are not sure you have hit upon the best time function, you can reduce the problems further by dropping the rotation frequency *n*.

If *n* lies within the audio range, the intelligibility of speech will be degraded during direction finding. At the same time, any speech activity will interfere with direction finding. However, since you can get a usable bearing with just a few rotations, this can be done in the gaps between speech. A high *n* is an advantage then, as it allows more rotations over the

same time. It is easy to imagine an automatic circuit that recognises pauses in conversation and carries out direction finding whilst blocking the audio path.

Intelligibility of transmitted speech does not require any components below 300 Hz. An *n* of less than 300 could thus be of use if bearings need to be taken during speech. A precondition to this is that the transmitting station does not produce any deviation in this audio frequency region. Separation of the Doppler signal from the audio on the receive side is easily achieved with commonplace filters.

In many transmit and receive oscillators the interference phase deviation increases significantly in the vicinity of the carrier. In contrast, the Doppler frequency deviation decreases with *n*. A lower boundary for *n* can be calculated like this at which the signal-to-noise separation in Doppler evaluation becomes behaviour of the side-band noise (fig. 14) or at least a measured value and the slope.

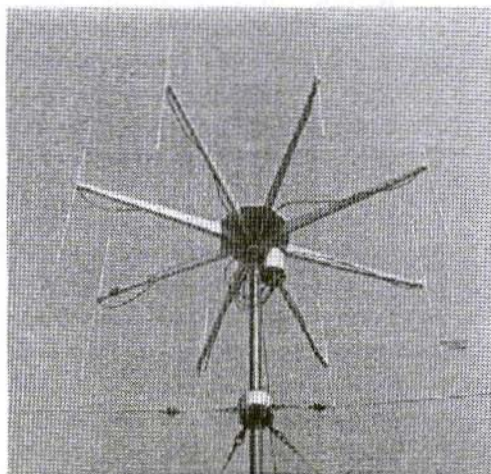

Fig.15:
A circular group of eight dipoles
on a mast



In general, the following is valid

$$\frac{J_r(f)}{J_0} = k_m \cdot f^m, \quad (7)$$

in which J_r and J_0 are the Bessel coefficients, their relationship in dB being expressed by the sideband noise ratio, k is a constant and m is the slope of the curve at the desired frequency. In the vicinity of the carrier m will lie between 0 and -2; k_m is determined by a single measured value (e.g. -80dB_c at 1 kHz, $m = -2$) and is measured in units of Hz^{-(m + 1/2)}. The total noise deviation in a bandwidth given by f_1 and f_2 is

$$\Delta F_r = 2 \cdot k_m \cdot \sqrt{\frac{1}{2m+3} (f_2^{2m+3} - f_1^{2m+3})} \quad (8)$$

This value can be put into relationship with the usable deviation by employing equation (1). For f_1 and f_2 suitable boundary limits should be established, which are produced from filtering the Doppler signal after demodulation. I select as an example $f_1 = 0.5 \cdot n$ and $f_2 = 1.5 \cdot n$ and $k_{-2} = 100\text{Hz}^{1.5}$, which corresponds to the example in the previous paragraph. Equation (8) simplifies itself to become

$$\Delta F_r = \frac{200/\text{Hz}^{1.5}}{\sqrt{n/\text{Hz}}}$$

If we now select $p = 0.35$, so that the Doppler deviation works out, according to equation (1), as $\approx 2 \cdot n$, then the signal-to-noise ratio amounts to

$$\frac{\Delta F}{\Delta F_r} \approx \frac{2 \cdot n \cdot \sqrt{n}}{200} = 10^{-2} \cdot n^{1.5}$$

If a $\Delta F/\Delta F_r$ of greater than 10 is required, then the following are valid: either $n^{1.5} > 1000$ or else $n > 1000^{0.667} = 100\text{Hz}$. If $\Delta F/\Delta F_r$ of greater than 100 is required, then we get under the same conditions $n > 464\text{Hz}$.

Averaging over N rotations reduces, on statistical grounds, the influence of noise by a factor of \sqrt{N} . A broad field opens up here for digital signal processing (DSP).

Using high-end equipment we would use a second receiver chain with a fixed antenna in order to acquire a signal without Doppler component at the IF or audio level. That now makes available the speech modulation without the distortion, which can be subtracted from the mixed modulation to produce the pure Doppler signal.

A further calculation enables us to prove that direction finding in most cases gets by with a lower level of received signal than is necessary for intelligible speech. Since Doppler does not reduce transmission range, I shall spare myself this calculation.

Commercial direction finding equipment (5) operates with $n = 150$ to 170Hz , for historical reasons. Early on, mechanically driven capacitive commutators were being used and this relatively low frequency was favourable to maintaining a separation from the speech band. It can be problematic when there are oscillators with relatively high levels of sideband noise in the complete set-up. An averaging of several rotations becomes necessary in order to maintain stable bearings.



7. PARTICULAR CHARACTERISTICS OF THE RECEIVE ANTENNA

The arrangement of eight dipoles, named the octopus by Rogers (3) and dubbed spontaneously the monkeys' merry-go-round by my wife, needs to be mechanically stable. The commutator should be put at the centre, not as shown in Fig.15 where it is causing asymmetry. The photo is only my first trial model, so I ask for your understanding. In any case, you learn from your mistakes which leads us to Fig.17 which clearly shows not only the inadequacies of this antenna but also of the filtering at that time.

The feeder cables from the dipoles to the commutator should have exactly equal lengths and be made from the same drum of cable. To avoid false coupling between the dipoles, we need to detune the unused ones. This is achieved in open half-wave dipoles by the high impedance at their connection point. The PIN diodes do this automatically if the feeder cable is a multiple of a half wavelength. There are other ways of doing the dimensioning but these involve multiple measurements, specific feeder lengths and defined values of p . For example you could do this by choosing the most suitable length of the cable to be equal to the radius of the antenna group. The feeder could then be built into the spoke. Air insulation is feasible and other changes to the cable brought about by stress, temperature, wind and ageing are eliminated. In the ideal case each dipole will behave as if it had no

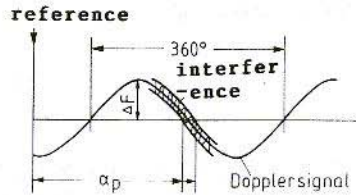

Fig.16: Derivation of display fluctuation through interference and noise

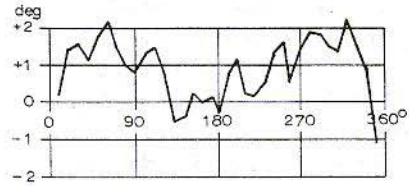

Fig.17: The azimuth-error diagram reveals insufficient filtering through rapid antenna asymmetry caused by slow periodicity

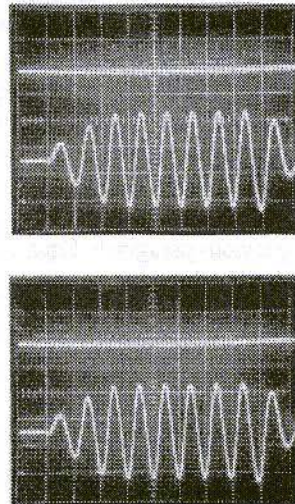

Fig.18: Control signals for the commutator (Y1) and build-up of the filtered Doppler signal (Y2) with mathematically positive (a) and negative (b) rotation. Y1: 5V per division; Y2: 1V per division; X: 2ms per division



affinity to the other seven. A certain degree of lopsidedness of the horizontal polar diagram is inevitable, and the mast must be responsible for this. If it lies below 3dB, the Doppler will work without problem, though.

8. PROCESSING THE DOPPLER SIGNAL

The ΔF curve of Fig.9 is, as it is, unsuitable for determining the zero-pass point. Because of the unequal movement to an octagon harmonics are produced, which make for the formation of the staircase curve. These harmonics should be filtered out to the extent that the remaining fluctuations in the sine wave now produced lie below the desired resolution. Looking at Fig.16, we see it is designed to show how to approximate fluctuations in the display by the noise overlaid.

The Doppler (useful) signal has, at the zero-pass point, a slope of

$$\frac{d(\Delta F = 0)}{d\alpha} = \pm \frac{\pi}{180^\circ} \cdot \Delta F \quad (9)$$

An overlaid interference voltage of magnitude ΔF_s causes a shift to the zero-pass by a maximum of

$$\Delta\alpha = \pm \frac{180^\circ}{\pi \cdot \Delta F} \cdot \Delta F_s \quad (10)$$

Inadequate filtering of the harmonics leads to systematic bearing errors, which can be recognised by the periodicity in the azi-

muth error diagram (Fig.17). The same diagram also illustrates the errors which arise from geometric errors in the antenna group.

The noise deviation, which overlays the useful deviation, leads to statistically fluctuating displays. The largest deviation occurs when measuring a single rotation per display. Putting that into figures, assume we have in equation (10) the values of 0.1 and 0.01 for $\Delta F_s/\Delta F$, which were produced with rotation frequencies of 100 Hz and 464 Hz respectively. This gives $\Delta\alpha = 5.7^\circ$ or 0.57° respectively. The first result demands improvement, the second is acceptable. It proves that quite good direction finding can be achieved with one single rotation in 2.2ms.

The necessary filtering requires that the Doppler signal must first build up before it can be evaluated. This building up process is shown in Fig.18. At the beginning of rotation, noticeably at the timing pulse on the upper trace, the amplitude is growing to a value at which it remains. Here this is achieved after three rotations. Afterwards (in this example) four rotations are meas-

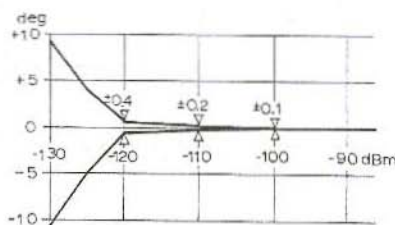

Fig.19: Noise induced display functions with dependency on the receiver's input signal strength



ured; one more is done as a check to see if the receiver is producing sufficient receive signal. After that the rotation is ended. This is just one example for many possibilities; according to individual requirements of measurement speed, broadband or narrowband filtering can be selected. The build-up time of a band filter is inversely proportional to its bandwidth, so a rapid indication calls for a broad filter (but these let in more noise and other interfering signals). Narrow filters require longer times (an order of magnitude of seconds when the bandwidth is of the order of Hz) but they suppress interfering signals of n varying frequencies better. Noise reduction is proportional to the root of the bandwidth reduction. The improvement of noise-influenced display fluctuations is therefore proportional to the root of the lengthening of the build-up period. The

same result is produced by averaging out direction finding over several rotations, and following Shannon's information theory, we should not be expecting anything else.

For filtering the Doppler signal all possible active and passive filters can be brought into service. N -path switching filters, as used by Rogers (3) and Zopp (4), assume a special role. They are bandpasses which, because they use the same tempo of rotation, are always correctly in tune with n and can thus be made as narrow-band as wished.

A very narrowband system can possibly be made to work satisfactorily during simultaneous speech. I have not put this to the test. Any use of switched filters must be recognised as introducing the possibility of

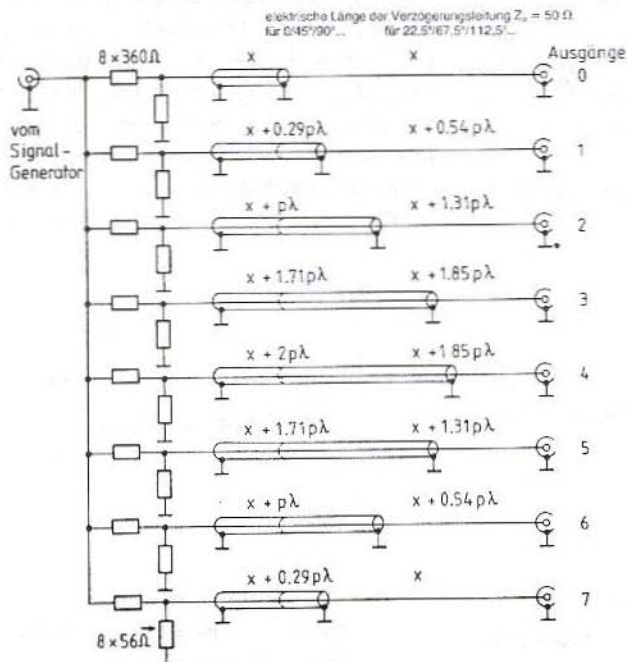

Fig.20:
Circuit of the antenna simulator from phase lines of defined length



new ripple in the Doppler signal. They must always be followed then by conventional analogue filters, which will suppress the ripple.

In practice a mixture of bandpass filtering and averaging has proved itself. By way of example, a system (1), working with $n = 1000$ Hz, built up in three rotations and averaged over ten rotations, gives noise-induced fluctuations in display shown in Fig.19. The input power -120dBm in this illustration corresponds to an RF signal-to-noise ratio of about 10dB; speech is just readable. Doppler direction finding on the other hand is error-free.

The various filtering in the IF and audio parts of the receiver influence transit time. A timing error arises between the control current for the reference dipole 0 and the corresponding result at the output of all the processing, and α_p is measured too large. A compensation can be made for this timing error by moving the antenna group or by all-pass networks in the signal path. The possibility remains of dependence on

temperature or ageing (and filters going off-tune). An elegant solution to this problem is the use of anti-sense rotation. Other conditions remaining equal, the bearing value now consists of the timing between the Doppler signal's zero-pass in a positive direction and the reference point. With the transit time Δp will be measured too small. The average value of the measurements in both directions will no longer contain the transit time!

9. SOME DEVELOPMENT HELP

For testing a Doppler system it is better to rotate the antenna group and receive a fixed-location transmitter. This needs only have low power (-60dBm at 100 metres' distance). Then the wave of the propagation path is kept constant and will produce results that remain equal even in the case of multipath reception. A beacon transmitter of this kind can also be useful later on, because its bearing is indicated immediately if something in the set-up is altered. Recording azimuth error diagrams (Fig.17) involves going out into the great outdoors, which according to experience seems always tied up with tropical heat and unremitting sunshine or else Siberian cold and snowdrifts. All the same, a lot of other work, such as optimising the time function or the filtering, can be carried out under your own roof with the aid of an antenna simulator. It consists of a few bits of coaxial cable, which are connected between signal generator and commutator. Following the dimensions of Fig.20, it replaces a group of eight antennas, which receives just from the reference direction if

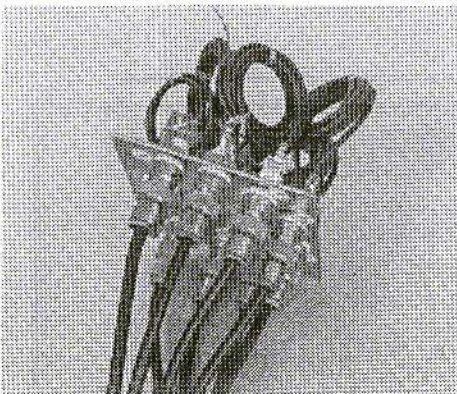

Fig.21: Sample of the antenna simulator



output 0 instead of antenna 0, output 1 instead of antenna 1 and so on are connected. Moving further one step alters the bearing each time by 45°. For intermediate values one must make the cables different lengths. The lengths for 22.5° are already given in Fig.20; x is a length which can be chosen freely as it turns out from the cabling. The voltage divider has 24dB attenuation and serves for the correct termination of the signal generator and commutator as well as decoupling the outputs from one another. A star-form set-up is offered; Fig.21 shows a constructed example. If you were to show it to Mr. Doppler, he would probably not connect it in any way with the effect bearing his name

10. LITERATURE

- (1) D. Burchard (1988): Direction Finding in Wildlife Research by Doppler-Effect
Biotelemetry X, pp 169-177,
University of Arkansas, Fayetteville
- (2) R. Grabau & K. Pfaff (1989):
Funkpilotechnik, chapt. 4.6, pp 48-172
Franckh'sche Verlagshandlung,
Stuttgart
- (3) T. Rogers (1978): A Doppler ScAnt
QST May 1978, pp. 24-28, American
Radio Relay League, Newington
- (4) A.G. Zopp (1980): Automatisches
Peilen mit dem Dopplereffekt
Funkschau 13/80, pp. 59-60; 14/80, pp.
91-93; 15/80, pp. 79-81; 16/80, pp.
94-96, Franziz-Verlag, Munich
- (5) N.N. (1972-1981): in "Neues von
Rohde & Schwarz" several reports in
issues 58 (1972), 59 (1973), 66 (1974),
71 (1975), 73 (1976), 80 (1977) and 96
(1981), Bergverlag R. Rother, Munich
- (6) N.N. (1978): Direction Finding using
your narrow-band FM receiver
Publicity document of the firm
Doppler Systems Inc., Phoenix AZ

PACKET RADIO TCP/IP MODEM

PCB only + circuit + *FREE* copy of TCP/IP
software

£10.75 + 50p p&p

**Mr.P.EDWARDS, 37 BUSHEL LANE, SOHAM,
ELY, CB7 5BY, U.K.**



Volker Esper, DF9PL

High-Stability, Low-Noise Power Supply

For a piece of high quality equipment it is of great importance to supply it with high quality voltages. In most constructional articles, the power supply is treated again and again as some kind of step-child. This article looks into the problems of high-stability, low-noise power supplies as well as measurement techniques for them. In addition a universal power supply is described; it has been dimensioned for the spectrum analyser designed by DBINV.

1. FIRST CONSIDERATIONS

1.1 Why high-stability and low-noise?

Just as in nature there is no ideal condition, so with power supplies there is no protected species of supply voltage that is immune from extraneous effects. If we must tolerate undesired voltages, which

order of magnitude can they reach without impinging on the functions of the apparatus?

Using the example of the local oscillator of the spectrum analyser, this will be explained.

The oscillator is tuned over a range of 500 MHz with about 30 volts. The 30V operating voltage is not applied directly to the varactor as a tuning voltage, but instead filtered by low-pass filters. The limiting frequency of these filters is selected so as to produce an adequate speed for tuning. **Below the limiting frequency the supply voltage must display the necessary "cleanliness", however.**

Fig.1 shows the operating voltage with a noise component overlaid. The single sine-wave oscillation represents the "worst case" with the largest amplitude and the shortest period.

A slow fluctuation of the operating voltage indicates in our analyser example an uncontrolled variation in the spectral line. A detectable movement of this line (0.2 of

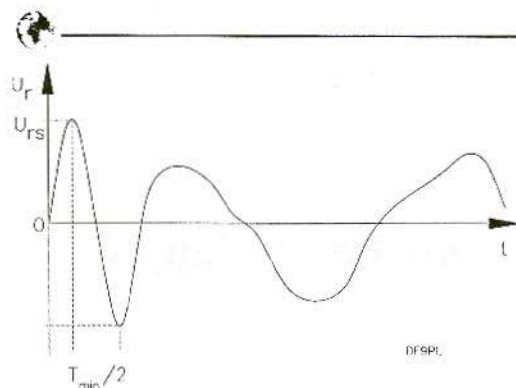

Fig.1: Noise voltage overlaying the operating voltage

a square on the display screen) after 10 is certainly bothersome but tolerable. Ten minutes correspond in Fig.1 to a period of the noise voltage of around 1000 seconds, that is a tolerable noise frequency of max. 1 mHz (!) = $f_{limiting}$. In the range of highest resolution (10 kHz/cm) 0.2 of a square corresponds to a change in the tuning voltage of 120 microvolts = U_{ISSmax} .

In any case, the noise voltage is not the only unasked-for component overlaid on the voltage, meaning that U_{RSS} should be depressed significantly lower.

1.2 Mains or battery operation?

Supplying DC from the mains to sensitive electronic apparatus brings many disadvantages with it. The most significant to be mentioned are:

- mains fluctuations
- breaks in the mains of several hundred milliseconds
- mains voltage must be transformed
- mains frequency must be filtered out

- interference (pulses, noise, spikes of some hundreds of volts)
- possible coupling of hum into regulator circuits.

A feasible alternative is the rechargeable battery power supply. For small current loads this is an entirely viable solution, for example the crystal reference oscillator (5).

Significant disadvantages of rechargeable batteries are:

- energy store is not limitless, recharging required
- impractical for large current drains
- battery noise cannot be ignored
- output voltage dependent on state of charge
- internal resistance higher than on conventional regulated sources and dependent on state of charge.

The rechargeable battery power supply will not be considered further here.

2. INTEGRATED REGULATORS

2.1 What are regulators for?

Isn't it also possible to put low-cost RC low-pass filtering in the power supply?

The limiting frequency of 1 millihertz achieved in section 1.1 should be taken for an RC low-pass. Below $f_{limiting}$ the internal resistance R_i of the voltage source increases (at 0 Hz R_i is the same as the R of the RC element); with changes in load this

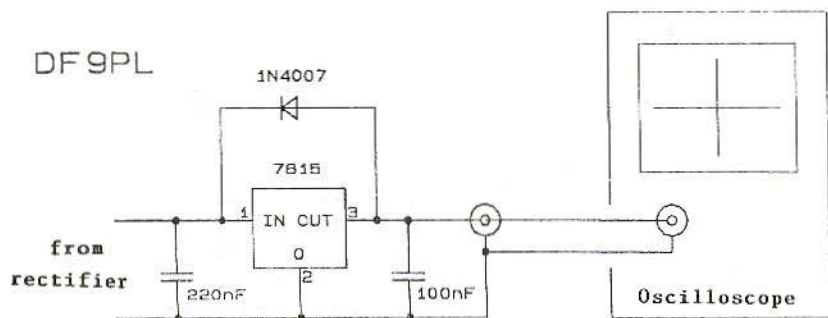

Fig.2: Broadband noise measurement circuit

leads to steady changes in the output voltage U_1 . In view of this, R cannot be selected as high as we might wish. If we substitute for R the dynamic resistance of the voltage regulator (because the low-pass will be measured this way), namely around 0.01 ohms, this produces according to

<equation>

a capacitance C of 16 kilofarads. Even if we reduce our demands substantially, we are still in the farad region, which in practice is totally unrealistic.

The example shows vividly that an RC low-pass filter can take the place of clean regulation of the operating voltage. Consequently, we need to build a regulator circuit which operates with high stability and has low noise up to several kHz.

2.2 Data for the regulator

The following details need especial consideration:

- power supply rejection (PSR) and line regulation

- load regulation
- voltage noise, current noise, noise density and which frequency ranges to measure
- temperature drift
- long-term stability.

In many cases the following considerations are also valid:

- absolute value of the output voltage
- quiescent current (with battery operation)
- maximum load current
- lowest voltage drop in the regulator (drop-out voltage)
- short-circuit behaviour
- maximum input voltage
- maximum sink current.

A particular problem is the noise created by the regulator.

2.3 Regulator noise

If we measure common commercial regulators (7815 or LM317) with an oscilloscope as in Fig.2 and check their output voltage in C mode, we will establish a

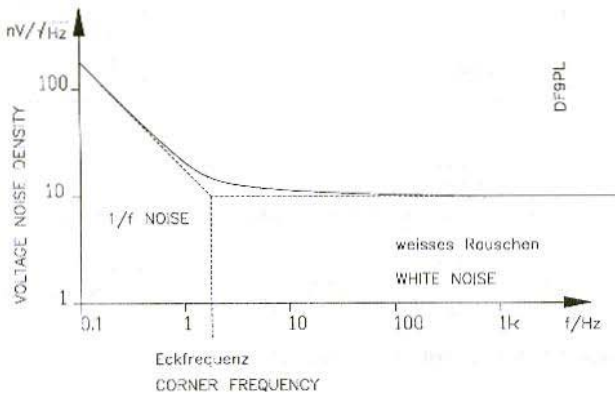
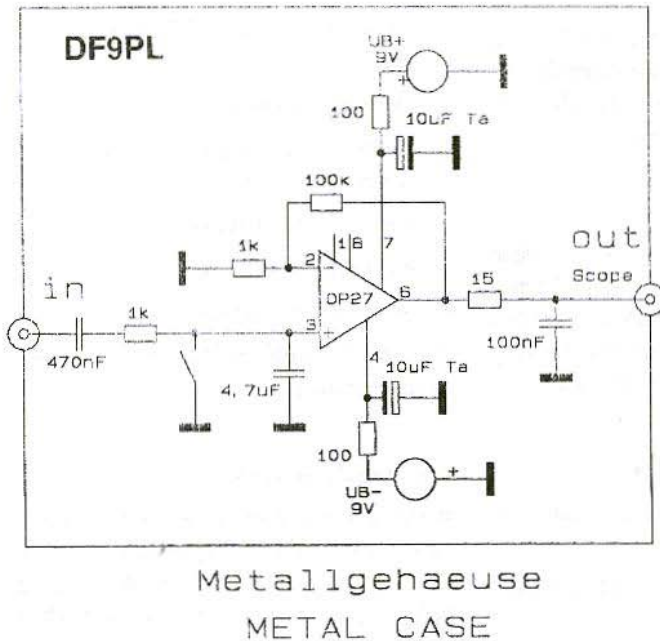

Fig.3: Transition of 1/f noise into White noise

broad band of noise in the most sensitive range. Carrying out the same experiment with the precision regulator REF-01 produces a disappointing result - the REF-01 is even noisier! All the same, every amateur knows that these devices are noted for their low noise! No worries: the device is very low-noise, but not in this circuit.

Figures in data sheets normally confine themselves to a range from 0.1 to 10 Hz, and restricting the bandwidth like this brings about a reduction in noise voltage (actually the noise power). And in this low-frequency range the REF-01 is virtually unbeatable. In the circuit of Fig.2 a much broader frequency range is handled.



**Fig.4:
Noise measurement
amplifier**



3. MEASUREMENT CIRCUITS

3.1 Noise

Noise voltages are stochastic, that is of a fortuitous nature. That goes for both the frequency and the amplitude. These voltages cannot therefore be measured in a comparative fashion on their own. Frequently other (partly periodic) interference voltages are termed as noise; here these voltages are bracketed together with noise as extraneous voltage.

Noise in semiconductors comprises several components, which exhibit partly different spectral densities. That means particular frequencies with high amplitudes crop up more frequently. Important in this connection are thermal (resistance) noise and flicker noise ($1/F$ noise). Whereas in thermal noise all frequencies are apparent (white noise), the prominence and amplitude of flicker noise increases at lower frequencies. The so-called corner frequency at which flicker noise diverges from thermal noise is an indication of the quality for integrated semiconductors.

3.2 Effective value measurements

The measurement of effective values is a product of reproducible measurement. The bandwidth of the measuring device must encompass the bandwidth under consideration of course. A true effective value voltmeter (RMS voltmeter) for broad frequency ranges is, because of its cost, not yet standard among amateurs.

3.3 Peak-value measurement

Another possibility is the measurement of

peak values. Peak values of noise are constantly given in data sheets. The amplitude of noise is still of a chance nature and can theoretically assume any value, though the larger its value, the smaller its likelihood of occurrence.

Derived from precise physical relationships, the following rule of thumb holds good between effective value and peak value: effective value times six gives the peak, peak value which for 99.73% of the time is not exceeded (1). Following rectification and quantisation by an A-to-D converter 10,000 values are stored (for example). The 27 highest values are ignored and then the largest value of the 9,973 remaining is the value which divided by three gives the effective value. (Since only the peak value, and not the peak, peak value, is of interest, the factor of three - instead of six - arises.)

3.4 Laboratory measurements with substitute methods

A substitute method is the observation of noise on an oscilloscope (AC mode of operation). During this, the brightness of the display should not be altered. At slow deflection speeds the height of the noise threshold can be read off. For internal comparisons this is a practical method. We need to look out for possible low-frequency noise, which is not visible in the noise threshold but manifests itself as a vertical "wagging" or drifting of the band. The formula to use is: the peak, peak value read off is divided by about six to eight to give the effective value (see also 3.3).

Additionally a simple but broadband (mean value) voltmeter can be used admirably for internal purposes (if the band-

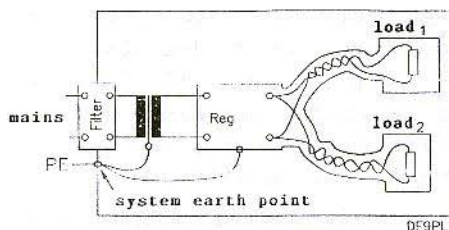

Fig.5a: Optimal screening relationships

width is larger than the noise bandwidth). In this case the measured value times 1.13 gives the effective value. This is valid only for true noise, not for overlying periodic voltages.

3.5 Measurement amplifiers

Noise voltages are generally very small. It is worth building a measurement amplifier according to Fig.4, with a bandwidth of 50 kHz and an amplification of around 100. Construction on perf-board is suitable. A metal cabinet, also containing two 9V batteries is not a luxury. A disadvantage of this simple circuit is that after applying the input voltage, the switch must be operated briefly in order to charge the capacitors and to bring the op-amp input into its operating range.

Also possible are low-noise circuits using discrete components but these will take a lot of effort to achieve the characteristics of the OP-27. Moreover, with the OP-27, all the data is already available.

3.6 Experimental and final construction

An important pointer for accurate measurement and suitable "transport" of the voltages produced is the method of wiring.

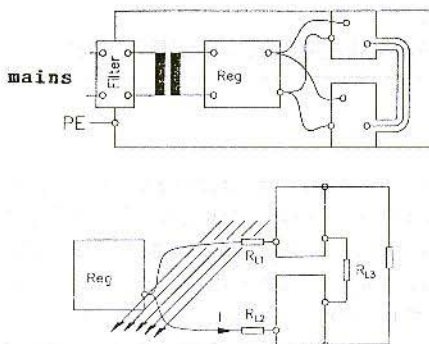

Fig.5: Earth potential loops through coaxial cable and metal casing

Poor connections between the various modules can cause interference to increase by up to 60dB. The largest sins are committed in the choice of the return conductor for the current. In automobile practice the return path is the steel body. Cross currents from other devices or poor connection between different body panels contaminate the zero potential between power supply and load device.

The points that follow should be kept uppermost in mind:

- Zero volts potentials should lead to one location and be taken to casing, chassis or earth: this point is defined as the system earth. Avoid current loops! If this is not possible, for instance with RF modules connected by coaxial cable (Fig.5), the screening (shielding) should be kept as short as possible and taken to deck close to the casing. The logic of this is as follows: the closed 0V circuit covers a fixed area. If this area is crossed by lines of magnetic field, induction current I arises in the shielding (Fig.5b). The wiring



resistance brings about a voltage drop, which shifts the 0V potential between power unit and load device. The influence of these lines of field is minimised in the vicinity of the casing. This measure also reduces capacitive coupling into the circuit.

- Feeder wiring to and from the power supply should be kept as short as possible, of low resistance and as symmetrical as possible. Twisted Litz wire is suitable, run as close as possible to the casing, or else screened twin wiring with the screen taken to ground at each end. Twisting also serves to reduce the surface area of the closed loop of power supply wiring that is susceptible to magnetic influence. Since the load device represents the highest resistance in the loop, the interference overlaid on the power supply voltage is highest where it is closest to the load!
- If several load devices are connected to the same power supply, a separate feeder cable should be provided for

each device, as close as possible to the regulator (a few centimetres can be decisive here).

- Screening should not be twisted together and formed into a pigtail but soldered instead direct to the metal case. The difference in the effectiveness of screening measures can work out up to 30dB (7).

Other possible sources of interference, which occur predominantly in open (un-cased) construction, are:

- Oxidised connectors (even dirty gold contacts) can cause noise.
- DC variations and noise in the microvolt region can occur due to thermal voltages produced by dissimilar contact materials touching.
- 50 Hz voltages and other interference on the oscilloscope screen can arise from radiation from nearby transformers and generators. Frequent causes of errors are soldering iron transformers, function generators, loudspeaker coils and so on.

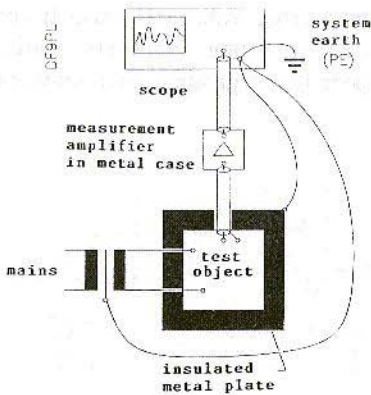

Fig.6a: Open experimental setup within apparatus

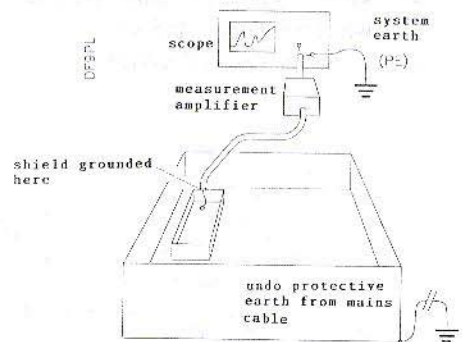

Fig.6b: Good setup for measuring within apparatus system earth

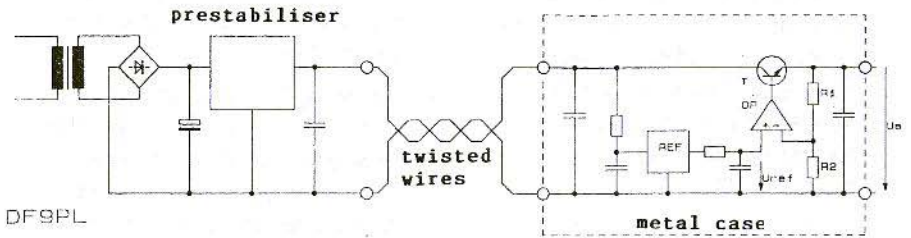

Fig.7: Principle of the mains unit

- Crosstalk in the oscilloscope. If possible, carry out sensitive measurements with just one channel (frequent source of errors).
- Are all transformers and test instruments in the laboratory connected to the same phase of the mains?
- Even close examination of system earth connections may overlook capacitive coupling to earth via transformers. If no transformers are available with screens grounded (at the system earth point), the primary windings can be connected reversed experimentally.
- Pick-up of broadcast stations. It often occurs that powerful medium wave and short wave transmitters induce interference voltages of several millivolts in test and measurement set-ups. These effects can easily be confused with noise. Recognition points are sudden disappearance and (rhythmic) modulation.
- Further suppression of interference in experimental set-ups can be achieved by constructing them above earth planes made from a metal plate grounded at the system earth point. Reduction by up to 20dB is possible.

4. CIRCUITRY OF POWER UNITS

The interference voltage U_s , which embraces all interfering components (noise, hum, poor load regulation, long-term and

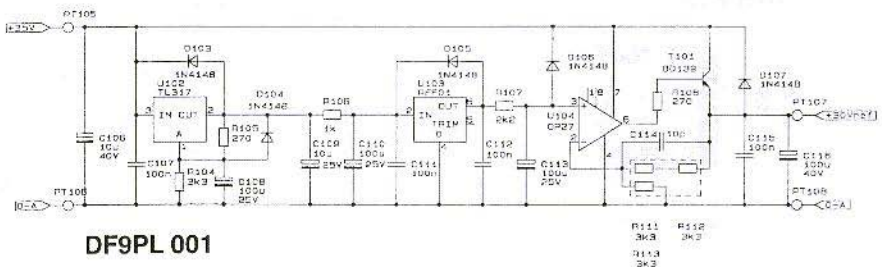

Fig.8a: Circuit of the 30 Volt section

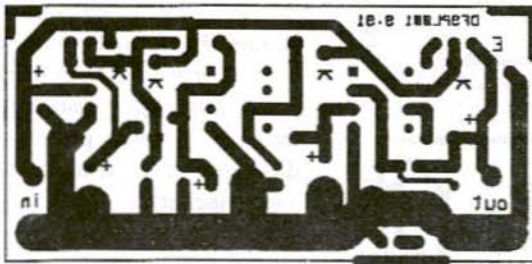

Fig.8b:
PCB and component
overlay of the 30V section

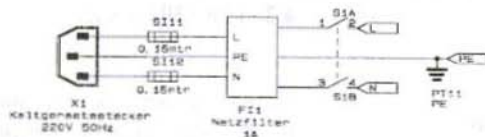
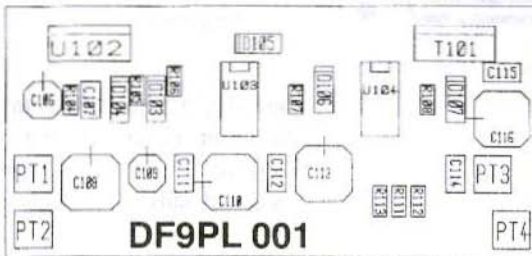
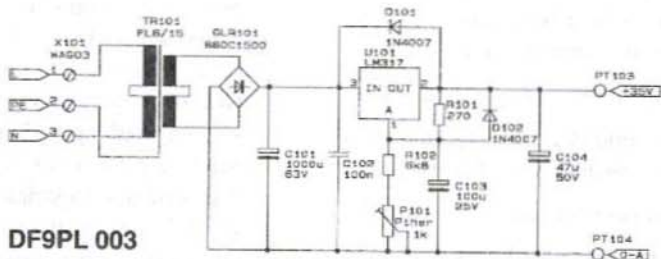

Fig.8c:
Prestabilisation,
30V circuit



thermal effects) should amount to less than 1 ppm. That means with a working voltage of 30V, u_s should be 30uV (120dB of interference suppression).

The circuit developed should be capable of virtually universal application. This one here is dimensioned for the spectrum analyser of DBINV. In this process the following values were arrived at:

- Output voltages +30V, ±15V each at 10

0mA; interference voltage U_s (hum, noise, etc.) on the output under all conditions less than 30uV; bandwidth of the final stage greater than 50 kHz; with a load increase of 50mA the voltage increased by this to remain below 1mV; over 60 seconds the output voltage should not vary by more than 3 ppm from the final value.

- Additionally +12V at 200mA forre-

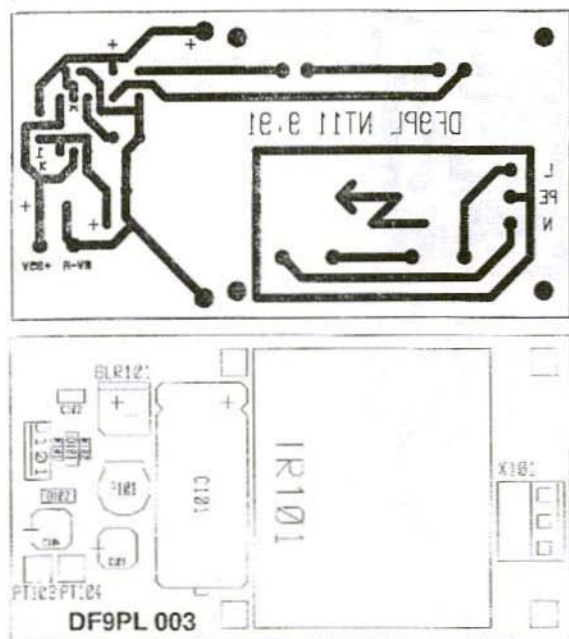

Fig.8d: PCB and Component layout of the prestabiliser

lays; +5V at 1.3A for purely digital circuits; -9V at 100mA for a digital voltmeter (frequency display).

Modifications make possible also:

- The output current can amount to several hundred milliamps.
- Output voltages from 3V to 30V.
- Simpler materials requirement for reduced specification versions.

4.1 Principle

Fig.7 shows the circuit outline. Rectification, filtering and prestabilisation are easily achieved, using commonplace circuits. An op-amp is provided with its own screened case. The reference voltage is produced using a REF-01 and a low-pass filter on its input and output. The regulated

voltage is produced with a voltage divider at the output of the transistor. The op-amp controls the output voltage to the stage where it presets a difference of 0V at its input. This brings about

<equation>

Devising a circuit like this does not mean creating a work of art, the skill lies in the fine details.

4.2 The +30V section

Fig.8a shows the circuit, Fig.8b the printed circuit board of the precision section. An LM317 is used as prestabiliser (Fig's.8c and 8d). Other regulators would be over-driven with these voltages (up to 62V on peaks). Since the REF-01 copes only (according to each version) with up to 30V, the 35V voltage must be stabilised (dropped) once again. The feedback capacitor C114 restricts the OP-27's propensity to oscillation in this high-ohmic input circuit (for an OP-27). The output electrolytic should not be larger than 100uF. The diodes have a specific function: they protect the components against feedback voltage surges. When the power unit is switched off the voltage conditions reverse and, because of the stored capacity, the output voltage is higher than the input voltage. The inputs of the OP-27 are especially threatened, so D106 and D107 must on no account be omitted. If only 25mA output current is

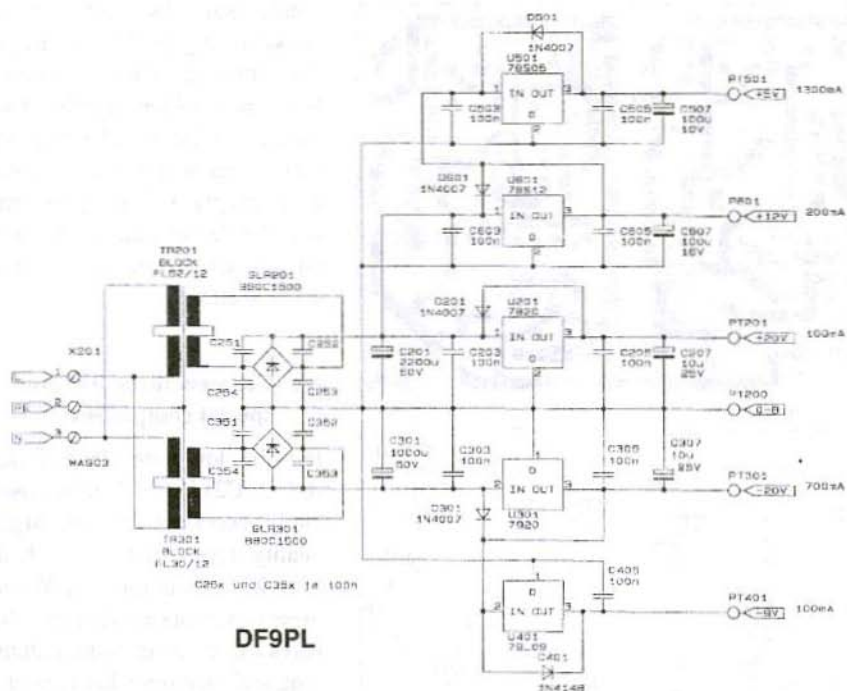

Fig.9a: Prestabilisation, ± 15V section

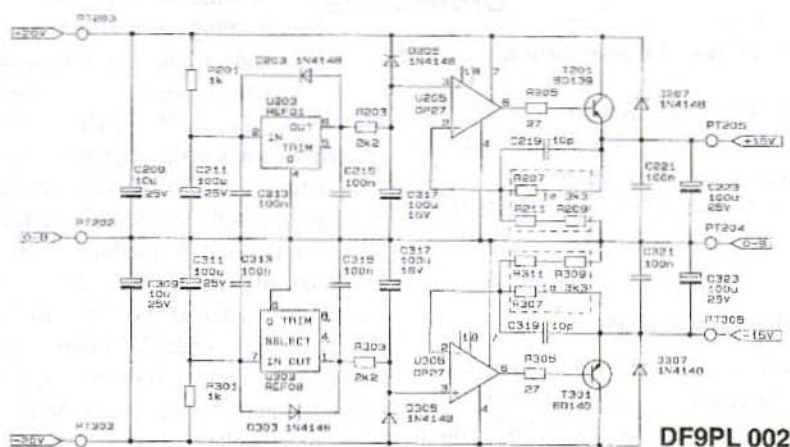

Fig.9b: Precision stabiliser

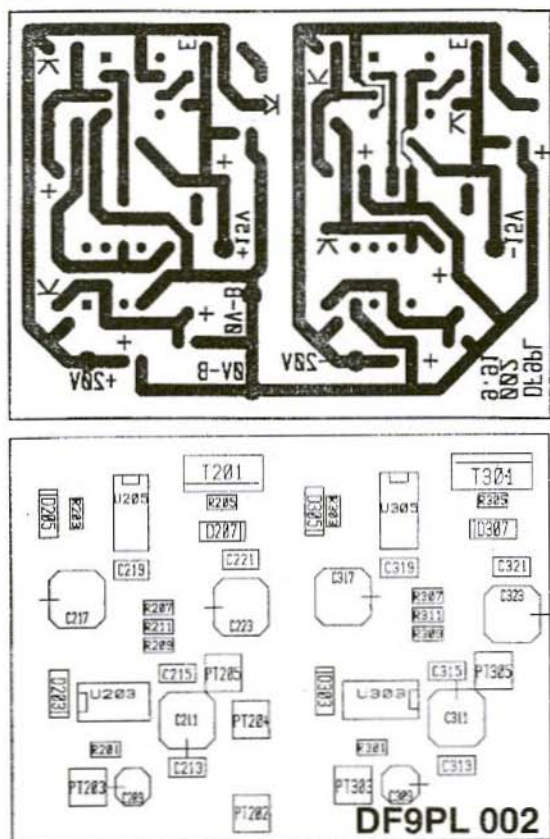

Fig.9c: PCB and Component layout, $\pm 15V$ section

needed, R108 and TR101 can be left out. In that case a strap is taken from pin 5 of the op-amp to the collector pad of the transistor. The OP-27 is short-circuit proof.

4.3 The $\pm 15V$ section

Fig.9a shows the prestabiliser, Fig.9b the precision stabiliser and Fig.9c their PCB. For prestabilisation we use a 7820 and a 7920 respectively. This too is where we stabilise the voltages for TTL circuitry (+5V) and the frequency display (-9V). Further stabilisation for the REF-xx is

omitted since the input voltage amounts only to 20V. As negative reference a REF-08 is used. It replaces older circuit ideas with a combined reference for both voltages, for which, however, supply voltage problems arise for the op-amp. Remaining circuit details are as for the +30V section.

4.4 Constructional details, special components

For the low-pass electrolytics (C113, C217, C317) it is absolutely necessary to use high-quality types, the sort which have low loss in forming. When these capacitors are charged, the barrier layer is, to some extent, renewed each time this happens ("forming"). With very large electrolytics, which are desirable on account of their low resultant limiting frequency, the forming current leads to far too high a charging time constant, which overlays the "normal"

time constant of $\tau = R \cdot C$. This can only be determined when the capacitor varies by only a few millivolts from the final charge voltage. Example: A 2200uF electrolytic is charged through 1 kilohm at 10 volts. Theoretically in 17 seconds it reaches 9.996V (variance of 400 ppm). In practice it takes 300 seconds! To reach one of the measured variations of the precision of this circuit (1 ppm), it takes some hours. Since the output voltage is proportional to the electrolytic voltage, the output voltage "runs" in this time!

(continued on page 35)



Index of Volume 24 (1992)

Article	Author	Edition	Pages
ANTENNA TECHNOLOGY			
Omnidirectional Waveguide Slot Antenna for Horizontal Polarisation Part-2 (Conclusion)	Oliver Nell Klaus Solbach DK3BA Jochen Drier DG8SG	1992/1	11 - 17
Low-feedback coupling of a Poly-directional Antenna for Contest Operation	Eugen Berberich DL8ZX	1992/2	97 - 99
VHF/UHF Sloping Vec Antennas	R.A.Formato, Ph.D. K1POO	1992/3	151 - 157
Active Antennas for the Frequency Range from 10 kHz to 50 MHz	Dr. Ing. Jochen Jirmann DB1NV	1992/4	226 - 231
A very low-noise Aerial Amplifier	Matjaz Vidmar YT3MV	1992/2	90 - 96



Article	Author	Edition	Pages
AMATEUR TELEVISION			
ATV with twin Sound Channels Part-2 (Conclusion)	Rainer Tappert	1992/1	2 - 10
A 10 GHz Television Transmitter Stabilised by a Dielectric Resonator	Denys Roussel F6IWF	1992/2	66 - 75
10 GHz ATV The Easy Way Part-4	Jim Toon G0FNH	1992/2	119 - 122
A Digital Slow-Scan Television Transmit Coder	Jean-Jacques Noel F6ILR Daniel Caudroy F6BXC	1992/3	140 - 150
DSP TECHNIQUES			
A 1Mbyte SRAM Card for the DSP	Matjaz Vidmar YT3MV	1992/4	209 - 225
WEATHER SATELLITE RECEPTION			
Digitally Transmitted Weather	Robert E. Lentz DL3WR	1992/2	107 - 118
6 m BAND			
SSB Transceiver for 50 MHz using 50Ω Modules	Wolfgang Schneider DJ8ES	1992/4	241 - 250



Article	Author	Edition	Pages
23 cm BAND			
Microwave Directional Coupler with Front-to-Back ratio made from Semi-Rigid Circuits	Carsten Vieland DJ4GC	1992/3	130 - 139
3 cm BAND			
Doppler Radar in the 10 GHz Amateur Band Part-1	Jean-Pierre Morel HB9RKR Dr.Angel Vilaseca HB9SLV	1992/3	169 - 181
Doppler Radar in the 10 GHz Amateur Band Part-2 (Conclusion)	Jean-Pierre Morel HB9RKR Dr.Angel Vilaseca HB9SLV	1992/3	169 - 181
MEASURING TECHNOLOGY			
A Tracking Generator for the DB1NV Spectrum Analyser	Dr.Ing.Jochen Jirrmann DB1NV	1992/1	35 - 46
A Marker Generator for 10 MHz and 1 MHz Markers	Walter Zwickel OE2TZL	1992/1	47 - 49
Expanding the DB1NV Spectrum to 2 GHz	Walter Zwickel OE2TZL	1992/1	50 - 54
Absolute Calibration of a Noise	Dipl.-Ing.Detlef Burchard	1992/2	76 - 89

Article	Author	Edition	Pages
FUNDAMENTALS * NEW TECHNOLOGY			
A DTMF Converter with Multiple Switching Outputs	Bernd Bauer DF1YW	1992/1	18 - 26
Universal 2:1 Economy Transformer for DC. Part-2 (Conclusion)	Dr.Ing.Ralph Oppelt DL2NDO (ex DB2NP)	1992/1	27 - 30
New Developments in High-Power Travelling Wave Tube designs	Dipl.-Ing.Fritz Hanf	1992/2	104 - 106
A Logarithmic Detector, Manufactured using Integrated Modules	Eugen Berberich DL8ZX	1992/3	165 - 168
MES-Fetishism I	Dipl.-Ing.Detlef Burchard	1992/3	183 - 188
Broadband VCO's using Microstrip Techniques	Dr.Ing.Jochen Jirmann DB1NV	1992/4	194 - 203
MES-Fetishism II	Dipl.-Ing.Detlef Burchard	1992/4	223 - 240
MISCELLANEOUS			
Observation of the Multi-Tone Effect	Dr.Volker Grassmann DF5AI	1992/2	100 - 103
Operating Electronic Equipment	Dr.-Ing.Jochen Jirmann	1992/3	158 - 164



What we need:

- electrolytic, max. 100 μ F
- ideally a tantalum type
- only brand-new (factory-new) stock
- highest possible voltage rating, since losses in forming increase significantly in the vicinity of maximum voltage.

In the present circuit a 100 μ F 25V aluminium electrolytic can be used as a good compromise. After 60 seconds the operating voltage achieves a variation of under 3 ppm. The noise voltage is not discernibly greater than for the 2200 μ F electrolytic.

For the op-amp, the OP-27 from PMI can be used. Its noise behaviour in this application is scarcely bettered. It is optimised for noise input voltage, that is, it unfolds its poverty of noise when driven by a low ohmic-source (in contrast to noise current optimisation). Its noise corner frequency lies around 2.7 Hz, a very good value, which vindicates the requirement for low noise at low frequencies. At present the metal-cased versions are significantly dearer, also somewhat better.

The voltage dividers comprising R111, R112 and R113 and the corresponding resistors in the ± 15 V section respectively deserve special attention. If the voltage division relationship varies by one part per million (one millionth), this corresponds to an output voltage change of 30 μ V. Using

metal layer resistors (± 50 ppm per $^{\circ}$ C), a temperature difference of one degree on the resistors could lead to a voltage fluctuation of up to 1.5 millivolts. The uniform behaviour (not unconditionally the constant behaviour) of resistors' temperatures is achieved in the following ways:

- Moderate loading. use 1/4W resistors for passing 50mW.
- Important! All resistors to be of the same wattage. In non-round-figure division relationships, the voltage U_R on each resistor is the largest common divider of the output and reference voltage. Example: reference voltage = 10V; Operating voltage = 12V; largest common divider = 2V = U_R so six equal resistors are used. See Fig.10.
- Use metal layer or film resistors.
- Build up resistors about 20mm. Trim leads to equal lengths. Solder pads to be of equal size (conducting away heat). Resistors should touch (to equalise heat transfer). Insulate them externally (some lengths of insulating tape are fine, see Fig.10). (Try building the divider once without insulation, with the resistors well away from the PCB. Then observe the output voltage on the oscilloscope whilst blowing gently on the divider!).

Further details:

- Sockets can produce noise, so solder in all components direct.
- In the precision section no potentiometers should be used. Their snags: increased temperature drift, noise, jumping of the pot's wiper in the confusion.
- For the 100nF capacitors use the

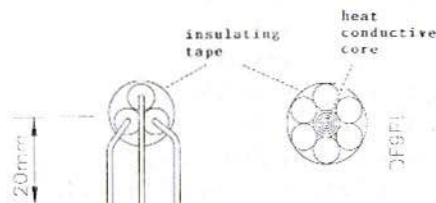

Fig.10: Arrangement of voltage divider resistors



polycarbonate MKS02 type; they are higher-quality than ceramic types and are still very small.

- Avoid air streams unconditionally (put everything in cabinets).
- Power components, which produce heat, should not be placed next to voltage dividers or semiconductors.
- Pre- and precision stabilisers should be on separate PCBs, the latter being placed in metal cases and kept well away from transformers and wiring carrying 50 Hz.

Once again it should be mentioned that the output voltage should be fed symmetrically and potential-free to the load devices, that means that unlike normal situations, the zero-volt line should not be soldered to the case.

The PCBs developed as DF9PLxxx observe all these rules.

Ahead of the transformer a mains filter should be connected. The best sort is the type combined with an IEC power connector, where an all-enclosing metal collar makes it also RF-proof. The best transformer is one with a copper screen winding taken to the system earth. Even better are the interference-proof transformers with a magnetic screen made by the Riedel company (6).

When connecting the +35V voltage, check its exact value. The OP- 27 tolerates a maximum of 44V and other op-amps tested experimentally would only take 36V! To fully drive the final op- amp stage a minimum of 34V are necessary.

5. COMPONENT LIST

5.1 +30V section

- 1 off 1000uF/63V
- 5 off 100uF/40V
- 4 off 10uF/40V
- 9 off 100nF MKS-02
- 1 off 10pF ceramic
- 5 off 1N4148 or 1N4007
- 2 off 1N4007
- 1 off rectifier B80C1500
- 1 off horizontal flat 1k potentiometer
- 1 off transistor BD139
- 1 off voltage regulator LM317
- 1 off voltage regulator TL317
- 1 off voltage reference REF-01 (PMI)
- 1 off op-amp OP-27 (PMI)
- 1 off transformer 6VA 30V (e.g. BLOCK FL6/15)

5.2 ±15V section

- 1 off 2200uF/50V
- 1 off 1000uF/50V
- 8 off 100uF/25V
- 4 off 10uF/25V
- 23 off 100nF MKS-02
- 1 off 10pF ceramic
- 4 off 1N4007
- 7 off 1N4148 or 1N4007
- 2 off rectifier B80C1500
- 1 off transistor BD139
- 1 off transistor BD140
- 1 off voltage regulator 7820
- 1 off voltage regulator 7920
- 1 off voltage regulator 79L09
- 1 off voltage regulator 78S05 (2A)
- 1 off voltage regulator 78S12
- 1 off voltage reference REF-01 (PMI)
- 1 off voltage reference REF-08 (PMI)
- 1 off op-amp OP-27 (PMI)



- 1 off transformer 50VA 24V
(e.g. BLOCK FL52/12)
- 1 off transformer 30VA 24V
(e.g. BOCK FL30/12)

6. LITERATURE

- (1) Precision Monolithics Inc. (PMI):
Application Note AN-15;
Minimisation of Noise in Operational
Amplifier Applications
- (2) PMI: Data Sheet OP-27; Low Noise
Precision Operational Amplifier;
edition 7/89
- (3) PMI: PMI Data Sheet REF-01; +10V
Precision Voltage Reference; edition
8/87
- (4) PMI: PMI Data Sheet REF-08;
Negative 10V/10.24V Voltage
Reference; Advance Product
Information; edition 10/87
- (5) Neubig, Bernd DK1AG: Extremely
Low-Noise 96 MHz Crystal Oscillator;
VHF Communications 3 and 4/81
- (6) Kilgenstein, Otmar:
Stoerspannungssicherung; EMV-
gerechte Stromversorgung mit
Spezial-Netztransformator; ELRAD
9/91, Heise-Verlag
- (7) Author unknown: Ist der Schirm sein
Geld wert? Schirmkontaktierung;
EMV-ESD 1/91; VP-Verlag
- (8) Jaeger, D.: EMV-gerechte
Ausfuehrung von Verkabelung und
Masseverbindungen; Kontakt und
Studium Band 41; Elektromagnetische
Vertraeglichkeit; Expert Verlag
- (9) Jirmann, J., DB1NV: A Spectrum
Analyser for Amateurs; VHF
Communications 3/87, 4/87, 2/89,
3/89, 1/90, 3/90, 3/91, 4/91
- (10), (11) & (12) As (9)

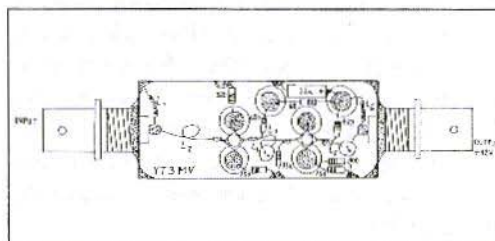

Very low noise aerial amplifier for the L-band as per the YT3MV article on page 90 of VHF Communications 2/92. Kit complete with housing Art No. 6358 DM 69. Orders to KM Publications at the address shown on the inside cover, or to UKW-Berichte direct.

Dr-Ing. Jochen Jirmann DB1NV and Wilfried Hercher DL8MX

Improvement of the Intermodulation Performance of modern Amateur HF Receivers

Anyone observing the HF bands over a long period and having a broadband antenna at his disposal will have noticed, among other things, that in really dead bands (e.g. the amateur 10-metre band) a multitude of carriers can be heard at 5kHz spacing. The novice listener puts this down to external sources of interference such as line output stages of TV receivers.

Closer examination shows that these carriers do indeed possess broadcast modulation. Cutting in the RF attenuator or adding an antenna tuner causes this interference to disappear. Even instruments having (on paper) extremely good intermodulation performance are not spared these interfering carriers.

The following is a discussion of the source of this interference and some preventive measures.

1. BAND OCCUPANCY AND ANTENNA SIGNAL LEVELS

Europe is the region on the Earth where the most high-power MW and SW transmitters are to be found. Consequently the RF level appearing on broadband antennas and with which radio receivers must cope is high.

Fig.1 shows an spectrum analyser print-out of the range 0 to 20MHz, taken on a February afternoon. The reference level at the upper edge of the illustration is 30dBm or 7mV into 50 ohms. In this example the analyser was driven by an active antenna of 1 metre length alone, with no additional amplifiers.

With good antennas one can reckon on levels above 100mV therefore. In Fig.1 you can see all the short wave broadcast bands from 49 metres to 16 metres.

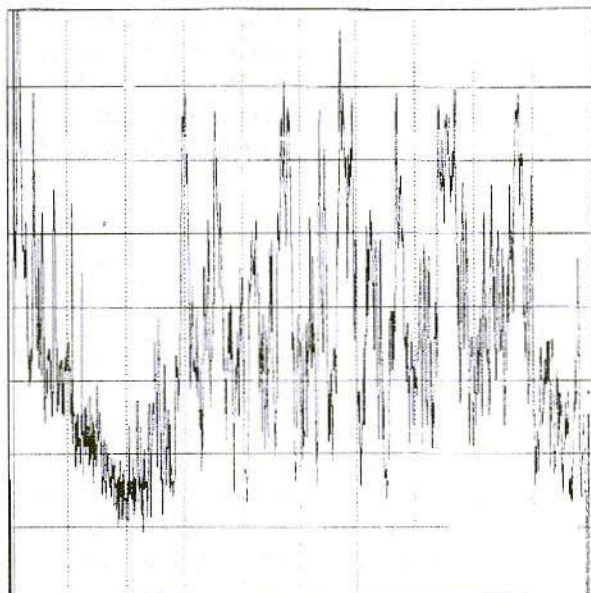

Fig.1:
Band occupancy in
the frequency range 0
to 20 MHz.

With these signal level relationships in mind, it is easy to explain the phantom signals observed as mixing products (sum frequencies) of strong radio stations. The actual creation point of the intermodulation signals must lie somewhere between the antenna input and the HF band-pass of the shortwave receiver. This is because on the one hand, moderate RF attenuation of from 5 to 10dB suppresses the interference signals more than proportionally, and on the other hand, the fundamental frequencies of these radio stations can not pass through the band-pass filters of the receiver.

Practical test showed in addition that not all receivers are susceptible to the same degree: the Icom transceiver IC765 produced extremely strong interference signals (S9 in the 10- metre band) whereas the Kenwood TS940 was scarcely affected. Also the conceptually old-fashioned Kenwood R2000 receiver is not unusable.

When searching for the source of this intermodulation interference, every component in the RF input section of the receiver having a dog-leg characteristic curve comes under suspicion; that means above all semiconductors but also over-driven filter coils with ferrite cores.

2. CIRCUIT ANALYSIS OF JAPANESE TRANSCEIVERS

Circuit analyses carried out on Japanese receivers (and the receiver sections of transceivers) showed up constructional errors that once again proved that their chief concern is with the general appearance and appeal of their nice shiny front panel layouts. The cause of the interference lies in the switching of the input

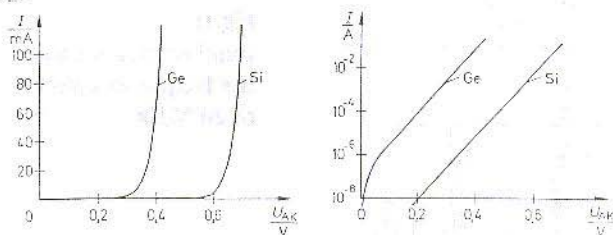

Fig.2:
Characteristic curves of semiconductor diodes represented in (left) linear and (right) semilogarithmic fashion.

band-pass filters. That a changeover relay takes up space and costs plenty of money is certainly understandable, but the author finds it remarkable that all manufacturers use normal general purpose diodes like the 1N4148 instead of the correct PIN diodes! Only the two Kenwood devices mentioned above use VHF band-switch diodes from TV tuners, which already lifts the receive characteristics above base level. One can only speculate on the cause of the general cheapskate approach though it is probably not far removed from the relative cost of the PIN diodes, which can be rationalised away on commercial grounds.

3. THE BEHAVIOUR OF DIODES AS RF SWITCHES

To understand the differences between a normal silicon diode and a PIN diodes when used as an RF switch we need to make a quick foray into semiconductor physics.

The current flowing in a semiconductor diode depends on the voltage applied to it according to an exponential law, which can be represented with gross simplification as

$$I = K_1 (e^{K_2 \cdot U} - 1) \quad (1)$$

Constants K_1 and K_2 relate above all to the material characteristics of the semiconductor and to temperature. This equation describes the typical characteristic curve of a diode, represented in Fig.2 in linear and semilogarithmic fashion.

As we can see, with a small basic bias on the diode, a small change in voltage ΔU brings about only a small change in current ΔI . If the fundamental bias on the diode is large, the same change in voltage ΔU causes a significantly larger change in current ΔI . In other words, the diode's differential internal resistance $R_d = \Delta U / \Delta I$ can be varied by the diode voltage over a broad range. The internal resistance R_d can be written as

$$R_d \approx \frac{0,0863 (273 - T)}{I} \quad (2)$$

where T = temperature in $^{\circ}\text{C}$.

This application as a controllable resistance opens up interesting applications in RF technology. For a start it means we can use the switching of diode voltages to control the internal resistance between extreme values between close to zero and nearly infinity, which allows the electronic substitution of a relay contact. It also means this continuous variation of internal resistance can be used for modulation, mixing or level regulation of signals. Since a diode has just two connection of signal and control voltage, it is important to ensure that the signal is kept much smaller

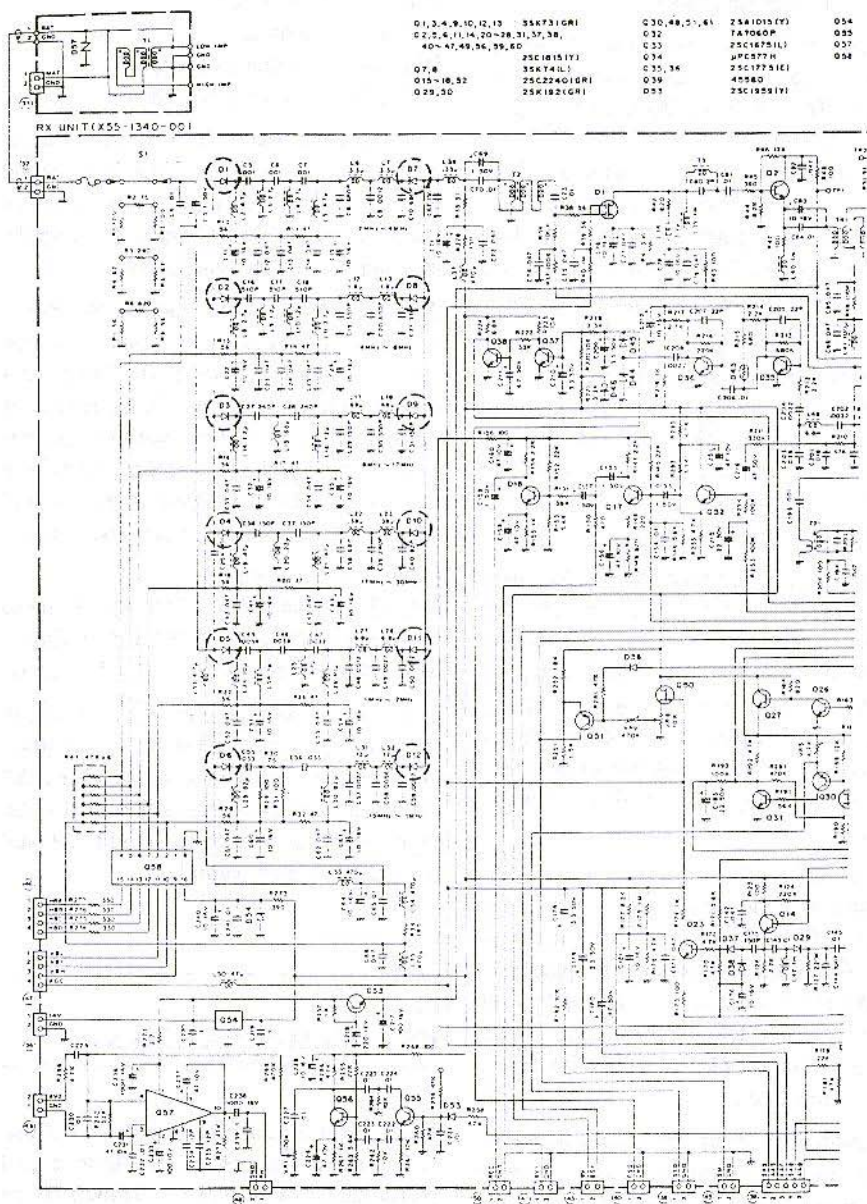

Fig. 3: Circuit diagram extract: band-pass module.



than the control voltage, since otherwise the signal level applied could modulate the diode's internal resistance.

It is exactly here that we must look for the cause of the interference already mentioned. The multiple broadcast stations produce a signal level that lies in the order of magnitude of the diode control voltage and modulates this in opposition. Certainly the broadcast signals are removed subsequently by band-pass filtering but the intermodulation products lie in the pass-through range and are thus audible.

So, if we now use normal general purpose diodes for switching, with switching times of a few nanoseconds, these diodes can follow the applied RF and work, as described above, as controllable resistors and hence as mixer stages.

A significant improvement can be made with switching diodes chosen for their "slow" operation, allowing their internal resistance to be controlled still using DC without the applied RF voltage modulating their internal resistance any more. Diodes of this kind are known by the name of PIN diodes, standing for Positive-intrinsic-Negative.

The unendowed intrinsic zone or self-conduction zone, produced during manufacture of the diode, makes the diode so slow that above a limiting frequency of around 1MHz (according to type), it can be regarded as a DC-controlled resistance. For lower frequencies, however, it behaves as a normal diode.

PIN diodes are offered by several semiconductor manufacturers, and the following table gives a general survey (without any claim to exhaustiveness).

BA379	Siemens, remainder stock on sale
BA389	Siemens
BA479	Telefunken
BAR12-1	Siemens
5082-3080	Hewlett-Packard
5082-3081	Hewlett-Packard

Unfortunately there is a trend among manufacturers to replace the wire-ended versions with surface mount devices (SMDs), which doesn't exactly simplify their application in amateur use.

A variant of the PIN diode is the band-switch diode used in TV tuners. These behave similarly to PIN diodes but have a higher limiting frequency, in the region of 10MHz. They are suitable without reservation for the application named, switching band-passes in short wave receivers, and always better than general purpose diodes.

Commonplace types are:

BA243, BA244, BA282, BA283:	Siemens
BA423, BA482, BA483, BA484:	Philips
MPN3404, MPN3700:	Motorola

With this knowledge now at our disposal, the route to improving the intermodulation characteristics of a receiver is clear. All switching diodes lying adjacent to the input band-pass must be sought out and replaced by better examples.

4. REMEDIAL MEASURES

With the wisdom now acquired we can now set about improving the large-signal performance of a receiver known to be sensitive under ideal conditions, by replacing the "suspect" switching diodes around the input band-pass filter with PIN diodes.



Unfortunately there is no patent formula for selecting the right components; examining the circuit diagram will, however, reveal the band-pass section. The band-pass section illustrated here is from an elderly Kenwood R2000. The marked diodes D1 to D12 (in this case BA244), which in each case lie in series with the inputs and outputs of the band-passes, are to be replaced by PIN diodes, noting the polarity of the diodes. Anyone unsure whether he has found the right diodes should call upon the help of an experienced amateur.

In an Icom IC765, which exhibited particularly strong phantom signals in the 10-metre band, the author replaced all switching diodes (1SS53, a universal diode equivalent to the 1N4148) adjacent to the band-pass filters with the Siemens BAR12-1. Apart from a fine-tipped soldering iron, solder wick, screwdriver, side-cutters and pliers, no special tools were required. The time involved was about an hour. As described next, this was time well spent.

5. TEST RESULTS AND EXPERIENCE

To check the results of our rebuilding activities, the receiver's sensitivity was checked before and after the work. Using a simple measurement set-up, a coarse determination was also made of its intermodulation behaviour. Sensitivity measurements indicated no noticeable alteration; this shattered the thoughts of some sceptics, who had prophesied an intolerable reduc-

tion in sensitivity as a result of the higher internal RF resistance of a PIN diode in its in-circuit condition (around 5Ω)

For intermodulation measurement two test generators (an HP8640 and an SG1000) were applied to the receiver's input via a resistive summer. These signal generators were tuned to 12 MHz and 15 MHz respectively, and the receiver was tuned to 27 MHz. The RF signal level was raised so as to read S8 on the S-meter display. Since this meant an input level of almost a milliwatt, it was expected that intermodulation products would be formed in the final stages of the signal generators as well, thus falsifying the results. All the same, it turned out that after fitting PIN diodes around 5dB more (almost one S step) input signal could be applied to achieve the same level of intermodulation. Since receiver sensitivity had remained the same, on the basis of the previous measurements, it can be taken that the dynamic range of the receiver had been improved by at least 5dB.

A comparison carried out by Wilfried Hercher DL8MX underlined these tests; in this case the IC765 and a TS940 were connected alternately to the same antenna by a switch. Under favourable propagation conditions the IC765 produced (before the rebuild) phantom signals at over S9 in the 10-metre band, whilst the interference in the TS940 was already audible with no deflection of the S-meter. After the modification the IC765 and TS940 both proved equal in performance, the IC765 having the slight edge.

An afterthought. While these investigations were already in progress, a similar treatment appeared in an American technical publication, leading to the same conclusions.



Dr-Ing. Jochen Jirrmann DB1NV

A Digital Framestore for the Spectrum Analyser: alterations and additions

In issues 3/91 and 4/91 of VHF COMMUNICATIONS we presented a digital frame store DB1NV 010 for the spectrum analyser DB1NV 006-009. It distinguished itself in the following qualities:

- Through the analogue interface to the analyser and VDU, adding a framestore causes no special problems of modification.
- Thanks to the CMOS technology employed, the current requirements are so low that this subsequent add-on does not necessitate an extra power supply.
- Since the spectrum data are already in digital form, output to a graphics plotter is possible.
- A reference curve can be stored.
- Digital averaging improves the signal-to-noise ratio on stable signals.

Meanwhile user reports came in, suggesting various modifications. In this connection particular thanks go out to Michael Kuhne DB6NT for his numerous ideas.

1. HARDWARE MODIFICATIONS

Practical use of the equipment showed that very narrow spectral lines could not be represented with their full amplitude on the screen, although they were shown correctly on screen-dump print-outs. The cause is the low-pass filter between D-to-A converter 14 and analogue switch 13 in the Y channel. This filter was dimensioned to give a "flat" representation of spectral lines without producing steps or brightness

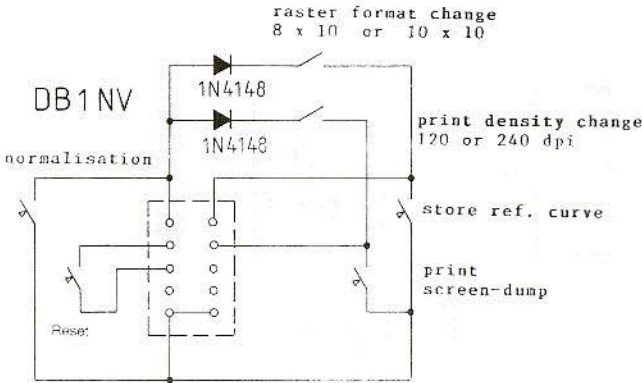

Fig.2:
Extended application
range for the
Framestore DB1NV
010

modulation looking like strings of beads. As a result the build-up time is too long for rapid signal changes (i.e. for very narrow lines).

A higher limiting frequency for the filter would reduce the build-up time, but would allow the jumps in amplitude between adjacent pixels to show up as steps or bright spots. The solution calls for a non-linear low-pass, as seen in Fig.1. For small variations in amplitude of the output signal from the Y-channel D-to-A converter, the previous low-pass remains effective, but with large changes in signal the two Schottky diodes start to conduct and shunt the longitudinal resistances. The series resistance of 6.8kohms was determined experimentally according to the best picture impression. For the Schottky diodes general purpose types such as the BAT43, the 1N6263, the BAS40 or the HSCH1001 are used; the only thing significant is the threshold voltage vis-a-vis normal silicon diodes. The three components are wired up "in mid-air" between pin 2 of IC4 and the wiper of potentiometer P2.

During the investigation of new add-ons to the frame store it became clear that the quality of the A-to-D converters used was

getting clearly better with respect to the seizure time, with the result that the frame store could now be driven at higher frequencies, giving a more stable, less flickery picture. On the author's own sample, the circuit would now operate in stable fashion at 27MHz, whereas the original prototype was already showing error conditions at 20MHz. A timing frequency of 20 to 24MHz seems certainly within our grasp. Anyone seeking further improvement can check out the following:

- Remove IC12 from its socket, carefully bend out pins 18 and 19 of the microcontroller 80C31S and replace the IC.
- To pin 19 connect a signal generator feeding a level of approx. 10dBm via a 1nF capacitor.
- Increase the frequency upwards from 18MHz until function errors appear.
- Replace the existing 18MHz crystal with one 1 or 2MHz lower than the maximum value determined in the previous step.

It is recommended that you carry out these trials with a device that is already warmed-up, since the maximum timing frequency drops with increasing operating temperature.



2. SOFTWARE ADDITIONS

Since the framestore is usable universally with almost all spectrum analysers and sweep generators, the following software enhancements will prove advantageous when it is used in combination with other designs of instrument.

- Keyboard scanning is arranged so that now the mode of operation can be changed already during flyback blanking (pin 15 of IC12 high). With analysers having a single sweep mode, keyboard scanning was previously blocked during the wait phase of scanning.

- The screen-dump sub-program can be switched between two printer resolutions. In the normal case printing is at 120 dots per inch, producing a horizontal (landscape) print-out on an EPSON-compatible printer and a quadratic print-out of 192 dots per inch on the HP-Thinkjet. EPSON-compatible printers must, however, be set up to work in landscape A4 mode. If a diode is connected on the microcontroller from P3.0 (pin 10) to P3.2 (pin 12), with the anode pointing to P3.0, the print density is changed to 240 dots per inch. This gives an output using simpler printers which can only work in A4 vertical (portrait) format. The HP Thinkjet ignores this control code and carries on printing with 192 dots per inch.

- The raster generator can be switched using a diode connected from P3.0 (pin 10) to P3.1 (pin 11), anode to P3.0: without the diode in place, the raster is printed with 8 *

10 components, corresponding to the normal oscilloscope screen display. With the diode in circuit, a 10 * 10 raster is produced, which is more convenient for older HP VDUs with round tubes and for Ailtech spectrum analysers.

- A push-button connected between P3.0 (pin 10) of the microcontroller and ground activates a new mode of operation, "normalisation". Pressing the button first stores a straight curve as a reference and then represents all curves produced afterwards as difference from the reference curve. This makes it possible with sweep generators to store the frequency behaviour of a measurement circuit without the object under test and to work this out automatically for subsequent measurements. During screen-dump the normalised curve is printed out.

- In addition, some alterations have been made to the source code, making minor improvements to the screen representation (but not desperately interesting for the user). the author is prepared to offer advice on this to readers interested.

Below the screen-dump print-out there now appears a prepared data field in which users can retain the measurement conditions.

Fig.2 shows a new circuit for the 10-way connector with its extended applications. The switches for raster and print-out format change can of course be left out, and if desired, the diodes can be soldered directly beneath the printed circuit board. EPROMS with the new framestore software (version 1.2) can be obtained from the publisher or from the author.



Wolfgang Schneider DJ8ES

SSB Transceiver for 50 MHz using 50Ω modules

Part-2

(Revised version of the presentation given at the 1991
Weinheim VHF Convention)

3.

THE RECEIVE MIXER

Since the transceiver is to be used both on the 6-metre band and in combination with other transverters, the receiver input is not provided with a low-noise transistor at the front end, in contrast to other concepts. Following the 3 pole filter we have the first amplifier stage, the ring mixer, broadband matching, another 3 pole filter and the second amplifier (Fig.16).

3.1 Construction details

The receive mixer is constructed on a printed circuit board with the dimensions 72mm by 72mm. This is soldered in matching tinplate case and the components are added (Fig.17).

3.2 Components

- 2 off BFR90 (Siemens) or equivalent
- 4 off 1N4148
- 3 off Neosid ready-made filters 0.3uH, BV5049 (yellow, white)
- 2 off Neosid ready-made filters 0.9uH, BV5046 (yellow, blue)
- 3 off Neosid ready-made filters 4uH, BV5056 (green, blue)
- 2 off foil trimmers 40pF (grey), 10mm pin spacing
- 3 off foil trimmers 70pF (yellow), 10mm pin spacing
- 1 off foil trimmers 90pF (red), 10mm pin spacing

Capacitors and resistors are surface-mount types

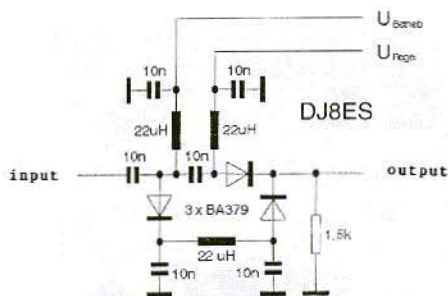

Fig.26: PIN diode regulator

Figures 21 and 22 following can be used as a guide to component layout. The illustrations show how the components used are placed either on the track side (all the SMD ones, for instance) or else on the so-called component side (for example the Neosid coils, trimmers and transformers).

4.2 Components

- 1 off BFR90 (Siemens) or equivalent
- 1 off BFR96 (Siemens) or equivalent
- 4 off 1N4148
- 2 off Neosid ready-made filters 0.13uH, BV5063 (blue, orange)
- 3 off Neosid ready-made filters 0.3uH, BV5049 (yellow, white)
- 2 off foil trimmers 40pF (grey), 10mm pin spacing
- 1 off foil trimmer 70pF (yellow), 0mm pin spacing

Capacitors and resistors are surface-mount types

4.3 Commissioning

After connecting power (+12V, 75mA) and the VFO, the transmit mixer can be brought into operation. The only alignment is tuning the 3 pole filter for maximum output.

With a drive of 100uW at the IF level (9 MHz from a signal generator or an SSB exciter), a good 50mW should be achieved at the output.

5. IF AMPLIFIER WITH AGC/ALC

An IF amplifier is composed of:

- an amplifier
- a crystal filter
- something to produce a regulated voltage
- a regulator.

In the block diagram of a conventional IF amplifier the arrangement of the individual components and the way they interact can be seen (Fig.24). The IF amplifier developed for the SSB transceiver uses separate modules for the amplifier itself and the regulation for AGC/ALC. The functional units necessary are split into two modules therefore.

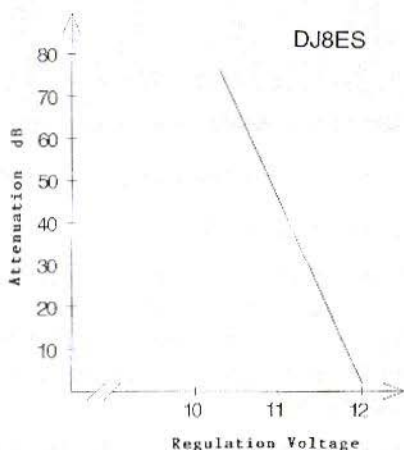

Fig.27: Regulation characteristics of the PIN diode regulator

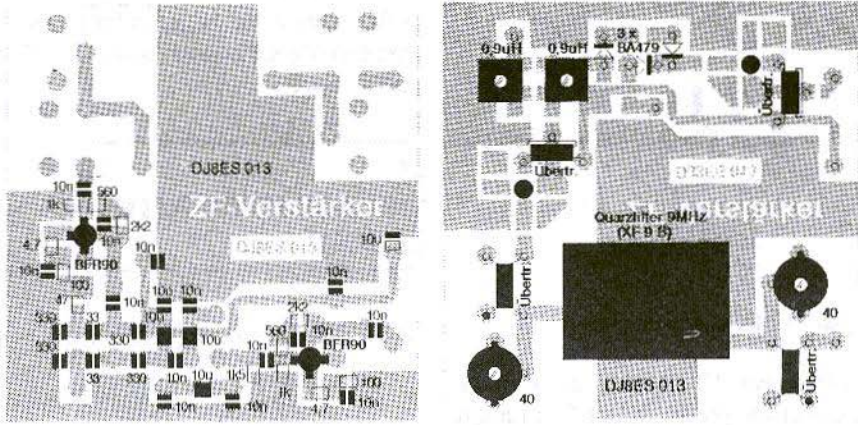

Fig.28: Component layout of the IF amplifier DJ8ES 013

a) component side

b) track side with SMDs

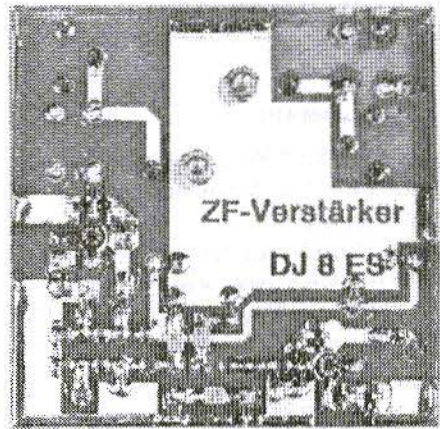
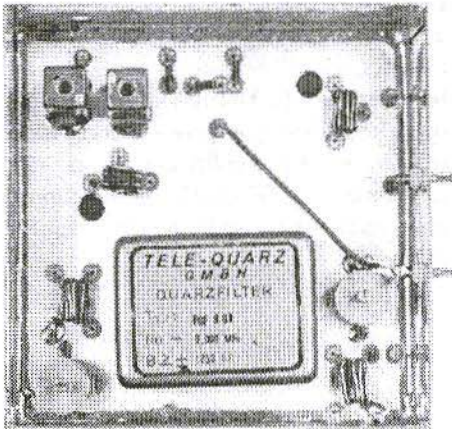

Fig.29: Sample construction of the IF amplifier group DJ8ES 013

5.1 The IF amplifier

The crystal filter, in my sample an XF9B, is matched to 50 ohms on its input and output by 9:1 transformers. In addition, 90pF trimmers are provided for the capacitive component.

An amplifier stage raises the 9 MHz signal, which is defined closely in bandwidth, by around 23dB.

The IF is taken out via a 20dB coupler at the output AGC OUT. This signal is used in the production of the regulating voltage and also for an S-meter display.

The regulating voltage produced in the AGC module has a feedback effect on the IF amplifier through the PIN diode regulator.

The amplification afterwards, in the highly



regarded broadband amplifier, guarantees the degree of IF amplification required by the total concept.

For regulation in IF stages there are generally two options. One is regulation of the amplifier stages, for example through the G_2 voltage of MOS-FETs; the other is regulation with PIN diodes.

Fig.26 shows the circuit of a PIN diode regulator and the behaviour characteristics of its regulation.

With an IF of 9 MHz this regulator shows an insertion loss of only 1.2dB. The dynamic range amounts to 75dB. From this characteristic curve arises a slope of around 40dB/V.

Beside the large regulation range, the PIN diode regulator is also superior to transistor stages thanks to its better intermodulation characteristics.

5.1.1 Construction details

The IF amplifier module is built up, as normal, on double-sided copper clad epoxy PCB material, with a thickness of 1.5mm.

The PCB has the dimensions 72mm by 72mm and is soldered inside a matching tinplate casing.

Special care should be devoted to wiring up the 9:1 transformers. Any "twist" in the transformer windings will have significant influence of the transformation characteristics of the module.

When installing the crystal filter pay attention to a good connection to chassis. At the same time, avoid any wafer-thin short circuit contacts.

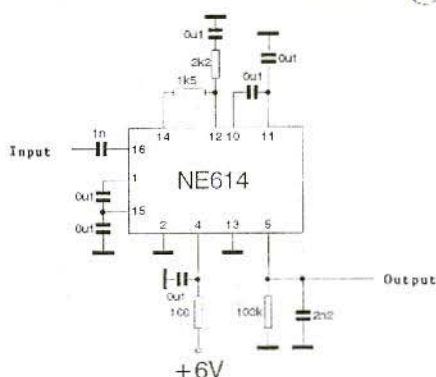

Fig.30: Circuit using an IC to produce regulated voltage

5.1.2 Component list

- 2 off BFR90 (Valvo)
- 1 off BA479
- 1 off SSB crystal filter (e.g. XF9B)
- 2 off Neosid ready-made filters 0.9uH, BV5046 (yellow, blue)
- 3 off Neosid ready-made filters 0.3uH, BV5049 (yellow, white)
- 3 off 33uH choke (SMD type)

Capacitors and resistors are surface-mount types

5.1.3 Commissioning

After applying the operating voltage (+12V) the module should draw about 55mA of current. For maximum through

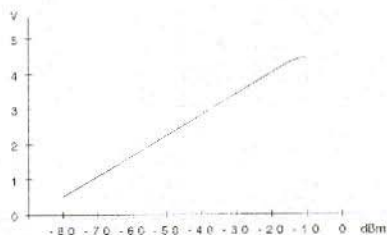

Fig.31: Voltage regulation showing its dependence on input level

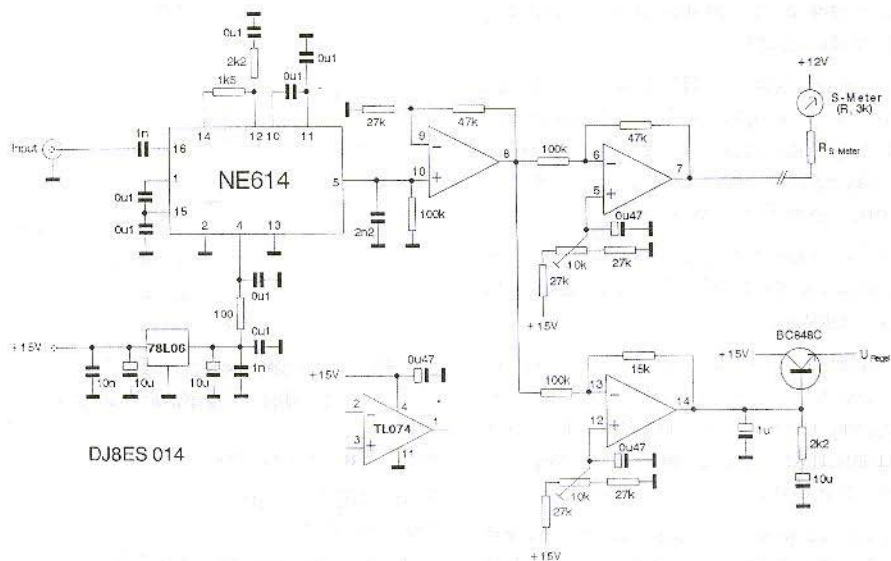

Fig.32: Complete circuit for AGC/ALC module DJ8ES 014

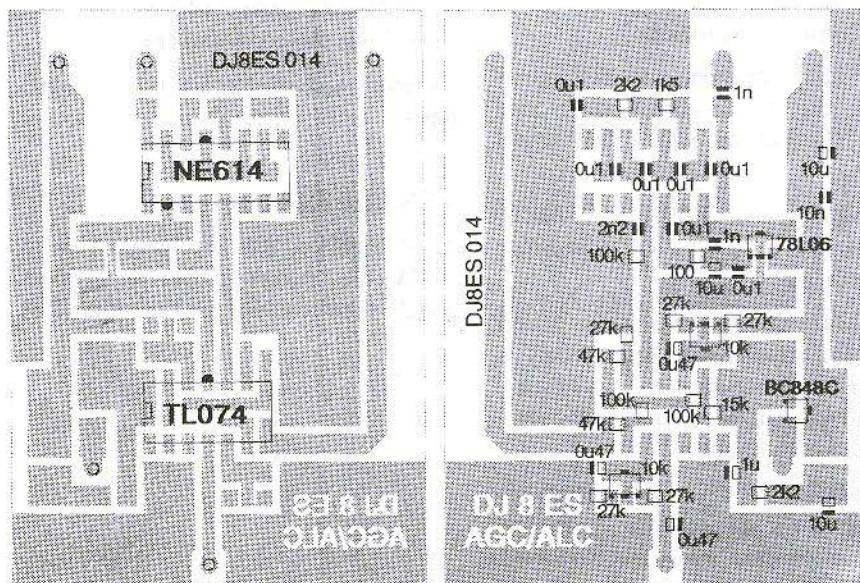

Fig.33a,b: Layout of the component side (a) and track side (b)



amplification the operating voltage should also be connected to the regulated voltage control input.

The matching of the crystal filter is optimised with the two trimmers on its input and output. For this purpose a DSB 9 MHz signal is fed from the SSB exciter. The trimmers should be adjusted for minimum residual carrier.

5.2 AGC/ALC module

For producing the regulation voltage and driving the S-meter we use an NE614 (Fig.30), as for an FM IF system. The IC contains among other things a circuit for displaying signal strength.

The field strength display (Fig.31), which operates logarithmically over a range of 80dB, can be used twice. On the first occasion the NE614 simplifies significantly the construction of an exact-reading S-meter, and the display achieved in this way can also be used for producing the regulating voltage used in the IF amplifier.

In the complete diagram of the AGC/ALC module (Fig.32) the output of the field strength indicator (NE614) is developed further. The op-amp connected following it permits the level matching for the S-meter and for the PIN diode regulator. Employ-

ing a four-in-one op-amp (TL074) makes for compact construction layout.

5.2.1 Construction details

Like the other modules before it, the AGC/ALC unit is also constructed in a separate tinfoil casing. The PCB measures 53.5mm by 72mm.

Because of the NE614's high level of sensitivity, the construction of the module must be screened. Unavoidable electrical fields (mains wiring, neon lamps, etc.) can produce an S-meter reading, even when not nearby. Built inside a tinfoil casing, with the lid on, the module works as wished for, however.

5.2.2 Components

- 1 off NE614 (Silconix)
- 1 off TL074 (Texas Instruments)
- 1 off TA 78L06F
- 1 off BC848C (Siemens)
- 2 off trimmer pots 10kohms (SMD type)
- 1 off S-meter (50uA, 3kohms)

Capacitors and resistors are surface-mount types

TO BE CONTINUED



The Editors

Poor Man's CAE 1 & 2 Public Domain Software Development Programs for the IBM PC

Although it is not normal practice to conduct product reviews through the pages of VHF Communications, the editors felt that it was well worthwhile acquainting the readership with these software packages.

Poor Man's CAE 1 & 2 are two extensive collections of programs for the IBM PC and compatible computers have been compiled and documented by Jörg Smith Ing.(Grad.)DJ5UN.

The software should be very useful for radio amateurs, professional engineers and students alike, to aid in the design of communication equipment, etc.

Each of the packages comes on 5.25" discs and is complete with a well-produced and bound manual. Both are a collection of forty programs. The computer require-

ments are very basic, an PC or compatible with a minimum of 256k of RAM, MS-DOS and GW-BASIC, a printer for some of the routines and virtually any display adapter.

The following is an abbreviated list of the program descriptions:

CAE No.1

Antenna Design

Parabolic Antenna Design Program

Amplifier Design

Amplifier Analysis Using S Parameters
Matching Using Stern's Stab. Factor
Design of Amplifiers Using S Parameters
Cad of Microwave Transistor Amplifiers



Noise Calculations

Converts S, Y, Z, H, A, Parameters

Component Calculations

Helical Resonator Design
Design and Analysis of Coils, Calculates Inductivity of: Wire, Strap, Coil, Microstrip Microstrip Dimension

Analysis/Synthesis of Parallel Plate Cap's and Microstrip

Magnetic Core Calculations

Synthesize and Analyse Microstrip Lines

Calculate Cut-Off Frequency Of Wave Guide

Active/Passive Filter Networks

Modern Filter Design

Low Impedance Double Tuned Circuit

Cascade of Active Filters (LP, HP, BP)

Design Narrow Bandpass Filter With a Basic Program

Matching Networks

Design "H", "T" Attenuators

Design "Pi", "T" Matching Networks

Design L-Matching Networks

Smith Chart Calculations on Your

Microcomputer

Simple Bandpass Filter Synthesis

Matches Load to Source with Desired Q

Calculates Z from Reflection Coefficient and Vice Versa

Network Analysis

A Ladder Analysis Program for Passive Components

Network Analysis of Active Parts

Propagation Calculations

Communication Range as Function of Rx/Tx Antenna Parameters

Calculates S/N Ratio at Satellite

Troposcatter Path Loss Calculations

Calculates Maximum Height of an Object in a Loss Path

Receiver Calculations

Intermodulation Products

Mixer Spur Calculations

Noise Factor of Cascaded Stages

Approach to Calculate Intercept Point and Noise Figure

14 Routines for the RF Engineer

CAE No.2

Antenna Design

Capacity and Radiation Resistance of a Short Vertical Antenna

Calculation of Helical Short Antennas

Amplifier Design

Amplifier Calculations using S-Parameters

Component Calculations

Inductance of a Straight Rectangular Bus

Inductance of a Hairpin Loop

Program to Calculate Spiral Inductors on a Printed Circuit Board

Twisted Wire Transmission Line

Impedances

Filter Networks (Active/Passive)

Chebyshev Filters with Arbitrary Source and Load Resistances

A Design Program for Chebyshev Low Pass Filters

Disk Rod Low Pass Filter Design

Elliptical Lowpass Filter Loss Program

A Design Program for Elliptical Low Pass Filters

Computer Aided Interdigital Bandpass Filter Design

Equal Ripple LC Filter Synthesis

Calculation of Passive Low/High Pass Filters (Lin., Phase, Butterw, Chebys.)

A Design Program for Butterworth Low Pass Filters



Basic Program for Op-Amp Active Filters
L.Orloff's Unequal Terminated Filter
Design

Matching Networks

Cad for Lumped Element Matching Circuit
T Pad/Pi Pad Calculations

Microstrip Applications

The Program Computes Various
Parameters of Microstrip Circuits, including
Impedance, Dielectric Constant, Line Widths,
Capacitor and Inductor Dimensions, Delay,
Dispersion, Loss and Propagation Delay

Program for Analysis and Synthesis of
Microstrip Couplers
Cad Amplifier Matching with Microstrip
Lines
A Parallel-Coupled Resonator Filter
Program
Impedance of a Transmission Line

Network Analysis

A Ladder Analysis Program
Network Analysis for Active/Passive
Components

Other Programs

Program to find the Approximate Coax
Cable Loss Between two Specified
Frequencies
Heatsink Design

Transmission Line Loss Calculations
Linear Full Wave Regulated Power Supply
Design with off-the-shelf Components, for
use with GW-Basic
Basic Ripple Voltage Calculations for a
Power Supply

Propagation Calculations

Pathloss Calculations
Program to Calculate the Elevation Angle
from a Transmitter
Propagation Range Calculations using
Egli Model

Receiver Calculations

Noise Bandwidth Calculation
Calculation of Noise Temperatures of Two
Stages from Noise Factor and Gain
Q-Problem Program
Combining Gain, Noise Figure and
Interception Point for Cascaded Elements
Calculation of Spurious Frequencies

Utility Programs

Program To Hold Screens In Memory
Program To Print The Screen To An Epson
Printer (Lx850 Or Similar) When Using Ega
Graphic Mode

These program collections are available
from KM Publications at a cost of £70 each
plus £5 post and packing

YAGI ANALYSIS v.3.52

**YAGI ANTENNA DESIGN ANALYSIS AND ANTENNA MODEL-
LING SOFTWARE FOR THE PC**

£65 + £5 p&p (Demo disc £10.00)

KM Publications, 5 Ware Orchard, Barby, Nr.Rugby, CV23 8UF, UK

Tel: 0788 890365 Fax: 0788 891883



CAMTECH [®] ELECTRONICS

21 Goldings Close, Haverhill
Suffolk, CB9 0EQ, England
Tel: 0440 62779 Fax: 0440 714147

- TXV4000** 24cm Low cost Video transmitter, excellent miniature VFO design, 400mW output, 12V DC input, Ready assembled and cased transmitter.
- TXV4001** 24cm Two channel PLL video transmitter module, 400mW output, 26 MHz bandwidth. 12VDC input, complete built and tested surface mount assembly.
- PA1001** 24cm Power amplifier module to compliment TXV4000 series transmitters, 2.5 Watt output, 12V DC input.
- LHA2001** 24cm Pseudomorphic HEMT ultra low noise GaAsFET preamp, outstanding performance using 0.15dB noise figure PHEMT! Supplied in weatherproof IP65 enclosure with N connectors.
- CV7001** 24cm Down Converter, 40MHz IF output, 27dB Gain, 1dB Noise Figure. Complete built and tested surface mount assembly.
- MI9001** Phase Lock Loop module based on Plessey SP5060 IC. Complete synthesiser on a single PCB, includes regulator and loop filter components.
- VIDEOIF** Camtech's complete video IF card demodulator, IF at 40MHz with 6MHz sound demodulator all on a single Euro card PCB.
- ASG+VOGAD** Intercarrier sound modulator board for TXV4000 series transmitters, enables you to transmit sound with your video pictures.

Specialist 24cm ATV suppliers, RF, Telecoms and Microwave design consultants + PCB CAD and prototype/small volume manufacturing service.

KM PUBLICATIONS

5 Ware Orchard * Barby * Nr.Rugby
CV23 8UF * U.K.

Telephone: 0788 890365

Fax: 0788 891883

Mobile: 0860 857434

- UHF COMPENDIUM**, Pts.1 & 2 and 3&4.....each £24.50
K.L.Weiner DJ9HOthe pair..... £40.00
- AN INTRODUCTION TO AMATEUR TELEVISION** £ 5.00
Mike Wooding G6IQM & Trevor Brown G8CJS
- SLOW SCAN TELEVISION EXPLAINED** £ 5.00
Mike Wooding G6IQM
- TV SECRETS Volume II** £17.95
Henry Ruh KB9FO, ATVQ magazine
- THE ATV COMPENDIUM**..... £ 3.50
Mike Wooding G6IQM
- ATVQ MAGAZINE**per issue .. £ 3.50
annual subscription inc. surface postage £17.50
- P&P please add £1.00 for U.K., £2.50 for Overseas surface, £7.50 for Air Mail

TIMESTEP



HRPT System

Noise-free digital HRPT transmissions from NOAA, with a ground resolution of just 1.1km, allow images to be received in incredible clarity. Rivers, lakes, mountains, cities and even small towns can be seen on good days. Fishermen will appreciate the increased resolution of sea surface temperatures.

Image processing, including variable and histogram contrast equalisation combined with full colour editing, gives the best possible results from any image. Colour enhancement allows sea surface temperature and land details to stand out in high contrast. Any number of colour palettes can be saved for future use. The sophisticated mouse-driven software allows all five bands to be saved and displayed on nearly all VGA and SVGA cards right up to 1024 pixels, 768 lines and 256 colours.

Zoom to greater than pixel level is available from both a mouse-driven zoom box or using a roaming zoom that allows real time dynamic panning.

Sections of the image may be saved and converted to GIF images for easy exchange.

Latitude and longitude gridding combined with a mouse pointer readout of temperature will be available late in 1991.

Tracking the satellite is easy and fun! Manual tracking is very simple as the pass is about 15 minutes long. A tracking system is under development and expected by the end of 1991. A 4 foot dish and good pre-amplifier are recommended. The Timestep Receiver is self-contained in an external case and features multi-channel operation and a moving-coil S meter for precise signal strength measurement and tracking. The data card is a Timestep design made under licence from John DuBois and Ed Murashie.

Complete systems are available, call or write for a colour brochure.

USA Amateur Dealer: Spectrum International, P.O. Box 1084, Concord, Massachusetts 01742. Tel: 508 263 2145

TIMESTEP WEATHER SYSTEMS

Wickhambrook Newmarket CB8 8QA England Tel: (0440) 820040 Fax: (0440) 820281

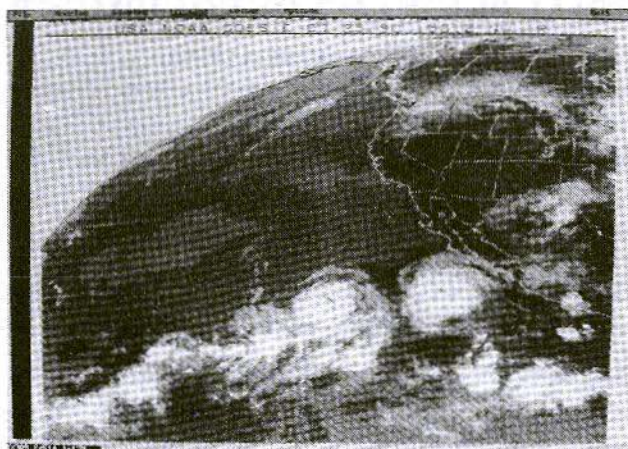

VGASAT IV & MegaNOAA APT Systems

1024 x 768 x 256 Resolution and 3D

The Timestep Satellite System can receive images from Meteosat, GOES, GMS, NOAA, Meteor, Okean and Feng Yun. Using an IBM PC-compatible computer enables the display of up to 1024 pixels, 768 lines and 256 simultaneous colours or grey shades depending on the graphic card fitted. We actively support nearly all known VGA and SVGA cards. Extensive image processing includes realistic 3D projection.

100 Frame Automatic Animation

Animation of up to 100 full screen frames from GOES and Meteosat is built in. We call this 'stand alone animation' as it automatically receives images, stores them and continuously displays them. Old images are automatically deleted and updated with new images. The smooth animated images are completely flicker-free. Once set in operation with a single mouse click, the program will always show the latest animation sequence without any further operator action.

NOAA Gridding and Temperature Calibration

The innovative MegaNOAA program will take the whole pass of an orbiting satellite and store the complete data. Automatic gridding and a 'you are here' function help image-interpretation on cloudy winter days. Spectacular colour is built in for sunny summer days. Self-calibrating temperature readout enables the mouse pointer to show longitude, latitude and temperature simultaneously.

Equipment

Meteosat/Goets

- 1.0M dish antenna (UK only) Yagi antenna
- Preamplifier 20M microwave cable
- Meteosat/GOES receiver
- VGASAT IV capture card
- Capture card/receiver cable
- Dish feed (coffee tin type)

Polar/NOAA

- Crossed dipole antenna
- Quadrifilar Helix antenna (late 1991) Preamplifier
- 2 channel NOAA receiver PROscan receiver
- Capture card/receiver cable

Call or write for further information.

USA Education Dealer, Fisher Scientific, Educational Materials Division, 4901 W. LeMoine Street, Chicago, IL 60651.

Tel: 1-800-621-4769

USA Amateur Dealer, Spectrum International, P.O. Box 1084,

Concord, Massachusetts 01742. Tel: 508 263 2145

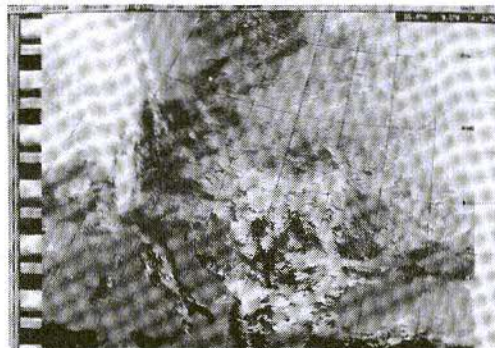

TIMESTEP WEATHER SYSTEMS

Wickhambrook Newmarket CB8 8QA England Tel: (0440) 820040 Fax: (0440) 820281

**MATERIAL PRICE LIST OF EQUIPMENT**

described in VHF COMMUNICATIONS

DB1NV	Digital Image-Store for the Spectrum Analyser	Art. No.	Ed. 4/1991
PCB	DB1NV 010	6477	DM 44.00
Components	Processor P80C31; 12 ICs; 1 Reg. IC, Transistor; Zener Diodes; Silicon Diodes; Chokes; RAM; EPROM DB1NV 010; 4 x 2k Trimpots; Crystal	6478	DM 276.00
DB1NV	Tracking Generator for the Spectrum Analyser	Art. No.	Ed. 1/1992
PCB	DB1NV 011	6479	DM 31.00
F61LR F6BXC	A Digital Slow-Scan Television Transmit Coder	Art. No.	ED. 3/1992
PCB	SSTV CODE1 (KM Publications)	SSTV1	£ 28.50
DB1NV	Broadband VCO's using Microstrip Techniques	Art. No.	Ed. 4/1992
PCB	DB1NV 012	6480	DM 33.00
PCB	DB1NV 013	6481	DM 33.00
Components	400 - 1250 MHz 3 x BB619; 1 x BB811; 1 x BFG96; 2 x AT42085; 1 x BFQ69; 2 x 2.2nF & 1 x 27pF Feed-through Cap. ; SMC Connectors; 2 x 0.47 H SMD Choke; 1 x housing 74x55x30mm; 1 PCB DB1NV 012	6482	DM 81.00
Components	450 - 1450 MHz as above but: 1 x BFG65 instead of BFG96	6483	DM 81.00
Components	800 - 1900 MHz as above but: 4 x BB811 instead of BB619 and PCB DB1NV 013 instead of 012	6484	DM 85.00
Tuning Diode	BB619	10 off	10450 DM 20.00
Tuning Diode	BB811	10 off	10451 DM 31.50

The above items are all supplied by, and obtained from, UKW-Berichte in Germany.

To obtain supplies please contact your country representative for details of local prices and availability. Alternatively, you may order direct from UKW-Berichte or via KM Publications, whose addresses may be found on the inside front cover of this magazine.



Plastic Binders for VHF COMMUNICATIONS

- Attractive plastic covered in VHF blue
- Accepts up to 12 editions (three volumes)
- Allows any required copy to be found easily
- Keeps the XYL happy and contented
- Will be sent anywhere in the world for DM8.00 + post and packing

Please order your binder via the national representative or directly from UKW-BERICHTE, Terry Bittan OHG (see below)

The elder editions of VHF COMMUNICATIONS are still obtainable for reduced prices from the publishers of UKW-Berichte.

Subscription	Volume	Individual copy
VHF COMMUNICATIONS 1993	each DM40.00	each DM 11.00
VHF COMMUNICATIONS 1992	each DM38.00	each DM10.00
VHF COMMUNICATIONS 1991	each DM35.00	each DM10.00
VHF COMMUNICATIONS 1990	each DM27.00	each DM 7.50
VHF COMMUNICATIONS 1988 to 1989	each DM25.00	each DM 7.50
VHF COMMUNICATIONS 1986 to 1987	each DM24.00	each DM 7.00
VHF COMMUNICATIONS 1985	each DM20.00	each DM 6.00
VHF COMMUNICATIONS 1980 to 1984	each DM16.00	each DM 4.50

(Edition 3/1982 no longer available)

Individual copies out of elder, incomplete volumes, as long as stock lasts:

1, 2, 4/1972 * 2, 4/1973 * 1, 3/1974 * 1, 2, 3, 4/1975	each DM 2.00
3, 4/1976 * 1, 4/1977 * 1, 2/1978 * 1, 2, 3/1979	each DM 2.00
Plastic binder for 3 volumes	each DM 8.00
Post and packing minimum charges	DM 14.00



UKWberichte T. Bittan OHG · Jahnstr. 14 · Postfach 80 · D-8523 Baiersdorf

Tel: 09133-47-0 * Telefax 09133-4747 * Postgiro Nürnberg 30455-858 code 760 100 85

EASY-PC PCB and Circuit Diagram CAD

Forget using tapes and lightbox! Create your Circuit Boards using CAD - like the professionals.

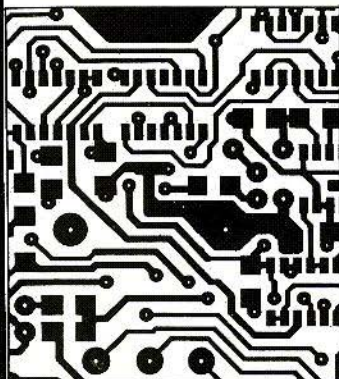

- Runs on PC/XT/AT etc. with Hercules, CGA, EGA or VGA display and many DOS emulations.
- Design Schematics Single and Double sided and Multilayer boards including Surface Mount.
- Standard output includes Dot Matrix / Laser / Inkjet Printer, Pen Plotter, Photo-plotter and N.C. Drill.
- Extremely powerful.
- Very easy to use.

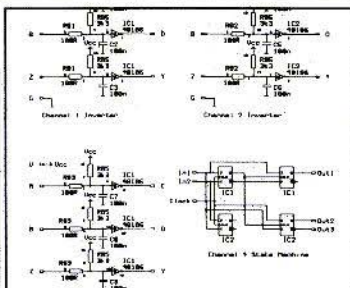

EASY-PC

Technical support is free, for life!

Only £98.00!

Plus P&P+VAT

Over 13,000 Installations in 70 Countries Worldwide!

Options:-500 piece Surface Mount Symbol Library £48, 1000 piece Symbol Library £38, Gerber Import facility £98.

DIGITAL SIMULATION £195

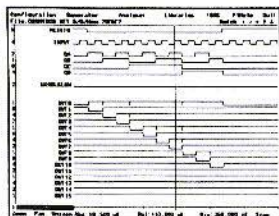

- At last! A full featured Digital Circuit Simulator for less than £1000!
- PULSAR allows you to test your designs without the need for expensive test equipment.
- Catch glitches down to a pico second per week!
- Includes 4000 Series CMOS and 74LS Libraries. 74HC/HCT libraries only £48.00 each.
- Runs on PC/XT/AT/286/386/486 with EGA or VGA.

ANALOGUE SIMULATION £195

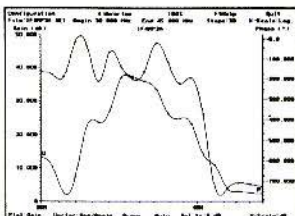

- NEW powerful ANALYSER III has full graphical output.
- Handles R's, L's, C's, Bipolar Transistors, FET's, OP-amp's, Tapped and Untapped Transformers and Microstrip and Co-axial Transmission Lines.
- Plots Input / Output Impedance, Gain, Phase & Group Delay.
- Covers 0.001 Hz to > 10GHz
- For PC/XT/AT/286/386/486 with EGA or VGA.
- Very fast computation.

SMITH CHART CAD £195

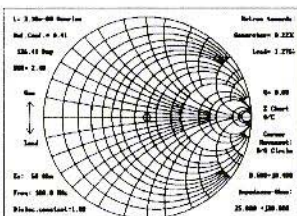

- Z-MATCH II simplifies RF matching and includes many more features than the standard Smith Chart.
- Handles transmission line transformers, stubs, discrete components, S Parameters etc.
- Supplied with many worked examples.
- Superbly easy to learn and use.
- Runs on IBM PC/XT/AT/386/486, CGA, EGA, VGA.
- Ideal for Education and Industry.

For full information, Write, Phone or Fax:-

Number One Systems Ltd. 1

REF: VHFCOM, HARDING WAY, ST.IVES, HUNTINGDON, CAMBS, ENGLAND, PE17 4WR.

Telephone: 0480 61778 (7 lines) Fax: 0480 494042

International: +44-480-61778, Fax: +44-480-494042 ACCESS, AMEX, MASTERCARD, VISA Welcome.

- TECHNICAL SUPPORT FREE FOR LIFE!
- PROGRAMS NOT COPY PROTECTED.
- SPECIAL PRICES FOR EDUCATION.