



*A Publication for the
Radio Amateur Worldwide*

*Especially Covering VHF,
UHF and Microwaves*

VHF COMMUNICATIONS

Volume No.30 . Spring . 1/1998 . £4.75

Gregor Storz, ZL1GSG / DL1GSG Wideband Stripline Directional Coupler

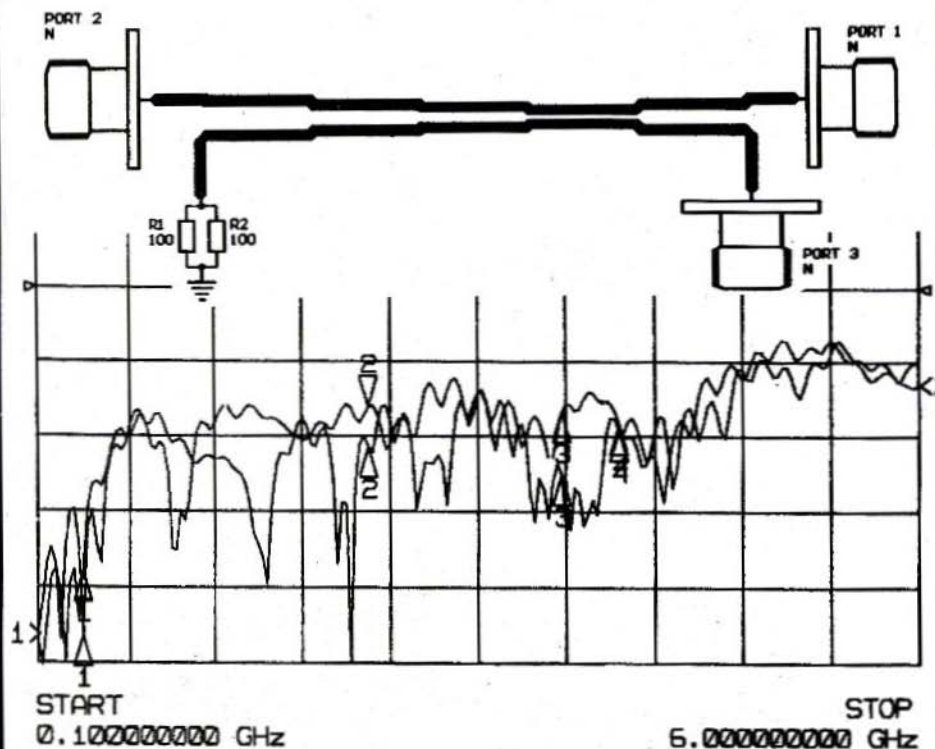

BOOKS FOR ENGINEERS AND SERIOUS AMATEURS



Microwave Field-Effect Transistors

By Raymond S. Pengelly

703 pages of data on GaAs FET devices and circuits! Basic information on fabrication, packaging and performance is followed by circuit design data on amplifiers, oscillators, switches, multipliers, mixers, phase shifters and other functions. The most complete book for design using GaAs FETs. **Order NP-8 \$89.00**

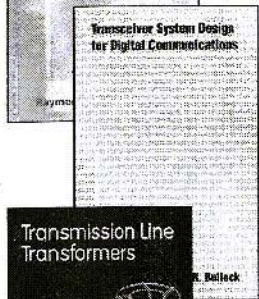

Transceiver System Design for Digital Communications

By Scott R. Bullock

A thorough summary of radio system design for digital communications. Draws on developments driven by military systems, but presents them as fundamental information essential for commercial wireless communications system development. 432 pages. **Order NP-7 \$54.00**



Transmission Line Transformers

By Jerry Sevick, W2FMI

Professionals and amateurs alike can use this unique resource, a modern classic that answers the questions, "How do they work?" and "How do I build them?" Guanella and Ruthroff configurations are described, with performance verified by hundreds of measurements on balanced, unbalanced and balun types. The best book ever on this subject! **Order NP-9 \$34.00**



Oscillator Design and Computer Simulation

By Randall W. Rhea

Understand oscillator design and operation! This book presents a unified approach to design, using a wide variety of active elements and resonator types — bipolar transistors, FETs or MMICs with crystal, L-C, SAW, coaxial, microstrip or other resonators. Strong coverage of basic concepts with many design CAD models and circuit examples. **Order NP-1 \$64.00**

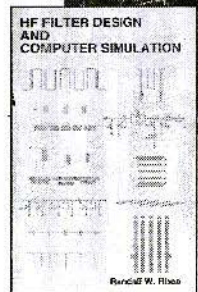

HF Filter Design and Computer Simulation

By Randall W. Rhea

Filters for the practicing engineer who actually *builds* filters! Includes lumped element, coaxial, helical, dielectric resonator, stripline and microstrip types. Thorough review of filter principles with practical information on topologies, transformations, component effects and matching. Especially good for the design and realization of microstrip filters. **Order NP-2 \$59.00**

Order by telephone, fax, mail or our Web site!

We accept payment by VISA, MasterCard and American Express or check drawn on a U.S. bank. Shipping charges are — U.S.: \$5.00 for the first item, \$1.00 for each additional item; Canada: \$10.00 first item, \$2.00 each additional item; Other countries (Air express): \$32.00 first item, \$10.00 each additional item.

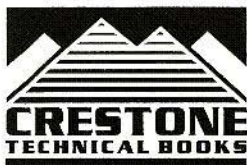

CRESTONE TECHNICAL BOOKS

Div. of Noble Publishing Corporation

2245 Dillard Street • Tucker, GA 30084 • USA

Tel: (770) 908-2320 • Fax: (770) 939-0157

www.noblepub.com



Contents

Gregor Storz ZL1GSG, DL2GSG	Stripline Directional Coupler for 400 MHz to 3.6 GHz	2 - 9
Eugen Berberich DL8ZX	Diplexer for Ring Mixers	11 - 17
Harald Fleckner DC8UG	Design and Assembly of a Noise-Matched Hetero-Junction GaAsFET 10.4 GHz Amplifier Developed using PUFF CAD Software	18 - 29
Editor	GHz Activities Rain Scatter as far as Basle	30
Index of Volume 29 (1997)		
Denys Roussel F61WF	An Exceptionally Low-Cost HF-SSB/CW Transceiver Part-4: Assembly Instructions	35 - 45
Gunthard Kraus DG8GB	Design and Realisation of Microwave Circuits Part-5	46 - 60



KM Publications, 5 Ware Orchard, Barby, Rugby, CV23 8UF, UK

Telephone: (0)1788 890365; INT: +44 1788 890365; FAX: (0)1788 891883

Email: michael.j@vhfcomm.co.uk

WWW: <http://www.vhfcomm.co.uk>



Gregor Storz, ZL1GSG, DL2GSG

Stripline Directional Coupler for 400 MHz to 3.6 GHz

I was preparing to move to new accommodation, and I began to think about extending my measuring equipment. You can buy many things, but good directional couplers are very expensive, assuming you can get them at all. Normal $\lambda/4$ microstrip couplers are frequently used, but their directivity effect is nothing special; and they are certainly not broad-band.

1. BASIC FACTORS

In my search for a solution I found a comprehensive description of directional couplers in the book "Stripline Circuit Design" by Harlan Howe [1]. Why Stripline (Triplate)? It very quickly became apparent that Stripline has marked advantages, as against Microstrip, in relation to the directivity. A directional coupler which consists only of 2 $\lambda/4$ long coupled lines has a band width of one octave. If this coupler is

extended by additional $\lambda/4$ couplers with an expanded interaction gap (Fig.1), the usable frequency range is expanded. At $n = 3$, we can already obtain a band width of 4:1 to 8:1 - depending on the permitted ripple, of course. If we want a coupler with a band width exceeding 9:1, we have to use a structure with $n \geq 4$. The consequence is that the coupler becomes very long and this also means the losses in the substrate increase.

Another option is to use an asymmetrical structure. This saves us almost half the $\lambda/4$ segments required - with scarcely any deterioration in the characteristics (Fig.2).

For a symmetrical coupler, the phase displacement to the de-coupled port is always 90° .

For an asymmetrical coupler, the phase displacement is frequency-dependent, but this is irrelevant for amateur radio applications.

One question troubled me here. Are there differences between the $2/4$ coupling and the $1/3$? Simulations show that

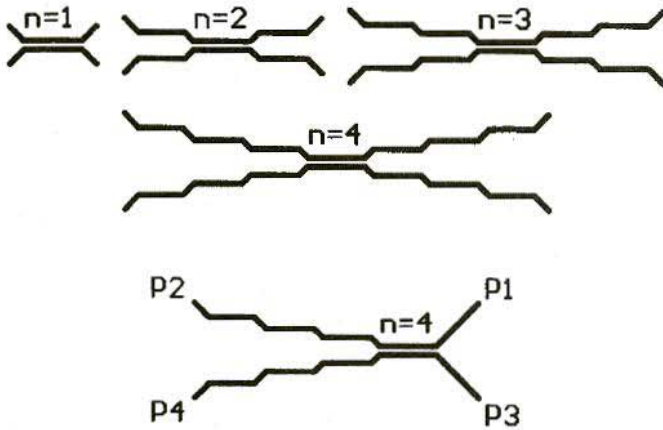

Fig.1:
Symmetrical and
Asymmetrical
Couplers

the coupling for the 2/4 port is more strongly frequency-dependent than that for the 1/3 port. The reason for this is the transmission loss through the segments right up to the $\lambda/4$ segment, limiting for the high frequencies, with the smallest coupling gap.

symmetrical coupler with $n = 3$ on Rogers RO3003 material.

Since this solution is very expensive, because of the base material used, the idea of a version which would give better value was pursued. So how well suited, or how badly suited, is FR4 epoxy material to these high frequencies?

2. REALISATION

Once these basic principles were clear, the original problem could also be solved very quickly. The result was a

I discovered through simulation, using Super-Compact, that, with limitations, a “normal” assembly could be carried out right up to 3.5 GHz. As a result of the simulation, I expanded the original structure ($n = 4$) by one $\lambda/4$ segment.

The useful frequency range goes from



Fig.2: Wiring Diagram of Asymmetrical Stripline Coupler

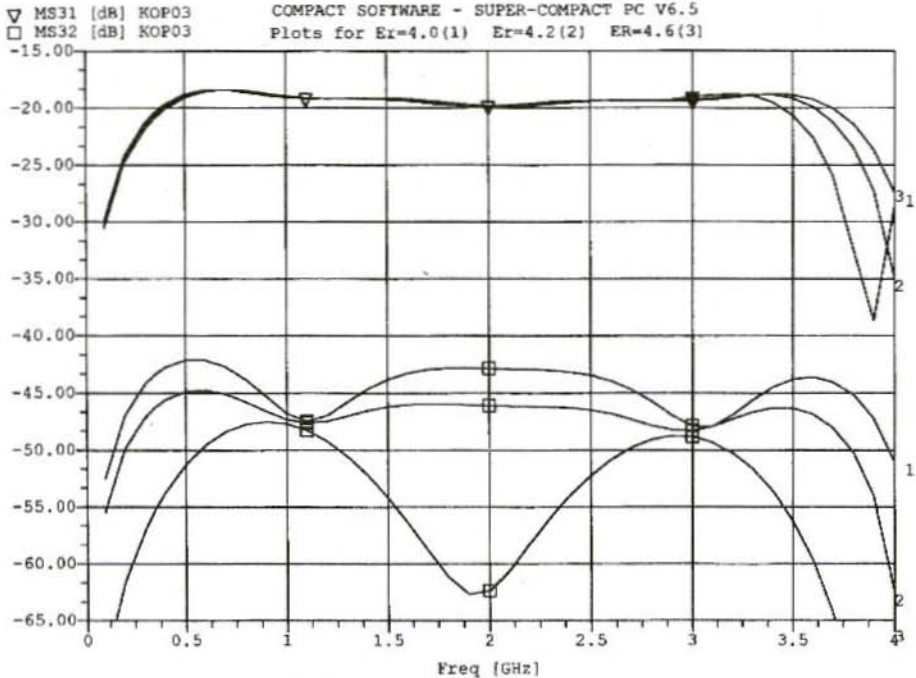

Fig.3: Simulation Results for Coupling and Directivity for various values of ϵ_r

400 MHz to 3.5 GHz at 20 ± 1 dB coupling.

The biggest disadvantage of FR4 is the attenuation, which here reaches a = 1.5 dB at 3.5 GHz, and is thus close to maximum. A certain amount of uncertainty comes from the ϵ_r , which oscillates, depending on the manufacturer, between $\epsilon_r = 4.0$ and 4.6. In my simulations, I use a value of $\epsilon_r = 4.2$ for FR4. The effects are displayed mainly by the fact that the operating range of the coupler is displaced (Fig.3).

2.0 mm. was selected as the thickness of each substrate. The Triplate was reinforced by a 2 mm. thick aluminium plate to give sufficient mechanical stability.

2 x 100 Ω SMD 0805 resistors were

integrated into the Triplate between two 2.0 mm. thick epoxy printed circuit boards. In order to obtain enough room for the resistors, some epoxy had to be "carved out" of the second board. The important thing here was that the earth contact for the resistors was soldered to all 3 layers with 2 pieces of wire (0.8 mm. long). You should also make sure that there is a good contact between the screws and the two earth surfaces (Fig.4).

In a reflection measurement, the two chip resistors, which added up to 0.25 W, limited the preliminary power to 25 Watts.

Fig's.5 and 6 show the structure of the coupler.

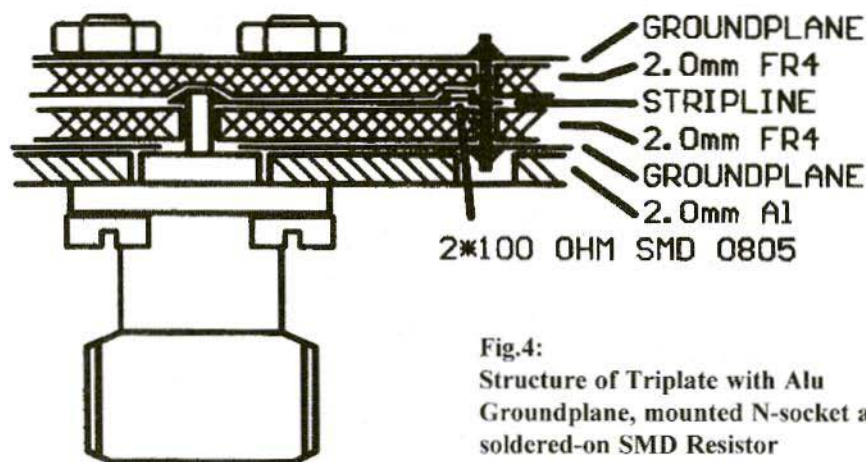

Fig.4:
Structure of Triplate with Alu
Groundplane, mounted N-socket and
soldered-on SMD Resistor

3. UNEXPECTED OBSTACLES

You can calculate everything on the coupler beautifully, use a high-quality substrate and have a good seal, and still not obtain good directivity. The reason for this is usually the sockets used. These components, or the way they are matched, have or has a direct influence on the directivity. The best solution is to use special sockets for striplines with "pennants" as centre contacts (e.g. from Rosenberger).

As I had no such N-sockets available during assembly, I tried my luck with "normal" N-sockets, which possess a thinner dielectric ($d = 5.8$ mm.) on the flange side.

After completing the coupler I had to admit that the return loss with this socket was still only $R_L = -22$ dB at 2.4 GHz.

The reason for this is that this socket has a section about 2 mm. longer with only 45Ω. Another type of socket was

even worse. It had an area 5 mm. long with an impedance of only 40 Ω.

To get things clear in my mind, I sawed the sockets down and tested them on the spot.

4. MEASUREMENT RESULTS

No matter how attractive the simulation results may have been, the measurement results (Fig's.7, 8) for the prototypes looked completely different. However, this was mainly in relation to the return loss, which at times was only 14dB (Fig.9).

The reason for this lay in the sockets, or in the way they were mounted.

In this case, however, I laid greater emphasis on a simple, mechanically solid construction which, for example, did not immediately collapse when two Aircom cables were connected.

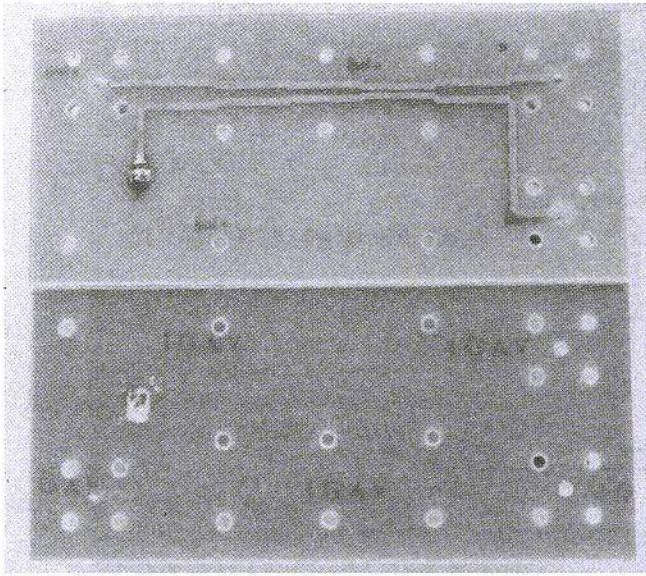

Fig.5:
Structure of
Coupler: Printed
Circuit Board
before Assembly

5. MAKING YOUR OWN

For those who want to start making their own version straight away, here are the dimensions for a coupler, with $n = 5$, mounted on 2×1.5 mm. FR4 epoxy (Fig.10).

Since there will certainly be no problem with access to programs for the design

of printed circuit boards, I am giving only the dimensions here.

- All lines lie on a 5 mil (0.005°) basic grid.
- The printed circuit boards are always 56 mil wide, and the length of a coupler segment is 690 mil.
- The length of the entire coupler is app. 88 mm. and thus fits crosswise onto a Euro-card.

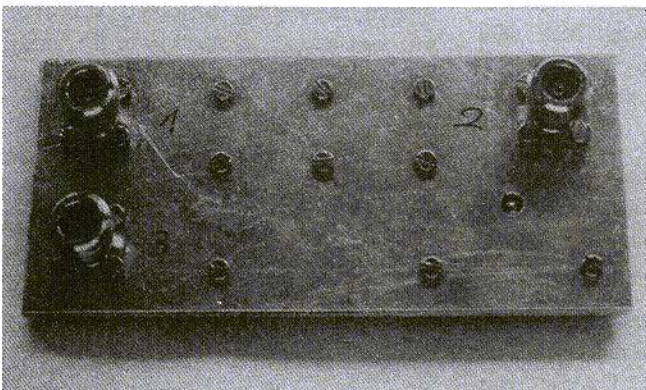

Fig.6:
View of Prototypes
with N-sockets

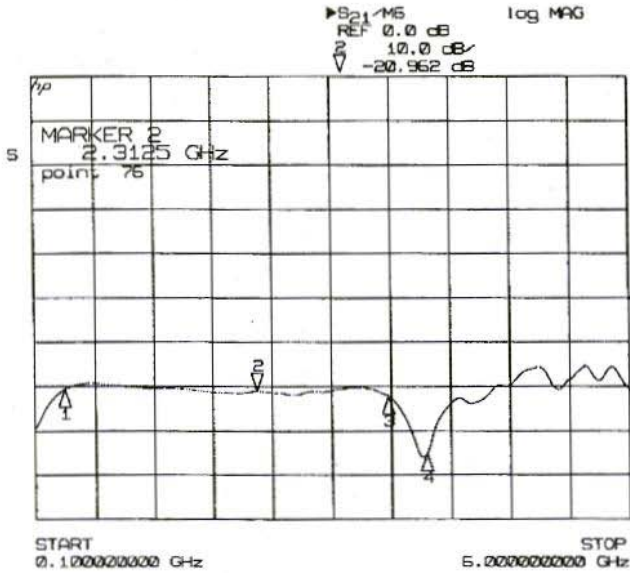

Fig.7:
Measurement
Diagram for Coupling
Port 1 to 3:

400 MHz - 3 GHz =
20 ± 1dB;

Marker 1: 400 MHz,

Marker 2: 2.31 GHz,

Marker 3: 3.6 GHz,

Marker 4: 4.0 GHz

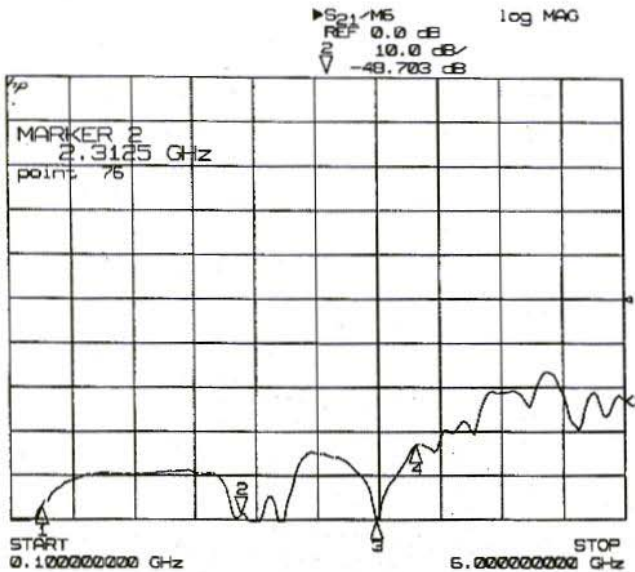

Fig.8:
Measurement Diagram
for Directivity Port 2
to 3:

400 MHz - 2.5 GHz ≥
18dB,

400 MHz - 3.5 GHz ≥
14dB

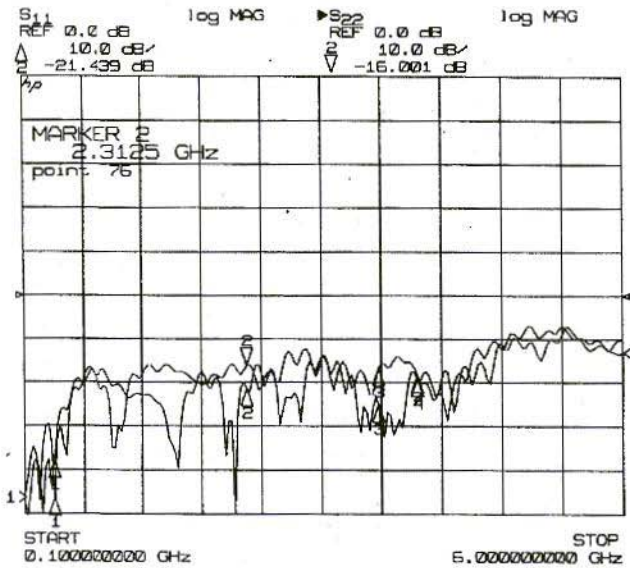

Fig.9:
 Matching of Ports 1, 2
 and 3;

400 MHz - 2.5 GHz

$R_L \geq 16\text{dB}$,

400 MHz - 3.5 GHz

$R_L \geq 13\text{dB}$

- The intervals of the coupler lines (centre of track in each case) are S1 = 175 mil, S2 = 140 mil, S3 = 120 mil, S4 = 100 mil and S5 = 85 mil > coupling gap: 119 mil, 84 mil, 64 mil, 44 mil, 29 mil.

The layout was printed onto film on a 1:1 scale using a laser printer and engraved using normal engraving equipment.

As regards sockets, an SMA construction with "pennants" was used on the prototype, and an SMA seal was used at port 4.

The assembly coupling is $21 \pm 1\text{dB}$ (350 MHz to 3.5 GHz). The directivity is better than 20dB up to 2 GHz and better than 18dB up to 3.5 GHz.

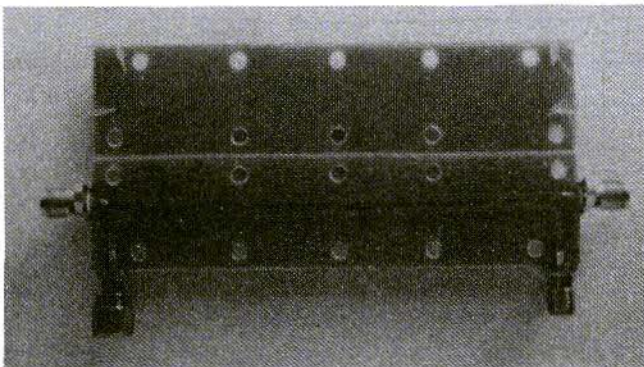

Fig.10:
 Coupler made from
 2 x 1.5 mm. Epoxy
 with SMA Sockets



6. SUMMARY

The directional coupler described above could certainly be developed further in relation to the matching and the directivity. Better sockets - e.g. SMA's - and an SMA seal resistance improve the results markedly.

I would like to thank K.Eichel, DL6SES, from the TSS company for support with Super-Compact, and DL1TR for measuring the prototype.

7. LITERATURE REFERENCES

- [1] Harlan Howe, Jr.: Stripline Circuit Design (1974), Artech House
- [2] Elements Library Super-Compact, Compact Software, USA

The Parabolic 24cm Preamplifier

A fully weather-proofed very high-quality preamplifier covering 1200 MHz to 1360 MHz. Mounted in a sealed diecast enclosure with weatherproof N-type sockets for input and output. DC powered via the output socket for remote mast-head mounting.

**GAIN >40dB across the band
NOISE FIGURE <1.6dB**

£135 + £7.50 post and packing

**KM Publications, 5 Ware Orchard, Barby, Nr.Rugby,
CV23 8UF, U.K.**

Tel: 01788 890 365; Int: +44 1788 890 365

Fax: 01788 891 883; Int: +44 1788 891 883

ALL MAJOR CREDIT CARDS ACCEPTED - above prices +5%

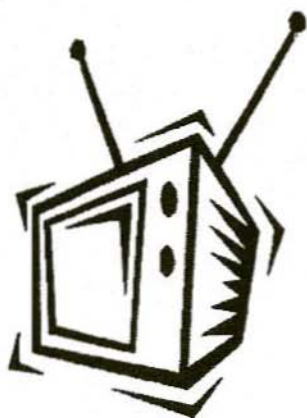

**Interested in the
Technical Side
of Television?**

B.A.T.C.

Over four decades of Television Service



**CQ-TV Magazine is for you,
packed full of practical and
easy to build circuits for the
Radio Amateur and Video
Enthusiast.**

**For details, contact the BATC at
Grenehurst, Pinewood Road,
High Wycombe, Bucks,
HP12 4DD, England**



Internet <http://www.batc.org.uk>



Eugen Berberich, DL8ZX

Diplexer for Ring Mixers

There are various possible ways of terminating ring mixers with the correct impedance. Diplexers for ring mixers have already been described by J.Kestler, DK1OF [1] (Fig.1).

Another possible way of terminating ring mixers with the correct impedance is indicated below.

1. INTRODUCTION

Correct termination of ring mixers has a big influence on their inter-modulation behaviour. A diplexer after the mixer is known to increase the noise factor of the

mixer through its additional attenuation, which can lie in the area of < 1 dB. This attenuation also increases the noise factor of the subsequent intermediate-frequency amplifier.

In many applications, the diplexer is replaced by a 3-dB attenuator. This saves on balancing in industrial production but, as stated above, it increases the noise factor of the intermediate-frequency amplifier by 3dB.

High, low and band passes have proved to be the selection agents with the lowest attenuation levels. For this reason, a bridged T-filter [2] was investigated with regard to using it as a diplexer (Fig.2).

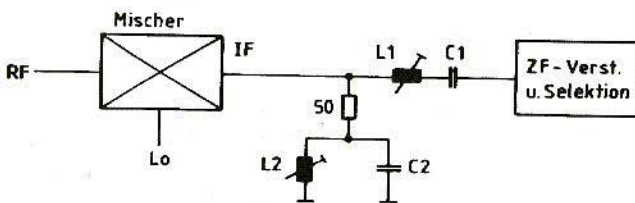

Fig.1:
Adjusting a Ring Mixer as per DK1OF
Mischer = Mixer,
ZF-Verst. u. Selektion
= IF Amp & selection

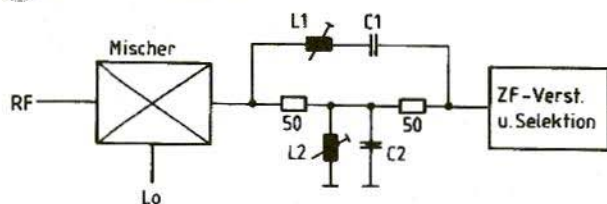

Fig.2:
Bridged T-Filter as
Adjusting Member
Mischer = Mixer,
ZF-Verst. u. Selektion
= IF Amp & selection

With regard to [1], what happens is that the subsequent intermediate-frequency amplifier also "sees" a real broad-band closure of 50Ω . At the higher intermediate frequencies in particular, realisation is made more difficult by components which are not ideal.

In [1], L2 and C2 are connected in series, with 12pF , at, for example, 9 MHz , with $10\text{ nF} / 29\text{ nH}$, and L1 and C1 with $26.5\mu\text{H}$.

The undesirable inductance of the capacitors used and the winding capacity of the coils, together with the coil Q, appear to create big obstacles here to the creation of an ideal diplexer.

It is advantageous to have additional LC filters between the mixer and the intermediate-frequency amplifier. The operation of the subsequent crystal filter is improved, and any residual oscillator levels which may still perhaps be present are also kept away from the

intermediate-frequency amplifier (see also Fig.7).

A filter of the type described below offers further advantages when inserted at the oscillator port. It is often overlooked in relation to mixers that amplifier stages of the oscillator, and the oscillator itself, feed noise power into the intermediate-frequency amplifier in the intermediate-frequency range through the oscillator port, and thus de-sensitise the amplifier.

A high-pass or band filter for the oscillator frequency at the oscillator port is sufficient to keep away noise power in the intermediate-frequency range. Of course, the LO connection of the mixer "sees" no real broad-band termination.

At this position too, a diplexer of the type described below is more advantageous (Fig.3).

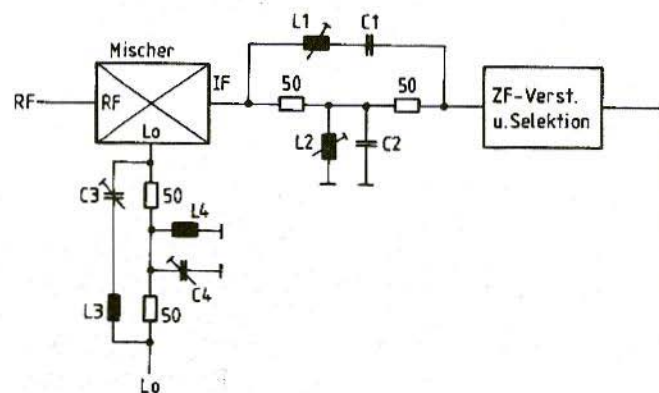

Fig.3:
Bridged T-Filters at
intermediate-
frequency and LO
Ports of Mixer

Mischer = Mixer,
ZF-Verst. u. Selektion
= IF Amp & selection

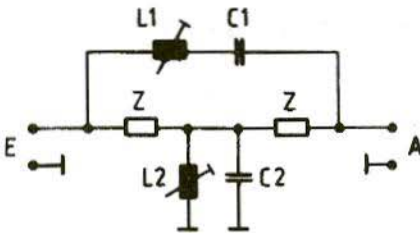

Fig.4:
Main Circuit of Bridged T-Filter

L1, C1 and L2, C2 resonant with the IF
L1 = 35 wdg; 0.15 CuI, Core Ø 4mm
L2 = 3 wdg; 0.5 CuI, Core Ø 4mm
(For values, see description below)

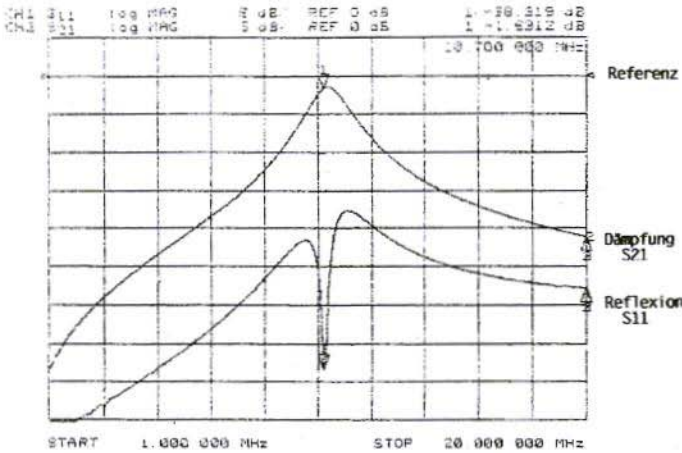

Fig.4a:
Measurement Curves for 10.7 MHz Diplexer as per Fig.4

Referenz = Reference,
Dämpfung = Attenuation,
Reflexion = Reflection

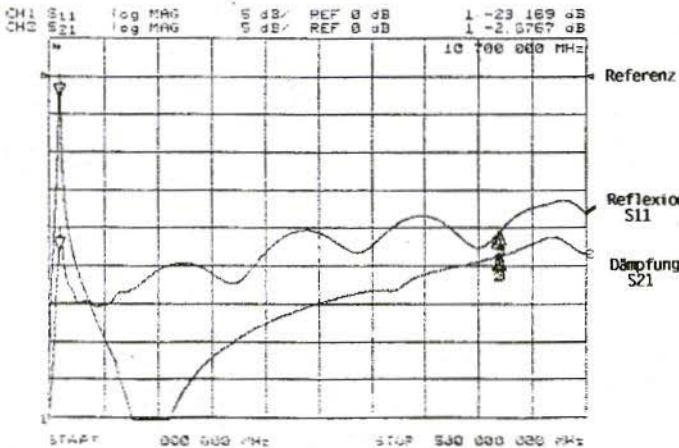

Fig.4b:
Measurement Curves at 500 MHz

Referenz = Reference,
Dämpfung = Attenuation,
Reflexion = Reflection

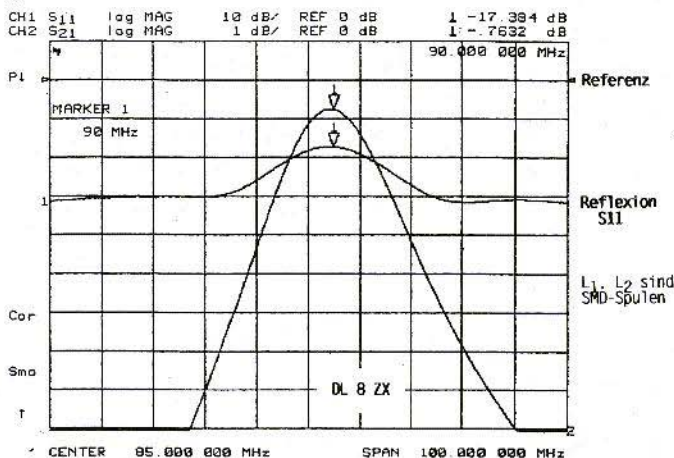

Fig.5:
Filter for 86.5 MHz

Referenz = Reference, Reflexion = Reflection

L1 & L2 are SMD coils

2. CREATION OF DIPLEXER

The principle of the bridged T-filter is known in communications engineering and has been described in the literature [2].

This circuit, which can be used as a diplexer, has the advantage, as against that described in [1], that not only the mixer but also the intermediate-frequency

amplifier "sees" a real termination in all frequency ranges (Fig.4).

Fig's.4a and 4B give the readings for this.

Calculations were carried out for diplexers with a bridged T-filter for a "popular" intermediate frequency of 10.7 MHz and for a "high-value" intermediate frequency of 86.5 MHz (readings taken at 90 MHz).

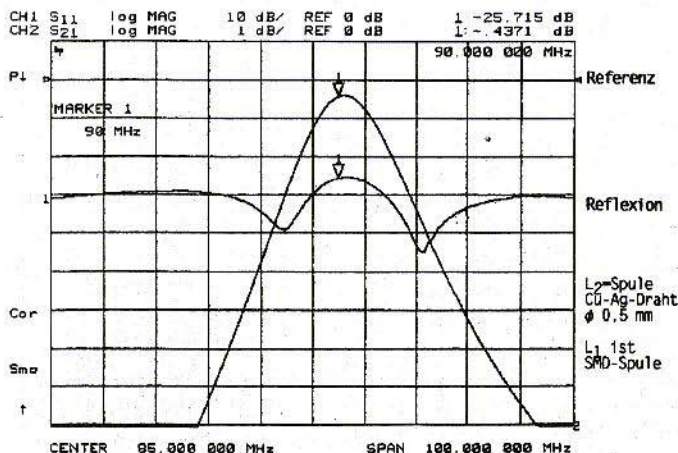

Fig.6:
Filter with less Attenuation - Coils of Higher Quality

Referenz = Reference, Reflexion = Reflection, Spule = Coil, Draht = Wire, 1st SMD-Spule = Is an SMD coil

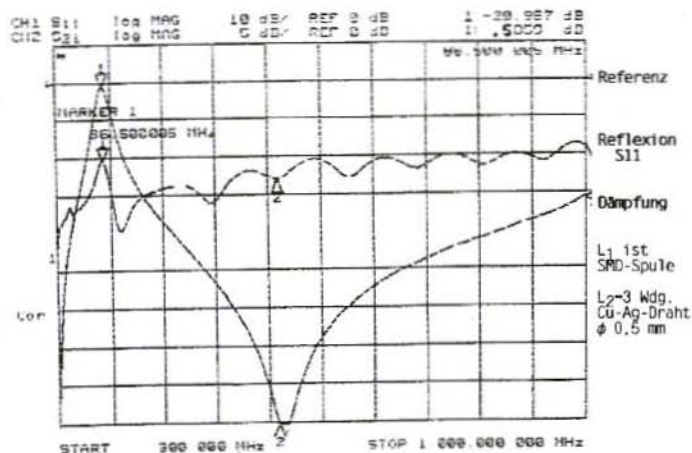

Fig.7: Measurement Curve for 86.5 MHz Diplexer, showing Reflection and low Transmission Loss of 0.5dB at f_0

The calculations for the diplexer components were carried out in accordance with [2]. The K value can be freely selected, within limits, for the individual case. In the applications below, it was set at 10 or 2 and 4 (depending on the band width).

SMD formats should be used at relatively high frequencies for resistors R1 and R2, as well as for C2. C2 can be advantageously created from several parallel-wired capacitors, to keep the inherent inductance of the capacitor low.

This circuit idea had already been tested by me in 1989. This idea was amplified by an article by DJ8ES in VHF Communications[3].

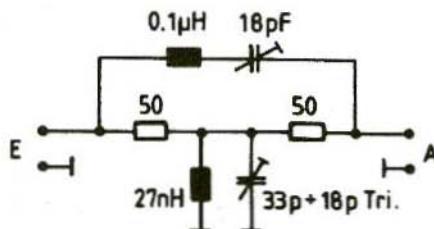

Fig.8: Circuit with values for use in a 2m Converter

Calculation for 10.7 MHz:

$$K = \frac{1}{Z} \cdot \sqrt{\frac{L}{C}} \quad (K = 10) \quad \omega_r = 67\,196\,000$$

$$L_1 = \frac{K \cdot Z}{\omega_r} = \frac{10 \cdot 50}{2 \cdot 3,14 \cdot 10,7 \cdot 10^6} = 7,44 \cdot 10^{-8} \approx 7,5 \mu\text{H}$$

$$C_1 = \frac{1}{\omega_r^2 \cdot L_1} = \frac{1}{(2 \cdot 3,14 \cdot 10,7 \cdot 10^6)^2 \cdot 7,44 \cdot 10^{-8}} = 29,7 \cdot 10^{-12} \approx 30 \text{ pf}$$

$$L_2 = C_1 \cdot Z^2 = 29,7 \cdot 10^{-12} \cdot 50^2 = 7,42 \cdot 10^{-8} \approx 74 \text{ nH}$$

$$C_2 = \frac{L_1}{Z^2} = \frac{7,44 \cdot 10^{-8}}{50^2} = 2,97 \cdot 10^{-9} \approx 3 \text{ nF}$$

Calculation for 86.5 MHz:

$$L_1 = \frac{1}{\omega_r^2 \cdot C_1} = \frac{1}{(86,5 \cdot 10^6 \cdot 8,28)^2 \cdot 10 \cdot 10^{-12}} = 0,34 \mu\text{H}$$

$$C_1 = 10 \text{ pF}$$

$$L_2 = C_1 \cdot Z^2 = 10 \cdot 10^{-12} \cdot 2500 = 25 \text{ nH}$$

$$C_2 = \frac{L_1}{Z^2} = \frac{0,34 \cdot 10^{-6}}{2500} = 136 \text{ pF}$$

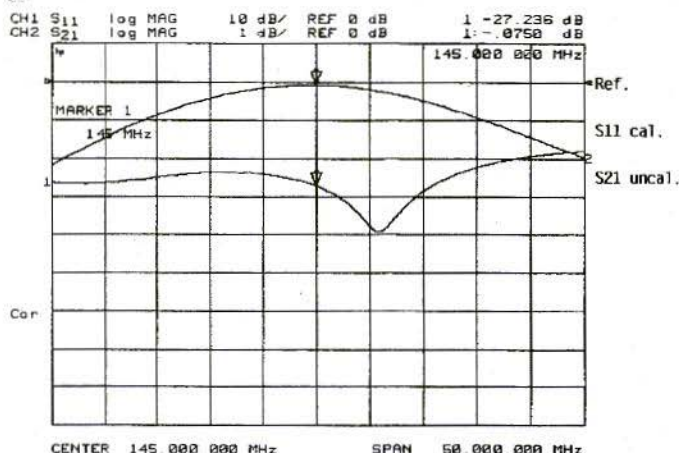

Fig.9:
Measurement
Curve for 145 MHz
Diplexer

The readings are shown in Fig's.5 and 6. The lower attenuation in Fig.6 can be recognised, in comparison with Fig.5. This is due to a higher quality coil.

It is therefore worthwhile to use a high-quality coil for L1. Unfortunately, no information can be obtained from [1] on attenuation values for the diplexer, which play a role, in particular, in mixer adjustment, as stated above. As well as the use of coils with high-frequency iron and ferrite cores for the main selection,

we should also add the option of inter-modulation in the high-frequency core. Ferrite cores are less favourable than iron powder cores in this connection. With a high first intermediate frequency, Ms, Cu or Al cores can be used, as they have previously been used in VHF tuners. Air-core coils made of Cu-Ag with C balance trimmers are a further alternative.

Calculations were carried out for another diplexer for a 2m. converter into

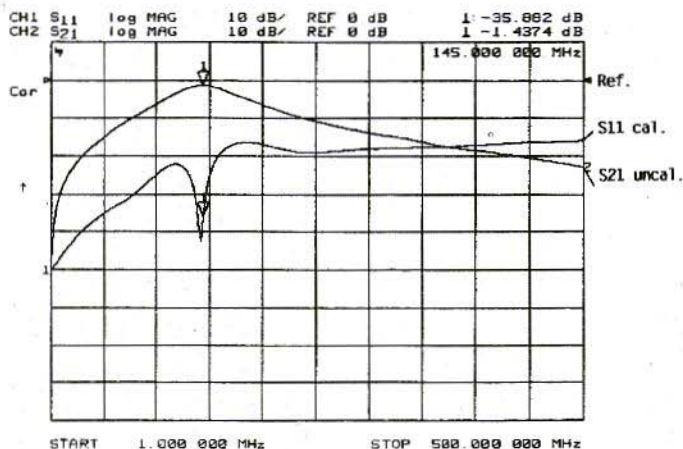

Fig.10:
Measurement
Curve shows a
Reflection Better
than 15dB at 500
MHz

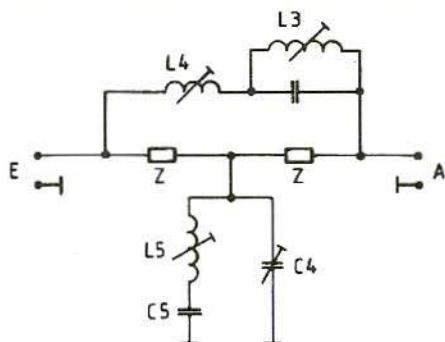

Fig.11: Wiring Diagram for Barriers at $f_{SP} < IF$

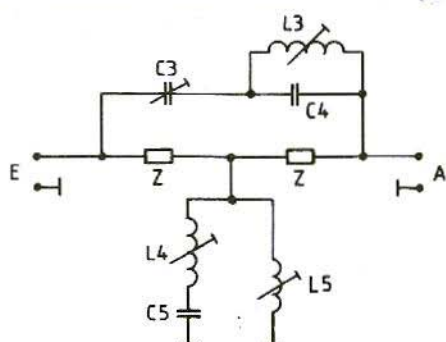

Fig.12: Wiring Diagram for Barriers at $f_{SP} > IF$

the short-wave range, as a test circuit for the highest limiting frequency still obtainable with this layout. Fig.8 shows the values obtained for this application.

The readings are given in Fig.9. The transmission loss for the wanted signal is less than 0.1dB and the reflection is better than 15dB up to 500 MHz, as shown in Fig.10.

3. DIPLEXER WITH NOTCH POSITION

For critical applications with strict requirements for the suppression of secondary reception points, the diplexer circuit described above can also still be used for the suppression of undesirable mix products.

To this end, an additional attenuation peak is inserted into the series circuit L1/C1 and L2/C2 for the frequency to be suppressed (Fig's.11 and 12).

4. LITERATURE REFERENCES

- [1] Joachim Kestler, DK10F
VHF Communications, 1/1976, pp.13 - 18
- [2] Meinke / Gundlach:
High-Frequency Engineering
Pocketbook
Springer-Verlag Berlin / Heidelberg, p. 127
- [3] Wolfgang Schneider, DJ8ES:
SSB Transceiver for 50 MHz with
Assemblies from 50Ω Engineering
VHF Communications, 4/1992, pp.241 - 250



Harald Fleckner, DC8UG

Design and Assembly of a Noise-Matched Hetero-Junction GaAsFET 10.4 GHz Amplifier Developed using PUFF CAD Software

HJ field effect transistors (FET's with high electron mobility - referred to as high-mobility electrons or as HEMT's) produce very little noise, even at very high frequencies, and are outstandingly suitable for the assembly of sensitive pre-amplifiers, the so-called "front ends".

Typical noise factors for these FET's at 10 GHz are 0.5 to 0.8dB for a stage amplification of 10 to 12dB.

This article is intended to stimulate and assist those interested in taking the risk of designing and assembling their own SHF preliminary stages with the help of the favourably priced Puff software [3], [4], [5] and [6].

The required procedure is explained, using the design and assembly of a low-noise 10.4 GHz preliminary stage as an example.

1. RECEIVER SENSITIVITY AND NOISE

In theory, an amplifier can receive wanted signals, however weak, if only the amplification is sufficiently powerful. But in practice, when the wanted signal enters the receiver, interference signals from other sources are always superimposed on it.

These interferences are of the most varied kinds, and have different effects, depending on the frequency.

Pre-amplifiers in the 2-m band boost not only the wanted signals but also the sources described as electro-smog, which are superimposed onto the wanted signal directly or through the antenna equipment.

In the SHF range, the antenna equipment essentially receives the normal



heat radiation from the atmosphere and from all objects within the antenna's reception range.

But interference signals also arise within the amplifier circuits.

They originate in the unregulated thermal agitation of the charged particles, their quantum nature, and their unregulated combination and recombination, in particular on semi-conductors. The description "noise" has been coined to cover all these unregulated interferences, because of the acoustic effect.

2. NOISE FACTOR OF NEUTRALISED FET AMPLIFIERS

The simplest way to determine the amplifier noise is through the noise factor, F , which is defined as the ratio of the total noise power at the exit of the amplifier to the thermal noise power of the generator's internal resistance at the exit [1].

The ratio between these two values makes it possible to determine the noise factor of the amplifier element.

Noise factors can thus be defined as power ratios, and are usually given in "dB" units.

An amplifier with a noise factor of 3dB (factor 2) thus generates twice the noise power at the exit, in relation to the noise power (thermal noise) of the generator resistance at the measurement temperature.

To put it another way, in this case the amplifier develops the same thermal output as the generator resistance.

An amplifier with a noise factor of 0.8dB is consequently a construction stage with very low losses, which produces only approximately 20% additional thermal noise, and thus worsens the signal-to-noise ratio of the antenna equipment only insignificantly.

For neutralised narrow-band MOSFET amplifiers - that is, the internal capacitances are compensated for by external inductances - in a source circuit, the noise factor can be described using the equation below if the operating frequency is sufficiently far below the limiting frequency:

where

$$F = 1 + \frac{2}{3 \cdot S \cdot R_g} \left[\left(1 + \frac{R_g}{R_e} \right)^2 + \frac{2}{5} \cdot S^2 \cdot R_g^2 \left(\frac{\omega}{\omega_0} \right)^2 \right]$$

S = Steepness

R_g = Generator resistance

R_e = Input resistance

ω_0 = Limiting frequency, and

ω = Operating frequency

If we examine this equation closely, we see that for very low generator resistances the noise factor is relatively high, in accordance with $F \sim 1/R_g$, and for high generator resistance levels the proportionality applying is $F \sim R_g$, and thus the noise factor again increases. In between we have the minimum noise factor, i.e. the so-called noise matching.

Because of the frequency-dependent contributions to the noise matching - $(\omega/\omega_0)^2$ - in the equation, the noise

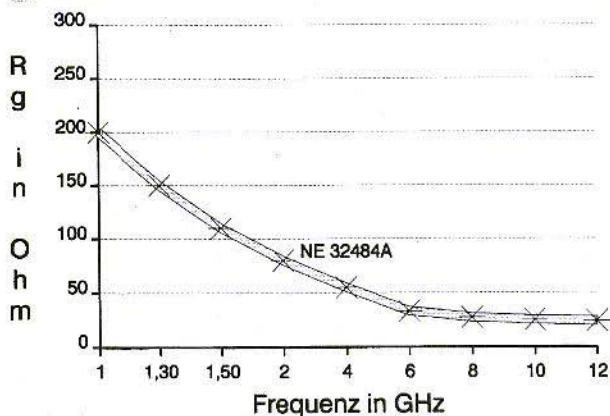

Fig.1:
A Generator Resistance
Noise Matching Curve
for an NE 32484

Frequenz = Frequency

matching is displaced to lower generator resistance values at higher frequencies.

Fig.1 now shows this typical curve, based on the example of an HJ-FET from NEC. At 1 GHz, the optimal generator resistance is so high that if the antenna is mismatched (poor voltage standing wave ratio) the noise factor of the pre-amplifier is determined by the shortening or extension of the supply line.

This effect can be observed, in particular, when very low-noise X-band GaAs-FET's are used at frequencies of 1 GHz and below on relatively old amateur installations.

The only remedy available here is obtained through source neutralisation - that is, bringing a low series inductance into the source connection to increase the effective resistance at the entrance and thus improve the stability and simplify the noise matching [2], [7].

The optimal generator resistance for noise matching at a specific frequency is determined in the manufacturer's data sheets through the reflection factor at the entrance to the amplifier stage. The

input network of the amplifier circuit must now convert the generator resistance from the antenna supplying the current to the impedance required for noise matching without any loss.

Without loss means that as little as possible additional attenuation should take place at the input - e.g. through coaxial junctions and / or lossy components.

As a rule, we make the assumption here of a real 50Ω system, which in practice is unfortunately available to only a limited extent (Fig.2).

3. DESIGN OF INPUT NETWORK FOR NOISE MATCHING

The manufacturer, NEC, gives an optimal reflection factor for noise matching for the NE 32484A at 10 GHz of MAG = 0.4, with ANG being 131, and at 12 GHz of MAG = 0.33 and ANG = 159.

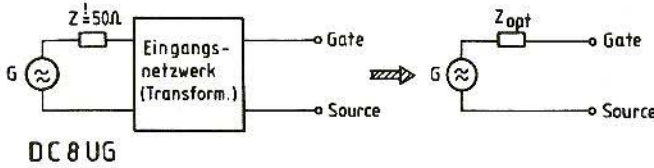

Fig.2:
Input Network
 Transforms $Z = 50\Omega$
 to Z_{opt}
Eingangsnetzwerk =
Input network

DC 8 UG

Z_{opt} = optimum generator resistance for noise matching

If we interpolate these specifications for 10.45 GHz, we get $MAG = 0.38$ and $ANG = 138$.

By putting these details into the Smith diagram (Fig.3), we obtain a good picture of the impedance transformation required.

The generator resistance of the antenna equipment (50Ω real) must thus be transformed in such a way that the FET input "sees" a series circuit made up of an ohmic resistance of 25.5Ω and an inductive resistance of 15Ω .

This signifies neutralisation, with a low series inductance at the input and a subsequent quarter-wave transformation in the direction of the generator.

An equivalent circuit diagram can now be created, with the help of the Puff software and the typical scatter parameters for the NE32484A (2 V / 10 mA) from the NEC databank, and used to design the input network required without any additional calculation tricks. Instructions for handling Puff and entering the necessary data are given in [2], with more detailed instructions in [6]!

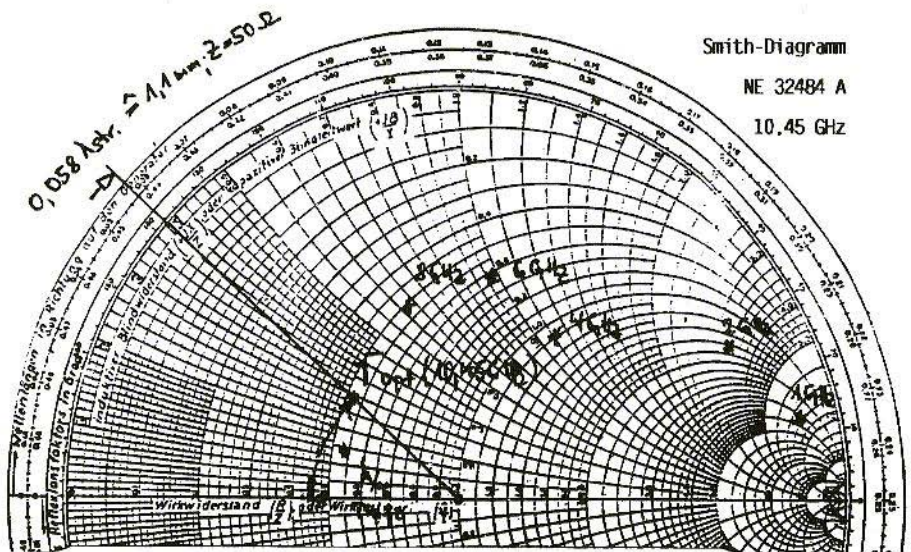

Fig.3: The Smith Diagram supplies Data on Impedance Transformation at 10.45 GHz

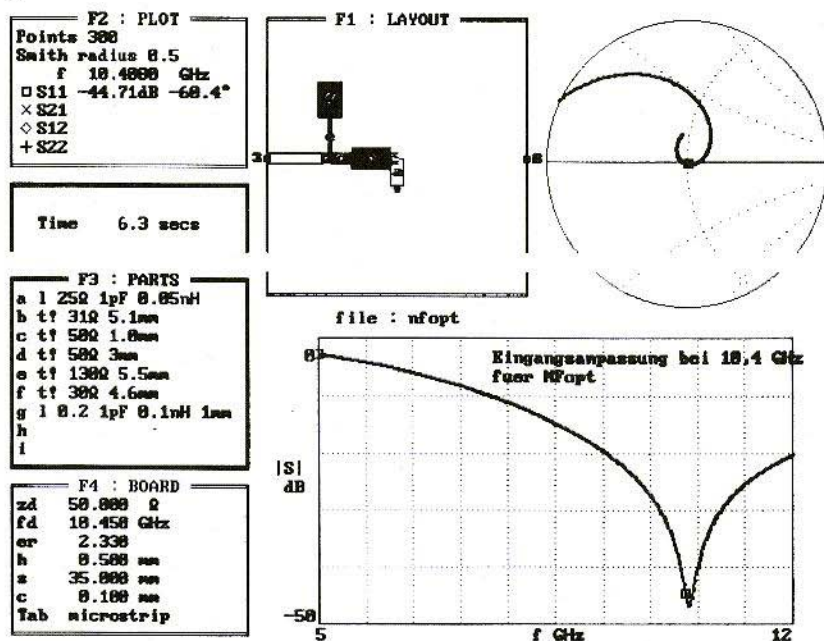

Fig.4: Puff Screen Printout of Input Matching for NF_{opt} at 10.4 GHz
Eingangsanpassung bei 18.4 GHz fuer NF_{opt} = Input matching at
 18.4 Hz for NF_{opt}

For this purpose, the input is simulated through the conjugate impedance of the generator by noise matching at the desired frequency - that is, a series circuit part (a) which is made up of 25.5Ω, and a capacitive resistance of 1Ω (1 pF). S11 is now brought to the lowest reflection value:

Initially through the low inductance in series - part (c) - (a 50Ω line app. 1 mm. long), and subsequently through quarter-wave transformation, with $Z = 31Ω$ - part (b) - to the 50Ω input impedance of the antenna.

Neutralisation by means of the app. 1 mm. long 50Ω line at the gate connection reduces the effective resistance fraction from 25.5Ω to app. 21Ω.

In the simulation, an additional inductance was introduced into the series circuit - part (a) - as a precaution. In the real circuit, this is created by the earth connection of the source connections. A value of 1 nH per 1 mm of connection length has been found by experience to be appropriate here.

If the earth contacting is carried out in an optimal way, an inductance of 0.05 nH remains to be taken into account - i.e. of app. 3.3Ω at the frequency in question.

$$Z_q = 25.5\Omega + 1\text{ pF} + 0.05\text{ nH} - \text{Part (a)}$$

or, based on frequency,

$$Z_q = 25.5\Omega - j\ 15\Omega + j\ 3.3\Omega$$

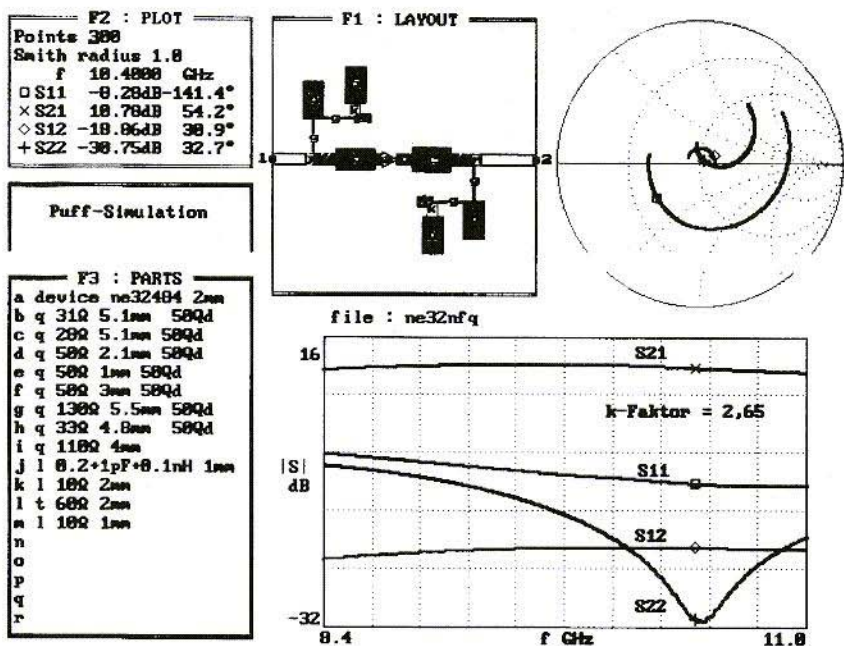

Fig.5: Simulated Output Transformation Curve, Plotted against Frequency

Fig.4 shows the Puff simulation and the reflection attenuation of over 40dB obtained.

4. SIMULATION OF AMPLIFIER CIRCUIT

Single-stage noise-matched amplifiers usually achieve an amplification of only 10 to 12dB in the X band, and can therefore be used only as "front-end amplifiers" in a receiver installation.

The output impedance of the NE32484A (generator resistance of transistor) at 10.4 GHz can be represented through a

series circuit consisting of the capacitance and the ohmic resistance ($30\Omega - j 35\Omega$), which is transformed to the required connection impedance of 50 Ohms, as in the input circuit, using the combination of a 50Ω phase line 2.1 mm. long - part (d) - and a quarter-wave transformer - part (c). This transformation is relatively narrow-band, but is thoroughly suitable for amateur applications.

Fig.5 shows the simulated curve of this output transformation, plotted against the frequency - S22.

The input transformation is carried out using the transformation elements determined for noise matching, so that the following S parameters are obtained for the selected frequency (10.4 GHz):

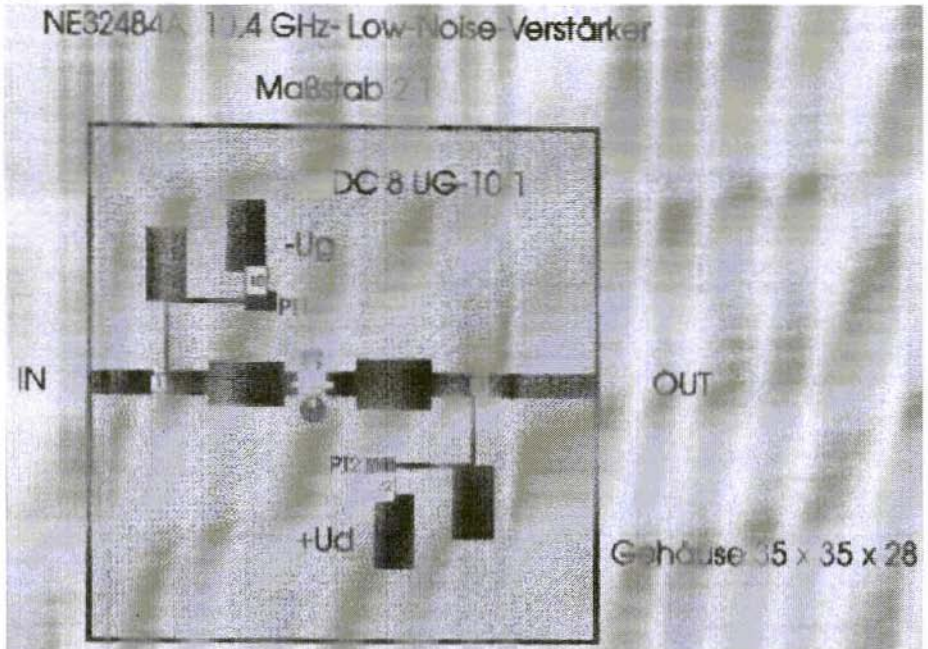

Fig.6: Layout of Low-Noise Amplifier for 10.4 GHz
Verstärker = Amplifier, Maßstab = Scale, Gehäuse = Housing

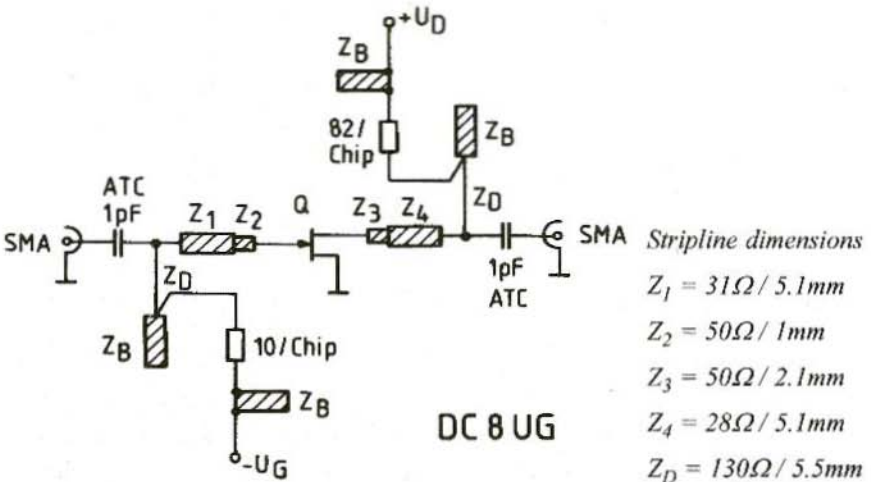

Fig.7: Wiring Diagram of HEMT Pre-Amplifier for 10 GHz

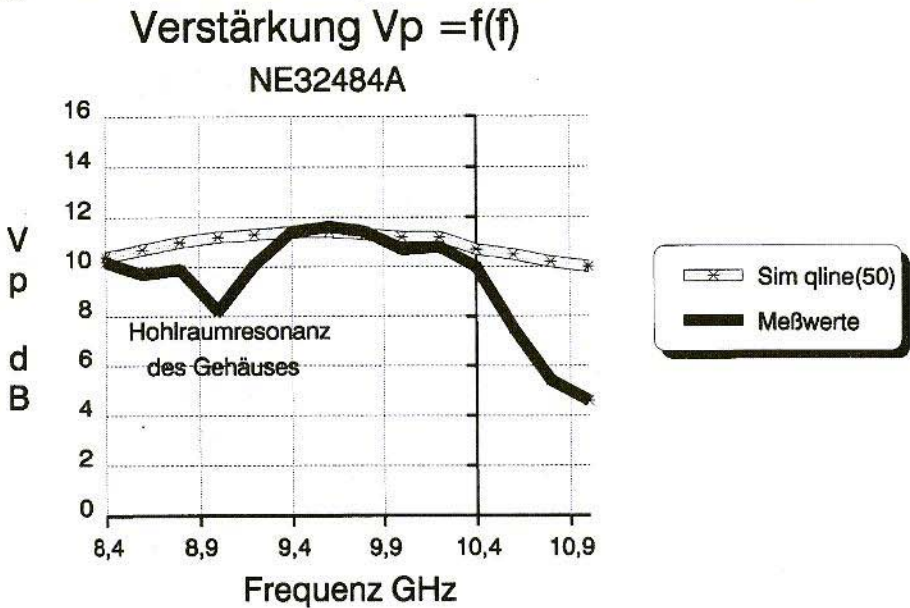

Fig.9: Housing Resonances at 9 and 11 GHz

Verstärkung = Amplification, *Hohlraumresonanz des Gehäuses* = Housing cavity resonance, *Meßwerte* = Readings

stripline transitions, because we need coaxial transitions with losses as low as possible.

As an alternative, the normal gold-plated flanged jack is also acceptable, with a long Teflon insulator and a gold pin.

The source connections on the specimen assembly were connected to earth through two hollow copper rivets (diameter 1.5 mm). For this purpose, the hollow rivets must be fitted in such a way that they are flush with the board surface.

The author uses SMD solder as soldering tin. It does not contain much flux and it corresponds to DIN 9516.

6. MEASUREMENT RESULTS AND COMPOSITION

At the sweep measuring position, we discovered that with the selected housing size of 34 x 34 x 28 mm there were cavity resonances, but fortunately these lie outside the useful frequency.

In the frequency range from 8 to 12 GHz, two resonance points were observed, which were defined, firstly, by the housing diameter, and, secondly, by the distance between the board and the housing cover.

Fig.9 shows these resonance points at app. 9 GHz and 11 GHz. By lining the

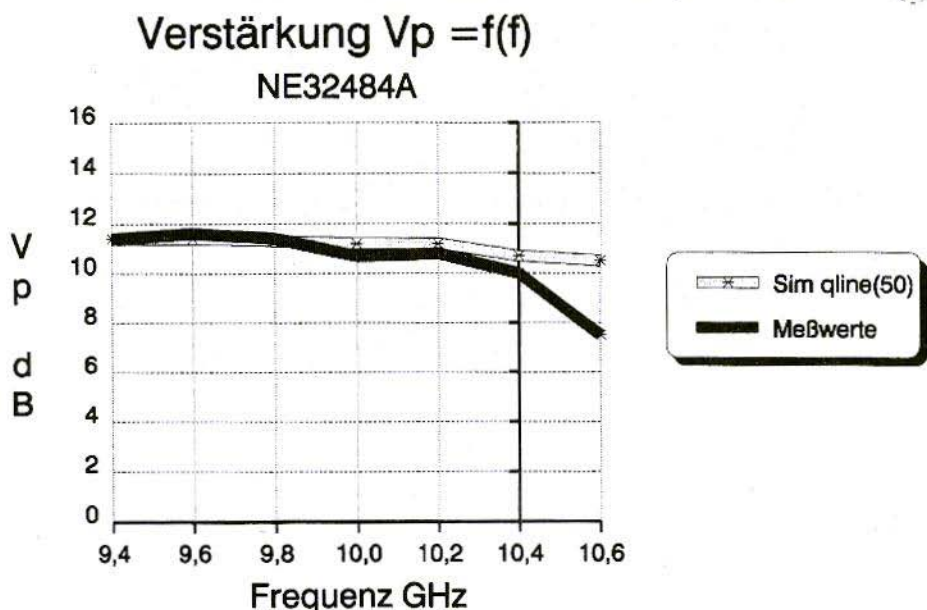

Fig.10: Measured Amplification Curve Compared with PUFF Simulation
Verstärkung = Amplification, Meßwerte = Readings

inner housing wall and the inside of the cover with sound-proofing material (sponge rubber, etc.), we can reduce the resonance and thus also displace it in frequency terms. Of course, this does not lead to any disadvantages at the operating frequency of 10.4 GHz.

Fig.10 shows the swept amplification curve in the range between 9.4 and 10.6 GHz, compared to the simulation using Puff (S21).

The relatively good match between the computer model and the real circuit can be recognised here.

The subsequent noise factor measurement was carried out using an Ailtech precision noise test rig and the AIL source 7618, and gave a stage noise factor of 0.8dB for the specimen assembly at an amplification of 10.5dB.

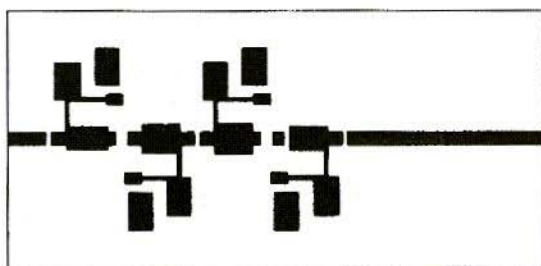

Fig.11:
Printed Circuit Board Design
for Two-Stage Low-Noise
Amplifier for 10.4 GHz with
NE 32484A

Actual size = 72.5 x 35mm

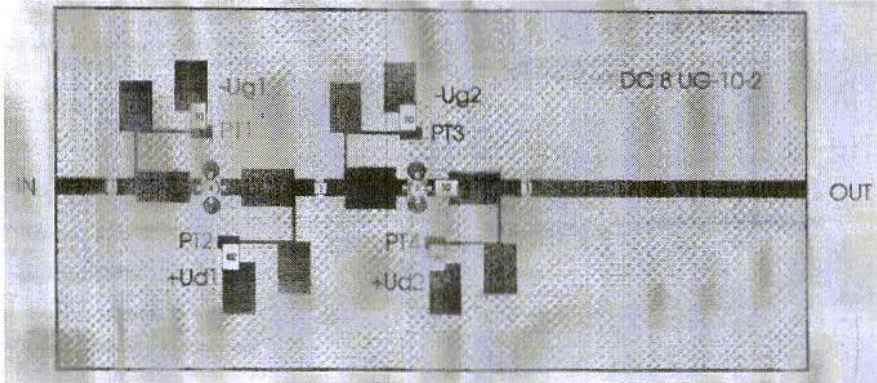

Fig.12: Components of Two-Stage Low-Noise Amplifier
Housing 72 x 35 x 28

The manufacturer, NEC, gives a noise factor of 0.5 to 0.6dB for the transistor as a component at 10.4 GHz, with an amplification of app. 11.5dB.

By refining the structure of the amplifier, the noise factor can still be shifted towards 0.7dB, if the additional attenuation (app. 0.1dB) which is bound to arise from, among other things, the transition from the normal SMA flanged jack to the track is minimised. Here we must work with the special SMA jacks for stripline coupling, or chamfer the central pin down to 45 degrees before installation.

Another tried and trusted method is to solder the flange of the SMA jack to the housing inside, and then reduce the central pin to a length of 0.5 mm., in order to solder it onto the stripline.

Otherwise any amplifier which attains a noise factor below 1dB is most suitable for use with tropo scatter and rain scatter links in the X band. A two-stage amplifier has the advantage, of course, that good total noise factors can also be

expected as a result of the multiplied amplification even if the subsequent stage displays only a modest degree of sensitivity.

Fig.11 shows the Puff design for such an amplification stage, which is then noise-matched in the first stage and power-matched in the second stage.

7. LITERATURE

- [1] Unger-Harth: High-Frequency Semi-Conductor Electronics
Hirzel-Verlag Stuttgart
ISBN 3777602353
- [2] Weinreb, S.; Fenstermacher, D.L.;
Harris, R.: L-Band Cryogenically Cooled GaAsFET Amplifiers
IEE Trans. MTT-30, no. 6,
June, 1982, pp. 849 - 853



- [3] Wedge, S.W., Compton, R., Rutledge, D.: Puff Computer Aided Design for Microwave Integrated Circuits
Puff Distribution, California Institute of Technology, Pasadena
VHF Communications no. 1/1997, pp.35 - 56
VHF Communications no. 3/1997, pp. 167 - 179
VHF Communications no. 4/1997, pp. 209 - 214
- [4] Fleckner, H.: A Power Amplifier for the 13cm Band in GaAs Engineering
VHF Communications 4/1995, pp. 130 - 139
- [5] Fleckner, H.: A 10-Watt Power Amplifier for the 13cm Band in GaAs Engineering
VHF Communications 3/1994, pp. 130 - 141
- [6] Kraus, G.: Design and Execution of Microwave Circuits, Parts 1 to 4
VHF Communications no. 1/1996, pp. 244 - 250
- [7] Bertelsmeier, R.: Low-Noise Preamp for 1.3 GHz
Dubus-Informationen no. 1, 1994, pp. 37 - 50
- [8] Zimmermann, E.: Low-Noise 24-GHz Pre-Amplifier
Dubus-Informationen no. 1, 1994, pp. 23 - 28

Note: The source code for the Turbo-Pascal program for calculating the K factor referred to above can be obtained from the publishers (Reader Services Dept.). Please enclose a stamped addressed envelope.

PUFF

MICROWAVE CAD SOFTWARE

Complete with full handbook

£21.50

Shipping UK £1.50; Surface £3.00; Air £5.00

KM Publications, 5 Ware Orchard, Barby,
Nr.Rugby, CV23 8UF, UK Tel:
(0)1788 890365 Fax: (0)1788 891883
email: sales@vhfcomm.co.uk

GHz ACTIVITIES

RAIN SCATTER AS FAR AS BASLE

10-GHz reflections via rainclouds in relatively flat areas, or going out from mountains, are normal, and have been known about for a long time. But now, for the first time, a QSO from Weinheim has traveled over the Black Forest down into the valley and as far as Basle. Dieter, DL3NQ and PüüP, HB9MMM, achieved this success over 243 kilometres with RS 55/42, and even in SSB.

Dieter, DL3NQ in Weinheim JN49IN, has amassed a lot of experience with 10 GHz and rain scatter in his region together with Frank, LX1DU. For a long time now, he had been waiting for the chance to be able to push forward into the South as well. But there are hardly any stations in North-West Switzerland or in Alsace with suitable equipment. Moreover there are (still) no beacons available there.

The first successful attempt has now been made to send a QSO down into the valley below, as far as Basle JN37SM, to "PÜÜP", HB9MMM. On 24th April, 1996, RS 55/42 reports were exchanged

between 15.19 and 15.31 UTC. The signals were even easier to decipher in CW. Average QSB prevailed, and naturally the usual scatter chirp was noticeable.

The signals from Dieter, DL3NQ initially took almost a direct line up the Rhine valley, and then had to cross over a few of the foothills of the Black Forest between Kaiserstuhl and Freiburg via rain scatter. The signals from PÜÜP, HB9MMM went over these hills at a radio bearing of 19 degrees, without any elevation, just to the West of the blue skies of Germany and into the scatter.

In the hot Summer weather which is approaching, the rainclouds - and especially the cumulo-nimbus clouds - will be higher, which means the distances will increase. Anyone interested in a sked can contact HB9MMM through PR Box HB9EAS-8.

P. Waldener, HB9MMM,
CH-Binningen



Index of Volume 29 (1997)

Article	Author	Edition	Pages
ANTENNA TECHNOLOGY			
A Genetically Designed Yagi	Richard A Formato K1POO	1997/2	116 - 213
HF EQUIPMENT			
An Ultra Low-Cost HF SSB/CW Transceiver with 20W Output, an AGC Meter, S-Meter and Audio Filters: Part-3 Description of Assembly	Denys Roussel F6IWF	1997/4	218 - 236
SATELLITE RECEPTION			
NOAA HRPT Receiver	Matjaz Vidmar S53MV	1997/3	130 - 151
Tips, Improvements and Corrections: A GPS/GLONASS Satellite Receiver	Matjaz Vidmar S53MV	1997/3	187 - 189
GPS/GLONASS Receiver Hardware and Software Update #1	Matjaz Vidmar S53MV	1997/4	252 - 253

2m / 70cm / 23cm / 13cm / 3cm

A broadband VHF-UHF-SHF Amplifier	André Jamet F9HX	1997/3	185 - 186
-----------------------------------	---------------------	--------	-----------

23cm BAND

Pre-Mixer for 23 and 13cm	Walter Zwickel OE2TZL	1997/1	20 - 29
23cm PSK Packet Radio Transceiver for 1.2 Mbit/s User Access	Matjaz Vidmar	1997/2	74 - 96

13cm BAND

Pre-Mixer for 23 and 13cm	Walter Zwickel OE2TZL	1997/1	20 - 29
---------------------------	--------------------------	--------	---------

3cm BAND

A 10 GHz Super-Regenerative Receiver	André Jamet F9HX	1997/1	2 - 12
--------------------------------------	---------------------	--------	--------

MEASURING TECHNOLOGY

VHF, UHF and SHF Measuring Methods using a PC; Part-3: 0.9 - 1.5 GHz Synthesiser	Wolfgang Schneider DJ8ES	1997/1	13 - 19
Elimination of Self-Oscillation Ponto in the DB1NV Spectrum Analyser	Andraes Schaumburg DF7ZW	1997/2	110 - 115
VHF, UHF and SHF Measuring Methods using a PC; Part-4: High-Frequency Test Rig for up to 1.4 GHz	Wolfgang Schneider DJ8ES	1997/3	152 - 166
VHF, UHF and SHF Measuring Methods using a PC; Part-5: mW Meters, Wobblers and Spectrum Analysers	Wolfgang Schneider DJ8ES	1997/4	194 - 208



MEASURING TECHNOLOGY (continued)

DBINV's Image Memory in Combinations with the HP 141 Spectrum Analyser	Lorenz Oelschlegel DL6NCI	1997/4	216 - 217
--	------------------------------	--------	-----------

FUNDAMENTALS * NEW TECHNOLOGY

Design and Realisation of Microwave Circuits; Part-2	Gunthard Kraus DG8GB	1997/1	35 - 56
Danger - Parasites!	D.Eckart Schimtzter DJ4BG	1997/2	97 - 102
Noise Behaviour of Zener Diodes	Dr.Ing. Jochen Jirmann	1997/2	103 - 109
Design and Realisation of Microwave Circuits; Part-3	Gunthard Kraus DG8GB	1997/3	167 - 179
Transistor Calculations using Rules of Thumb	D.Eckart Schimtzter DJ4BG	1997/3	180 - 184
Design and Realisation of Microwave Circuits; Part-4	Gunthard Kraus DG8GB	1997/4	209 - 214
The Sine Converter	Dipl.-Ing. Detlef Burchard	1997/4	237 - 251

MISCELLANEOUS

Splash - a Review	Michael J Wooding	1997/1	57 - 61
-------------------	-------------------	--------	---------

BINDERS FOR VHF Communications

each binder holds 3 year volumes - 12 issues

£5.50 each

p&p: UK: £0.75; Overseas: £1.25; Air mail: £3.00

Credit card orders +5%

VHF Communications

Back Issues

Back issues of VHF Communications Magazine are available at £2.50 each

Issues available: 1, 2, 3, 4/1972 * 2/1973 * 1/1974
 1, 3, 4/1975 * 3/1976 * 1, 4/1977 * 1, 2/1978 * 1, 3/1979
 1, 4/1980 * 1, 2/1981 * 1/1982 * all 1983 to 1987
 1, 3, 4/1988 * 1, 2, 4/1989 * 2, 3, 4/1990 * all 1992 to 1996

Price includes surface shipping, for Air Mail add £0.75 per issue. Credit card orders +5%

*A complete set of available issues to 4/1996
 £120.00 plus shipping at cost*

**KM Publications, 5 Ware Orchard, Barby,
 Nr.Rugby, CV23 8UF, UK**

Tel: (0)1788 890365 Fax: (0)1788 891883

Email: vhfsales@vhfcomm.co.uk Secure WWW Form 

<https://www.vhfcomm.co.uk/saleform.htm>



Denys Roussel, F6IWF

An Exceptionally Low-Cost HF-SSB/CW Transceiver

Part 4: Assembly Instructions

(continued - conclusion)

4. MECHANICAL ASSEMBLY

As this transceiver was primarily intended for use as second equipment (week end, holidays etc.), the size of the box should be suitable for portable use.

For portable use, an internal battery is very interesting, but useful operation requires at least a 6AH pack and consequently most of the volume and weight is taken by the battery. Nevertheless, I preferred to keep the battery inside and benefit from a real portable capability.

Finally, the box size was fixed to 19 x 8 x 27cm as shown in Fig.21.

The material used for the box is 1mm thick tin-plate inside and aluminium outside, Fig.22 shows the internal chassis arrangement. Fig's 23 to 26 give the dimensions of the various cabinet parts, with Fig's.27 and 28 showing the front panel layout and Fig.29 the rear panel.

5. TESTING AND ALIGNMENT

5.1. VFO, RF Phase Shifters and Mixers

First, wire up the VFO, the RF phase shift and the mixer board.

Centre the VFO on the range 28.0 - 30.4 MHz by the select-on-test choice of CVa and CVb (depending of the variable capacitor used). Use NPO capacitors. RTC "C642" types give good results. Check the wave form at VFO out and the division by 4 of 1C901. With a dual trace oscilloscope, it is possible to check the phase shift between the two clocks.

Connect a 40m antenna (dipole) to the mixer board input (Filters IN I OUT), and an AF amplifier to AFRX1. Connect +TX to Ground and +RX to +12V. You should receive the 40 metre band. The level should be the same on the two outputs AFRX1 and AFRX2.

Check the operation of the RF pre-amp. You should obtain almost 10dB of gain when ON.

Connect +RX to Ground and +TX to +12V. Connect a 1 metre length wire at the filter OUT and the output of a microphone preamplifier at AFTX1 (few hundred of millivolts). Check the DSB quality on a receiver. It should be the same for both inputs AFTX1 and 2.

5.2. Band Pass Filter Board

In receive, you can observe the effect of the filter: up to about 7130 kHz, you can hear the band noise when connected to the antenna. Above 7150 kHz the attenuation becomes more important and broadcast stations are attenuated.

In transmit, you should obtain about 5mW after T501 on 7000 to 7100 kHz.

Power Supply

Power Amplifier

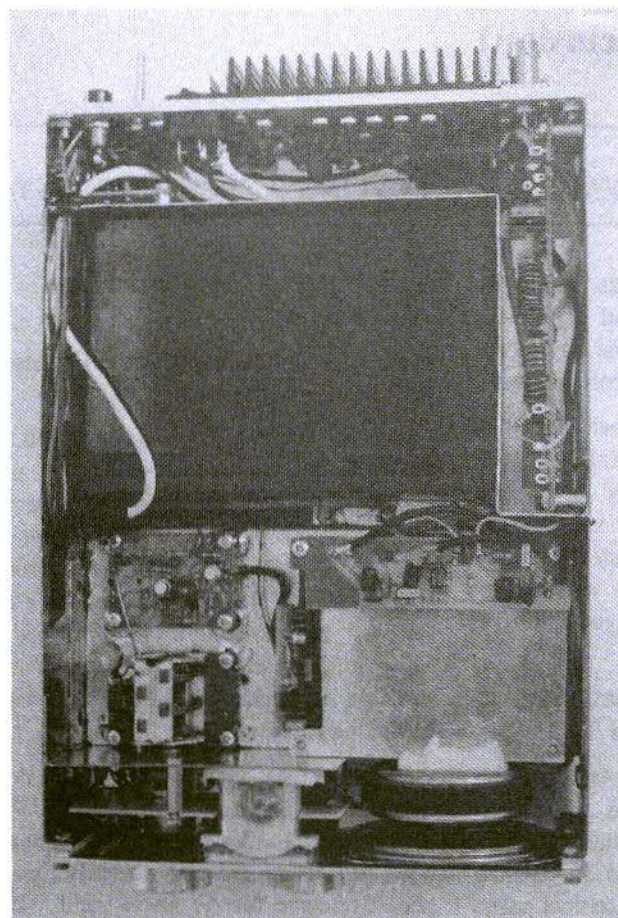

Antenna Socket

12V Battery

RF Low-Pass Filter

VFO

RF Band-Pass Filter

Loudspeaker

S-Meter

Fig.21: Internal Layout of the Various Assemblies

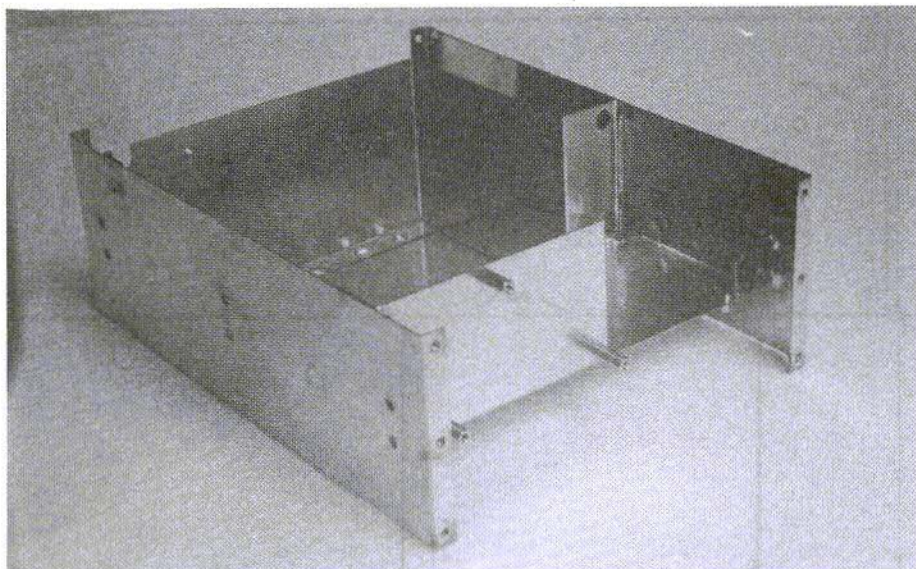

Fig.22: The Internal Chassis

5.3. Power Supply Unit

Connect a 220 Ω resistor to ground on the +TX output. Check the +TX and +RX voltages versus the PTT state. With 13.0V power supply: PTT open : +RX = +12.8V; +TX <0.5V; PTT closed : +RX = < 0.1V; +TX = 13.1V.

Please note that the 220 ohm resistor is necessary to pull down the +TX below 0.5 V in receive mode as it simulates the antenna relay coil when the LPF unit is not connected. If +TX is too high (0.8 to 1V) the AGC will not operate correctly as T303 starts to conduct.

If the antenna relay coil resistance is too high the 220 Ω resistor must be fitted.

5.4. AF board:

5.4.1 Receive mode:

Initially check the power supply and +6V line on the IC sockets before insert the IC's. Check the +8V and the +5V. Place a jumper between pins-8 and 9 of 1C205 location instead of fitting the IC. Ground the PCB at the screws near C322.

Connect the unit to the mixer board and inject a 50 μ V signal at the antenna input (7050 kHz).

Listen to the note on each side of the zero beat. On upper side band, the signal should be lower.

Set P201 for minimum signal. Place the capacitor C902 to Q1 or Q2 (start with 10 pF) to improve the rejection and tune P201 again. I find 18pF the best value from Q2 to ground. On another phase

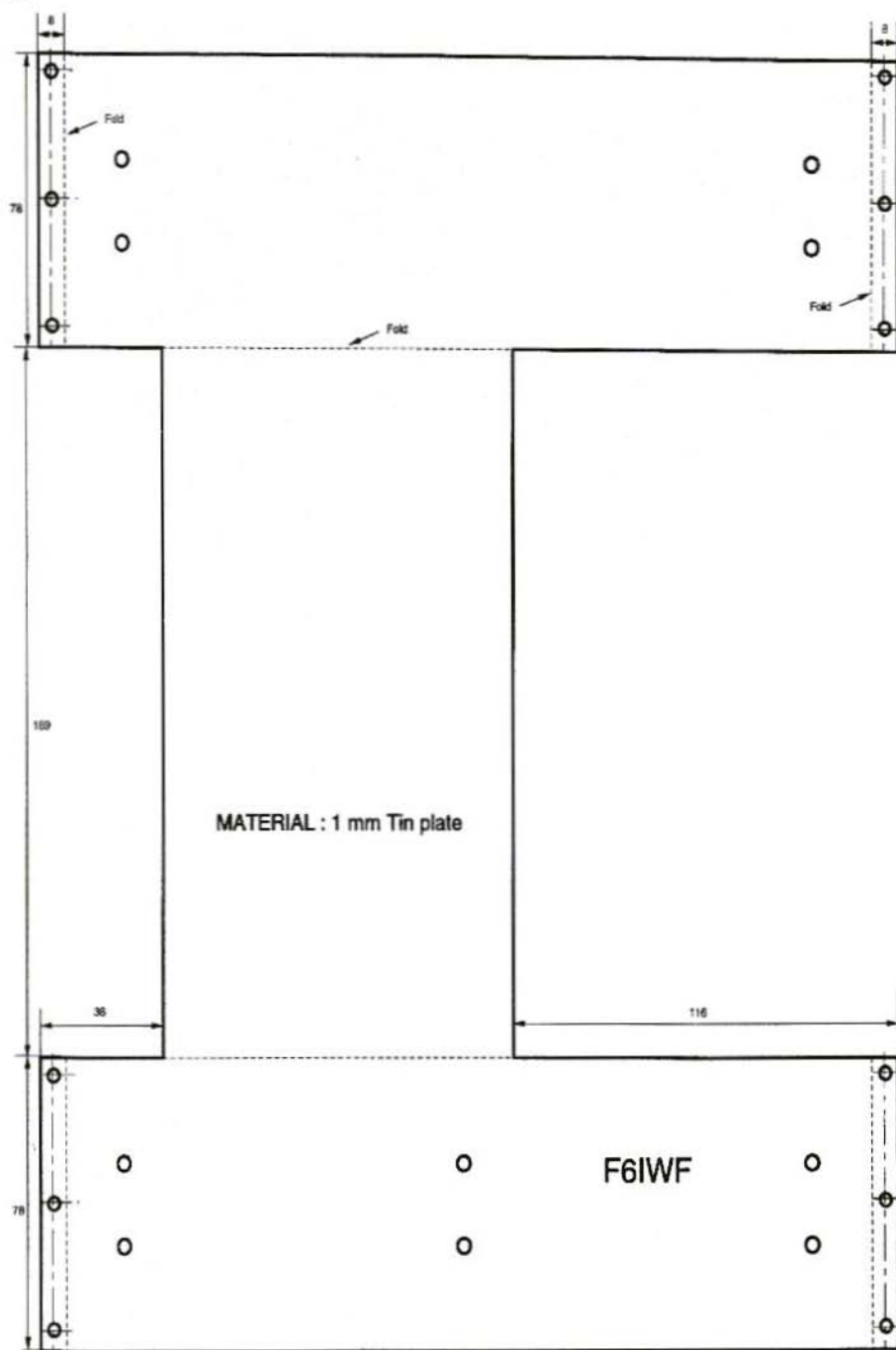
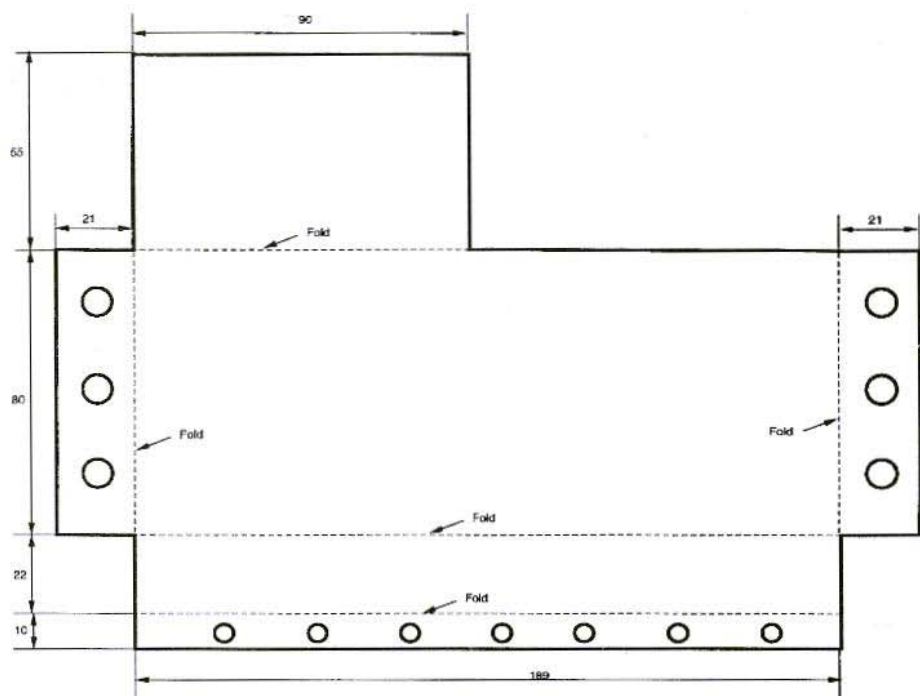

Fig.23: Main Cabinet



The holes help to solder the PCB's support to the main cabinet

MATERIAL : 1 mm Tin plate

PHASING TRX - PCB's support
F6IWF

Fig.24: PCB Support Chassis

shift sample, it was 6.8pF at Q1.

You should obtain at least 40dB below the lower side band.

Set P301 for an S9 reading on the S-Meter for 1 kHz AF on lower side band.

Check the Narrow filter and CW filter positions, and the AGC ON/OFF.

Check the action of the volume control, the transceiver should stay stable in all modes with the maximum AF gain setting and no signal at the input.

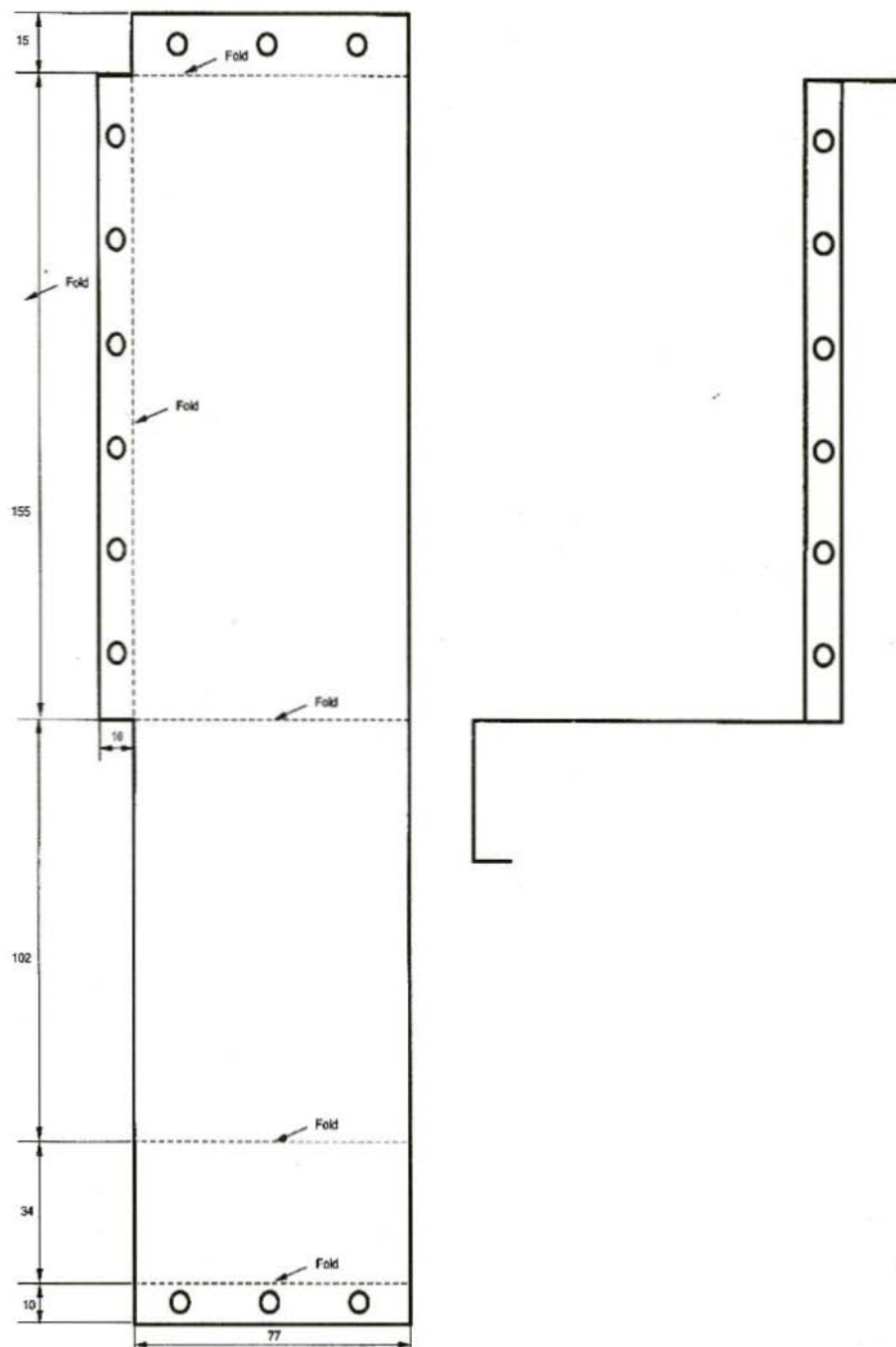

Fig.25: Battery Compartment



Fig.26:
Mixers & Band Pass Filters
Screen

Material : tin plate 0.5 mm

5.4.2. Transmit Mode:

Depress the PTT, check the microphone signal at pin-7 of IC301 and at AFTX1 and AFTX2 on the mixer board.

Press the CW Key, you should hear a tone in the loudspeaker. Tune P1002 for the maximum level at the pin-14 of IC301. Set P1001 for a correct delay.

On a receiver, observe the signal on the upper side band when Key down and tune P101 for a minimum signal on the upper side band. You should obtain at least 30dB below the lower side band signal.

In phone mode, the signal should be not readable on the wrong side band after P101 setting. Of course if a spectrum analyser is available, the tuning is very fast and easy.

5.5. Power Amplifier Unit

Connect the permanent 12V (12VP), to the unit. Apply the +TX with no input signal.

Check the +12V on collector of T601, T602, T603. Check the current through T601 at 70mA, with 0.6 V across R603

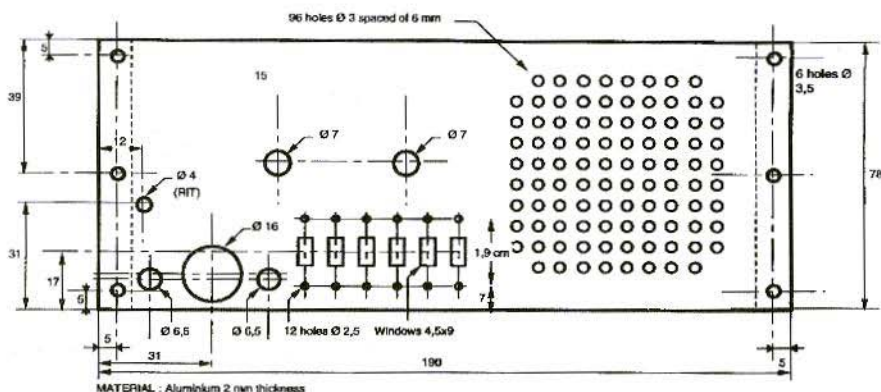

Fig.27: Front Panel Hole and Cutout Details

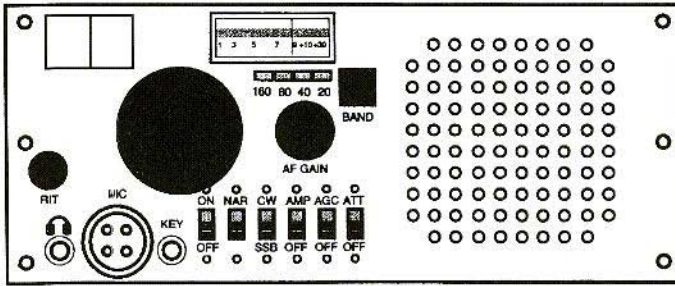

Fig.27: Front Panel Layout

and the current through T602/T603 at 20 to 40mA with 10 to 20mV across R606/R607.

Connect the Low Pass Filter unit. Connect a 50Ω dummy load and a wattmeter at the output. Apply the +12V HIGH AMP through a 10A ammeter. Set P601 for 250mA quiescent current.

Apply the solder iron on the case of D602, the current should decrease,

Connect a 15 MHz generator at the input of the amplifier. Increase the power and observe the current and output power.

For an output power of 20W, the current should be about 4A. Tune C604, C609 and C615 for the best gain at 15 MHz.

The efficiency is about 50%. Poor efficiency is the sign of poor Ft of the transistors.

Connect the input of the amplifier to the Band Pass Filter unit. The power on a whistle should be of the order of 30W with 13V supply. Tune P701 (ALC) to limit the power to 20W. The S-Meter needle indicates S9+.

Set the MIC amp potentiometer for a deviation of the needle which follows

the modulation. Check the ALC action by changing the distance of microphone from the operator.

Set the CW power control P1003 for a 20W output at 7040 kHz on a CW tune.

This completes the tuning of the transmitter.

6. COMPONENT CONSTRUCTION DETAILS

Unless otherwise specified all coils are formed from 0.25mm enamelled copper wire

L001 to L006:

40 turns 0.15mm diameter wire on a 4 x 6mm ferrite bead, hole diameter 2mm. The inductance is app. 3mH.

TR2: 1:4 Transformer:

Two wires twisted - 0.25 mm diameter, 2 twists per centimetre.

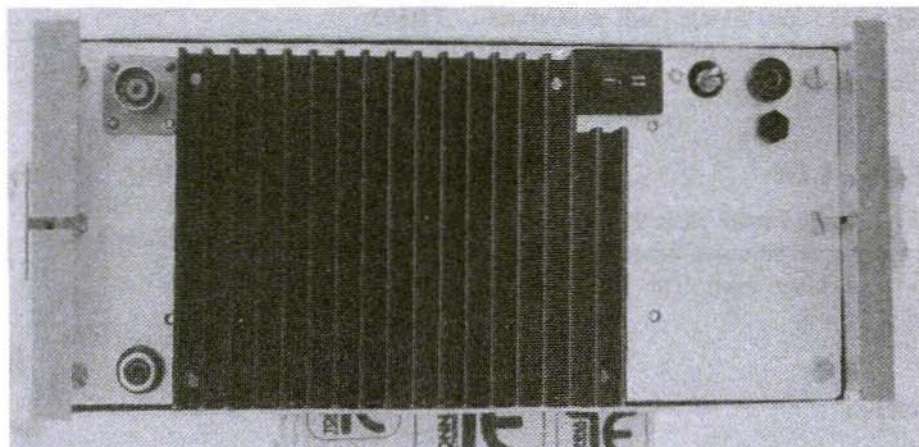
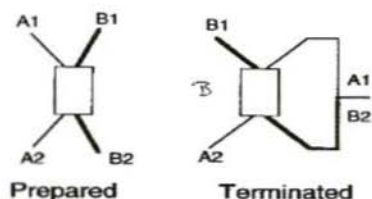

Fig.29: Layout of the Rear Panel

Wind 7 turns of bifilar on a 7 x 4 mm ferrite bead, hole diameter 2mm. Use different colours wires. Verify the continuity A1-A2 and B1-B2, and the isolation between A and B at the preparation stage.



TR3 to TR6: 1:1:1 Transformer:

Three wires twisted - 0.25 mm diameter, 2 twists per centimetre.

Wind 8 turns of trifilar on a 7 x 4 mm ferrite bead, hole diameter 2mm. Use different coloured wires. Verify the

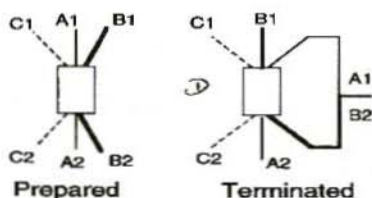

continuity A1-A2, B1-B2, and C1-C2, and the isolation between A, B and C at the preparation stage.

TR7 to TR 10 (OPTION): 1:1 Balun Transformer:

Two wires twisted - 0.25 mm diameter, 2 twists per centimetre.

Wind 8 turns of bifilar on a 5 x 3mm ferrite bead. Use different coloured wires. Verify the continuity A1-A2 and B1-B2 after winding.

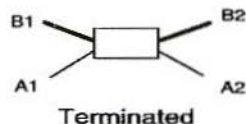

L801:

9 turns of 1mm diameter enamelled copper wire on a 10mm diameter plexiglass core.

Fix with 2-part glue. The core is drilled and screw cut at the base

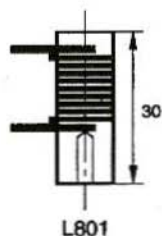

for a M3 screw fixing. Coils extremities are soldered onto two pins inserted in the plastic.

L401 to L408:

20 turns 0.15mm diameter enamelled copper wire on a 4 x 6mm ferrite bead, hole diameter 2mm. The inductance is app. 100uH.

TR401:

On two ferrite beads 5 x 3.5mm, hole diameter 1.5mm .

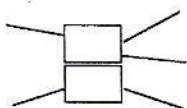

Primary (emitter of T401): 1 turn
Secondary (collector of T401): 15 turns, the tap is at 11 turns from the collector.

L802:

20 turns 0.15mm diameter enamelled copper wire on a 470Ω 1/4W resistor.

L803 to L805:

30 turns 0.15mm diameter enamelled copper wire on a 4 x 6mm ferrite bead, hole diameter 2mm. The inductance is app. 200uH.

TR501 and 502:

14 turns on a 7 x 4mm ferrite bead, the tap is at 5 turns from the ground end.

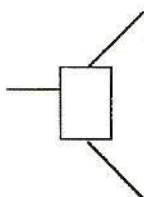

TR503:

On two ferrite beads 5 x 3.5mm, hole diameter 1.5mm.

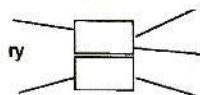

Primary (emitter of T401): 2 turns
Secondary (collector of T401): 6 turns, the tap is at 2 turns from the collector.

L601:

4.7u H SMD Choke

TR601:

On two ferrite beads 7 x 4mm.
Primary: 10 turns
Secondary: 4 turns, twisted wire.

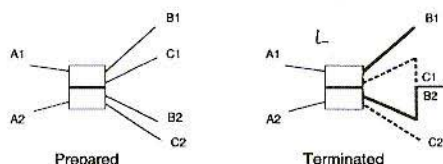

TR602:

On a 4C65 2-holes core (Fig.M): 4 turns of 6 twisted wires of 0.35mm diameter.

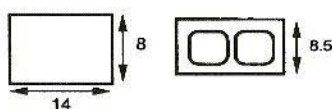

Primary (collector of T601)
A1/B2-C1/D2: use 4 wires.

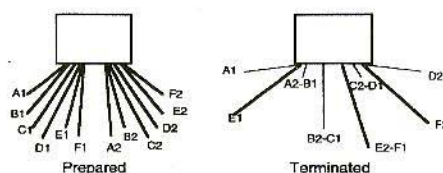



Secondary (bases of T602/T603):

E1/E2-F1/F2: use two wires.

A2-B1 and C2-D1: soldered together but not used.

TR603:

On two ferrite tubes 4C6 25 x 14mm, hole diameter 0 8mm joined by adhesive tape.

Primary (collectors): 2 tubes diameter 7mm covered by adhesive tape. Use shield of rigid coax cable designed for SMATV.

Secondary (antenna): 2 turns of large plastic insulated wires.

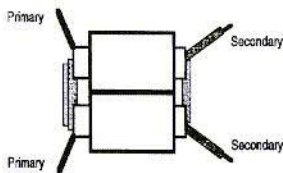

L701 - L702: 1uH:

41 turns of 0.5mm wire on plastic core (water pipe).

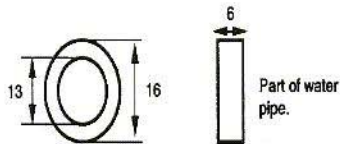

L1101:

8 turns bifilar 1mm 2 plastic insulated wire on a 15mm diameter interference suppression core.

Ceramic filter:

SFE 7.02 MC MURATA

Final Comment: I consider that the job is now nearly complete. However, I all be considering designing multiband options and a frequency stabiliser circuit.

Note on article:

Wolfgang Schneider, DJ8ES

VHF, UHF and SHF Measuring Methods Using a PC - Part 4

The component drawing showing the assembly DJ8ES 030, VCO contains an error. Transistor BC 549 should be rotated through 180°. The transistor is correctly drawn in the circuit diagram.

The two BB621 diodes, to earth, stand vertically in the plane of the board and are soldered flush on the earth side.

Gunthard Kraus, DG8GB

Design and Realisation of Microwave Circuits

Part 5

8. THE STRIPLINE BAND PASS for 1,700 MHz

8.1. Preliminary observations

Behind the pre-amplifier chain there follows a band pass, which is to ensure that only the input frequency range around 1,700 MHz is made available to the mixer. It also prevents the oscillator frequency effective in the mixer from seeking a way back to the antenna through the amplifier.

So we must lay down the following requirements:

- a) Insertion attenuation as low as possible for the Meteosat reception range around 1,700 MHz
- b) Insertion attenuation as high as possible for the oscillator frequency (used in this design) around 1,600 MHz
- c) Insertion attenuation just as high for the image frequency range of 1,500 MHz, to prevent the noise there from

being transferred onto the intermediate frequency selected here (app. 100 MHz) and thus making the noise factor of the entire system worse.

That means a pass range curve "displaced right", which still lets 1,700 MHz through well (just), but on which the oscillator frequency and the image frequency are already as far out on the "sloping flanks" as possible, and are strongly attenuated.

The question of the type of filter assembly now arises. Among the various options for the gigaHertz range: helix filter, inter-digital filter, Stripline filter, coaxial filter, etc., the Stripline filter was deliberately picked out, for the following reasons:

- a) To gain experience in the creation of such filters - both in simulation using Puff and in the production of the printed circuit
- b) Inexpensive manufacture
- c) No balancing of any sort required
- d) Absolute reliability for copying, if the



scattering in the track dimensions or the board material properties is kept small in series manufacture.

The relatively large dimensions should be pointed out as the biggest disadvantage of this filter as soon as the degree of filtration is increased in order to obtain steeper flanks. The only way out is to use board material with very high dielectric constants and correspondingly large shortening factors - for example, RT-Duroid 6810 would be normal here, with $\epsilon_r = 10.4$ to 10.8.

8.2. Dimensioning documents for Stripline band passes

Unfortunately, Stripline band passes are not as easy to calculate and dimension as a parallel oscillation circuit. What we are actually dealing with here is a series circuit of "coupled line sections, each with 90 degrees of electrical length", with the high computing power of modern computers being indispensable for the analysis and dimensioning programs which are required.

Here there are only two options available to the user in normal cases:

a) To use the third-degree "bpf.dev" specimen deep pass supplied on the Puff diskette - i.e. with three consecutive, coupled microstrip line pairs - and to dimension it for the board material used, the band pass frequency provided for and, as far as possible, the required band width.

b) To obtain relevant literature on this topic, struggle through it, and then design the appropriate filter yourself, but now at a markedly higher degree of

efficiency, to obtain a better characteristic.

Once again, both paths were followed, so that we could obtain a direct comparison between the necessary expenditure on a specialist literature search and on Puff simulation, and obtain the resulting readings for the specimen circuits.

8.2.1. Working with "bpf.puf" specimen band pass

Call up the "bpf" file and enter the medium frequency, 1,693 MHz, the dielectric constant (most recent version: 4.32 at 1,693 MHz) and the board thickness, 1.5 mm. in field F4.

Then carry out an initial computing cycle.

Default in F2: 200 computation points, frequency range 1-2 GHz, value range for S_{21} and S_{11} from 0 to - 25 dB. Finally, press "p" for "plot".

First store the result under a suitable name - for example, BP1700M - and leave Puff for a short time.

Now call up the word processing program and load file "BP1700M". Now enter the data valid for the FR4 material as already used:

Dielectric constant, $\epsilon_r = 4.32$
 Dielectric loss factor, $l_t = 0.015$
 Thickness of copper, $mt = 35\mu\text{m}$
 Surface roughness, $sr = 0.002$ mm.
 Minimum conductor spacing = 0.2 mm.

Store the file again (without word processing formatting signs!), re-load Puff, call up file "BP1700M" again. Insert the now familiar exclamation

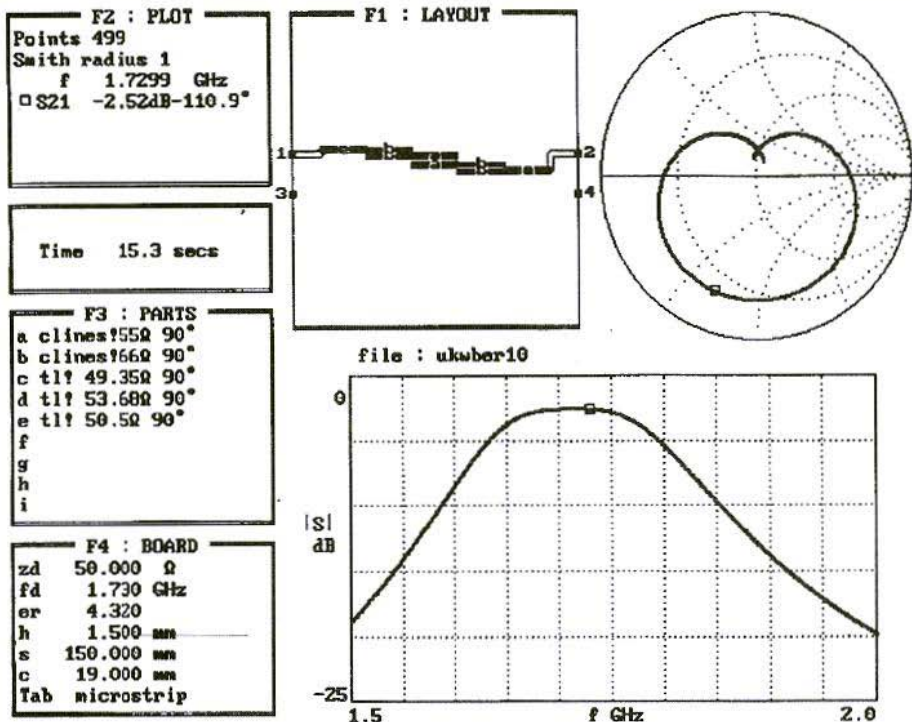

Fig.31: Simulation of Lossy Bandpass

mark in field F3 for each Stripline, behind the word "clines" (which can be abbreviated to "c" without any problem).

Now start another plotting procedure, to obtain a realistic prediction of the pass range curve and transmission loss the completed filter will display when engraved.

If the medium frequency has to be displaced further, this can be done in field F4, under item "fd", while the band width, and thus the form of the pass range curve, can be changed by altering the resistance values in the two coupled Striplines in the components list, F3.

The following conditions apply here:

a) If the impedance level given in F3 (this is the "Even" value) for one of the two line pairs increases, the band width increases. Of course, as in a two-circuit band filter, the curve takes on the typical "dip" caused by over-critical coupling.

But be careful. Changes of 0.5Ω are already sufficient to produce a sharp bend in the curve!

b) If the resistance values are reduced, the "under-critical coupling" case is obtained. The pass range curve becomes narrower and narrower, until suddenly the transmission loss increases sharply and the reflection factor becomes worse.



In Fig.31, we can see the simulation for the filter afterwards converted into practice, with two 50Ω Striplines added as a link to the SMA sockets at the input and output.

Another important tip concerning Puff. How do we get the individual line pairs together for a Stripline filter?

Anyone who, for example, has changed or deleted too much in the layout in window F1 would certainly prefer to re-draw the circuit.

So first we delete everything, using <Control e> as usual. Then we desperately attempt to combine the individual line pairs from list F3 together into a Stripline band pass again. The trick here is as follows:

Position the cursor as far to the left as possible in field F1, lay down the 50Ω stripline and connect the input with pin-1 of the layout by pressing "1". Then use the appropriate letter to select the first line pair, and then press the "Cursor Right" key. Now simply select the next line pair, one after the other, and keep pressing "Cursor Down". So you go all the way to the end again, and finally you can connect the output with connection "2" through a further 50Ω circuit.

Unfortunately, this procedure is not documented in the manual!

Now we just need the mechanical dimensions of the Striplines for the board design using a CAD system. Anyone who briefly deletes the call-up sign for each line and keys in the equals sign obtains the following details:

Line a:
($Z_e = 55\Omega$), length = 23.96mm.
Width = 2.984mm, interval = 1.696mm

Line b:
($Z_e = 66\Omega$), length = 24.385mm.
Width = 2.593mm, interval = 0.281mm.

To this must be added a width of 2.88mm for the 50Ω supply line.

But be careful! The lengths need to be corrected again, because at the end of all open lines the electrical field lines go on a little bit further. But this increases the electrical length of the line! Here this means that the line sections in the board layout must be mechanically shortened so that the resonance frequency is correct again.

There are two different options for doing this as well.

8.2.2. Length correction for Striplines

Case A)

The Stripline ends abruptly and is not followed by another link.

For this case, you can find a diagram in the Puff manual (p. 38) for determining the shortening, which is repeated as Fig.32. Of course there is some more work for Puff first, because we must first use samples to determine what the impedance level of each individual line section is, with its special conductor width.

This is not particularly difficult. You simply enter a "Normal Microstrip Line (tline)" in components list F3, with any length, which has an impedance level of app. 50Ω . Press the "Equals" key and you will obtain the associated conductor

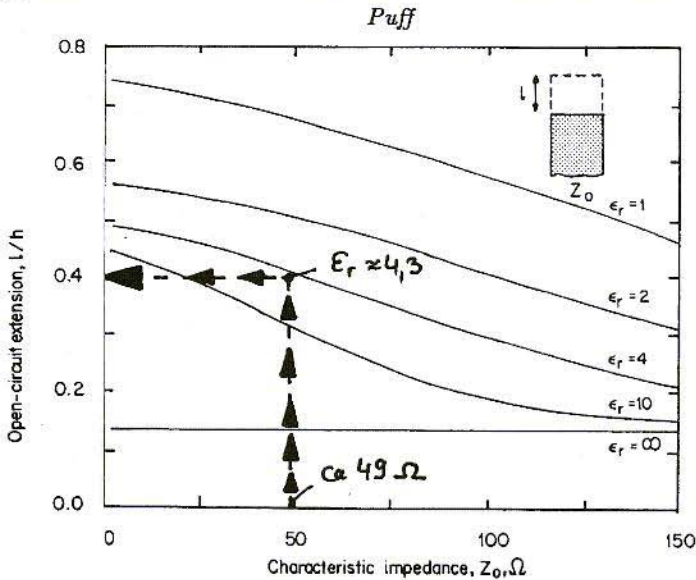

Fig.32:
Determination of
Electrical
Shortening

width. Now keep changing the impedance level until this conductor width is identical with that of the individual track of the coupled Stripline.

With the dielectric constant, 4.32, and the impedance level of the line section, you can now go into the diagram and read off the "Open End Shortening" required as a fraction of the board thickness.

You will obtain the following results for the two line pairs in question:

Line "a":

The track width is 2.984mm., which corresponds to a lossy Microstrip line (= "tline! 49.35 Ω , 90°"), but which would have an actual impedance level of 48,93 Ω . For this, in combination with the dielectric constant of 4.32, the diagram gives us an electrical extension which is equal to 0.4 x board thickness = 0.4 x 1.5mm. = 0.6mm..

Line "b":

A track width of 2.593mm. gives us a "tline! 53.68 Ω , 90°" with an actual impedance level of 53.154 Ω for the individual track.

For this, the diagram gives an electrical extension of 0.39 x board thickness = 0.39 x 1.5mm. = 0.58mm..

And now for something I came up against when measuring out the first board I set up, which really made me realise the discrepancies between the measured results and the Puff simulation (app. 2%):

The extensions obtained are valid for "simple" Striplines. Here the result agrees precisely with the theory. However, for the coupled lines we are talking about here there is always an inductive coupling between the two tracks.

Obviously, if the electrical field lines extend a little further at the ends, this

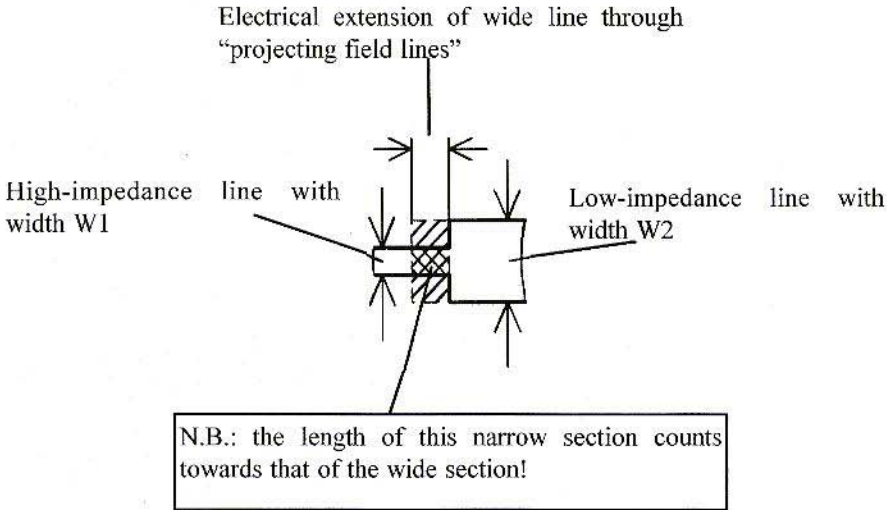

Fig.33: Representation of Electrical Extension

decreases more or less linearly down to zero, as soon as we (in imagination) leave the track, when no more copper is present and the current can no longer flow in it.

For this reason we obtain the correct resonance frequency only if, as an exception, we do not take the entire extension into account, but consider only the half of it on either side of the line section, i.e. app. 0.15mm. in each case.

Case B)

An additional, narrower line is connected to a wide Stripline.

Since the final capacity of the wide line is now reduced by the copper track on the subsequent narrow track, the electrical extension is also reduced. In addition, the cross-hatched "narrow extension section" is always added onto the wide line and omitted from the length of

the narrow line. This loss of length must then be appropriately taken into account in the layout of the narrow line and must be balanced out (see Fig.33).

The correction formula for a "discontinuity" of this kind runs as follows:

$$X_{\text{Separate}} = X_{\text{wide}} [1 - (W_1/W_2)]$$

where

X_{Separate} = Actual effective extension at discontinuity

X_{wide} = Theoretical extension of wide line alone (from top diagram in Fig.32)

W_1 = Conductor width of narrow Stripline

W_2 = Conductor width of wide Stripline

We then obtain the following correction values for the "discontinuities" for the Stripline band pass:

Conductor lengths as per Puff

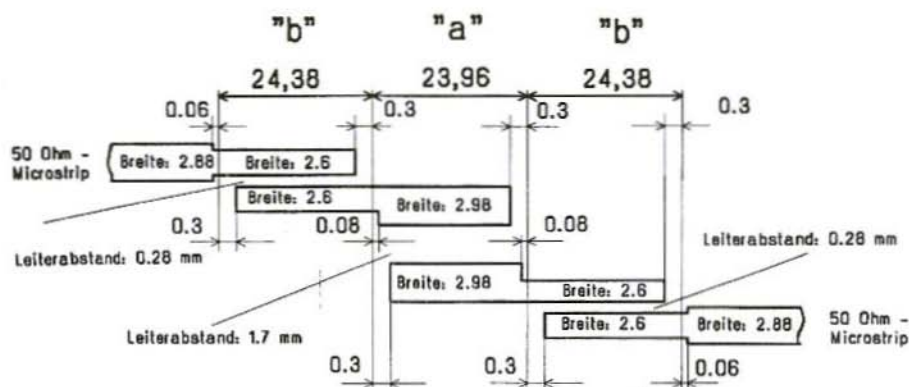

Fig.34: Difference between “mechanically” and electrically effective Conductor Lengths

Leiterabstand = Conductor interval, *Breite* = Width

1. Transition from 50Ω supply line (width 2.88mm.) to coupled line “b” (width app. 2.6mm., associated impedance level of a single line would be 53.153Ω):

Shortening = 0.6mm. x (1 - 2.6mm. / 2.88mm.) = 0.058mm., i.e. 0.06mm.

2. Transition from line “b” (width 2.6mm., the corresponding impedance level would be 53.153Ω) to line “a”

(width 2.98mm., corresponding impedance level 49.35Ω):

Shortening = 0.6mm. x (1 - 2.6mm. / 2.98mm.) = 0.0765mm., i.e. 0.08mm.

Now carefully enter all this into the board layout using CAD. Fig.34 gives a block diagram of the points to watch out for in designing the board. You can now clearly see the difference everywhere between the “mechanical” lengths to be

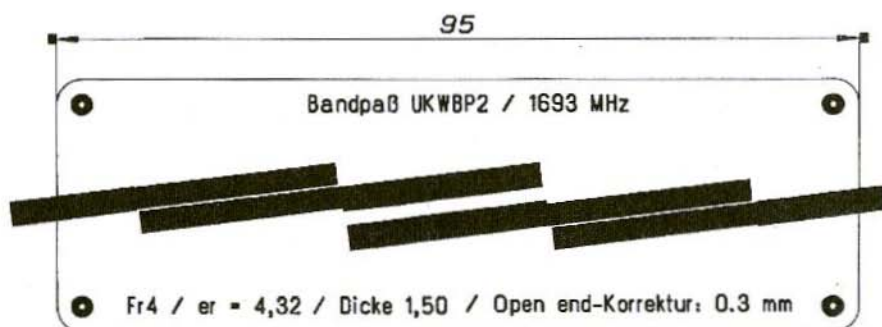

Fig.35: Completed Board Layout of Band Pass

Bandpaß = Bandpass, *Dicke* = Thickness, *Korrektur* = Correction

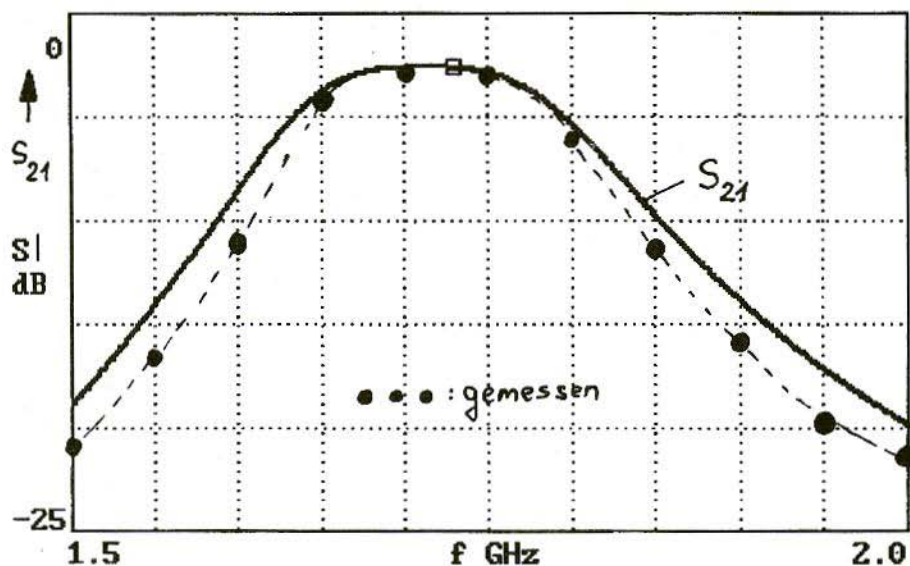

Fig.36: S_{21} of Band Pass for Range 1.5 to 2 GHz; *Gemessen* = Measured

printed and the electrically effective lengths.

Naturally this involves a lot of effort and a lot of computing time, but this is precisely where what we are doing differs from the very expensive professional programs referred to, which supply the complete layout at the same time as they do the computing.

8.2.3. Instructions for assembly

Because of the small conductor interval in the coupled line "b", the layout result absolutely must be printed out highly magnified, and then reduced again photographically when a film is made. Only in this way can "short circuits" be avoided, since photographic copying is far more precise than a printer. Naturally things are even simpler and even more precise with a photo plotter.

Fig.35 finally shows the completed board layout.

Things to look out for here: the 50 Ω connection lines at the input and output were carried on precisely along the extension of the band pass line pair, in order to avoid a bend. In this way, the computed shortening values continue to correlate, whilst in addition any reflection errors arising due to the "oblique" connection of the SMA plug can be compensated for relatively easily if necessary.

In Fig.36, the computed and measured pass range curves in the range between 1.5 and 2 GHz can be compared with one another.

As can be seen, our observations were pretty well correct. Something which seems rather puzzling at first is the fact that the flanks fall away rather more steeply on the measured board than in

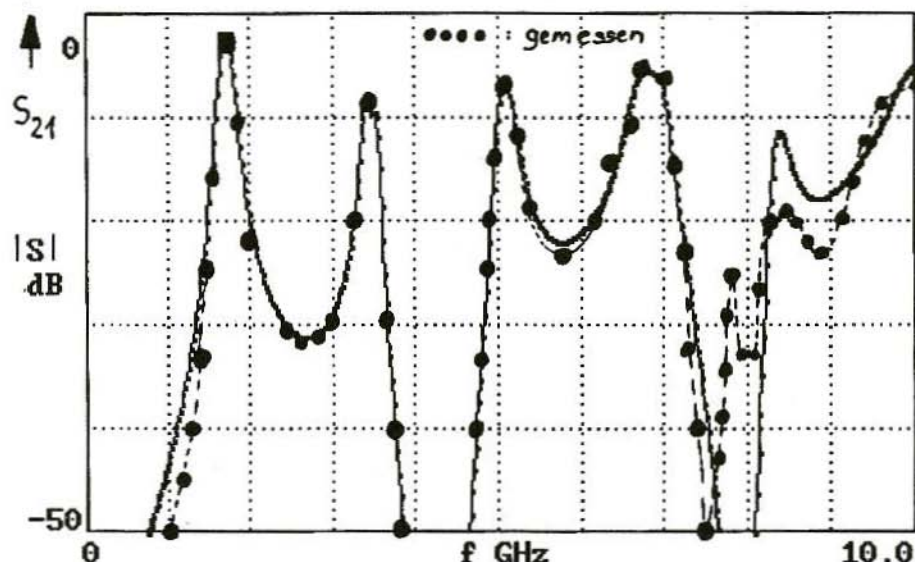

Fig.37: S_{21} of Band Pass for 0 to 10 GHz; *Gemessen* = Measured

the simulation, for clearly the “band filter coupling” is not quite as firm as it was computed to be.

As one possible explanation, when I examined the board with a magnifying glass (!) I found something which one would hardly have suspected in advance.

The resolution of the laser printer used is only 300dpi, which leads to the notorious “stair nosing” on the tracks of the Stripline running at an angle to the board axis in the board layout. Obviously, with the very narrow interval between the two “b” lines, this is already enough to make the coupling looser than was foreseen, and thus the pass range curve has steeper flanks. In addition, an investigation ought to be carried out, using professional methods, to determine the extent to which any “under-cutting of track edges” is also a contributing factor.

The housing construction also has a strong influence, in that if the screening cover is screwed off, then the band width expands markedly and the pass range curves measured match the simulation considerably better!

In Fig.37, we see again the curve from 0 to 10 GHz. Here there is now really no cause for complaint, as there is almost no difference between measurement and simulation, apart from a narrow area around 8 GHz.

Incidentally, the recurring “intrusions” of the attenuation in the filter attenuation band with this filter construction are unfortunately inherent in the principle involved, and are described as “scatter resonances”.

If they cause interference, you just combine the above filter with an additional Stripline deep pass on each side, which forms just as good a barrier there!



This two-sided "framing" of the band pass with two equal deep passes has already been shown to be correct, and has become a standard technique in industry, since it keeps the layout symmetrical.

For this application of course, Puff reaches its limits with the first calculations, and suddenly feels faint. Perhaps you remember seeing the message come up - "CIRCUIT TOO BIG FOR PUFF".

In such a case it is recommended that you transcribe the complete band pass*.puf file to a device file with the termination *, as already done for the GaAsFET CFY30, with the text processing program, and thus simply make a component out of it, which is managed in the F3 list (e.g. as "BP1700M.dev") for further calculations.

Of course, we must not forget to plot the frequency response of the band pass from 0 to 10 GHz before setting up the *.dev file, so that later we will not be surprised by the message that the permissible frequency range has been exceeded.

Moreover, when plotting, use the maximum possible 499 plot points, as otherwise the entire curve looks very stepped if additional deep passes with smaller frequency ranges are analysed later on.

8.3. General calculation of Stripline band passes

8.3.1. Preliminary comments

To work myself into this topic properly, I carried out some research into the relevant literature first.

The most important literature references are, for example, the "original article" on this topic by S.B.Cohn [1], with the corresponding calculation mechanisms, or the further development of these thoughts in the article by G.L.Matthaei [2]. And in German there is a chapter with all the calculation formulae, together with an example showing the working out, in the book by Geschwinde & Krank [3]. Finally, a modern work, which supplies answers to most questions on passive components in microwave engineering, and which no enthusiastic designer should be without. It is distinguished by the way it explains things, which is laudably educational, and at the same time mathematically correct, but very clear. It also includes examples of calculations, not only for this topic, but for nearly all the questions dealt with, plus a very comprehensive list of literature references: Peter A.Rizzi [4].

8.3.2.1. Determination of general filter coefficients for a pre-set reflection factor

The starting point for all filter calculations is the so-called "standard deep pass" for a specific degree of filtration, which simultaneously gives the number of components required.

From this deep pass circuit, by means of appropriate "transformations", all other filter formats can be created, such as high pass, band pass or band elimination, as well as any characteristic desired, such as impedance level, limiting frequency or band width.

Before starting the design work, you

should devote some thought to the following points:

a) How steep should the transition of the filter curve from the pass range into the filter attenuation band be? The degree of filtration, n , depends on this, and thus the number of components or assemblies. A higher degree of filtration gives a steeper gradient. In this context, you should also know that the degree of filtration should, as far as possible, be odd (i.e. $n = 3, 5, 7$, etc.). The reason is that, if $n = 2, 4, 6$, etc., the terminal resistance of the filter is no longer equal to the internal resistance on the input side, and also changes with the filter attenuation selected. In many cases, this is very impractical.

b) Should the attenuation and group delay time in the pass range oscillate within specific limits, or must they be constant, as far as possible? In this connection it is always true that smaller oscillations in the "pass range" unfortunately simultaneously create a "flutter rise" in the filter attenuation outside the pass range.

c) The maximum attenuation value in the pass range is always associated with a reflection factor and / or a specific maximum voltage standing wave ratio (VSWR), which can be precisely calculated. The filter calculations can not be carried out until it has been determined.

Fig.38 shows such a standard deep pass with its filter coefficients, g_1 to g_5 , the two assembly options - anti-capacitance or anti-coil - and the essential cycle of the transmission loss for the two most important types of filter, Butterworth and Tschebyscheff. "Butterworth" gives a lovely smooth curve with slight distur-

tions, but in practice the Tschebyscheff filter is often preferred, with its steeper flanks, and in return we accept the attenuation "ripple" in the pass range.

A)

Immediately below, we give the formulae for determining the coefficients for Butterworth deep passes.

The following generally applies here:

where

$$g_k = 2 \cdot \sin \left[\frac{(2k-1) \cdot \pi}{2n} \right] \quad (1)$$

$k = 1, 2, 3, \dots, n$

Example for $n = 3$:

$$g_1 = 2 \cdot \sin \left[\frac{(2 \cdot 1 - 1) \cdot \pi}{2 \cdot 3} \right] = 1,00 = g_3$$

$$g_2 = 2 \cdot \sin \left[\frac{(2 \cdot 2 - 1) \cdot \pi}{2 \cdot 3} \right] = 2,00$$

B)

Things are unfortunately rather more difficult with the Tschebyscheff type:

First step:

Determination of maximum attenuation in pass range from reflection factor and/or VSWR.

Conversion of VSWR into reflection factor

$$r = (\text{VSWR}-1) / (\text{VSWR}+1)$$

The maximum attenuation in dB in (2) pass range then amounts to

Example:

$$a_{\max} = 10 \cdot \log \frac{1}{1-|r|^2} \quad (3)$$



A reflection factor of $r = 10\%$ means that

Sec-

$$a_{\max} = 10 \cdot \log \frac{1}{1 - (0,1)^2} \text{ dB} = 0,043648 \text{ dB}$$

ond step:

We now need the variable β :

$$\beta = \ln \left(\coth \frac{a_{\max}}{17,37} \right) \quad (4)$$

For a reflection factor of 10%:

$$\beta = \ln \left(\coth \frac{0,043648}{17,37} \right) = 5,98634$$

We can thus determine the next variable, γ :

$$\gamma = \sin h \left(\frac{\beta}{2n} \right) \quad (5)$$

As an example, we shall now go through all the calculations and the assembly for a fifth-degree "specimen deep pass" ($n = 5$) with the reflection factor $r = 10\%$.

This gives us

$$\gamma = \sin h \left(\frac{5,98634}{2 \cdot 5} \right) = 0,635$$

Third step:

The individual filter coefficients are determined according to the following formula:

$$g_1 = \frac{2 \cdot a_1}{\gamma} \quad (6)$$

$$g_k = \frac{4 \cdot a_{k-1} \cdot a_k}{b_{k-1} \cdot g_{k-1}} \quad (7)$$

where

$k = 2, 3, \dots, n$

But in addition we also need a_k and b_k :

$$a_k = \sin \left[\frac{(2k-1) \cdot \pi}{2n} \right] \quad (8)$$

where $k = 1, 2, 3, \dots, n$

$$b_k = \gamma^2 + \sin^2 \left(\frac{k \cdot \pi}{n} \right) \quad (9)$$

where $k = 1, 2, 3, \dots, n$

We obtain the first coefficient for the "specimen deep pass" in the following way: If $k = 1$

$$a_1 = \sin \left[\frac{(2 \cdot 1 - 1) \cdot \pi}{2 \cdot 5} \right] = 0,309$$

This gives:

$$g_1 = \frac{2 \cdot a_1}{\gamma} = \frac{2 \cdot 0,309}{0,635} = 0,97322$$

For the next coefficient ($k = 2$), we need:

$$a_2 = \sin \left[\frac{(2 \cdot 2 - 1) \cdot \pi}{2 \cdot 5} \right] = 0,809$$

together with

$$b_1 = \gamma^2 + \sin^2 \left[\frac{1 \cdot \pi}{5} \right] = 0,748716$$

Thus as the second filter coefficient we obtain:

$$g_2 = \frac{4 \cdot a_1 \cdot a_2}{b_1 \cdot g_1} = \frac{4 \cdot 0,309 \cdot 0,809}{0,748716 \cdot 0,97322} = 1,37226$$

For the last coefficient, with

$$a_3 = \sin \left[\frac{(2 \cdot 3 - 1) \cdot \pi}{2 \cdot 5} \right] = 1,00$$

and

$$b_2 = (\gamma)^2 + \sin^2 \left(\frac{2 \cdot \pi}{5} \right) = (0,635)^2 + \sin^2 \left(\frac{2 \cdot \pi}{5} \right) = 1,3077$$



we finally obtain

$$g_3 = \frac{4 \cdot a_2 \cdot a_3}{b_2 \cdot g_2} = \frac{4 \cdot 0,809 \cdot 1,00}{1,3077 \cdot 1,37226} = 1,80324$$

8.3.2.2. Checking calculation results with Puff

The simplest method of checking the calculations would be to design a deep pass with any feasible, even limiting frequency, for example 100 MHz or 1 GHz. This is the easiest way to check the results on the screen.

But Puff also offers the option of incorporating the filter coefficients into the component table directly. Then you need only enter the desired impedance level and the limiting frequency in field F4, and the attenuation cycle for this case is plotted immediately. The components values actually required for the coils and capacitors can then be simply and rapidly determined using a pocket calculator.

As an example, let us do the calculations for an 100 MHz deep pass, with $n = 5$ and a maximum reflection factor of $r = 10\%$ in the "anti-coil format".

Spulenarm

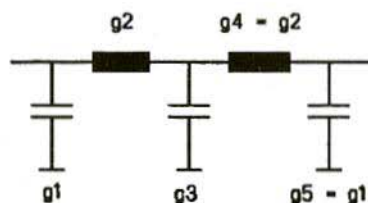

Kapazitätsarm

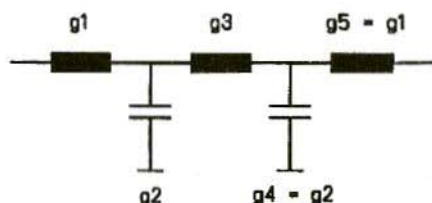

Butterworth-Typ

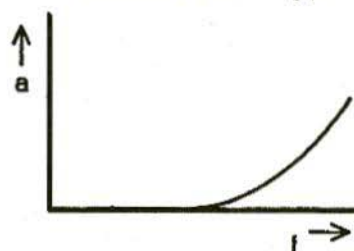

Tschebyscheff-Typ

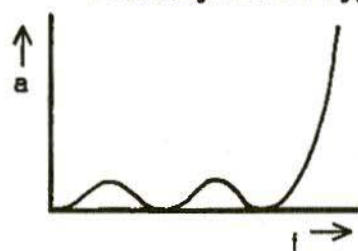

Fig.38: Standard Deep Pass in two Formats and Basic Transmission Loss Cycle
Spulenarm = Anti-coil, *Kapazitätsarm* = Anti-capacitanc", "Typ" = Type

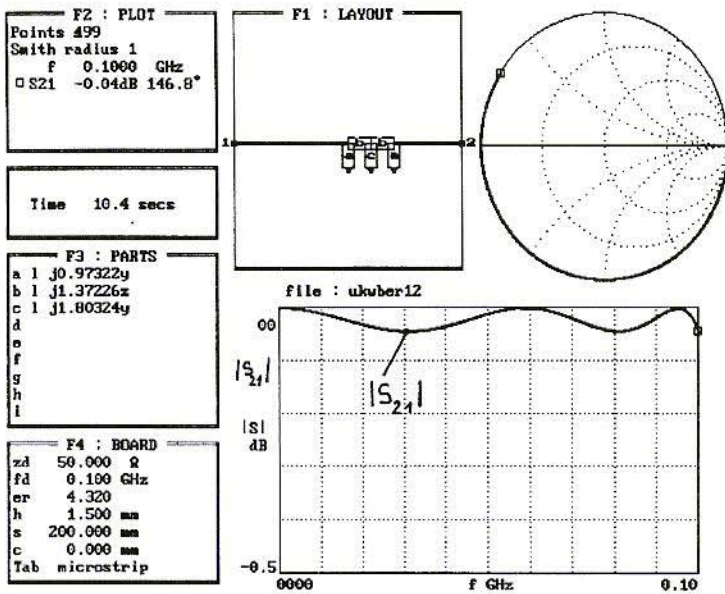

Fig.39: Simulation of a 100 MHz Deep Pass with $n = 5$ and $r = 10\%$

To this end, the capacitors and coils are simply written into field F3 in standardised form - i.e. in the form of the coefficients g_1 , g_2 , g_3 just calculated. But be careful. In this context, coils must be represented as “standardised reactive impedances”. Capacitors, on the other hand, must be shown as “standardised susceptances”. But a blind element is always accompanied by the letter “j”. Standardisation on the impedance value is shown by the addition of a “z” after the component value, whereas standardisation on the susceptance is shown by the letter “y”.

The F3 component list thus looks like this:

part a: lumped $j0.97322y$
 part b: lumped $j1.37226x$
 part c: lumped $j1.80324y$

Anyone pre-setting a limiting frequency

of 100 MHz in the frequency response diagram, with a range of 0 to -05dB in the vertical direction for S21, must obtain a print-out like the one in Fig.39.

If we now press the < p a g e

down> key and go right down to one of the attenuation maxima, we can read off a transmission loss of precisely 0.04dB in field F2, which was used in the calculations for this filter. If we now also plot the input reflection factor S11 for a value range switched from 0 to -50dB, for frequencies from 0 to 200 MHz, we will be amazed to see the pre-determined minimum reflection attenuation at 20dB, which is associated with a 10% reflection factor (Fig.40).

Determining the component value itself is relatively simple: Any nominated value from the F3 list is actually nothing more than the reactive impedance or susceptance of the component in question for the limiting frequency specified, based on the impedance value, here, of 50Ω. With this information, we can carry out the following calculations:

Anyone who wants to can now have fun

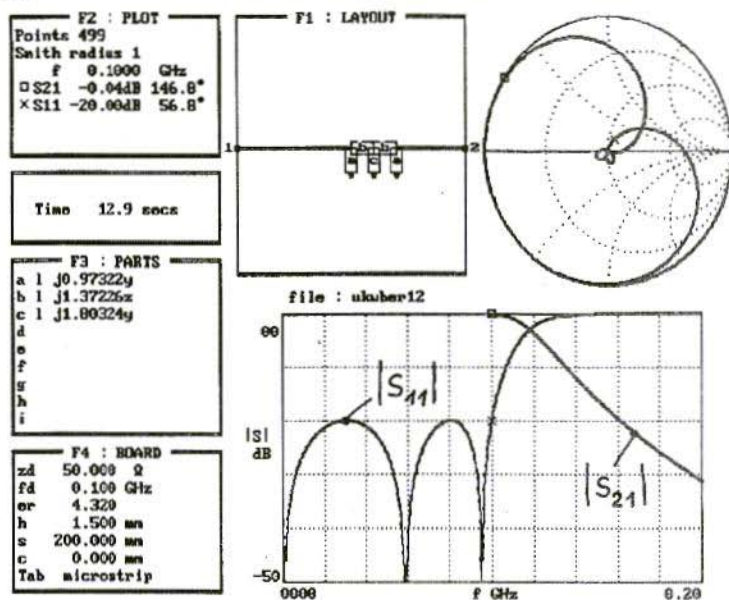

Fig.40: S11 and S22 for the 100-MHz Deep Pass, Range 0 to 200 MHz

$$\begin{aligned}
 Y_{C_1} &= \frac{0,97322}{50 \Omega} \Rightarrow \\
 &\Rightarrow 2\pi \cdot f_0 \cdot C_1 = \frac{0,97322}{50 \Omega} \Rightarrow \\
 &\Rightarrow C_1 = \frac{0,97322}{2\pi \cdot 100 \text{ MHz} \cdot 50 \Omega} \Rightarrow \\
 &\Rightarrow C_1 = 30,97 \text{ pF}
 \end{aligned}$$

$$\begin{aligned}
 X_{L_2} &= 1,377226 \cdot 50 \Omega \Rightarrow \\
 &\Rightarrow 2\pi \cdot f_0 \cdot L_2 = 1,377226 \cdot 50 \Omega \Rightarrow \\
 &\Rightarrow L_2 = \frac{1,377226 \cdot 50 \Omega}{2\pi \cdot 100 \text{ MHz}} \Rightarrow \\
 &\Rightarrow L_2 = 109,2 \text{ nH}
 \end{aligned}$$

$$\begin{aligned}
 Y_{C_3} &= \frac{1,80324}{50 \Omega} \Rightarrow \\
 &\Rightarrow 2\pi \cdot 100 \text{ MHz} \cdot C_3 = \frac{1,80324}{50 \Omega} \Rightarrow \\
 &\Rightarrow C_3 = \frac{1,80324}{2\pi \cdot 100 \text{ MHz} \cdot 50 \Omega} \Rightarrow \\
 &\Rightarrow C_3 = 57,39 \text{ pF}
 \end{aligned}$$

carrying out another Puff simulation with these components, and checking whether they really give the 100 MHz deep pass. Only SMD components may be used in the practical assembly of such a filter. Only they have such a high natural resonance (due to the tiny natural inductance of 1nH for the 0805 formats) that the resulting dips in the filter attenuation band no longer cause any interference. Of course, specific rules of play then have to be observed in designing the board, as well as in the screen housing construction, in order to obtain the attenuation losses predicted by the theory. Of course, we can now use Puff again to give a very precise prediction of the attenuation cycle going high up into the gigaHertz range, using the complete equivalent circuits of coils and capacitors, together with the stray capacitances of the solder flecks in the layout. *(To be continued)*



COMPLETE KITS & PCB's

KIT	DESCRIPTION	ISSUE	No.	PRICE
DB6NT-001	Measuring Amp up to 2.5 GHz	4/93	06382	£ 60.00
DB6NT-002	Frequency Divider to 5.5. GHz	4/93	06383	£100.00
DC8UG-007	5W PA for 13cm	3/94	06938	£286.00
DJ8ES-001	23cm FM ATV Converter	1/91	06347	£ 93.00
DJ8ES-002	Digital Frequency Indicator	1/91	06352	£ 53.00
DJ8ES-003	IF Amplifier	1/91	06355	£ 55.00
DJ8ES-004	Demodulator	1/91	06362	£ 72.00
DJ8ES-019	Transverter 144/28 MHz	4/93	06385	£143.00
DJ8ES-019mod	Transverter 50/28 MHz	2/95	06392	£143.00
DJ8ES-020	Hybrid Amplifier for 144 MHz	1/94	06387	£179.00
DJ8ES-021	13cm FM ATV Exciter	2/94	06388	£ 67.00
DJ8ES-022	28/432 MHz Transverter Oscillator	2/95	06395	£ 59.00
DJ8ES-023	28/432 MHz Transverter Converter	2/95	06396	£114.00
HF-MESS	PC Software for the DJ8ES projects	TBA	-----	£ 32.50
OE2TLZ 001	PreMixer for 23 and 13cm	1/97	-----	£115.00
YT3MV	Low Noise L-Band Aerial Amplifier	2/92	06358	£ 29.80
PCB	DESCRIPTION	ISSUE	No.	PRICE
DC8UG-PA	5W PA for 13cm	3/94	06936	£ 19.25
DC8UG-NT	Power Supply for the PA	3/94	06937	£ 7.75
DJ8ES-001	23cm FM ATV Converter	1/91	06347	£ 10.75
DJ8ES-019	Transverter 144/28 MHz	4/93	06384	£ 17.75
DJ8ES-020	Hybrid Amplifier 144 MHz	1/94	06386	£ 17.25
DJ8ES-021	13cm FM ATV Exciter	2/94	-----	£ 18.50
DJ8ES-022	28/432 MHz Transverter Oscillator	2/95	-----	£ 16.50
DJ8ES-023	28/432 MHz Transverter Converter	2/95	-----	£ 16.50
DJ8ES-027	Milliwatt Meter for the PC	4/96	-----	£ 13.50
DJ8ES-028	0.9 - 1.5 GHz Synthesiser for the PC	1/97	-----	£ 13.50
DJ8ES-029	Interface Card	3/97	-----	£ 15.00
DJ8ES-030	VCO with PLL	3/97	-----	£ 15.00
DJ8ES-031	Mixer / LO	3/97	-----	£ 15.00
DJ8ES-032	Pin Diode Controller	3/97	-----	£ 15.00
DJ8ES-033	A/D Converter with Detector	4/97	-----	£ 15.00
DJ8ES-034	Direct Mixer with Logarithmic Display	4/97	-----	£ 15.00
HF-MESS	Software for the DJ8ES PC projects	TBA	-----	£ 32.50
DF9PL-001	30 Volt PSU	1/93	06378	£ 9.80
DF9PL-002	Pre-Stabiliser	1/93	06376	£ 10.20
DF9PL-003	Precision Stabiliser	1/93	06377	£ 11.20
OE2TZL-001	PreMixer for 23 and 13cm	1/97	-----	£ 15.00

Minimum Shipping charge £6.75 * Credit Card orders +5% * Address data at bottom of Contents page

THE G80ZP RANGE OF MICROWAVE KITS FOR AMATEUR TELEVISION

ASSEMBLED GUNNMOD2 3cm ATV TRANSMITTER PCB & KIT

Gunnmod2 PCB forms the heart of a compact, fully featured FM. Gunn diode PAL, SECAM. or NTSC Amateur Television Transmitter with 5.5, 6.0 or 6.5 MHz intercarrier sound. The PCB is suitable for most types of 3cm and other frequency Gunn oscillators up to 25mW (up to 300mW Gunn oscillators may be used with the addition of one extra transistor). The single 3 by 2 inch quality PCB incorporates a stable, adjustable Gunn diode modulator with video pre-emphasis and adjustable deviation, together with a stable intercarrier sound generator with selectable pre-emphasis, audio limiting, input level control and output filtering. The PCB requires a single 10 - 15V DC unregulated supply and consumes only 20mA, excluding the Gunn diode. This makes it ideal for portable or mast head use.

PCB with full instructions - you supply components, Gunn Osc, case, connectors, etc..... £ 7.50
Kit with full instructions - you supply Gunn Osc, case, connectors, etc (Note 1)..... £ 25.00
Kit with Gunn oscillator - you supply case, connectors, etc. (Notes 1 & 2)..... £ 35.00

Note 1: Please state 5.5 MHz, 6.0 MHz or 6.5 MHz audio sub carrier frequency. (6 MHz standard) *Note 2:* At present Gunn oscillators are good tested surplus units. Gunn oscillators are WG16 square flange mounting, 8 - 12mW output and pre-tuned to 10.340 GHz, other frequencies at request. 8 - 12mW oscillators, when equipped with a suitable antenna and a low noise RX are capable of providing line-of-site transmissions well in excess of 100Km. With minor modifications this TX may be used to transmit data.

3cm LNB's

Low Noise Block receive converters have been the main contributive factor that has opened up the 3cm band to ATV and other modes. With the low receive noise figures now available, transmissions are no longer restricted to clear line-of-sight paths. Test transmissions have conclusively shown that over the horizon transmissions by various propagation modes are now possible. None line-of-sight transmission by means of scatter from rain clouds has also been achieved. Equipped with suitable antenna systems, etc., operation well in excess of 100km is readily achievable. Integral feed horn types will fit directly on to standard offset satellite dishes with a 38 - 40mm mount.

Brand new with integral feed horn 0.7dB noise figure £ 50.00
Brand new with integral feed horn 1.0 - 1.2dB noise figure..... £ 45.00
Brand new with integral 20dB antenna 0.8db noise fig. £ 60.00
Brand new 22mm circular input 0.7db noise figure £ 55.00
Brand new 22mm circular input 1.0db - 1.2db noise figure..... £ 50.00

All LNB's. are fully tested with the local oscillator at 9.0GHz $\pm 0.01\%$ (this is often better than original). Other local oscillator frequencies available by request. Horizontal or vertical polarisation is selected by applying either approximately 13 or 1BV DC.

Note: Due to the lower deviation often used by amateur transmissions, mods may be required to the



video amp and the audio subcarrier demodulator of domestic satellite RX's. when used for amateur use.

ASSEMBLED TVRO3 RECEIVER KIT

A new TVRO (television receive only) kit, designed by an amateur for amateurs with amateur requirements in mind. On the single 95 x 145mm quality glass fibre PCB are mounted all the components (less front panel controls) required for a fully featured TVRO, or tuneable IF. All RF signal amplification and demodulation is performed within a screened pre-assembled, pre-aligned signal module. All other circuitry, including power supplies, is mounted on the same board as the RF module. All connections are via connectors: RF input via an 'F type' connector, all others by 0.1inch Molex connectors which are supplied in the kit. Construction requires only basic tools, small wire cutters soldering iron etc. together with basic electronic assembly skills. One of the design philosophies was to eliminate the need for any variable components, therefore once assembled no further setting up or alignment is required (no test equipment required). The kit contains the PCB, all board mounted components and full assembly and operating instructions.

Tuneable IF/Demod for 13, 9, 6, 3cm, etc. Or with pre-amp as a 24cm ATV RX

TVRO Tuner/Demodulator for satellite use

12V DC operation, 500mA typical consumption. (depends on volume and LNB used)

Tunes 750 MHz to 1750 MHz

In-built switchable 13V or 18V LNB supply

1V PK-PK composite video output.

Sound fully tuneable from 5.5 MHz to 7.5 MHz * Audio squelch * 3 Watts audio output

In-built dish alignment aid

Video gain control * + or - modulation selection

Signal meter output

Absolutely no alignment required - just assemble and away you go!

TVR03 - ONLY AVAILABLE AS A COMPLETE KIT..... £ 65.00

24cm HEMT GaAsFET ATV PREAMP

Satellite receivers are basically tuneable IF units which require, for satisfactory operation, input signal levels of many millivolts. In a satellite installation most of the RF gain is provided by the dish mounted LNB. This means that if used on the 24cm band, unless they are used only for local working, they will require a high-gain pre-amp at the front end to compensate for the gain normally provided by the LNB. This 24cm low-noise, high-gain pre-amp is designed specifically for ATV use, but may be used on any modes if required. Micro striplines plus Helical band pass filter make alignment very simple and greatly reduces the possibility of interference from out of band signals.

1dB noise figure HEMT GaAsFET front end, 40db gain.

12 - 20V DC supply via coax. (from satellite RX etc.) or separate feed if required. Sturdy tin plate enclosure.

High quality BNC connectors. Very simple to align.

Note: This kit contains some surface mount components. TX/RX switching is not included

Complete Kit..... £ 77.50

Shipping charges at cost

Credit Card orders +5%.

KM Publications, 5 Ware Orchard, Barby, Nr.Rugby, CV23 8UF, U.K.

Tel: (0)1788 890365

Fax: (0)1788 891883

E-mail: vhfsales@vhfcomm.co.uk



VHF COMMUNICATIONS

A Publication for the Radio Amateur Worldwide

Especially Covering VHF, UHF and Microwaves

Volume No. 30 Spring Edition 1/1998

Publishers

KM PUBLICATIONS,
5 Ware Orchard, Barby, Nr.Rugby,
CV23 8UF, United Kingdom
Tel: +44 1788 890365
Fax: +44 1788 891883

Email:
michael.j@vhfcomm.co.uk

Editor

Mike Wooding G6IQM

**VHF
COMMUNICATIONS**

The international edition of the German publication UKW-Berichte is a quarterly amateur radio magazine, especially catering for the VHF/UHF/SHF technology. It is owned and published in the United Kingdom in Spring, Summer, Autumn and Winter by KM PUBLICATIONS.

The 1998 subscription price is £18.00, or national equivalent. Individual copies are available at £4.75, or national equivalent each. Subscriptions should be addressed to the national representative shown in the next column. Orders for individual copies of the magazine, back issues, kits, binders, or any other enquiries should be addressed directly to the publishers.

NOTICE: No guarantee is given that the circuits, plans and PCB designs published are free of intellectual property rights. Commercial supply of these designs without the agreement of the Author and Publisher is not allowed. Users should also take notice of all relevant laws and regulations when designing, constructing and operating radio devices.

**© KM
PUBLICATIONS**

All rights reserved. Reprints, translations, or extracts only with the written approval of the publishers

Translated by: Inter-Ling Services,
62 Caldecott Street, Rugby,
CV21 3TH, UK

Printed in the United Kingdom by:
Cramphorn Colour Printers Ltd.,
15c Paynes Lane, Rugby.

AUSTRALIA - W.I.A. South Australia Division, GPO Box 1234, Adelaide, SA 5001, Australia. Tel/Fax: 8 8522 4859

BELGIUM - UKW-BERICHTE, POB 80, D-91081 BAIERSDORF, Germany. Tel: 09133-77980. Fax: 09133-779833 Postgiro Nbg. 30445-858.

DENMARK - KM PUBLICATIONS, 5 Ware Orchard, Barby, Nr.RUGBY, CV23 8UF, UK. Tel: +44 788 890365. Fax: +44 788 891883. Email: vhfsubs@vhfcomm.co.uk

FRANCE - Christianne Michel F5SM, SM ELECTRONIC, 20bis Avenue des Clairions, F-89000 AUXERRI, France Tel: (86) 46 96 59

FINLAND - KM PUBLICATIONS, 5 Ware Orchard, Barby, Nr.RUGBY, CV23 8UF, UK. Tel: +44 788 890365 Fax: +44 788 891883. Email: vhfsubs@vhfcomm.co.uk

GERMANY - UKW-BERICHTE, POB 80, D-91081 BAIERSDORF, Germany. Tel: 09133 7798-0. Fax: 09133 779833.

GREECE - KM PUBLICATIONS, 5 Ware Orchard, Barby, Nr.RUGBY, CV23 8UF, UK. Tel: +44 788 890365. Fax: +44 788 891883. Email: vhfsubs@vhfcomm.co.uk

HOLLAND - KM PUBLICATIONS, 5 Ware Orchard, Barby, Nr.RUGBY, CV23 8UF, UK. Tel: +44 788 890365. Fax: +44 788 891883. Email: vhfsubs@vhfcomm.co.uk

ITALY - ADB ELETRONICA di Luchesi Fabrizio IW5ADB, Via Vecchia Romana 266, 55100 ANTRACCOLI, (LUCCA), Italy. Tel: 0583 952612. Fax: 0583 91109

NEW ZEALAND - Judith Holland, AUCKLAND VHF GROUP Inc., P.O. Box 10 138, AUCKLAND 1030, New Zealand. Tel: 0 9 412 7659

NORWAY - WAVELINE AB, Box 60224, S-216 09 MALMÖ, Sweden. Tel: +46 40 16 42 66. Fax: +46 40 15 05 07. GSM: 0705 16 42 66 e-mail: waveline@algonet.se <http://www.algonet.se/~waveline>

SOUTH AFRICA - KM PUBLICATIONS, 5 Ware Orchard, Barby, Nr.RUGBY, CV23 8UF, UK. Tel: +44 788 890365. Fax: +44 788 891883. Email: vhfsubs@vhfcomm.co.uk

SPAIN & PORTUGAL - JULIO A. PRIETO ALONSO EA4CJ, Donoso Cortes 58 5º -B, MADRID 15, Spain. Tel: 543 83 84

SWEDEN - WAVELINE AB, Box 60224, S-216 09 MALMÖ, Sweden. Tel: 040 16 42 66. Fax: 040 15 05 07. GSM: 0705 16 42 66 e-mail: waveline@algonet.se <http://www.algonet.se/~waveline>

SWITZERLAND - KM PUBLICATIONS, 5 Ware Orchard, Barby, Nr.RUGBY, CV23 8UF, UK. Tel: +44 788 890365. Fax: +44 788 891883. Email: vhfsubs@vhfcomm.co.uk

UNITED KINGDOM - KM PUBLICATIONS, 5 Ware Orchard, Barby, Nr.RUGBY, CV23 8UF, UK. Tel: +44 788 890365. Fax: +44 788 891883. Email: vhfsubs@vhfcomm.co.uk

U.S.A. - GENE HARLAN, ATVQ Magazine, 5931 Alma Drive, Rockford, IL 61108, USA. Tel: Toll free USA only 800 557 9469. Elsewhere: +1 815 398 2683; Fax: +1 815 398 2688 Email: atvq@aol.com

ELSEWHERE - KM PUBLICATIONS, address as for the U.K.

WWW: <http://www.vhfcomm.co.uk>

ISSN 0177-7505

AFFORDABLE SOFTWARE FOR PRO AND AMATEUR

winLINE

Transmission line impedance calculations for all sorts of lines: coaxial, stripline, microstrip, plus rectangular lines, eccentric lines, trough lines, wire-above-ground plane, and many others. Computes impedance, loss, inductance, capacitance and other parameters. Uses data from *Microwave Transmission Line Impedance Data*. For Windows.

Order NP-11 \$195.00

Microwave Transmission Line Impedance Data
by M.A.R. Gunston

Order NP-10 \$54.00

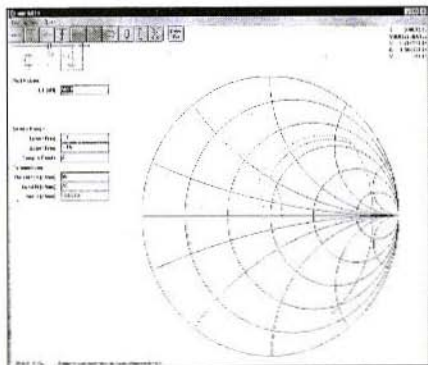
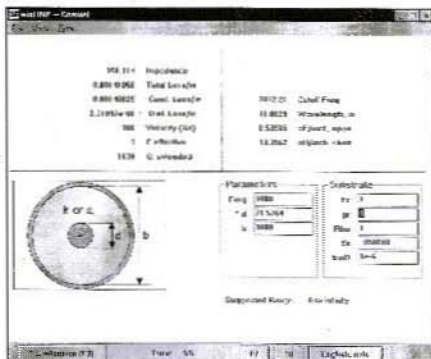

winSMITH

The best electronic Smith Chart around! "Build" a ladder network of up to nine elements (L, C, R, transmission line or transformer) and use the chart to tune values until the match is perfect. Written for stand-alone operation, but makes a perfect addition to the book *Electronic Applications of the Smith Chart*. For Windows.

Order NP-5 \$79.00

Electronic Applications of the Smith Chart
by Philip Smith

Order NP-4 \$59.00

EEpal

The "Electrical Engineer's Pal" is loaded with useful data and utilities for the active designer. Includes units and conversions, materials and component data, scientific calculator with higher math functions, pads, filters, matching, and more. Has a notepad and calendar, plus a phone list with an autodialer. All this is topped off with a list 1800 EE suppliers! Runs in DOS or a DOS window.

Order NP-20 \$195.00

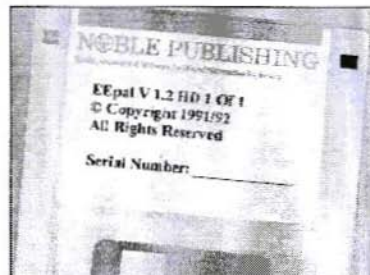

Order by telephone, fax, mail or our Web site!

We accept payment by VISA, MasterCard and American Express or check drawn on a U.S. bank. Shipping charges are - U.S.: \$5.00 for the first item, \$1.00 for each additional item; Canada: \$10.00 first item, \$2.00 each additional item; Other countries (Air express): \$32.00 first item, \$10.00 each additional item.

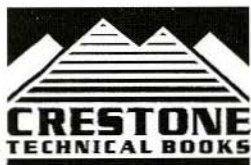

CRESTONE TECHNICAL BOOKS

Div. of Noble Publishing Corporation

2245 Dillard Street • Tucker, GA 30084 • USA

Tel: (770) 908-2320 • Fax: (770) 939-0157

www.noblepub.com

Easy-PC for Windows 95 and NT!

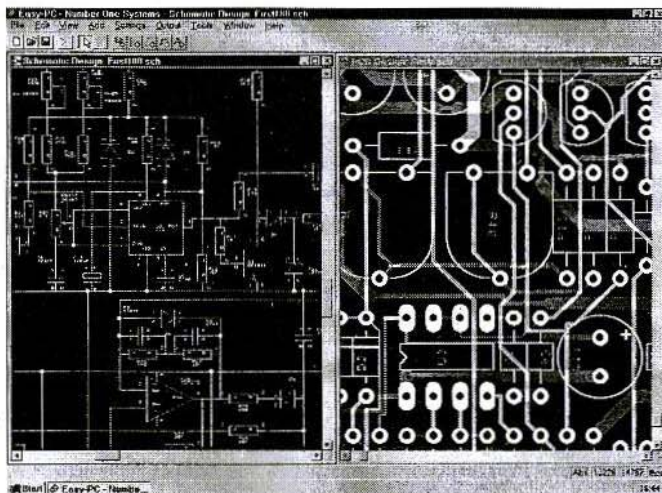

- 4th Generation Schematic Design and Printed Circuit Layout.
- By Engineers, for Engineers.
- Full links to our Analogue, Digital and Electromagnetic simulators.
- NO pin, net or layer limits!
- Fast, Intuitive Operation!
- Track and Component editing - a dream!
- Superb User Interface!
- *Competitive pricing!*

Number One Systems

Write, fax, phone or e-mail for full information.

UK/EEC: Ref: VHFCOM, Harding Way, St.Ives, Cambridgeshire, ENGLAND, PE17 4WR. e-mail: sales@numberone.com
Telephone UK: 01480 461778 (7 lines) Fax: 01480 494042
International +44 1480 461778/494042

USA: Ref: VHFCOM, 126 Smith Creek Drive, Los Gatos, CA 95030
Telephone/Fax: (408) 395-0249

<http://www.numberone.com>